

**ELECTROMAGNETIC EMISSIONS
COMPLIANCE REPORT**

Applicant: Telit Communications S.p.A.
Via Stazione di Prosecco 5/b 34010 Sgonico - Trieste

Product Name: LN920A12-WW / LN920A6-WW

Brand Name: Telit

Model No.: LN920A12-WW / LN920A6-WW

Model Difference: 1. Internal Component is different between two model.
2. Capability is different between two model.

Report Number: ER/2021/A0026

FCC ID RI7LN920

IC: 5131A-LN920

Issue Date: January 11, 2022

Date of Test: October 12, 2021~November 15, 2021

Date of EUT Received: October 6, 2021

Approved By _____

Blue Yang

We hereby certify that:

The above equipment was tested by SGS Taiwan Ltd. Central RF Lab The test data, data evaluation, test procedures, and equipment configurations shown in this report were made in accordance with the procedures given in ANSI C63.26-2015 and the energy emitted by the sample EUT comply with FCC rule part 2, 22H & 24E & 27 C and ISSED RSS-Gen, 132, 133, 139.

The results of this report relate only to the sample identified in this report.

Unless otherwise stated the results shown in this test report refer only to the sample(s) tested and such sample(s) are retained for 90 days only.

除非另有說明，此報告結果僅對測試之樣品負責，同時此樣品僅保留90天。本報告未經本公司書面許可，不可部份複製。

This document is issued by the Company subject to its General Conditions of Service printed overleaf, available on request or accessible at <http://www.sgs.com.tw/Terms-and-Conditions> and for electronic format documents, subject to Terms and Conditions for Electronic Documents at <http://www.sgs.com.tw/Terms-and-Conditions>. Attention is drawn to the limitation of liability, indemnification and jurisdiction issues defined therein. Any holder of this document is advised that information contained hereon reflects the Company's findings at the time of its intervention only and within the limits of Client's instructions, if any. The Company's sole responsibility is to its Client and this document does not exonerate parties to a transaction from exercising all their rights and obligations under the transaction documents. This document cannot be reproduced except in full, without prior written approval of the Company. Any unauthorized alteration, forgery or falsification of the content or appearance of this document is unlawful and offenders may be prosecuted to the fullest extent of the law.

Revision History					
Report Number	Revision	Description	Issue Date	Revised By	Remark
ER/2021/A0026	00	Original.	January 11, 2022	Susan Lin	

Note:

- 1、The remark "" indicates modification of the report upon requests from certification body.
- 2、Variant information of model numbers is provided by the applicant, test results of this report are applicable to the sample EUT(s) received and are assessed as identical in hardware and firmware to each other.

Unless otherwise stated the results shown in this test report refer only to the sample(s) tested and such sample(s) are retained for 90 days only.

除非另有說明，此報告結果僅對測試之樣品負責，同時此樣品僅保留90天。本報告未經本公司書面許可，不可部份複製。

This document is issued by the Company subject to its General Conditions of Service printed overleaf, available on request or accessible at <http://www.sgs.com.tw/Terms-and-Conditions> and for electronic format documents, subject to Terms and Conditions for Electronic Documents at <http://www.sgs.com.tw/Terms-and-Conditions>. Attention is drawn to the limitation of liability, indemnification and jurisdiction issues defined therein. Any holder of this document is advised that information contained hereon reflects the Company's findings at the time of its intervention only and within the limits of Client's instructions, if any. The Company's sole responsibility is to its Client and this document does not exonerate parties to a transaction from exercising all their rights and obligations under the transaction documents. This document cannot be reproduced except in full, without prior written approval of the Company. Any unauthorized alteration, forgery or falsification of the content or appearance of this document is unlawful and offenders may be prosecuted to the fullest extent of the law.

Contents

1	GENERAL PRODUCT INFORMATION	4
2	SYSTEM TEST CONFIGURATION	9
3	SUMMARY OF TEST RESULTS	11
4	DESCRIPTION OF TEST MODES	12
5	MEASUREMENT UNCERTAINTY	14
6	MAXMUM OUTPUT POWER	15
7	OCCUPIED BANDWIDTH MEASUREMENT	24
8	OUT OF BAND EMISSION AT ANTENNA TERMINALS	32
9	FIELD STRENGTH OF SPURIOUS RADIATION MEASUREMENT.....	46
10	FREQUENCY STABILITY MEASUREMENT	67
11	PEAK TO AVERAGE RATIO	72

Unless otherwise stated the results shown in this test report refer only to the sample(s) tested and such sample(s) are retained for 90 days only.

除非另有說明，此報告結果僅對測試之樣品負責，同時此樣品僅保留90天。本報告未經本公司書面許可，不可部份複製。

This document is issued by the Company subject to its General Conditions of Service printed overleaf, available on request or accessible at <http://www.sgs.com.tw/Terms-and-Conditions> and for electronic format documents, subject to Terms and Conditions for Electronic Documents at <http://www.sgs.com.tw/Terms-and-Conditions>. Attention is drawn to the limitation of liability, indemnification and jurisdiction issues defined therein. Any holder of this document is advised that information contained hereon reflects the Company's findings at the time of its intervention only and within the limits of Client's instructions, if any. The Company's sole responsibility is to its Client and this document does not exonerate parties to a transaction from exercising all their rights and obligations under the transaction documents. This document cannot be reproduced except in full, without prior written approval of the Company. Any unauthorized alteration, forgery or falsification of the content or appearance of this document is unlawful and offenders may be prosecuted to the fullest extent of the law.

1 GENERAL PRODUCT INFORMATION

1.1 Product Description

Product Name:	LN920A12-WW / LN920A6-WW
Brand Name:	Telit
Model No.:	LN920A12-WW / LN920A6-WW
Model Difference:	1. Internal Component is different between two model. 2. Capability is different between two model.
Hardware Version:	1.0
Firmware Version:	LN920A12-WW: M0L.000001 / LN920A6-WW : M0L.010001
EUT Series No.:	35417570001280
Power Supply:	3.3Vdc
Test Software (Name/Version):	N/A

1.2 Operation Frequency Range

Operating Frequency (MHz)	
WCDMA / HSPA+ Band II	1852.4 - 1907.6
WCDMA / HSPA+ Band IV	1712.4 - 1752.6
WCDMA / HSPA+ Band V	826.4 - 846.6

Unless otherwise stated the results shown in this test report refer only to the sample(s) tested and such sample(s) are retained for 90 days only.

除非另有說明，此報告結果僅對測試之樣品負責，同時此樣品僅保留90天。本報告未經本公司書面許可，不可部份複製。

This document is issued by the Company subject to its General Conditions of Service printed overleaf, available on request or accessible at <http://www.sgs.com.tw/Terms-and-Conditions> and for electronic format documents, subject to Terms and Conditions for Electronic Documents at <http://www.sgs.com.tw/Terms-and-Conditions>. Attention is drawn to the limitation of liability, indemnification and jurisdiction issues defined therein. Any holder of this document is advised that information contained hereon reflects the Company's findings at the time of its intervention only and within the limits of Client's instructions, if any. The Company's sole responsibility is to its Client and this document does not exonerate parties to a transaction from exercising all their rights and obligations under the transaction documents. This document cannot be reproduced except in full, without prior written approval of the Company. Any unauthorized alteration, forgery or falsification of the content or appearance of this document is unlawful and offenders may be prosecuted to the fullest extent of the law.

1.3 Antenna Designation

Antenna Type	Antenna Model No.
Monopole	TG.55.8113
Note: Transmission in frequencies in this test report are only available by the above antenna(s).	

Modulation	Frequency (MHz)	Peak Antenna Gain (dBi)
WCDMA / HSPA+ Band II	1852.4 - 1907.6	3.05
WCDMA / HSPA+ Band IV	1712.4 - 1752.6	3.40
WCDMA / HSPA+ Band V	826.4 - 846.6	3.20

Note: Antenna information is provided by the applicant.

Unless otherwise stated the results shown in this test report refer only to the sample(s) tested and such sample(s) are retained for 90 days only.

除非另有說明，此報告結果僅對測試之樣品負責，同時此樣品僅保留90天。本報告未經本公司書面許可，不可部份複製。

This document is issued by the Company subject to its General Conditions of Service printed overleaf, available on request or accessible at <http://www.sgs.com.tw/Terms-and-Conditions> and for electronic format documents, subject to Terms and Conditions for Electronic Documents at <http://www.sgs.com.tw/Terms-and-Conditions>. Attention is drawn to the limitation of liability, indemnification and jurisdiction issues defined therein. Any holder of this document is advised that information contained hereon reflects the Company's findings at the time of its intervention only and within the limits of Client's instructions, if any. The Company's sole responsibility is to its Client and this document does not exonerate parties to a transaction from exercising all their rights and obligations under the transaction documents. This document cannot be reproduced except in full, without prior written approval of the Company. Any unauthorized alteration, forgery or falsification of the content or appearance of this document is unlawful and offenders may be prosecuted to the fullest extent of the law.

1.4 Type of Emission & Max ERP/EIRP Power Measurement Result:

Mode	ERP / EIRP (dBm)		W	99%	Type of Emission
	ERP	EIRP			
WCDMA Band II	26.24	EIRP	0.421	4.1378	4M14F9W
HSDPA Band II	24.96	EIRP	0.313	4.1279	4M13F9W
HSUPA Band II	25.07	EIRP	0.321	4.1320	4M13F9W
WCDMA Band IV	26.69	EIRP	0.467	4.1272	4M13F9W
HSDPA Band IV	25.54	EIRP	0.358	4.1238	4M12F9W
HSUPA Band IV	25.99	EIRP	0.397	4.1259	4M13F9W
WCDMA Band V	24.21	ERP	0.264	4.1515	4M15F9W
HSDPA Band V	23.24	ERP	0.211	4.1463	4M15F9W
HSUPA Band V	23.38	ERP	0.218	4.1468	4M15F9W

Unless otherwise stated the results shown in this test report refer only to the sample(s) tested and such sample(s) are retained for 90 days only.

除非另有說明，此報告結果僅對測試之樣品負責，同時此樣品僅保留90天。本報告未經本公司書面許可，不可部份複製。

This document is issued by the Company subject to its General Conditions of Service printed overleaf, available on request or accessible at <http://www.sgs.com.tw/Terms-and-Conditions> and for electronic format documents, subject to Terms and Conditions for Electronic Documents at <http://www.sgs.com.tw/Terms-and-Conditions>. Attention is drawn to the limitation of liability, indemnification and jurisdiction issues defined therein. Any holder of this document is advised that information contained hereon reflects the Company's findings at the time of its intervention only and within the limits of Client's instructions, if any. The Company's sole responsibility is to its Client and this document does not exonerate parties to a transaction from exercising all their rights and obligations under the transaction documents. This document cannot be reproduced except in full, without prior written approval of the Company. Any unauthorized alteration, forgery or falsification of the content or appearance of this document is unlawful and offenders may be prosecuted to the fullest extent of the law.

1.5 Test Methodology of Applied Standards

FCC 47 CFR Part 2, 22H, 24E, 27C

ISED RSS-132 Issue 3 Jan. 2013

ISED RSS-133 Issue 6, Amendment 1 Jan. 18, 2018

ISED RSS-139 Issue 3 July 16, 2015

ANSI C63.26-2015

KDB971168 D01 Power Meas license Digital System v03r01

KDB941225 D01 SAR test for 3G devices v03r01 (SAR Measurement Procedures for 3G Devices, WCDMA / HSPA) was used for EUT and Base station setting.

KDB412172 D01 Determining ERP and EIRP v01r01

1.6 Test Facility

Laboratory	Test Site Address	Test Site Name	FCC Designation number	IC CAB identifier
SGS Taiwan Ltd. Central RF Lab. (TAF code 3702)	No.134, Wu Kung Road, New Taipei Industrial Park, Wuku District, New Taipei City, Taiwan.	SAC 1	TW0027	TW3702
		SAC 3		
		Conduction 1		
		Conducted 1		
		Conducted 2		
		Conducted 3		
		Conducted 4		
		Conducted 5		
		Conducted 6		
	No.2, Keji 1st Rd., Guishan District, Taoyuan City, Taiwan 333	Conduction C	TW0028	
		SAC C		
		SAC D		
		SAC G		
		Conducted A		
		Conducted B		
		Conducted C		
		Conducted D		
		Conducted E		
		Conducted F		
Conducted G				

Note: Test site name is remarked on the equipment list in each section of this report as an indication where measurements occurred in specific test site and address.

1.7 Special Accessories

No special accessories were used during testing.

1.8 Equipment Modifications

There was no modifications incorporated into the EUT.

Unless otherwise stated the results shown in this test report refer only to the sample(s) tested and such sample(s) are retained for 90 days only.

除非另有說明，此報告結果僅對測試之樣品負責，同時此樣品僅保留90天。本報告未經本公司書面許可，不可部份複製。

This document is issued by the Company subject to its General Conditions of Service printed overleaf, available on request or accessible at <http://www.sgs.com.tw/Terms-and-Conditions> and for electronic format documents, subject to Terms and Conditions for Electronic Documents at <http://www.sgs.com.tw/Terms-and-Conditions>. Attention is drawn to the limitation of liability, indemnification and jurisdiction issues defined therein. Any holder of this document is advised that information contained hereon reflects the Company's findings at the time of its intervention only and within the limits of Client's instructions, if any. The Company's sole responsibility is to its Client and this document does not exonerate parties to a transaction from exercising all their rights and obligations under the transaction documents. This document cannot be reproduced except in full, without prior written approval of the Company. Any unauthorized alteration, forgery or falsification of the content or appearance of this document is unlawful and offenders may be prosecuted to the fullest extent of the law.

1.9 Radiated Emission Test Sites For Measurements From 9 kHz To 30 MHz

Radiated emission below 30MHz is measured in a 9m*6m*6m semi-anechoic chamber, the measurements correspond to those obtained at an open-field test site.

There is a comparison data of both open-field test site and semi-Anechoic chamber, and the result came out very similar.

Unless otherwise stated the results shown in this test report refer only to the sample(s) tested and such sample(s) are retained for 90 days only.

除非另有說明，此報告結果僅對測試之樣品負責，同時此樣品僅保留90天。本報告未經本公司書面許可，不可部份複製。

This document is issued by the Company subject to its General Conditions of Service printed overleaf, available on request or accessible at <http://www.sgs.com.tw/Terms-and-Conditions> and for electronic format documents, subject to Terms and Conditions for Electronic Documents at <http://www.sgs.com.tw/Terms-and-Conditions>. Attention is drawn to the limitation of liability, indemnification and jurisdiction issues defined therein. Any holder of this document is advised that information contained hereon reflects the Company's findings at the time of its intervention only and within the limits of Client's instructions, if any. The Company's sole responsibility is to its Client and this document does not exonerate parties to a transaction from exercising all their rights and obligations under the transaction documents. This document cannot be reproduced except in full, without prior written approval of the Company. Any unauthorized alteration, forgery or falsification of the content or appearance of this document is unlawful and offenders may be prosecuted to the fullest extent of the law.

2 SYSTEM TEST CONFIGURATION

2.1 EUT Configuration

The EUT configuration for testing is installed on RF field strength measurement to meet the Commissions requirement and operating in a manner which intends to maximize its emission characteristics in a continuous normal application.

2.2 EUT Exercise

The EUT (Transmitter) was operated in the continuous transmission mode employed with the simulator of the Base Station that fixates at test default channels to fix the Tx frequency which was for the purpose of the measurements.

2.3 Test Procedure

2.3.1 Conducted Measurement at Antenna Port

The EUT is placed on a table which is 0.8 m above ground plane. A low loss of RF cable was used to connect the antenna port of EUT to measurement equipment.

2.3.2 Radiated Emissions (ERP/EIRP)

The EUT is placed on a turn table, for emission measurements below 1 GHz is 0.8 m above ground plane, for emission measurements above 1 GHz, the table height shall be 1.5 m. The turn table shall rotate 360 degrees to determine the position of maximum emission level. EUT is set 3m away from the receiving antenna which varied from 1m to 4m to find out the highest emission. And also, each emission was to be maximized by changing the polarization of receiving antenna both Horizontal and Vertical. In order to find out the max. emission, the relative positions of this hand-held transmitter (EUT) was rotated through three orthogonal axes and measurement procedures for electric field radiated emissions above 1 GHz the EUT measurement is to be made “while keeping the antenna in the ‘cone of radiation’ from that area and pointed at the area both in azimuth and elevation, with polarization oriented for maximum response.” is still within the 3dB illumination BW of the measurement antenna.

2.4 Measurement Results Explanation Example

For all conducted test items:

The offset level is set in the spectrum analyzer to compensate the RF cable loss and attenuation factor between EUT conducted port and spectrum analyzer. With the offset compensation, the spectrum analyzer reading level is exactly EUT RF output level.

Note:

The spectrum analyzer offset is derived from RF cable loss and attenuator factor. Following shows an offset computation in physical test.

Frequency	RF Cable loss (dB)	Attenuation (dB)	Offset (dB)
LB (1GHz below)	4.22	10	14.22
MB (1GHz - 2GHz)	4.52	10	14.52

Unless otherwise stated the results shown in this test report refer only to the sample(s) tested and such sample(s) are retained for 90 days only.

除非另有說明，此報告結果僅對測試之樣品負責，同時此樣品僅保留90天。本報告未經本公司書面許可，不可部份複製。

This document is issued by the Company subject to its General Conditions of Service printed overleaf, available on request or accessible at <http://www.sgs.com.tw/Terms-and-Conditions> and for electronic format documents, subject to Terms and Conditions for Electronic Documents at <http://www.sgs.com.tw/Terms-and-Conditions>. Attention is drawn to the limitation of liability, indemnification and jurisdiction issues defined therein. Any holder of this document is advised that information contained hereon reflects the Company's findings at the time of its intervention only and within the limits of Client's instructions, if any. The Company's sole responsibility is to its Client and this document does not exonerate parties to a transaction from exercising all their rights and obligations under the transaction documents. This document cannot be reproduced except in full, without prior written approval of the Company. Any unauthorized alteration, forgery or falsification of the content or appearance of this document is unlawful and offenders may be prosecuted to the fullest extent of the law.

2.5 Final Amplifier Voltage and Current Information:

Test mode	DC voltage (V)	DC current (mA)
WCDMA B2	3.3	582
HSUPA B2	3.3	543
HSDPA B2	3.3	591
WCDMA B4	3.3	603
HSUPA B4	3.3	572
HSDPA B4	3.3	587
WCDMA B5	3.3	563
HSUPA B5	3.3	572
HSDPA B5	3.3	527

2.6 Test Configuration

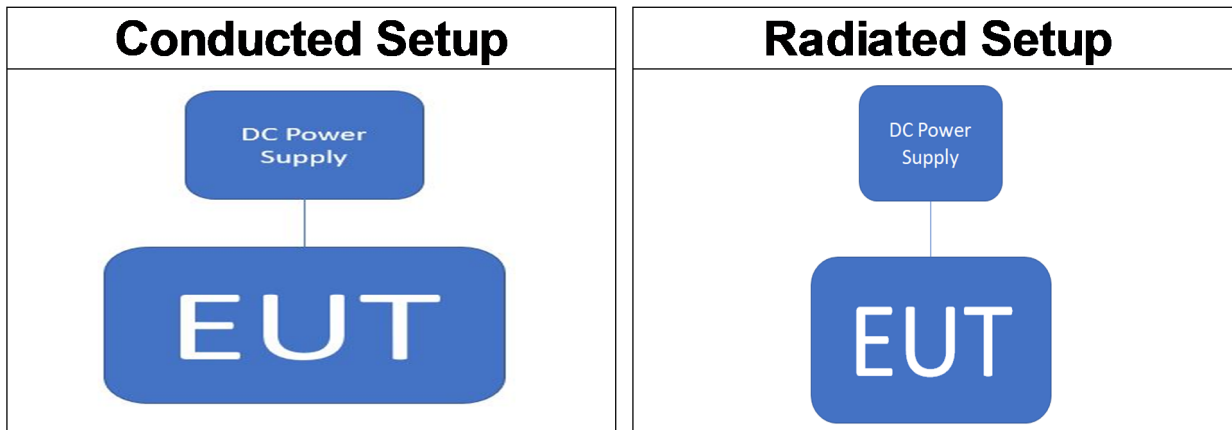

Note: Radio Communication Analyzer is placed in remote side for radiated test.

Unless otherwise stated the results shown in this test report refer only to the sample(s) tested and such sample(s) are retained for 90 days only.

除非另有說明，此報告結果僅對測試之樣品負責，同時此樣品僅保留90天。本報告未經本公司書面許可，不可部份複製。

This document is issued by the Company subject to its General Conditions of Service printed overleaf, available on request or accessible at <http://www.sgs.com.tw/Terms-and-Conditions> and for electronic format documents, subject to Terms and Conditions for Electronic Documents at <http://www.sgs.com.tw/Terms-and-Conditions>. Attention is drawn to the limitation of liability, indemnification and jurisdiction issues defined therein. Any holder of this document is advised that information contained hereon reflects the Company's findings at the time of its intervention only and within the limits of Client's instructions, if any. The Company's sole responsibility is to its Client and this document does not exonerate parties to a transaction from exercising all their rights and obligations under the transaction documents. This document cannot be reproduced except in full, without prior written approval of the Company. Any unauthorized alteration, forgery or falsification of the content or appearance of this document is unlawful and offenders may be prosecuted to the fullest extent of the law.

3 SUMMARY OF TEST RESULTS

FCC Rules	IC Rules	Description Of Test	Result
§2.1046(a)	RSS-GEN §6.12	RF Power Output	Compliant
§22.913(a)(5) §24.232(c) §27.50(d)(4)	RSS-132 §5.4 RSS-133 §6.4 RSS-139 §6.5	ERP/ EIRP measurement	Compliant
§2.1049(h)	RSS-GEN §6.7	99% & 26dB Occupied Bandwidth	Compliant
§2.1051 §22.917(a) §24.238(a) §27.53(h)	RSS-GEN §6.13 RSS-132 §5.5 RSS-133 §6.5 RSS-139 §6.6	Out of Band Emissions at Antenna Terminals and Band Edge / Emission mask requirements	Compliant
§2.1053 §22.917(a) §24.238(a) §27.53(h)	RSS-GEN §6.13 RSS-132 §5.5 RSS-133 §6.5 RSS-139 §6.6	Field Strength of Spurious Radiation	Compliant
§24.232(d) §27.50(a)(1)(B)	RSS-132 §5.4 RSS-133 §6.4 RSS-139 §6.4	Peak to Average Ratio	Compliant
§2.1055(a)(1) §22.355 §24.235 §27.54	RSS-132 §5.3 RSS-133 §6.3 RSS-139 §6.5	Frequency Stability	Compliant

Unless otherwise stated the results shown in this test report refer only to the sample(s) tested and such sample(s) are retained for 90 days only.

除非另有說明，此報告結果僅對測試之樣品負責，同時此樣品僅保留90天。本報告未經本公司書面許可，不可部份複製。

This document is issued by the Company subject to its General Conditions of Service printed overleaf, available on request or accessible at <http://www.sgs.com.tw/Terms-and-Conditions> and for electronic format documents, subject to Terms and Conditions for Electronic Documents at <http://www.sgs.com.tw/Terms-and-Conditions>. Attention is drawn to the limitation of liability, indemnification and jurisdiction issues defined therein. Any holder of this document is advised that information contained hereon reflects the Company's findings at the time of its intervention only and within the limits of Client's instructions, if any. The Company's sole responsibility is to its Client and this document does not exonerate parties to a transaction from exercising all their rights and obligations under the transaction documents. This document cannot be reproduced except in full, without prior written approval of the Company. Any unauthorized alteration, forgery or falsification of the content or appearance of this document is unlawful and offenders may be prosecuted to the fullest extent of the law.

4 DESCRIPTION OF TEST MODES

4.1 The Worst Test Modes and Channel Details

1. The EUT has been tested under operating condition.
2. Pre-Scan has been conducted to determine the worst-case mode from all possible combinations between available modulations, data rates, X(E1)Y(E2)Z(H) axis and antenna ports. The worst case was found as listed below. Following channel(s) was (were) selected for the final test as listed below:

BAND	H Plane	E1 Plane	E2 Plane
WCDMA/HSPA Band II	V		
WCDMA/HSPA Band IV	V		
WCDMA/HSPA Band V	V		

Unless otherwise stated the results shown in this test report refer only to the sample(s) tested and such sample(s) are retained for 90 days only.

除非另有說明，此報告結果僅對測試之樣品負責，同時此樣品僅保留90天。本報告未經本公司書面許可，不可部份複製。

This document is issued by the Company subject to its General Conditions of Service printed overleaf, available on request or accessible at <http://www.sgs.com.tw/Terms-and-Conditions> and for electronic format documents, subject to Terms and Conditions for Electronic Documents at <http://www.sgs.com.tw/Terms-and-Conditions>. Attention is drawn to the limitation of liability, indemnification and jurisdiction issues defined therein. Any holder of this document is advised that information contained hereon reflects the Company's findings at the time of its intervention only and within the limits of Client's instructions, if any. The Company's sole responsibility is to its Client and this document does not exonerate parties to a transaction from exercising all their rights and obligations under the transaction documents. This document cannot be reproduced except in full, without prior written approval of the Company. Any unauthorized alteration, forgery or falsification of the content or appearance of this document is unlawful and offenders may be prosecuted to the fullest extent of the law.

4.2 Measurement Configuration

Test Items	WCDMA / HSPA Bands	Test Channel		
		L	M	H
ERP	Band V	v	v	v
EIRP	Bnad II	v	v	v
	Band IV	v	v	v
FREQUENCY STABILITY	Bnad II	-	v	-
	Band IV	-	v	-
	Band V	-	v	-
OCCUPIED BANDWIDTH	Bnad II	v	v	v
	Band IV	v	v	v
	Band V	v	v	v
PEAK TO AVERAGE RATIO	Bnad II	v	v	v
	Band IV	v	v	v
	Band V	v	v	v
BAND EDGE	Bnad II	v	-	v
	Band IV	v	-	v
	Band V	v	-	v
CONDCUETED EMISSION	Bnad II	v	v	v
	Band IV	v	v	v
	Band V	v	v	v
RADIATED EMISSION	Bnad II	v	v	v
	Band IV	v	v	v
	Band V	v	v	v

Unless otherwise stated the results shown in this test report refer only to the sample(s) tested and such sample(s) are retained for 90 days only.

除非另有說明，此報告結果僅對測試之樣品負責，同時此樣品僅保留90天。本報告未經本公司書面許可，不可部份複製。

This document is issued by the Company subject to its General Conditions of Service printed overleaf, available on request or accessible at <http://www.sgs.com.tw/Terms-and-Conditions> and for electronic format documents, subject to Terms and Conditions for Electronic Documents at <http://www.sgs.com.tw/Terms-and-Conditions>. Attention is drawn to the limitation of liability, indemnification and jurisdiction issues defined therein. Any holder of this document is advised that information contained hereon reflects the Company's findings at the time of its intervention only and within the limits of Client's instructions, if any. The Company's sole responsibility is to its Client and this document does not exonerate parties to a transaction from exercising all their rights and obligations under the transaction documents. This document cannot be reproduced except in full, without prior written approval of the Company. Any unauthorized alteration, forgery or falsification of the content or appearance of this document is unlawful and offenders may be prosecuted to the fullest extent of the law.

5 MEASUREMENT UNCERTAINTY

Test Items	Uncertainty
RF Power Output	+/- 1 dB
ERP/ EIRP measurement	+/- 3 dB
	+/- 3 dB
Emission Bandwidth	+/- 1.53 Hz
Out of Band Emissions at Antenna Terminals and Band Edge	+/- 1.69 dB
Peak to Average Ratio	+/- 1 dB
Frequency Stability vs. Temperature	+/- 1.53 Hz
Frequency Stability vs. Voltage	+/- 1.53 Hz
Temperature	+/- 0.4 °C
Humidity	+/- 3.5 %
DC / AC Power Source	+/- 1 %

Radiated Spurious Emission Measurement Uncertainty		
Polarization: Vertical	+/- 2.64 dB	9kHz~30MHz
	+/- 4.93 dB	30MHz - 1000MHz
	+/- 4.81 dB	1GHz - 18GHz
	+/- 4.52 dB	18GHz - 40GHz
Polarization: Horizontal	+/- 2.64 dB	9kHz~30MHz
	+/- 4.45 dB	30MHz - 1000MHz
	+/- 4.81 dB	1GHz - 18GHz
	+/- 4.52 dB	18GHz - 40GHz

This uncertainty represents an expanded uncertainty expressed at approximately the 95% confidence level using a coverage factor of k=2.

Unless otherwise stated the results shown in this test report refer only to the sample(s) tested and such sample(s) are retained for 90 days only.

除非另有說明，此報告結果僅對測試之樣品負責，同時此樣品僅保留90天。本報告未經本公司書面許可，不可部份複製。

This document is issued by the Company subject to its General Conditions of Service printed overleaf, available on request or accessible at <http://www.sgs.com.tw/Terms-and-Conditions> and for electronic format documents, subject to Terms and Conditions for Electronic Documents at <http://www.sgs.com.tw/Terms-and-Conditions>. Attention is drawn to the limitation of liability, indemnification and jurisdiction issues defined therein. Any holder of this document is advised that information contained hereon reflects the Company's findings at the time of its intervention only and within the limits of Client's instructions, if any. The Company's sole responsibility is to its Client and this document does not exonerate parties to a transaction from exercising all their rights and obligations under the transaction documents. This document cannot be reproduced except in full, without prior written approval of the Company. Any unauthorized alteration, forgery or falsification of the content or appearance of this document is unlawful and offenders may be prosecuted to the fullest extent of the law.

6 MAXMUM OUTPUT POWER

6.1 Standard Applicable

A base station simulator was used to establish communication with the EUT. Its parameters were set to transmit the maximum power on the EUT. The measured power in the radio frequency on the transmitter output terminals.

According to FCC §2.1046

FCC 22.913(a)

(5) mobile transmitters and auxiliary test transmitters must not exceed 7 watts.

FCC 24.232(c)

Mobile and portable stations are limited to 2 W EIRP.

FCC 27.50(d)

(4) Mobile, and portable (hand-held) stations operating in the 1710-1755 MHz, 1695-1710 MHz and 1755-1780 MHz bands are limited to 1W EIRP.

RSS-132 §5.4

The equivalent isotropically radiated power (e.i.r.p.) for mobile equipment in operating in the Bands 824-849 and 869-894MHz shall not exceed 11.5 watts.

RSS-133 §6.4

The equivalent isotropically radiated power (e.i.r.p.) for transmitters shall not exceed the limits given in SRSP-510.

According to section 5.1.2 of SRSP-510, Mobile stations and hand-held portables are limited to 2 watts maximum e.i.r.p. The equipment shall employ means to limit the power to the minimum necessary for successful communication.

RSS-139 §6.5

The equivalent isotropically radiated power (e.i.r.p.) for mobile and portable transmitters in the Bands 1710-1780MHz shall not exceed one watt.

Unless otherwise stated the results shown in this test report refer only to the sample(s) tested and such sample(s) are retained for 90 days only.

除非另有說明，此報告結果僅對測試之樣品負責，同時此樣品僅保留90天。本報告未經本公司書面許可，不可部份複製。

This document is issued by the Company subject to its General Conditions of Service printed overleaf, available on request or accessible at <http://www.sgs.com.tw/Terms-and-Conditions> and for electronic format documents, subject to Terms and Conditions for Electronic Documents at <http://www.sgs.com.tw/Terms-and-Conditions>. Attention is drawn to the limitation of liability, indemnification and jurisdiction issues defined therein. Any holder of this document is advised that information contained hereon reflects the Company's findings at the time of its intervention only and within the limits of Client's instructions, if any. The Company's sole responsibility is to its Client and this document does not exonerate parties to a transaction from exercising all their rights and obligations under the transaction documents. This document cannot be reproduced except in full, without prior written approval of the Company. Any unauthorized alteration, forgery or falsification of the content or appearance of this document is unlawful and offenders may be prosecuted to the fullest extent of the law.

6.2 Test Set-up

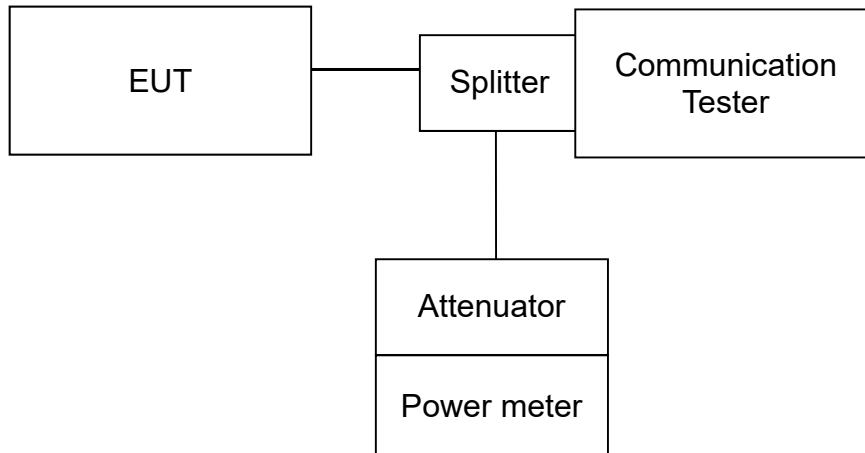

Note: Measurement setup for testing on Antenna connector

6.3 Output Power Measurement Applicable Guidance

The transmitter output was connected to a calibrated attenuator, the other end of which was connected to a power meter.

Transmitter output was read off the power meter in dBm.

The power output at the transmitter antenna port was determined by adding the value of the attenuator to the power meter reading.

The Procedure of KDB941225 (SAR Measurement Procedures for 3G devices, (WCDMA/HSPA) was used for EUT and RMC 12.2kps is used for Base station setting.

KDB 971168 D01 Power Meas License Digital System as the supplemental test methodology to adjust the proper setting obtaining the measurement results.

Conducted average power is obtained from the simulator telecommunication test set.

Unless otherwise stated the results shown in this test report refer only to the sample(s) tested and such sample(s) are retained for 90 days only.

除非另有說明，此報告結果僅對測試之樣品負責，同時此樣品僅保留90天。本報告未經本公司書面許可，不可部份複製。

This document is issued by the Company subject to its General Conditions of Service printed overleaf, available on request or accessible at <http://www.sgs.com.tw/Terms-and-Conditions> and for electronic format documents, subject to Terms and Conditions for Electronic Documents at <http://www.sgs.com.tw/Terms-and-Conditions>. Attention is drawn to the limitation of liability, indemnification and jurisdiction issues defined therein. Any holder of this document is advised that information contained hereon reflects the Company's findings at the time of its intervention only and within the limits of Client's instructions, if any. The Company's sole responsibility is to its Client and this document does not exonerate parties to a transaction from exercising all their rights and obligations under the transaction documents. This document cannot be reproduced except in full, without prior written approval of the Company. Any unauthorized alteration, forgery or falsification of the content or appearance of this document is unlawful and offenders may be prosecuted to the fullest extent of the law.

6.4 Determining ERP and/or EIRP from conducted RF output power measurements

According to KDB 412172 D01 Power Approach,

$$EIRP = P_T + G_T - L_C,$$

$$ERP = EIRP - 2.15,$$

Where:

- ERP or EIRP = effective radiated power or equivalent isotropically radiated power (expressed in the same units as P_T , typically dBW, dBm, or power spectral density (PSD)²), relative to either a dipole antenna (ERP) or an isotropic antenna (EIRP);
- P_T = transmitter output power, expressed in dBW, dBm, or PSD;
- G_T = gain of the transmitting antenna, in dBd (ERP) or dBi (EIRP);
- L_C = signal attenuation in the connecting cable between the transmitter and antenna, in dB.

6.5 Measurement Equipment Used

Conducted Emission Test Site: Conducted 4					
EQUIPMENT TYPE	MFR	MODEL NUMBER	SERIAL NUMBER	LAST CAL.	CAL DUE.
EXA Spectrum Analyzer	Agilent	N9010A	MY54200716	10/13/2021	10/12/2022
Radio Communication Analyzer	Anritsu	MT8815B	6200711454	04/07/2021	04/06/2022
Test Software	WORLD-PAL-LAS TECH. CO., LTD	Dr.E	Ver. 3.0	N.C.R	N.C.R
Temperature Chamber	Giant Force	GTH-150-40-CP-AR	MAA0512-018	05/19/2021	05/18/2022
DC Power Supply	Gwinstek	SPS-3610	GEV856761	09/18/2021	09/17/2022
Attenuator	Mini-Circuit	BW-S10W2+	4	12/16/2020	12/15/2021
DC Block	Mini-Circuits	BLK-18-S+	1	12/16/2020	12/15/2021
Power Divider	RF-LAMBAD	RFLT2W1G18G	11-JSPF412-017	12/16/2020	12/15/2021
Coaxial Cable	Woken	00100A1F1A196S	N/A	N/A	N/A

Unless otherwise stated the results shown in this test report refer only to the sample(s) tested and such sample(s) are retained for 90 days only.

除非另有說明，此報告結果僅對測試之樣品負責，同時此樣品僅保留90天。本報告未經本公司書面許可，不可部份複製。

This document is issued by the Company subject to its General Conditions of Service printed overleaf, available on request or accessible at <http://www.sgs.com.tw/Terms-and-Conditions> and for electronic format documents, subject to Terms and Conditions for Electronic Documents at <http://www.sgs.com.tw/Terms-and-Conditions>. Attention is drawn to the limitation of liability, indemnification and jurisdiction issues defined therein. Any holder of this document is advised that information contained hereon reflects the Company's findings at the time of its intervention only and within the limits of Client's instructions, if any. The Company's sole responsibility is to its Client and this document does not exonerate parties to a transaction from exercising all their rights and obligations under the transaction documents. This document cannot be reproduced except in full, without prior written approval of the Company. Any unauthorized alteration, forgery or falsification of the content or appearance of this document is unlawful and offenders may be prosecuted to the fullest extent of the law.

6.6 Measurement Results

6.6.1 WCDMA & HSPA Measurement Results:

The following tests were completed according to the test requirements outlined in section 5.2 of the 3GPP TS34.121-1 specification. The EUT supports power Class 3, which has a nominal maximum output power of 24 dBm. RMC 12.2kps is used for this testing.

WCDMA/HSUPA/HSDPA Band II Result:

EUT Mode	Freq. (MHz)	CH	Conducted Avg. Power (dBm)	Antenna Gain (dBi)	ERP (dBm)	EIRP (dBm)	Limit (dBm)	Margin (dB)
WCDMA	1852.4	9262	23.04	3.05	23.94	26.09	33.00	-6.91
	1880.0	9400	23.19	3.05	24.09	26.24	33.00	-6.76
	1907.6	9538	23.13	3.05	24.03	26.18	33.00	-6.82
HSDPA	1852.4	9262	21.91	3.05	22.81	24.96	33.00	-8.04
	1880.0	9400	21.83	3.05	22.73	24.88	33.00	-8.12
	1907.6	9538	21.78	3.05	22.68	24.83	33.00	-8.17
HSUPA	1852.4	9262	22.02	3.05	22.92	25.07	33.00	-7.93
	1880.0	9400	21.66	3.05	22.56	24.71	33.00	-8.29
	1907.6	9538	20.62	3.05	21.52	23.67	33.00	-9.33

WCDMA/HSUPA/HSDPA Band IV Result:

EUT Mode	Freq. (MHz)	CH	Conducted Avg. Power (dBm)	Antenna Gain (dBi)	ERP (dBm)	EIRP (dBm)	Limit (dBm)	Margin (dB)
WCDMA	1712.4	1312	23.29	3.40	24.54	26.69	30.00	-3.31
	1732.6	1413	23.10	3.40	24.35	26.50	30.00	-3.50
	1752.6	1513	23.11	3.40	24.36	26.51	30.00	-3.49
HSDPA	1712.4	1312	22.14	3.40	23.39	25.54	30.00	-4.46
	1732.6	1413	21.79	3.40	23.04	25.19	30.00	-4.81
	1752.6	1513	21.99	3.40	23.24	25.39	30.00	-4.61
HSUPA	1712.4	1312	22.59	3.40	23.84	25.99	30.00	-4.01
	1732.6	1413	21.54	3.40	22.79	24.94	30.00	-5.06
	1752.6	1513	20.90	3.40	22.15	24.30	30.00	-5.70

Unless otherwise stated the results shown in this test report refer only to the sample(s) tested and such sample(s) are retained for 90 days only.

除非另有說明，此報告結果僅對測試之樣品負責，同時此樣品僅保留90天。本報告未經本公司書面許可，不可部份複製。

This document is issued by the Company subject to its General Conditions of Service printed overleaf, available on request or accessible at <http://www.sgs.com.tw/Terms-and-Conditions> and for electronic format documents, subject to Terms and Conditions for Electronic Documents at <http://www.sgs.com.tw/Terms-and-Conditions>. Attention is drawn to the limitation of liability, indemnification and jurisdiction issues defined therein. Any holder of this document is advised that information contained hereon reflects the Company's findings at the time of its intervention only and within the limits of Client's instructions, if any. The Company's sole responsibility is to its Client and this document does not exonerate parties to a transaction from exercising all their rights and obligations under the transaction documents. This document cannot be reproduced except in full, without prior written approval of the Company. Any unauthorized alteration, forgery or falsification of the content or appearance of this document is unlawful and offenders may be prosecuted to the fullest extent of the law.

WCDMA/HSUPA/HSDPA Band V Result:

EUT Mode	Freq. (MHz)	CH	Conducted Avg. Power (dBm)	Antenna Gain (dBi)	ERP (dBm)	EIRP (dBm)	Limit (dBm)	Margin (dB)
WCDMA	826.4	4132	23.16	3.20	24.21	26.36	38.50	-12.14
	836.6	4183	23.06	3.20	24.11	26.26	38.50	-12.24
	846.6	4233	23.03	3.20	24.08	26.23	38.50	-12.27
HSDPA	826.4	4132	22.19	3.20	23.24	25.39	38.50	-13.11
	836.6	4183	21.77	3.20	22.82	24.97	38.50	-13.53
	846.6	4233	22.18	3.20	23.23	25.38	38.50	-13.12
HSUPA	826.4	4132	22.33	3.20	23.38	25.53	38.50	-12.97
	836.6	4183	22.09	3.20	23.14	25.29	38.50	-13.21
	846.6	4233	22.06	3.20	23.11	25.26	38.50	-13.24

Unless otherwise stated the results shown in this test report refer only to the sample(s) tested and such sample(s) are retained for 90 days only.

除非另有說明，此報告結果僅對測試之樣品負責，同時此樣品僅保留90天。本報告未經本公司書面許可，不可部份複製。

This document is issued by the Company subject to its General Conditions of Service printed overleaf, available on request or accessible at <http://www.sgs.com.tw/Terms-and-Conditions> and for electronic format documents, subject to Terms and Conditions for Electronic Documents at <http://www.sgs.com.tw/Terms-and-Conditions>. Attention is drawn to the limitation of liability, indemnification and jurisdiction issues defined therein. Any holder of this document is advised that information contained hereon reflects the Company's findings at the time of its intervention only and within the limits of Client's instructions, if any. The Company's sole responsibility is to its Client and this document does not exonerate parties to a transaction from exercising all their rights and obligations under the transaction documents. This document cannot be reproduced except in full, without prior written approval of the Company. Any unauthorized alteration, forgery or falsification of the content or appearance of this document is unlawful and offenders may be prosecuted to the fullest extent of the law.

6.6.2 HSPA (HSDPA & HSUPA) Release 6:

The following 4 Sub-Tests were completed according to the test requirements outlined in section 5.2A of the 3GPP TS34.121-1 specification. All TX RMS power requirements for Power Class 3 were met according to table 5.2AA.5 and 5.2B.5 All UE channels and power ratio's are set according to table C10.1.4 & C11.1.3 in the 3GPP TS34.121-1. RMC 12.2kps is used for this testing.

6.6.3 HSDPA SUB-TEST Setting

Table C.10.1.4: β values for transmitter characteristics tests with HS-DPCCH(FOR HSDPA)

Sub-test	β_c	β_d	β_d (SF)	β_c/β_d	β_{HS} (Note 1, Note 2)	CM (dB) (Note 3)	MPR (dB) (Note 3)	RMC (Kbps)
1	2/15	15/15	64	2/15	4/15	0.0	0.0	12.2
2	12/15 (Note 4)	15/15 (Note 4)	64	12/15 (Note 4)	24/15	1.0	0.0	12.2
3	15/15	8/15	64	15/8	30/15	1.5	0.5	12.2
4	15/15	4/15	64	15/4	30/15	1.5	0.5	12.2

Note: The recommended HSDPA MPRs are implemented as per following sub-tests.

Mode	Sub test	Avg. Power (dBm) Channel		
		9262.00	9400.00	9538.00
HSDPA II	1	21.91	21.83	21.78
	2	21.99	21.91	21.81
	3	21.50	21.42	21.33
	4	21.49	21.43	21.34

Mode	Sub test	Avg. Power (dBm) Channel		
		1312.00	1413.00	1513.00
HSDPA IV	1	22.14	21.79	21.99
	2	22.16	21.92	22.01
	3	21.77	21.42	21.56
	4	21.72	21.41	21.57

Unless otherwise stated the results shown in this test report refer only to the sample(s) tested and such sample(s) are retained for 90 days only.

除非另有說明，此報告結果僅對測試之樣品負責，同時此樣品僅保留90天。本報告未經本公司書面許可，不可部份複製。

This document is issued by the Company subject to its General Conditions of Service printed overleaf, available on request or accessible at <http://www.sgs.com.tw/Terms-and-Conditions> and for electronic format documents, subject to Terms and Conditions for Electronic Documents at <http://www.sgs.com.tw/Terms-and-Conditions>. Attention is drawn to the limitation of liability, indemnification and jurisdiction issues defined therein. Any holder of this document is advised that information contained hereon reflects the Company's findings at the time of its intervention only and within the limits of Client's instructions, if any. The Company's sole responsibility is to its Client and this document does not exonerate parties to a transaction from exercising all their rights and obligations under the transaction documents. This document cannot be reproduced except in full, without prior written approval of the Company. Any unauthorized alteration, forgery or falsification of the content or appearance of this document is unlawful and offenders may be prosecuted to the fullest extent of the law.

Mode	Sub test	Avg. Power (dBm)		
		Channel		
		4132.00	4183.00	4233.00
HSDPA V	1	22.19	21.77	22.18
	2	21.97	21.88	22.21
	3	21.46	21.23	21.72
	4	21.44	21.28	21.74

Unless otherwise stated the results shown in this test report refer only to the sample(s) tested and such sample(s) are retained for 90 days only.

除非另有說明，此報告結果僅對測試之樣品負責，同時此樣品僅保留90天。本報告未經本公司書面許可，不可部份複製。

This document is issued by the Company subject to its General Conditions of Service printed overleaf, available on request or accessible at <http://www.sgs.com.tw/Terms-and-Conditions> and for electronic format documents, subject to Terms and Conditions for Electronic Documents at <http://www.sgs.com.tw/Terms-and-Conditions>. Attention is drawn to the limitation of liability, indemnification and jurisdiction issues defined therein. Any holder of this document is advised that information contained hereon reflects the Company's findings at the time of its intervention only and within the limits of Client's instructions, if any. The Company's sole responsibility is to its Client and this document does not exonerate parties to a transaction from exercising all their rights and obligations under the transaction documents. This document cannot be reproduced except in full, without prior written approval of the Company. Any unauthorized alteration, forgery or falsification of the content or appearance of this document is unlawful and offenders may be prosecuted to the fullest extent of the law.

6.6.4 HSPA SUB-TEST Setting

Table C.11.1.3: β values for transmitter characteristics tests with HS-DPCCH and E-DCH(FOR HSUPA)

Sub-test	β_c	β_d	β_d (SF)	β_c/β_d	β_{HS}	β_{ec}	β_{ed}	β_{ed} (SF)	β_{ed} (Code s)	CM (dB)	MPR (dB)	AG Index	E-TFCI	RMC (Kbps)
1	11/15 (Note 3)	15/15 (Note 3)	64	11/15 (Note 3)	22/15	209/225	1309/225	4	1	1.0	0.0	20	75	12.2
2	6/15	15/15	64	6/15	12/15	12/15	94/75	4	1	3.0	2.0	12	67	12.2
3	15/15	9/15	64	15/9	30/15	30/15	β_{ed1} : 47/15 β_{ed2} : 47/15	4 4	2	2.0	1.0	15	92	12.2
4	2/15	15/15	64	2/15	4/15	2/15	56/75	4	1	3.0	2.0	17	71	12.2
5	15/15 (Note 4)	15/15 (Note 4)	64	15/15 (Note 4)	30/15	24/15	134/15	4	1	1.0	0.0	21	81	12.2

Note: The recommended HSUPA MPRs are implemented as per following sub-tests.

Mode	Sub test	Avg. Power (dBm)		
		Channel		
		9262.00	9400.00	9538.00
HSUPA II	1	22.02	21.66	20.62
	2	21.45	21.12	20.09
	3	21.99	21.68	20.65
	4	21.88	21.63	20.56
	5	21.92	21.70	20.62

Mode	Sub test	Avg. Power (dBm)		
		Channel		
		1312.00	1413.00	1513.00
HSUPA IV	1	22.59	21.54	20.90
	2	22.08	20.97	20.38
	3	22.59	21.57	20.94
	4	22.58	21.45	20.89
	5	22.59	21.56	20.93

Unless otherwise stated the results shown in this test report refer only to the sample(s) tested and such sample(s) are retained for 90 days only.

除非另有說明，此報告結果僅對測試之樣品負責，同時此樣品僅保留90天。本報告未經本公司書面許可，不可部份複製。

This document is issued by the Company subject to its General Conditions of Service printed overleaf, available on request or accessible at <http://www.sgs.com.tw/Terms-and-Conditions> and for electronic format documents, subject to Terms and Conditions for Electronic Documents at <http://www.sgs.com.tw/Terms-and-Conditions>. Attention is drawn to the limitation of liability, indemnification and jurisdiction issues defined therein. Any holder of this document is advised that information contained hereon reflects the Company's findings at the time of its intervention only and within the limits of Client's instructions, if any. The Company's sole responsibility is to its Client and this document does not exonerate parties to a transaction from exercising all their rights and obligations under the transaction documents. This document cannot be reproduced except in full, without prior written approval of the Company. Any unauthorized alteration, forgery or falsification of the content or appearance of this document is unlawful and offenders may be prosecuted to the fullest extent of the law.

Mode	Sub test	Avg. Power (dBm)		
		Channel		
		4132.00	4183.00	4233.00
HSUPA V	1	22.33	22.09	22.06
	2	21.88	21.53	21.52
	3	22.32	22.13	22.08
	4	22.38	22.06	22.02
	5	22.33	22.16	22.05

6.6.5 WCDMA/HSDPA/HSUPA band II, IV, V

The EUT output power was controlled by simulator and enter max rated power 24dBm. The EUT is going to be set to max output power to 24dBm then record the read. The min. power was measures by a function key “minimum power” then record the read. It is -52.3dBm. The power variation can be 0.1dB step by setting.

Unless otherwise stated the results shown in this test report refer only to the sample(s) tested and such sample(s) are retained for 90 days only.

除非另有說明，此報告結果僅對測試之樣品負責，同時此樣品僅保留90天。本報告未經本公司書面許可，不可部份複製。

This document is issued by the Company subject to its General Conditions of Service printed overleaf, available on request or accessible at <http://www.sgs.com.tw/Terms-and-Conditions> and for electronic format documents, subject to Terms and Conditions for Electronic Documents at <http://www.sgs.com.tw/Terms-and-Conditions>. Attention is drawn to the limitation of liability, indemnification and jurisdiction issues defined therein. Any holder of this document is advised that information contained hereon reflects the Company's findings at the time of its intervention only and within the limits of Client's instructions, if any. The Company's sole responsibility is to its Client and this document does not exonerate parties to a transaction from exercising all their rights and obligations under the transaction documents. This document cannot be reproduced except in full, without prior written approval of the Company. Any unauthorized alteration, forgery or falsification of the content or appearance of this document is unlawful and offenders may be prosecuted to the fullest extent of the law.

7 OCCUPIED BANDWIDTH MEASUREMENT

7.1 Standard Applicable

The occupied bandwidth is the frequency bandwidth such that, below its lower and above its upper frequency limits, the mean powers radiated are each equal to 0.5 percent of the total mean power.

7.2 Test Set-up

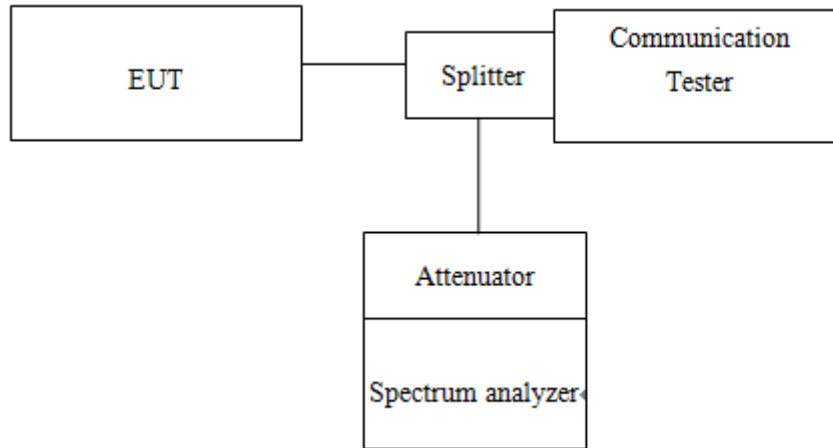

7.3 Measurement Procedure

99% & 26dB Bandwidth with detector peak

The EUT's output RF connector was connected with a short cable to the spectrum analyzer, RBW was set to about 1% of emission BW, VBW= 3 times RBW, -26dBc display line was placed on the screen (or 26dB bandwidth), the occupied bandwidth is the delta frequency between the two points where the display line intersects the signal trace. Then set RBW to 99% bandwidth, RBW= 1%, VBW= 3 * RBW, with span > 2 * Signal BW, set % Power = 99%.

99% Bandwidth with detector sample

The EUT's output RF connector was connected with a short cable to the spectrum analyzer, RBW was set to about 1% ~ 5% of emission BW, VBW= 3 times RBW. Set RBW= 1% ~ 5%, VBW= 3 * RBW, with span > 2 * Signal BW, set % Power = 99%.

Unless otherwise stated the results shown in this test report refer only to the sample(s) tested and such sample(s) are retained for 90 days only.

除非另有說明，此報告結果僅對測試之樣品負責，同時此樣品僅保留90天。本報告未經本公司書面許可，不可部份複製。

This document is issued by the Company subject to its General Conditions of Service printed overleaf, available on request or accessible at <http://www.sgs.com.tw/Terms-and-Conditions> and for electronic format documents, subject to Terms and Conditions for Electronic Documents at <http://www.sgs.com.tw/Terms-and-Conditions>. Attention is drawn to the limitation of liability, indemnification and jurisdiction issues defined therein. Any holder of this document is advised that information contained hereon reflects the Company's findings at the time of its intervention only and within the limits of Client's instructions, if any. The Company's sole responsibility is to its Client and this document does not exonerate parties to a transaction from exercising all their rights and obligations under the transaction documents. This document cannot be reproduced except in full, without prior written approval of the Company. Any unauthorized alteration, forgery or falsification of the content or appearance of this document is unlawful and offenders may be prosecuted to the fullest extent of the law.

7.4 Measurement Equipment Used

Conducted Emission Test Site: Conducted 4					
EQUIPMENT TYPE	MFR	MODEL NUMBER	SERIAL NUMBER	LAST CAL.	CAL DUE.
EXA Spectrum Analyzer	Agilent	N9010A	MY54200716	10/13/2021	10/12/2022
Radio Communication Analyer	Anritsu	MT8815B	6200711454	04/07/2021	04/06/2022
Test Software	WORLD-PAL-LAS TECH. CO., LTD	Dr.E	Ver. 3.0	N.C.R	N.C.R
Temperature Chamber	Giant Force	GTH-150-40-CP-AR	MAA0512-018	05/19/2021	05/18/2022
DC Power Supply	Gwinstek	SPS-3610	GEV856761	09/18/2021	09/17/2022
Attenuator	Mini-Circuit	BW-S10W2+	4	12/16/2020	12/15/2021
DC Block	Mini-Circuits	BLK-18-S+	1	12/16/2020	12/15/2021
Power Divider	RF-LAMBAD	RFLT2W1G18G	11-JSPF412-017	12/16/2020	12/15/2021
Coaxial Cable	Woken	00100A1F1A196S	N/A	N/A	N/A

7.5 Measurement Result

Freq. (MHz)	CH	99% BW (MHz)			26 dB BW (MHz)		
		WCDMA II	HSDPA II	HSUPA II	WCDMA II	HSDPA II	HSUPA II
1852.40	9262	4.12390	4.12240	4.12550	4.667	4.668	4.672
1880.00	9400	4.13780	4.12790	4.13200	4.682	4.669	4.671
1907.60	9538	4.13200	4.12270	4.12960	4.658	4.666	4.669

Freq. (MHz)	CH	99% BW (MHz)			26 dB BW (MHz)		
		WCDMA IV	HSDPA IV	HSUPA IV	WCDMA IV	HSDPA IV	HSUPA IV
1712.40	1312	4.12640	4.12380	4.12590	4.671	4.666	4.663
1732.60	1413	4.12720	4.12370	4.12100	4.659	4.661	4.667
1752.60	1513	4.12690	4.12310	4.12000	4.670	4.663	4.675

Unless otherwise stated the results shown in this test report refer only to the sample(s) tested and such sample(s) are retained for 90 days only.

除非另有說明，此報告結果僅對測試之樣品負責，同時此樣品僅保留90天。本報告未經本公司書面許可，不可部份複製。

This document is issued by the Company subject to its General Conditions of Service printed overleaf, available on request or accessible at <http://www.sgs.com.tw/Terms-and-Conditions> and for electronic format documents, subject to Terms and Conditions for Electronic Documents at <http://www.sgs.com.tw/Terms-and-Conditions>. Attention is drawn to the limitation of liability, indemnification and jurisdiction issues defined therein. Any holder of this document is advised that information contained hereon reflects the Company's findings at the time of its intervention only and within the limits of Client's instructions, if any. The Company's sole responsibility is to its Client and this document does not exonerate parties to a transaction from exercising all their rights and obligations under the transaction documents. This document cannot be reproduced except in full, without prior written approval of the Company. Any unauthorized alteration, forgery or falsification of the content or appearance of this document is unlawful and offenders may be prosecuted to the fullest extent of the law.

Freq. (MHz)	CH	99% BW (MHz)			26 dB BW (MHz)		
		WCDMA V	HSDPA V	HSUPA V	WCDMA V	HSDPA V	HSUPA V
826.40	4132	4.15150	4.14630	4.14680	4.694	4.685	4.685
836.60	4183	4.12580	4.11640	4.12170	4.669	4.664	4.666
846.60	4233	4.14810	4.14050	4.14060	4.689	4.667	4.686

Unless otherwise stated the results shown in this test report refer only to the sample(s) tested and such sample(s) are retained for 90 days only.

除非另有說明，此報告結果僅對測試之樣品負責，同時此樣品僅保留90天。本報告未經本公司書面許可，不可部份複製。

This document is issued by the Company subject to its General Conditions of Service printed overleaf, available on request or accessible at <http://www.sgs.com.tw/Terms-and-Conditions> and for electronic format documents, subject to Terms and Conditions for Electronic Documents at <http://www.sgs.com.tw/Terms-and-Conditions>. Attention is drawn to the limitation of liability, indemnification and jurisdiction issues defined therein. Any holder of this document is advised that information contained hereon reflects the Company's findings at the time of its intervention only and within the limits of Client's instructions, if any. The Company's sole responsibility is to its Client and this document does not exonerate parties to a transaction from exercising all their rights and obligations under the transaction documents. This document cannot be reproduced except in full, without prior written approval of the Company. Any unauthorized alteration, forgery or falsification of the content or appearance of this document is unlawful and offenders may be prosecuted to the fullest extent of the law.

WCDMA_B2_LowCH9262-1852.4

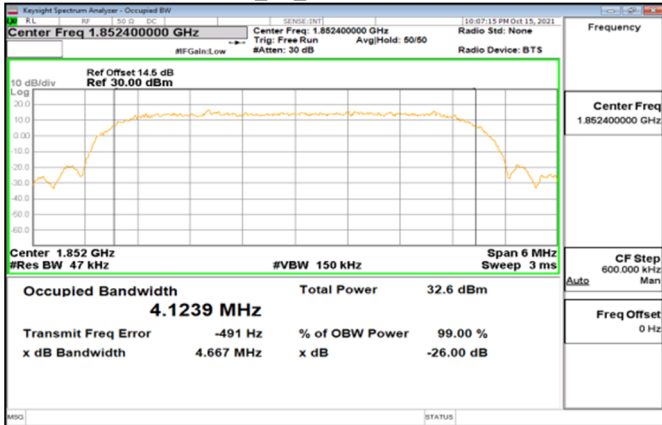

HSDPA_B2_LowCH9262-1852.4

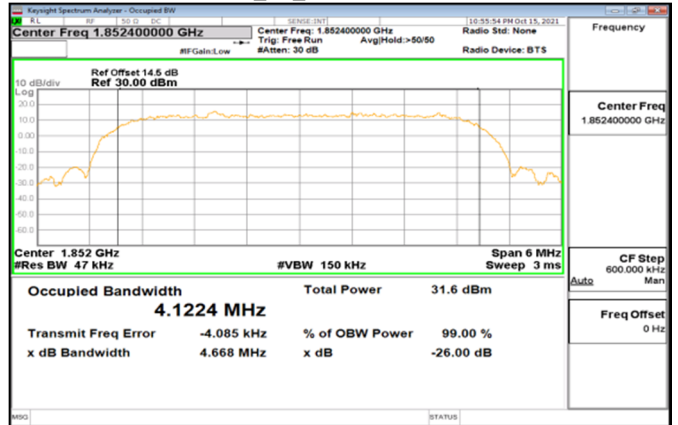

WCDMA_B2_MidCH9400-1880

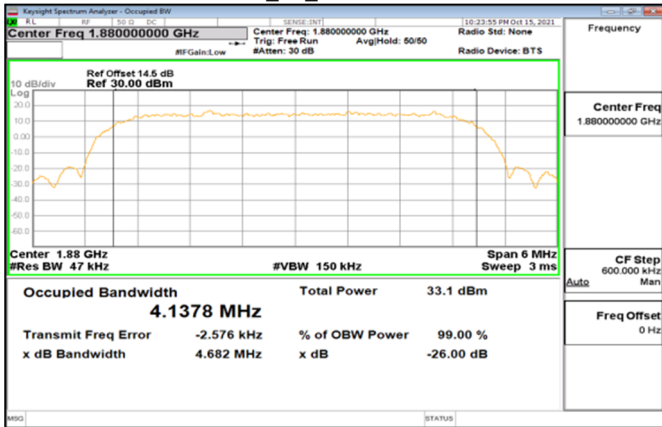

HSDPA_B2_MidCH9400-1880

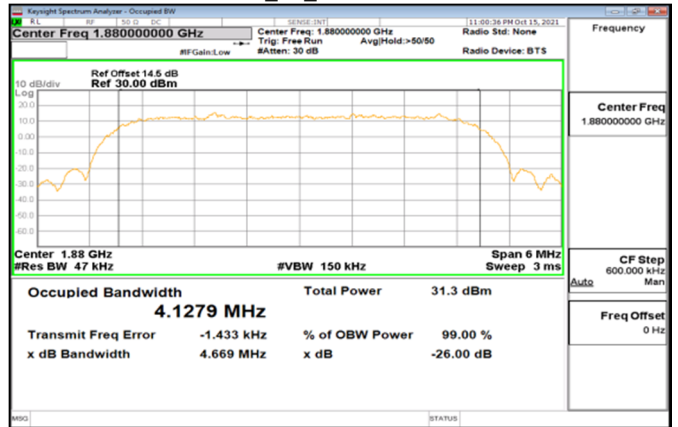

WCDMA_B2_HighCH9538-1907.6

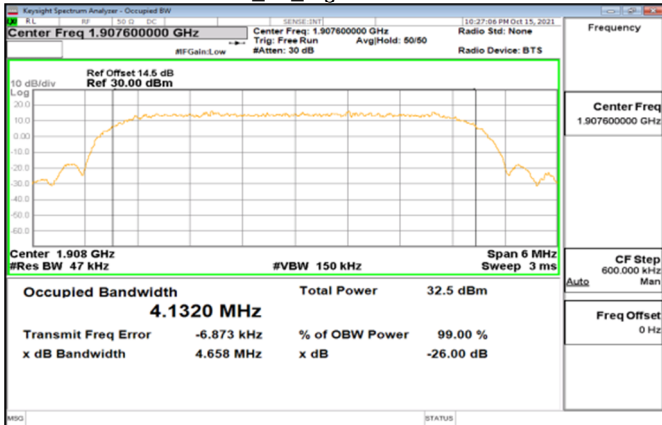

HSDPA_B2_HighCH9538-1907.6

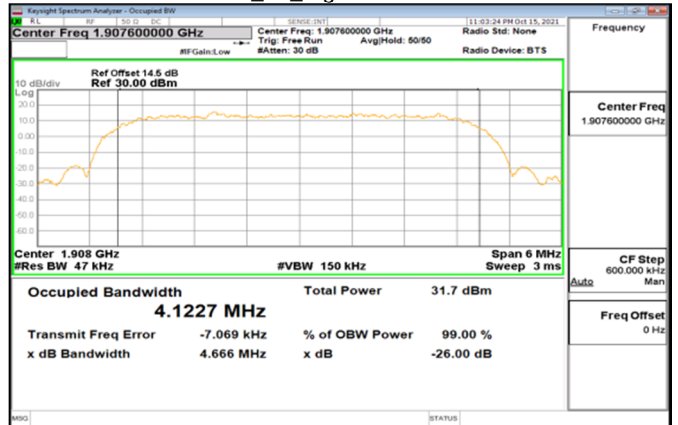

Unless otherwise stated the results shown in this test report refer only to the sample(s) tested and such sample(s) are retained for 90 days only.

除非另有說明，此報告結果僅對測試之樣品負責，同時此樣品僅保留90天。本報告未經本公司書面許可，不可部份複製。

This document is issued by the Company subject to its General Conditions of Service printed overleaf, available on request or accessible at <http://www.sgs.com.tw/Terms-and-Conditions> and for electronic format documents, subject to Terms and Conditions for Electronic Documents at <http://www.sgs.com.tw/Terms-and-Conditions>. Attention is drawn to the limitation of liability, indemnification and jurisdiction issues defined therein. Any holder of this document is advised that information contained herein reflects the Company's findings at the time of its intervention only and within the limits of Client's instructions, if any. The Company's sole responsibility is to its Client and this document does not exonerate parties to a transaction from exercising all their rights and obligations under the transaction documents. This document cannot be reproduced except in full, without prior written approval of the Company. Any unauthorized alteration, forgery or falsification of the content or appearance of this document is unlawful and offenders may be prosecuted to the fullest extent of the law.

HSUPA_B2_LowCH9262-1852.4

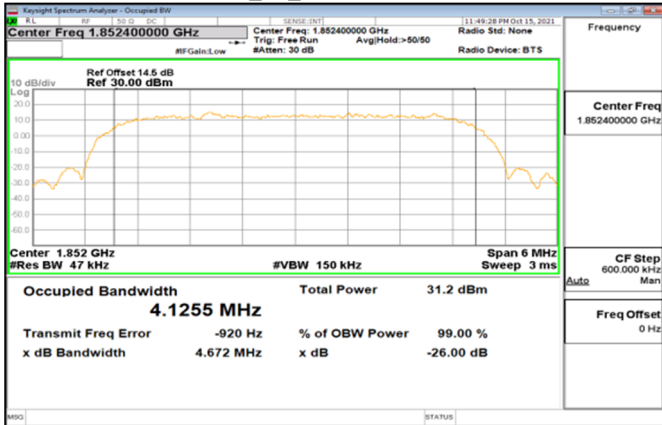

WCDMA_B4_LowCH1312-1712.4

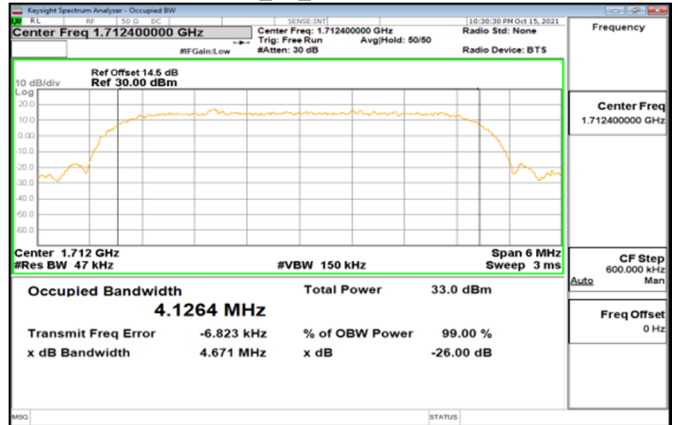

HSUPA_B2_MidCH9400-1880

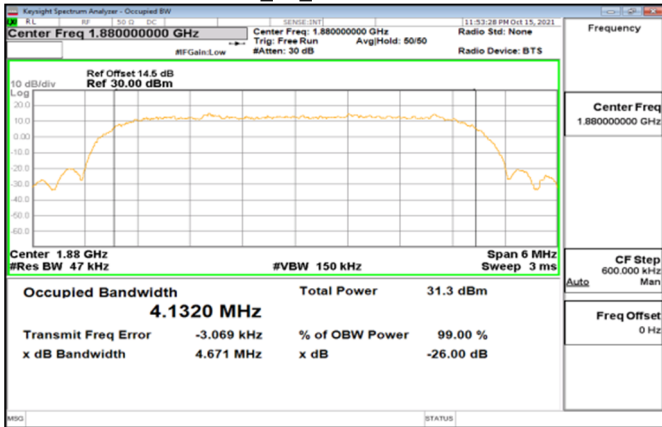

WCDMA_B4_MidCH1413-1732.6

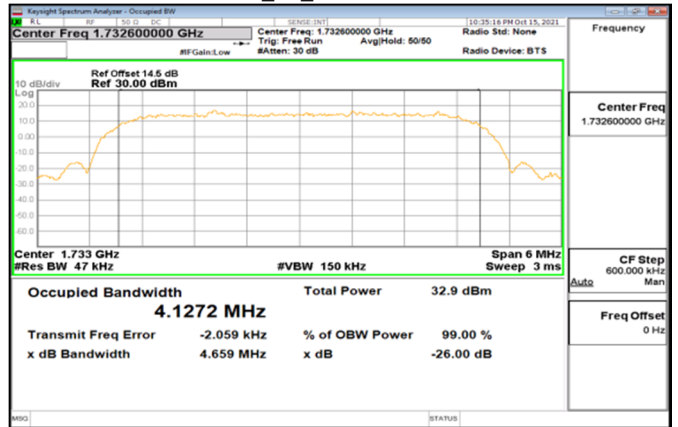

HSUPA_B2_HighCH9538-1907.6

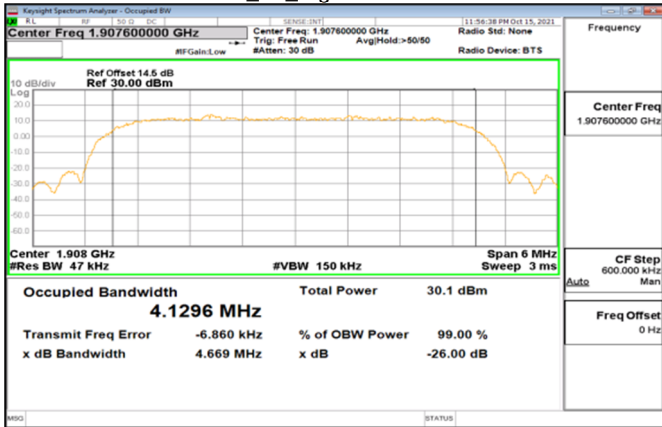

WCDMA_B4_HighCH1513-1752.6

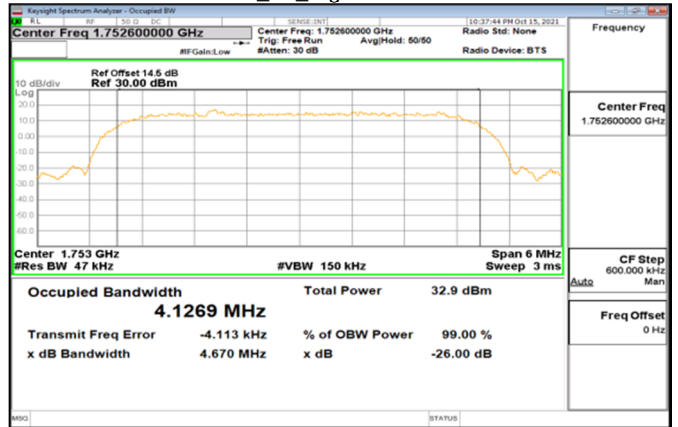

Unless otherwise stated the results shown in this test report refer only to the sample(s) tested and such sample(s) are retained for 90 days only.

除非另有說明，此報告結果僅對測試之樣品負責，同時此樣品僅保留90天。本報告未經本公司書面許可，不可部份複製。

This document is issued by the Company subject to its General Conditions of Service printed overleaf, available on request or accessible at <http://www.sgs.com.tw/Terms-and-Conditions> and for electronic format documents, subject to Terms and Conditions for Electronic Documents at <http://www.sgs.com.tw/Terms-and-Conditions>. Attention is drawn to the limitation of liability, indemnification and jurisdiction issues defined therein. Any holder of this document is advised that information contained herein reflects the Company's findings at the time of its intervention only and within the limits of Client's instructions, if any. The Company's sole responsibility is to its Client and this document does not exonerate parties to a transaction from exercising all their rights and obligations under the transaction documents. This document cannot be reproduced except in full, without prior written approval of the Company. Any unauthorized alteration, forgery or falsification of the content or appearance of this document is unlawful and offenders may be prosecuted to the fullest extent of the law.

HSDPA_B4_LowCH1312-1712.4

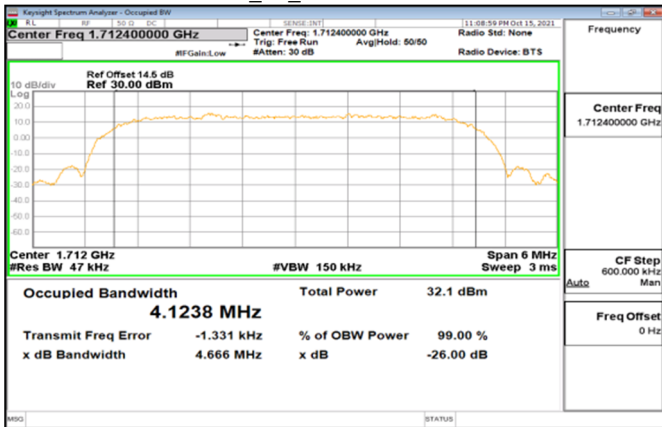

HSUPA_B4_LowCH1312-1712.4

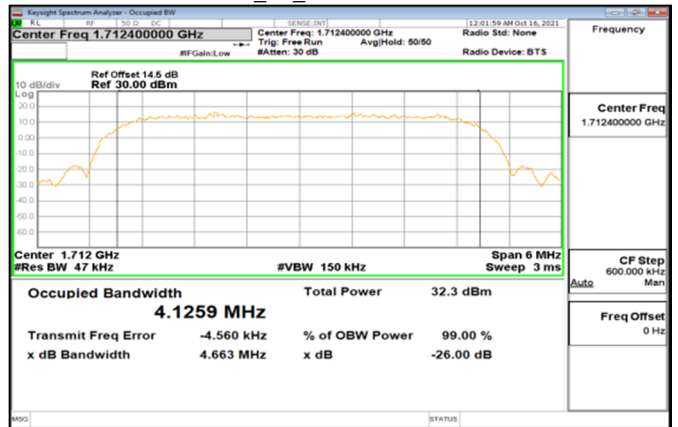

HSDPA_B4_MidCH1413-1732.6

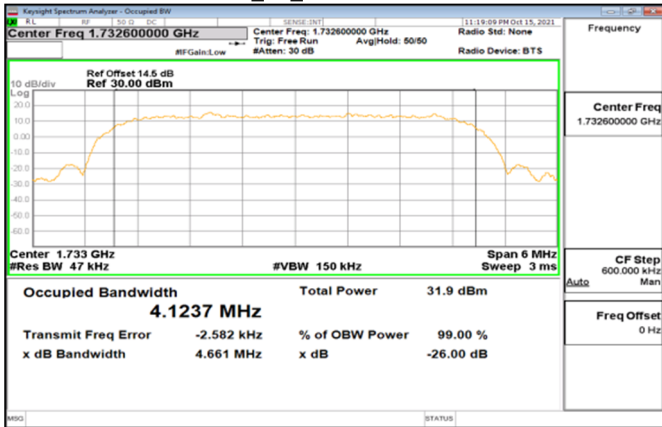

HSUPA_B4_MidCH1413-1732.6

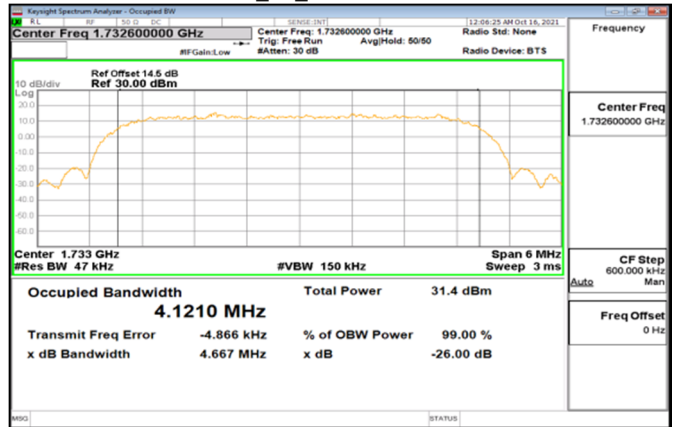

HSDPA_B4_HighCH1513-1752.6

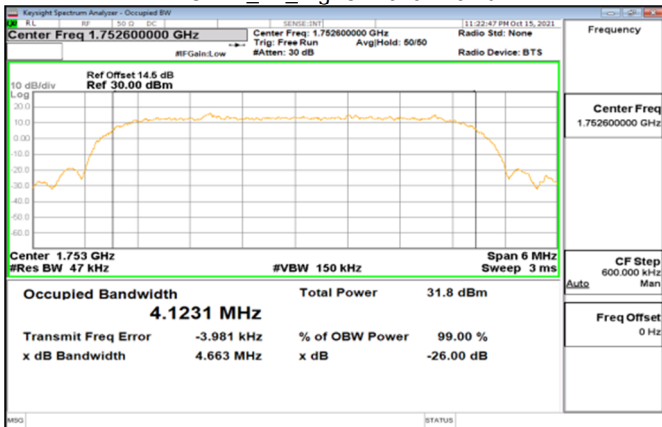

HSUPA_B4_HighCH1513-1752.6

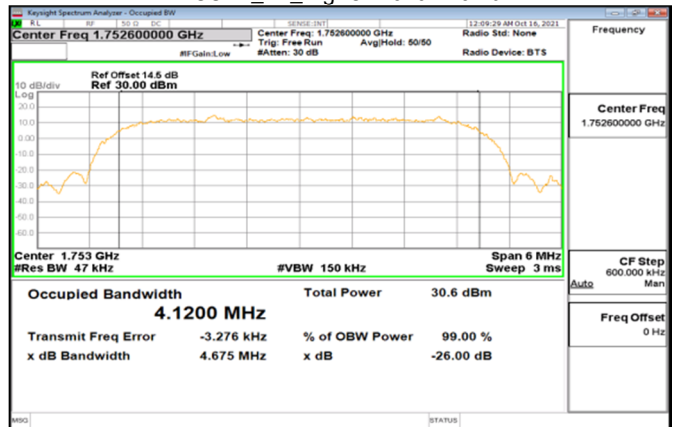

Unless otherwise stated the results shown in this test report refer only to the sample(s) tested and such sample(s) are retained for 90 days only.

除非另有說明，此報告結果僅對測試之樣品負責，同時此樣品僅保留90天。本報告未經本公司書面許可，不可部份複製。

This document is issued by the Company subject to its General Conditions of Service printed overleaf, available on request or accessible at <http://www.sgs.com.tw/Terms-and-Conditions> and for electronic format documents, subject to Terms and Conditions for Electronic Documents at <http://www.sgs.com.tw/Terms-and-Conditions>. Attention is drawn to the limitation of liability, indemnification and jurisdiction issues defined therein. Any holder of this document is advised that information contained herein reflects the Company's findings at the time of its intervention only and within the limits of Client's instructions, if any. The Company's sole responsibility is to its Client and this document does not exonerate parties to a transaction from exercising all their rights and obligations under the transaction documents. This document cannot be reproduced except in full, without prior written approval of the Company. Any unauthorized alteration, forgery or falsification of the content or appearance of this document is unlawful and offenders may be prosecuted to the fullest extent of the law.