

Band13_5MHz_QPSK_RB1_0_CH23205

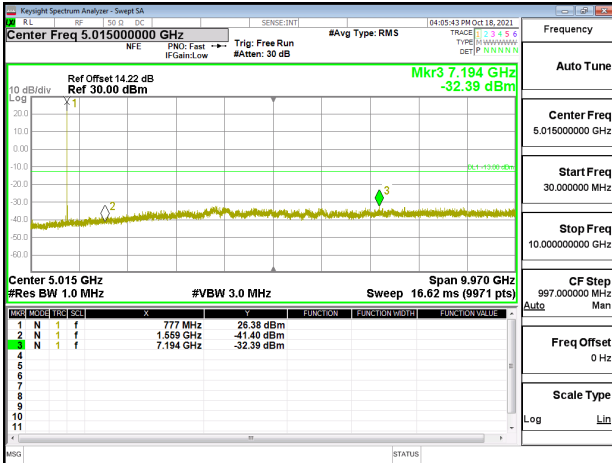

Band13_10MHz_QPSK_RB1_0_CH23230

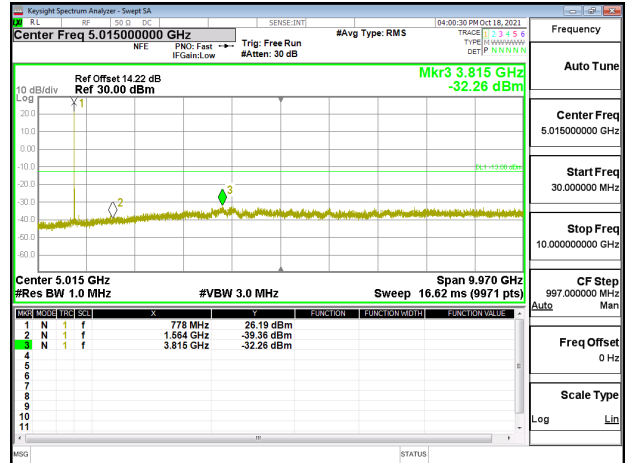

Band13_5MHz_QPSK_RB1_0_CH23230

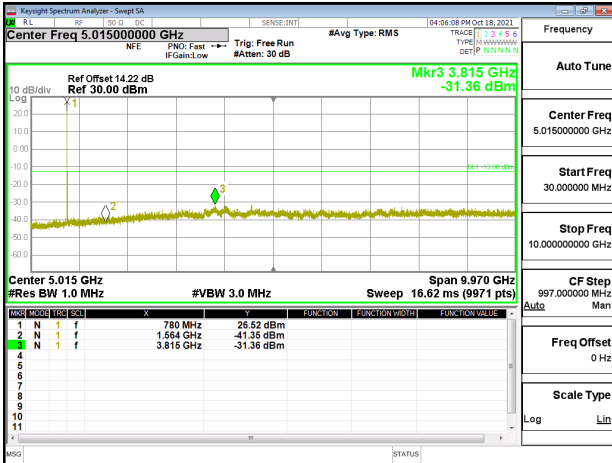

Band14_5MHz_QPSK_RB1_0_CH23305

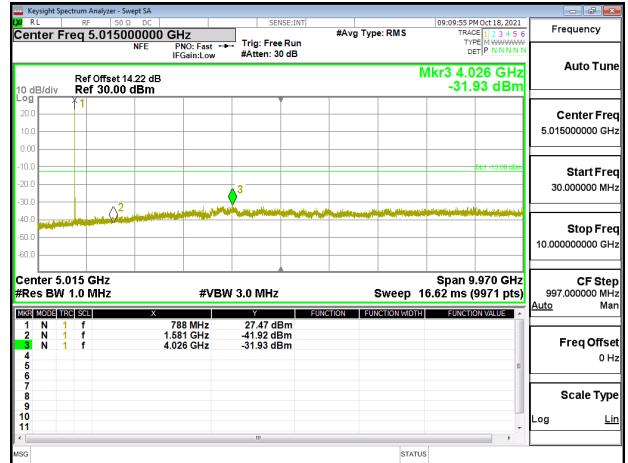

Band13_5MHz_QPSK_RB1_0_CH23255

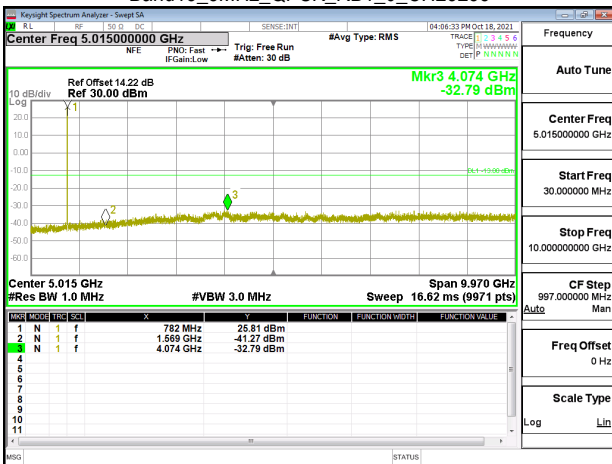

Band14_5MHz_QPSK_RB1_0_CH23330



Unless otherwise stated the results shown in this test report refer only to the sample(s) tested and such sample(s) are retained for 90 days only.

除非另有說明，此報告結果僅對測試之樣品負責，同時此樣品僅保留90天。本報告未經本公司書面許可，不可部份複製。

This document is issued by the Company subject to its General Conditions of Service printed overleaf, available on request or accessible at <http://www.sgs.com.tw/Terms-and-Conditions> and for electronic format documents, subject to Terms and Conditions for Electronic Documents at <http://www.sgs.com.tw/Terms-and-Conditions>. Attention is drawn to the limitation of liability, indemnification and jurisdiction issues defined therein. Any holder of this document is advised that information contained hereon reflects the Company's findings at the time of its intervention only and within the limits of Client's instructions, if any. The Company's sole responsibility is to its Client and this document does not exonerate parties to a transaction from exercising all their rights and obligations under the transaction documents. This document cannot be reproduced except in full, without prior written approval of the Company. Any unauthorized alteration, forgery or falsification of the content or appearance of this document is unlawful and offenders may be prosecuted to the fullest extent of the law.

Band14_5MHz_QPSK_RB1_0_CH23355

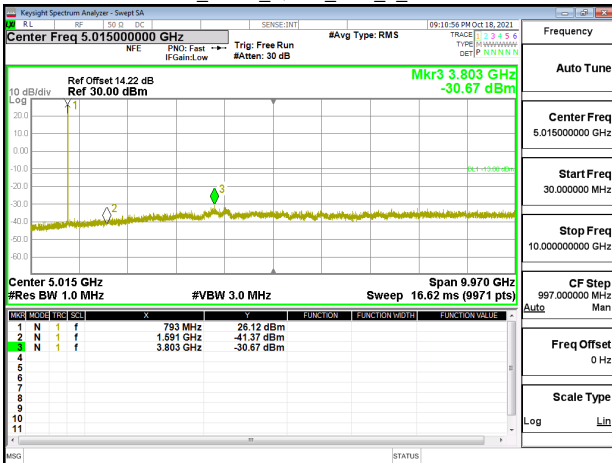

Band17_10MHz_QPSK_RB1_0_CH23790

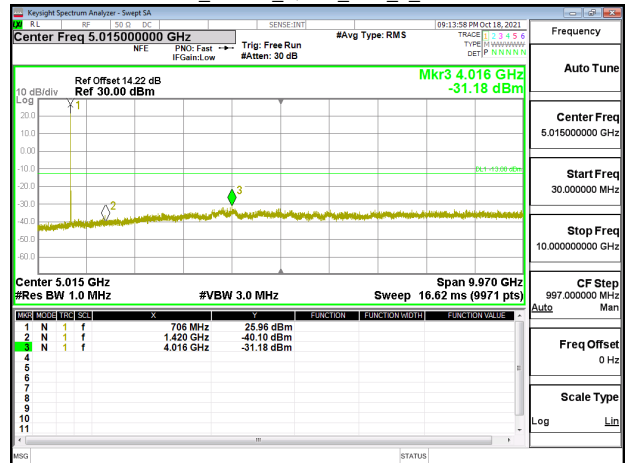

Band14_10MHz_QPSK_RB1_0_CH23330

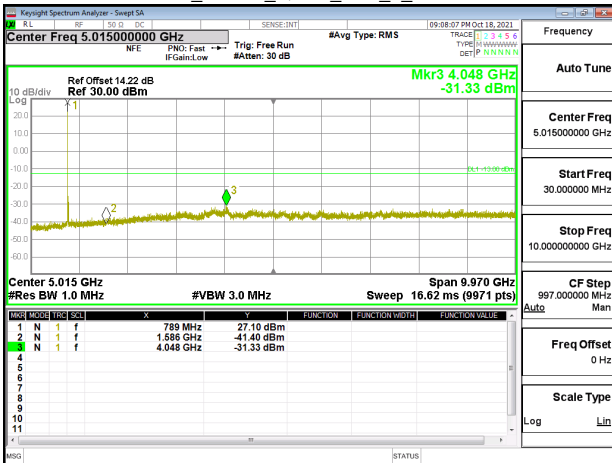

Band17_10MHz_QPSK_RB1_0_CH23800

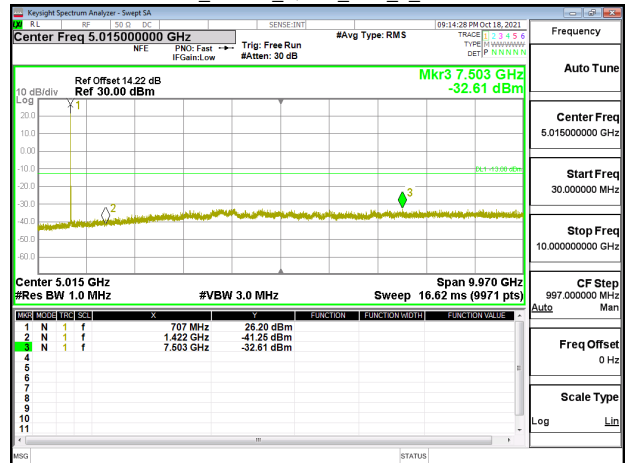

Band17_10MHz_QPSK_RB1_0_CH23780

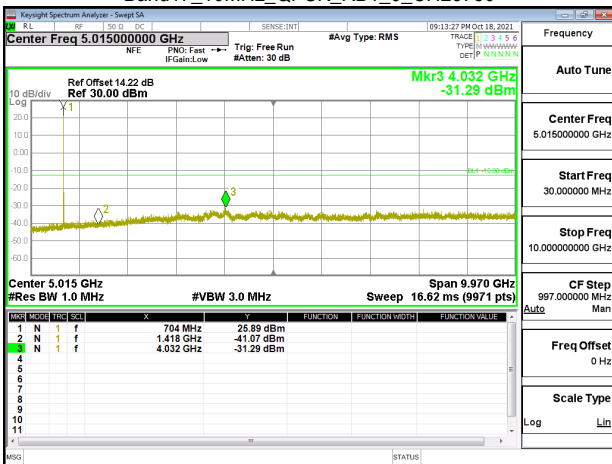

Band25_10MHz_QPSK_RB1_0_CH26090

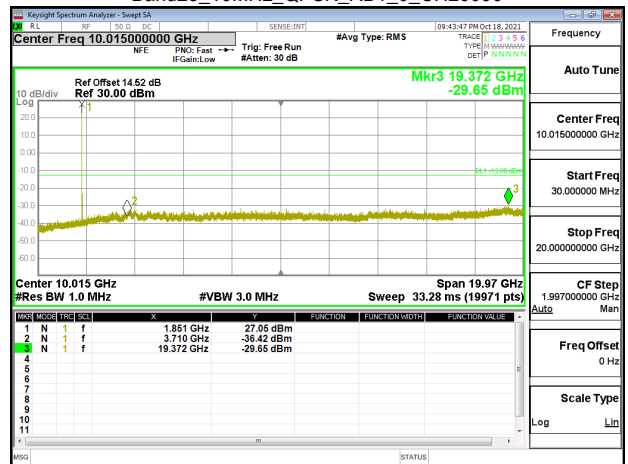

Unless otherwise stated the results shown in this test report refer only to the sample(s) tested and such sample(s) are retained for 90 days only.

除非另有說明，此報告結果僅對測試之樣品負責，同時此樣品僅保留90天。本報告未經本公司書面許可，不可部份複製。

This document is issued by the Company subject to its General Conditions of Service printed overleaf, available on request or accessible at <http://www.sgs.com.tw/Terms-and-Conditions> and for electronic format documents, subject to Terms and Conditions for Electronic Documents at <http://www.sgs.com.tw/Terms-and-Conditions>. Attention is drawn to the limitation of liability, indemnification and jurisdiction issues defined therein. Any holder of this document is advised that information contained herein reflects the Company's findings at the time of its intervention only and within the limits of Client's instructions, if any. The Company's sole responsibility is to its Client and this document does not exonerate parties to a transaction from exercising all their rights and obligations under the transaction documents. This document cannot be reproduced except in full, without prior written approval of the Company. Any unauthorized alteration, forgery or falsification of the content or appearance of this document is unlawful and offenders may be prosecuted to the fullest extent of the law.

Band25_10MHz_QPSK_RB1_0_CH26365

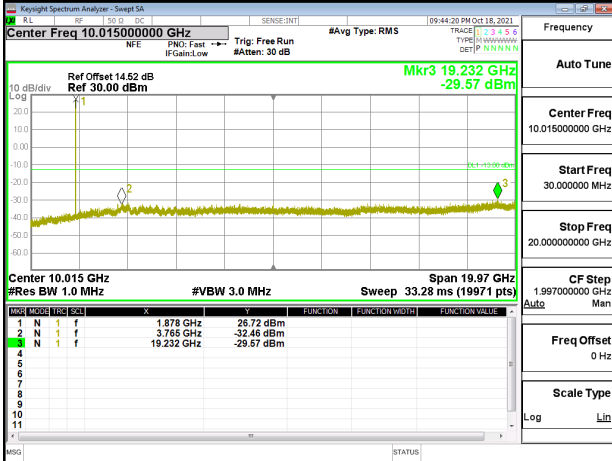

Band25_20MHz_QPSK_RB1_0_CH26365

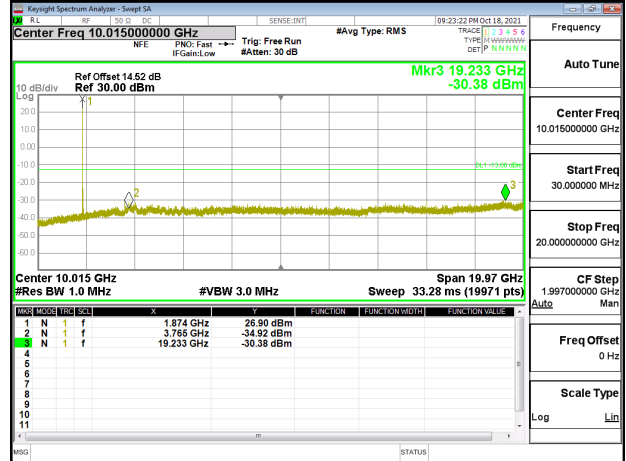

Band25_10MHz_QPSK_RB1_0_CH26640

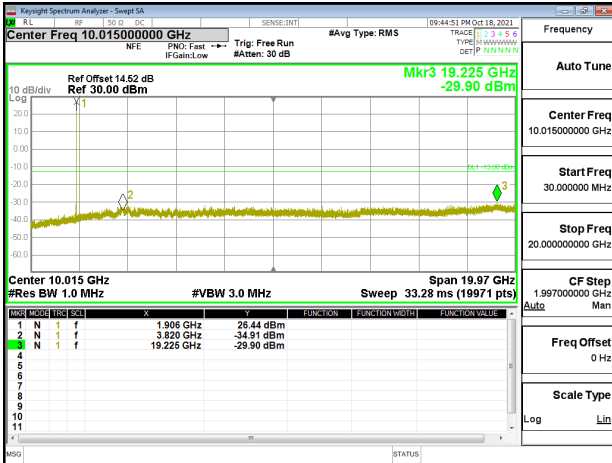

Band25_20MHz_QPSK_RB1_0_CH26590

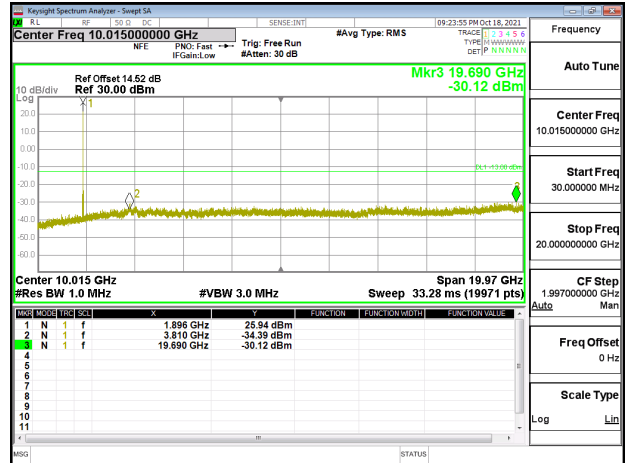

Band25_20MHz_QPSK_RB1_0_CH26140

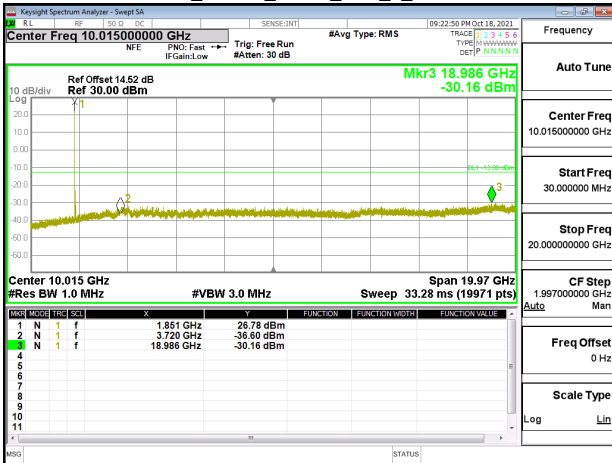

Band26-Part90s_3MHz_QPSK_RB1_0_CH26705

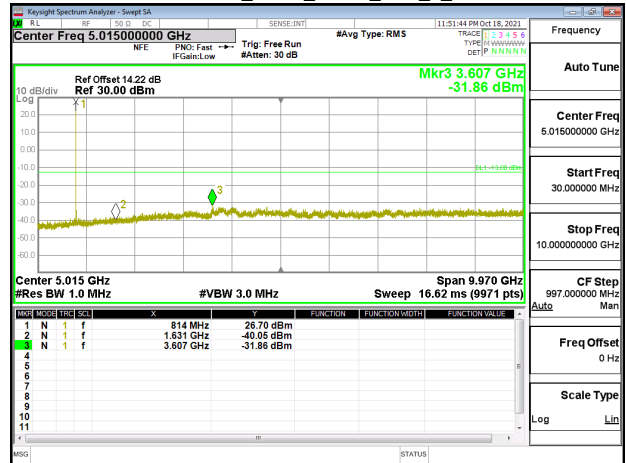

Unless otherwise stated the results shown in this test report refer only to the sample(s) tested and such sample(s) are retained for 90 days only.

除非另有說明，此報告結果僅對測試之樣品負責，同時此樣品僅保留90天。本報告未經本公司書面許可，不可部份複製。

This document is issued by the Company subject to its General Conditions of Service printed overleaf, available on request or accessible at <http://www.sgs.com.tw/Terms-and-Conditions> and for electronic format documents, subject to Terms and Conditions for Electronic Documents at <http://www.sgs.com.tw/Terms-and-Conditions>. Attention is drawn to the limitation of liability, indemnification and jurisdiction issues defined therein. Any holder of this document is advised that information contained herein reflects the Company's findings at the time of its intervention only and within the limits of Client's instructions, if any. The Company's sole responsibility is to its Client and this document does not exonerate parties to a transaction from exercising all their rights and obligations under the transaction documents. This document cannot be reproduced except in full, without prior written approval of the Company. Any unauthorized alteration, forgery or falsification of the content or appearance of this document is unlawful and offenders may be prosecuted to the fullest extent of the law.

Band26-Part90s_3MHz_QPSK_RB1_0_CH26740

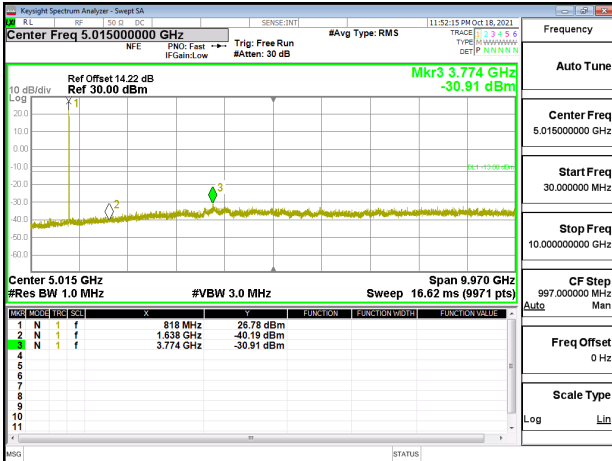

Band26_3MHz_QPSK_RB1_0_CH26805

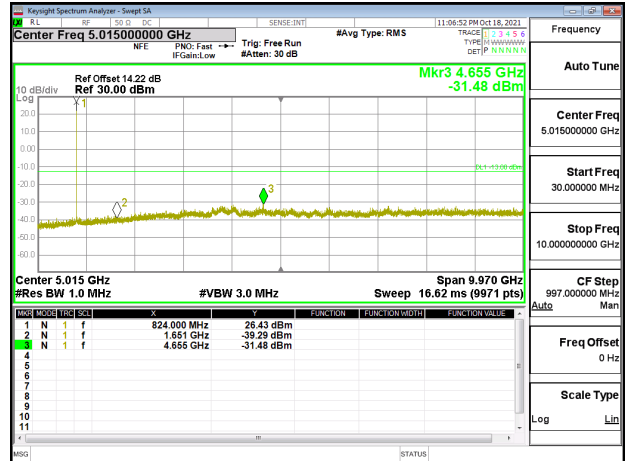

Band26-Part90s_3MHz_QPSK_RB1_0_CH26775

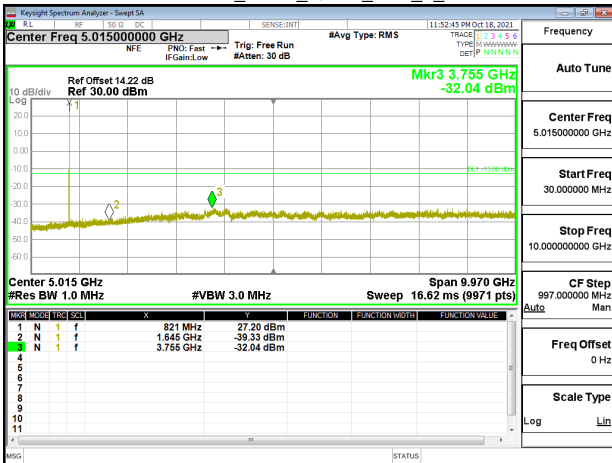

Band26_3MHz_QPSK_RB1_0_CH26915

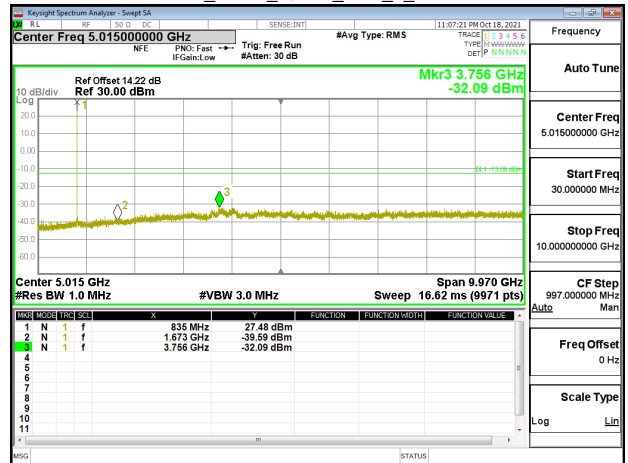

Band26-Part90s_10MHz_QPSK_RB1_0_CH26740



Band26_3MHz_QPSK_RB1_0_CH27025



Unless otherwise stated the results shown in this test report refer only to the sample(s) tested and such sample(s) are retained for 90 days only.

除非另有說明，此報告結果僅對測試之樣品負責，同時此樣品僅保留90天。本報告未經本公司書面許可，不可部份複製。

This document is issued by the Company subject to its General Conditions of Service printed overleaf, available on request or accessible at <http://www.sgs.com.tw/Terms-and-Conditions> and for electronic format documents, subject to Terms and Conditions for Electronic Documents at <http://www.sgs.com.tw/Terms-and-Conditions>. Attention is drawn to the limitation of liability, indemnification and jurisdiction issues defined therein. Any holder of this document is advised that information contained herein reflects the Company's findings at the time of its intervention only and within the limits of Client's instructions, if any. The Company's sole responsibility is to its Client and this document does not exonerate parties to a transaction from exercising all their rights and obligations under the transaction documents. This document cannot be reproduced except in full, without prior written approval of the Company. Any unauthorized alteration, forgery or falsification of the content or appearance of this document is unlawful and offenders may be prosecuted to the fullest extent of the law.

Band26_15MHz_QPSK_RB1_0_CH26865

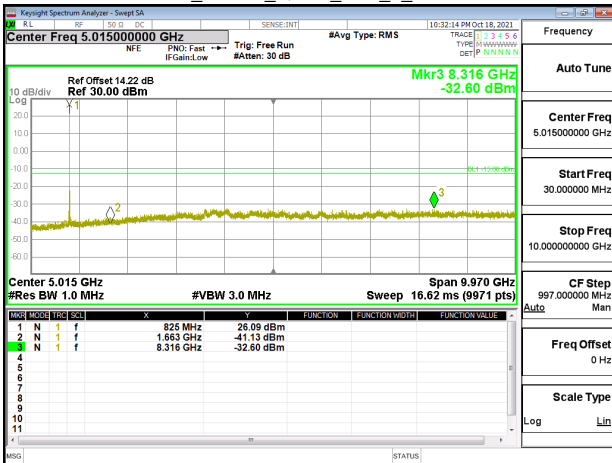

Band30_10MHz_QPSK_RB1_0_CH27710_1

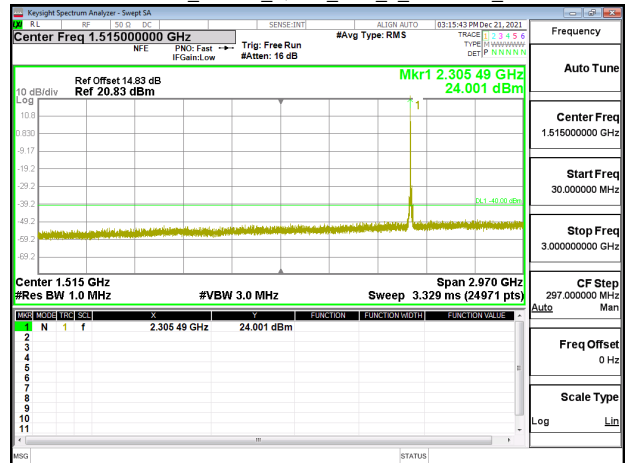

Band26_15MHz_QPSK_RB1_0_CH26915

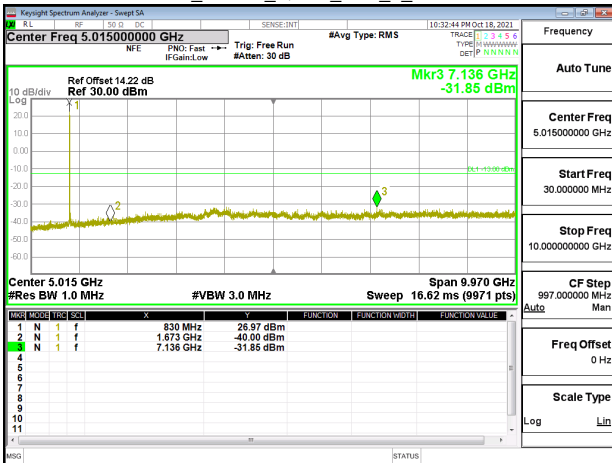

Band30_10MHz_QPSK_RB1_0_CH27710_2

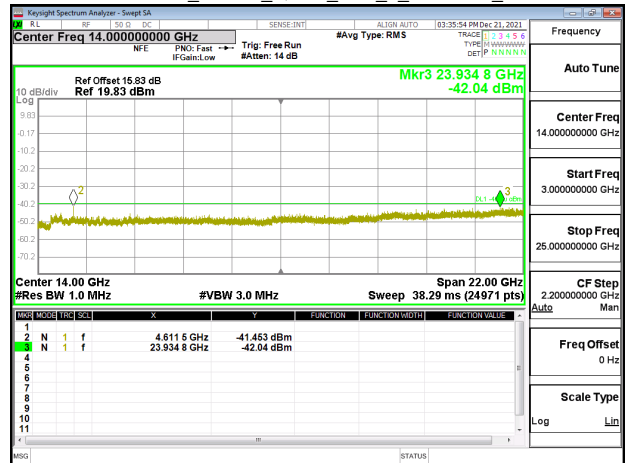

Band26_15MHz_QPSK_RB1_0_CH26965



Band38_15MHz_QPSK_RB1_0_CH37825

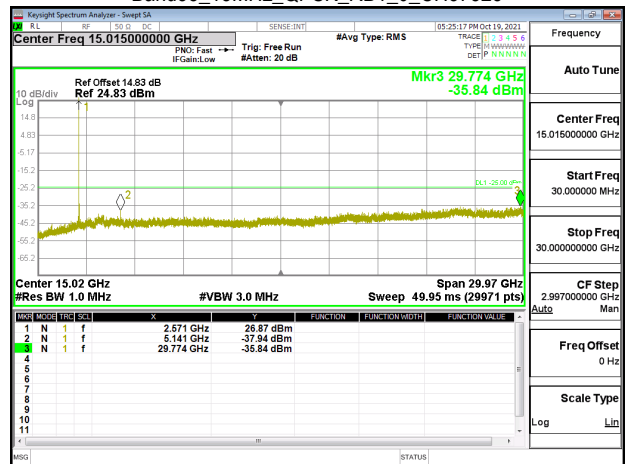

Unless otherwise stated the results shown in this test report refer only to the sample(s) tested and such sample(s) are retained for 90 days only.

除非另有說明，此報告結果僅對測試之樣品負責，同時此樣品僅保留90天。本報告未經本公司書面許可，不可部份複製。

This document is issued by the Company subject to its General Conditions of Service printed overleaf, available on request or accessible at <http://www.sgs.com.tw/Terms-and-Conditions> and for electronic format documents, subject to Terms and Conditions for Electronic Documents at <http://www.sgs.com.tw/Terms-and-Conditions>. Attention is drawn to the limitation of liability, indemnification and jurisdiction issues defined therein. Any holder of this document is advised that information contained herein reflects the Company's findings at the time of its intervention only and within the limits of Client's instructions, if any. The Company's sole responsibility is to its Client and this document does not exonerate parties to a transaction from exercising all their rights and obligations under the transaction documents. This document cannot be reproduced except in full, without prior written approval of the Company. Any unauthorized alteration, forgery or falsification of the content or appearance of this document is unlawful and offenders may be prosecuted to the fullest extent of the law.

Band38_15MHz_QPSK_RB1_0_CH38000



Band38_20MHz_QPSK_RB1_0_CH38000

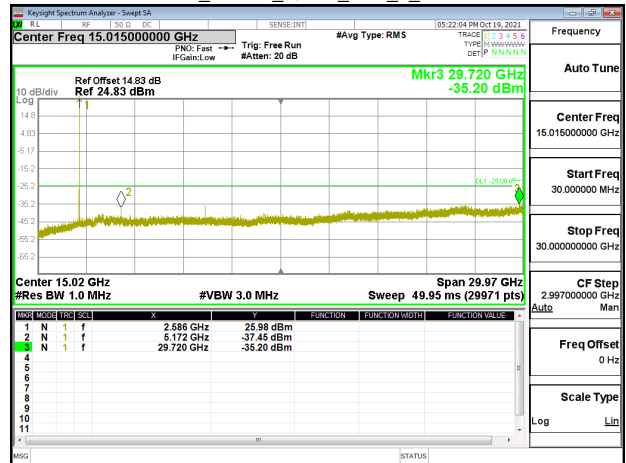

Band38_15MHz_QPSK_RB1_0_CH38175

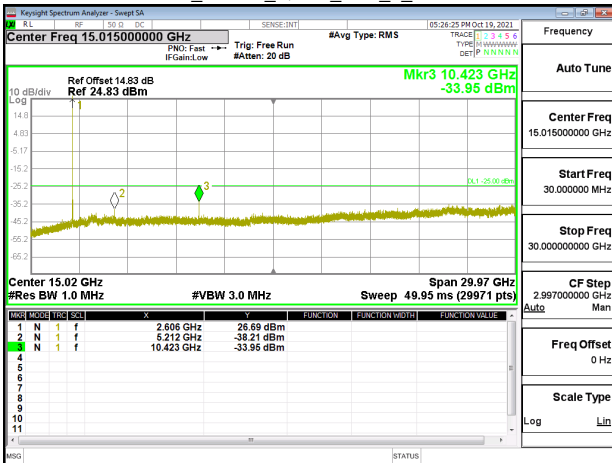

Band38_20MHz_QPSK_RB1_0_CH38150

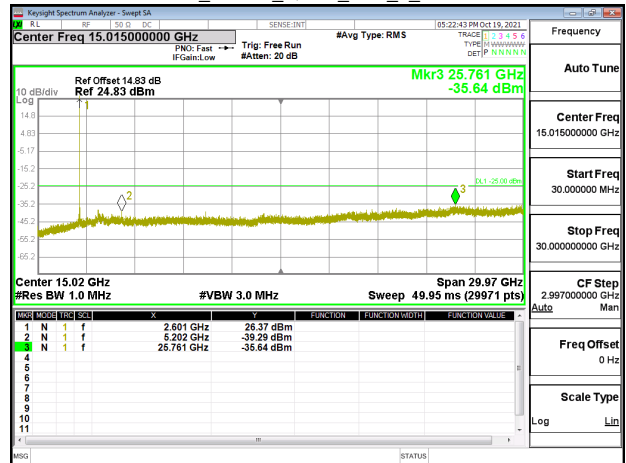

Band38_20MHz_QPSK_RB1_0_CH37850

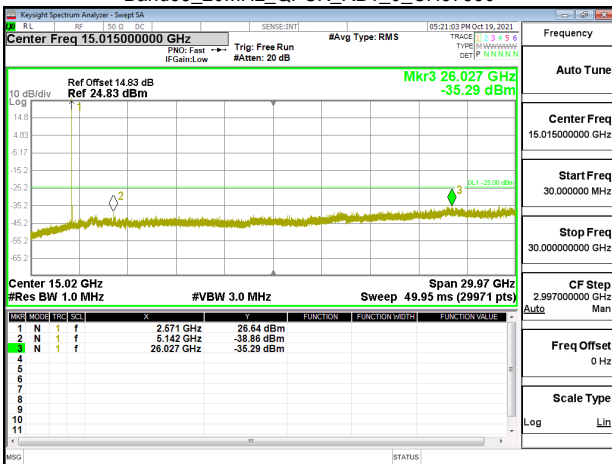

Band41_20MHz_QPSK_RB1_0_CH39750

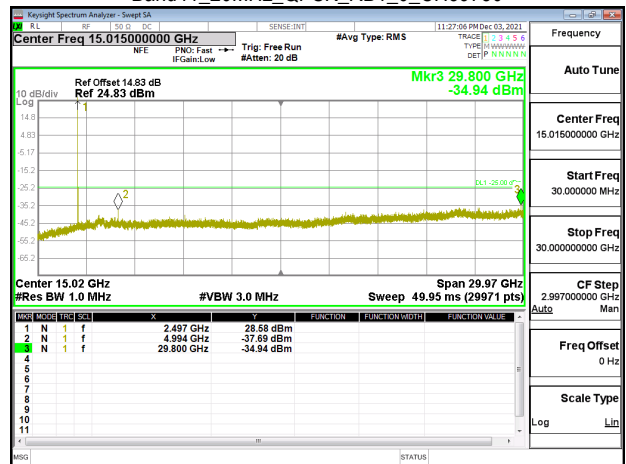

Unless otherwise stated the results shown in this test report refer only to the sample(s) tested and such sample(s) are retained for 90 days only.

除非另有說明，此報告結果僅對測試之樣品負責，同時此樣品僅保留90天。本報告未經本公司書面許可，不可部份複製。

This document is issued by the Company subject to its General Conditions of Service printed overleaf, available on request or accessible at <http://www.sgs.com.tw/Terms-and-Conditions> and for electronic format documents, subject to Terms and Conditions for Electronic Documents at <http://www.sgs.com.tw/Terms-and-Conditions>. Attention is drawn to the limitation of liability, indemnification and jurisdiction issues defined therein. Any holder of this document is advised that information contained herein reflects the Company's findings at the time of its intervention only and within the limits of Client's instructions, if any. The Company's sole responsibility is to its Client and this document does not exonerate parties to a transaction from exercising all their rights and obligations under the transaction documents. This document cannot be reproduced except in full, without prior written approval of the Company. Any unauthorized alteration, forgery or falsification of the content or appearance of this document is unlawful and offenders may be prosecuted to the fullest extent of the law.

Band41_20MHz_QPSK_RB1_0_CH40620

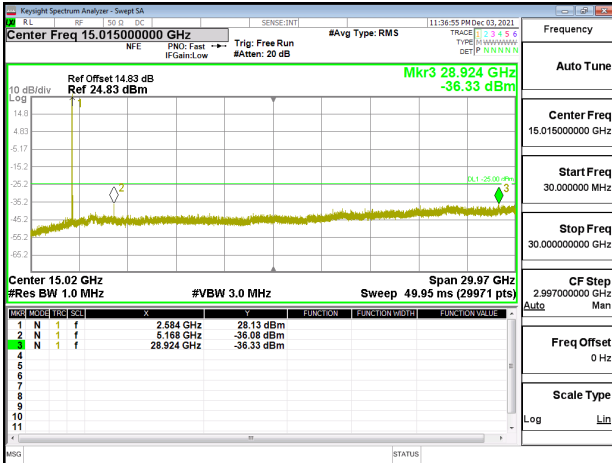

Band66_3MHz_QPSK_RB1_0_CH132322

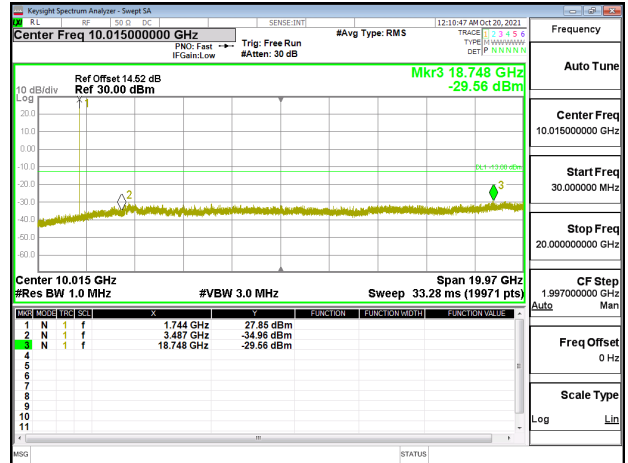

Band41_20MHz_QPSK_RB1_0_CH41490

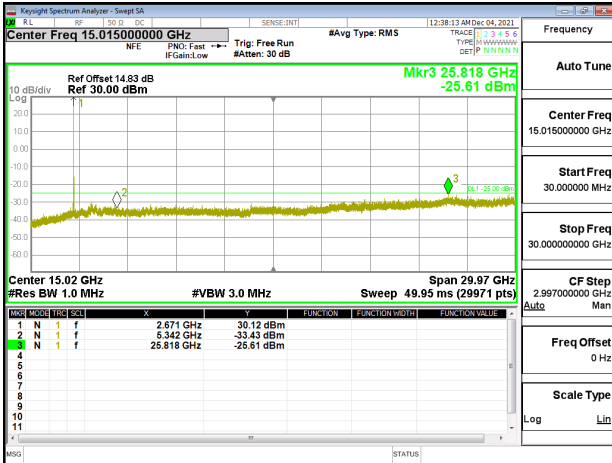

Band66_3MHz_QPSK_RB1_0_CH132657

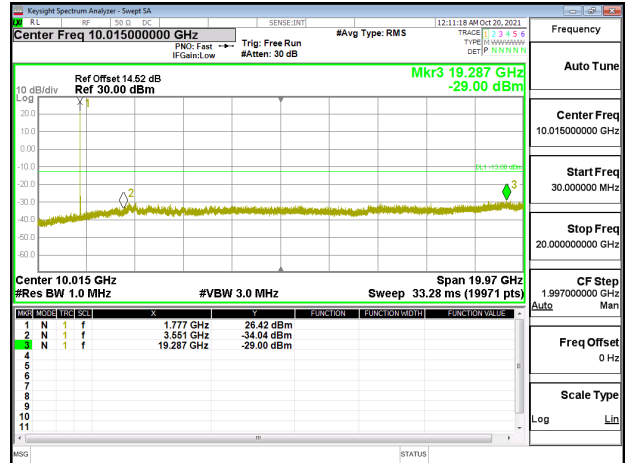

Band66_3MHz_QPSK_RB1_0_CH131987

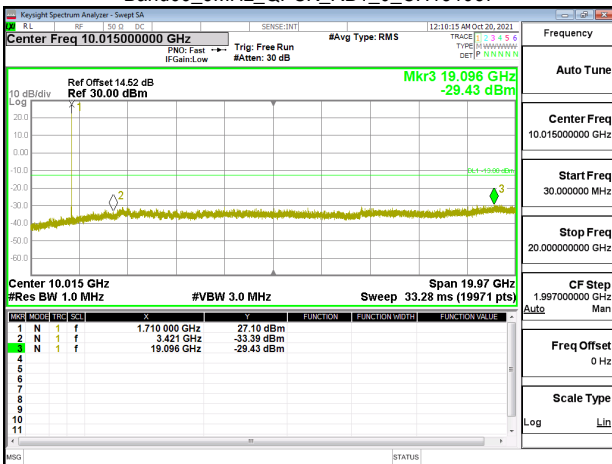

Band66_20MHz_QPSK_RB1_0_CH132072

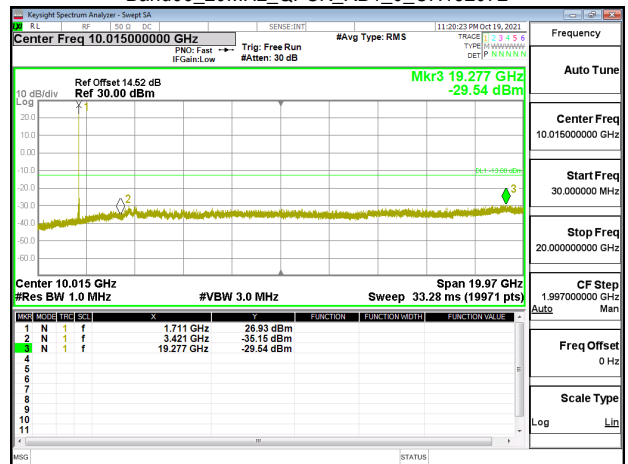

Unless otherwise stated the results shown in this test report refer only to the sample(s) tested and such sample(s) are retained for 90 days only.

除非另有說明，此報告結果僅對測試之樣品負責，同時此樣品僅保留90天。本報告未經本公司書面許可，不可部份複製。

This document is issued by the Company subject to its General Conditions of Service printed overleaf, available on request or accessible at <http://www.sgs.com.tw/Terms-and-Conditions> and for electronic format documents, subject to Terms and Conditions for Electronic Documents at <http://www.sgs.com.tw/Terms-and-Conditions>. Attention is drawn to the limitation of liability, indemnification and jurisdiction issues defined therein. Any holder of this document is advised that information contained herein reflects the Company's findings at the time of its intervention only and within the limits of Client's instructions, if any. The Company's sole responsibility is to its Client and this document does not exonerate parties to a transaction from exercising all their rights and obligations under the transaction documents. This document cannot be reproduced except in full, without prior written approval of the Company. Any unauthorized alteration, forgery or falsification of the content or appearance of this document is unlawful and offenders may be prosecuted to the fullest extent of the law.

Band66_20MHz_QPSK_RB1_0_CH132322

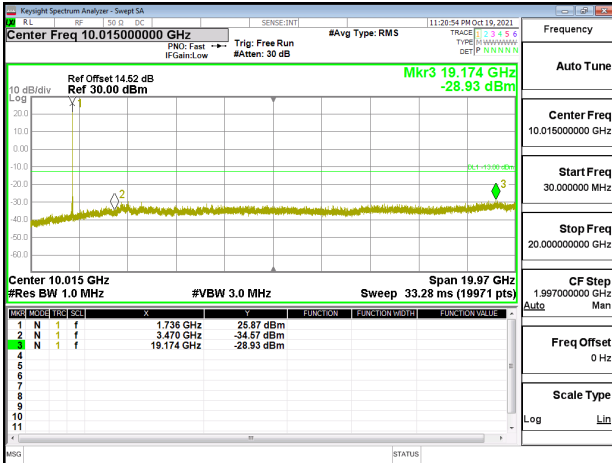

Band71_20MHz_QPSK_RB1_0_CH133297

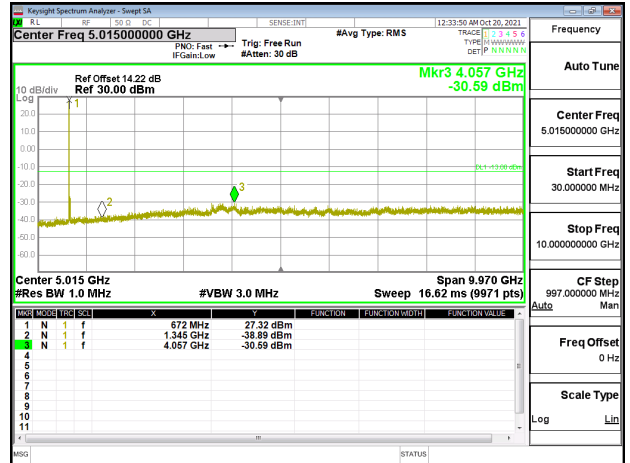

Band66_20MHz_QPSK_RB1_0_CH132572

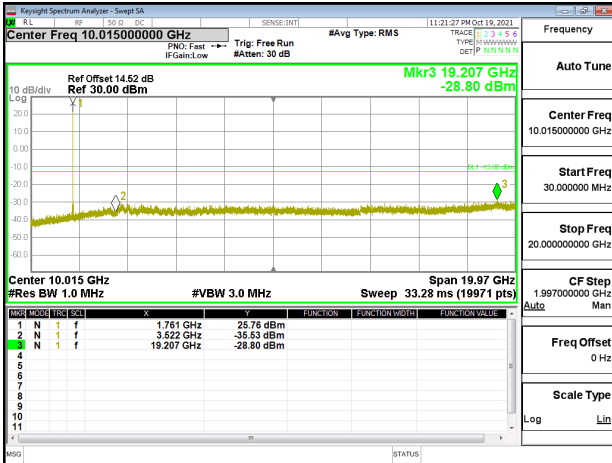

Band71_20MHz_QPSK_RB1_0_CH133372

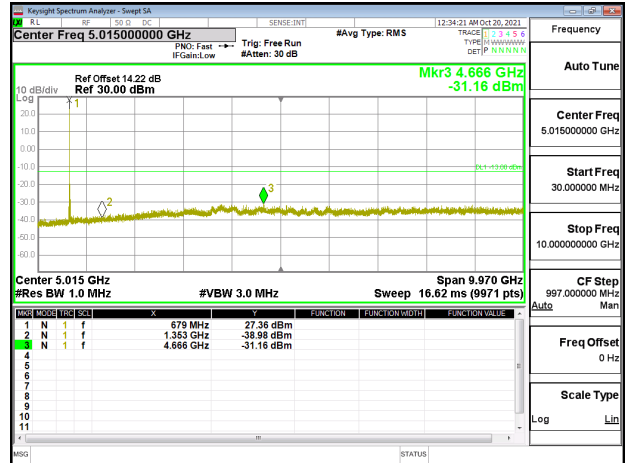

Band71_20MHz_QPSK_RB1_0_CH133222

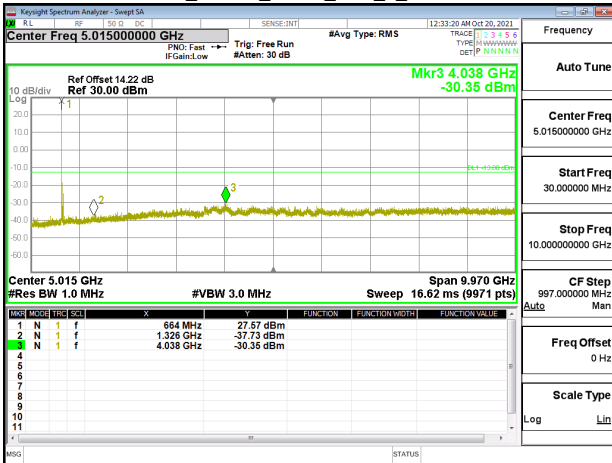

Unless otherwise stated the results shown in this test report refer only to the sample(s) tested and such sample(s) are retained for 90 days only.

除非另有說明，此報告結果僅對測試之樣品負責，同時此樣品僅保留90天。本報告未經本公司書面許可，不可部份複製。

This document is issued by the Company subject to its General Conditions of Service printed overleaf, available on request or accessible at <http://www.sgs.com.tw/Terms-and-Conditions> and for electronic format documents, subject to Terms and Conditions for Electronic Documents at <http://www.sgs.com.tw/Terms-and-Conditions>. Attention is drawn to the limitation of liability, indemnification and jurisdiction issues defined therein. Any holder of this document is advised that information contained herein reflects the Company's findings at the time of its intervention only and within the limits of Client's instructions, if any. The Company's sole responsibility is to its Client and this document does not exonerate parties to a transaction from exercising all their rights and obligations under the transaction documents. This document cannot be reproduced except in full, without prior written approval of the Company. Any unauthorized alteration, forgery or falsification of the content or appearance of this document is unlawful and offenders may be prosecuted to the fullest extent of the law.

10 FIELD STRENGTH OF SPURIOUS RADIATION MEASUREMENT

10.1 Standard Applicable

According to FCC §2.1053,

FCC §22.917(a), §24.238(a), §27.53(h), §90.543(e)(3)

RSS-130 §4.7, RSS-132 §5.5, RSS-133 §6.5.1, RSS-139 §6.6, RSS-140 §4.4, RSS-195 §5.6

RSS-199 §4.5

Out of band emissions. The power of any emission outside of the authorized operating frequency ranges must be attenuated below the transmitting power (P) by a factor of at least $43 + 10 \log(P)$ dB.

FCC §27.53(a)

For operations in the 2305-2320 MHz band and the 2345-2360 MHz band, the power of any emission outside a licensee's frequency band(s) of operation shall be attenuated below the transmitter power P (with averaging performed only during periods of transmission) within the licensed band(s) of operation, in watts, by the following amounts:

- (4) For mobile and portable stations operating in the 2305-2315 MHz and 2350-2360 MHz bands:
 - (ii) By a factor of not less than $70 + 10 \log(P)$ dB below 2288 MHz;
 - (iii) By a factor of not less than $70 + 10 \log(P)$ dB above 2365 MHz.

FCC §27.53(g)

Compliance for operations in the 600 MHz, 698-746 MHz, 746-758 MHz and the 776-788 MHz band with this provision is based on the use of measurement instrumentation employing a resolution bandwidth of 100 kilohertz or greater. However, in the 100 kilohertz bands immediately outside and adjacent to a licensee's frequency block, a resolution bandwidth of at least 30 kHz may be employed.

- (2) On any frequency outside the 776-788 MHz band, the power of any emission shall be attenuated outside the band below the transmitter power (P) by at least $43 + 10 \log(P)$ dB;
- (3) On all frequencies between 763-775 MHz and 793-805 MHz, by a factor not less than $76 + 10 \log(P)$ dB in a 6.25 kHz band segment, for base and fixed stations;
- (4) On all frequencies between 763-775 MHz and 793-805 MHz, by a factor not less than $65 + 10 \log(P)$ dB in a 6.25 kHz band segment, for mobile and portable stations;

FCC §90.543 (f)

For operations in the 758-775 MHz and 788-805 MHz bands, all emissions including harmonics in the band 1559-1610 MHz shall be limited to -70 dBW/MHz equivalent isotropically radiated power (EIRP) for wideband signals, and -80 dBW EIRP for discrete emissions of less than 700 Hz bandwidth. For the purpose of equipment authorization, a transmitter shall be tested with an antenna that is representative of the type that will be used with the equipment in normal operation.

RSS-130 §4.7.1

Compliance for operations in the 617-652 MHz, 663-698 MHz, 698-756 MHz and the 777-787 MHz band, the unwanted emissions in any 100 kHz bandwidth on any frequency outside the low frequency edge and the high frequency edge of each frequency block range(s), shall be attenuated below the transmitter power, P (dBW), by at least $43 + 10 \log_{10} p$ (watts), dB. However, in the 100 kHz band immediately outside of the equipment's frequency block range, a resolution bandwidth of 30 kHz may be employed.

RSS-130 §4.7.2

In addition to the limit outlined in section 4.7.1 above, equipment operating in the frequency bands 746-756 MHz and 777-787 MHz shall also comply with the following restrictions:
the power of any unwanted emissions in any 6.25 kHz bandwidth for all frequencies between 763-775 MHz and 793-806 MHz shall be attenuated below the transmitter power, P (dBW), by at least:

Unless otherwise stated the results shown in this test report refer only to the sample(s) tested and such sample(s) are retained for 90 days only.

除非另有說明，此報告結果僅對測試之樣品負責，同時此樣品僅保留90天。本報告未經本公司書面許可，不可部份複製。

This document is issued by the Company subject to its General Conditions of Service printed overleaf, available on request or accessible at <http://www.sgs.com.tw/Terms-and-Conditions> and for electronic format documents, subject to Terms and Conditions for Electronic Documents at <http://www.sgs.com.tw/Terms-and-Conditions>. Attention is drawn to the limitation of liability, indemnification and jurisdiction issues defined therein. Any holder of this document is advised that information contained hereon reflects the Company's findings at the time of its intervention only and within the limits of Client's instructions, if any. The Company's sole responsibility is to its Client and this document does not exonerate parties to a transaction from exercising all their rights and obligations under the transaction documents. This document cannot be reproduced except in full, without prior written approval of the Company. Any unauthorized alteration, forgery or falsification of the content or appearance of this document is unlawful and offenders may be prosecuted to the fullest extent of the law.

76 + 10 log₁₀ p (watts), dB, for base and fixed equipment and
65 + 10 log₁₀ p (watts), dB, for mobile and portable equipment

the e.i.r.p. in the band 1559-1610 MHz shall not exceed -70 dBW/MHz for wideband signal and
-80 dBW for discrete emission with bandwidth less than 700 Hz.

FCC §27.53(h)(1)

(h) *AWS emission limits*—(1) *General protection levels*. Except as otherwise specified below, for operations in the 1695-1710 MHz, 1710-1755 MHz, 1755-1780 MHz, 1915-1920 MHz, 1995-2000 MHz, 2000-2020 MHz, 2110-2155 MHz, 2155-2180 MHz, and 2180-2200 bands, the power of any emission outside a licensee's frequency block shall be attenuated below the transmitter power (P) in watts by at least 43 + 10 log₁₀ (P) dB.

ISED RSS-132 §5.5

Mobile and base station equipment shall comply with the limits in (i) and (ii) below.

- i. In the first 1.0 MHz band immediately outside and adjacent to each of the sub-bands specified in Section 5.1, the power of emissions per any 1% of the occupied bandwidth shall be attenuated (in dB) below the transmitter output power P (dBW) by at least 43 + 10 log₁₀p (watts).
- ii. After the first 1.0 MHz immediately outside and adjacent to each of the sub-bands, the power of emissions in any 100 kHz bandwidth shall be attenuated (in dB) below the transmitter output power P (dBW) by at least 43 + 10 log₁₀ p (watts). If the measurement is performed using 1% of the occupied bandwidth, power integration over 100 kHz is required.

ISED RSS-133 §6.5.1

Equipment shall comply with the limits in (i) and (ii) below.

- i. In the 1.0 MHz bands immediately outside and adjacent to the equipment's operating frequency block, the emission power per any 1% of the emission bandwidth shall be attenuated (in dB) below the transmitter output power P (dBW) by at least 43 + 10 log₁₀p(watts).
- ii. After the first 1.0 MHz, the emission power in any 1 MHz bandwidth shall be attenuated (in dB) below the transmitter output power P (dBW) by at least 43 + 10 log₁₀p(watts). If the measurement is performed using 1% of the emission bandwidth, power integration over 1.0 MHz is required.

RSS-139 §6.6

In the first 1.0 MHz bands immediately outside and adjacent to the equipment's smallest operating frequency block, Footnote 2 which can contain the equipment's occupied bandwidth, the emission power per any 1% of the emission bandwidth shall be attenuated below the transmitter output power P (in dBW) by at least 43 + 10 log₁₀ p (watts) dB.

After the first 1.0 MHz outside the equipment's smallest operating frequency block, which can contain the equipment's occupied bandwidth, the emission power in any 1 MHz bandwidth shall be attenuated below the transmitter output power P (in dBW) by at least 43 + 10 log₁₀ p (watts) dB.

ISED RSS-140 §4.4

- a. For any frequency between 769-775 MHz and 799-806 MHz:
 - i. 76 + 10 log (p), dB in a 6.25 kHz band for fixed and base station equipment
 - ii. 65 + 10 log (p), dB in a 6.25 kHz band for mobile and portable/hand-held equipment

Unless otherwise stated the results shown in this test report refer only to the sample(s) tested and such sample(s) are retained for 90 days only.

除非另有說明，此報告結果僅對測試之樣品負責，同時此樣品僅保留90天。本報告未經本公司書面許可，不可部份複製。

This document is issued by the Company subject to its General Conditions of Service printed overleaf, available on request or accessible at <http://www.sgs.com.tw/Terms-and-Conditions> and for electronic format documents, subject to Terms and Conditions for Electronic Documents at <http://www.sgs.com.tw/Terms-and-Conditions>. Attention is drawn to the limitation of liability, indemnification and jurisdiction issues defined therein. Any holder of this document is advised that information contained hereon reflects the Company's findings at the time of its intervention only and within the limits of Client's instructions, if any. The Company's sole responsibility is to its Client and this document does not exonerate parties to a transaction from exercising all their rights and obligations under the transaction documents. This document cannot be reproduced except in full, without prior written approval of the Company. Any unauthorized alteration, forgery or falsification of the content or appearance of this document is unlawful and offenders may be prosecuted to the fullest extent of the law.

- b. For any frequency between 775-788 MHz, above 806 MHz, and below 758 MHz: $43 + 10 \log (p)$, dB in a bandwidth of 100 kHz or greater. However, in the 100 kHz bands immediately outside and adjacent to the frequency bands 758-768 MHz and 788-798 MHz, a resolution bandwidth of 30 kHz may be employed.

Unless otherwise stated the results shown in this test report refer only to the sample(s) tested and such sample(s) are retained for 90 days only.

除非另有說明，此報告結果僅對測試之樣品負責，同時此樣品僅保留90天。本報告未經本公司書面許可，不可部份複製。

This document is issued by the Company subject to its General Conditions of Service printed overleaf, available on request or accessible at <http://www.sgs.com.tw/Terms-and-Conditions> and for electronic format documents, subject to Terms and Conditions for Electronic Documents at <http://www.sgs.com.tw/Terms-and-Conditions>. Attention is drawn to the limitation of liability, indemnification and jurisdiction issues defined therein. Any holder of this document is advised that information contained hereon reflects the Company's findings at the time of its intervention only and within the limits of Client's instructions, if any. The Company's sole responsibility is to its Client and this document does not exonerate parties to a transaction from exercising all their rights and obligations under the transaction documents. This document cannot be reproduced except in full, without prior written approval of the Company. Any unauthorized alteration, forgery or falsification of the content or appearance of this document is unlawful and offenders may be prosecuted to the fullest extent of the law.

ISED RSS-195 §5.6

The power of any emission outside the frequency range(s) in which the equipment operates shall be attenuated below the transmitter power, P(dBW), by the amount indicated in Table 2, where p is the transmitter output power measured in watts.

Table 2 — Unwanted Emissions for Mobile, Portable and Low-Power Fixed Subscriber Equipment			
Frequency (MHz)	Attenuation (dB)	Frequency (MHz)	Attenuation (dB)
<2200	43 + 10 log ₁₀ (p)	2324 - 2328	61 + 10 log ₁₀ (p)
2200 - 2288	70 + 10 log ₁₀ (p)	2328 - 2337	67 + 10 log ₁₀ (p)
2288 - 2292	67 + 10 log ₁₀ (p)	2337 - 2341	61 + 10 log ₁₀ (p)
2292 - 2296	61 + 10 log ₁₀ (p)	2341 - 2345	55 + 10 log ₁₀ (p)
2296 - 2300	55 + 10 log ₁₀ (p)	2345 - 2360	43 + 10 log ₁₀ (p) FootnoteNote
2300 - 2305	43 + 10 log ₁₀ (p)	2360 - 2365	43 + 10 log ₁₀ (p)
2305 - 2320	43 + 10 log ₁₀ (p) FootnoteNote	2365 - 2395	70 + 10 log ₁₀ (p)
2320 - 2324	55 + 10 log ₁₀ (p)	>2395	43 + 10 log ₁₀ (p)

Note -- Mobile and portable equipment are prohibited from transmitting in the bands 2315-2320 MHz and 2345-2350 MHz. In addition, mobile and portable equipment employing FDD technology shall be restricted to transmitting in the band 2305-2315 MHz.

FCC §27.53(m) (4) (6)

For mobile digital stations, the attenuation factor shall be not less than 40 + 10 log (P) dB on all frequencies between the channel edge and 5 megahertz from the channel edge, 43 + 10 log (P) dB on all frequencies between 5 megahertz and X megahertz from the channel edge, and 55 + 10 log (P) dB on all frequencies more than X megahertz from the channel edge, where X is the greater of 6 megahertz or the actual emission bandwidth as defined in paragraph (m)(6) of this section. In addition, the attenuation factor shall not be less than 43 + 10 log (P) dB on all frequencies between 2490.5 MHz and 2496 MHz and 55 + 10 log (P) dB at or below 2490.5 MHz. Mobile Satellite Service licensees operating on frequencies below 2495 MHz may also submit a documented interference complaint against BRS licensees operating on channel BRS Channel 1 on the same terms and conditions as adjacent channel BRS or EBS licensees.

Measurement procedure. Compliance with these rules is based on the use of measurement instrumentation employing a resolution bandwidth of 1 megahertz or greater. However, in the 1 MHz bands immediately outside and adjacent to the frequency block a resolution bandwidth of at least one percent of the emission bandwidth of the fundamental emission of the transmitter may be employed; for mobile digital stations, in the 1 megahertz bands immediately outside and adjacent to the frequency block a resolution bandwidth of at least two percent may be employed, except when the 1 megahertz band is 2495-2496 MHz, in which case a resolution bandwidth of at least one percent may be employed. A narrower resolution bandwidth is permitted in all cases to improve measurement accuracy provided the measured power is integrated over the full required measurement bandwidth (i.e. 1 megahertz or 1 percent of emission bandwidth, as specified; or 1 megahertz or 2 percent for mobile digital stations, except in the band 2495-2496 MHz). The emission bandwidth is defined as the width of the signal between two points, one below the carrier center frequency and one above the carrier center frequency, outside of which all emissions are attenuated at least 26 dB below the transmitter power. With respect to television operations, measurements must be made of the separate visual and aural operating powers at sufficiently frequent intervals to ensure compliance with the rules.

RSS-199 §4.5

In the 1 MHz band immediately outside and adjacent to the channel edge, the unwanted emission

Unless otherwise stated the results shown in this test report refer only to the sample(s) tested and such sample(s) are retained for 90 days only.

除非另有說明，此報告結果僅對測試之樣品負責，同時此樣品僅保留90天。本報告未經本公司書面許可，不可部份複製。

This document is issued by the Company subject to its General Conditions of Service printed overleaf, available on request or accessible at <http://www.sgs.com.tw/Terms-and-Conditions> and for electronic format documents, subject to Terms and Conditions for Electronic Documents at <http://www.sgs.com.tw/Terms-and-Conditions>. Attention is drawn to the limitation of liability, indemnification and jurisdiction issues defined therein. Any holder of this document is advised that information contained herein reflects the Company's findings at the time of its intervention only and within the limits of Client's instructions, if any. The Company's sole responsibility is to its Client and this document does not exonerate parties to a transaction from exercising all their rights and obligations under the transaction documents. This document cannot be reproduced except in full, without prior written approval of the Company. Any unauthorized alteration, forgery or falsification of the content or appearance of this document is unlawful and offenders may be prosecuted to the fullest extent of the law.

power shall be measured with a resolution bandwidth of at least 1% of the occupied bandwidth for base station and fixed subscriber equipment, and 2% for mobile subscriber equipment. Beyond the 1 MHz band, a resolution bandwidth of 1 MHz shall be used. A narrower resolution bandwidth can be used, provided that the measured power is integrated over the full required measurement bandwidth of 1 MHz, or 1% or 2% of the occupied bandwidth, as applicable.

Equipment shall comply with the following unwanted emission limits:

for base station and fixed subscriber equipment, the power of any unwanted emissions measured as above shall be attenuated (in dB) below the transmitter power, P (dBW), by at least $43 + 10 \log_{10} p$ for mobile subscriber equipment, the power of any unwanted emissions measured as above shall be attenuated (in dB) below the transmitter power, P (dBW), by at least:

$40 + 10 \log_{10} p$ from the channel edges to 5 MHz away

$43 + 10 \log_{10} p$ between 5 MHz and X MHz from the channel edges, and

$55 + 10 \log_{10} p$ at X MHz and beyond from the channel edges

In addition, the attenuation shall not be less than $43 + 10 \log_{10} p$ on all frequencies between 2490.5 MHz and 2496 MHz, and $55 + 10 \log_{10} p$ at or below 2490.5 MHz.

In (a) and (b), p is the transmitter power measured in watts and X is 6 MHz or the equipment occupied bandwidth, whichever is greater.

§90.691 Emission mask requirements for EA-based systems

(a) Out-of-band emission requirement shall apply only to the “outer” channels included in an EA license and to spectrum adjacent to interior channels used by incumbent licensees. The emission limits are as follows:

(1) For any frequency removed from the EA licensee's frequency block by up to and including 37.5 kHz, the power of any emission shall be attenuated below the transmitter power (P) in watts by at least $116 \text{Log}_{10}(f/6.1)$ decibels or $50 + 10 \text{Log}_{10}(P)$ decibels or 80 decibels, whichever is the lesser attenuation, where f is the frequency removed from the center of the outer channel in the block in kilohertz and where f is greater than 12.5 kHz.

(2) For any frequency removed from the EA licensee's frequency block greater than 37.5 kHz, the power of any emission shall be attenuated below the transmitter power (P) in watts by at least $43 + 10 \text{Log}_{10}(P)$ decibels or 80 decibels, whichever is the lesser attenuation, where f is the frequency removed from the center of the outer channel in the block in kilohertz and where f is greater than 37.5 kHz.

Unless otherwise stated the results shown in this test report refer only to the sample(s) tested and such sample(s) are retained for 90 days only.

除非另有說明，此報告結果僅對測試之樣品負責，同時此樣品僅保留90天。本報告未經本公司書面許可，不可部份複製。

This document is issued by the Company subject to its General Conditions of Service printed overleaf, available on request or accessible at <http://www.sgs.com.tw/Terms-and-Conditions> and for electronic format documents, subject to Terms and Conditions for Electronic Documents at <http://www.sgs.com.tw/Terms-and-Conditions>. Attention is drawn to the limitation of liability, indemnification and jurisdiction issues defined therein. Any holder of this document is advised that information contained hereon reflects the Company's findings at the time of its intervention only and within the limits of Client's instructions, if any. The Company's sole responsibility is to its Client and this document does not exonerate parties to a transaction from exercising all their rights and obligations under the transaction documents. This document cannot be reproduced except in full, without prior written approval of the Company. Any unauthorized alteration, forgery or falsification of the content or appearance of this document is unlawful and offenders may be prosecuted to the fullest extent of the law.

10.2 EUT Setup

Radiated Emission Test Set-Up, Frequency Below 1000MHz

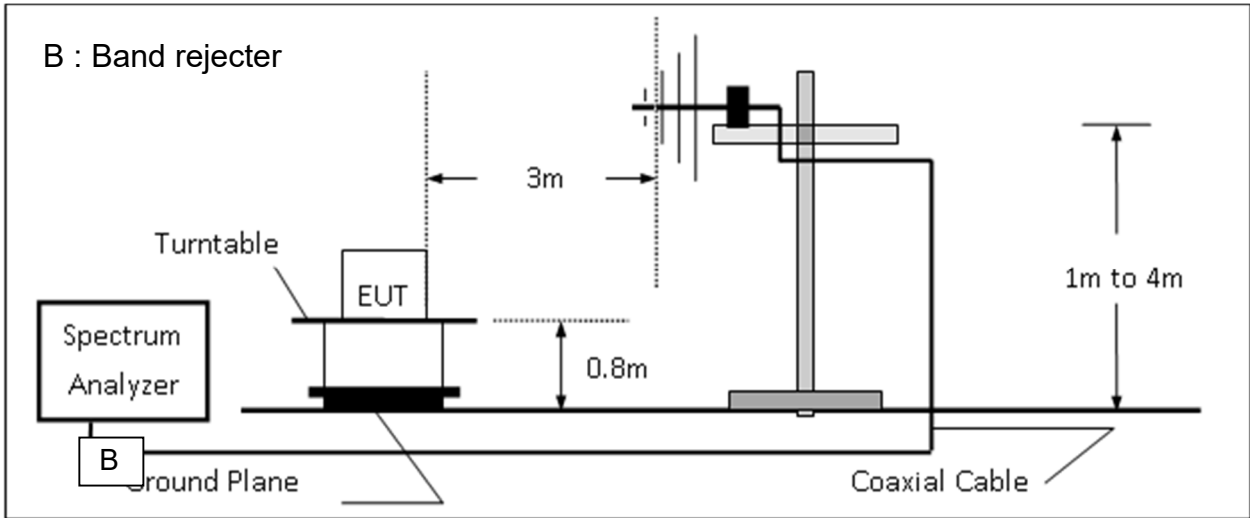

Radiated Emission Test Set-UP Frequency Over 1 GHz

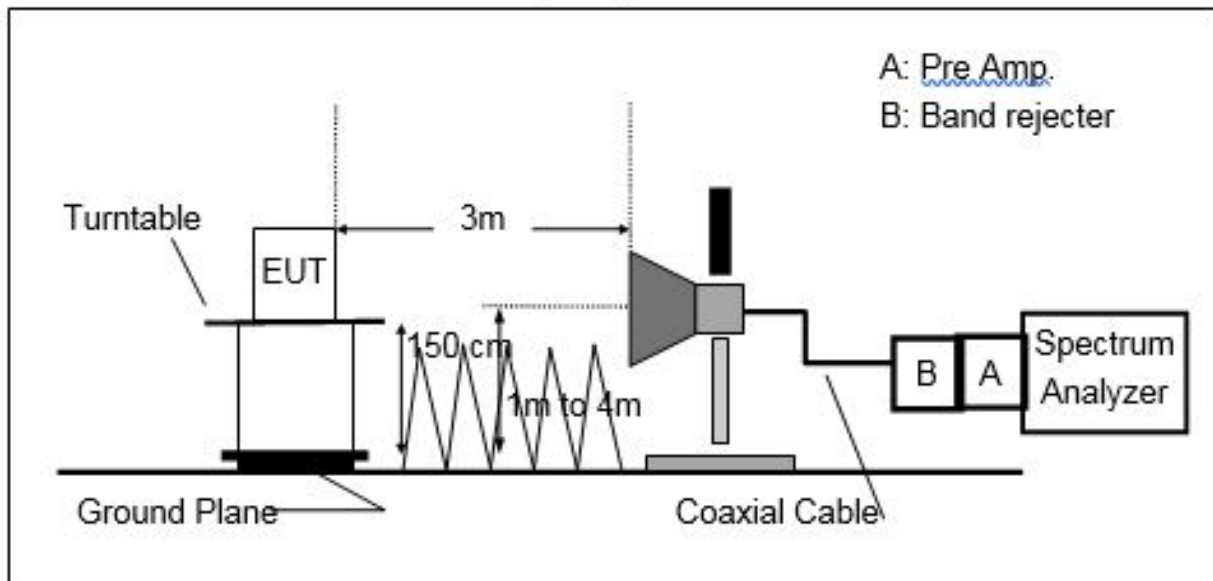

Unless otherwise stated the results shown in this test report refer only to the sample(s) tested and such sample(s) are retained for 90 days only.

除非另有說明，此報告結果僅對測試之樣品負責，同時此樣品僅保留90天。本報告未經本公司書面許可，不可部份複製。

This document is issued by the Company subject to its General Conditions of Service printed overleaf, available on request or accessible at <http://www.sgs.com.tw/Terms-and-Conditions> and for electronic format documents, subject to Terms and Conditions for Electronic Documents at <http://www.sgs.com.tw/Terms-and-Conditions>. Attention is drawn to the limitation of liability, indemnification and jurisdiction issues defined therein. Any holder of this document is advised that information contained hereon reflects the Company's findings at the time of its intervention only and within the limits of Client's instructions, if any. The Company's sole responsibility is to its Client and this document does not exonerate parties to a transaction from exercising all their rights and obligations under the transaction documents. This document cannot be reproduced except in full, without prior written approval of the Company. Any unauthorized alteration, forgery or falsification of the content or appearance of this document is unlawful and offenders may be prosecuted to the fullest extent of the law.

10.3 Measurement Procedure:

The EUT was placed on a non-conductive; the measurement antenna was placed at a distance of 3 meters from the EUT. During the tests, the antenna height and the EUT azimuth were varied in order to identify the maximum level of emissions from the EUT. This maximization process was repeated with the EUT positioned in each of its three orthogonal orientations.

The frequency range up to tenth harmonic was investigated for each of three fundamental frequencies (low, middle and high channels). Once spurious emission was identified, the power of the emission was determined using the substitution method.

The spurious emissions attenuation was calculated as the difference between radiated power at the fundamental frequency and the spurious emissions frequency.

ERP (dBm) = SG Level(dBm) + Antenna Gain(dBd) + Cable Loss(dB)

EIRP (dBm) = SG Level(dBm) + Antenna Gain(dBi) + Cable Loss(dB)

Unless otherwise stated the results shown in this test report refer only to the sample(s) tested and such sample(s) are retained for 90 days only.

除非另有說明，此報告結果僅對測試之樣品負責，同時此樣品僅保留90天。本報告未經本公司書面許可，不可部份複製。

This document is issued by the Company subject to its General Conditions of Service printed overleaf, available on request or accessible at <http://www.sgs.com.tw/Terms-and-Conditions> and for electronic format documents, subject to Terms and Conditions for Electronic Documents at <http://www.sgs.com.tw/Terms-and-Conditions>. Attention is drawn to the limitation of liability, indemnification and jurisdiction issues defined therein. Any holder of this document is advised that information contained hereon reflects the Company's findings at the time of its intervention only and within the limits of Client's instructions, if any. The Company's sole responsibility is to its Client and this document does not exonerate parties to a transaction from exercising all their rights and obligations under the transaction documents. This document cannot be reproduced except in full, without prior written approval of the Company. Any unauthorized alteration, forgery or falsification of the content or appearance of this document is unlawful and offenders may be prosecuted to the fullest extent of the law.

10.4 Measurement Result:

Report Number	:ER/2021/A0027	Test Site	:SAC 1
Operation Mode	:LTE B2	Test Date	:2021-11-12
Test Mode	:Tx CH Low	Temp./Humi.	:23.8/53
EUT Pol	:H Plane	Antenna Pol.	:Vertical
Test Frequency	:1855 MHz	Engineer	:GN Lin

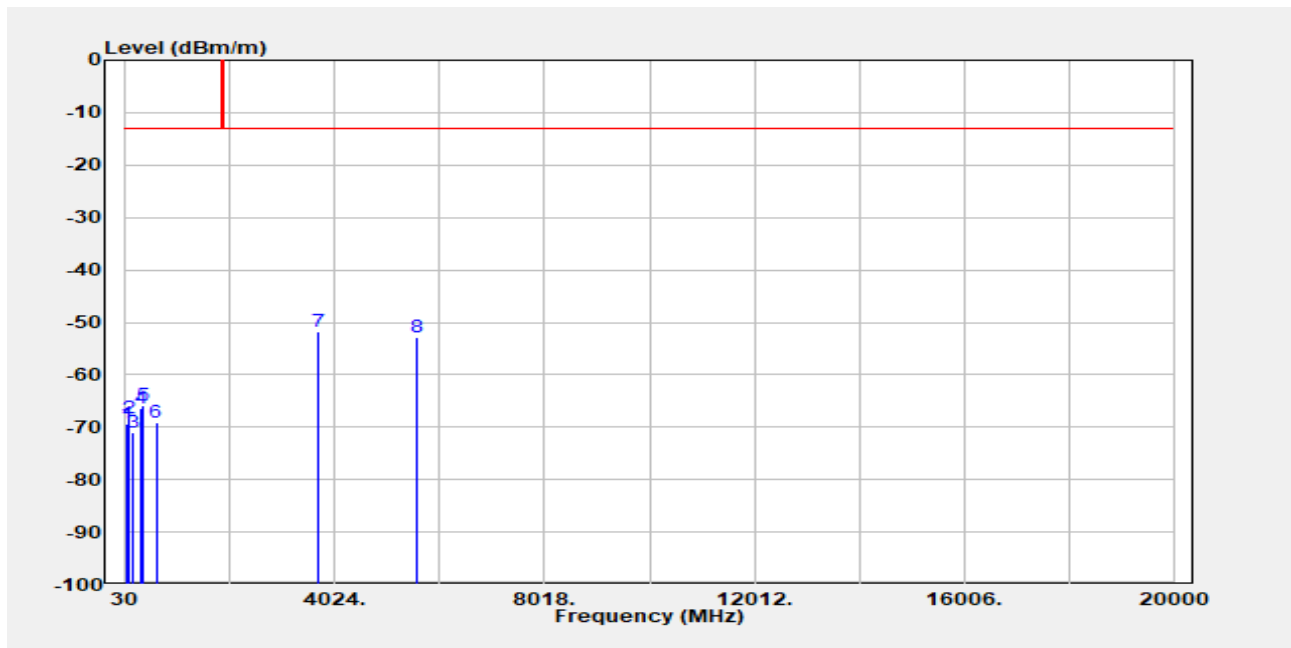

Freq. MHz	EIRP/ERP dBm	SG Output Level dBm	Antenna Gain dBi/dBd	Cable Loss dB	Limit dBm	Margin dB
62.33	-69.30	-59.72	-8.83	-0.76	-13.00	-56.30
107.60	-68.37	-65.90	-1.42	-1.04	-13.00	-55.37
164.18	-70.93	-68.80	-0.88	-1.26	-13.00	-57.93
335.55	-66.38	-68.76	4.28	-1.90	-13.00	-53.38
348.48	-65.78	-68.29	4.52	-2.01	-13.00	-52.78
610.38	-69.04	-70.03	3.48	-2.50	-13.00	-56.04
3710.00	-51.63	-56.40	12.32	-7.54	-13.00	-38.63
5565.00	-52.91	-56.34	12.93	-9.50	-13.00	-39.91

Unless otherwise stated the results shown in this test report refer only to the sample(s) tested and such sample(s) are retained for 90 days only.

除非另有說明，此報告結果僅對測試之樣品負責，同時此樣品僅保留90天。本報告未經本公司書面許可，不可部份複製。

This document is issued by the Company subject to its General Conditions of Service printed overleaf, available on request or accessible at <http://www.sgs.com.tw/Terms-and-Conditions> and for electronic format documents, subject to Terms and Conditions for Electronic Documents at <http://www.sgs.com.tw/Terms-and-Conditions>. Attention is drawn to the limitation of liability, indemnification and jurisdiction issues defined therein. Any holder of this document is advised that information contained hereon reflects the Company's findings at the time of its intervention only and within the limits of Client's instructions, if any. The Company's sole responsibility is to its Client and this document does not exonerate parties to a transaction from exercising all their rights and obligations under the transaction documents. This document cannot be reproduced except in full, without prior written approval of the Company. Any unauthorized alteration, forgery or falsification of the content or appearance of this document is unlawful and offenders may be prosecuted to the fullest extent of the law.

Report Number :ER/2021/A0027
 Operation Mode :LTE B2
 Test Mode :Tx CH Low
 EUT Pol :H Plane
 Test Frequency :1855 MHz

Test Site :SAC 1
 Test Date :2021-11-12
 Temp./Humi. :23.8/53
 Antenna Pol. :Horizontal
 Engineer :GN Lin

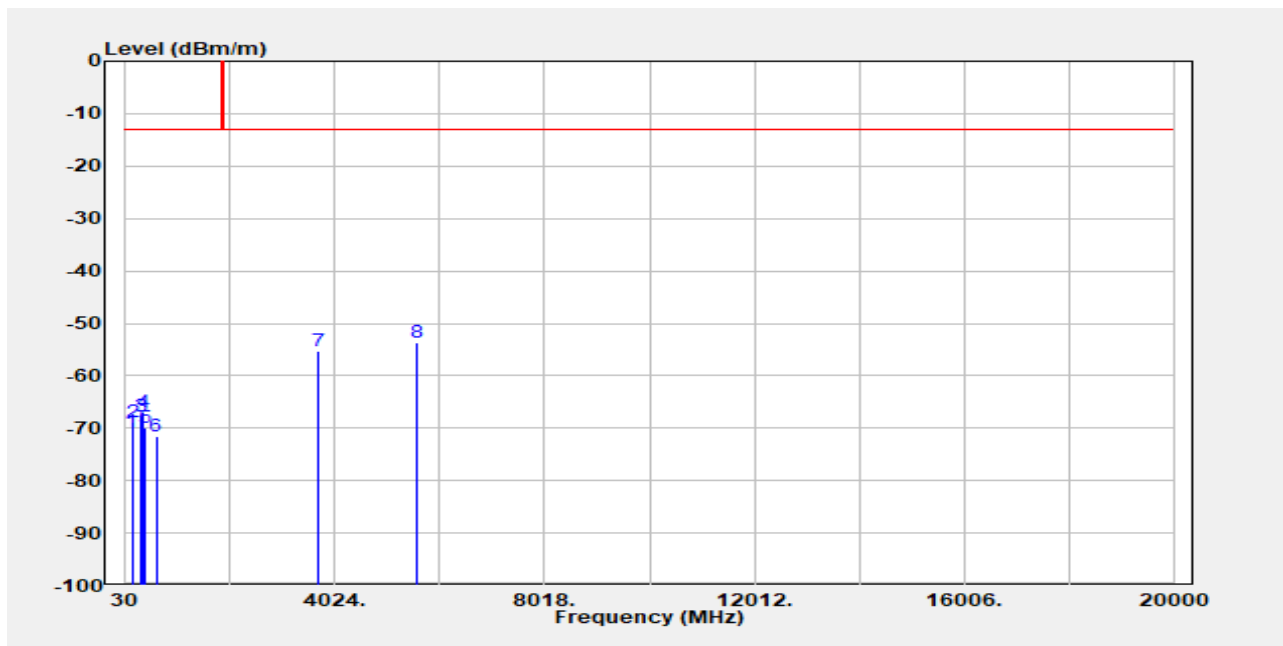

Freq. MHz	EIRP/ERP dBm	SG Output Level dBm	Antenna Gain dBi/dBd	Cable Loss dB	Limit dBm	Margin dB
149.63	-70.86	-68.09	-1.62	-1.15	-13.00	-57.86
164.18	-68.88	-66.75	-0.88	-1.26	-13.00	-55.88
335.55	-67.84	-70.22	4.28	-1.90	-13.00	-54.84
348.48	-66.84	-69.35	4.52	-2.01	-13.00	-53.84
388.90	-70.03	-72.39	4.40	-2.04	-13.00	-57.03
610.38	-71.58	-72.57	3.48	-2.50	-13.00	-58.58
3710.00	-55.25	-60.03	12.32	-7.54	-13.00	-42.25
5565.00	-53.76	-57.19	12.93	-9.50	-13.00	-40.76

Unless otherwise stated the results shown in this test report refer only to the sample(s) tested and such sample(s) are retained for 90 days only.

除非另有說明，此報告結果僅對測試之樣品負責，同時此樣品僅保留90天。本報告未經本公司書面許可，不可部份複製。

This document is issued by the Company subject to its General Conditions of Service printed overleaf, available on request or accessible at <http://www.sgs.com.tw/Terms-and-Conditions> and for electronic format documents, subject to Terms and Conditions for Electronic Documents at <http://www.sgs.com.tw/Terms-and-Conditions>. Attention is drawn to the limitation of liability, indemnification and jurisdiction issues defined therein. Any holder of this document is advised that information contained hereon reflects the Company's findings at the time of its intervention only and within the limits of Client's instructions, if any. The Company's sole responsibility is to its Client and this document does not exonerate parties to a transaction from exercising all their rights and obligations under the transaction documents. This document cannot be reproduced except in full, without prior written approval of the Company. Any unauthorized alteration, forgery or falsification of the content or appearance of this document is unlawful and offenders may be prosecuted to the fullest extent of the law.

Report Number :ER/2021/A0027
 Operation Mode :LTE B2
 Test Mode :Tx CH Mid
 EUT Pol :H Plane
 Test Frequency :1880 MHz

Test Site :SAC 1
 Test Date :2021-11-12
 Temp./Humi. :23.8/53
 Antenna Pol. :Vertical
 Engineer :GN Lin

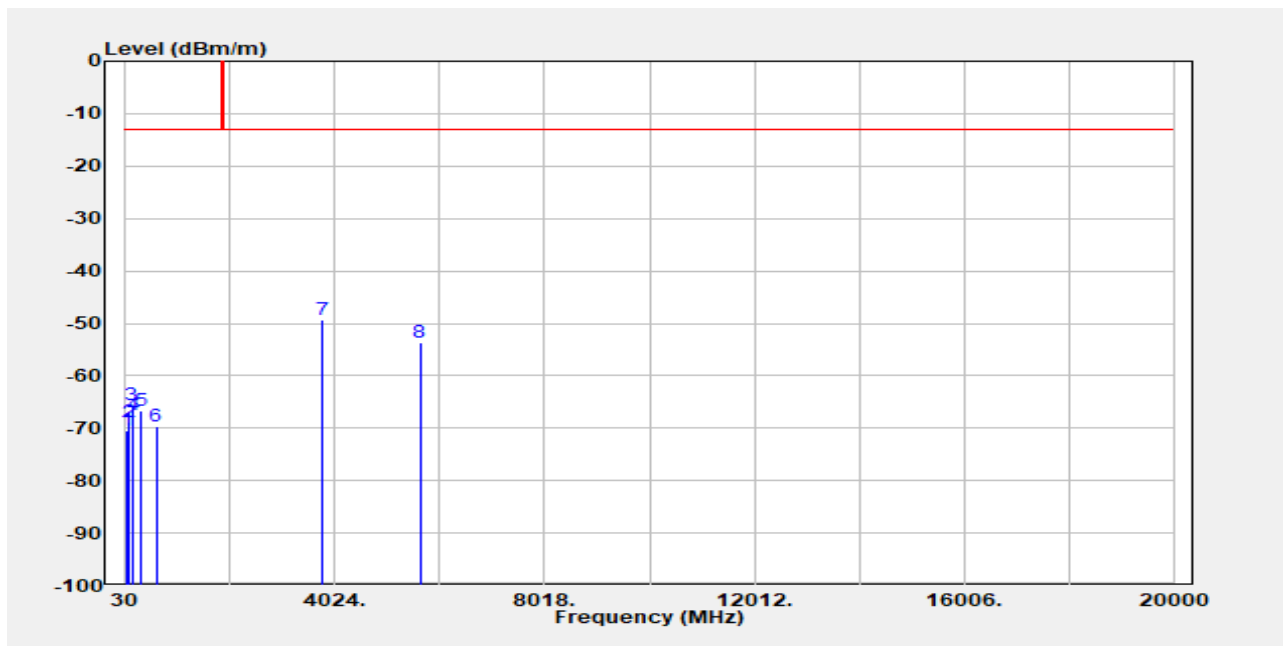

Freq. MHz	EIRP/ERP dBm	SG Output Level dBm	Antenna Gain dBi/dBd	Cable Loss dB	Limit dBm	Margin dB
60.72	-70.57	-60.44	-9.38	-0.74	-13.00	-57.57
101.13	-68.82	-66.92	-0.88	-1.02	-13.00	-55.82
149.63	-65.47	-62.70	-1.62	-1.15	-13.00	-52.47
164.18	-67.59	-65.45	-0.88	-1.26	-13.00	-54.59
335.55	-66.80	-69.18	4.28	-1.90	-13.00	-53.80
610.38	-69.77	-70.76	3.48	-2.50	-13.00	-56.77
3760.00	-49.41	-54.17	12.40	-7.63	-13.00	-36.41
5640.00	-53.55	-57.32	13.00	-9.23	-13.00	-40.55

Unless otherwise stated the results shown in this test report refer only to the sample(s) tested and such sample(s) are retained for 90 days only.

除非另有說明，此報告結果僅對測試之樣品負責，同時此樣品僅保留90天。本報告未經本公司書面許可，不可部份複製。

This document is issued by the Company subject to its General Conditions of Service printed overleaf, available on request or accessible at <http://www.sgs.com.tw/Terms-and-Conditions> and for electronic format documents, subject to Terms and Conditions for Electronic Documents at <http://www.sgs.com.tw/Terms-and-Conditions>. Attention is drawn to the limitation of liability, indemnification and jurisdiction issues defined therein. Any holder of this document is advised that information contained hereon reflects the Company's findings at the time of its intervention only and within the limits of Client's instructions, if any. The Company's sole responsibility is to its Client and this document does not exonerate parties to a transaction from exercising all their rights and obligations under the transaction documents. This document cannot be reproduced except in full, without prior written approval of the Company. Any unauthorized alteration, forgery or falsification of the content or appearance of this document is unlawful and offenders may be prosecuted to the fullest extent of the law.

Report Number :ER/2021/A0027
 Operation Mode :LTE B2
 Test Mode :Tx CH Mid
 EUT Pol :H Plane
 Test Frequency :1880 MHz

Test Site :SAC 1
 Test Date :2021-11-12
 Temp./Humi. :23.8/53
 Antenna Pol. :Horizontal
 Engineer :GN Lin

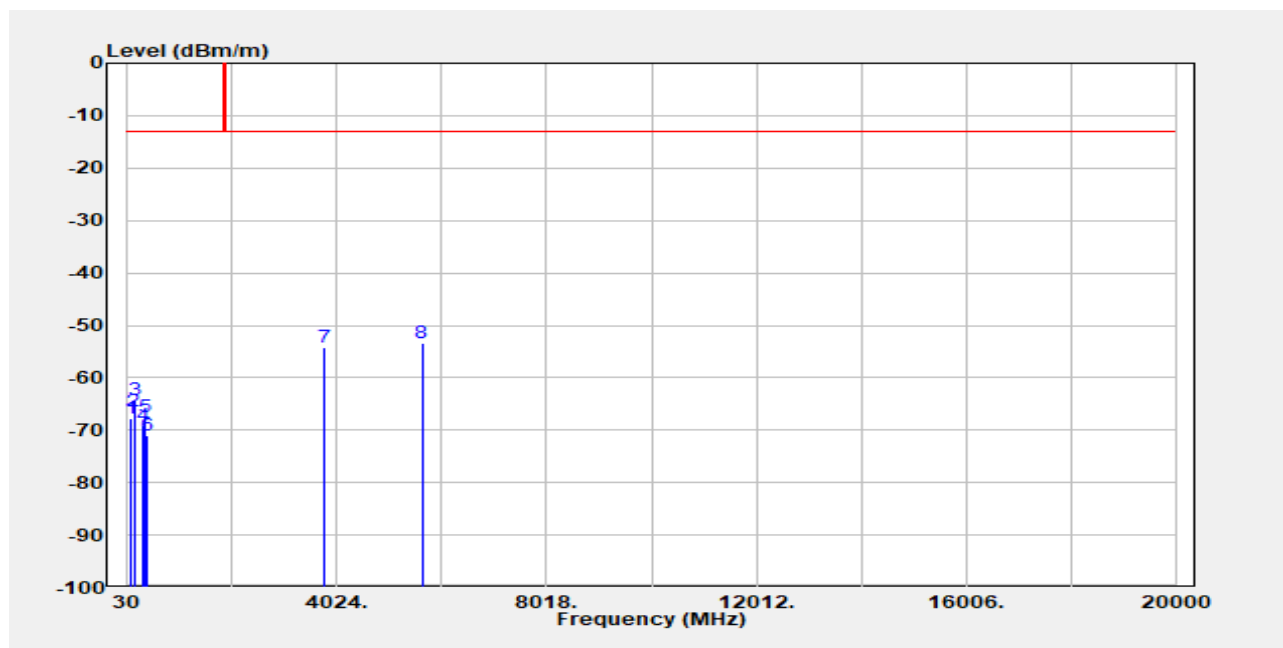

Freq. MHz	EIRP/ERP dBm	SG Output Level dBm	Antenna Gain dBi/dBd	Cable Loss dB	Limit dBm	Margin dB
89.82	-67.81	-66.40	-0.43	-0.98	-13.00	-54.81
149.63	-66.33	-63.56	-1.62	-1.15	-13.00	-53.33
164.18	-64.28	-62.15	-0.88	-1.26	-13.00	-51.28
335.55	-68.98	-71.36	4.28	-1.90	-13.00	-55.98
348.48	-67.52	-70.03	4.52	-2.01	-13.00	-54.52
388.90	-71.04	-73.40	4.40	-2.04	-13.00	-58.04
3760.00	-54.08	-58.84	12.40	-7.63	-13.00	-41.08
5640.00	-53.36	-57.13	13.00	-9.23	-13.00	-40.36

Unless otherwise stated the results shown in this test report refer only to the sample(s) tested and such sample(s) are retained for 90 days only.

除非另有說明，此報告結果僅對測試之樣品負責，同時此樣品僅保留90天。本報告未經本公司書面許可，不可部份複製。

This document is issued by the Company subject to its General Conditions of Service printed overleaf, available on request or accessible at <http://www.sgs.com.tw/Terms-and-Conditions> and for electronic format documents, subject to Terms and Conditions for Electronic Documents at <http://www.sgs.com.tw/Terms-and-Conditions>. Attention is drawn to the limitation of liability, indemnification and jurisdiction issues defined therein. Any holder of this document is advised that information contained hereon reflects the Company's findings at the time of its intervention only and within the limits of Client's instructions, if any. The Company's sole responsibility is to its Client and this document does not exonerate parties to a transaction from exercising all their rights and obligations under the transaction documents. This document cannot be reproduced except in full, without prior written approval of the Company. Any unauthorized alteration, forgery or falsification of the content or appearance of this document is unlawful and offenders may be prosecuted to the fullest extent of the law.

Report Number :ER/2021/A0027
 Operation Mode :LTE B2
 Test Mode :Tx CH High
 EUT Pol :H Plane
 Test Frequency :1905 MHz

Test Site :SAC 1
 Test Date :2021-11-12
 Temp./Humi. :23.8/53
 Antenna Pol. :Vertical
 Engineer :GN Lin

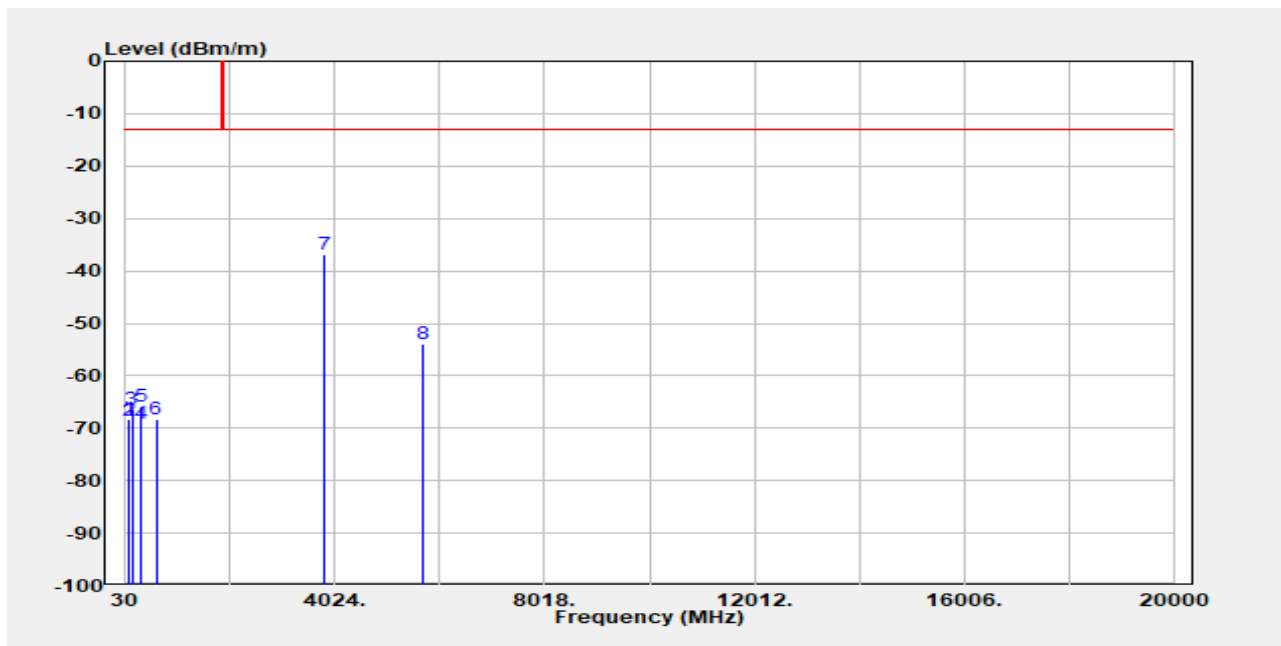

Freq. MHz	EIRP/ERP dBm	SG Output Level dBm	Antenna Gain dBi/dBd	Cable Loss dB	Limit dBm	Margin dB
89.82	-68.25	-66.84	-0.43	-0.98	-13.00	-55.25
107.60	-68.45	-65.98	-1.42	-1.04	-13.00	-55.45
149.63	-66.37	-63.60	-1.62	-1.15	-13.00	-53.37
321.00	-69.17	-71.69	4.19	-1.68	-13.00	-56.17
335.55	-65.97	-68.36	4.28	-1.90	-13.00	-52.97
610.38	-68.25	-69.23	3.48	-2.50	-13.00	-55.25
3810.00	-36.80	-41.50	12.38	-7.67	-13.00	-23.80
5715.00	-53.87	-57.61	12.80	-9.07	-13.00	-40.87

Unless otherwise stated the results shown in this test report refer only to the sample(s) tested and such sample(s) are retained for 90 days only.

除非另有說明，此報告結果僅對測試之樣品負責，同時此樣品僅保留90天。本報告未經本公司書面許可，不可部份複製。

This document is issued by the Company subject to its General Conditions of Service printed overleaf, available on request or accessible at <http://www.sgs.com.tw/Terms-and-Conditions> and for electronic format documents, subject to Terms and Conditions for Electronic Documents at <http://www.sgs.com.tw/Terms-and-Conditions>. Attention is drawn to the limitation of liability, indemnification and jurisdiction issues defined therein. Any holder of this document is advised that information contained hereon reflects the Company's findings at the time of its intervention only and within the limits of Client's instructions, if any. The Company's sole responsibility is to its Client and this document does not exonerate parties to a transaction from exercising all their rights and obligations under the transaction documents. This document cannot be reproduced except in full, without prior written approval of the Company. Any unauthorized alteration, forgery or falsification of the content or appearance of this document is unlawful and offenders may be prosecuted to the fullest extent of the law.

Report Number :ER/2021/A0027
 Operation Mode :LTE B2
 Test Mode :Tx CH High
 EUT Pol :H Plane
 Test Frequency :1905 MHz

Test Site :SAC 1
 Test Date :2021-11-12
 Temp./Humi. :23.8/53
 Antenna Pol. :Horizontal
 Engineer :GN Lin

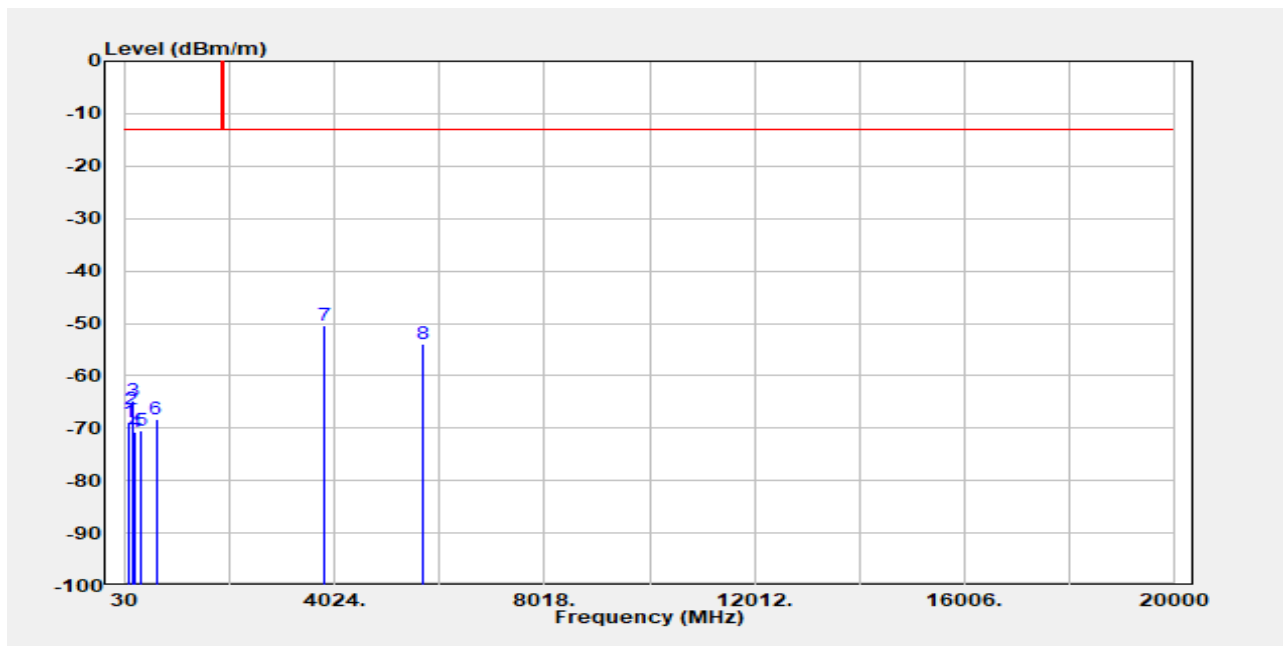

Freq. MHz	EIRP/ERP dBm	SG Output Level dBm	Antenna Gain dBi/dBd	Cable Loss dB	Limit dBm	Margin dB
89.82	-68.81	-67.40	-0.43	-0.98	-13.00	-55.81
149.63	-66.42	-63.65	-1.62	-1.15	-13.00	-53.42
164.18	-64.81	-62.67	-0.88	-1.26	-13.00	-51.81
215.92	-70.85	-74.32	4.95	-1.47	-13.00	-57.85
335.55	-70.58	-72.97	4.28	-1.90	-13.00	-57.58
610.38	-68.22	-69.21	3.48	-2.50	-13.00	-55.22
3810.00	-50.48	-55.19	12.38	-7.67	-13.00	-37.48
5715.00	-53.80	-57.53	12.80	-9.07	-13.00	-40.80

Unless otherwise stated the results shown in this test report refer only to the sample(s) tested and such sample(s) are retained for 90 days only.

除非另有說明，此報告結果僅對測試之樣品負責，同時此樣品僅保留90天。本報告未經本公司書面許可，不可部份複製。

This document is issued by the Company subject to its General Conditions of Service printed overleaf, available on request or accessible at <http://www.sgs.com.tw/Terms-and-Conditions> and for electronic format documents, subject to Terms and Conditions for Electronic Documents at <http://www.sgs.com.tw/Terms-and-Conditions>. Attention is drawn to the limitation of liability, indemnification and jurisdiction issues defined therein. Any holder of this document is advised that information contained hereon reflects the Company's findings at the time of its intervention only and within the limits of Client's instructions, if any. The Company's sole responsibility is to its Client and this document does not exonerate parties to a transaction from exercising all their rights and obligations under the transaction documents. This document cannot be reproduced except in full, without prior written approval of the Company. Any unauthorized alteration, forgery or falsification of the content or appearance of this document is unlawful and offenders may be prosecuted to the fullest extent of the law.

Report Number :ER/2021/A0027
 Operation Mode :LTE B4
 Test Mode :Tx CH Low
 EUT Pol :H Plane
 Test Frequency :1717.5 MHz

Test Site :SAC 1
 Test Date :2021-11-12
 Temp./Humi. :23.8/53
 Antenna Pol. :Vertical
 Engineer :GN Lin

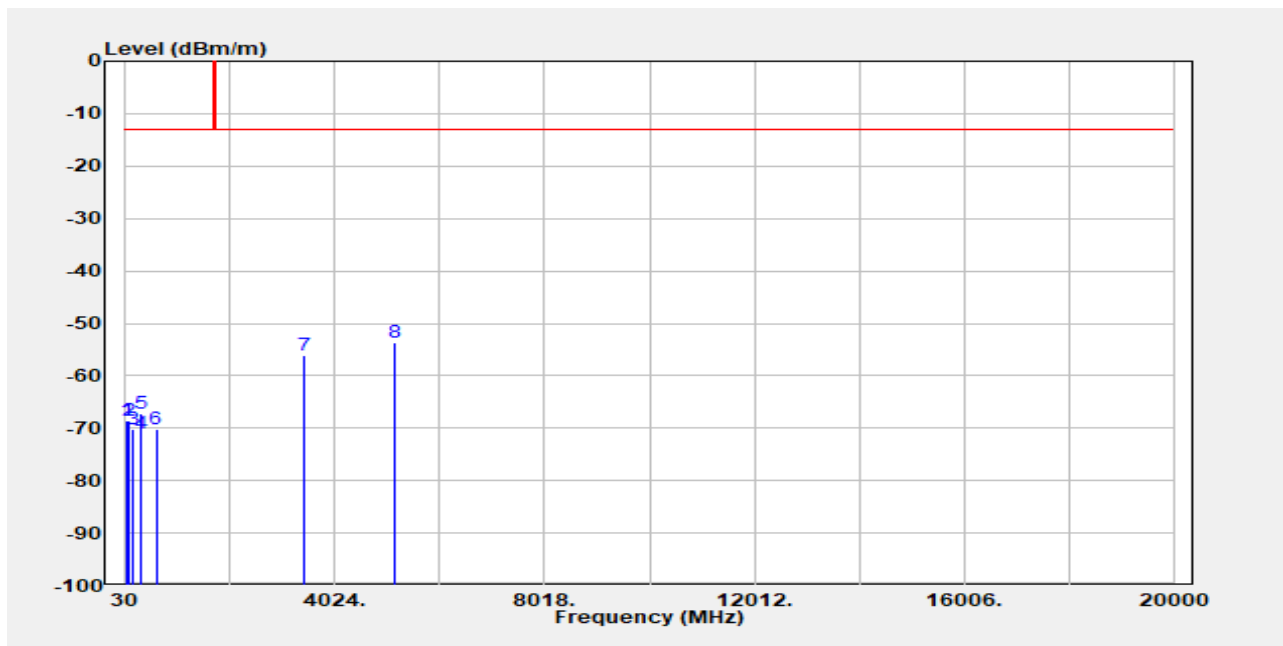

Freq. MHz	EIRP/ERP dBm	SG Output Level dBm	Antenna Gain dBi/dBd	Cable Loss dB	Limit dBm	Margin dB
62.33	-68.50	-58.91	-8.83	-0.76	-13.00	-55.50
89.82	-68.60	-67.19	-0.43	-0.98	-13.00	-55.60
164.18	-70.13	-68.00	-0.88	-1.26	-13.00	-57.13
311.30	-70.98	-73.43	4.19	-1.74	-13.00	-57.98
335.55	-67.08	-69.47	4.28	-1.90	-13.00	-54.08
610.38	-70.18	-71.16	3.48	-2.50	-13.00	-57.18
3435.00	-56.18	-62.80	12.53	-5.91	-13.00	-43.18
5152.50	-53.64	-57.82	12.12	-7.94	-13.00	-40.64

Unless otherwise stated the results shown in this test report refer only to the sample(s) tested and such sample(s) are retained for 90 days only.

除非另有說明，此報告結果僅對測試之樣品負責，同時此樣品僅保留90天。本報告未經本公司書面許可，不可部份複製。

This document is issued by the Company subject to its General Conditions of Service printed overleaf, available on request or accessible at <http://www.sgs.com.tw/Terms-and-Conditions> and for electronic format documents, subject to Terms and Conditions for Electronic Documents at <http://www.sgs.com.tw/Terms-and-Conditions>. Attention is drawn to the limitation of liability, indemnification and jurisdiction issues defined therein. Any holder of this document is advised that information contained hereon reflects the Company's findings at the time of its intervention only and within the limits of Client's instructions, if any. The Company's sole responsibility is to its Client and this document does not exonerate parties to a transaction from exercising all their rights and obligations under the transaction documents. This document cannot be reproduced except in full, without prior written approval of the Company. Any unauthorized alteration, forgery or falsification of the content or appearance of this document is unlawful and offenders may be prosecuted to the fullest extent of the law.

Report Number :ER/2021/A0027
 Operation Mode :LTE B4
 Test Mode :Tx CH Low
 EUT Pol :H Plane
 Test Frequency :1717.5 MHz

Test Site :SAC 1
 Test Date :2021-11-12
 Temp./Humi. :23.8/53
 Antenna Pol. :Horizontal
 Engineer :GN Lin

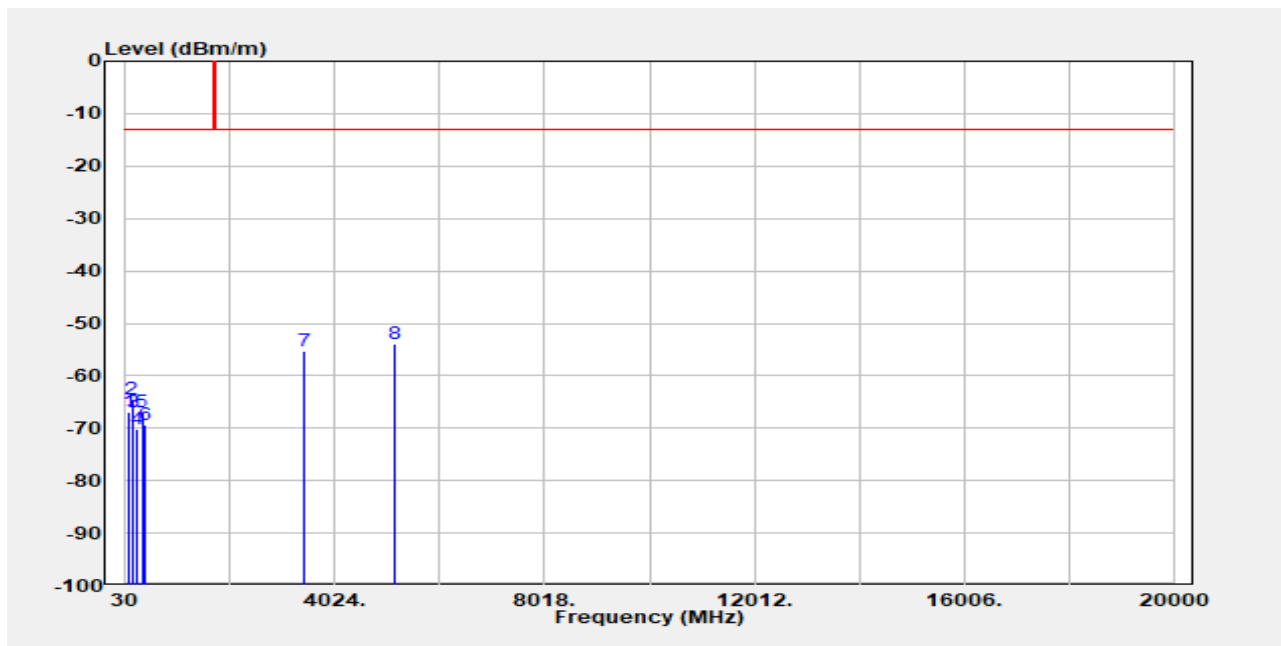

Freq. MHz	EIRP/ERP dBm	SG Output Level dBm	Antenna Gain dBi/dBd	Cable Loss dB	Limit dBm	Margin dB
89.82	-66.92	-65.51	-0.43	-0.98	-13.00	-53.92
149.63	-64.59	-61.82	-1.62	-1.15	-13.00	-51.59
181.97	-66.82	-67.31	1.87	-1.39	-13.00	-53.82
240.17	-70.15	-72.92	4.38	-1.61	-13.00	-57.15
342.02	-66.93	-69.37	4.36	-1.92	-13.00	-53.93
388.90	-69.44	-71.80	4.40	-2.04	-13.00	-56.44
3435.00	-55.37	-61.98	12.53	-5.91	-13.00	-42.37
5152.50	-53.83	-58.01	12.12	-7.94	-13.00	-40.83

Unless otherwise stated the results shown in this test report refer only to the sample(s) tested and such sample(s) are retained for 90 days only.

除非另有說明，此報告結果僅對測試之樣品負責，同時此樣品僅保留90天。本報告未經本公司書面許可，不可部份複製。

This document is issued by the Company subject to its General Conditions of Service printed overleaf, available on request or accessible at <http://www.sgs.com.tw/Terms-and-Conditions> and for electronic format documents, subject to Terms and Conditions for Electronic Documents at <http://www.sgs.com.tw/Terms-and-Conditions>. Attention is drawn to the limitation of liability, indemnification and jurisdiction issues defined therein. Any holder of this document is advised that information contained hereon reflects the Company's findings at the time of its intervention only and within the limits of Client's instructions, if any. The Company's sole responsibility is to its Client and this document does not exonerate parties to a transaction from exercising all their rights and obligations under the transaction documents. This document cannot be reproduced except in full, without prior written approval of the Company. Any unauthorized alteration, forgery or falsification of the content or appearance of this document is unlawful and offenders may be prosecuted to the fullest extent of the law.

Report Number :ER/2021/A0027
 Operation Mode :LTE B4
 Test Mode :Tx CH Mid
 EUT Pol :H Plane
 Test Frequency :1732.5 MHz

Test Site :SAC 1
 Test Date :2021-11-12
 Temp./Humi. :23.8/53
 Antenna Pol. :Vertical
 Engineer :GN Lin

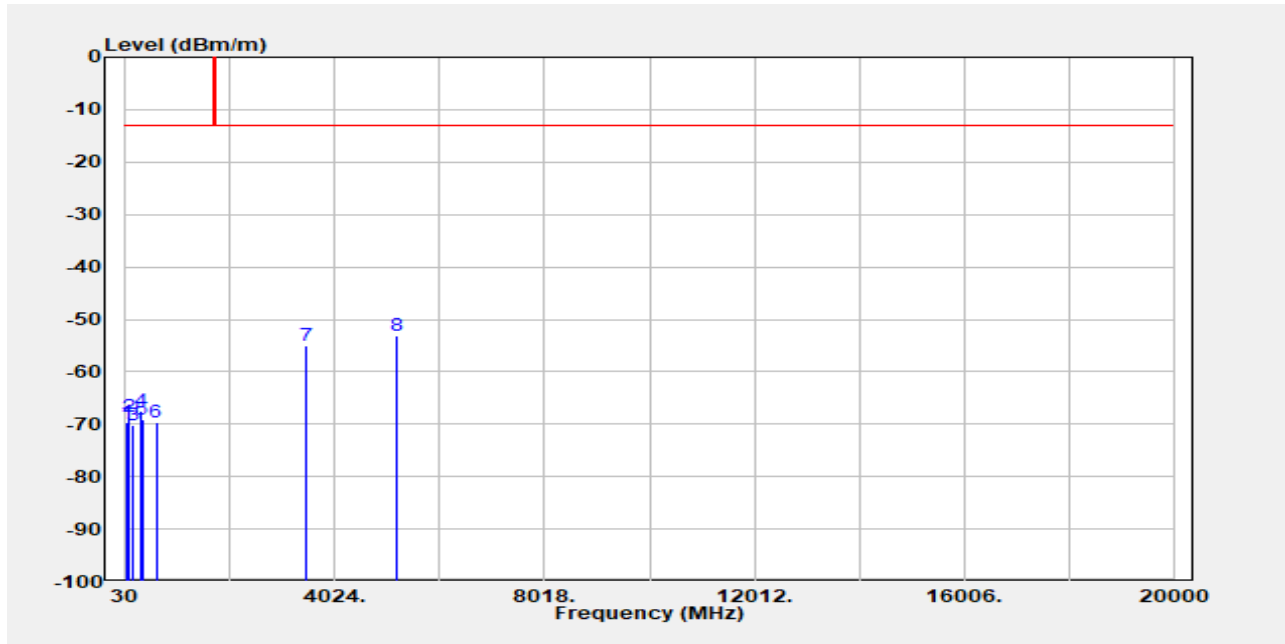

Freq. MHz	EIRP/ERP dBm	SG Output Level dBm	Antenna Gain dBi/dBd	Cable Loss dB	Limit dBm	Margin dB
60.72	-69.67	-59.55	-9.38	-0.74	-13.00	-56.67
89.82	-68.65	-67.24	-0.43	-0.98	-13.00	-55.65
164.18	-70.21	-68.08	-0.88	-1.26	-13.00	-57.21
335.55	-67.48	-69.87	4.28	-1.90	-13.00	-54.48
342.02	-69.18	-71.63	4.36	-1.92	-13.00	-56.18
610.38	-69.52	-70.51	3.48	-2.50	-13.00	-56.52
3465.00	-54.96	-61.32	12.47	-6.10	-13.00	-41.95
5197.50	-53.10	-57.61	12.39	-7.88	-13.00	-40.09

Unless otherwise stated the results shown in this test report refer only to the sample(s) tested and such sample(s) are retained for 90 days only.

除非另有說明，此報告結果僅對測試之樣品負責，同時此樣品僅保留90天。本報告未經本公司書面許可，不可部份複製。

This document is issued by the Company subject to its General Conditions of Service printed overleaf, available on request or accessible at <http://www.sgs.com.tw/Terms-and-Conditions> and for electronic format documents, subject to Terms and Conditions for Electronic Documents at <http://www.sgs.com.tw/Terms-and-Conditions>. Attention is drawn to the limitation of liability, indemnification and jurisdiction issues defined therein. Any holder of this document is advised that information contained hereon reflects the Company's findings at the time of its intervention only and within the limits of Client's instructions, if any. The Company's sole responsibility is to its Client and this document does not exonerate parties to a transaction from exercising all their rights and obligations under the transaction documents. This document cannot be reproduced except in full, without prior written approval of the Company. Any unauthorized alteration, forgery or falsification of the content or appearance of this document is unlawful and offenders may be prosecuted to the fullest extent of the law.

Report Number :ER/2021/A0027
 Operation Mode :LTE B4
 Test Mode :Tx CH Mid
 EUT Pol :H Plane
 Test Frequency :1732.5 MHz

Test Site :SAC 1
 Test Date :2021-11-12
 Temp./Humi. :23.8/53
 Antenna Pol. :Horizontal
 Engineer :GN Lin

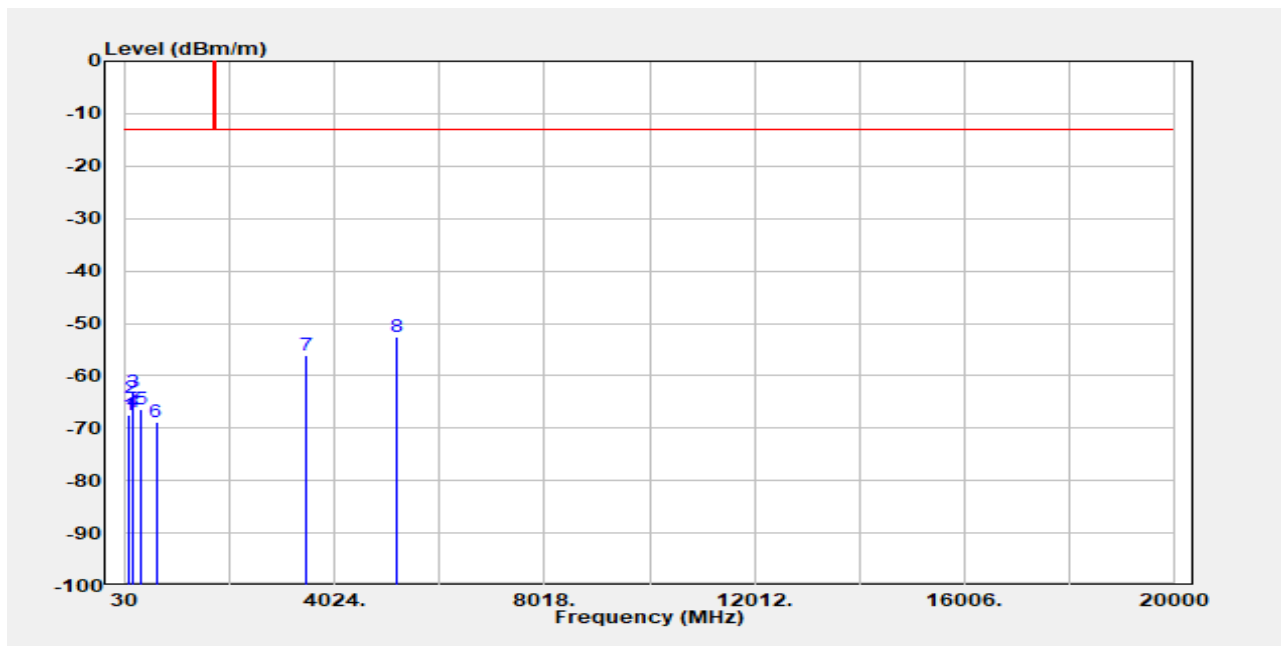

Freq. MHz	EIRP/ERP dBm	SG Output Level dBm	Antenna Gain dBi/dBd	Cable Loss dB	Limit dBm	Margin dB
89.82	-67.38	-65.97	-0.43	-0.98	-13.00	-54.38
149.63	-64.14	-61.37	-1.62	-1.15	-13.00	-51.14
164.18	-63.10	-60.96	-0.88	-1.26	-13.00	-50.10
185.20	-66.81	-67.77	2.37	-1.41	-13.00	-53.81
332.32	-66.44	-68.80	4.26	-1.91	-13.00	-53.44
610.38	-68.90	-69.89	3.48	-2.50	-13.00	-55.90
3465.00	-56.09	-62.46	12.47	-6.10	-13.00	-43.08
5197.50	-52.56	-57.07	12.39	-7.88	-13.00	-39.55

Unless otherwise stated the results shown in this test report refer only to the sample(s) tested and such sample(s) are retained for 90 days only.

除非另有說明，此報告結果僅對測試之樣品負責，同時此樣品僅保留90天。本報告未經本公司書面許可，不可部份複製。

This document is issued by the Company subject to its General Conditions of Service printed overleaf, available on request or accessible at <http://www.sgs.com.tw/Terms-and-Conditions> and for electronic format documents, subject to Terms and Conditions for Electronic Documents at <http://www.sgs.com.tw/Terms-and-Conditions>. Attention is drawn to the limitation of liability, indemnification and jurisdiction issues defined therein. Any holder of this document is advised that information contained hereon reflects the Company's findings at the time of its intervention only and within the limits of Client's instructions, if any. The Company's sole responsibility is to its Client and this document does not exonerate parties to a transaction from exercising all their rights and obligations under the transaction documents. This document cannot be reproduced except in full, without prior written approval of the Company. Any unauthorized alteration, forgery or falsification of the content or appearance of this document is unlawful and offenders may be prosecuted to the fullest extent of the law.

Report Number :ER/2021/A0027
 Operation Mode :LTE B4
 Test Mode :Tx CH High
 EUT Pol :H Plane
 Test Frequency :1747.5 MHz

Test Site :SAC 1
 Test Date :2021-11-12
 Temp./Humi. :23.8/53
 Antenna Pol. :Vertical
 Engineer :GN Lin

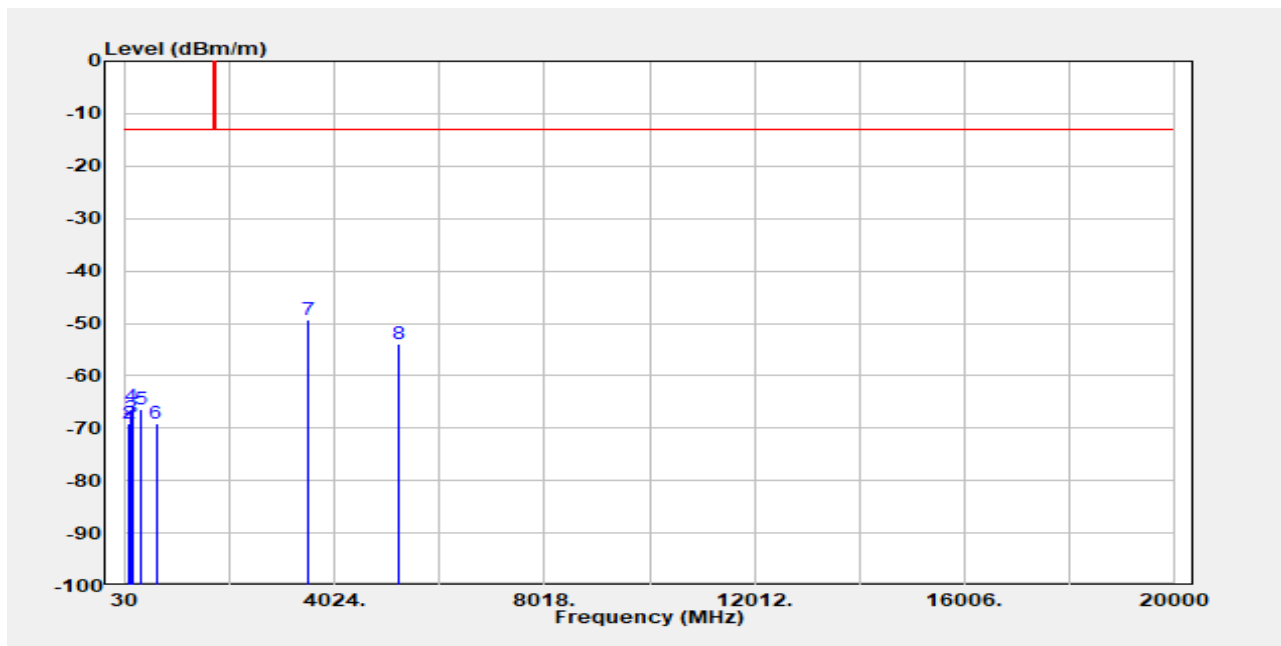

Freq. MHz	EIRP/ERP dBm	SG Output Level dBm	Antenna Gain dBi/dBd	Cable Loss dB	Limit dBm	Margin dB
89.82	-69.95	-68.54	-0.43	-0.98	-13.00	-56.95
107.60	-69.08	-66.61	-1.42	-1.04	-13.00	-56.08
138.32	-68.15	-64.82	-2.03	-1.30	-13.00	-55.15
149.63	-65.89	-63.13	-1.62	-1.15	-13.00	-52.89
335.55	-66.31	-68.70	4.28	-1.90	-13.00	-53.31
610.38	-69.14	-70.13	3.48	-2.50	-13.00	-56.14
3495.00	-49.35	-55.47	12.41	-6.29	-13.00	-36.34
5242.50	-53.83	-58.56	12.74	-8.01	-13.00	-40.82

Unless otherwise stated the results shown in this test report refer only to the sample(s) tested and such sample(s) are retained for 90 days only.

除非另有說明，此報告結果僅對測試之樣品負責，同時此樣品僅保留90天。本報告未經本公司書面許可，不可部份複製。

This document is issued by the Company subject to its General Conditions of Service printed overleaf, available on request or accessible at <http://www.sgs.com.tw/Terms-and-Conditions> and for electronic format documents, subject to Terms and Conditions for Electronic Documents at <http://www.sgs.com.tw/Terms-and-Conditions>. Attention is drawn to the limitation of liability, indemnification and jurisdiction issues defined therein. Any holder of this document is advised that information contained hereon reflects the Company's findings at the time of its intervention only and within the limits of Client's instructions, if any. The Company's sole responsibility is to its Client and this document does not exonerate parties to a transaction from exercising all their rights and obligations under the transaction documents. This document cannot be reproduced except in full, without prior written approval of the Company. Any unauthorized alteration, forgery or falsification of the content or appearance of this document is unlawful and offenders may be prosecuted to the fullest extent of the law.

Report Number :ER/2021/A0027
 Operation Mode :LTE B4
 Test Mode :Tx CH High
 EUT Pol :H Plane
 Test Frequency :1747.5 MHz

Test Site :SAC 1
 Test Date :2021-11-12
 Temp./Humi. :23.8/53
 Antenna Pol. :Horizontal
 Engineer :GN Lin

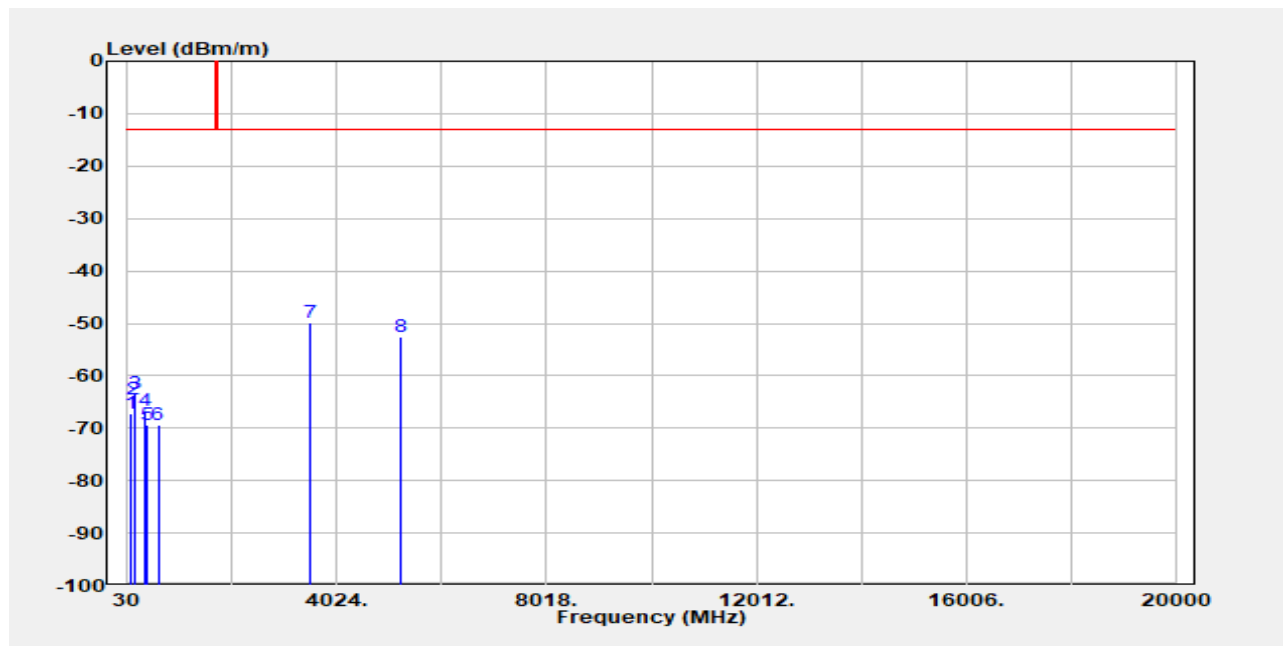

Freq. MHz	EIRP/ERP dBm	SG Output Level dBm	Antenna Gain dBi/dBd	Cable Loss dB	Limit dBm	Margin dB
89.82	-67.25	-65.84	-0.43	-0.98	-13.00	-54.25
149.63	-64.50	-61.73	-1.62	-1.15	-13.00	-51.50
164.18	-63.43	-61.30	-0.88	-1.26	-13.00	-50.43
345.25	-66.59	-69.06	4.44	-1.97	-13.00	-53.59
388.90	-69.26	-71.62	4.40	-2.04	-13.00	-56.26
610.38	-69.50	-70.49	3.48	-2.50	-13.00	-56.50
3495.00	-49.79	-55.91	12.41	-6.29	-13.00	-36.78
5242.50	-52.63	-57.36	12.74	-8.01	-13.00	-39.62

Unless otherwise stated the results shown in this test report refer only to the sample(s) tested and such sample(s) are retained for 90 days only.

除非另有說明，此報告結果僅對測試之樣品負責，同時此樣品僅保留90天。本報告未經本公司書面許可，不可部份複製。

This document is issued by the Company subject to its General Conditions of Service printed overleaf, available on request or accessible at <http://www.sgs.com.tw/Terms-and-Conditions> and for electronic format documents, subject to Terms and Conditions for Electronic Documents at <http://www.sgs.com.tw/Terms-and-Conditions>. Attention is drawn to the limitation of liability, indemnification and jurisdiction issues defined therein. Any holder of this document is advised that information contained hereon reflects the Company's findings at the time of its intervention only and within the limits of Client's instructions, if any. The Company's sole responsibility is to its Client and this document does not exonerate parties to a transaction from exercising all their rights and obligations under the transaction documents. This document cannot be reproduced except in full, without prior written approval of the Company. Any unauthorized alteration, forgery or falsification of the content or appearance of this document is unlawful and offenders may be prosecuted to the fullest extent of the law.

Report Number :ER/2021/A0027
 Operation Mode :LTE B5
 Test Mode :Tx CH Low
 EUT Pol :H Plane
 Test Frequency :826.5 MHz

Test Site :SAC 1
 Test Date :2021-11-12
 Temp./Humi. :23.8/53
 Antenna Pol. :Vertical
 Engineer :GN Lin

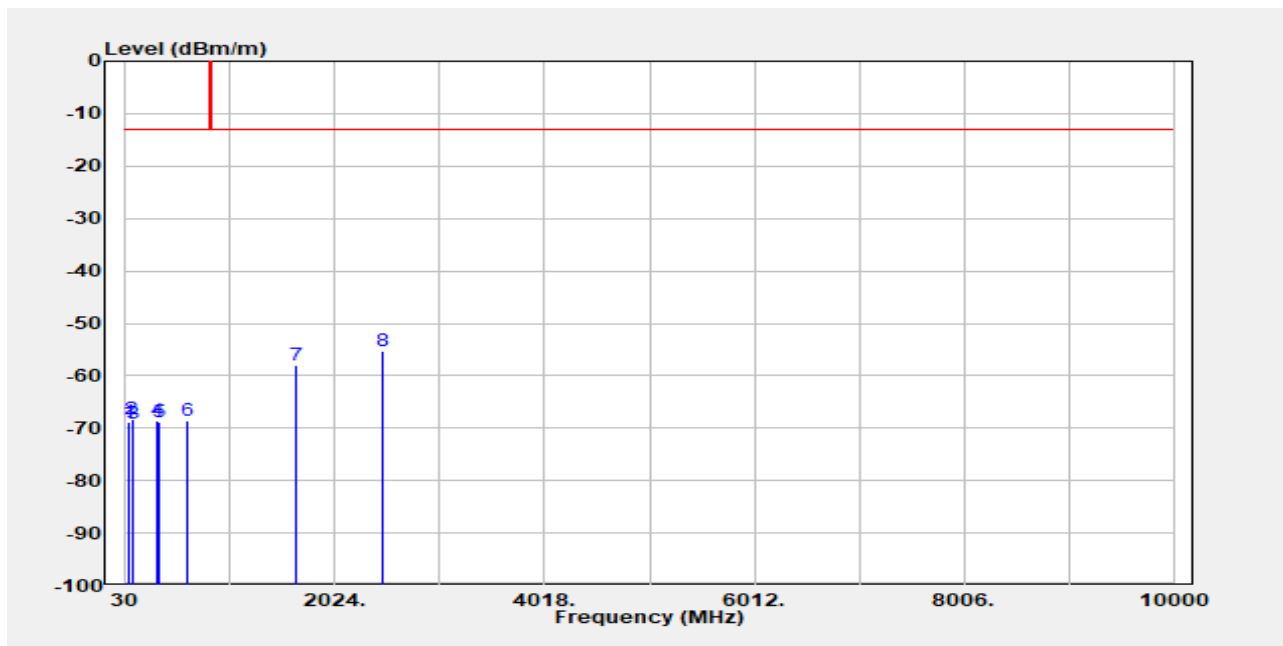

Freq. MHz	EIRP/ERP dBm	SG Output Level dBm	Antenna Gain dBi/dBd	Cable Loss dB	Limit dBm	Margin dB
60.72	-68.86	-58.73	-9.38	-0.74	-13.00	-55.86
89.82	-68.20	-66.79	-0.43	-0.98	-13.00	-55.20
107.60	-69.05	-66.58	-1.42	-1.04	-13.00	-56.05
335.55	-68.61	-71.00	4.28	-1.90	-13.00	-55.61
348.48	-68.79	-71.30	4.52	-2.01	-13.00	-55.79
610.38	-68.64	-69.62	3.48	-2.50	-13.00	-55.64
1653.00	-58.03	-63.28	9.51	-4.26	-13.00	-45.03
2479.50	-55.16	-60.55	10.56	-5.17	-13.00	-42.16

Unless otherwise stated the results shown in this test report refer only to the sample(s) tested and such sample(s) are retained for 90 days only.

除非另有說明，此報告結果僅對測試之樣品負責，同時此樣品僅保留90天。本報告未經本公司書面許可，不可部份複製。

This document is issued by the Company subject to its General Conditions of Service printed overleaf, available on request or accessible at <http://www.sgs.com.tw/Terms-and-Conditions> and for electronic format documents, subject to Terms and Conditions for Electronic Documents at <http://www.sgs.com.tw/Terms-and-Conditions>. Attention is drawn to the limitation of liability, indemnification and jurisdiction issues defined therein. Any holder of this document is advised that information contained hereon reflects the Company's findings at the time of its intervention only and within the limits of Client's instructions, if any. The Company's sole responsibility is to its Client and this document does not exonerate parties to a transaction from exercising all their rights and obligations under the transaction documents. This document cannot be reproduced except in full, without prior written approval of the Company. Any unauthorized alteration, forgery or falsification of the content or appearance of this document is unlawful and offenders may be prosecuted to the fullest extent of the law.

Report Number :ER/2021/A0027
 Operation Mode :LTE B5
 Test Mode :Tx CH Low
 EUT Pol :H Plane
 Test Frequency :826.5 MHz

Test Site :SAC 1
 Test Date :2021-11-12
 Temp./Humi. :23.8/53
 Antenna Pol. :Horizontal
 Engineer :GN Lin

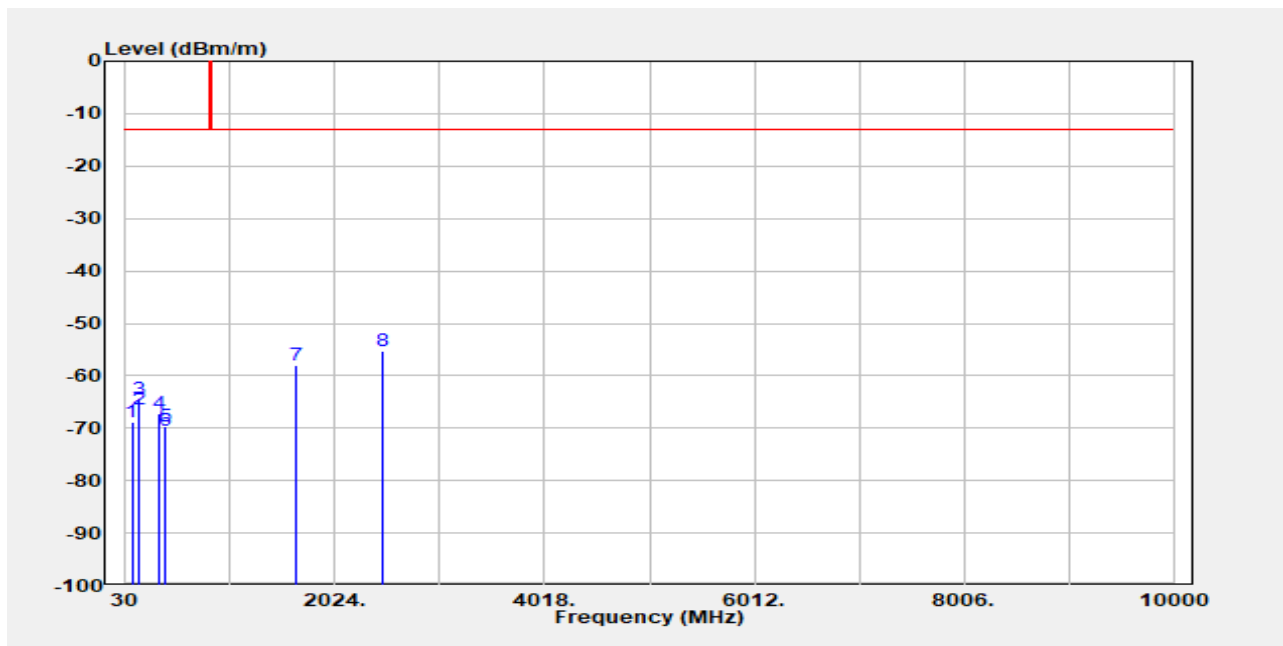

Freq. MHz	EIRP/ERP dBm	SG Output Level dBm	Antenna Gain dBi/dBd	Cable Loss dB	Limit dBm	Margin dB
89.82	-68.81	-67.40	-0.43	-0.98	-13.00	-55.81
149.63	-66.32	-63.55	-1.62	-1.15	-13.00	-53.32
164.18	-64.39	-62.26	-0.88	-1.26	-13.00	-51.39
342.02	-67.29	-69.73	4.36	-1.92	-13.00	-54.29
401.83	-69.75	-72.00	4.32	-2.08	-13.00	-56.75
413.15	-70.43	-72.95	4.38	-1.86	-13.00	-57.43
1653.00	-57.89	-63.14	9.51	-4.26	-13.00	-44.89
2479.50	-55.38	-60.77	10.56	-5.17	-13.00	-42.38

Unless otherwise stated the results shown in this test report refer only to the sample(s) tested and such sample(s) are retained for 90 days only.

除非另有說明，此報告結果僅對測試之樣品負責，同時此樣品僅保留90天。本報告未經本公司書面許可，不可部份複製。

This document is issued by the Company subject to its General Conditions of Service printed overleaf, available on request or accessible at <http://www.sgs.com.tw/Terms-and-Conditions> and for electronic format documents, subject to Terms and Conditions for Electronic Documents at <http://www.sgs.com.tw/Terms-and-Conditions>. Attention is drawn to the limitation of liability, indemnification and jurisdiction issues defined therein. Any holder of this document is advised that information contained hereon reflects the Company's findings at the time of its intervention only and within the limits of Client's instructions, if any. The Company's sole responsibility is to its Client and this document does not exonerate parties to a transaction from exercising all their rights and obligations under the transaction documents. This document cannot be reproduced except in full, without prior written approval of the Company. Any unauthorized alteration, forgery or falsification of the content or appearance of this document is unlawful and offenders may be prosecuted to the fullest extent of the law.

Report Number :ER/2021/A0027
 Operation Mode :LTE B5
 Test Mode :Tx CH Mid
 EUT Pol :H Plane
 Test Frequency :836.5 MHz

Test Site :SAC 1
 Test Date :2021-11-12
 Temp./Humi. :23.8/53
 Antenna Pol. :Vertical
 Engineer :GN Lin

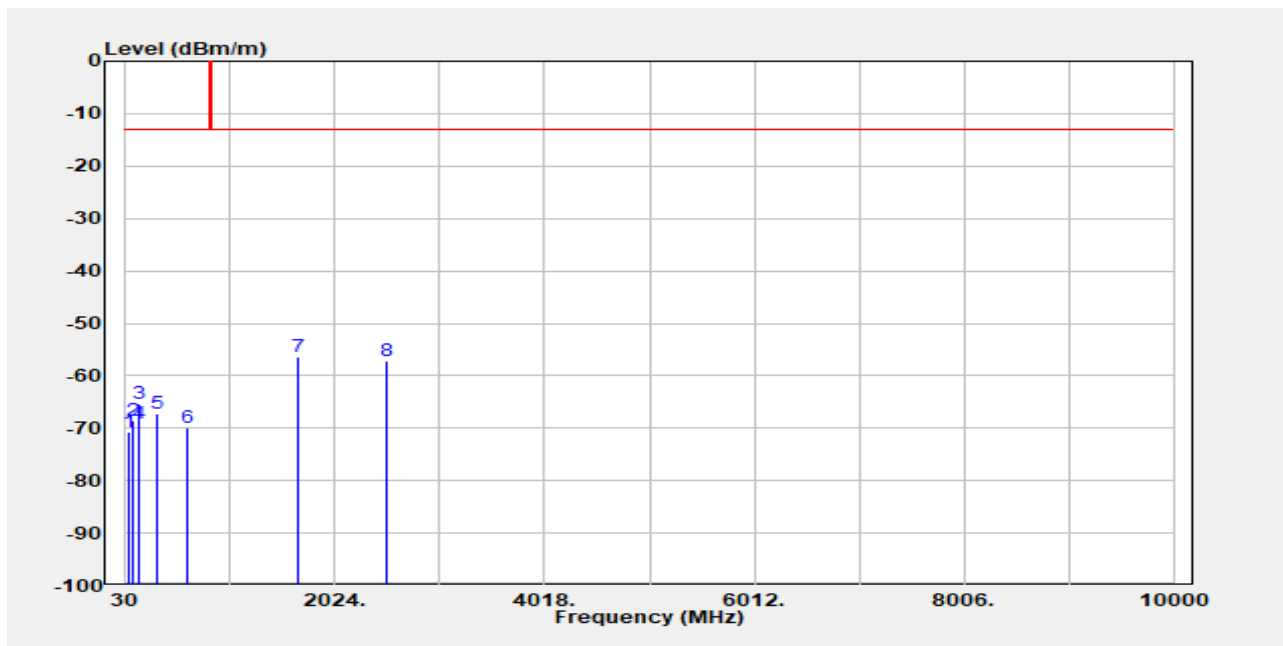

Freq. MHz	EIRP/ERP dBm	SG Output Level dBm	Antenna Gain dBi/dBd	Cable Loss dB	Limit dBm	Margin dB
62.33	-70.67	-61.08	-8.83	-0.76	-13.00	-57.67
107.60	-68.56	-66.09	-1.42	-1.04	-13.00	-55.56
149.63	-65.38	-62.61	-1.62	-1.15	-13.00	-52.38
164.18	-69.01	-66.88	-0.88	-1.26	-13.00	-56.01
335.55	-67.08	-69.46	4.28	-1.90	-13.00	-54.08
610.38	-69.97	-70.95	3.48	-2.50	-13.00	-56.97
1673.00	-56.47	-61.73	9.55	-4.29	-13.00	-43.47
2509.50	-57.12	-62.54	10.62	-5.20	-13.00	-44.12

Unless otherwise stated the results shown in this test report refer only to the sample(s) tested and such sample(s) are retained for 90 days only.

除非另有說明，此報告結果僅對測試之樣品負責，同時此樣品僅保留90天。本報告未經本公司書面許可，不可部份複製。

This document is issued by the Company subject to its General Conditions of Service printed overleaf, available on request or accessible at <http://www.sgs.com.tw/Terms-and-Conditions> and for electronic format documents, subject to Terms and Conditions for Electronic Documents at <http://www.sgs.com.tw/Terms-and-Conditions>. Attention is drawn to the limitation of liability, indemnification and jurisdiction issues defined therein. Any holder of this document is advised that information contained hereon reflects the Company's findings at the time of its intervention only and within the limits of Client's instructions, if any. The Company's sole responsibility is to its Client and this document does not exonerate parties to a transaction from exercising all their rights and obligations under the transaction documents. This document cannot be reproduced except in full, without prior written approval of the Company. Any unauthorized alteration, forgery or falsification of the content or appearance of this document is unlawful and offenders may be prosecuted to the fullest extent of the law.

Report Number :ER/2021/A0027
 Operation Mode :LTE B5
 Test Mode :Tx CH Mid
 EUT Pol :H Plane
 Test Frequency :836.5 MHz

Test Site :SAC 1
 Test Date :2021-11-12
 Temp./Humi. :23.8/53
 Antenna Pol. :Horizontal
 Engineer :GN Lin

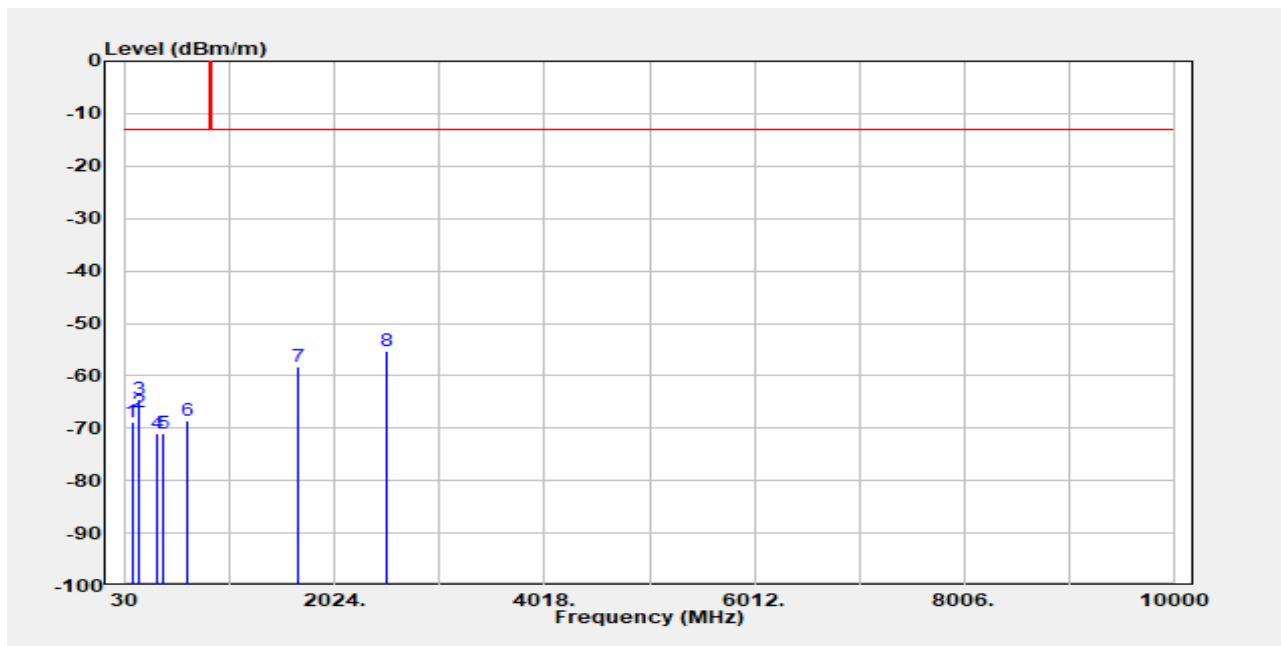

Freq. MHz	EIRP/ERP dBm	SG Output Level dBm	Antenna Gain dBi/dBd	Cable Loss dB	Limit dBm	Margin dB
89.82	-68.97	-67.56	-0.43	-0.98	-13.00	-55.97
149.63	-66.94	-64.17	-1.62	-1.15	-13.00	-53.94
164.18	-64.42	-62.29	-0.88	-1.26	-13.00	-51.42
335.55	-70.91	-73.29	4.28	-1.90	-13.00	-57.91
388.90	-70.88	-73.24	4.40	-2.04	-13.00	-57.88
610.38	-68.52	-69.51	3.48	-2.50	-13.00	-55.52
1673.00	-58.24	-63.50	9.55	-4.29	-13.00	-45.24
2509.50	-55.18	-60.60	10.62	-5.20	-13.00	-42.18

Unless otherwise stated the results shown in this test report refer only to the sample(s) tested and such sample(s) are retained for 90 days only.

除非另有說明，此報告結果僅對測試之樣品負責，同時此樣品僅保留90天。本報告未經本公司書面許可，不可部份複製。

This document is issued by the Company subject to its General Conditions of Service printed overleaf, available on request or accessible at <http://www.sgs.com.tw/Terms-and-Conditions> and for electronic format documents, subject to Terms and Conditions for Electronic Documents at <http://www.sgs.com.tw/Terms-and-Conditions>. Attention is drawn to the limitation of liability, indemnification and jurisdiction issues defined therein. Any holder of this document is advised that information contained hereon reflects the Company's findings at the time of its intervention only and within the limits of Client's instructions, if any. The Company's sole responsibility is to its Client and this document does not exonerate parties to a transaction from exercising all their rights and obligations under the transaction documents. This document cannot be reproduced except in full, without prior written approval of the Company. Any unauthorized alteration, forgery or falsification of the content or appearance of this document is unlawful and offenders may be prosecuted to the fullest extent of the law.

Report Number :ER/2021/A0027
 Operation Mode :LTE B5
 Test Mode :Tx CH High
 EUT Pol :H Plane
 Test Frequency :846.5 MHz

Test Site :SAC 1
 Test Date :2021-11-12
 Temp./Humi. :23.8/53
 Antenna Pol. :Vertical
 Engineer :GN Lin

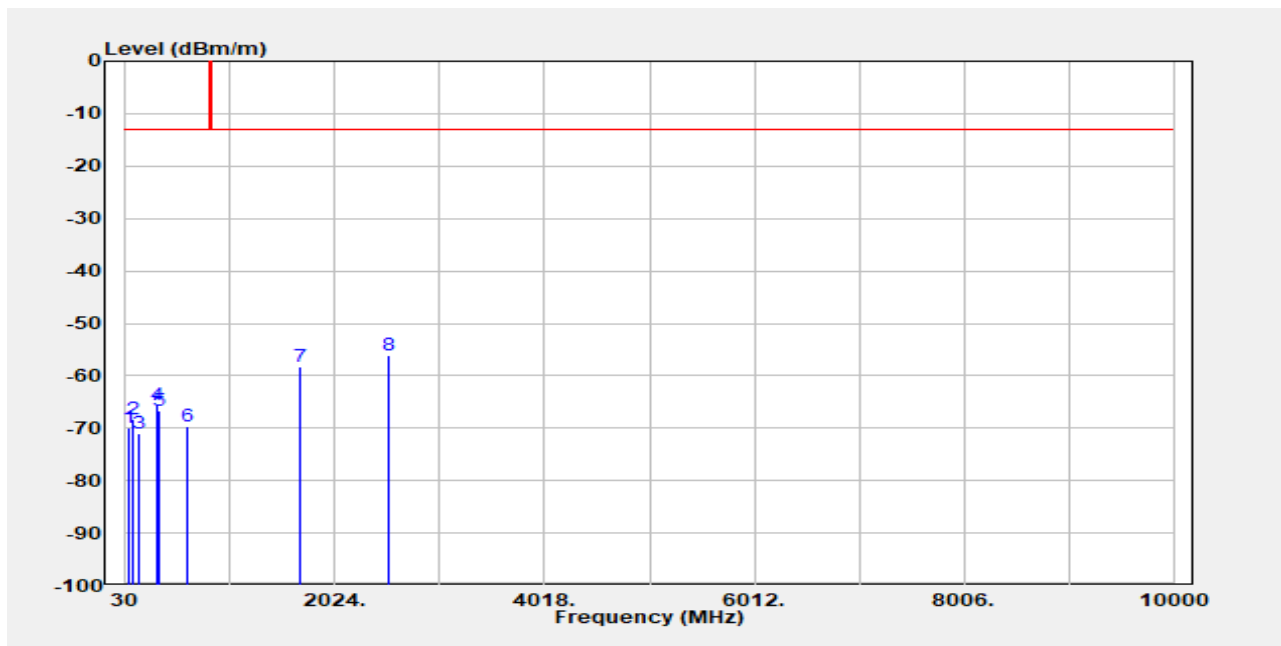

Freq. MHz	EIRP/ERP dBm	SG Output Level dBm	Antenna Gain dBi/dBd	Cable Loss dB	Limit dBm	Margin dB
62.33	-69.91	-60.32	-8.83	-0.76	-13.00	-56.91
101.13	-68.41	-66.52	-0.88	-1.02	-13.00	-55.41
162.57	-70.99	-68.74	-1.00	-1.25	-13.00	-57.99
335.55	-65.60	-67.99	4.28	-1.90	-13.00	-52.60
348.48	-66.75	-69.26	4.52	-2.01	-13.00	-53.75
610.38	-69.73	-70.72	3.48	-2.50	-13.00	-56.73
1693.00	-58.35	-63.62	9.59	-4.32	-13.00	-45.35
2539.50	-56.09	-61.54	10.68	-5.23	-13.00	-43.09

Unless otherwise stated the results shown in this test report refer only to the sample(s) tested and such sample(s) are retained for 90 days only.

除非另有說明，此報告結果僅對測試之樣品負責，同時此樣品僅保留90天。本報告未經本公司書面許可，不可部份複製。

This document is issued by the Company subject to its General Conditions of Service printed overleaf, available on request or accessible at <http://www.sgs.com.tw/Terms-and-Conditions> and for electronic format documents, subject to Terms and Conditions for Electronic Documents at <http://www.sgs.com.tw/Terms-and-Conditions>. Attention is drawn to the limitation of liability, indemnification and jurisdiction issues defined therein. Any holder of this document is advised that information contained hereon reflects the Company's findings at the time of its intervention only and within the limits of Client's instructions, if any. The Company's sole responsibility is to its Client and this document does not exonerate parties to a transaction from exercising all their rights and obligations under the transaction documents. This document cannot be reproduced except in full, without prior written approval of the Company. Any unauthorized alteration, forgery or falsification of the content or appearance of this document is unlawful and offenders may be prosecuted to the fullest extent of the law.

Report Number :ER/2021/A0027
 Operation Mode :LTE B5
 Test Mode :Tx CH High
 EUT Pol :H Plane
 Test Frequency :846.5 MHz

Test Site :SAC 1
 Test Date :2021-11-12
 Temp./Humi. :23.8/53
 Antenna Pol. :Horizontal
 Engineer :GN Lin

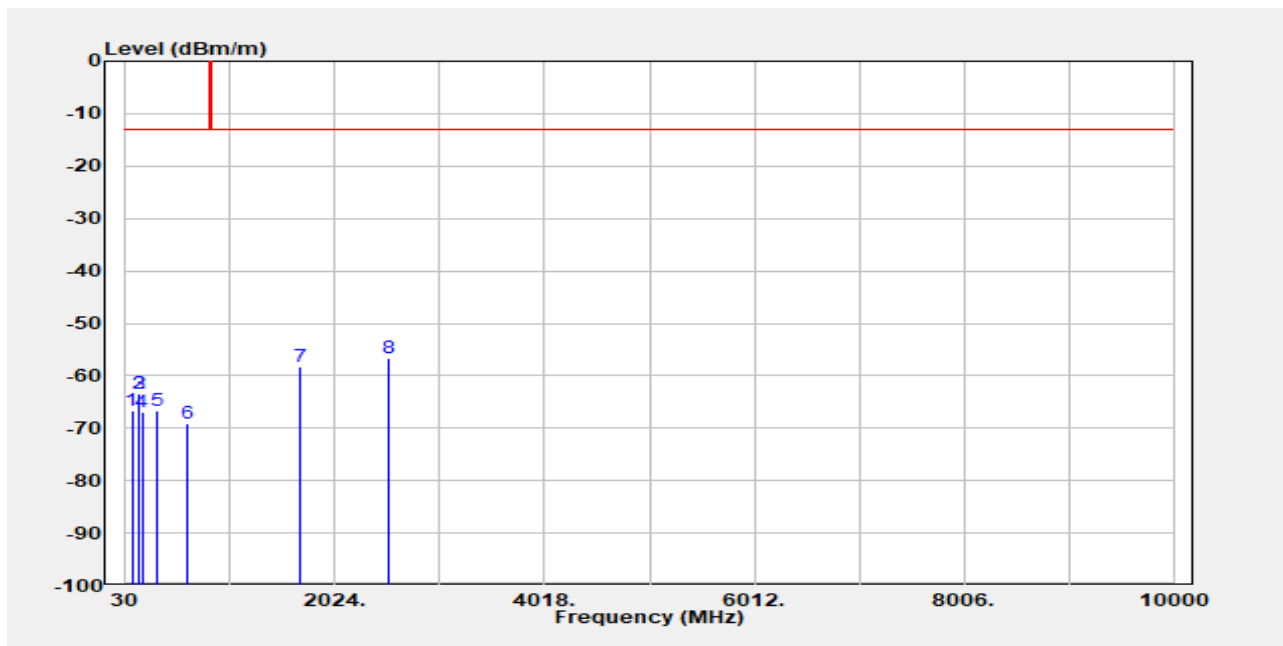

Freq. MHz	EIRP/ERP dBm	SG Output Level dBm	Antenna Gain dBi/dBd	Cable Loss dB	Limit dBm	Margin dB
89.82	-66.59	-65.18	-0.43	-0.98	-13.00	-53.59
149.63	-63.34	-60.58	-1.62	-1.15	-13.00	-50.34
164.18	-63.32	-61.19	-0.88	-1.26	-13.00	-50.32
185.20	-66.96	-67.93	2.37	-1.41	-13.00	-53.96
335.55	-66.79	-69.17	4.28	-1.90	-13.00	-53.79
610.38	-68.98	-69.97	3.48	-2.50	-13.00	-55.98
1693.00	-58.24	-63.51	9.59	-4.32	-13.00	-45.24
2539.50	-56.68	-62.13	10.68	-5.23	-13.00	-43.68

Unless otherwise stated the results shown in this test report refer only to the sample(s) tested and such sample(s) are retained for 90 days only.

除非另有說明，此報告結果僅對測試之樣品負責，同時此樣品僅保留90天。本報告未經本公司書面許可，不可部份複製。

This document is issued by the Company subject to its General Conditions of Service printed overleaf, available on request or accessible at <http://www.sgs.com.tw/Terms-and-Conditions> and for electronic format documents, subject to Terms and Conditions for Electronic Documents at <http://www.sgs.com.tw/Terms-and-Conditions>. Attention is drawn to the limitation of liability, indemnification and jurisdiction issues defined therein. Any holder of this document is advised that information contained hereon reflects the Company's findings at the time of its intervention only and within the limits of Client's instructions, if any. The Company's sole responsibility is to its Client and this document does not exonerate parties to a transaction from exercising all their rights and obligations under the transaction documents. This document cannot be reproduced except in full, without prior written approval of the Company. Any unauthorized alteration, forgery or falsification of the content or appearance of this document is unlawful and offenders may be prosecuted to the fullest extent of the law.

Report Number :ER/2021/A0027
 Operation Mode :LTE B7
 Test Mode :Tx CH Low
 EUT Pol :H Plane
 Test Frequency :2507.5 MHz

Test Site :SAC 1
 Test Date :2021-11-12
 Temp./Humi. :23.8/53
 Antenna Pol. :Vertical
 Engineer :GN Lin

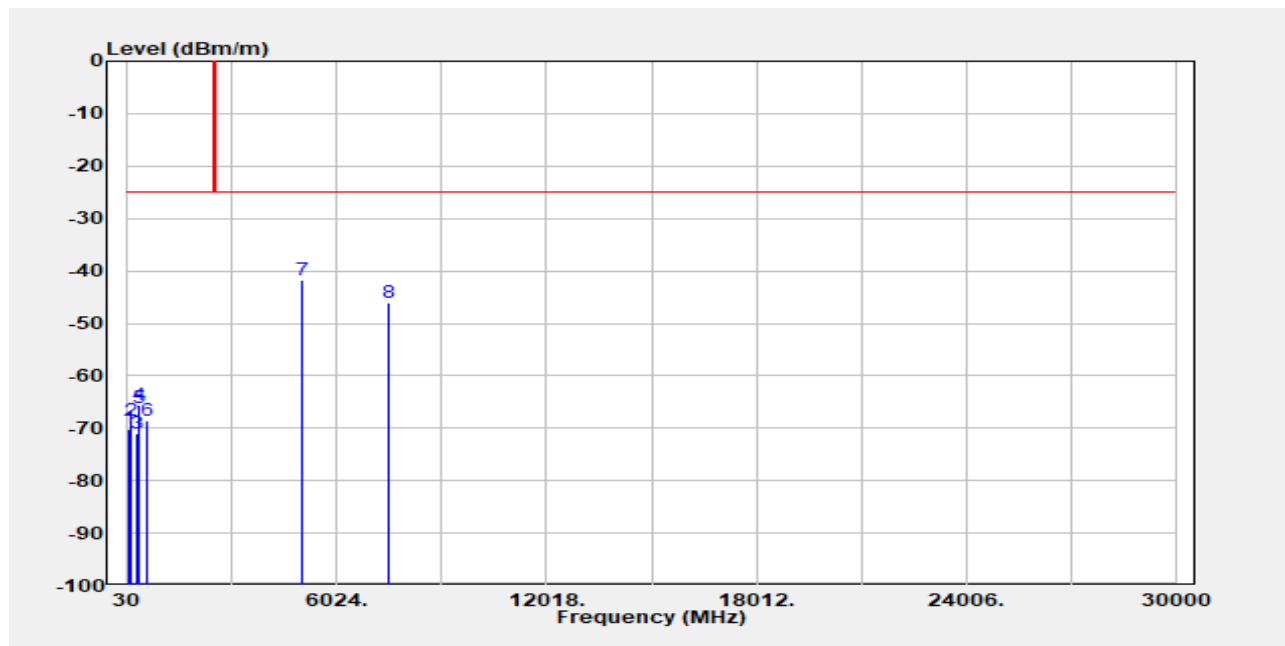

Freq. MHz	EIRP/ERP dBm	SG Output Level dBm	Antenna Gain dBi/dBd	Cable Loss dB	Limit dBm	Margin dB
62.33	-70.12	-60.53	-8.83	-0.76	-25.00	-45.12
107.60	-68.54	-66.07	-1.42	-1.04	-25.00	-43.54
311.30	-70.96	-73.41	4.19	-1.74	-25.00	-45.96
335.55	-65.63	-68.02	4.28	-1.90	-25.00	-40.63
348.48	-66.23	-68.75	4.52	-2.01	-25.00	-41.23
610.38	-68.60	-69.58	3.48	-2.50	-25.00	-43.60
5015.00	-41.74	13.06	12.38	-7.50	-25.00	-16.74
7522.50	-46.08	-47.85	11.05	-9.27	-25.00	-21.08

Unless otherwise stated the results shown in this test report refer only to the sample(s) tested and such sample(s) are retained for 90 days only.

除非另有說明，此報告結果僅對測試之樣品負責，同時此樣品僅保留90天。本報告未經本公司書面許可，不可部份複製。

This document is issued by the Company subject to its General Conditions of Service printed overleaf, available on request or accessible at <http://www.sgs.com.tw/Terms-and-Conditions> and for electronic format documents, subject to Terms and Conditions for Electronic Documents at <http://www.sgs.com.tw/Terms-and-Conditions>. Attention is drawn to the limitation of liability, indemnification and jurisdiction issues defined therein. Any holder of this document is advised that information contained hereon reflects the Company's findings at the time of its intervention only and within the limits of Client's instructions, if any. The Company's sole responsibility is to its Client and this document does not exonerate parties to a transaction from exercising all their rights and obligations under the transaction documents. This document cannot be reproduced except in full, without prior written approval of the Company. Any unauthorized alteration, forgery or falsification of the content or appearance of this document is unlawful and offenders may be prosecuted to the fullest extent of the law.

Report Number :ER/2021/A0027
 Operation Mode :LTE B7
 Test Mode :Tx CH Low
 EUT Pol :H Plane
 Test Frequency :2507.5 MHz

Test Site :SAC 1
 Test Date :2021-11-12
 Temp./Humi. :23.8/53
 Antenna Pol. :Horizontal
 Engineer :GN Lin

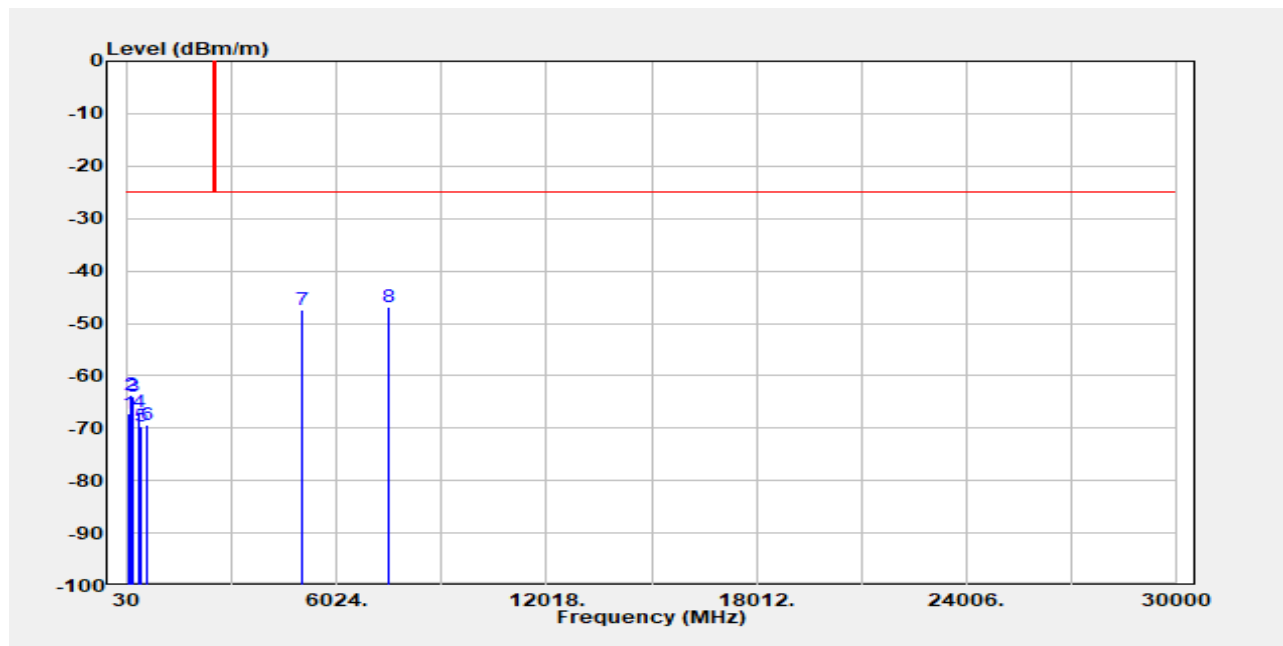

Freq. MHz	EIRP/ERP dBm	SG Output Level dBm	Antenna Gain dBi/dBd	Cable Loss dB	Limit dBm	Margin dB
89.82	-67.14	-65.73	-0.43	-0.98	-25.00	-42.14
149.63	-63.71	-60.95	-1.62	-1.15	-25.00	-38.71
164.18	-64.00	-61.87	-0.88	-1.26	-25.00	-39.00
335.55	-66.99	-69.37	4.28	-1.90	-25.00	-41.99
388.90	-69.62	-71.98	4.40	-2.04	-25.00	-44.62
610.38	-69.29	-70.27	3.48	-2.50	-25.00	-44.29
5015.00	-47.51	13.34	12.38	-7.50	-25.00	-22.51
7522.50	-46.82	22.70	11.05	-9.27	-25.00	-21.82

Unless otherwise stated the results shown in this test report refer only to the sample(s) tested and such sample(s) are retained for 90 days only.

除非另有說明，此報告結果僅對測試之樣品負責，同時此樣品僅保留90天。本報告未經本公司書面許可，不可部份複製。

This document is issued by the Company subject to its General Conditions of Service printed overleaf, available on request or accessible at <http://www.sgs.com.tw/Terms-and-Conditions> and for electronic format documents, subject to Terms and Conditions for Electronic Documents at <http://www.sgs.com.tw/Terms-and-Conditions>. Attention is drawn to the limitation of liability, indemnification and jurisdiction issues defined therein. Any holder of this document is advised that information contained hereon reflects the Company's findings at the time of its intervention only and within the limits of Client's instructions, if any. The Company's sole responsibility is to its Client and this document does not exonerate parties to a transaction from exercising all their rights and obligations under the transaction documents. This document cannot be reproduced except in full, without prior written approval of the Company. Any unauthorized alteration, forgery or falsification of the content or appearance of this document is unlawful and offenders may be prosecuted to the fullest extent of the law.

Report Number :ER/2021/A0027
 Operation Mode :LTE B7
 Test Mode :Tx CH Mid
 EUT Pol :H Plane
 Test Frequency :2535 MHz

Test Site :SAC 1
 Test Date :2021-11-12
 Temp./Humi. :23.8/53
 Antenna Pol. :Vertical
 Engineer :GN Lin

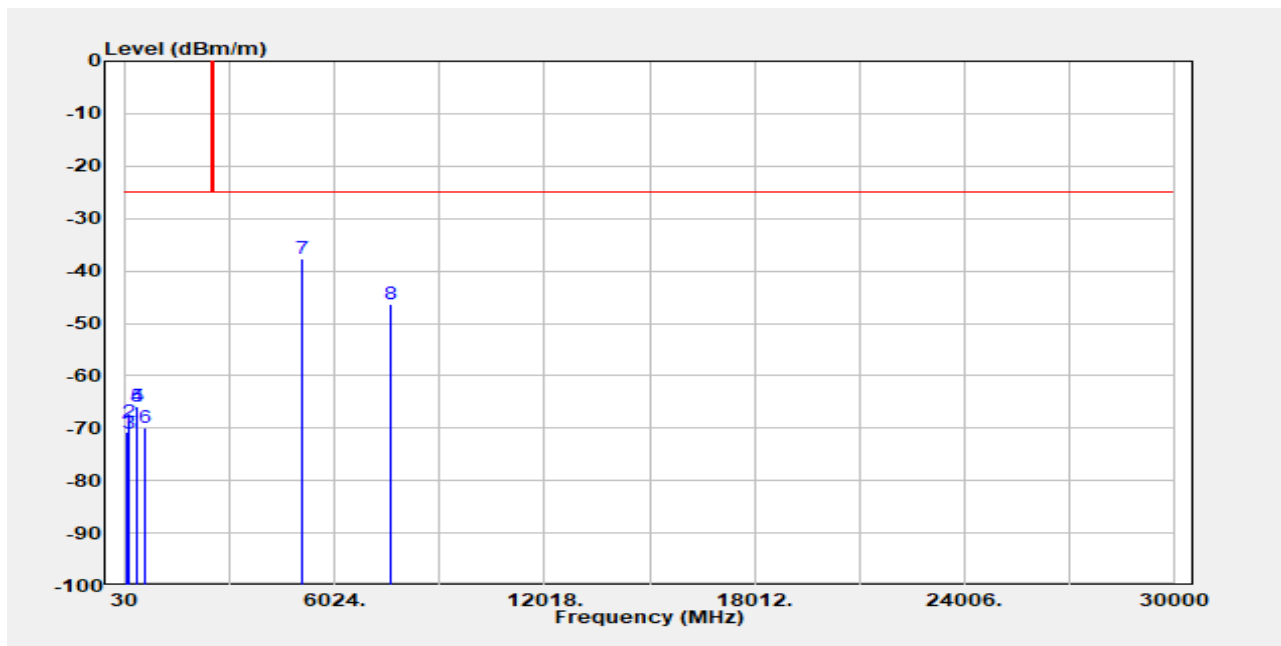

Freq. MHz	EIRP/ERP dBm	SG Output Level dBm	Antenna Gain dBi/dBd	Cable Loss dB	Limit dBm	Margin dB
60.72	-70.62	-60.49	-9.38	-0.74	-25.00	-45.62
107.60	-68.81	-66.34	-1.42	-1.04	-25.00	-43.81
149.63	-70.89	-68.12	-1.62	-1.15	-25.00	-45.89
335.55	-65.97	-68.35	4.28	-1.90	-25.00	-40.97
348.48	-65.93	-68.44	4.52	-2.01	-25.00	-40.93
610.38	-70.03	-71.02	3.48	-2.50	-25.00	-45.03
5070.00	-37.71	-41.98	12.10	-7.83	-25.00	-12.71
7605.00	-46.22	-47.82	11.21	-9.61	-25.00	-21.22

Unless otherwise stated the results shown in this test report refer only to the sample(s) tested and such sample(s) are retained for 90 days only.

除非另有說明，此報告結果僅對測試之樣品負責，同時此樣品僅保留90天。本報告未經本公司書面許可，不可部份複製。

This document is issued by the Company subject to its General Conditions of Service printed overleaf, available on request or accessible at <http://www.sgs.com.tw/Terms-and-Conditions> and for electronic format documents, subject to Terms and Conditions for Electronic Documents at <http://www.sgs.com.tw/Terms-and-Conditions>. Attention is drawn to the limitation of liability, indemnification and jurisdiction issues defined therein. Any holder of this document is advised that information contained hereon reflects the Company's findings at the time of its intervention only and within the limits of Client's instructions, if any. The Company's sole responsibility is to its Client and this document does not exonerate parties to a transaction from exercising all their rights and obligations under the transaction documents. This document cannot be reproduced except in full, without prior written approval of the Company. Any unauthorized alteration, forgery or falsification of the content or appearance of this document is unlawful and offenders may be prosecuted to the fullest extent of the law.

Report Number :ER/2021/A0027
 Operation Mode :LTE B7
 Test Mode :Tx CH Mid
 EUT Pol :H Plane
 Test Frequency :2535 MHz

Test Site :SAC 1
 Test Date :2021-11-12
 Temp./Humi. :23.8/53
 Antenna Pol. :Horizontal
 Engineer :GN Lin

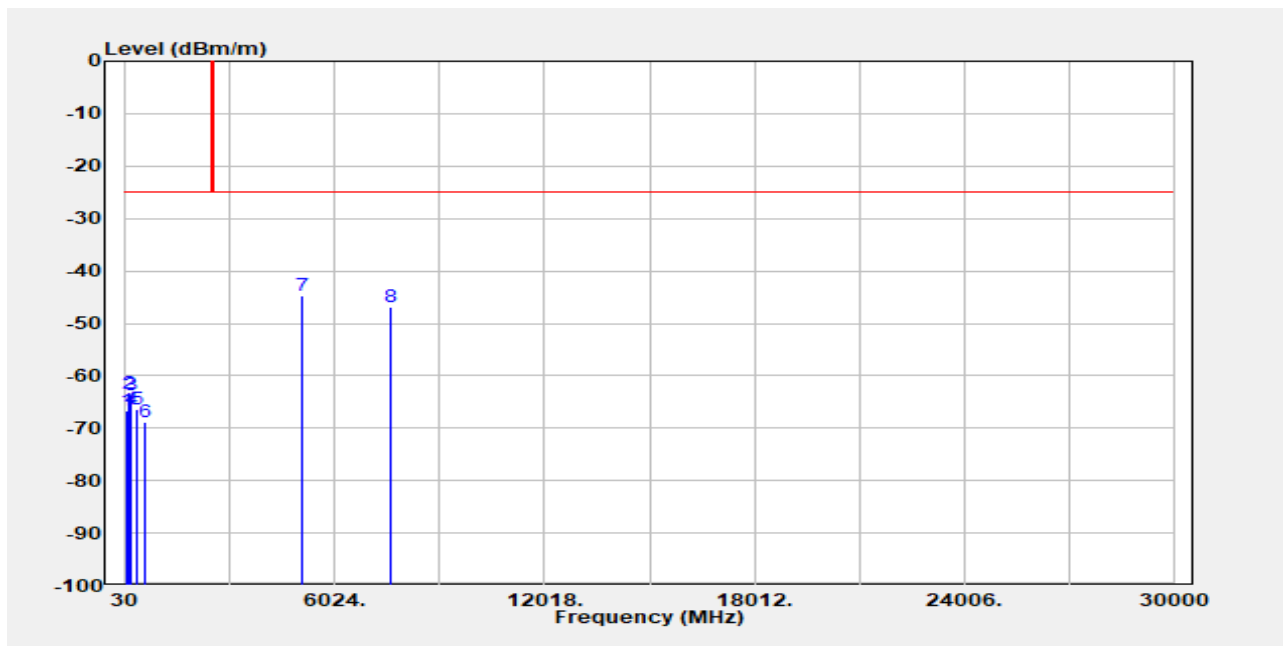

Freq. MHz	EIRP/ERP dBm	SG Output Level dBm	Antenna Gain dBi/dBd	Cable Loss dB	Limit dBm	Margin dB
89.82	-66.79	-65.38	-0.43	-0.98	-25.00	-41.79
149.63	-63.47	-60.70	-1.62	-1.15	-25.00	-38.47
164.18	-63.80	-61.67	-0.88	-1.26	-25.00	-38.80
181.97	-66.48	-66.97	1.87	-1.39	-25.00	-41.48
335.55	-66.53	-68.91	4.28	-1.90	-25.00	-41.53
610.38	-68.92	-69.91	3.48	-2.50	-25.00	-43.92
5070.00	-44.77	-49.04	12.10	-7.83	-25.00	-19.77
7605.00	-46.96	-48.56	11.21	-9.61	-25.00	-21.96

Unless otherwise stated the results shown in this test report refer only to the sample(s) tested and such sample(s) are retained for 90 days only.

除非另有說明，此報告結果僅對測試之樣品負責，同時此樣品僅保留90天。本報告未經本公司書面許可，不可部份複製。

This document is issued by the Company subject to its General Conditions of Service printed overleaf, available on request or accessible at <http://www.sgs.com.tw/Terms-and-Conditions> and for electronic format documents, subject to Terms and Conditions for Electronic Documents at <http://www.sgs.com.tw/Terms-and-Conditions>. Attention is drawn to the limitation of liability, indemnification and jurisdiction issues defined therein. Any holder of this document is advised that information contained hereon reflects the Company's findings at the time of its intervention only and within the limits of Client's instructions, if any. The Company's sole responsibility is to its Client and this document does not exonerate parties to a transaction from exercising all their rights and obligations under the transaction documents. This document cannot be reproduced except in full, without prior written approval of the Company. Any unauthorized alteration, forgery or falsification of the content or appearance of this document is unlawful and offenders may be prosecuted to the fullest extent of the law.

Report Number :ER/2021/A0027
 Operation Mode :LTE B7
 Test Mode :Tx CH High
 EUT Pol :H Plane
 Test Frequency :2562.5 MHz

Test Site :SAC 1
 Test Date :2021-11-12
 Temp./Humi. :23.8/53
 Antenna Pol. :Vertical
 Engineer :GN Lin

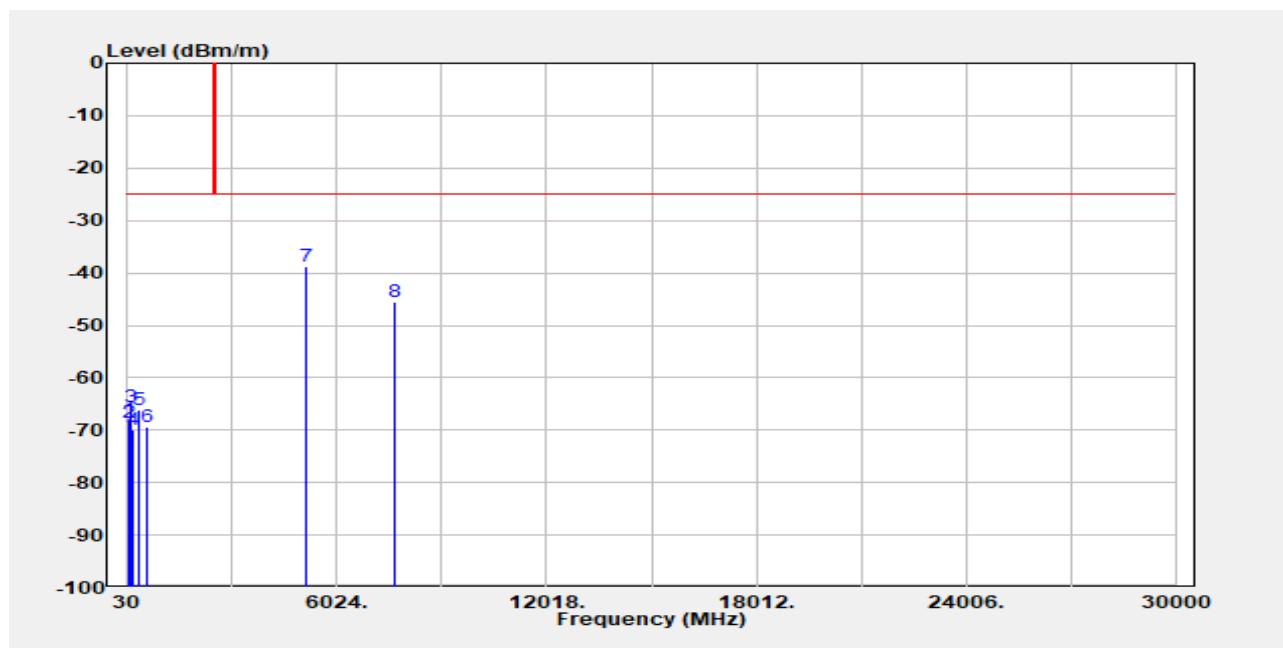

Freq. MHz	EIRP/ERP dBm	SG Output Level dBm	Antenna Gain dBi/dBd	Cable Loss dB	Limit dBm	Margin dB
60.72	-68.08	-57.96	-9.38	-0.74	-25.00	-43.08
89.82	-68.65	-67.24	-0.43	-0.98	-25.00	-43.65
149.63	-65.56	-62.80	-1.62	-1.15	-25.00	-40.56
164.18	-69.86	-67.73	-0.88	-1.26	-25.00	-44.86
335.55	-66.12	-68.51	4.28	-1.90	-25.00	-41.12
610.38	-69.26	-70.25	3.48	-2.50	-25.00	-44.26
5125.00	-38.85	-42.98	12.10	-7.97	-25.00	-13.85
7687.50	-45.65	-47.20	11.45	-9.91	-25.00	-20.65

Unless otherwise stated the results shown in this test report refer only to the sample(s) tested and such sample(s) are retained for 90 days only.

除非另有說明，此報告結果僅對測試之樣品負責，同時此樣品僅保留90天。本報告未經本公司書面許可，不可部份複製。

This document is issued by the Company subject to its General Conditions of Service printed overleaf, available on request or accessible at <http://www.sgs.com.tw/Terms-and-Conditions> and for electronic format documents, subject to Terms and Conditions for Electronic Documents at <http://www.sgs.com.tw/Terms-and-Conditions>. Attention is drawn to the limitation of liability, indemnification and jurisdiction issues defined therein. Any holder of this document is advised that information contained hereon reflects the Company's findings at the time of its intervention only and within the limits of Client's instructions, if any. The Company's sole responsibility is to its Client and this document does not exonerate parties to a transaction from exercising all their rights and obligations under the transaction documents. This document cannot be reproduced except in full, without prior written approval of the Company. Any unauthorized alteration, forgery or falsification of the content or appearance of this document is unlawful and offenders may be prosecuted to the fullest extent of the law.

Report Number :ER/2021/A0027
 Operation Mode :LTE B7
 Test Mode :Tx CH High
 EUT Pol :H Plane
 Test Frequency :2562.5 MHz

Test Site :SAC 1
 Test Date :2021-11-12
 Temp./Humi. :23.8/53
 Antenna Pol. :Horizontal
 Engineer :GN Lin

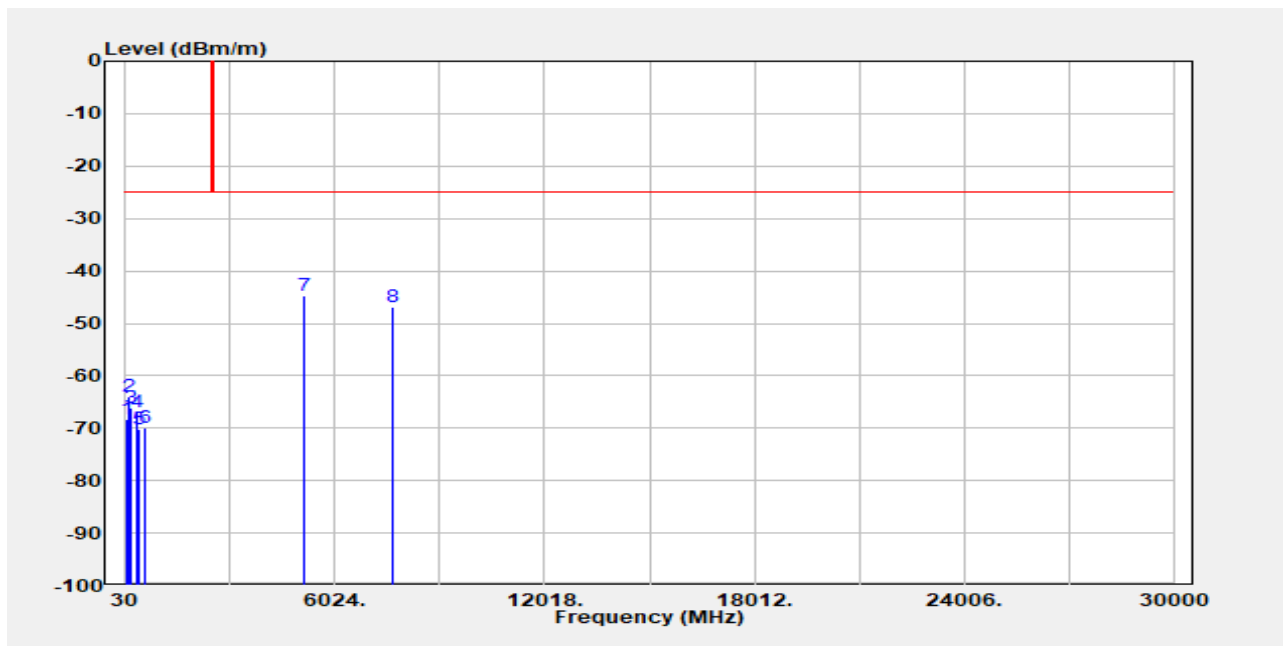

Freq. MHz	EIRP/ERP dBm	SG Output Level dBm	Antenna Gain dBi/dBd	Cable Loss dB	Limit dBm	Margin dB
89.82	-68.22	-66.81	-0.43	-0.98	-25.00	-43.22
149.63	-64.02	-61.25	-1.62	-1.15	-25.00	-39.02
181.97	-66.13	-66.61	1.87	-1.39	-25.00	-41.13
335.55	-67.03	-69.42	4.28	-1.90	-25.00	-42.03
388.90	-70.16	-72.52	4.40	-2.04	-25.00	-45.16
610.38	-70.00	-70.99	3.48	-2.50	-25.00	-45.00
5125.00	-44.72	-48.85	12.10	-7.97	-25.00	-19.72
7687.50	-46.99	-48.54	11.45	-9.91	-25.00	-21.99

Unless otherwise stated the results shown in this test report refer only to the sample(s) tested and such sample(s) are retained for 90 days only.

除非另有說明，此報告結果僅對測試之樣品負責，同時此樣品僅保留90天。本報告未經本公司書面許可，不可部份複製。

This document is issued by the Company subject to its General Conditions of Service printed overleaf, available on request or accessible at <http://www.sgs.com.tw/Terms-and-Conditions> and for electronic format documents, subject to Terms and Conditions for Electronic Documents at <http://www.sgs.com.tw/Terms-and-Conditions>. Attention is drawn to the limitation of liability, indemnification and jurisdiction issues defined therein. Any holder of this document is advised that information contained hereon reflects the Company's findings at the time of its intervention only and within the limits of Client's instructions, if any. The Company's sole responsibility is to its Client and this document does not exonerate parties to a transaction from exercising all their rights and obligations under the transaction documents. This document cannot be reproduced except in full, without prior written approval of the Company. Any unauthorized alteration, forgery or falsification of the content or appearance of this document is unlawful and offenders may be prosecuted to the fullest extent of the law.

Report Number :ER/2021/A0027
 Operation Mode :LTE B12
 Test Mode :Tx CH Low
 EUT Pol :H Plane
 Test Frequency :701.5 MHz

Test Site :SAC 1
 Test Date :2021-11-12
 Temp./Humi. :23.8/53
 Antenna Pol. :Vertical
 Engineer :GN Lin

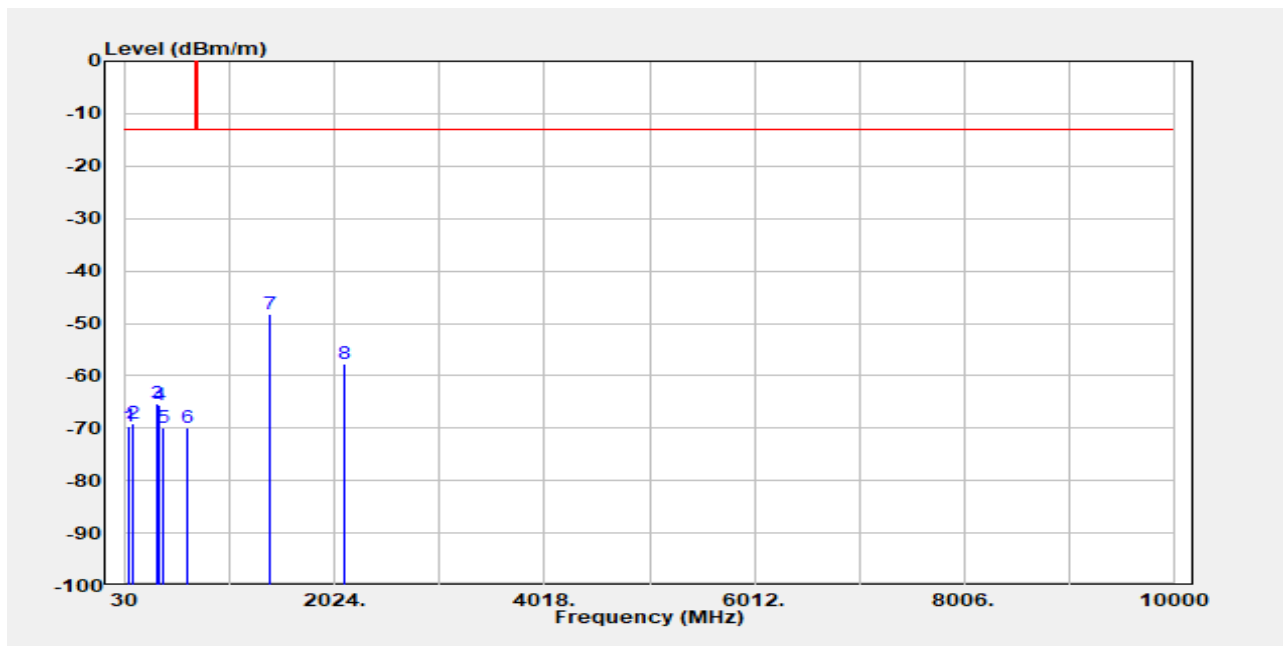

Freq. MHz	EIRP/ERP dBm	SG Output Level dBm	Antenna Gain dBi/dBd	Cable Loss dB	Limit dBm	Margin dB
60.72	-69.52	-59.40	-9.38	-0.74	-13.00	-56.52
107.60	-69.04	-66.57	-1.42	-1.04	-13.00	-56.04
335.55	-65.33	-67.71	4.28	-1.90	-13.00	-52.33
348.48	-65.58	-68.09	4.52	-2.01	-13.00	-52.58
388.90	-70.01	-72.37	4.40	-2.04	-13.00	-57.01
610.38	-70.05	-71.04	3.48	-2.50	-13.00	-57.05
1403.00	-48.37	-52.14	7.62	-3.85	-13.00	-35.37
2104.50	-57.64	-62.71	9.85	-4.77	-13.00	-44.64

Unless otherwise stated the results shown in this test report refer only to the sample(s) tested and such sample(s) are retained for 90 days only.

除非另有說明，此報告結果僅對測試之樣品負責，同時此樣品僅保留90天。本報告未經本公司書面許可，不可部份複製。

This document is issued by the Company subject to its General Conditions of Service printed overleaf, available on request or accessible at <http://www.sgs.com.tw/Terms-and-Conditions> and for electronic format documents, subject to Terms and Conditions for Electronic Documents at <http://www.sgs.com.tw/Terms-and-Conditions>. Attention is drawn to the limitation of liability, indemnification and jurisdiction issues defined therein. Any holder of this document is advised that information contained hereon reflects the Company's findings at the time of its intervention only and within the limits of Client's instructions, if any. The Company's sole responsibility is to its Client and this document does not exonerate parties to a transaction from exercising all their rights and obligations under the transaction documents. This document cannot be reproduced except in full, without prior written approval of the Company. Any unauthorized alteration, forgery or falsification of the content or appearance of this document is unlawful and offenders may be prosecuted to the fullest extent of the law.

Report Number :ER/2021/A0027
 Operation Mode :LTE B12
 Test Mode :Tx CH Low
 EUT Pol :H Plane
 Test Frequency :701.5 MHz

Test Site :SAC 1
 Test Date :2021-11-12
 Temp./Humi. :23.8/53
 Antenna Pol. :Horizontal
 Engineer :GN Lin

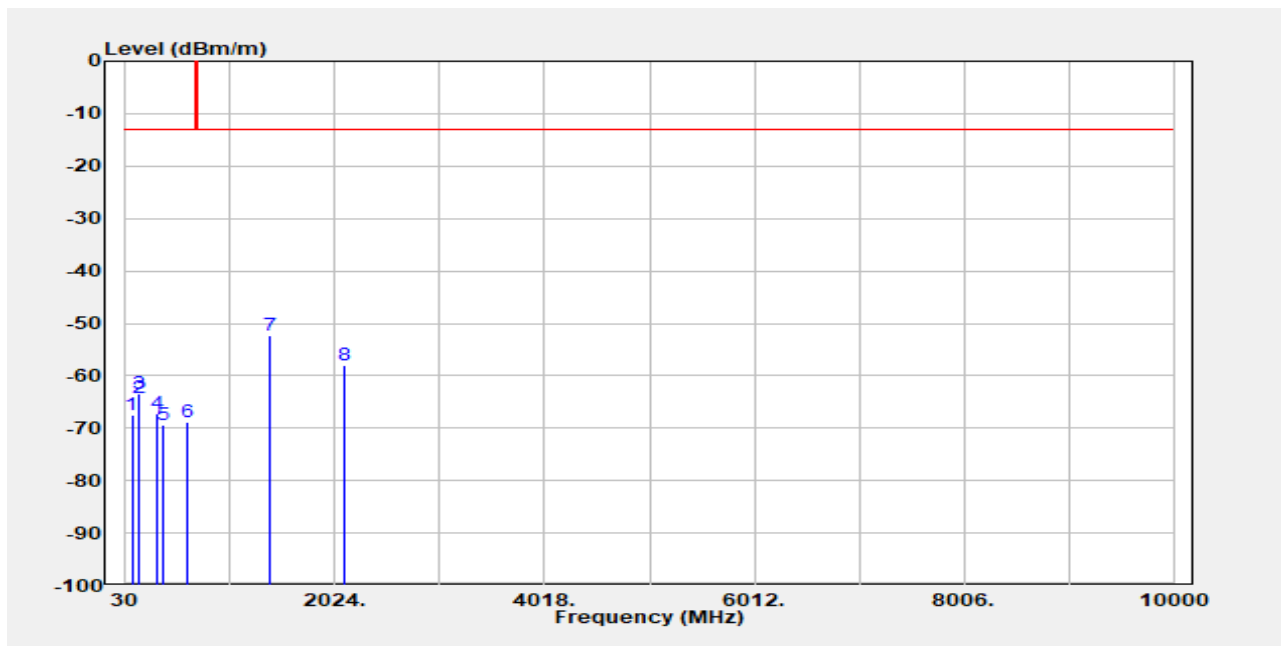

Freq. MHz	EIRP/ERP dBm	SG Output Level dBm	Antenna Gain dBi/dBd	Cable Loss dB	Limit dBm	Margin dB
89.82	-67.51	-66.10	-0.43	-0.98	-13.00	-54.51
149.63	-64.11	-61.34	-1.62	-1.15	-13.00	-51.11
164.18	-63.29	-61.15	-0.88	-1.26	-13.00	-50.29
335.55	-67.26	-69.64	4.28	-1.90	-13.00	-54.26
388.90	-69.45	-71.81	4.40	-2.04	-13.00	-56.45
610.38	-68.72	-69.71	3.48	-2.50	-13.00	-55.72
1403.00	-52.28	-56.05	7.62	-3.85	-13.00	-39.28
2104.50	-58.03	-63.10	9.85	-4.77	-13.00	-45.03

Unless otherwise stated the results shown in this test report refer only to the sample(s) tested and such sample(s) are retained for 90 days only.

除非另有說明，此報告結果僅對測試之樣品負責，同時此樣品僅保留90天。本報告未經本公司書面許可，不可部份複製。

This document is issued by the Company subject to its General Conditions of Service printed overleaf, available on request or accessible at <http://www.sgs.com.tw/Terms-and-Conditions> and for electronic format documents, subject to Terms and Conditions for Electronic Documents at <http://www.sgs.com.tw/Terms-and-Conditions>. Attention is drawn to the limitation of liability, indemnification and jurisdiction issues defined therein. Any holder of this document is advised that information contained hereon reflects the Company's findings at the time of its intervention only and within the limits of Client's instructions, if any. The Company's sole responsibility is to its Client and this document does not exonerate parties to a transaction from exercising all their rights and obligations under the transaction documents. This document cannot be reproduced except in full, without prior written approval of the Company. Any unauthorized alteration, forgery or falsification of the content or appearance of this document is unlawful and offenders may be prosecuted to the fullest extent of the law.

Report Number :ER/2021/A0027
 Operation Mode :LTE B12
 Test Mode :Tx CH Mid
 EUT Pol :H Plane
 Test Frequency :707.5 MHz

Test Site :SAC 1
 Test Date :2021-11-12
 Temp./Humi. :23.8/53
 Antenna Pol. :Vertical
 Engineer :GN Lin

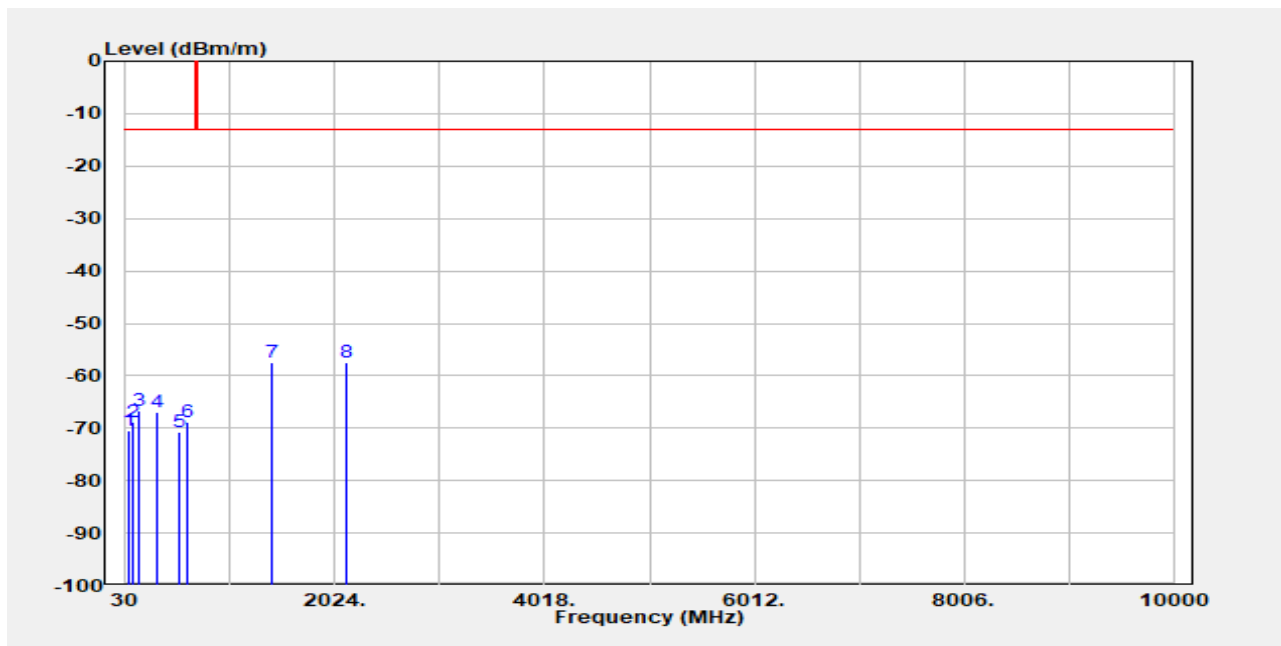

Freq. MHz	EIRP/ERP dBm	SG Output Level dBm	Antenna Gain dBi/dBd	Cable Loss dB	Limit dBm	Margin dB
62.33	-70.33	-60.74	-8.83	-0.76	-13.00	-57.33
101.13	-68.82	-66.93	-0.88	-1.02	-13.00	-55.82
149.63	-66.59	-63.82	-1.62	-1.15	-13.00	-53.59
335.55	-66.82	-69.21	4.28	-1.90	-13.00	-53.82
539.25	-70.75	-72.81	4.40	-2.34	-13.00	-57.75
610.38	-68.90	-69.89	3.48	-2.50	-13.00	-55.90
1415.00	-57.58	-61.44	7.72	-3.86	-13.00	-44.58
2122.50	-57.42	-62.25	9.63	-4.80	-13.00	-44.42

Unless otherwise stated the results shown in this test report refer only to the sample(s) tested and such sample(s) are retained for 90 days only.

除非另有說明，此報告結果僅對測試之樣品負責，同時此樣品僅保留90天。本報告未經本公司書面許可，不可部份複製。

This document is issued by the Company subject to its General Conditions of Service printed overleaf, available on request or accessible at <http://www.sgs.com.tw/Terms-and-Conditions> and for electronic format documents, subject to Terms and Conditions for Electronic Documents at <http://www.sgs.com.tw/Terms-and-Conditions>. Attention is drawn to the limitation of liability, indemnification and jurisdiction issues defined therein. Any holder of this document is advised that information contained hereon reflects the Company's findings at the time of its intervention only and within the limits of Client's instructions, if any. The Company's sole responsibility is to its Client and this document does not exonerate parties to a transaction from exercising all their rights and obligations under the transaction documents. This document cannot be reproduced except in full, without prior written approval of the Company. Any unauthorized alteration, forgery or falsification of the content or appearance of this document is unlawful and offenders may be prosecuted to the fullest extent of the law.

Report Number :ER/2021/A0027
 Operation Mode :LTE B12
 Test Mode :Tx CH Mid
 EUT Pol :H Plane
 Test Frequency :707.5 MHz

Test Site :SAC 1
 Test Date :2021-11-12
 Temp./Humi. :23.8/53
 Antenna Pol. :Horizontal
 Engineer :GN Lin

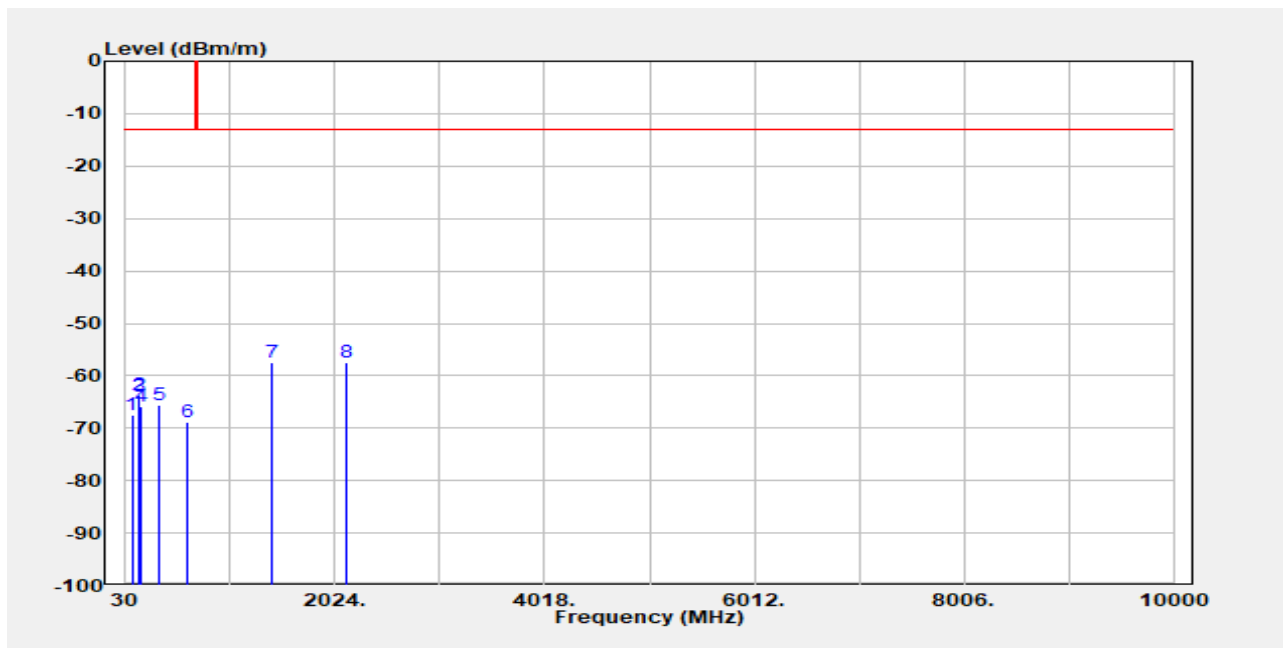

Freq. MHz	EIRP/ERP dBm	SG Output Level dBm	Antenna Gain dBi/dBd	Cable Loss dB	Limit dBm	Margin dB
89.82	-67.37	-65.96	-0.43	-0.98	-13.00	-54.37
149.63	-63.77	-61.00	-1.62	-1.15	-13.00	-50.77
164.18	-63.91	-61.78	-0.88	-1.26	-13.00	-50.91
181.97	-65.88	-66.37	1.87	-1.39	-13.00	-52.88
342.02	-65.66	-68.10	4.36	-1.92	-13.00	-52.66
610.38	-68.94	-69.93	3.48	-2.50	-13.00	-55.94
1415.00	-57.42	-61.28	7.72	-3.86	-13.00	-44.41
2122.50	-57.54	-62.37	9.63	-4.80	-13.00	-44.53

Unless otherwise stated the results shown in this test report refer only to the sample(s) tested and such sample(s) are retained for 90 days only.

除非另有說明，此報告結果僅對測試之樣品負責，同時此樣品僅保留90天。本報告未經本公司書面許可，不可部份複製。

This document is issued by the Company subject to its General Conditions of Service printed overleaf, available on request or accessible at <http://www.sgs.com.tw/Terms-and-Conditions> and for electronic format documents, subject to Terms and Conditions for Electronic Documents at <http://www.sgs.com.tw/Terms-and-Conditions>. Attention is drawn to the limitation of liability, indemnification and jurisdiction issues defined therein. Any holder of this document is advised that information contained hereon reflects the Company's findings at the time of its intervention only and within the limits of Client's instructions, if any. The Company's sole responsibility is to its Client and this document does not exonerate parties to a transaction from exercising all their rights and obligations under the transaction documents. This document cannot be reproduced except in full, without prior written approval of the Company. Any unauthorized alteration, forgery or falsification of the content or appearance of this document is unlawful and offenders may be prosecuted to the fullest extent of the law.

Report Number :ER/2021/A0027
 Operation Mode :LTE B12
 Test Mode :Tx CH High
 EUT Pol :H Plane
 Test Frequency :713.5 MHz

Test Site :SAC 1
 Test Date :2021-11-12
 Temp./Humi. :23.8/53
 Antenna Pol. :Vertical
 Engineer :GN Lin

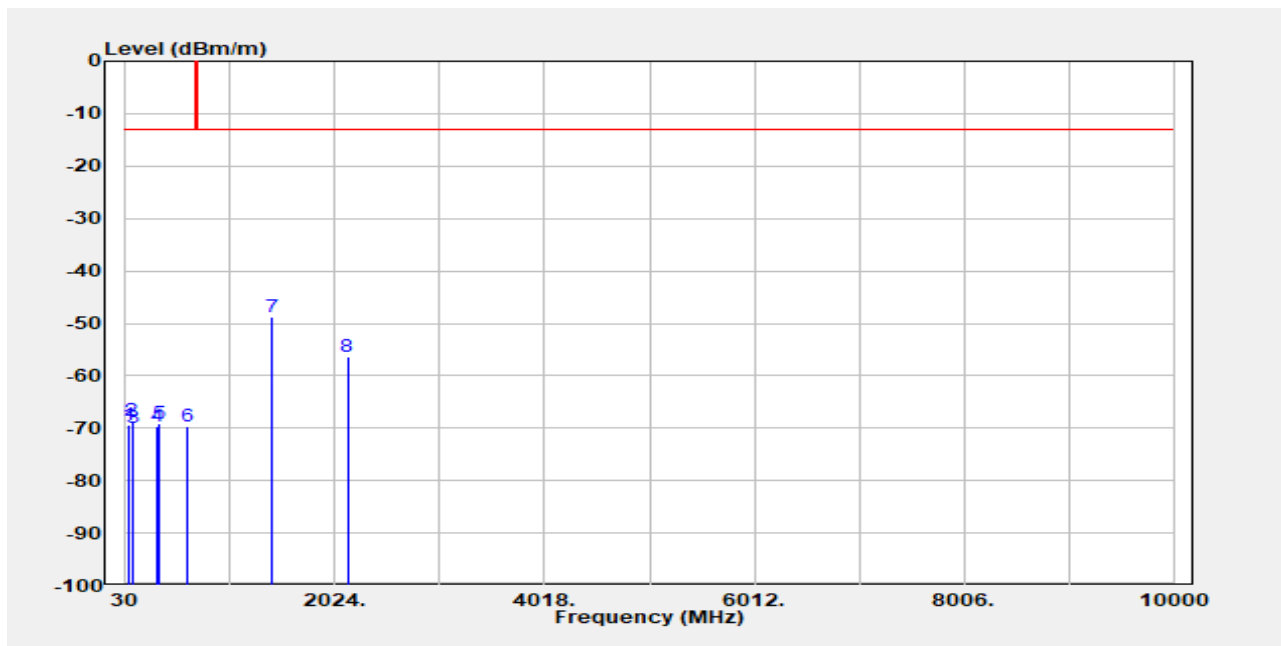

Freq. MHz	EIRP/ERP dBm	SG Output Level dBm	Antenna Gain dBi/dBd	Cable Loss dB	Limit dBm	Margin dB
62.33	-69.27	-59.69	-8.83	-0.76	-13.00	-56.27
89.82	-68.64	-67.23	-0.43	-0.98	-13.00	-55.64
107.60	-69.84	-67.37	-1.42	-1.04	-13.00	-56.84
335.55	-69.68	-72.06	4.28	-1.90	-13.00	-56.68
348.48	-69.17	-71.68	4.52	-2.01	-13.00	-56.17
610.38	-69.71	-70.70	3.48	-2.50	-13.00	-56.71
1427.00	-48.84	-52.78	7.82	-3.88	-13.00	-35.83
2140.50	-56.30	-60.89	9.41	-4.82	-13.00	-43.29

Unless otherwise stated the results shown in this test report refer only to the sample(s) tested and such sample(s) are retained for 90 days only.

除非另有說明，此報告結果僅對測試之樣品負責，同時此樣品僅保留90天。本報告未經本公司書面許可，不可部份複製。

This document is issued by the Company subject to its General Conditions of Service printed overleaf, available on request or accessible at <http://www.sgs.com.tw/Terms-and-Conditions> and for electronic format documents, subject to Terms and Conditions for Electronic Documents at <http://www.sgs.com.tw/Terms-and-Conditions>. Attention is drawn to the limitation of liability, indemnification and jurisdiction issues defined therein. Any holder of this document is advised that information contained hereon reflects the Company's findings at the time of its intervention only and within the limits of Client's instructions, if any. The Company's sole responsibility is to its Client and this document does not exonerate parties to a transaction from exercising all their rights and obligations under the transaction documents. This document cannot be reproduced except in full, without prior written approval of the Company. Any unauthorized alteration, forgery or falsification of the content or appearance of this document is unlawful and offenders may be prosecuted to the fullest extent of the law.

Report Number :ER/2021/A0027
 Operation Mode :LTE B12
 Test Mode :Tx CH High
 EUT Pol :H Plane
 Test Frequency :713.5 MHz

Test Site :SAC 1
 Test Date :2021-11-12
 Temp./Humi. :23.8/53
 Antenna Pol. :Horizontal
 Engineer :GN Lin

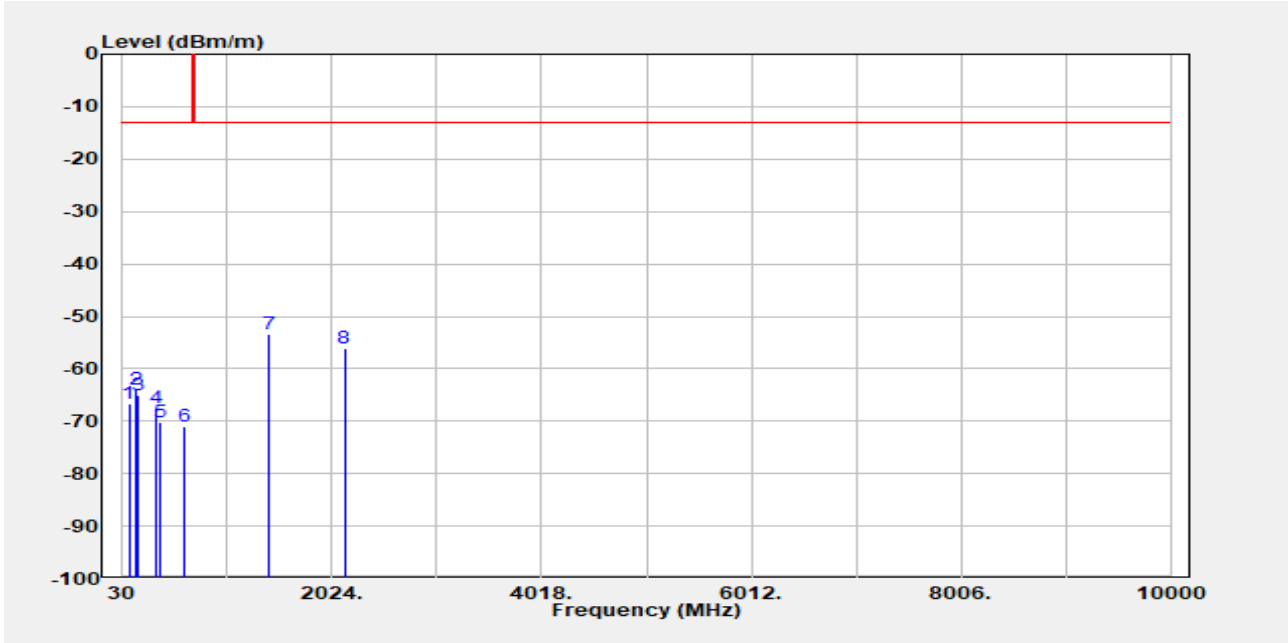

Freq. MHz	EIRP/ERP dBm	SG Output Level dBm	Antenna Gain dBi/dBd	Cable Loss dB	Limit dBm	Margin dB
89.82	-66.67	-65.26	-0.43	-0.98	-13.00	-53.67
149.63	-63.84	-61.07	-1.62	-1.15	-13.00	-50.84
170.65	-65.04	-63.55	-0.21	-1.27	-13.00	-52.04
342.02	-67.41	-69.86	4.36	-1.92	-13.00	-54.41
388.90	-70.07	-72.43	4.40	-2.04	-13.00	-57.07
610.38	-71.02	-72.01	3.48	-2.50	-13.00	-58.02
1427.00	-53.46	-57.40	7.82	-3.88	-13.00	-40.45
2140.50	-56.10	-60.69	9.41	-4.82	-13.00	-43.09

Unless otherwise stated the results shown in this test report refer only to the sample(s) tested and such sample(s) are retained for 90 days only.

除非另有說明，此報告結果僅對測試之樣品負責，同時此樣品僅保留90天。本報告未經本公司書面許可，不可部份複製。

This document is issued by the Company subject to its General Conditions of Service printed overleaf, available on request or accessible at <http://www.sgs.com.tw/Terms-and-Conditions> and for electronic format documents, subject to Terms and Conditions for Electronic Documents at <http://www.sgs.com.tw/Terms-and-Conditions>. Attention is drawn to the limitation of liability, indemnification and jurisdiction issues defined therein. Any holder of this document is advised that information contained hereon reflects the Company's findings at the time of its intervention only and within the limits of Client's instructions, if any. The Company's sole responsibility is to its Client and this document does not exonerate parties to a transaction from exercising all their rights and obligations under the transaction documents. This document cannot be reproduced except in full, without prior written approval of the Company. Any unauthorized alteration, forgery or falsification of the content or appearance of this document is unlawful and offenders may be prosecuted to the fullest extent of the law.

Report Number :ER/2021/A0027
 Operation Mode :LTE B13
 Test Mode :Tx CH Low
 EUT Pol :H Plane
 Test Frequency :779.5 MHz

Test Site :SAC 1
 Test Date :2021-11-12
 Temp./Humi. :23.8/53
 Antenna Pol. :Vertical
 Engineer :GN Lin

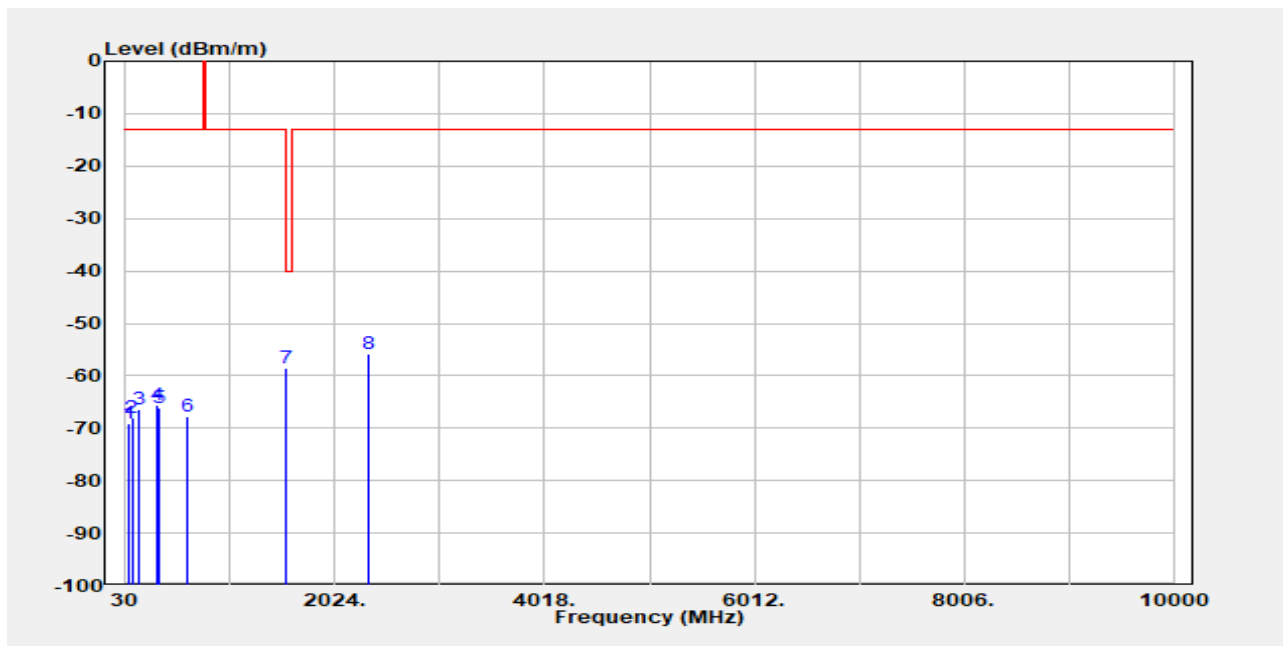

Freq. MHz	EIRP/ERP dBm	SG Output Level dBm	Antenna Gain dBi/dBd	Cable Loss dB	Limit dBm	Margin dB
62.33	-69.00	-59.42	-8.83	-0.76	-13.00	-56.00
89.82	-67.91	-66.50	-0.43	-0.98	-13.00	-54.91
149.63	-66.35	-63.59	-1.62	-1.15	-13.00	-53.35
335.55	-65.57	-67.96	4.28	-1.90	-13.00	-52.57
348.48	-66.14	-68.65	4.52	-2.01	-13.00	-53.14
610.38	-67.85	-68.83	3.48	-2.50	-13.00	-54.85
1559.00	-58.43	-63.49	9.15	-4.09	-40.00	-18.43
2338.50	-55.70	-60.24	9.53	-4.99	-13.00	-42.70

Unless otherwise stated the results shown in this test report refer only to the sample(s) tested and such sample(s) are retained for 90 days only.

除非另有說明，此報告結果僅對測試之樣品負責，同時此樣品僅保留90天。本報告未經本公司書面許可，不可部份複製。

This document is issued by the Company subject to its General Conditions of Service printed overleaf, available on request or accessible at <http://www.sgs.com.tw/Terms-and-Conditions> and for electronic format documents, subject to Terms and Conditions for Electronic Documents at <http://www.sgs.com.tw/Terms-and-Conditions>. Attention is drawn to the limitation of liability, indemnification and jurisdiction issues defined therein. Any holder of this document is advised that information contained hereon reflects the Company's findings at the time of its intervention only and within the limits of Client's instructions, if any. The Company's sole responsibility is to its Client and this document does not exonerate parties to a transaction from exercising all their rights and obligations under the transaction documents. This document cannot be reproduced except in full, without prior written approval of the Company. Any unauthorized alteration, forgery or falsification of the content or appearance of this document is unlawful and offenders may be prosecuted to the fullest extent of the law.

Report Number :ER/2021/A0027
 Operation Mode :LTE B13
 Test Mode :Tx CH Low
 EUT Pol :H Plane
 Test Frequency :779.5 MHz

Test Site :SAC 1
 Test Date :2021-11-12
 Temp./Humi. :23.8/53
 Antenna Pol. :Horizontal
 Engineer :GN Lin

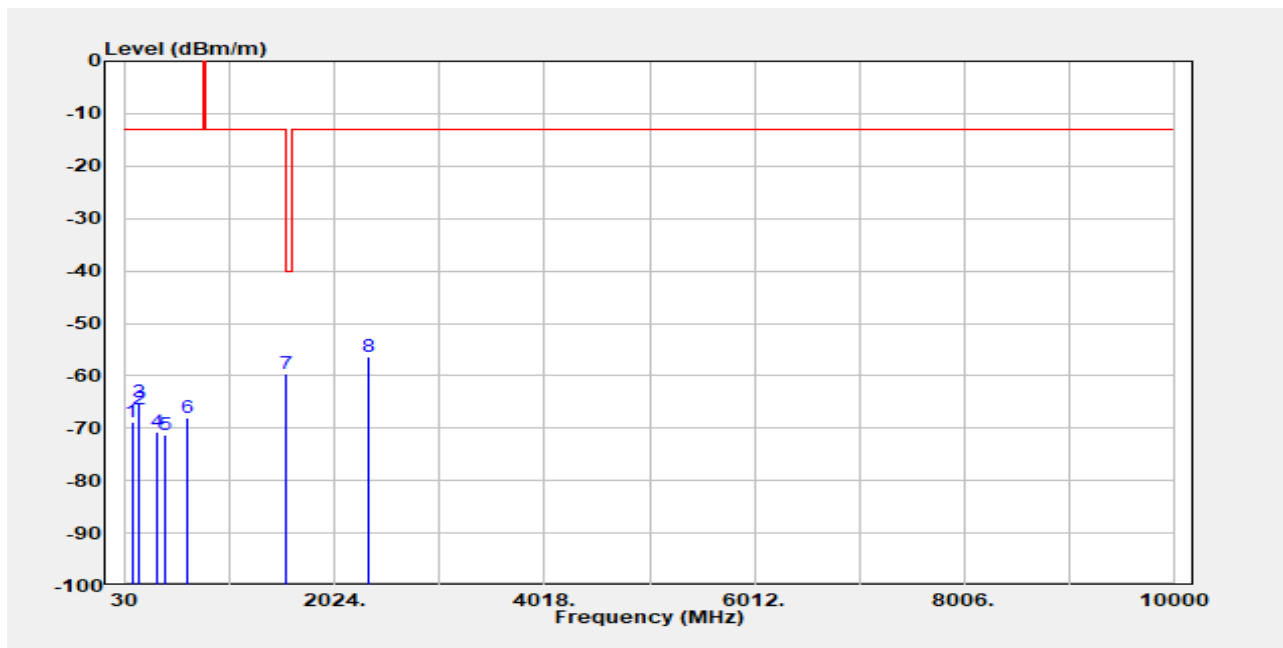

Freq. MHz	EIRP/ERP dBm	SG Output Level dBm	Antenna Gain dBi/dBd	Cable Loss dB	Limit dBm	Margin dB
89.82	-68.71	-67.30	-0.43	-0.98	-13.00	-55.71
149.63	-66.36	-63.59	-1.62	-1.15	-13.00	-53.36
164.18	-65.01	-62.88	-0.88	-1.26	-13.00	-52.01
335.55	-70.76	-73.14	4.28	-1.90	-13.00	-57.76
401.83	-71.40	-73.65	4.32	-2.08	-13.00	-58.40
610.38	-68.03	-69.01	3.48	-2.50	-13.00	-55.03
1559.00	-59.69	-64.75	9.15	-4.09	-40.00	-19.68
2338.50	-56.34	-60.88	9.53	-4.99	-13.00	-43.33

Unless otherwise stated the results shown in this test report refer only to the sample(s) tested and such sample(s) are retained for 90 days only.

除非另有說明，此報告結果僅對測試之樣品負責，同時此樣品僅保留90天。本報告未經本公司書面許可，不可部份複製。

This document is issued by the Company subject to its General Conditions of Service printed overleaf, available on request or accessible at <http://www.sgs.com.tw/Terms-and-Conditions> and for electronic format documents, subject to Terms and Conditions for Electronic Documents at <http://www.sgs.com.tw/Terms-and-Conditions>. Attention is drawn to the limitation of liability, indemnification and jurisdiction issues defined therein. Any holder of this document is advised that information contained hereon reflects the Company's findings at the time of its intervention only and within the limits of Client's instructions, if any. The Company's sole responsibility is to its Client and this document does not exonerate parties to a transaction from exercising all their rights and obligations under the transaction documents. This document cannot be reproduced except in full, without prior written approval of the Company. Any unauthorized alteration, forgery or falsification of the content or appearance of this document is unlawful and offenders may be prosecuted to the fullest extent of the law.

Report Number :ER/2021/A0027
 Operation Mode :LTE B13
 Test Mode :Tx CH Mid
 EUT Pol :H Plane
 Test Frequency :782 MHz

Test Site :SAC 1
 Test Date :2021-11-12
 Temp./Humi. :23.8/53
 Antenna Pol. :Vertical
 Engineer :GN Lin

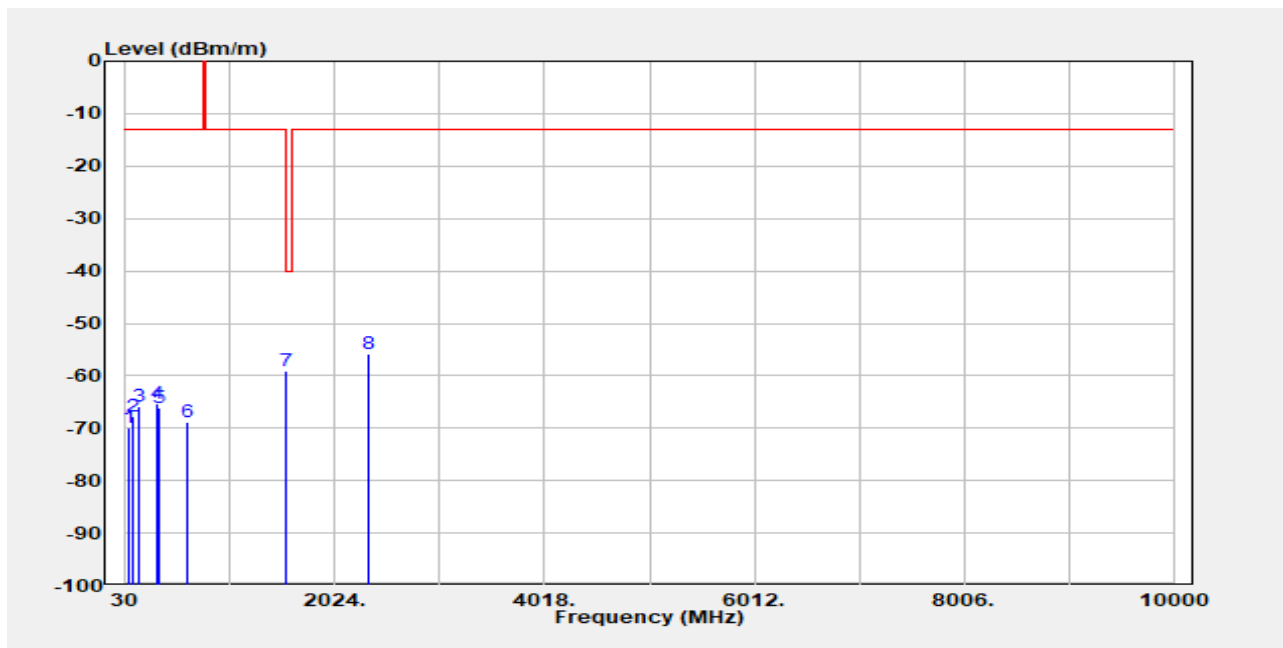

Freq. MHz	EIRP/ERP dBm	SG Output Level dBm	Antenna Gain dBi/dBd	Cable Loss dB	Limit dBm	Margin dB
60.72	-69.97	-59.85	-9.38	-0.74	-13.00	-56.97
107.60	-67.84	-65.37	-1.42	-1.04	-13.00	-54.84
149.63	-65.92	-63.15	-1.62	-1.15	-13.00	-52.92
335.55	-65.43	-67.82	4.28	-1.90	-13.00	-52.43
348.48	-66.13	-68.64	4.52	-2.01	-13.00	-53.13
610.38	-68.85	-69.84	3.48	-2.50	-13.00	-55.85
1564.00	-59.10	-64.18	9.18	-4.10	-40.00	-19.10
2346.00	-55.89	-60.47	9.58	-5.01	-13.00	-42.89

Unless otherwise stated the results shown in this test report refer only to the sample(s) tested and such sample(s) are retained for 90 days only.

除非另有說明，此報告結果僅對測試之樣品負責，同時此樣品僅保留90天。本報告未經本公司書面許可，不可部份複製。

This document is issued by the Company subject to its General Conditions of Service printed overleaf, available on request or accessible at <http://www.sgs.com.tw/Terms-and-Conditions> and for electronic format documents, subject to Terms and Conditions for Electronic Documents at <http://www.sgs.com.tw/Terms-and-Conditions>. Attention is drawn to the limitation of liability, indemnification and jurisdiction issues defined therein. Any holder of this document is advised that information contained hereon reflects the Company's findings at the time of its intervention only and within the limits of Client's instructions, if any. The Company's sole responsibility is to its Client and this document does not exonerate parties to a transaction from exercising all their rights and obligations under the transaction documents. This document cannot be reproduced except in full, without prior written approval of the Company. Any unauthorized alteration, forgery or falsification of the content or appearance of this document is unlawful and offenders may be prosecuted to the fullest extent of the law.

Report Number :ER/2021/A0027
 Operation Mode :LTE B13
 Test Mode :Tx CH Mid
 EUT Pol :H Plane
 Test Frequency :782 MHz

Test Site :SAC 1
 Test Date :2021-11-12
 Temp./Humi. :23.8/53
 Antenna Pol. :Horizontal
 Engineer :GN Lin

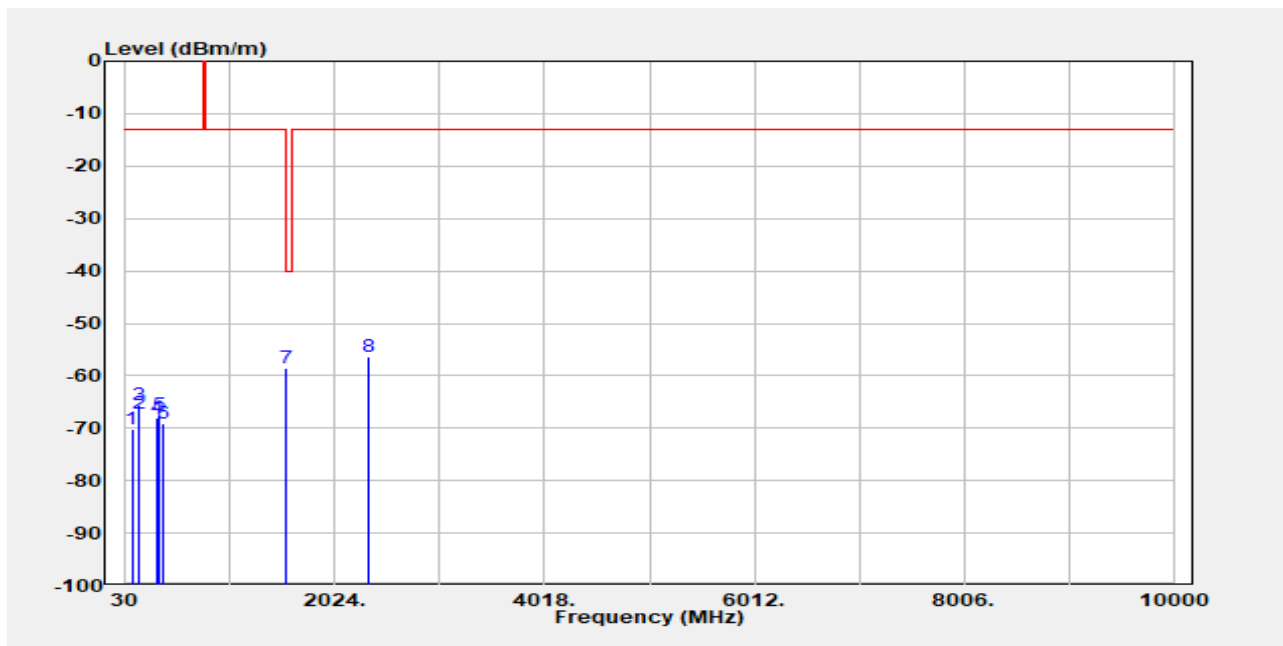

Freq. MHz	EIRP/ERP dBm	SG Output Level dBm	Antenna Gain dBi/dBd	Cable Loss dB	Limit dBm	Margin dB
89.82	-70.26	-68.85	-0.43	-0.98	-13.00	-57.26
149.63	-67.24	-64.47	-1.62	-1.15	-13.00	-54.24
164.18	-65.66	-63.53	-0.88	-1.26	-13.00	-52.66
335.55	-68.14	-70.52	4.28	-1.90	-13.00	-55.14
348.48	-67.59	-70.10	4.52	-2.01	-13.00	-54.59
388.90	-69.09	-71.45	4.40	-2.04	-13.00	-56.09
1564.00	-58.56	-63.64	9.18	-4.10	-40.00	-18.55
2346.00	-56.42	-60.99	9.58	-5.01	-13.00	-43.41

Unless otherwise stated the results shown in this test report refer only to the sample(s) tested and such sample(s) are retained for 90 days only.

除非另有說明，此報告結果僅對測試之樣品負責，同時此樣品僅保留90天。本報告未經本公司書面許可，不可部份複製。

This document is issued by the Company subject to its General Conditions of Service printed overleaf, available on request or accessible at <http://www.sgs.com.tw/Terms-and-Conditions> and for electronic format documents, subject to Terms and Conditions for Electronic Documents at <http://www.sgs.com.tw/Terms-and-Conditions>. Attention is drawn to the limitation of liability, indemnification and jurisdiction issues defined therein. Any holder of this document is advised that information contained hereon reflects the Company's findings at the time of its intervention only and within the limits of Client's instructions, if any. The Company's sole responsibility is to its Client and this document does not exonerate parties to a transaction from exercising all their rights and obligations under the transaction documents. This document cannot be reproduced except in full, without prior written approval of the Company. Any unauthorized alteration, forgery or falsification of the content or appearance of this document is unlawful and offenders may be prosecuted to the fullest extent of the law.

Report Number :ER/2021/A0027
 Operation Mode :LTE B13
 Test Mode :Tx CH High
 EUT Pol :H Plane
 Test Frequency :784.5 MHz

Test Site :SAC 1
 Test Date :2021-11-12
 Temp./Humi. :23.8/53
 Antenna Pol. :Vertical
 Engineer :GN Lin

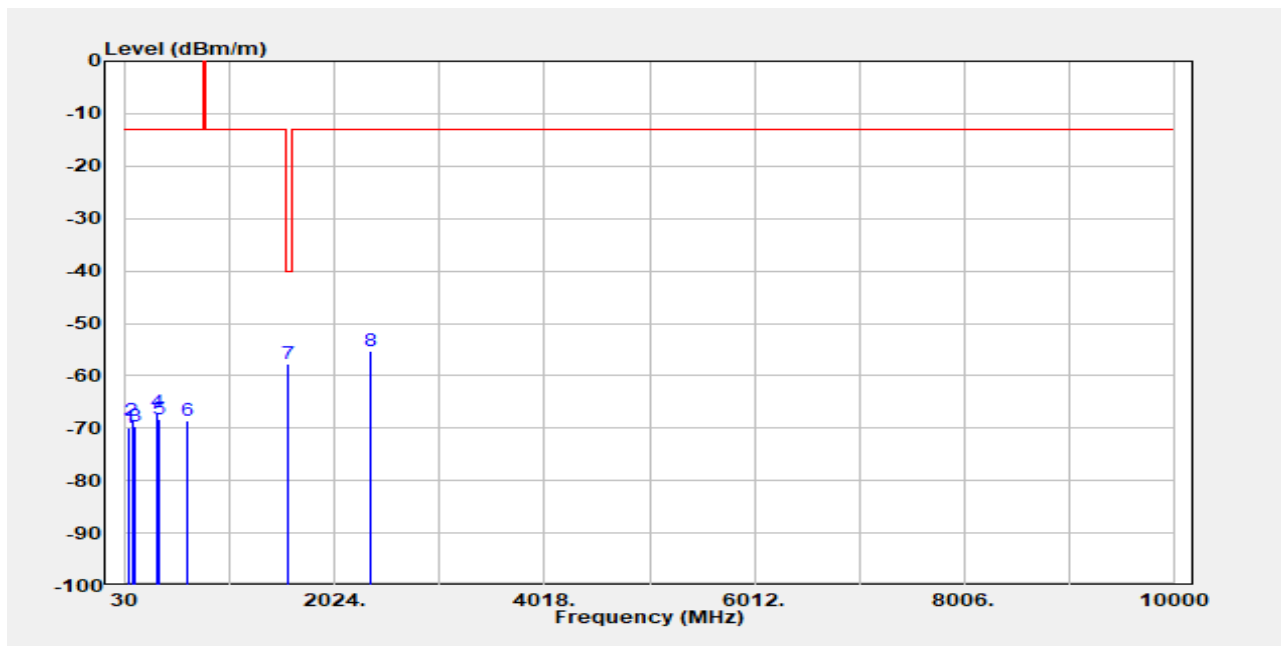

Freq. MHz	EIRP/ERP dBm	SG Output Level dBm	Antenna Gain dBi/dBd	Cable Loss dB	Limit dBm	Margin dB
60.72	-70.00	-59.88	-9.38	-0.74	-13.00	-57.00
89.82	-68.61	-67.20	-0.43	-0.98	-13.00	-55.61
110.83	-69.68	-67.18	-1.44	-1.06	-13.00	-56.68
335.55	-67.04	-69.42	4.28	-1.90	-13.00	-54.04
348.48	-68.32	-70.83	4.52	-2.01	-13.00	-55.32
610.38	-68.68	-69.67	3.48	-2.50	-13.00	-55.68
1569.00	-57.77	-62.87	9.22	-4.12	-40.00	-17.77
2353.50	-55.30	-59.91	9.64	-5.02	-13.00	-42.30

Unless otherwise stated the results shown in this test report refer only to the sample(s) tested and such sample(s) are retained for 90 days only.

除非另有說明，此報告結果僅對測試之樣品負責，同時此樣品僅保留90天。本報告未經本公司書面許可，不可部份複製。

This document is issued by the Company subject to its General Conditions of Service printed overleaf, available on request or accessible at <http://www.sgs.com.tw/Terms-and-Conditions> and for electronic format documents, subject to Terms and Conditions for Electronic Documents at <http://www.sgs.com.tw/Terms-and-Conditions>. Attention is drawn to the limitation of liability, indemnification and jurisdiction issues defined therein. Any holder of this document is advised that information contained hereon reflects the Company's findings at the time of its intervention only and within the limits of Client's instructions, if any. The Company's sole responsibility is to its Client and this document does not exonerate parties to a transaction from exercising all their rights and obligations under the transaction documents. This document cannot be reproduced except in full, without prior written approval of the Company. Any unauthorized alteration, forgery or falsification of the content or appearance of this document is unlawful and offenders may be prosecuted to the fullest extent of the law.

Report Number :ER/2021/A0027
 Operation Mode :LTE B13
 Test Mode :Tx CH High
 EUT Pol :H Plane
 Test Frequency :784.5 MHz

Test Site :SAC 1
 Test Date :2021-11-12
 Temp./Humi. :23.8/53
 Antenna Pol. :Horizontal
 Engineer :GN Lin

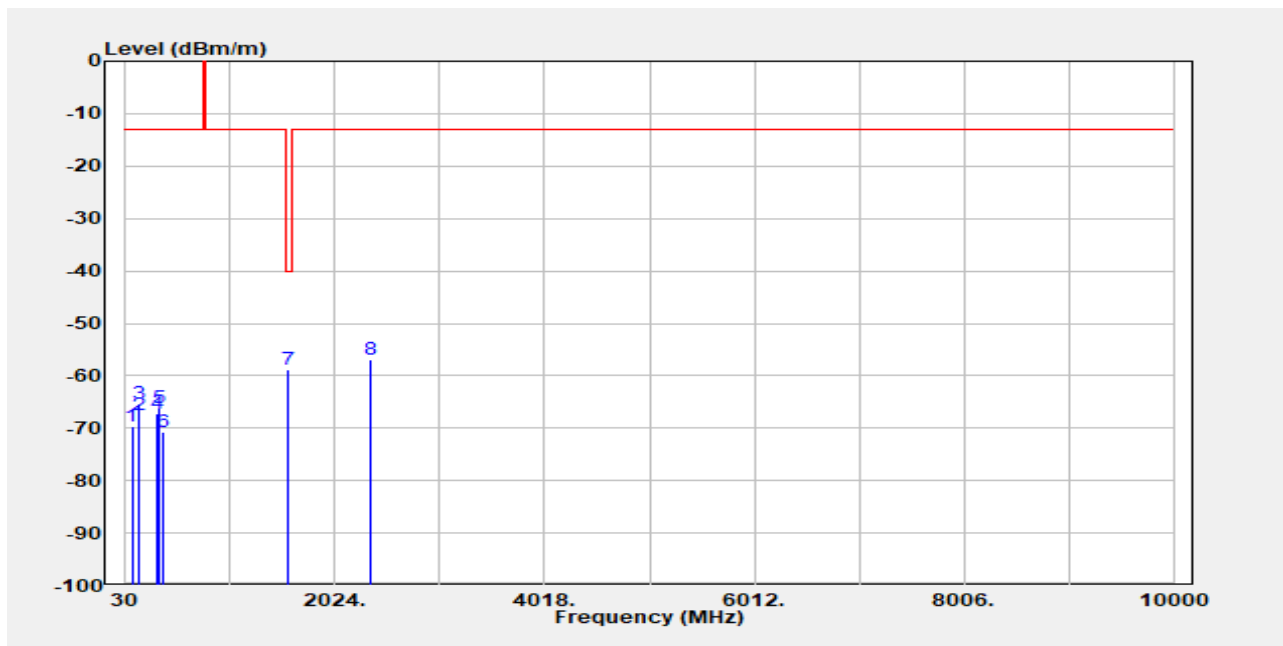

Freq. MHz	EIRP/ERP dBm	SG Output Level dBm	Antenna Gain dBi/dBd	Cable Loss dB	Limit dBm	Margin dB
89.82	-69.52	-68.11	-0.43	-0.98	-13.00	-56.52
149.63	-67.59	-64.83	-1.62	-1.15	-13.00	-54.59
164.18	-65.36	-63.22	-0.88	-1.26	-13.00	-52.36
335.55	-67.18	-69.57	4.28	-1.90	-13.00	-54.18
348.48	-66.04	-68.55	4.52	-2.01	-13.00	-53.04
388.90	-70.63	-72.99	4.40	-2.04	-13.00	-57.63
1569.00	-58.77	-63.87	9.22	-4.12	-40.00	-18.76
2353.50	-56.82	-61.44	9.64	-5.02	-13.00	-43.81

Unless otherwise stated the results shown in this test report refer only to the sample(s) tested and such sample(s) are retained for 90 days only.

除非另有說明，此報告結果僅對測試之樣品負責，同時此樣品僅保留90天。本報告未經本公司書面許可，不可部份複製。

This document is issued by the Company subject to its General Conditions of Service printed overleaf, available on request or accessible at <http://www.sgs.com.tw/Terms-and-Conditions> and for electronic format documents, subject to Terms and Conditions for Electronic Documents at <http://www.sgs.com.tw/Terms-and-Conditions>. Attention is drawn to the limitation of liability, indemnification and jurisdiction issues defined therein. Any holder of this document is advised that information contained hereon reflects the Company's findings at the time of its intervention only and within the limits of Client's instructions, if any. The Company's sole responsibility is to its Client and this document does not exonerate parties to a transaction from exercising all their rights and obligations under the transaction documents. This document cannot be reproduced except in full, without prior written approval of the Company. Any unauthorized alteration, forgery or falsification of the content or appearance of this document is unlawful and offenders may be prosecuted to the fullest extent of the law.

Report Number :ER/2021/A0027
 Operation Mode :LTE B13
 Test Mode :Tx CH Low
 EUT Pol :H Plane
 Test Frequency :779.5 MHz

Test Site :SAC 1
 Test Date :2021-11-12
 Temp./Humi. :23.8/53
 Antenna Pol. :Vertical
 Engineer :GN Lin

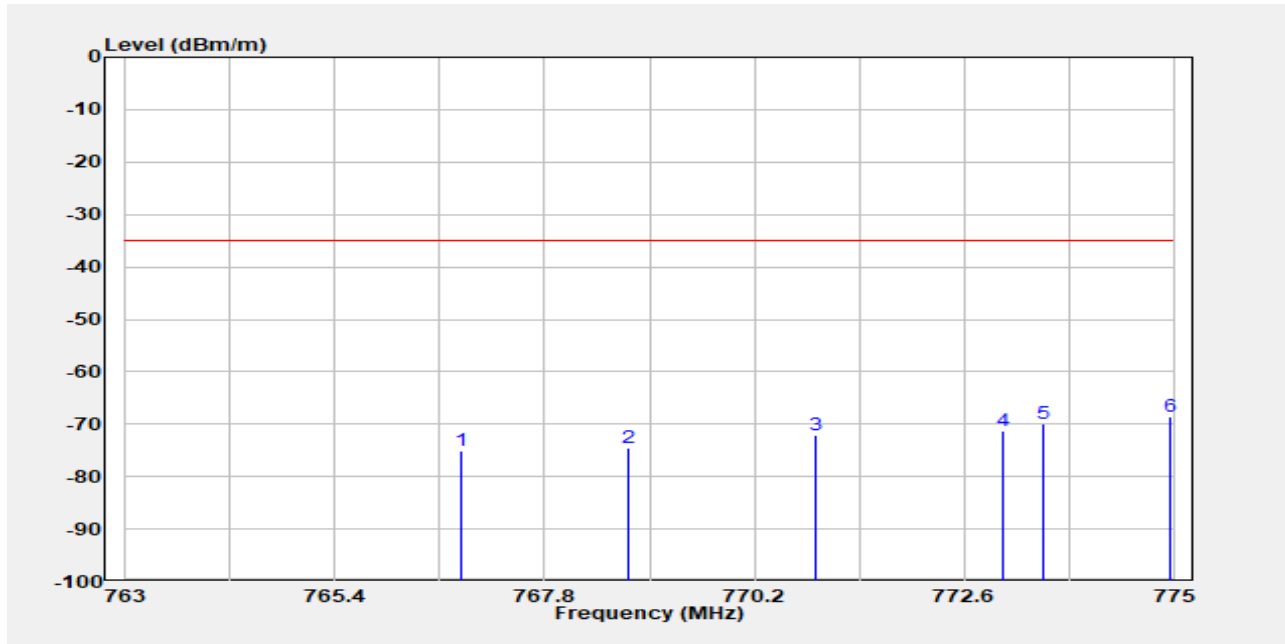

Freq. MHz	EIRP/ERP dBm	SG Output Level dBm	Antenna Gain dBi/dBd	Cable Loss dB	Limit dBm	Margin dB
766.84	-75.05	-75.32	3.07	-2.81	-35.00	-40.05
768.76	-74.66	-74.85	3.10	-2.91	-35.00	-39.66
770.90	-72.21	-72.35	3.12	-2.98	-35.00	-37.21
773.06	-71.28	-71.43	3.14	-3.00	-35.00	-36.28
773.52	-69.81	-69.95	3.15	-3.00	-35.00	-34.81
774.96	-68.50	-68.65	3.17	-3.02	-35.00	-33.50

Unless otherwise stated the results shown in this test report refer only to the sample(s) tested and such sample(s) are retained for 90 days only.

除非另有說明，此報告結果僅對測試之樣品負責，同時此樣品僅保留90天。本報告未經本公司書面許可，不可部份複製。

This document is issued by the Company subject to its General Conditions of Service printed overleaf, available on request or accessible at <http://www.sgs.com.tw/Terms-and-Conditions> and for electronic format documents, subject to Terms and Conditions for Electronic Documents at <http://www.sgs.com.tw/Terms-and-Conditions>. Attention is drawn to the limitation of liability, indemnification and jurisdiction issues defined therein. Any holder of this document is advised that information contained hereon reflects the Company's findings at the time of its intervention only and within the limits of Client's instructions, if any. The Company's sole responsibility is to its Client and this document does not exonerate parties to a transaction from exercising all their rights and obligations under the transaction documents. This document cannot be reproduced except in full, without prior written approval of the Company. Any unauthorized alteration, forgery or falsification of the content or appearance of this document is unlawful and offenders may be prosecuted to the fullest extent of the law.

Report Number :ER/2021/A0027
 Operation Mode :LTE B13
 Test Mode :Tx CH Low
 EUT Pol :H Plane
 Test Frequency :779.5 MHz

Test Site :SAC 1
 Test Date :2021-11-12
 Temp./Humi. :23.8/53
 Antenna Pol. :Horizontal
 Engineer :GN Lin

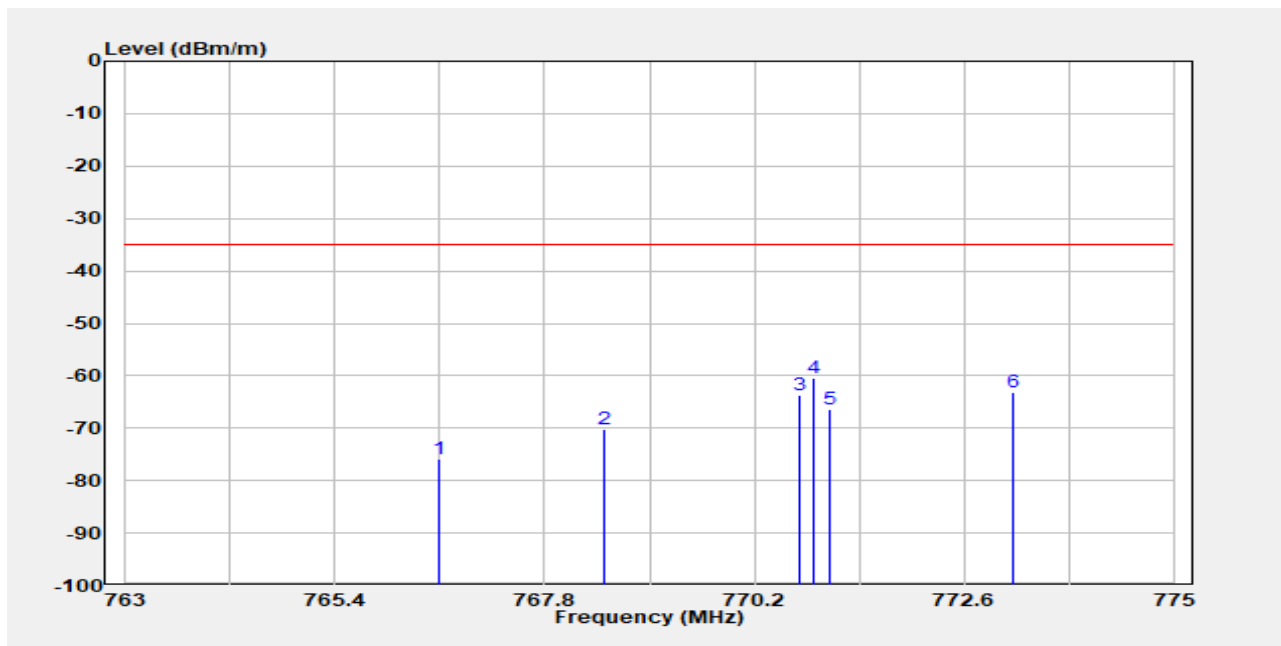

Freq. MHz	EIRP/ERP dBm	SG Output Level dBm	Antenna Gain dBi/dBd	Cable Loss dB	Limit dBm	Margin dB
766.60	-75.88	-76.16	3.07	-2.80	-35.00	-40.88
768.48	-70.29	-70.49	3.09	-2.89	-35.00	-35.29
770.72	-63.79	-63.93	3.12	-2.98	-35.00	-28.79
770.88	-60.57	-60.71	3.12	-2.98	-35.00	-25.57
771.06	-66.47	-66.61	3.12	-2.98	-35.00	-31.47
773.16	-63.03	-63.18	3.15	-3.00	-35.00	-28.03

Unless otherwise stated the results shown in this test report refer only to the sample(s) tested and such sample(s) are retained for 90 days only.

除非另有說明，此報告結果僅對測試之樣品負責，同時此樣品僅保留90天。本報告未經本公司書面許可，不可部份複製。

This document is issued by the Company subject to its General Conditions of Service printed overleaf, available on request or accessible at <http://www.sgs.com.tw/Terms-and-Conditions> and for electronic format documents, subject to Terms and Conditions for Electronic Documents at <http://www.sgs.com.tw/Terms-and-Conditions>. Attention is drawn to the limitation of liability, indemnification and jurisdiction issues defined therein. Any holder of this document is advised that information contained hereon reflects the Company's findings at the time of its intervention only and within the limits of Client's instructions, if any. The Company's sole responsibility is to its Client and this document does not exonerate parties to a transaction from exercising all their rights and obligations under the transaction documents. This document cannot be reproduced except in full, without prior written approval of the Company. Any unauthorized alteration, forgery or falsification of the content or appearance of this document is unlawful and offenders may be prosecuted to the fullest extent of the law.

Report Number :ER/2021/A0027
 Operation Mode :LTE B13
 Test Mode :Tx CH Low
 EUT Pol :H Plane
 Test Frequency :779.5 MHz

Test Site :SAC 1
 Test Date :2021-11-12
 Temp./Humi. :23.8/53
 Antenna Pol. :Vertical
 Engineer :GN Lin

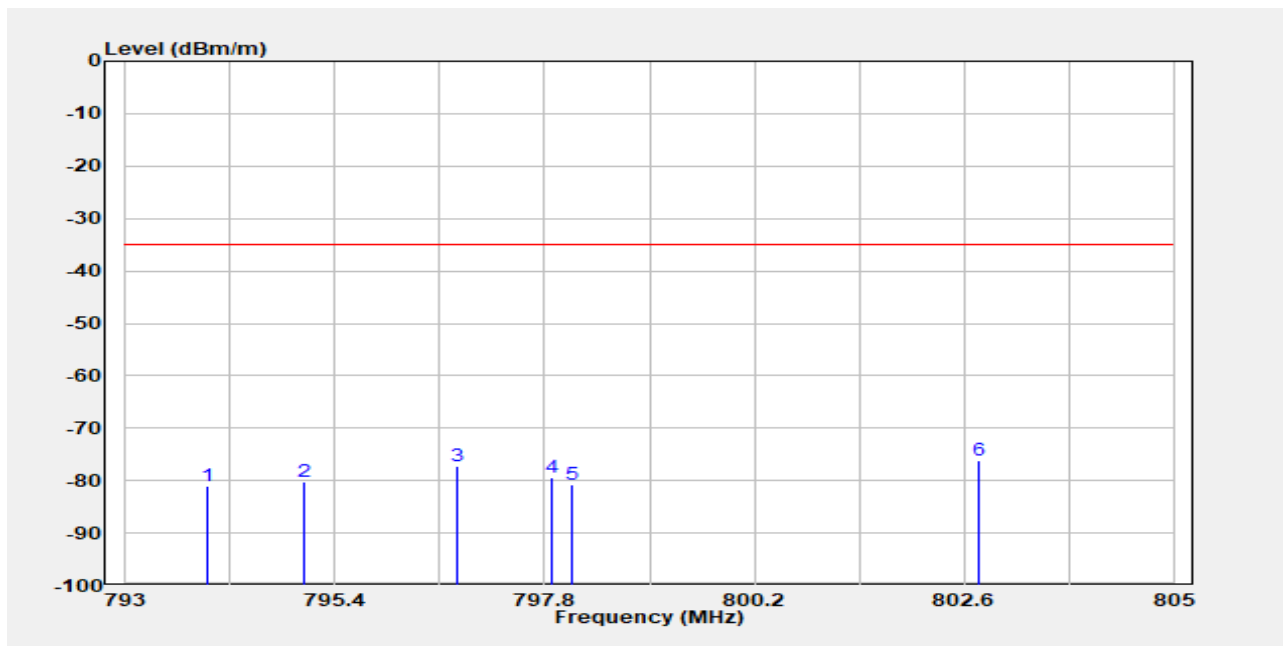

Freq. MHz	EIRP/ERP dBm	SG Output Level dBm	Antenna Gain dBi/dBd	Cable Loss dB	Limit dBm	Margin dB
793.94	-81.12	-81.84	3.85	-3.13	-35.00	-46.12
795.04	-80.28	-81.03	3.89	-3.13	-35.00	-45.28
796.80	-77.13	-77.94	3.94	-3.13	-35.00	-42.13
797.88	-79.43	-80.27	3.98	-3.13	-35.00	-44.43
798.12	-80.85	-81.70	3.98	-3.13	-35.00	-45.85
802.78	-76.16	-77.18	4.13	-3.11	-35.00	-41.16

Unless otherwise stated the results shown in this test report refer only to the sample(s) tested and such sample(s) are retained for 90 days only.

除非另有說明，此報告結果僅對測試之樣品負責，同時此樣品僅保留90天。本報告未經本公司書面許可，不可部份複製。

This document is issued by the Company subject to its General Conditions of Service printed overleaf, available on request or accessible at <http://www.sgs.com.tw/Terms-and-Conditions> and for electronic format documents, subject to Terms and Conditions for Electronic Documents at <http://www.sgs.com.tw/Terms-and-Conditions>. Attention is drawn to the limitation of liability, indemnification and jurisdiction issues defined therein. Any holder of this document is advised that information contained hereon reflects the Company's findings at the time of its intervention only and within the limits of Client's instructions, if any. The Company's sole responsibility is to its Client and this document does not exonerate parties to a transaction from exercising all their rights and obligations under the transaction documents. This document cannot be reproduced except in full, without prior written approval of the Company. Any unauthorized alteration, forgery or falsification of the content or appearance of this document is unlawful and offenders may be prosecuted to the fullest extent of the law.

Report Number :ER/2021/A0027
 Operation Mode :LTE B13
 Test Mode :Tx CH Low
 EUT Pol :H Plane
 Test Frequency :779.5 MHz

Test Site :SAC 1
 Test Date :2021-11-12
 Temp./Humi. :23.8/53
 Antenna Pol. :Horizontal
 Engineer :GN Lin

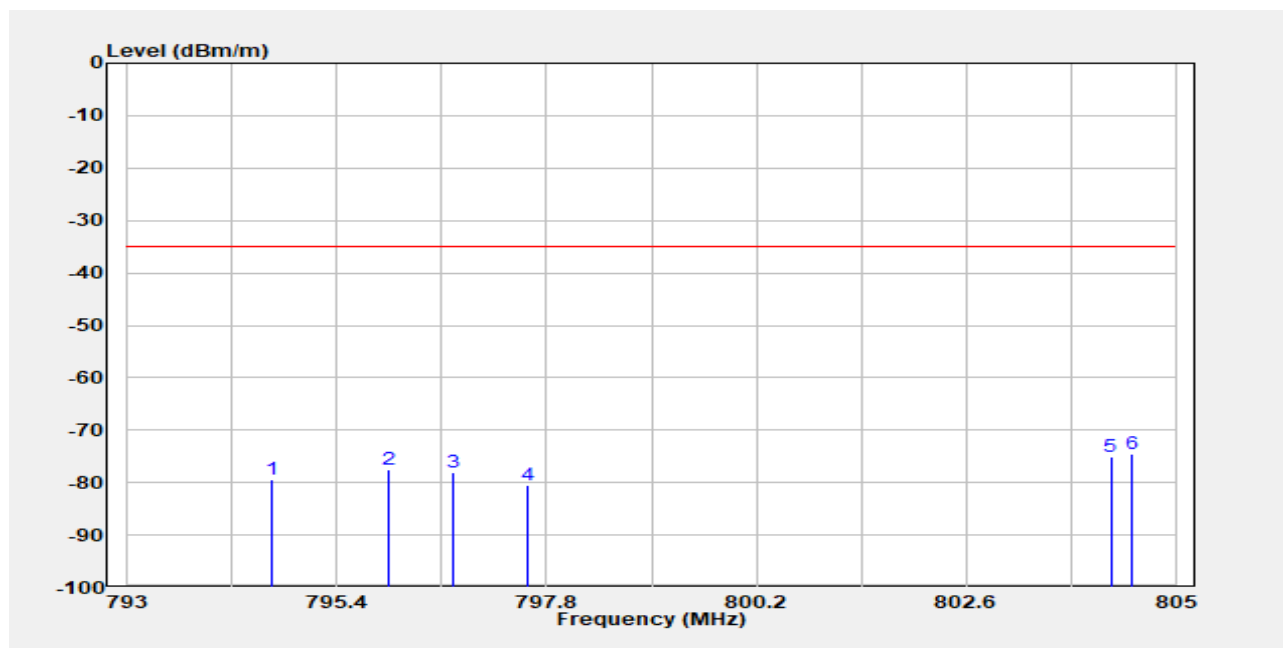

Freq. MHz	EIRP/ERP dBm	SG Output Level dBm	Antenna Gain dBi/dBd	Cable Loss dB	Limit dBm	Margin dB
794.66	-79.40	-80.15	3.88	-3.13	-35.00	-44.40
795.98	-77.52	-78.31	3.92	-3.13	-35.00	-42.52
796.72	-78.08	-78.88	3.94	-3.13	-35.00	-43.08
797.58	-80.48	-81.32	3.97	-3.13	-35.00	-45.48
804.26	-75.10	-76.17	4.17	-3.10	-35.00	-40.10
804.50	-74.55	-75.63	4.18	-3.10	-35.00	-39.55

Unless otherwise stated the results shown in this test report refer only to the sample(s) tested and such sample(s) are retained for 90 days only.

除非另有說明，此報告結果僅對測試之樣品負責，同時此樣品僅保留90天。本報告未經本公司書面許可，不可部份複製。

This document is issued by the Company subject to its General Conditions of Service printed overleaf, available on request or accessible at <http://www.sgs.com.tw/Terms-and-Conditions> and for electronic format documents, subject to Terms and Conditions for Electronic Documents at <http://www.sgs.com.tw/Terms-and-Conditions>. Attention is drawn to the limitation of liability, indemnification and jurisdiction issues defined therein. Any holder of this document is advised that information contained hereon reflects the Company's findings at the time of its intervention only and within the limits of Client's instructions, if any. The Company's sole responsibility is to its Client and this document does not exonerate parties to a transaction from exercising all their rights and obligations under the transaction documents. This document cannot be reproduced except in full, without prior written approval of the Company. Any unauthorized alteration, forgery or falsification of the content or appearance of this document is unlawful and offenders may be prosecuted to the fullest extent of the law.

Report Number :ER/2021/A0027
 Operation Mode :LTE B13
 Test Mode :Tx CH Mid
 EUT Pol :H Plane
 Test Frequency :782 MHz

Test Site :SAC 1
 Test Date :2021-11-12
 Temp./Humi. :23.8/53
 Antenna Pol. :Vertical
 Engineer :GN Lin

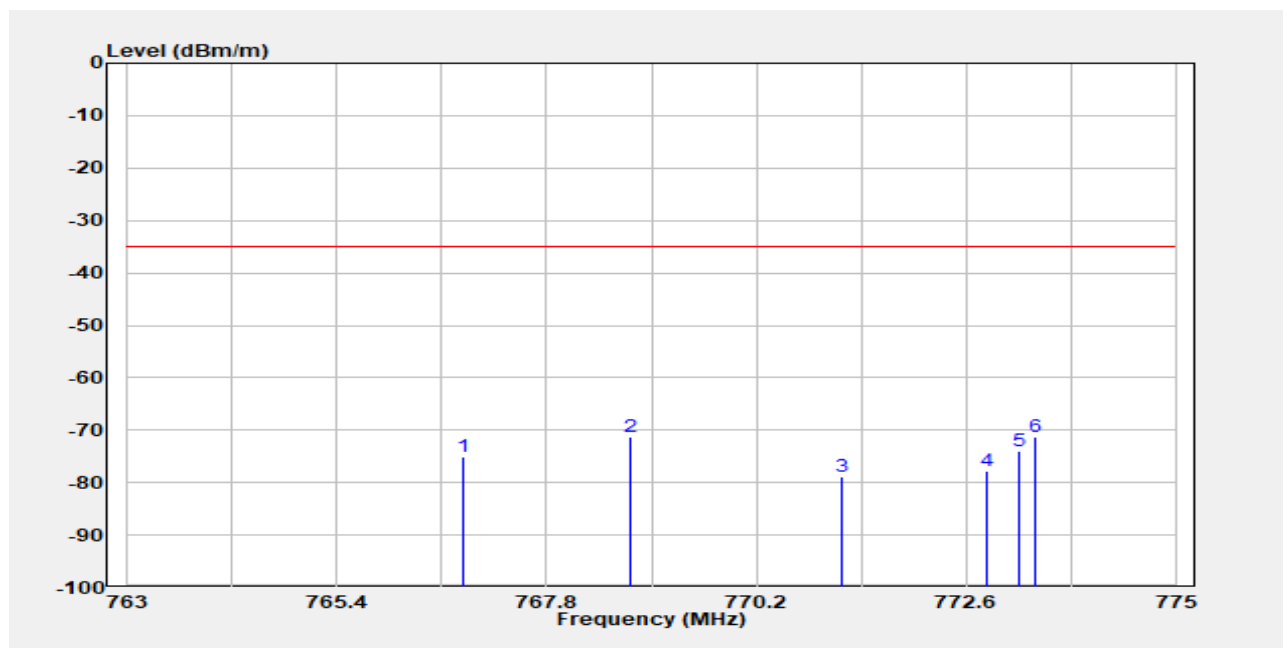

Freq. MHz	EIRP/ERP dBm	SG Output Level dBm	Antenna Gain dBi/dBd	Cable Loss dB	Limit dBm	Margin dB
766.84	-74.95	-75.22	3.07	-2.81	-35.00	-39.95
768.76	-71.20	-71.39	3.10	-2.91	-35.00	-36.20
771.18	-78.83	-78.97	3.12	-2.98	-35.00	-43.83
772.84	-77.89	-78.03	3.14	-3.00	-35.00	-42.89
773.20	-74.04	-74.18	3.15	-3.00	-35.00	-39.04
773.40	-71.29	-71.44	3.15	-3.00	-35.00	-36.29

Unless otherwise stated the results shown in this test report refer only to the sample(s) tested and such sample(s) are retained for 90 days only.

除非另有說明，此報告結果僅對測試之樣品負責，同時此樣品僅保留90天。本報告未經本公司書面許可，不可部份複製。

This document is issued by the Company subject to its General Conditions of Service printed overleaf, available on request or accessible at <http://www.sgs.com.tw/Terms-and-Conditions> and for electronic format documents, subject to Terms and Conditions for Electronic Documents at <http://www.sgs.com.tw/Terms-and-Conditions>. Attention is drawn to the limitation of liability, indemnification and jurisdiction issues defined therein. Any holder of this document is advised that information contained hereon reflects the Company's findings at the time of its intervention only and within the limits of Client's instructions, if any. The Company's sole responsibility is to its Client and this document does not exonerate parties to a transaction from exercising all their rights and obligations under the transaction documents. This document cannot be reproduced except in full, without prior written approval of the Company. Any unauthorized alteration, forgery or falsification of the content or appearance of this document is unlawful and offenders may be prosecuted to the fullest extent of the law.

Report Number :ER/2021/A0027
 Operation Mode :LTE B13
 Test Mode :Tx CH Mid
 EUT Pol :H Plane
 Test Frequency :782 MHz

Test Site :SAC 1
 Test Date :2021-11-12
 Temp./Humi. :23.8/53
 Antenna Pol. :Horizontal
 Engineer :GN Lin

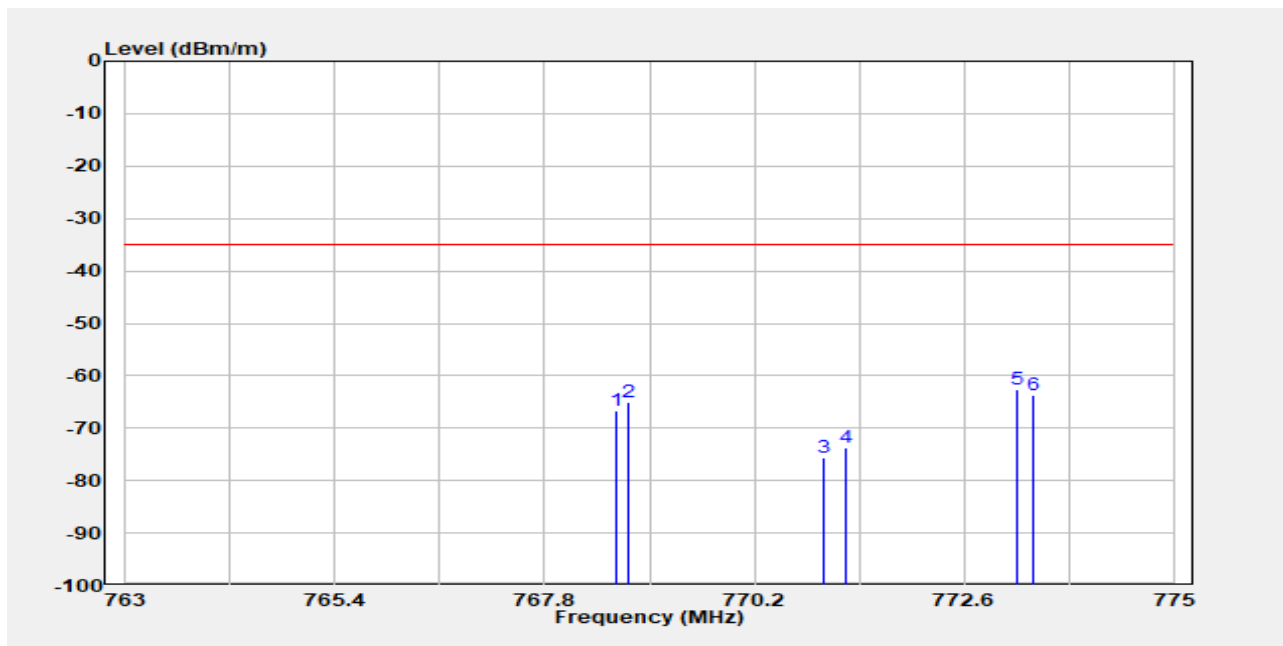

Freq. MHz	EIRP/ERP dBm	SG Output Level dBm	Antenna Gain dBi/dBd	Cable Loss dB	Limit dBm	Margin dB
768.62	-66.71	-66.90	3.09	-2.90	-35.00	-31.71
768.76	-64.96	-65.15	3.10	-2.91	-35.00	-29.96
771.00	-75.71	-75.85	3.12	-2.98	-35.00	-40.71
771.26	-73.85	-73.99	3.12	-2.98	-35.00	-38.85
773.20	-62.71	-62.86	3.15	-3.00	-35.00	-27.71
773.40	-63.78	-63.92	3.15	-3.00	-35.00	-28.78

Unless otherwise stated the results shown in this test report refer only to the sample(s) tested and such sample(s) are retained for 90 days only.

除非另有說明，此報告結果僅對測試之樣品負責，同時此樣品僅保留90天。本報告未經本公司書面許可，不可部份複製。

This document is issued by the Company subject to its General Conditions of Service printed overleaf, available on request or accessible at <http://www.sgs.com.tw/Terms-and-Conditions> and for electronic format documents, subject to Terms and Conditions for Electronic Documents at <http://www.sgs.com.tw/Terms-and-Conditions>. Attention is drawn to the limitation of liability, indemnification and jurisdiction issues defined therein. Any holder of this document is advised that information contained hereon reflects the Company's findings at the time of its intervention only and within the limits of Client's instructions, if any. The Company's sole responsibility is to its Client and this document does not exonerate parties to a transaction from exercising all their rights and obligations under the transaction documents. This document cannot be reproduced except in full, without prior written approval of the Company. Any unauthorized alteration, forgery or falsification of the content or appearance of this document is unlawful and offenders may be prosecuted to the fullest extent of the law.

Report Number :ER/2021/A0027
 Operation Mode :LTE B13
 Test Mode :Tx CH Mid
 EUT Pol :H Plane
 Test Frequency :782 MHz

Test Site :SAC 1
 Test Date :2021-11-12
 Temp./Humi. :23.8/53
 Antenna Pol. :Vertical
 Engineer :GN Lin

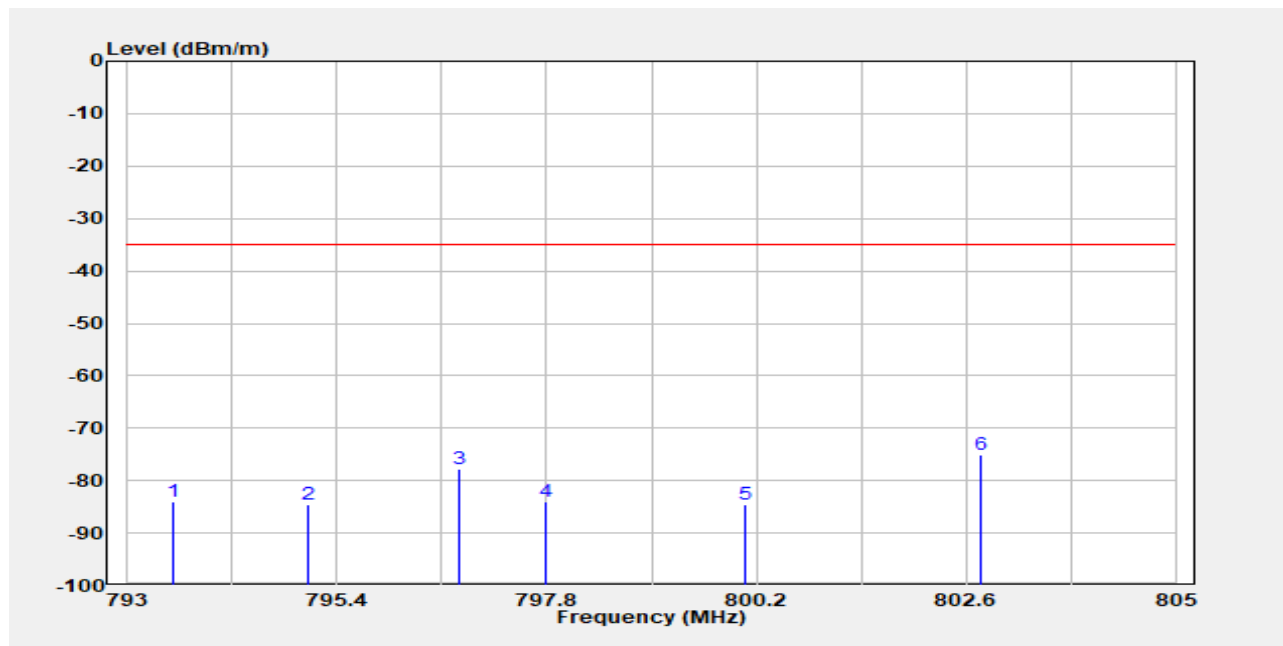

Freq. MHz	EIRP/ERP dBm	SG Output Level dBm	Antenna Gain dBi/dBd	Cable Loss dB	Limit dBm	Margin dB
793.52	-84.11	-84.81	3.84	-3.13	-35.00	-49.11
795.06	-84.46	-85.22	3.89	-3.13	-35.00	-49.46
796.80	-77.90	-78.71	3.94	-3.13	-35.00	-42.90
797.80	-84.00	-84.85	3.97	-3.13	-35.00	-49.00
800.08	-84.56	-85.48	4.04	-3.13	-35.00	-49.56
802.78	-74.96	-75.97	4.13	-3.11	-35.00	-39.96

Unless otherwise stated the results shown in this test report refer only to the sample(s) tested and such sample(s) are retained for 90 days only.

除非另有說明，此報告結果僅對測試之樣品負責，同時此樣品僅保留90天。本報告未經本公司書面許可，不可部份複製。

This document is issued by the Company subject to its General Conditions of Service printed overleaf, available on request or accessible at <http://www.sgs.com.tw/Terms-and-Conditions> and for electronic format documents, subject to Terms and Conditions for Electronic Documents at <http://www.sgs.com.tw/Terms-and-Conditions>. Attention is drawn to the limitation of liability, indemnification and jurisdiction issues defined therein. Any holder of this document is advised that information contained hereon reflects the Company's findings at the time of its intervention only and within the limits of Client's instructions, if any. The Company's sole responsibility is to its Client and this document does not exonerate parties to a transaction from exercising all their rights and obligations under the transaction documents. This document cannot be reproduced except in full, without prior written approval of the Company. Any unauthorized alteration, forgery or falsification of the content or appearance of this document is unlawful and offenders may be prosecuted to the fullest extent of the law.

Report Number :ER/2021/A0027
 Operation Mode :LTE B13
 Test Mode :Tx CH Mid
 EUT Pol :H Plane
 Test Frequency :782 MHz

Test Site :SAC 1
 Test Date :2021-11-12
 Temp./Humi. :23.8/53
 Antenna Pol. :Horizontal
 Engineer :GN Lin

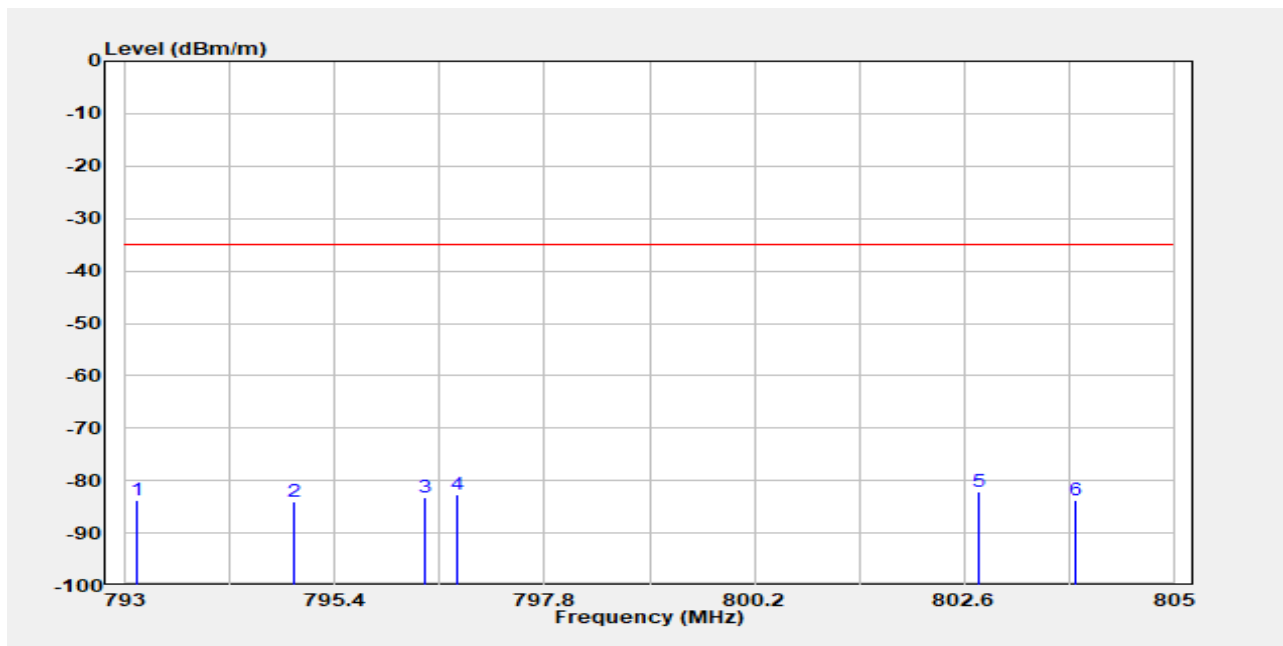

Freq. MHz	EIRP/ERP dBm	SG Output Level dBm	Antenna Gain dBi/dBd	Cable Loss dB	Limit dBm	Margin dB
793.14	-83.86	-84.55	3.83	-3.13	-35.00	-48.86
794.92	-84.05	-84.81	3.88	-3.13	-35.00	-49.05
796.42	-83.33	-84.13	3.93	-3.13	-35.00	-48.33
796.80	-82.73	-83.54	3.94	-3.13	-35.00	-47.73
802.78	-82.20	-83.22	4.13	-3.11	-35.00	-47.20
803.88	-83.71	-84.77	4.16	-3.10	-35.00	-48.71

Unless otherwise stated the results shown in this test report refer only to the sample(s) tested and such sample(s) are retained for 90 days only.

除非另有說明，此報告結果僅對測試之樣品負責，同時此樣品僅保留90天。本報告未經本公司書面許可，不可部份複製。

This document is issued by the Company subject to its General Conditions of Service printed overleaf, available on request or accessible at <http://www.sgs.com.tw/Terms-and-Conditions> and for electronic format documents, subject to Terms and Conditions for Electronic Documents at <http://www.sgs.com.tw/Terms-and-Conditions>. Attention is drawn to the limitation of liability, indemnification and jurisdiction issues defined therein. Any holder of this document is advised that information contained hereon reflects the Company's findings at the time of its intervention only and within the limits of Client's instructions, if any. The Company's sole responsibility is to its Client and this document does not exonerate parties to a transaction from exercising all their rights and obligations under the transaction documents. This document cannot be reproduced except in full, without prior written approval of the Company. Any unauthorized alteration, forgery or falsification of the content or appearance of this document is unlawful and offenders may be prosecuted to the fullest extent of the law.

Report Number :ER/2021/A0027
 Operation Mode :LTE B13
 Test Mode :Tx CH High
 EUT Pol :H Plane
 Test Frequency :784.5 MHz

Test Site :SAC 1
 Test Date :2021-11-12
 Temp./Humi. :23.8/53
 Antenna Pol. :Vertical
 Engineer :GN Lin

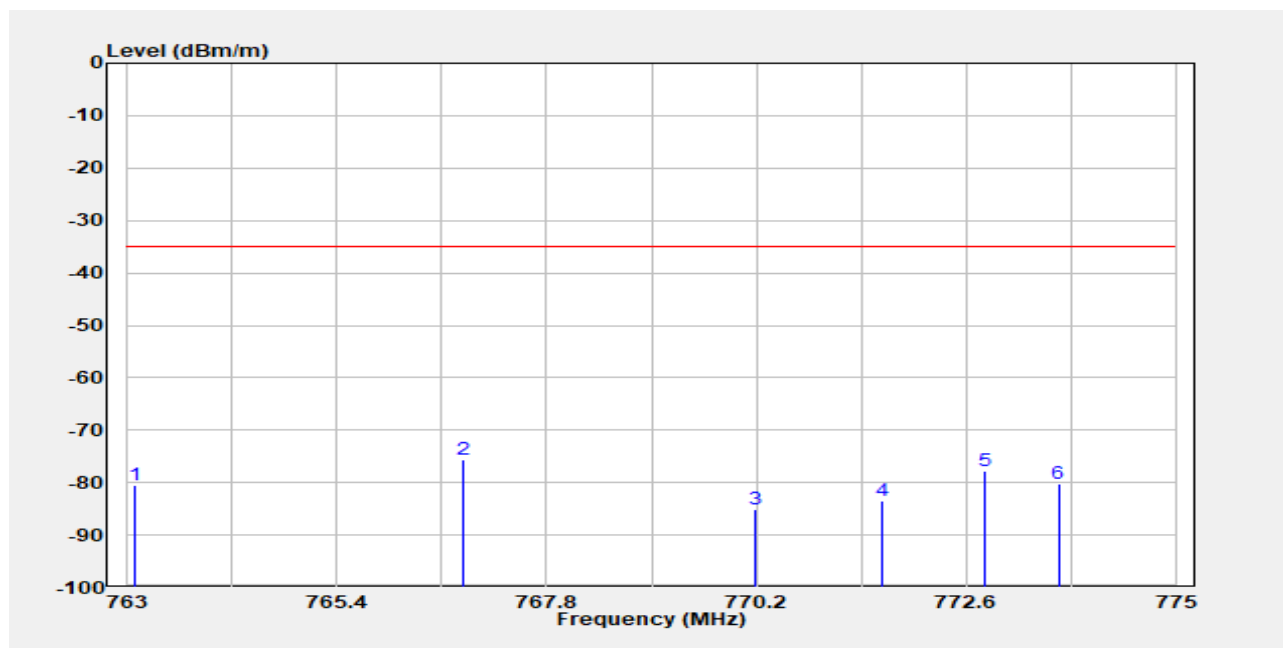

Freq. MHz	EIRP/ERP dBm	SG Output Level dBm	Antenna Gain dBi/dBd	Cable Loss dB	Limit dBm	Margin dB
763.08	-80.55	-80.97	3.03	-2.62	-35.00	-45.55
766.84	-75.64	-75.90	3.07	-2.81	-35.00	-40.64
770.18	-85.16	-85.30	3.11	-2.97	-35.00	-50.16
771.64	-83.56	-83.70	3.13	-2.99	-35.00	-48.56
772.82	-77.69	-77.83	3.14	-3.00	-35.00	-42.69
773.66	-80.15	-80.29	3.15	-3.00	-35.00	-45.15

Unless otherwise stated the results shown in this test report refer only to the sample(s) tested and such sample(s) are retained for 90 days only.

除非另有說明，此報告結果僅對測試之樣品負責，同時此樣品僅保留90天。本報告未經本公司書面許可，不可部份複製。

This document is issued by the Company subject to its General Conditions of Service printed overleaf, available on request or accessible at <http://www.sgs.com.tw/Terms-and-Conditions> and for electronic format documents, subject to Terms and Conditions for Electronic Documents at <http://www.sgs.com.tw/Terms-and-Conditions>. Attention is drawn to the limitation of liability, indemnification and jurisdiction issues defined therein. Any holder of this document is advised that information contained hereon reflects the Company's findings at the time of its intervention only and within the limits of Client's instructions, if any. The Company's sole responsibility is to its Client and this document does not exonerate parties to a transaction from exercising all their rights and obligations under the transaction documents. This document cannot be reproduced except in full, without prior written approval of the Company. Any unauthorized alteration, forgery or falsification of the content or appearance of this document is unlawful and offenders may be prosecuted to the fullest extent of the law.

Report Number :ER/2021/A0027
 Operation Mode :LTE B13
 Test Mode :Tx CH High
 EUT Pol :H Plane
 Test Frequency :784.5 MHz

Test Site :SAC 1
 Test Date :2021-11-12
 Temp./Humi. :23.8/53
 Antenna Pol. :Horizontal
 Engineer :GN Lin

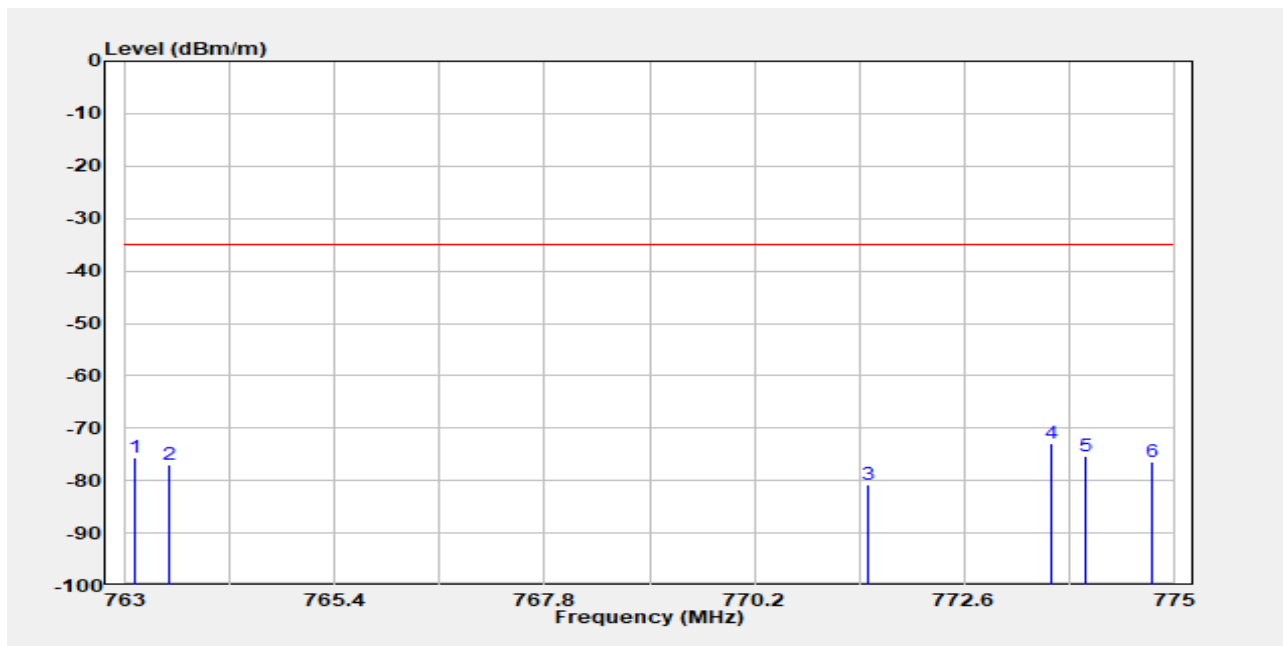

Freq. MHz	EIRP/ERP dBm	SG Output Level dBm	Antenna Gain dBi/dBd	Cable Loss dB	Limit dBm	Margin dB
763.10	-75.51	-75.93	3.03	-2.62	-35.00	-40.51
763.50	-77.01	-77.41	3.04	-2.64	-35.00	-42.01
771.50	-80.70	-80.84	3.13	-2.98	-35.00	-45.70
773.60	-72.82	-72.96	3.15	-3.00	-35.00	-37.82
774.00	-75.40	-75.55	3.15	-3.01	-35.00	-40.40
774.76	-76.31	-76.46	3.16	-3.02	-35.00	-41.31

Unless otherwise stated the results shown in this test report refer only to the sample(s) tested and such sample(s) are retained for 90 days only.

除非另有說明，此報告結果僅對測試之樣品負責，同時此樣品僅保留90天。本報告未經本公司書面許可，不可部份複製。

This document is issued by the Company subject to its General Conditions of Service printed overleaf, available on request or accessible at <http://www.sgs.com.tw/Terms-and-Conditions> and for electronic format documents, subject to Terms and Conditions for Electronic Documents at <http://www.sgs.com.tw/Terms-and-Conditions>. Attention is drawn to the limitation of liability, indemnification and jurisdiction issues defined therein. Any holder of this document is advised that information contained hereon reflects the Company's findings at the time of its intervention only and within the limits of Client's instructions, if any. The Company's sole responsibility is to its Client and this document does not exonerate parties to a transaction from exercising all their rights and obligations under the transaction documents. This document cannot be reproduced except in full, without prior written approval of the Company. Any unauthorized alteration, forgery or falsification of the content or appearance of this document is unlawful and offenders may be prosecuted to the fullest extent of the law.

Report Number :ER/2021/A0027
 Operation Mode :LTE B13
 Test Mode :Tx CH High
 EUT Pol :H Plane
 Test Frequency :784.5 MHz

Test Site :SAC 1
 Test Date :2021-11-12
 Temp./Humi. :23.8/53
 Antenna Pol. :Vertical
 Engineer :GN Lin

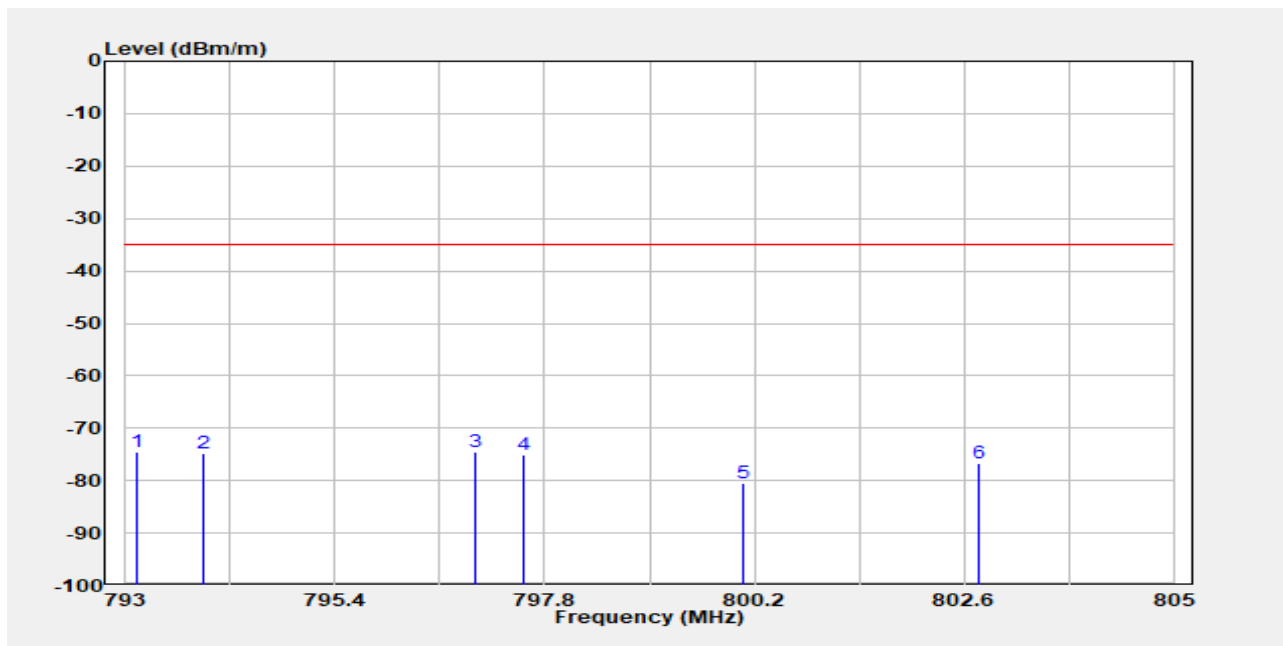

Freq. MHz	EIRP/ERP dBm	SG Output Level dBm	Antenna Gain dBi/dBd	Cable Loss dB	Limit dBm	Margin dB
793.12	-74.41	-75.11	3.83	-3.13	-35.00	-39.41
793.88	-74.74	-75.45	3.85	-3.13	-35.00	-39.74
797.00	-74.48	-75.30	3.95	-3.13	-35.00	-39.48
797.56	-75.04	-75.88	3.97	-3.13	-35.00	-40.04
800.08	-80.43	-81.34	4.04	-3.13	-35.00	-45.43
802.78	-76.79	-77.81	4.13	-3.11	-35.00	-41.79

Unless otherwise stated the results shown in this test report refer only to the sample(s) tested and such sample(s) are retained for 90 days only.

除非另有說明，此報告結果僅對測試之樣品負責，同時此樣品僅保留90天。本報告未經本公司書面許可，不可部份複製。

This document is issued by the Company subject to its General Conditions of Service printed overleaf, available on request or accessible at <http://www.sgs.com.tw/Terms-and-Conditions> and for electronic format documents, subject to Terms and Conditions for Electronic Documents at <http://www.sgs.com.tw/Terms-and-Conditions>. Attention is drawn to the limitation of liability, indemnification and jurisdiction issues defined therein. Any holder of this document is advised that information contained hereon reflects the Company's findings at the time of its intervention only and within the limits of Client's instructions, if any. The Company's sole responsibility is to its Client and this document does not exonerate parties to a transaction from exercising all their rights and obligations under the transaction documents. This document cannot be reproduced except in full, without prior written approval of the Company. Any unauthorized alteration, forgery or falsification of the content or appearance of this document is unlawful and offenders may be prosecuted to the fullest extent of the law.

Report Number :ER/2021/A0027
 Operation Mode :LTE B13
 Test Mode :Tx CH High
 EUT Pol :H Plane
 Test Frequency :784.5 MHz

Test Site :SAC 1
 Test Date :2021-11-12
 Temp./Humi. :23.8/53
 Antenna Pol. :Horizontal
 Engineer :GN Lin

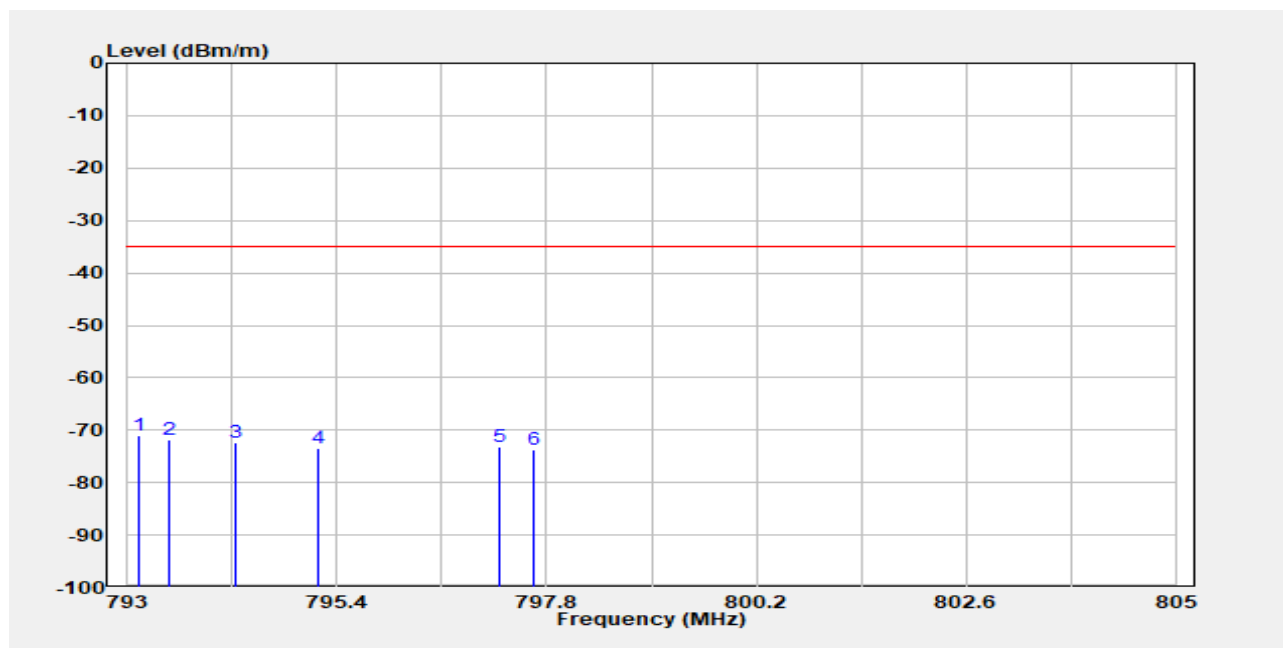

Freq. MHz	EIRP/ERP dBm	SG Output Level dBm	Antenna Gain dBi/dBd	Cable Loss dB	Limit dBm	Margin dB
793.14	-71.07	-71.76	3.83	-3.13	-35.00	-36.07
793.48	-71.91	-72.62	3.84	-3.13	-35.00	-36.91
794.24	-72.38	-73.11	3.86	-3.13	-35.00	-37.38
795.18	-73.32	-74.08	3.89	-3.13	-35.00	-38.32
797.26	-73.19	-74.02	3.96	-3.13	-35.00	-38.19
797.66	-73.63	-74.47	3.97	-3.13	-35.00	-38.63

Unless otherwise stated the results shown in this test report refer only to the sample(s) tested and such sample(s) are retained for 90 days only.

除非另有說明，此報告結果僅對測試之樣品負責，同時此樣品僅保留90天。本報告未經本公司書面許可，不可部份複製。

This document is issued by the Company subject to its General Conditions of Service printed overleaf, available on request or accessible at <http://www.sgs.com.tw/Terms-and-Conditions> and for electronic format documents, subject to Terms and Conditions for Electronic Documents at <http://www.sgs.com.tw/Terms-and-Conditions>. Attention is drawn to the limitation of liability, indemnification and jurisdiction issues defined therein. Any holder of this document is advised that information contained hereon reflects the Company's findings at the time of its intervention only and within the limits of Client's instructions, if any. The Company's sole responsibility is to its Client and this document does not exonerate parties to a transaction from exercising all their rights and obligations under the transaction documents. This document cannot be reproduced except in full, without prior written approval of the Company. Any unauthorized alteration, forgery or falsification of the content or appearance of this document is unlawful and offenders may be prosecuted to the fullest extent of the law.

Report Number :ER/2021/A0027
 Operation Mode :LTE B14
 Test Mode :Tx CH Low
 EUT Pol :H Plane
 Test Frequency :790.5 MHz

Test Site :SAC 1
 Test Date :2021-11-12
 Temp./Humi. :23.8/53
 Antenna Pol. :Vertical
 Engineer :GN Lin

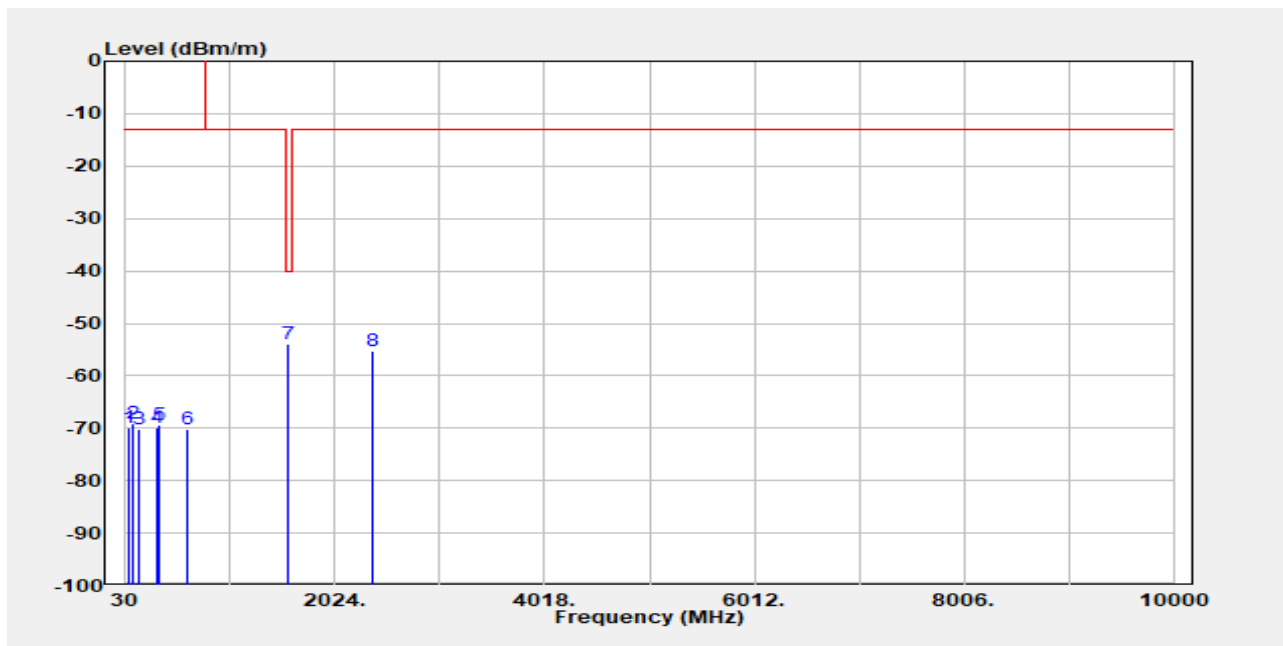

Freq. MHz	EIRP/ERP dBm	SG Output Level dBm	Antenna Gain dBi/dBd	Cable Loss dB	Limit dBm	Margin dB
62.33	-69.90	-60.32	-8.83	-0.76	-13.00	-56.90
101.13	-69.21	-67.32	-0.88	-1.02	-13.00	-56.21
164.18	-70.32	-68.19	-0.88	-1.26	-13.00	-57.32
335.55	-69.81	-72.20	4.28	-1.90	-13.00	-56.81
348.48	-69.40	-71.91	4.52	-2.01	-13.00	-56.40
610.38	-70.32	-71.31	3.48	-2.50	-13.00	-57.32
1581.00	-54.02	-59.17	9.29	-4.14	-40.00	-14.01
2371.50	-55.38	-60.15	9.82	-5.06	-13.00	-42.37

Unless otherwise stated the results shown in this test report refer only to the sample(s) tested and such sample(s) are retained for 90 days only.

除非另有說明，此報告結果僅對測試之樣品負責，同時此樣品僅保留90天。本報告未經本公司書面許可，不可部份複製。

This document is issued by the Company subject to its General Conditions of Service printed overleaf, available on request or accessible at <http://www.sgs.com.tw/Terms-and-Conditions> and for electronic format documents, subject to Terms and Conditions for Electronic Documents at <http://www.sgs.com.tw/Terms-and-Conditions>. Attention is drawn to the limitation of liability, indemnification and jurisdiction issues defined therein. Any holder of this document is advised that information contained hereon reflects the Company's findings at the time of its intervention only and within the limits of Client's instructions, if any. The Company's sole responsibility is to its Client and this document does not exonerate parties to a transaction from exercising all their rights and obligations under the transaction documents. This document cannot be reproduced except in full, without prior written approval of the Company. Any unauthorized alteration, forgery or falsification of the content or appearance of this document is unlawful and offenders may be prosecuted to the fullest extent of the law.

Report Number :ER/2021/A0027
 Operation Mode :LTE B14
 Test Mode :Tx CH Low
 EUT Pol :H Plane
 Test Frequency :790.5 MHz

Test Site :SAC 1
 Test Date :2021-11-12
 Temp./Humi. :23.8/53
 Antenna Pol. :Horizontal
 Engineer :GN Lin

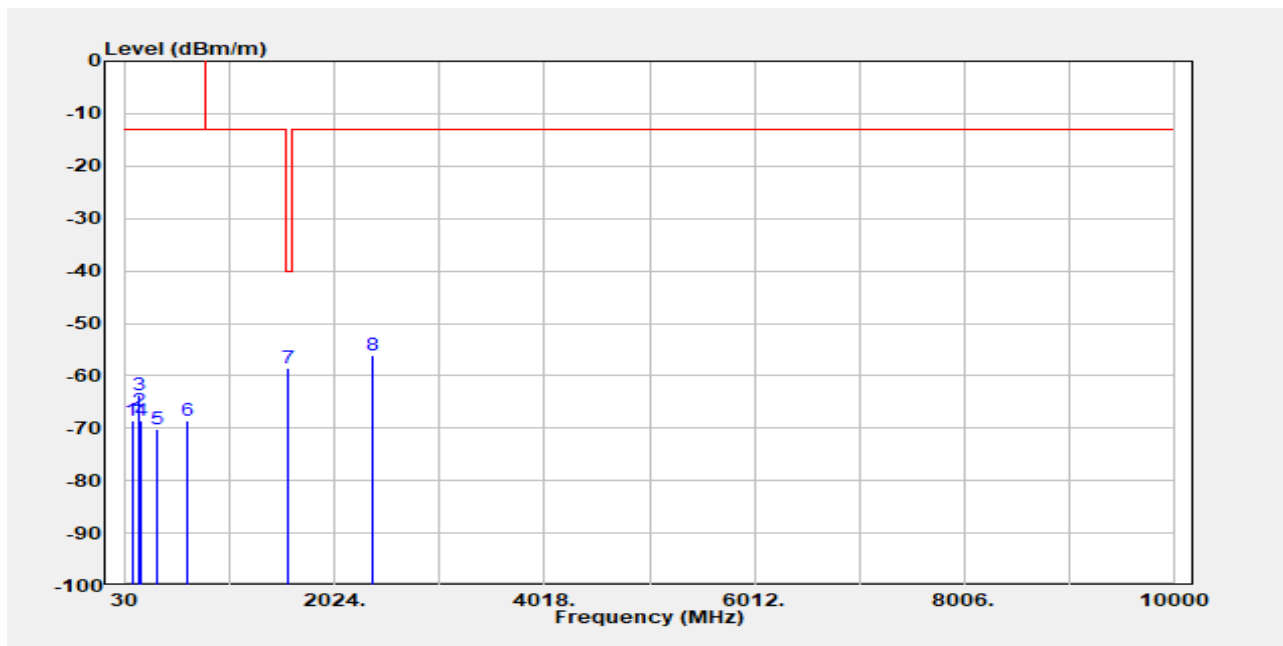

Freq. MHz	EIRP/ERP dBm	SG Output Level dBm	Antenna Gain dBi/dBd	Cable Loss dB	Limit dBm	Margin dB
89.82	-68.61	-67.20	-0.43	-0.98	-13.00	-55.61
149.63	-66.69	-63.92	-1.62	-1.15	-13.00	-53.69
164.18	-63.80	-61.67	-0.88	-1.26	-13.00	-50.80
181.97	-68.56	-69.05	1.87	-1.39	-13.00	-55.56
335.55	-70.22	-72.61	4.28	-1.90	-13.00	-57.22
610.38	-68.63	-69.62	3.48	-2.50	-13.00	-55.63
1581.00	-58.65	-63.79	9.29	-4.14	-40.00	-18.64
2371.50	-56.02	-60.78	9.82	-5.06	-13.00	-43.01

Unless otherwise stated the results shown in this test report refer only to the sample(s) tested and such sample(s) are retained for 90 days only.

除非另有說明，此報告結果僅對測試之樣品負責，同時此樣品僅保留90天。本報告未經本公司書面許可，不可部份複製。

This document is issued by the Company subject to its General Conditions of Service printed overleaf, available on request or accessible at <http://www.sgs.com.tw/Terms-and-Conditions> and for electronic format documents, subject to Terms and Conditions for Electronic Documents at <http://www.sgs.com.tw/Terms-and-Conditions>. Attention is drawn to the limitation of liability, indemnification and jurisdiction issues defined therein. Any holder of this document is advised that information contained hereon reflects the Company's findings at the time of its intervention only and within the limits of Client's instructions, if any. The Company's sole responsibility is to its Client and this document does not exonerate parties to a transaction from exercising all their rights and obligations under the transaction documents. This document cannot be reproduced except in full, without prior written approval of the Company. Any unauthorized alteration, forgery or falsification of the content or appearance of this document is unlawful and offenders may be prosecuted to the fullest extent of the law.

Report Number :ER/2021/A0027
 Operation Mode :LTE B14
 Test Mode :Tx CH Mid
 EUT Pol :H Plane
 Test Frequency :793 MHz

Test Site :SAC 1
 Test Date :2021-11-12
 Temp./Humi. :23.8/53
 Antenna Pol. :Vertical
 Engineer :GN Lin

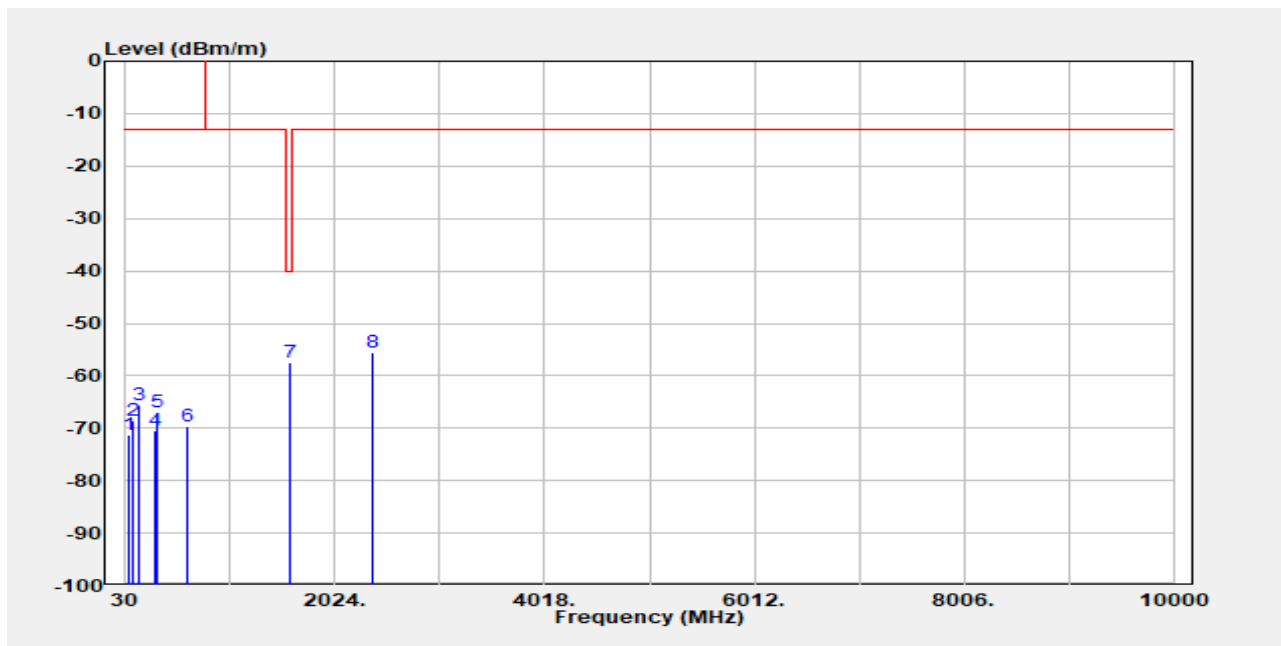

Freq. MHz	EIRP/ERP dBm	SG Output Level dBm	Antenna Gain dBi/dBd	Cable Loss dB	Limit dBm	Margin dB
62.33	-71.14	-61.56	-8.83	-0.76	-13.00	-58.14
107.60	-68.51	-66.04	-1.42	-1.04	-13.00	-55.51
149.63	-65.67	-62.90	-1.62	-1.15	-13.00	-52.67
311.30	-70.56	-73.01	4.19	-1.74	-13.00	-57.56
335.55	-66.87	-69.26	4.28	-1.90	-13.00	-53.87
610.38	-69.72	-70.71	3.48	-2.50	-13.00	-56.72
1586.00	-57.57	-62.74	9.32	-4.15	-40.00	-17.56
2379.00	-55.51	-60.33	9.89	-5.07	-13.00	-42.50

Unless otherwise stated the results shown in this test report refer only to the sample(s) tested and such sample(s) are retained for 90 days only.

除非另有說明，此報告結果僅對測試之樣品負責，同時此樣品僅保留90天。本報告未經本公司書面許可，不可部份複製。

This document is issued by the Company subject to its General Conditions of Service printed overleaf, available on request or accessible at <http://www.sgs.com.tw/Terms-and-Conditions> and for electronic format documents, subject to Terms and Conditions for Electronic Documents at <http://www.sgs.com.tw/Terms-and-Conditions>. Attention is drawn to the limitation of liability, indemnification and jurisdiction issues defined therein. Any holder of this document is advised that information contained hereon reflects the Company's findings at the time of its intervention only and within the limits of Client's instructions, if any. The Company's sole responsibility is to its Client and this document does not exonerate parties to a transaction from exercising all their rights and obligations under the transaction documents. This document cannot be reproduced except in full, without prior written approval of the Company. Any unauthorized alteration, forgery or falsification of the content or appearance of this document is unlawful and offenders may be prosecuted to the fullest extent of the law.

Report Number :ER/2021/A0027
 Operation Mode :LTE B14
 Test Mode :Tx CH Mid
 EUT Pol :H Plane
 Test Frequency :793 MHz

Test Site :SAC 1
 Test Date :2021-11-12
 Temp./Humi. :23.8/53
 Antenna Pol. :Horizontal
 Engineer :GN Lin

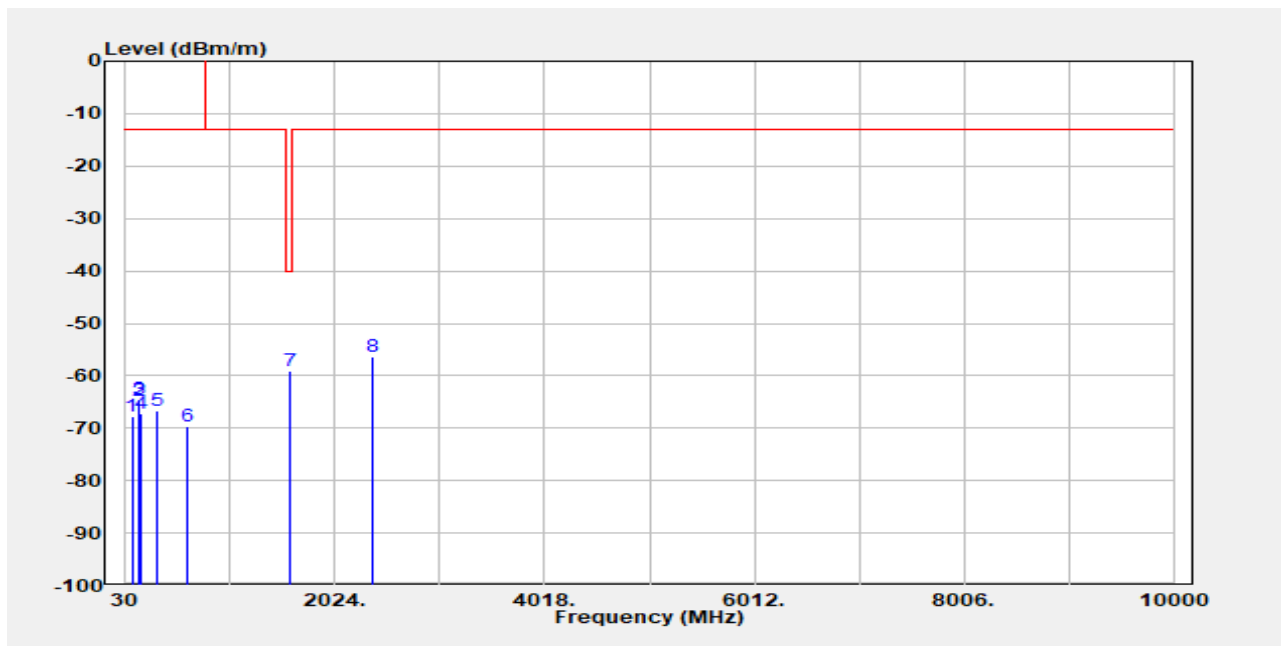

Freq. MHz	EIRP/ERP dBm	SG Output Level dBm	Antenna Gain dBi/dBd	Cable Loss dB	Limit dBm	Margin dB
89.82	-67.86	-66.45	-0.43	-0.98	-13.00	-54.86
149.63	-64.70	-61.93	-1.62	-1.15	-13.00	-51.70
164.18	-64.51	-62.38	-0.88	-1.26	-13.00	-51.51
181.97	-67.15	-67.63	1.87	-1.39	-13.00	-54.15
335.55	-66.54	-68.92	4.28	-1.90	-13.00	-53.54
610.38	-69.62	-70.60	3.48	-2.50	-13.00	-56.62
1586.00	-59.20	-64.36	9.32	-4.15	-40.00	-19.19
2379.00	-56.29	-61.11	9.89	-5.07	-13.00	-43.28

Unless otherwise stated the results shown in this test report refer only to the sample(s) tested and such sample(s) are retained for 90 days only.

除非另有說明，此報告結果僅對測試之樣品負責，同時此樣品僅保留90天。本報告未經本公司書面許可，不可部份複製。

This document is issued by the Company subject to its General Conditions of Service printed overleaf, available on request or accessible at <http://www.sgs.com.tw/Terms-and-Conditions> and for electronic format documents, subject to Terms and Conditions for Electronic Documents at <http://www.sgs.com.tw/Terms-and-Conditions>. Attention is drawn to the limitation of liability, indemnification and jurisdiction issues defined therein. Any holder of this document is advised that information contained hereon reflects the Company's findings at the time of its intervention only and within the limits of Client's instructions, if any. The Company's sole responsibility is to its Client and this document does not exonerate parties to a transaction from exercising all their rights and obligations under the transaction documents. This document cannot be reproduced except in full, without prior written approval of the Company. Any unauthorized alteration, forgery or falsification of the content or appearance of this document is unlawful and offenders may be prosecuted to the fullest extent of the law.

Report Number :ER/2021/A0027
 Operation Mode :LTE B14
 Test Mode :Tx CH High
 EUT Pol :H Plane
 Test Frequency :795.5 MHz

Test Site :SAC 1
 Test Date :2021-11-12
 Temp./Humi. :23.8/53
 Antenna Pol. :Vertical
 Engineer :GN Lin

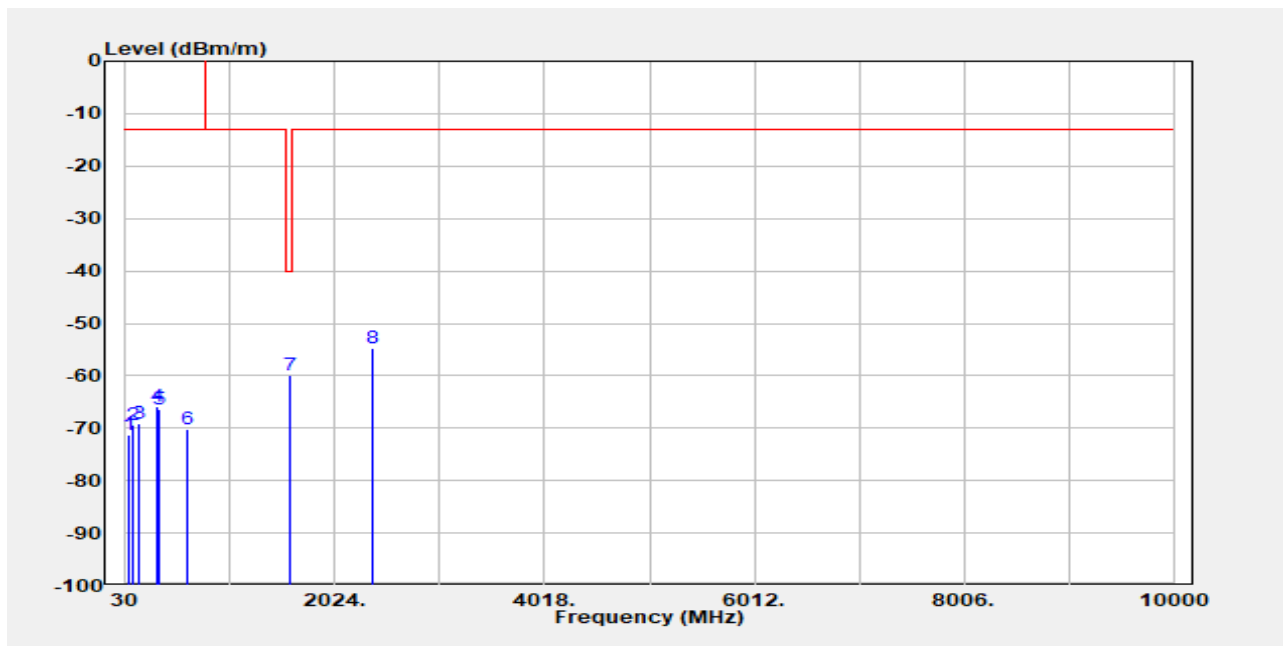

Freq. MHz	EIRP/ERP dBm	SG Output Level dBm	Antenna Gain dBi/dBd	Cable Loss dB	Limit dBm	Margin dB
60.72	-71.35	-61.22	-9.38	-0.74	-13.00	-58.35
107.60	-69.44	-66.97	-1.42	-1.04	-13.00	-56.44
149.63	-69.04	-66.27	-1.62	-1.15	-13.00	-56.04
335.55	-65.74	-68.12	4.28	-1.90	-13.00	-52.74
348.48	-66.35	-68.86	4.52	-2.01	-13.00	-53.35
610.38	-70.19	-71.17	3.48	-2.50	-13.00	-57.19
1591.00	-60.00	-65.18	9.35	-4.16	-40.00	-19.99
2386.50	-54.69	-59.57	9.97	-5.08	-13.00	-41.68

Unless otherwise stated the results shown in this test report refer only to the sample(s) tested and such sample(s) are retained for 90 days only.

除非另有說明，此報告結果僅對測試之樣品負責，同時此樣品僅保留90天。本報告未經本公司書面許可，不可部份複製。

This document is issued by the Company subject to its General Conditions of Service printed overleaf, available on request or accessible at <http://www.sgs.com.tw/Terms-and-Conditions> and for electronic format documents, subject to Terms and Conditions for Electronic Documents at <http://www.sgs.com.tw/Terms-and-Conditions>. Attention is drawn to the limitation of liability, indemnification and jurisdiction issues defined therein. Any holder of this document is advised that information contained hereon reflects the Company's findings at the time of its intervention only and within the limits of Client's instructions, if any. The Company's sole responsibility is to its Client and this document does not exonerate parties to a transaction from exercising all their rights and obligations under the transaction documents. This document cannot be reproduced except in full, without prior written approval of the Company. Any unauthorized alteration, forgery or falsification of the content or appearance of this document is unlawful and offenders may be prosecuted to the fullest extent of the law.

Report Number :ER/2021/A0027
 Operation Mode :LTE B14
 Test Mode :Tx CH High
 EUT Pol :H Plane
 Test Frequency :795.5 MHz

Test Site :SAC 1
 Test Date :2021-11-12
 Temp./Humi. :23.8/53
 Antenna Pol. :Horizontal
 Engineer :GN Lin

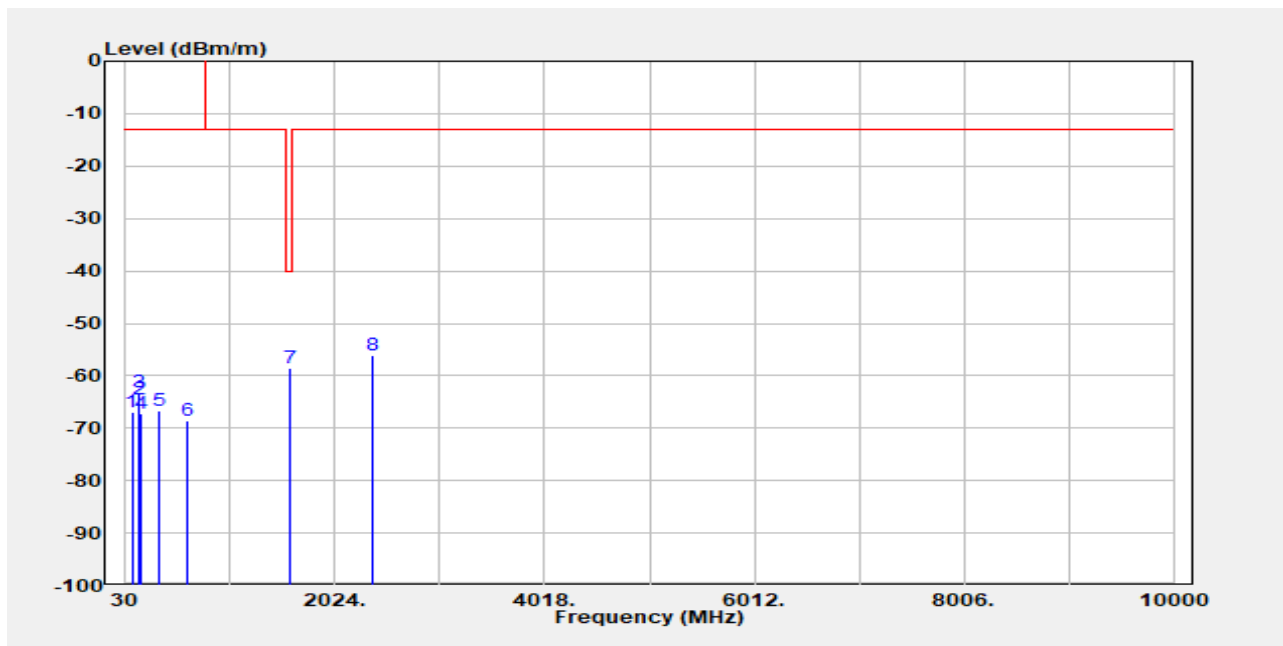

Freq. MHz	EIRP/ERP dBm	SG Output Level dBm	Antenna Gain dBi/dBd	Cable Loss dB	Limit dBm	Margin dB
89.82	-66.90	-65.49	-0.43	-0.98	-13.00	-53.90
149.63	-64.62	-61.85	-1.62	-1.15	-13.00	-51.62
164.18	-63.20	-61.07	-0.88	-1.26	-13.00	-50.20
181.97	-67.10	-67.59	1.87	-1.39	-13.00	-54.10
345.25	-66.69	-69.17	4.44	-1.97	-13.00	-53.69
610.38	-68.65	-69.64	3.48	-2.50	-13.00	-55.65
1591.00	-58.54	-63.72	9.35	-4.16	-40.00	-18.53
2386.50	-56.17	-61.05	9.97	-5.08	-13.00	-43.16

Unless otherwise stated the results shown in this test report refer only to the sample(s) tested and such sample(s) are retained for 90 days only.

除非另有說明，此報告結果僅對測試之樣品負責，同時此樣品僅保留90天。本報告未經本公司書面許可，不可部份複製。

This document is issued by the Company subject to its General Conditions of Service printed overleaf, available on request or accessible at <http://www.sgs.com.tw/Terms-and-Conditions> and for electronic format documents, subject to Terms and Conditions for Electronic Documents at <http://www.sgs.com.tw/Terms-and-Conditions>. Attention is drawn to the limitation of liability, indemnification and jurisdiction issues defined therein. Any holder of this document is advised that information contained hereon reflects the Company's findings at the time of its intervention only and within the limits of Client's instructions, if any. The Company's sole responsibility is to its Client and this document does not exonerate parties to a transaction from exercising all their rights and obligations under the transaction documents. This document cannot be reproduced except in full, without prior written approval of the Company. Any unauthorized alteration, forgery or falsification of the content or appearance of this document is unlawful and offenders may be prosecuted to the fullest extent of the law.

Report Number :ER/2021/A0027
 Operation Mode :LTE B17
 Test Mode :Tx CH Low
 EUT Pol :H Plane
 Test Frequency :709 MHz

Test Site :SAC 1
 Test Date :2021-11-12
 Temp./Humi. :23.8/53
 Antenna Pol. :Vertical
 Engineer :GN Lin

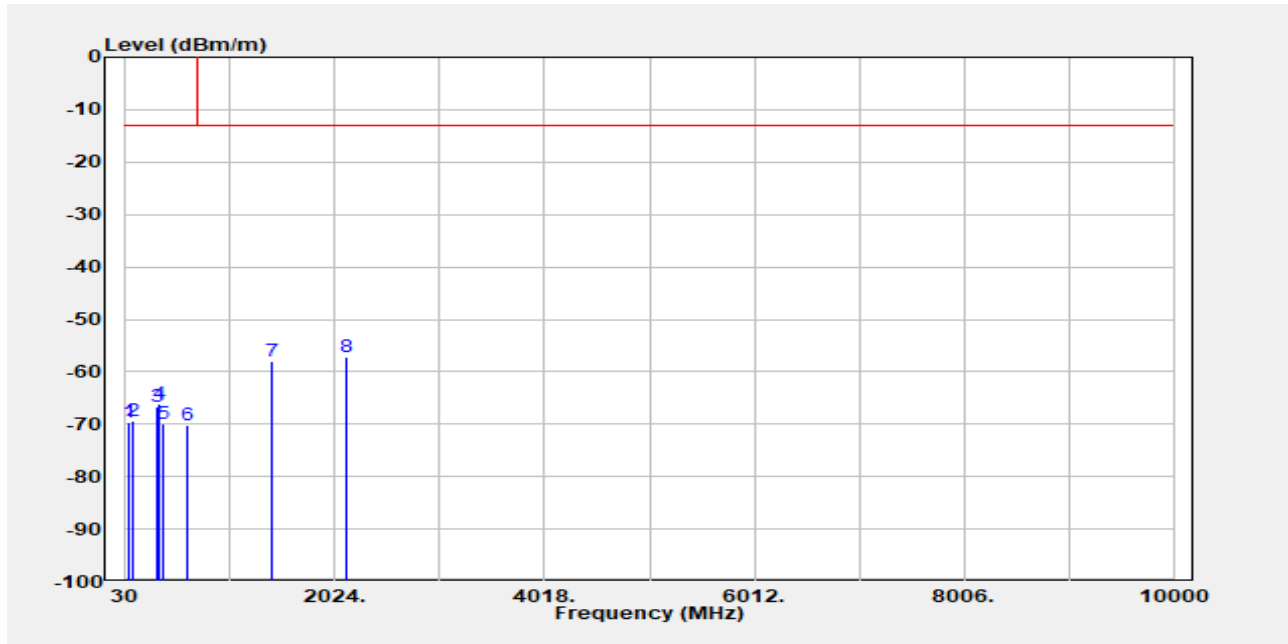

Freq. MHz	EIRP/ERP dBm	SG Output Level dBm	Antenna Gain dBi/dBd	Cable Loss dB	Limit dBm	Margin dB
62.33	-69.61	-60.03	-8.83	-0.76	-13.00	-56.60
107.60	-69.33	-66.87	-1.42	-1.04	-13.00	-56.32
335.55	-66.65	-69.04	4.28	-1.90	-13.00	-53.64
348.48	-66.01	-68.52	4.52	-2.01	-13.00	-53.00
388.90	-70.00	-72.36	4.40	-2.04	-13.00	-56.99
610.38	-70.22	-71.20	3.48	-2.50	-13.00	-57.21
1418.00	-57.89	-61.77	7.75	-3.87	-13.00	-44.88
2127.00	-57.30	-62.07	9.57	-4.80	-13.00	-44.29

Unless otherwise stated the results shown in this test report refer only to the sample(s) tested and such sample(s) are retained for 90 days only.

除非另有說明，此報告結果僅對測試之樣品負責，同時此樣品僅保留90天。本報告未經本公司書面許可，不可部份複製。

This document is issued by the Company subject to its General Conditions of Service printed overleaf, available on request or accessible at <http://www.sgs.com.tw/Terms-and-Conditions> and for electronic format documents, subject to Terms and Conditions for Electronic Documents at <http://www.sgs.com.tw/Terms-and-Conditions>. Attention is drawn to the limitation of liability, indemnification and jurisdiction issues defined therein. Any holder of this document is advised that information contained hereon reflects the Company's findings at the time of its intervention only and within the limits of Client's instructions, if any. The Company's sole responsibility is to its Client and this document does not exonerate parties to a transaction from exercising all their rights and obligations under the transaction documents. This document cannot be reproduced except in full, without prior written approval of the Company. Any unauthorized alteration, forgery or falsification of the content or appearance of this document is unlawful and offenders may be prosecuted to the fullest extent of the law.

Report Number :ER/2021/A0027
 Operation Mode :LTE B17
 Test Mode :Tx CH Low
 EUT Pol :H Plane
 Test Frequency :709 MHz

Test Site :SAC 1
 Test Date :2021-11-12
 Temp./Humi. :23.8/53
 Antenna Pol. :Horizontal
 Engineer :GN Lin

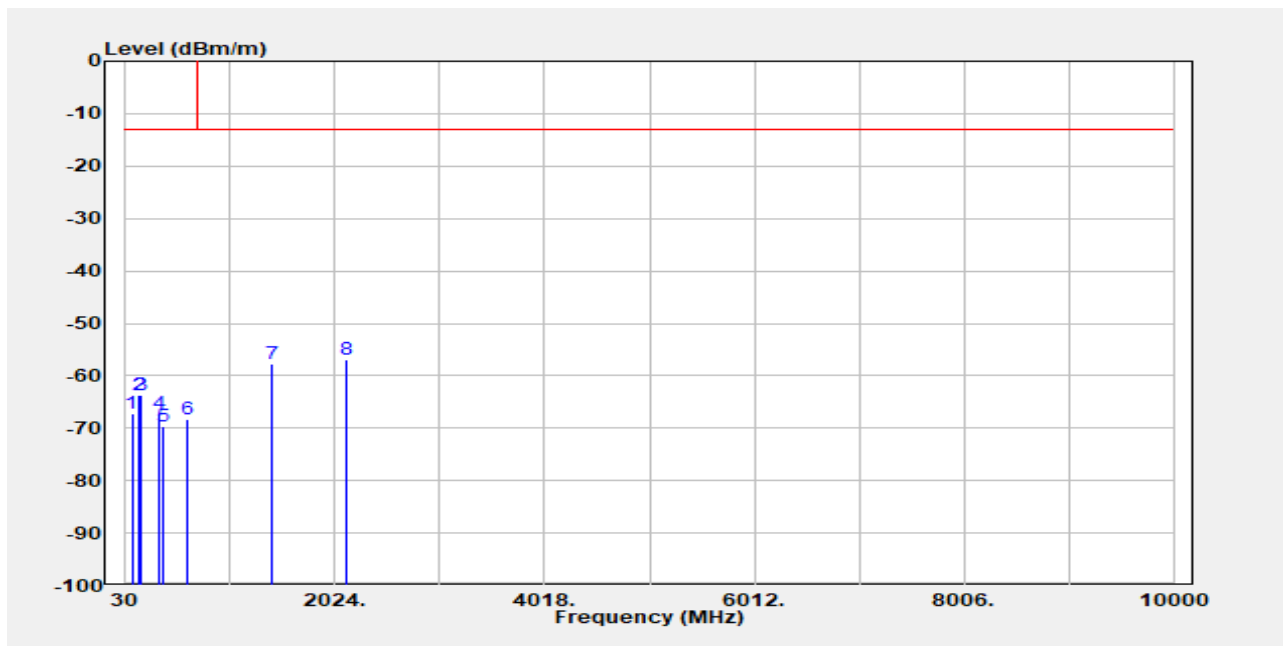

Freq. MHz	EIRP/ERP dBm	SG Output Level dBm	Antenna Gain dBi/dBd	Cable Loss dB	Limit dBm	Margin dB
89.82	-67.32	-65.91	-0.43	-0.98	-13.00	-54.31
149.63	-63.66	-60.89	-1.62	-1.15	-13.00	-50.65
170.65	-63.75	-62.26	-0.21	-1.27	-13.00	-50.74
345.25	-67.14	-69.62	4.44	-1.97	-13.00	-54.13
388.90	-69.67	-72.03	4.40	-2.04	-13.00	-56.66
610.38	-68.26	-69.25	3.48	-2.50	-13.00	-55.25
1418.00	-57.60	-61.48	7.75	-3.87	-13.00	-44.59
2127.00	-56.93	-61.70	9.57	-4.80	-13.00	-43.92

Unless otherwise stated the results shown in this test report refer only to the sample(s) tested and such sample(s) are retained for 90 days only.

除非另有說明，此報告結果僅對測試之樣品負責，同時此樣品僅保留90天。本報告未經本公司書面許可，不可部份複製。

This document is issued by the Company subject to its General Conditions of Service printed overleaf, available on request or accessible at <http://www.sgs.com.tw/Terms-and-Conditions> and for electronic format documents, subject to Terms and Conditions for Electronic Documents at <http://www.sgs.com.tw/Terms-and-Conditions>. Attention is drawn to the limitation of liability, indemnification and jurisdiction issues defined therein. Any holder of this document is advised that information contained hereon reflects the Company's findings at the time of its intervention only and within the limits of Client's instructions, if any. The Company's sole responsibility is to its Client and this document does not exonerate parties to a transaction from exercising all their rights and obligations under the transaction documents. This document cannot be reproduced except in full, without prior written approval of the Company. Any unauthorized alteration, forgery or falsification of the content or appearance of this document is unlawful and offenders may be prosecuted to the fullest extent of the law.

Report Number :ER/2021/A0027
 Operation Mode :LTE B17
 Test Mode :Tx CH Mid
 EUT Pol :H Plane
 Test Frequency :710 MHz

Test Site :SAC 1
 Test Date :2021-11-12
 Temp./Humi. :23.8/53
 Antenna Pol. :Vertical
 Engineer :GN Lin

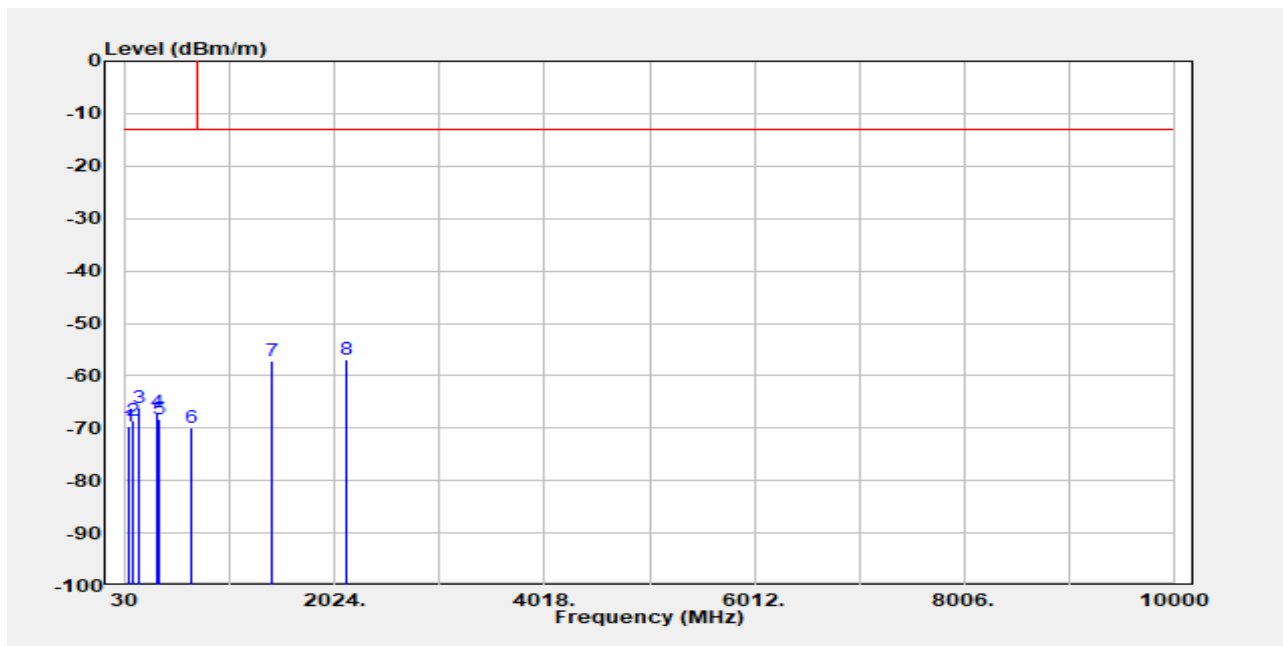

Freq. MHz	EIRP/ERP dBm	SG Output Level dBm	Antenna Gain dBi/dBd	Cable Loss dB	Limit dBm	Margin dB
60.72	-69.57	-59.45	-9.38	-0.74	-13.00	-56.56
107.60	-68.44	-65.97	-1.42	-1.04	-13.00	-55.43
149.63	-66.02	-63.25	-1.62	-1.15	-13.00	-53.01
335.55	-66.84	-69.22	4.28	-1.90	-13.00	-53.83
348.48	-68.38	-70.90	4.52	-2.01	-13.00	-55.37
647.57	-69.79	-71.02	3.61	-2.38	-13.00	-56.78
1420.00	-57.16	-61.05	7.76	-3.87	-13.00	-44.15
2130.00	-56.88	-61.61	9.54	-4.81	-13.00	-43.87

Unless otherwise stated the results shown in this test report refer only to the sample(s) tested and such sample(s) are retained for 90 days only.

除非另有說明，此報告結果僅對測試之樣品負責，同時此樣品僅保留90天。本報告未經本公司書面許可，不可部份複製。

This document is issued by the Company subject to its General Conditions of Service printed overleaf, available on request or accessible at <http://www.sgs.com.tw/Terms-and-Conditions> and for electronic format documents, subject to Terms and Conditions for Electronic Documents at <http://www.sgs.com.tw/Terms-and-Conditions>. Attention is drawn to the limitation of liability, indemnification and jurisdiction issues defined therein. Any holder of this document is advised that information contained hereon reflects the Company's findings at the time of its intervention only and within the limits of Client's instructions, if any. The Company's sole responsibility is to its Client and this document does not exonerate parties to a transaction from exercising all their rights and obligations under the transaction documents. This document cannot be reproduced except in full, without prior written approval of the Company. Any unauthorized alteration, forgery or falsification of the content or appearance of this document is unlawful and offenders may be prosecuted to the fullest extent of the law.

Report Number :ER/2021/A0027
 Operation Mode :LTE B17
 Test Mode :Tx CH Mid
 EUT Pol :H Plane
 Test Frequency :710 MHz

Test Site :SAC 1
 Test Date :2021-11-12
 Temp./Humi. :23.8/53
 Antenna Pol. :Horizontal
 Engineer :GN Lin

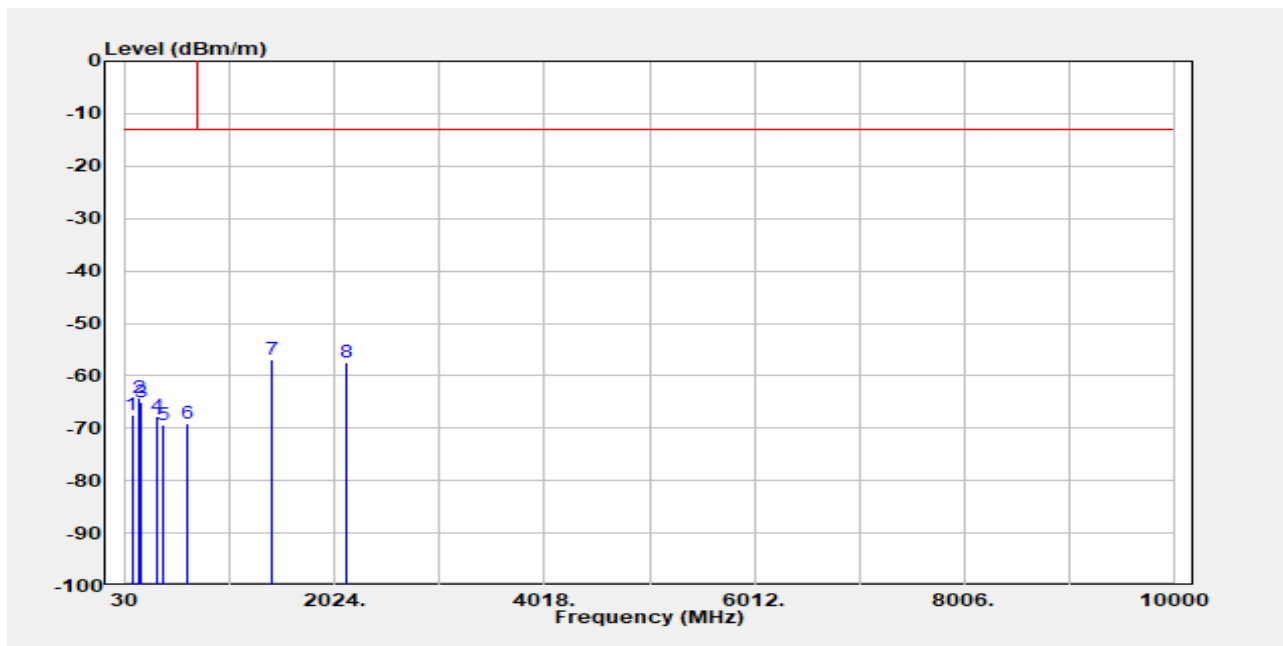

Freq. MHz	EIRP/ERP dBm	SG Output Level dBm	Antenna Gain dBi/dBd	Cable Loss dB	Limit dBm	Margin dB
89.82	-67.43	-66.02	-0.43	-0.98	-13.00	-54.42
149.63	-64.30	-61.54	-1.62	-1.15	-13.00	-51.29
170.65	-65.09	-63.60	-0.21	-1.27	-13.00	-52.08
335.55	-67.63	-70.01	4.28	-1.90	-13.00	-54.62
388.90	-69.51	-71.87	4.40	-2.04	-13.00	-56.50
610.38	-69.01	-69.99	3.48	-2.50	-13.00	-56.00
1420.00	-56.84	-60.73	7.76	-3.87	-13.00	-43.83
2130.00	-57.41	-62.14	9.54	-4.81	-13.00	-44.40

Unless otherwise stated the results shown in this test report refer only to the sample(s) tested and such sample(s) are retained for 90 days only.

除非另有說明，此報告結果僅對測試之樣品負責，同時此樣品僅保留90天。本報告未經本公司書面許可，不可部份複製。

This document is issued by the Company subject to its General Conditions of Service printed overleaf, available on request or accessible at <http://www.sgs.com.tw/Terms-and-Conditions> and for electronic format documents, subject to Terms and Conditions for Electronic Documents at <http://www.sgs.com.tw/Terms-and-Conditions>. Attention is drawn to the limitation of liability, indemnification and jurisdiction issues defined therein. Any holder of this document is advised that information contained hereon reflects the Company's findings at the time of its intervention only and within the limits of Client's instructions, if any. The Company's sole responsibility is to its Client and this document does not exonerate parties to a transaction from exercising all their rights and obligations under the transaction documents. This document cannot be reproduced except in full, without prior written approval of the Company. Any unauthorized alteration, forgery or falsification of the content or appearance of this document is unlawful and offenders may be prosecuted to the fullest extent of the law.

Report Number :ER/2021/A0027
 Operation Mode :LTE B17
 Test Mode :Tx CH High
 EUT Pol :H Plane
 Test Frequency :711 MHz

Test Site :SAC 1
 Test Date :2021-11-12
 Temp./Humi. :23.8/53
 Antenna Pol. :Vertical
 Engineer :GN Lin

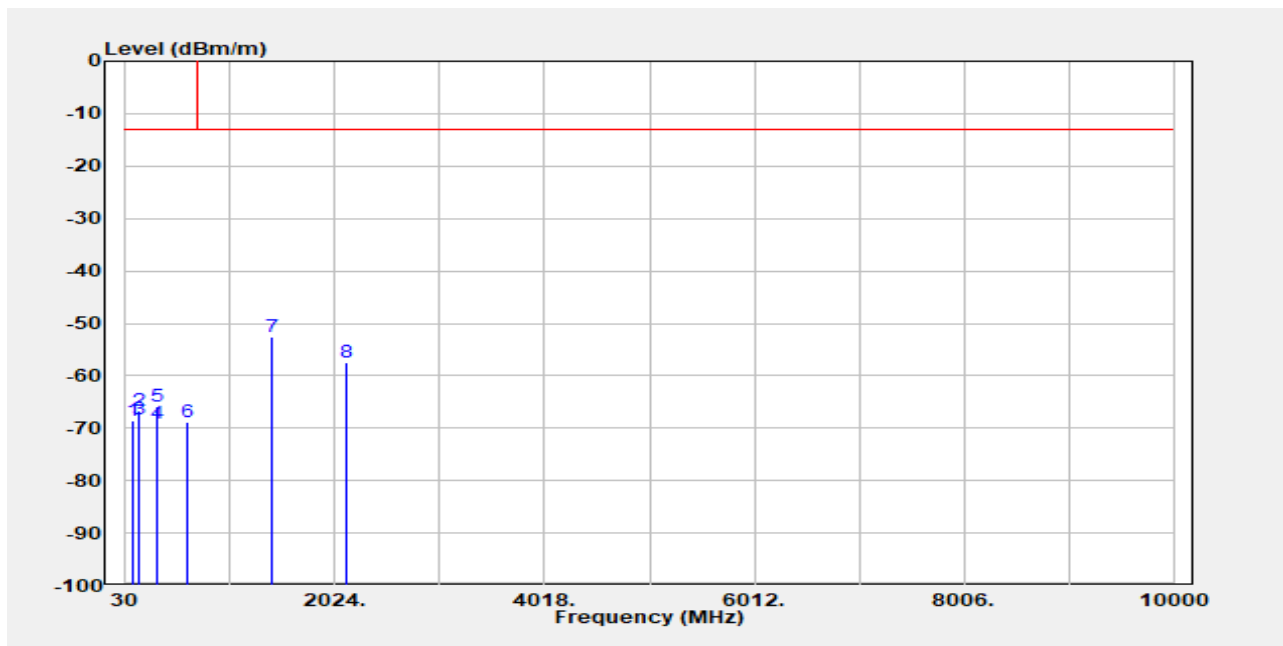

Freq. MHz	EIRP/ERP dBm	SG Output Level dBm	Antenna Gain dBi/dBd	Cable Loss dB	Limit dBm	Margin dB
107.60	-68.52	-66.05	-1.42	-1.04	-13.00	-55.51
149.63	-66.55	-63.78	-1.62	-1.15	-13.00	-53.54
164.18	-68.41	-66.28	-0.88	-1.26	-13.00	-55.40
321.00	-69.18	-71.69	4.19	-1.68	-13.00	-56.17
335.55	-65.93	-68.31	4.28	-1.90	-13.00	-52.92
610.38	-68.95	-69.94	3.48	-2.50	-13.00	-55.94
1422.00	-52.64	-56.55	7.78	-3.87	-13.00	-39.63
2133.00	-57.49	-62.18	9.50	-4.81	-13.00	-44.48

Unless otherwise stated the results shown in this test report refer only to the sample(s) tested and such sample(s) are retained for 90 days only.

除非另有說明，此報告結果僅對測試之樣品負責，同時此樣品僅保留90天。本報告未經本公司書面許可，不可部份複製。

This document is issued by the Company subject to its General Conditions of Service printed overleaf, available on request or accessible at <http://www.sgs.com.tw/Terms-and-Conditions> and for electronic format documents, subject to Terms and Conditions for Electronic Documents at <http://www.sgs.com.tw/Terms-and-Conditions>. Attention is drawn to the limitation of liability, indemnification and jurisdiction issues defined therein. Any holder of this document is advised that information contained hereon reflects the Company's findings at the time of its intervention only and within the limits of Client's instructions, if any. The Company's sole responsibility is to its Client and this document does not exonerate parties to a transaction from exercising all their rights and obligations under the transaction documents. This document cannot be reproduced except in full, without prior written approval of the Company. Any unauthorized alteration, forgery or falsification of the content or appearance of this document is unlawful and offenders may be prosecuted to the fullest extent of the law.

Report Number :ER/2021/A0027
 Operation Mode :LTE B17
 Test Mode :Tx CH High
 EUT Pol :H Plane
 Test Frequency :711 MHz

Test Site :SAC 1
 Test Date :2021-11-12
 Temp./Humi. :23.8/53
 Antenna Pol. :Horizontal
 Engineer :GN Lin

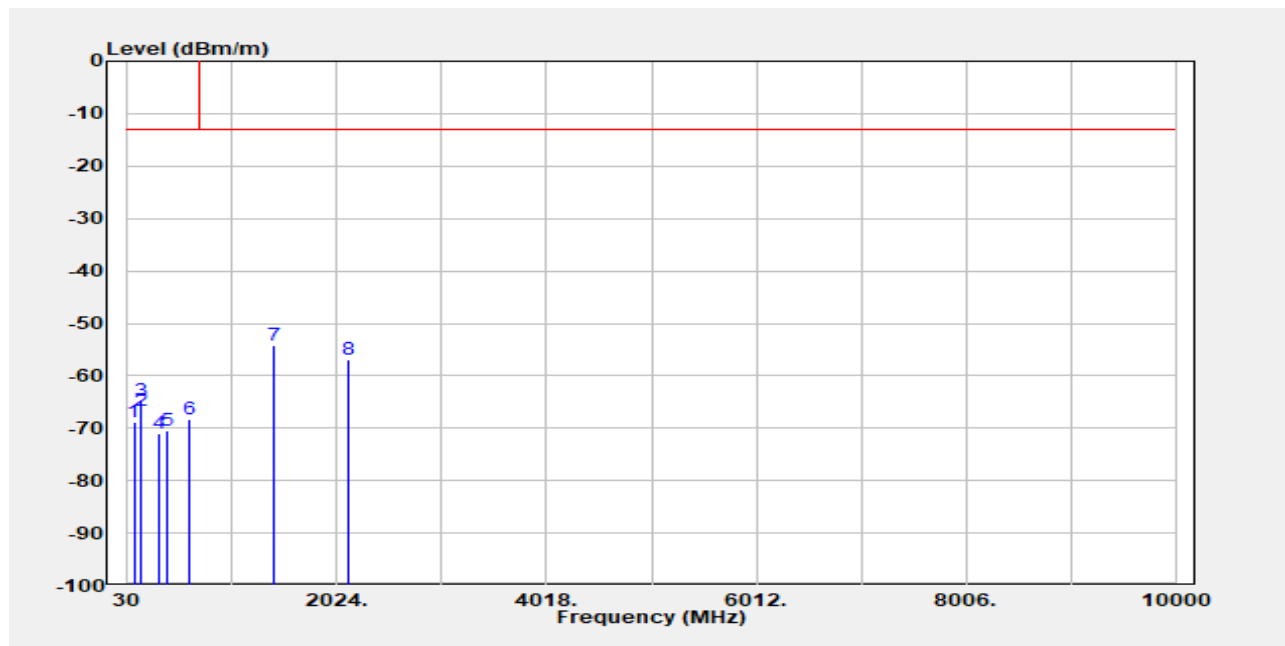

Freq. MHz	EIRP/ERP dBm	SG Output Level dBm	Antenna Gain dBi/dBd	Cable Loss dB	Limit dBm	Margin dB
89.82	-68.87	-67.46	-0.43	-0.98	-13.00	-55.86
149.63	-66.60	-63.83	-1.62	-1.15	-13.00	-53.59
164.18	-64.73	-62.60	-0.88	-1.26	-13.00	-51.72
335.55	-71.03	-73.41	4.28	-1.90	-13.00	-58.02
401.83	-70.43	-72.68	4.32	-2.08	-13.00	-57.42
610.38	-68.18	-69.17	3.48	-2.50	-13.00	-55.17
1422.00	-54.31	-58.22	7.78	-3.87	-13.00	-41.30
2133.00	-56.85	-61.54	9.50	-4.81	-13.00	-43.84

Unless otherwise stated the results shown in this test report refer only to the sample(s) tested and such sample(s) are retained for 90 days only.

除非另有說明，此報告結果僅對測試之樣品負責，同時此樣品僅保留90天。本報告未經本公司書面許可，不可部份複製。

This document is issued by the Company subject to its General Conditions of Service printed overleaf, available on request or accessible at <http://www.sgs.com.tw/Terms-and-Conditions> and for electronic format documents, subject to Terms and Conditions for Electronic Documents at <http://www.sgs.com.tw/Terms-and-Conditions>. Attention is drawn to the limitation of liability, indemnification and jurisdiction issues defined therein. Any holder of this document is advised that information contained hereon reflects the Company's findings at the time of its intervention only and within the limits of Client's instructions, if any. The Company's sole responsibility is to its Client and this document does not exonerate parties to a transaction from exercising all their rights and obligations under the transaction documents. This document cannot be reproduced except in full, without prior written approval of the Company. Any unauthorized alteration, forgery or falsification of the content or appearance of this document is unlawful and offenders may be prosecuted to the fullest extent of the law.

Report Number :ER/2021/A0027
 Operation Mode :LTE B25
 Test Mode :Tx CH Low
 EUT Pol :H Plane
 Test Frequency :1855 MHz

Test Site :SAC 1
 Test Date :2021-11-12
 Temp./Humi. :23.8/53
 Antenna Pol. :Vertical
 Engineer :GN Lin

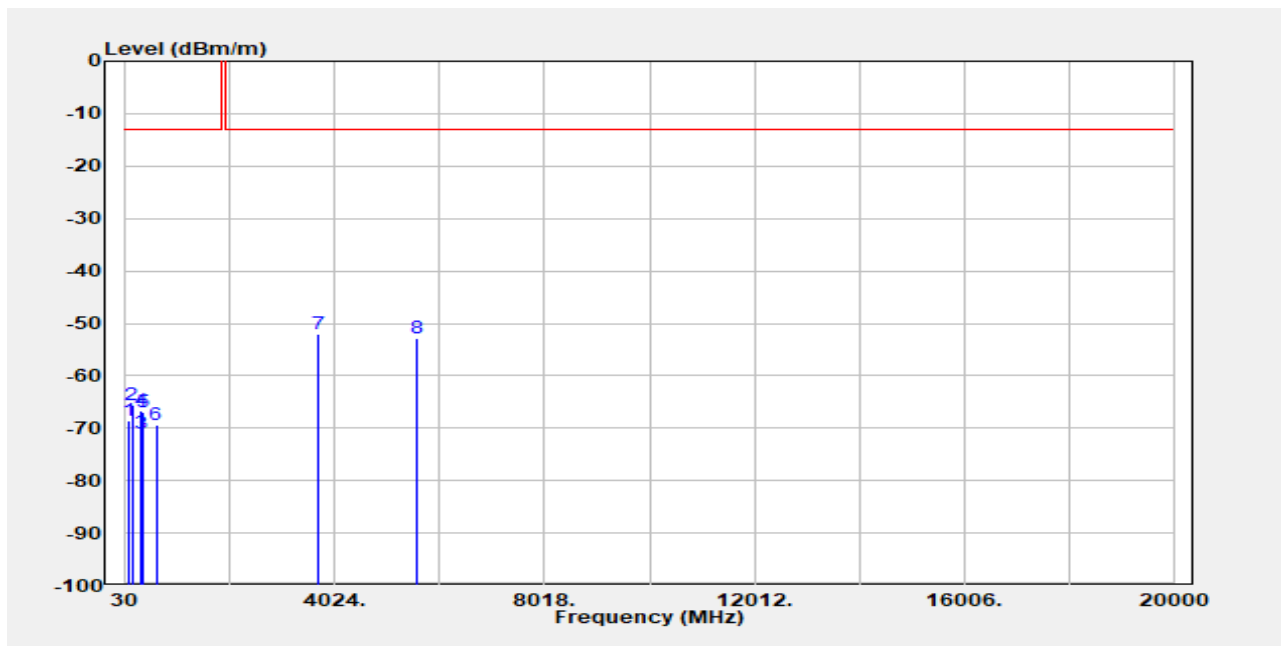

Freq. MHz	EIRP/ERP dBm	SG Output Level dBm	Antenna Gain dBi/dBd	Cable Loss dB	Limit dBm	Margin dB
107.60	-68.44	-65.97	-1.42	-1.04	-13.00	-55.44
149.63	-65.70	-62.94	-1.62	-1.15	-13.00	-52.70
311.30	-70.97	-73.41	4.19	-1.74	-13.00	-57.97
335.55	-66.65	-69.04	4.28	-1.90	-13.00	-53.65
348.48	-66.97	-69.48	4.52	-2.01	-13.00	-53.97
610.38	-69.39	-70.37	3.48	-2.50	-13.00	-56.39
3710.00	-51.97	-56.75	12.32	-7.54	-13.00	-38.96
5565.00	-52.78	-56.21	12.93	-9.50	-13.00	-39.77

Unless otherwise stated the results shown in this test report refer only to the sample(s) tested and such sample(s) are retained for 90 days only.

除非另有說明，此報告結果僅對測試之樣品負責，同時此樣品僅保留90天。本報告未經本公司書面許可，不可部份複製。

This document is issued by the Company subject to its General Conditions of Service printed overleaf, available on request or accessible at <http://www.sgs.com.tw/Terms-and-Conditions> and for electronic format documents, subject to Terms and Conditions for Electronic Documents at <http://www.sgs.com.tw/Terms-and-Conditions>. Attention is drawn to the limitation of liability, indemnification and jurisdiction issues defined therein. Any holder of this document is advised that information contained hereon reflects the Company's findings at the time of its intervention only and within the limits of Client's instructions, if any. The Company's sole responsibility is to its Client and this document does not exonerate parties to a transaction from exercising all their rights and obligations under the transaction documents. This document cannot be reproduced except in full, without prior written approval of the Company. Any unauthorized alteration, forgery or falsification of the content or appearance of this document is unlawful and offenders may be prosecuted to the fullest extent of the law.

Report Number :ER/2021/A0027
 Operation Mode :LTE B25
 Test Mode :Tx CH Low
 EUT Pol :H Plane
 Test Frequency :1855 MHz

Test Site :SAC 1
 Test Date :2021-11-12
 Temp./Humi. :23.8/53
 Antenna Pol. :Horizontal
 Engineer :GN Lin

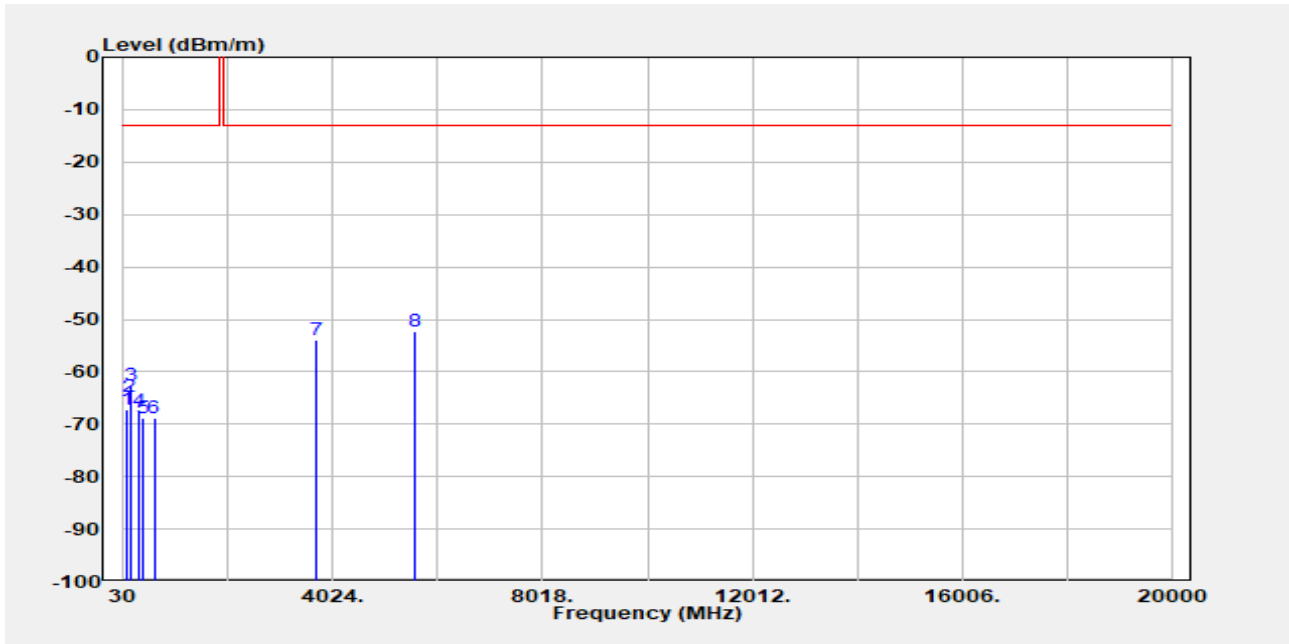

Freq. MHz	EIRP/ERP dBm	SG Output Level dBm	Antenna Gain dBi/dBd	Cable Loss dB	Limit dBm	Margin dB
89.82	-67.33	-65.92	-0.43	-0.98	-13.00	-54.33
149.63	-64.81	-62.04	-1.62	-1.15	-13.00	-51.81
164.18	-62.57	-60.44	-0.88	-1.26	-13.00	-49.57
332.32	-67.44	-69.79	4.26	-1.91	-13.00	-54.44
388.90	-68.84	-71.20	4.40	-2.04	-13.00	-55.84
610.38	-68.86	-69.85	3.48	-2.50	-13.00	-55.86
3710.00	-53.82	-58.60	12.32	-7.54	-13.00	-40.82
5565.00	-52.31	-55.74	12.93	-9.50	-13.00	-39.31

Unless otherwise stated the results shown in this test report refer only to the sample(s) tested and such sample(s) are retained for 90 days only.

除非另有說明，此報告結果僅對測試之樣品負責，同時此樣品僅保留90天。本報告未經本公司書面許可，不可部份複製。

This document is issued by the Company subject to its General Conditions of Service printed overleaf, available on request or accessible at <http://www.sgs.com.tw/Terms-and-Conditions> and for electronic format documents, subject to Terms and Conditions for Electronic Documents at <http://www.sgs.com.tw/Terms-and-Conditions>. Attention is drawn to the limitation of liability, indemnification and jurisdiction issues defined therein. Any holder of this document is advised that information contained hereon reflects the Company's findings at the time of its intervention only and within the limits of Client's instructions, if any. The Company's sole responsibility is to its Client and this document does not exonerate parties to a transaction from exercising all their rights and obligations under the transaction documents. This document cannot be reproduced except in full, without prior written approval of the Company. Any unauthorized alteration, forgery or falsification of the content or appearance of this document is unlawful and offenders may be prosecuted to the fullest extent of the law.

Report Number :ER/2021/A0027
 Operation Mode :LTE B25
 Test Mode :Tx CH Mid
 EUT Pol :H Plane
 Test Frequency :1882.5 MHz

Test Site :SAC 1
 Test Date :2021-11-12
 Temp./Humi. :23.8/53
 Antenna Pol. :Vertical
 Engineer :GN Lin

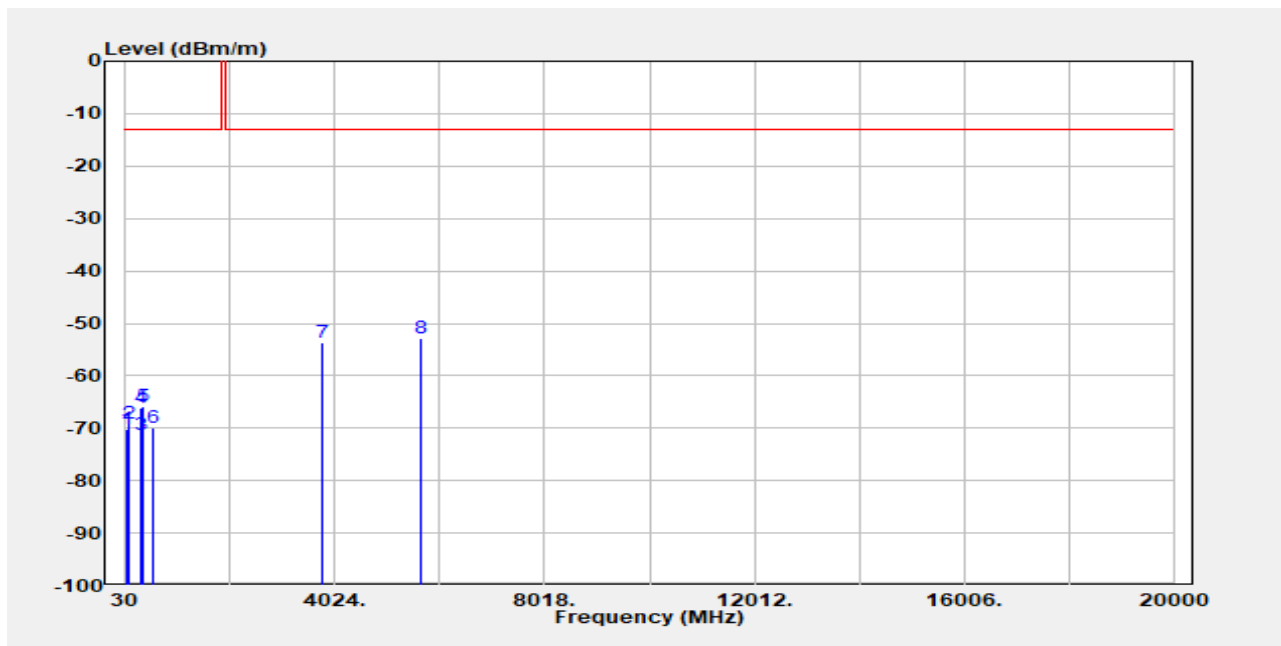

Freq. MHz	EIRP/ERP dBm	SG Output Level dBm	Antenna Gain dBi/dBd	Cable Loss dB	Limit dBm	Margin dB
60.72	-70.23	-60.11	-9.38	-0.74	-13.00	-57.23
107.60	-69.23	-66.76	-1.42	-1.04	-13.00	-56.23
311.30	-71.27	-73.72	4.19	-1.74	-13.00	-58.27
335.55	-66.08	-68.46	4.28	-1.90	-13.00	-53.08
348.48	-65.83	-68.34	4.52	-2.01	-13.00	-52.83
563.50	-69.94	-71.48	4.16	-2.62	-13.00	-56.94
3765.00	-53.72	-58.47	12.40	-7.64	-13.00	-40.71
5647.50	-52.94	-56.72	13.00	-9.21	-13.00	-39.93

Unless otherwise stated the results shown in this test report refer only to the sample(s) tested and such sample(s) are retained for 90 days only.

除非另有說明，此報告結果僅對測試之樣品負責，同時此樣品僅保留90天。本報告未經本公司書面許可，不可部份複製。

This document is issued by the Company subject to its General Conditions of Service printed overleaf, available on request or accessible at <http://www.sgs.com.tw/Terms-and-Conditions> and for electronic format documents, subject to Terms and Conditions for Electronic Documents at <http://www.sgs.com.tw/Terms-and-Conditions>. Attention is drawn to the limitation of liability, indemnification and jurisdiction issues defined therein. Any holder of this document is advised that information contained hereon reflects the Company's findings at the time of its intervention only and within the limits of Client's instructions, if any. The Company's sole responsibility is to its Client and this document does not exonerate parties to a transaction from exercising all their rights and obligations under the transaction documents. This document cannot be reproduced except in full, without prior written approval of the Company. Any unauthorized alteration, forgery or falsification of the content or appearance of this document is unlawful and offenders may be prosecuted to the fullest extent of the law.

Report Number :ER/2021/A0027
 Operation Mode :LTE B25
 Test Mode :Tx CH Mid
 EUT Pol :H Plane
 Test Frequency :1882.5 MHz

Test Site :SAC 1
 Test Date :2021-11-12
 Temp./Humi. :23.8/53
 Antenna Pol. :Horizontal
 Engineer :GN Lin

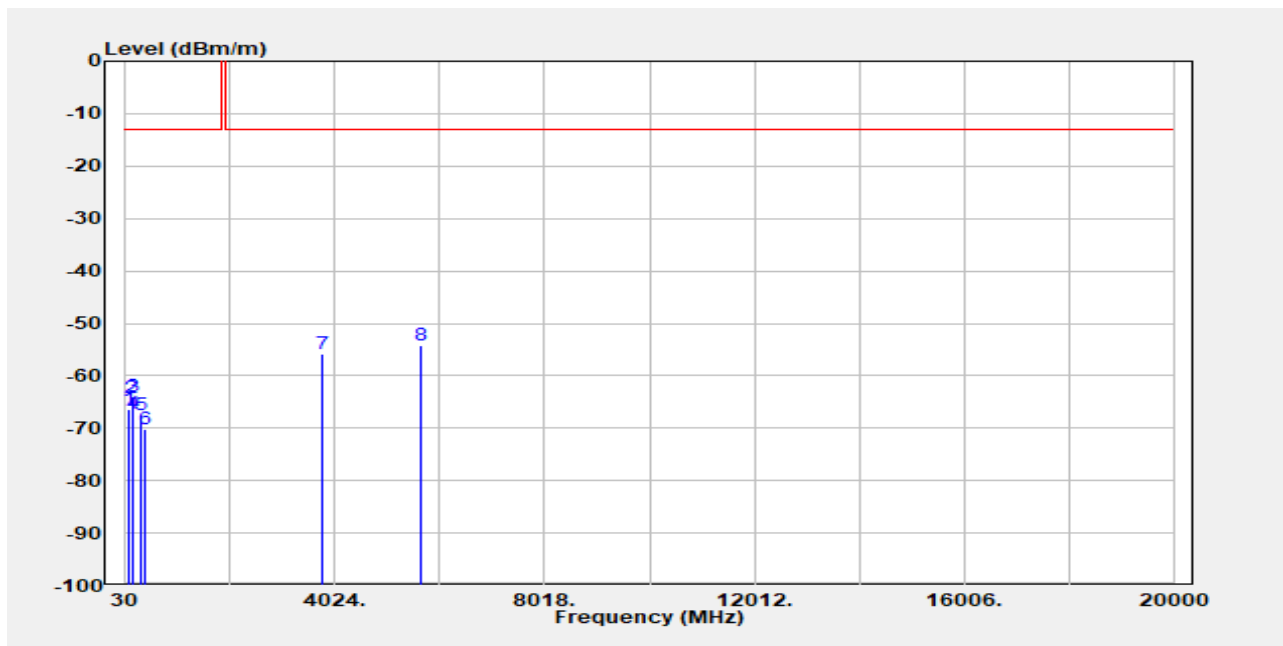

Freq. MHz	EIRP/ERP dBm	SG Output Level dBm	Antenna Gain dBi/dBd	Cable Loss dB	Limit dBm	Margin dB
89.82	-66.47	-65.06	-0.43	-0.98	-13.00	-53.47
149.63	-64.19	-61.42	-1.62	-1.15	-13.00	-51.19
164.18	-64.05	-61.91	-0.88	-1.26	-13.00	-51.05
181.97	-67.10	-67.59	1.87	-1.39	-13.00	-54.10
335.55	-67.46	-69.85	4.28	-1.90	-13.00	-54.46
401.83	-70.16	-72.40	4.32	-2.08	-13.00	-57.16
3765.00	-55.79	-60.55	12.40	-7.64	-13.00	-42.78
5647.50	-54.30	-58.09	13.00	-9.21	-13.00	-41.29

Unless otherwise stated the results shown in this test report refer only to the sample(s) tested and such sample(s) are retained for 90 days only.

除非另有說明，此報告結果僅對測試之樣品負責，同時此樣品僅保留90天。本報告未經本公司書面許可，不可部份複製。

This document is issued by the Company subject to its General Conditions of Service printed overleaf, available on request or accessible at <http://www.sgs.com.tw/Terms-and-Conditions> and for electronic format documents, subject to Terms and Conditions for Electronic Documents at <http://www.sgs.com.tw/Terms-and-Conditions>. Attention is drawn to the limitation of liability, indemnification and jurisdiction issues defined therein. Any holder of this document is advised that information contained hereon reflects the Company's findings at the time of its intervention only and within the limits of Client's instructions, if any. The Company's sole responsibility is to its Client and this document does not exonerate parties to a transaction from exercising all their rights and obligations under the transaction documents. This document cannot be reproduced except in full, without prior written approval of the Company. Any unauthorized alteration, forgery or falsification of the content or appearance of this document is unlawful and offenders may be prosecuted to the fullest extent of the law.

Report Number :ER/2021/A0027
 Operation Mode :LTE B25
 Test Mode :Tx CH High
 EUT Pol :H Plane
 Test Frequency :1910 MHz

Test Site :SAC 1
 Test Date :2021-11-12
 Temp./Humi. :23.8/53
 Antenna Pol. :Vertical
 Engineer :GN Lin

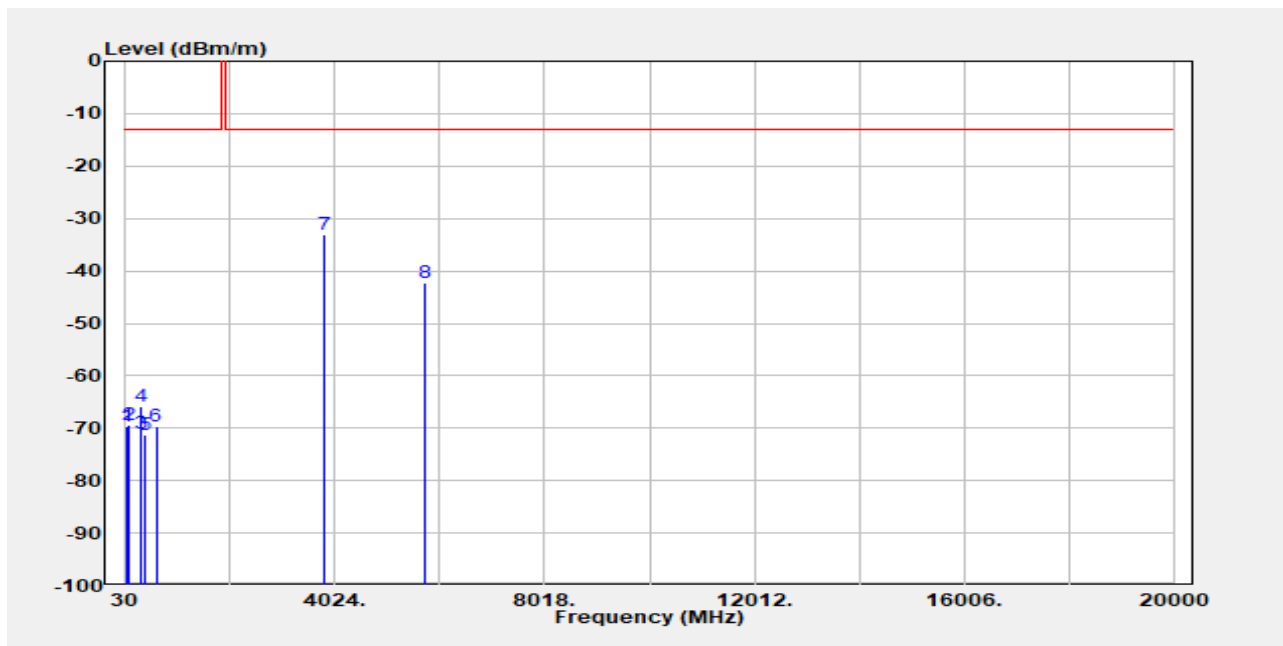

Freq. MHz	EIRP/ERP dBm	SG Output Level dBm	Antenna Gain dBi/dBd	Cable Loss dB	Limit dBm	Margin dB
60.72	-69.74	-59.62	-9.38	-0.74	-13.00	-56.74
101.13	-69.43	-67.53	-0.88	-1.02	-13.00	-56.43
311.30	-70.90	-73.35	4.19	-1.74	-13.00	-57.90
335.55	-65.77	-68.15	4.28	-1.90	-13.00	-52.77
388.90	-71.26	-73.62	4.40	-2.04	-13.00	-58.26
610.38	-69.76	-70.74	3.48	-2.50	-13.00	-56.76
3820.00	-33.04	-37.76	12.36	-7.64	-13.00	-20.03
5730.00	-42.38	-46.15	12.80	-9.03	-13.00	-29.37

Unless otherwise stated the results shown in this test report refer only to the sample(s) tested and such sample(s) are retained for 90 days only.

除非另有說明，此報告結果僅對測試之樣品負責，同時此樣品僅保留90天。本報告未經本公司書面許可，不可部份複製。

This document is issued by the Company subject to its General Conditions of Service printed overleaf, available on request or accessible at <http://www.sgs.com.tw/Terms-and-Conditions> and for electronic format documents, subject to Terms and Conditions for Electronic Documents at <http://www.sgs.com.tw/Terms-and-Conditions>. Attention is drawn to the limitation of liability, indemnification and jurisdiction issues defined therein. Any holder of this document is advised that information contained hereon reflects the Company's findings at the time of its intervention only and within the limits of Client's instructions, if any. The Company's sole responsibility is to its Client and this document does not exonerate parties to a transaction from exercising all their rights and obligations under the transaction documents. This document cannot be reproduced except in full, without prior written approval of the Company. Any unauthorized alteration, forgery or falsification of the content or appearance of this document is unlawful and offenders may be prosecuted to the fullest extent of the law.

Report Number :ER/2021/A0027
 Operation Mode :LTE B25
 Test Mode :Tx CH High
 EUT Pol :H Plane
 Test Frequency :1910 MHz

Test Site :SAC 1
 Test Date :2021-11-12
 Temp./Humi. :23.8/53
 Antenna Pol. :Horizontal
 Engineer :GN Lin

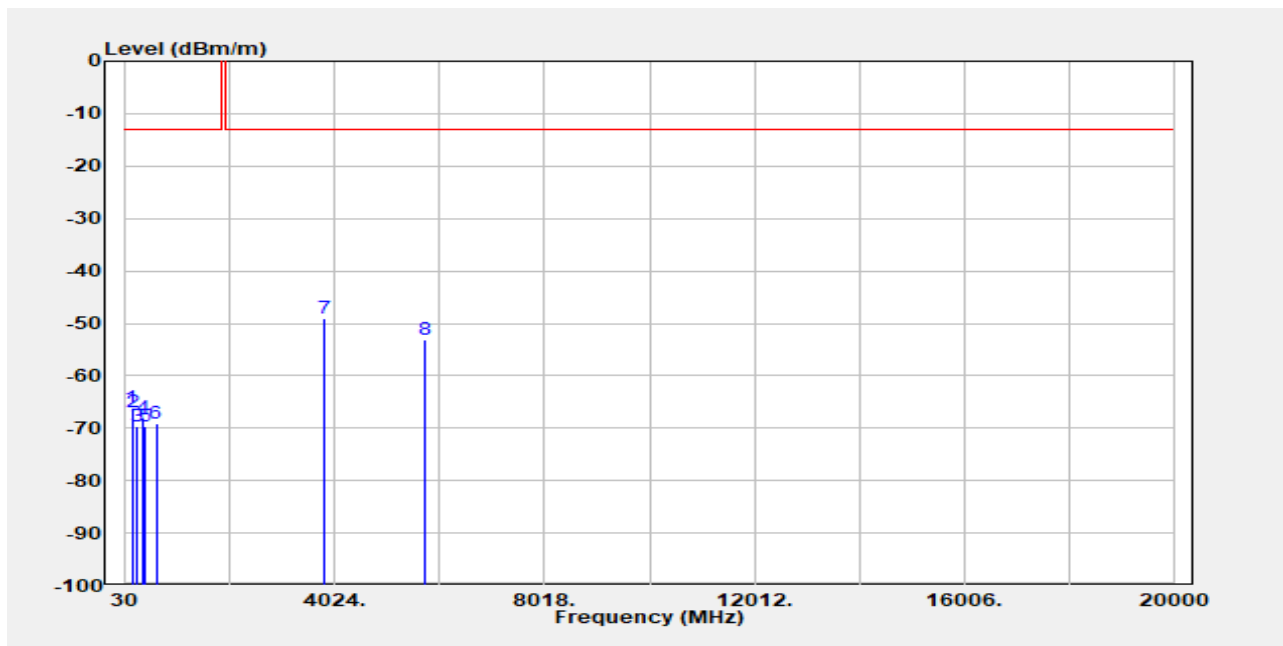

Freq. MHz	EIRP/ERP dBm	SG Output Level dBm	Antenna Gain dBi/dBd	Cable Loss dB	Limit dBm	Margin dB
149.63	-66.02	-63.26	-1.62	-1.15	-13.00	-53.02
170.65	-67.04	-65.56	-0.21	-1.27	-13.00	-54.04
240.17	-69.53	-72.30	4.38	-1.61	-13.00	-56.53
345.25	-67.98	-70.46	4.44	-1.97	-13.00	-54.98
388.90	-69.77	-72.13	4.40	-2.04	-13.00	-56.77
610.38	-68.99	-69.98	3.48	-2.50	-13.00	-55.99
3820.00	-49.19	-53.90	12.36	-7.64	-13.00	-36.18
5730.00	-53.04	-56.81	12.80	-9.03	-13.00	-40.03

Unless otherwise stated the results shown in this test report refer only to the sample(s) tested and such sample(s) are retained for 90 days only.

除非另有說明，此報告結果僅對測試之樣品負責，同時此樣品僅保留90天。本報告未經本公司書面許可，不可部份複製。

This document is issued by the Company subject to its General Conditions of Service printed overleaf, available on request or accessible at <http://www.sgs.com.tw/Terms-and-Conditions> and for electronic format documents, subject to Terms and Conditions for Electronic Documents at <http://www.sgs.com.tw/Terms-and-Conditions>. Attention is drawn to the limitation of liability, indemnification and jurisdiction issues defined therein. Any holder of this document is advised that information contained hereon reflects the Company's findings at the time of its intervention only and within the limits of Client's instructions, if any. The Company's sole responsibility is to its Client and this document does not exonerate parties to a transaction from exercising all their rights and obligations under the transaction documents. This document cannot be reproduced except in full, without prior written approval of the Company. Any unauthorized alteration, forgery or falsification of the content or appearance of this document is unlawful and offenders may be prosecuted to the fullest extent of the law.

Report Number :ER/2021/A0027
 Operation Mode :LTE B26
 Test Mode :Tx CH Low
 EUT Pol :H Plane
 Test Frequency :825.5 MHz

Test Site :SAC 1
 Test Date :2021-11-12
 Temp./Humi. :23.8/53
 Antenna Pol. :Vertical
 Engineer :GN Lin

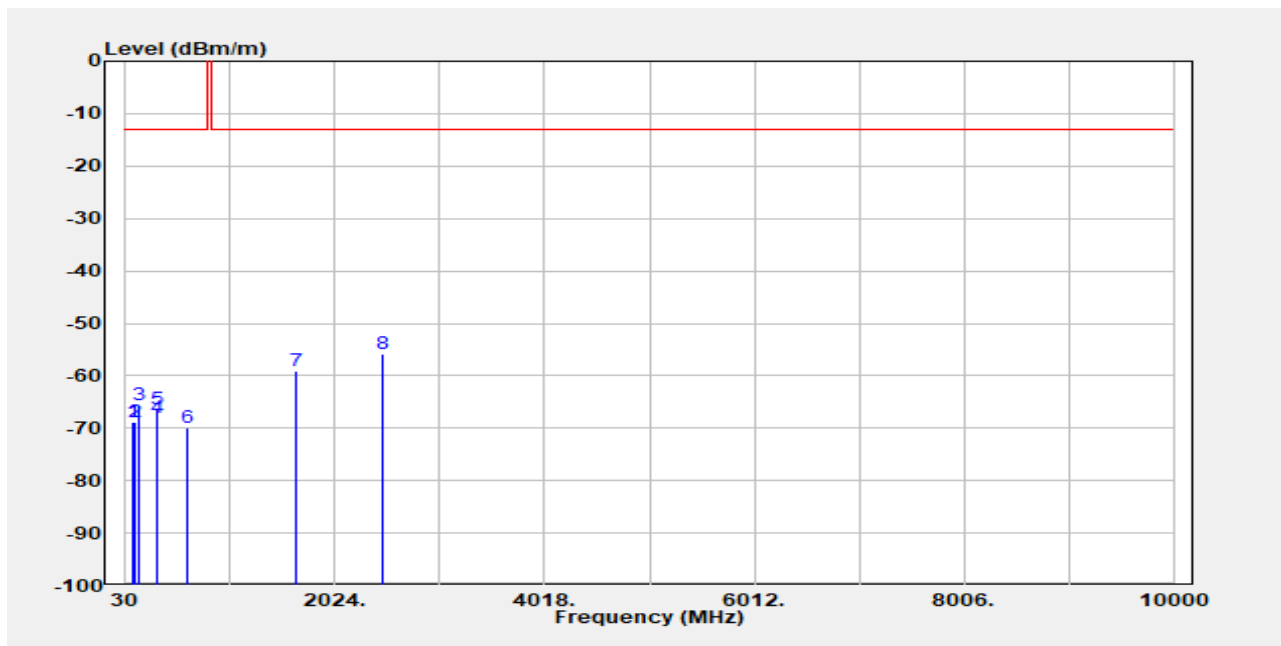

Freq. MHz	EIRP/ERP dBm	SG Output Level dBm	Antenna Gain dBi/dBd	Cable Loss dB	Limit dBm	Margin dB
101.13	-68.95	-67.05	-0.88	-1.02	-13.00	-55.95
110.83	-68.91	-66.41	-1.44	-1.06	-13.00	-55.91
149.63	-65.49	-62.72	-1.62	-1.15	-13.00	-52.49
321.00	-68.08	-70.59	4.19	-1.68	-13.00	-55.08
332.32	-66.28	-68.64	4.26	-1.91	-13.00	-53.28
610.38	-69.99	-70.97	3.48	-2.50	-13.00	-56.99
1651.00	-59.18	1.24	9.50	-4.26	-13.00	-46.18
2476.50	-55.76	5.56	10.55	-5.17	-13.00	-42.76

Unless otherwise stated the results shown in this test report refer only to the sample(s) tested and such sample(s) are retained for 90 days only.

除非另有說明，此報告結果僅對測試之樣品負責，同時此樣品僅保留90天。本報告未經本公司書面許可，不可部份複製。

This document is issued by the Company subject to its General Conditions of Service printed overleaf, available on request or accessible at <http://www.sgs.com.tw/Terms-and-Conditions> and for electronic format documents, subject to Terms and Conditions for Electronic Documents at <http://www.sgs.com.tw/Terms-and-Conditions>. Attention is drawn to the limitation of liability, indemnification and jurisdiction issues defined therein. Any holder of this document is advised that information contained hereon reflects the Company's findings at the time of its intervention only and within the limits of Client's instructions, if any. The Company's sole responsibility is to its Client and this document does not exonerate parties to a transaction from exercising all their rights and obligations under the transaction documents. This document cannot be reproduced except in full, without prior written approval of the Company. Any unauthorized alteration, forgery or falsification of the content or appearance of this document is unlawful and offenders may be prosecuted to the fullest extent of the law.

Report Number :ER/2021/A0027
 Operation Mode :LTE B26
 Test Mode :Tx CH Low
 EUT Pol :H Plane
 Test Frequency :825.5 MHz

Test Site :SAC 1
 Test Date :2021-11-12
 Temp./Humi. :23.8/53
 Antenna Pol. :Horizontal
 Engineer :GN Lin

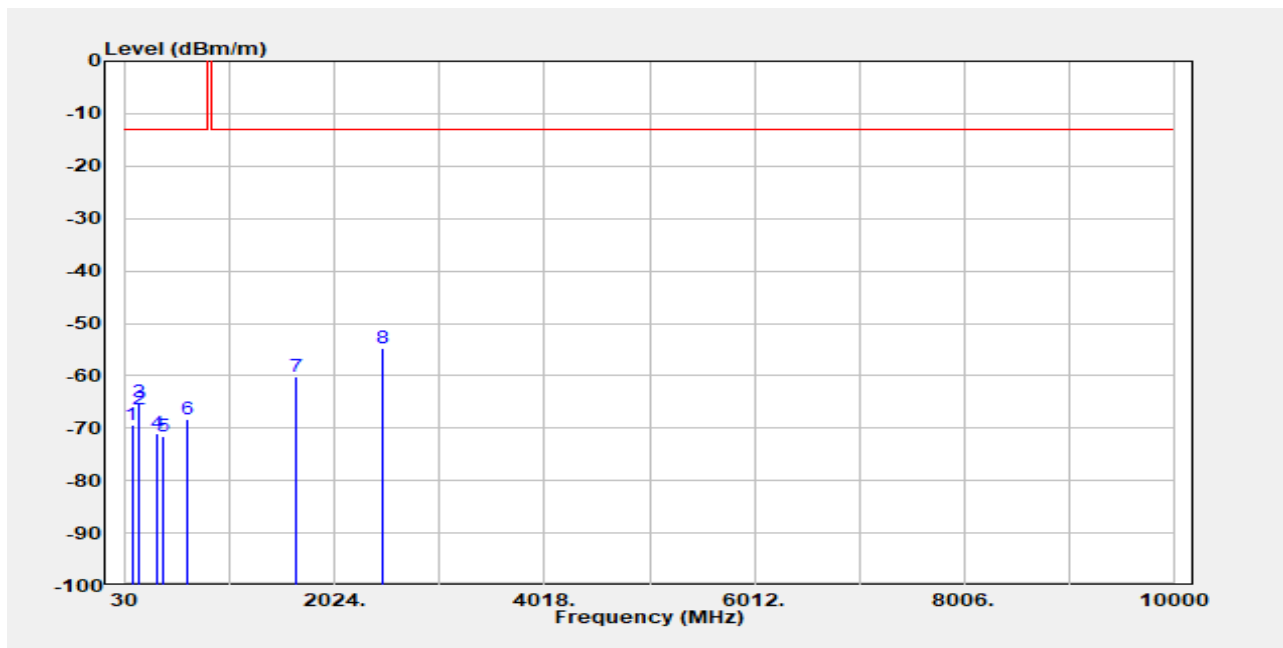

Freq. MHz	EIRP/ERP dBm	SG Output Level dBm	Antenna Gain dBi/dBd	Cable Loss dB	Limit dBm	Margin dB
89.82	-69.29	-67.88	-0.43	-0.98	-13.00	-56.29
149.63	-66.50	-63.73	-1.62	-1.15	-13.00	-53.50
164.18	-65.11	-62.98	-0.88	-1.26	-13.00	-52.11
335.55	-70.90	-73.28	4.28	-1.90	-13.00	-57.90
388.90	-71.51	-73.87	4.40	-2.04	-13.00	-58.51
610.38	-68.31	-69.29	3.48	-2.50	-13.00	-55.31
1651.00	-60.09	1.59	9.50	-4.26	-13.00	-47.09
2476.50	-54.73	5.68	10.55	-5.17	-13.00	-41.73

Unless otherwise stated the results shown in this test report refer only to the sample(s) tested and such sample(s) are retained for 90 days only.

除非另有說明，此報告結果僅對測試之樣品負責，同時此樣品僅保留90天。本報告未經本公司書面許可，不可部份複製。

This document is issued by the Company subject to its General Conditions of Service printed overleaf, available on request or accessible at <http://www.sgs.com.tw/Terms-and-Conditions> and for electronic format documents, subject to Terms and Conditions for Electronic Documents at <http://www.sgs.com.tw/Terms-and-Conditions>. Attention is drawn to the limitation of liability, indemnification and jurisdiction issues defined therein. Any holder of this document is advised that information contained hereon reflects the Company's findings at the time of its intervention only and within the limits of Client's instructions, if any. The Company's sole responsibility is to its Client and this document does not exonerate parties to a transaction from exercising all their rights and obligations under the transaction documents. This document cannot be reproduced except in full, without prior written approval of the Company. Any unauthorized alteration, forgery or falsification of the content or appearance of this document is unlawful and offenders may be prosecuted to the fullest extent of the law.

Report Number :ER/2021/A0027
 Operation Mode :LTE B26
 Test Mode :Tx CH Mid
 EUT Pol :H Plane
 Test Frequency :836.5 MHz

Test Site :SAC 1
 Test Date :2021-11-12
 Temp./Humi. :23.8/53
 Antenna Pol. :Vertical
 Engineer :GN Lin

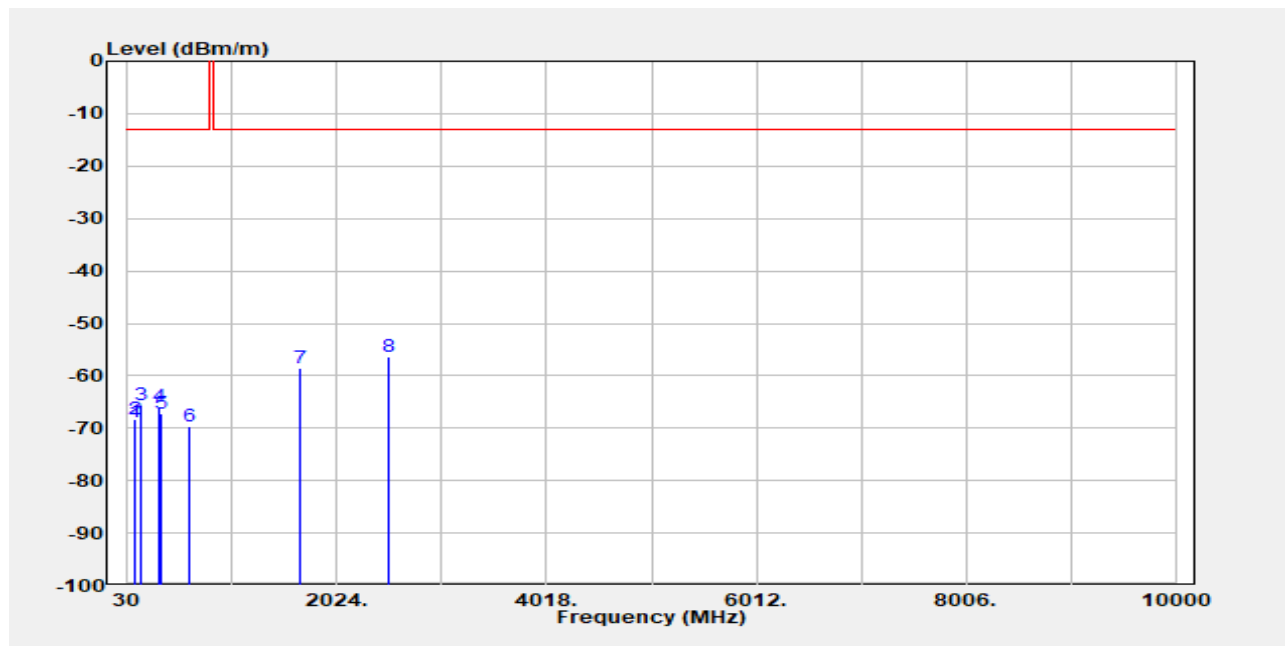

Freq. MHz	EIRP/ERP dBm	SG Output Level dBm	Antenna Gain dBi/dBd	Cable Loss dB	Limit dBm	Margin dB
101.13	-68.71	-66.81	-0.88	-1.02	-13.00	-55.71
107.60	-68.24	-65.77	-1.42	-1.04	-13.00	-55.24
149.63	-65.45	-62.68	-1.62	-1.15	-13.00	-52.45
335.55	-65.81	-68.19	4.28	-1.90	-13.00	-52.81
348.48	-67.33	-69.84	4.52	-2.01	-13.00	-54.33
610.38	-69.64	-70.63	3.48	-2.50	-13.00	-56.64
1673.00	-58.45	-63.71	9.55	-4.29	-13.00	-45.44
2509.50	-56.46	-61.88	10.62	-5.20	-13.00	-43.45

Unless otherwise stated the results shown in this test report refer only to the sample(s) tested and such sample(s) are retained for 90 days only.

除非另有說明，此報告結果僅對測試之樣品負責，同時此樣品僅保留90天。本報告未經本公司書面許可，不可部份複製。

This document is issued by the Company subject to its General Conditions of Service printed overleaf, available on request or accessible at <http://www.sgs.com.tw/Terms-and-Conditions> and for electronic format documents, subject to Terms and Conditions for Electronic Documents at <http://www.sgs.com.tw/Terms-and-Conditions>. Attention is drawn to the limitation of liability, indemnification and jurisdiction issues defined therein. Any holder of this document is advised that information contained hereon reflects the Company's findings at the time of its intervention only and within the limits of Client's instructions, if any. The Company's sole responsibility is to its Client and this document does not exonerate parties to a transaction from exercising all their rights and obligations under the transaction documents. This document cannot be reproduced except in full, without prior written approval of the Company. Any unauthorized alteration, forgery or falsification of the content or appearance of this document is unlawful and offenders may be prosecuted to the fullest extent of the law.

Report Number :ER/2021/A0027
 Operation Mode :LTE B26
 Test Mode :Tx CH Mid
 EUT Pol :H Plane
 Test Frequency :836.5 MHz

Test Site :SAC 1
 Test Date :2021-11-12
 Temp./Humi. :23.8/53
 Antenna Pol. :Horizontal
 Engineer :GN Lin

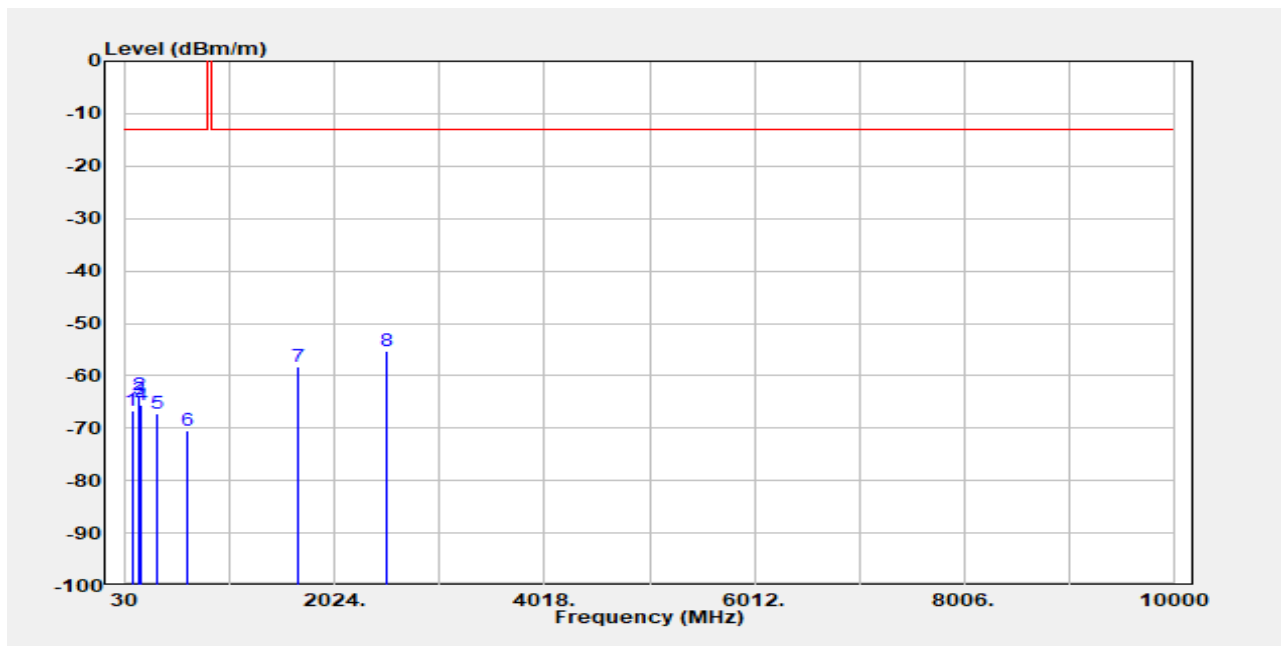

Freq. MHz	EIRP/ERP dBm	SG Output Level dBm	Antenna Gain dBi/dBd	Cable Loss dB	Limit dBm	Margin dB
89.82	-66.69	-65.28	-0.43	-0.98	-13.00	-53.69
149.63	-63.61	-60.84	-1.62	-1.15	-13.00	-50.61
164.18	-64.56	-62.42	-0.88	-1.26	-13.00	-51.56
181.97	-65.62	-66.11	1.87	-1.39	-13.00	-52.62
335.55	-67.28	-69.66	4.28	-1.90	-13.00	-54.28
610.38	-70.48	-71.47	3.48	-2.50	-13.00	-57.48
1673.00	-58.31	-63.57	9.55	-4.29	-13.00	-45.30
2509.50	-55.35	-60.78	10.62	-5.20	-13.00	-42.34

Unless otherwise stated the results shown in this test report refer only to the sample(s) tested and such sample(s) are retained for 90 days only.

除非另有說明，此報告結果僅對測試之樣品負責，同時此樣品僅保留90天。本報告未經本公司書面許可，不可部份複製。

This document is issued by the Company subject to its General Conditions of Service printed overleaf, available on request or accessible at <http://www.sgs.com.tw/Terms-and-Conditions> and for electronic format documents, subject to Terms and Conditions for Electronic Documents at <http://www.sgs.com.tw/Terms-and-Conditions>. Attention is drawn to the limitation of liability, indemnification and jurisdiction issues defined therein. Any holder of this document is advised that information contained hereon reflects the Company's findings at the time of its intervention only and within the limits of Client's instructions, if any. The Company's sole responsibility is to its Client and this document does not exonerate parties to a transaction from exercising all their rights and obligations under the transaction documents. This document cannot be reproduced except in full, without prior written approval of the Company. Any unauthorized alteration, forgery or falsification of the content or appearance of this document is unlawful and offenders may be prosecuted to the fullest extent of the law.

Report Number :ER/2021/A0027
 Operation Mode :LTE B26
 Test Mode :Tx CH High
 EUT Pol :H Plane
 Test Frequency :847.5 MHz

Test Site :SAC 1
 Test Date :2021-11-12
 Temp./Humi. :23.8/53
 Antenna Pol. :Vertical
 Engineer :GN Lin

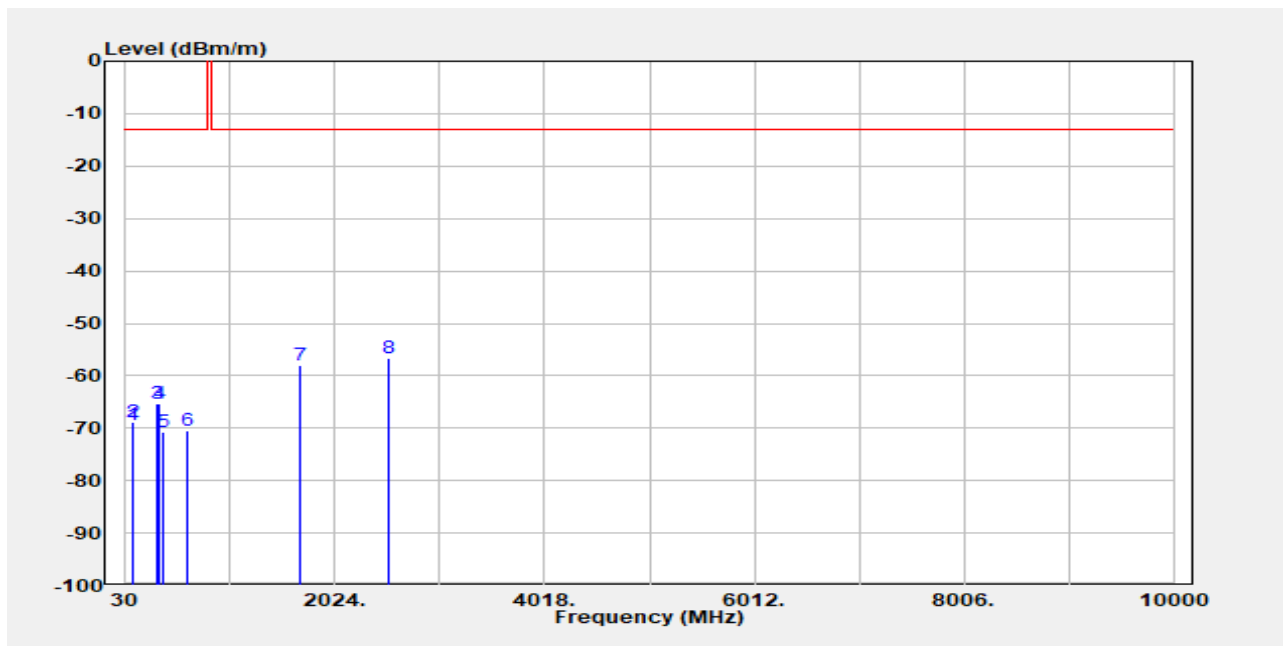

Freq. MHz	EIRP/ERP dBm	SG Output Level dBm	Antenna Gain dBi/dBd	Cable Loss dB	Limit dBm	Margin dB
101.13	-69.38	-67.48	-0.88	-1.02	-13.00	-56.38
107.60	-68.94	-66.47	-1.42	-1.04	-13.00	-55.94
335.55	-65.26	-67.64	4.28	-1.90	-13.00	-52.26
348.48	-65.44	-67.95	4.52	-2.01	-13.00	-52.44
388.90	-70.60	-72.96	4.40	-2.04	-13.00	-57.60
623.32	-70.49	-71.64	3.47	-2.32	-13.00	-57.49
1695.00	-58.12	-63.39	9.59	-4.32	-13.00	-45.11
2542.50	-56.76	-62.21	10.69	-5.23	-13.00	-43.75

Unless otherwise stated the results shown in this test report refer only to the sample(s) tested and such sample(s) are retained for 90 days only.

除非另有說明，此報告結果僅對測試之樣品負責，同時此樣品僅保留90天。本報告未經本公司書面許可，不可部份複製。

This document is issued by the Company subject to its General Conditions of Service printed overleaf, available on request or accessible at <http://www.sgs.com.tw/Terms-and-Conditions> and for electronic format documents, subject to Terms and Conditions for Electronic Documents at <http://www.sgs.com.tw/Terms-and-Conditions>. Attention is drawn to the limitation of liability, indemnification and jurisdiction issues defined therein. Any holder of this document is advised that information contained hereon reflects the Company's findings at the time of its intervention only and within the limits of Client's instructions, if any. The Company's sole responsibility is to its Client and this document does not exonerate parties to a transaction from exercising all their rights and obligations under the transaction documents. This document cannot be reproduced except in full, without prior written approval of the Company. Any unauthorized alteration, forgery or falsification of the content or appearance of this document is unlawful and offenders may be prosecuted to the fullest extent of the law.

Report Number :ER/2021/A0027
 Operation Mode :LTE B26
 Test Mode :Tx CH High
 EUT Pol :H Plane
 Test Frequency :847.5 MHz

Test Site :SAC 1
 Test Date :2021-11-12
 Temp./Humi. :23.8/53
 Antenna Pol. :Horizontal
 Engineer :GN Lin

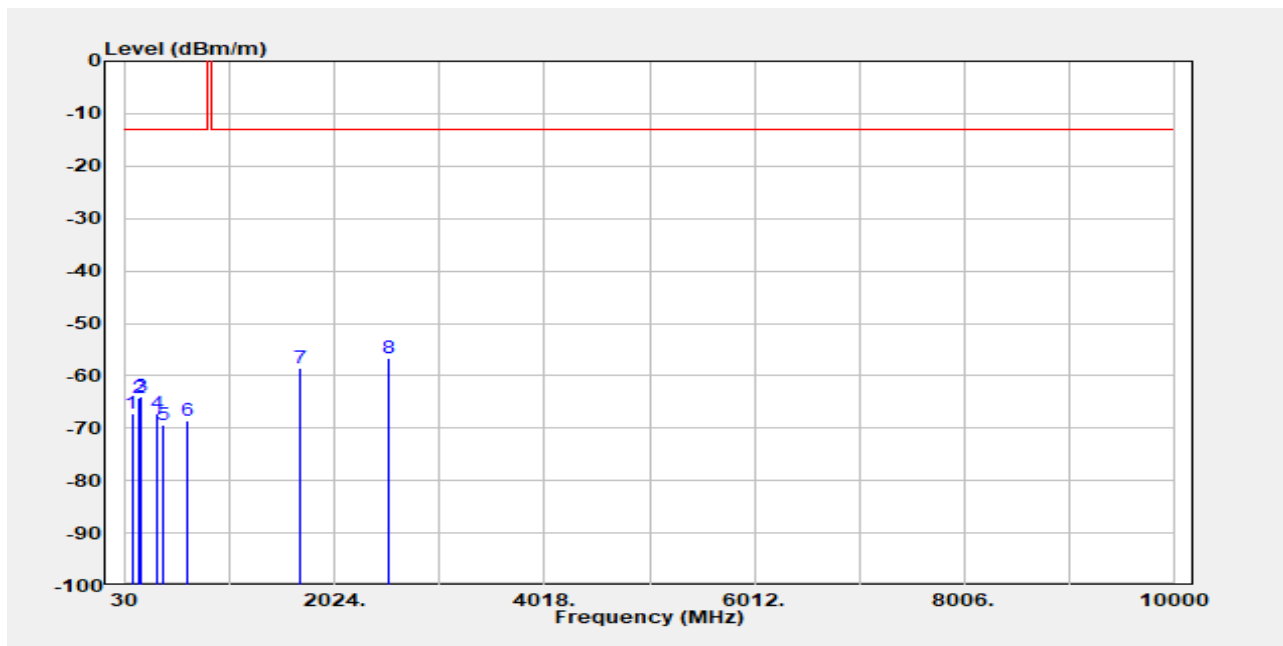

Freq. MHz	EIRP/ERP dBm	SG Output Level dBm	Antenna Gain dBi/dBd	Cable Loss dB	Limit dBm	Margin dB
89.82	-67.18	-65.77	-0.43	-0.98	-13.00	-54.18
149.63	-64.27	-61.51	-1.62	-1.15	-13.00	-51.27
170.65	-63.94	-62.45	-0.21	-1.27	-13.00	-50.94
335.55	-67.10	-69.49	4.28	-1.90	-13.00	-54.10
388.90	-69.46	-71.82	4.40	-2.04	-13.00	-56.46
610.38	-68.53	-69.51	3.48	-2.50	-13.00	-55.53
1695.00	-58.62	-63.89	9.59	-4.32	-13.00	-45.61
2542.50	-56.51	-61.96	10.69	-5.23	-13.00	-43.50

Unless otherwise stated the results shown in this test report refer only to the sample(s) tested and such sample(s) are retained for 90 days only.

除非另有說明，此報告結果僅對測試之樣品負責，同時此樣品僅保留90天。本報告未經本公司書面許可，不可部份複製。

This document is issued by the Company subject to its General Conditions of Service printed overleaf, available on request or accessible at <http://www.sgs.com.tw/Terms-and-Conditions> and for electronic format documents, subject to Terms and Conditions for Electronic Documents at <http://www.sgs.com.tw/Terms-and-Conditions>. Attention is drawn to the limitation of liability, indemnification and jurisdiction issues defined therein. Any holder of this document is advised that information contained hereon reflects the Company's findings at the time of its intervention only and within the limits of Client's instructions, if any. The Company's sole responsibility is to its Client and this document does not exonerate parties to a transaction from exercising all their rights and obligations under the transaction documents. This document cannot be reproduced except in full, without prior written approval of the Company. Any unauthorized alteration, forgery or falsification of the content or appearance of this document is unlawful and offenders may be prosecuted to the fullest extent of the law.

Report Number :ER/2021/A0027
 Operation Mode :LTE B26 Part90
 Test Mode :Tx CH Low
 EUT Pol :H Plane
 Test Frequency :815.5 MHz

Test Site :SAC 1
 Test Date :2021-11-12
 Temp./Humi. :23.8/53
 Antenna Pol. :Vertical
 Engineer :GN Lin

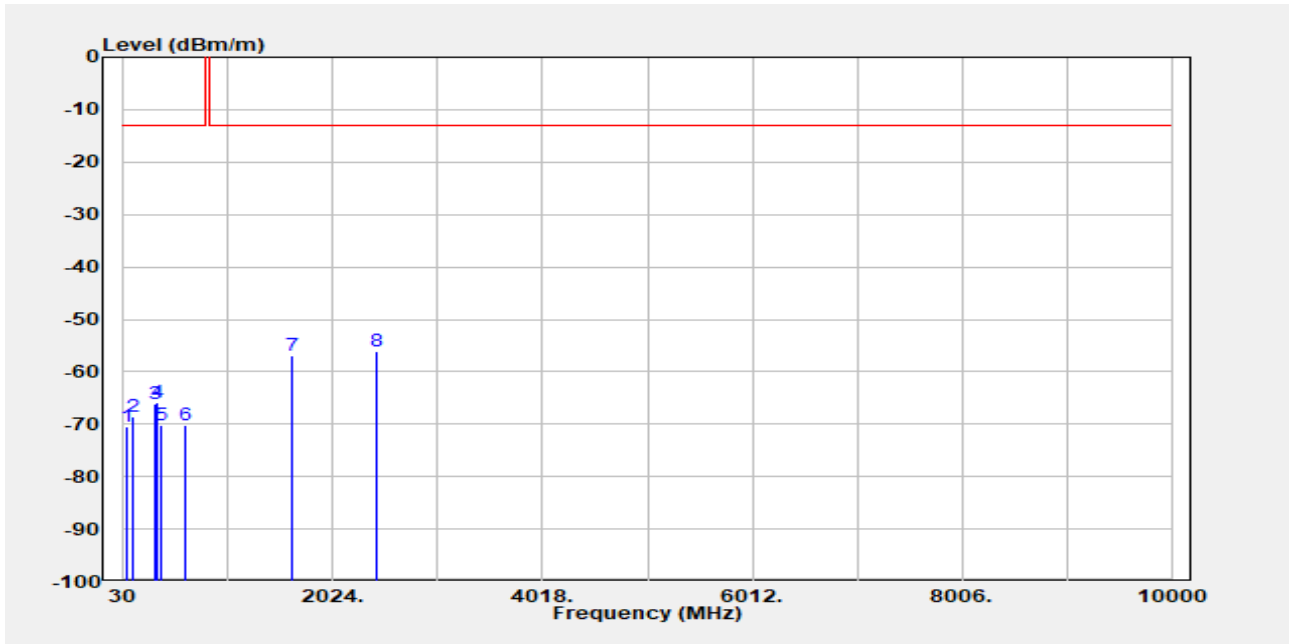

Freq. MHz	EIRP/ERP dBm	SG Output Level dBm	Antenna Gain dBi/dBd	Cable Loss dB	Limit dBm	Margin dB
60.72	-70.59	-60.47	-9.38	-0.74	-13.00	-57.59
110.83	-68.62	-66.12	-1.44	-1.06	-13.00	-55.62
335.55	-66.08	-68.46	4.28	-1.90	-13.00	-53.08
348.48	-65.75	-68.26	4.52	-2.01	-13.00	-52.75
388.90	-70.07	-72.43	4.40	-2.04	-13.00	-57.07
610.38	-70.21	-71.19	3.48	-2.50	-13.00	-57.21
1631.00	-56.97	-62.21	9.46	-4.23	-13.00	-43.96
2446.50	-56.07	-61.40	10.47	-5.15	-13.00	-43.06

Unless otherwise stated the results shown in this test report refer only to the sample(s) tested and such sample(s) are retained for 90 days only.

除非另有說明，此報告結果僅對測試之樣品負責，同時此樣品僅保留90天。本報告未經本公司書面許可，不可部份複製。

This document is issued by the Company subject to its General Conditions of Service printed overleaf, available on request or accessible at <http://www.sgs.com.tw/Terms-and-Conditions> and for electronic format documents, subject to Terms and Conditions for Electronic Documents at <http://www.sgs.com.tw/Terms-and-Conditions>. Attention is drawn to the limitation of liability, indemnification and jurisdiction issues defined therein. Any holder of this document is advised that information contained hereon reflects the Company's findings at the time of its intervention only and within the limits of Client's instructions, if any. The Company's sole responsibility is to its Client and this document does not exonerate parties to a transaction from exercising all their rights and obligations under the transaction documents. This document cannot be reproduced except in full, without prior written approval of the Company. Any unauthorized alteration, forgery or falsification of the content or appearance of this document is unlawful and offenders may be prosecuted to the fullest extent of the law.

Report Number :ER/2021/A0027
 Operation Mode :LTE B26 Part90
 Test Mode :Tx CH Low
 EUT Pol :H Plane
 Test Frequency :815.5 MHz

Test Site :SAC 1
 Test Date :2021-11-12
 Temp./Humi. :23.8/53
 Antenna Pol. :Horizontal
 Engineer :GN Lin

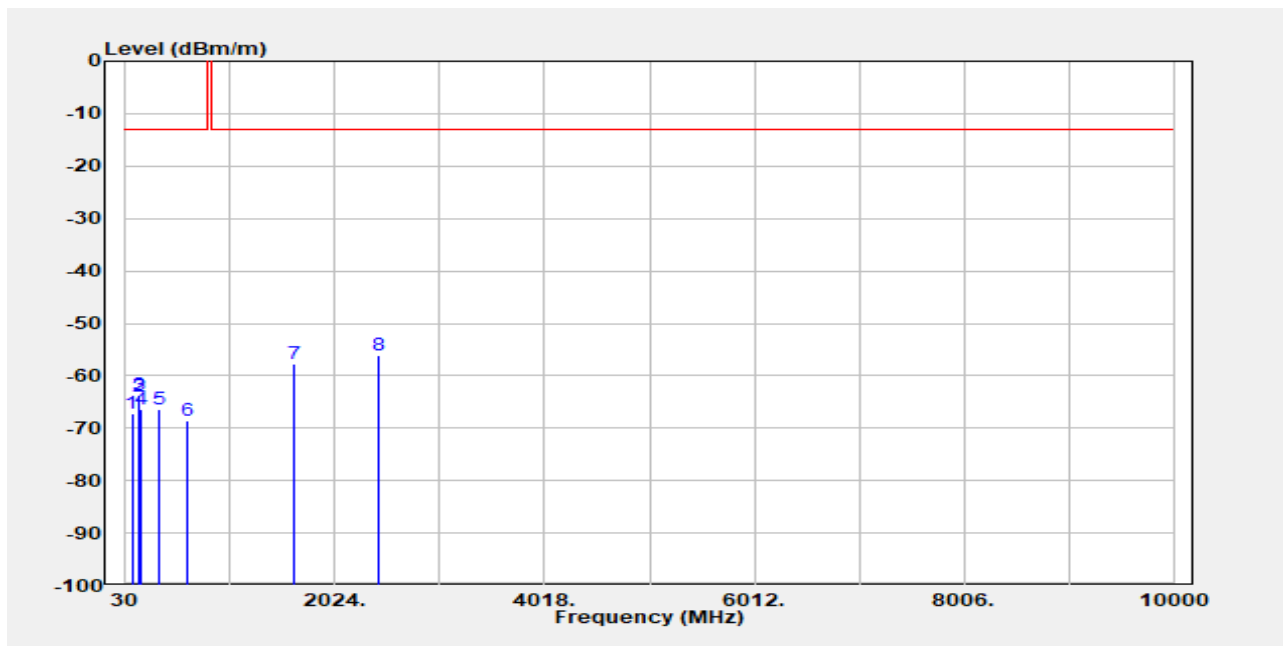

Freq. MHz	EIRP/ERP dBm	SG Output Level dBm	Antenna Gain dBi/dBd	Cable Loss dB	Limit dBm	Margin dB
89.82	-67.21	-65.80	-0.43	-0.98	-13.00	-54.21
149.63	-64.04	-61.27	-1.62	-1.15	-13.00	-51.04
164.18	-63.61	-61.48	-0.88	-1.26	-13.00	-50.61
181.97	-66.48	-66.97	1.87	-1.39	-13.00	-53.48
345.25	-66.51	-68.99	4.44	-1.97	-13.00	-53.51
610.38	-68.65	-69.64	3.48	-2.50	-13.00	-55.65
1631.00	-57.78	-63.01	9.46	-4.23	-13.00	-44.77
2446.50	-55.99	-61.31	10.47	-5.15	-13.00	-42.98

Unless otherwise stated the results shown in this test report refer only to the sample(s) tested and such sample(s) are retained for 90 days only.

除非另有說明，此報告結果僅對測試之樣品負責，同時此樣品僅保留90天。本報告未經本公司書面許可，不可部份複製。

This document is issued by the Company subject to its General Conditions of Service printed overleaf, available on request or accessible at <http://www.sgs.com.tw/Terms-and-Conditions> and for electronic format documents, subject to Terms and Conditions for Electronic Documents at <http://www.sgs.com.tw/Terms-and-Conditions>. Attention is drawn to the limitation of liability, indemnification and jurisdiction issues defined therein. Any holder of this document is advised that information contained hereon reflects the Company's findings at the time of its intervention only and within the limits of Client's instructions, if any. The Company's sole responsibility is to its Client and this document does not exonerate parties to a transaction from exercising all their rights and obligations under the transaction documents. This document cannot be reproduced except in full, without prior written approval of the Company. Any unauthorized alteration, forgery or falsification of the content or appearance of this document is unlawful and offenders may be prosecuted to the fullest extent of the law.

Report Number :ER/2021/A0027
 Operation Mode :LTE B26 Part90
 Test Mode :Tx CH Mid
 EUT Pol :H Plane
 Test Frequency :819 MHz

Test Site :SAC 1
 Test Date :2021-11-12
 Temp./Humi. :23.8/53
 Antenna Pol. :Vertical
 Engineer :GN Lin

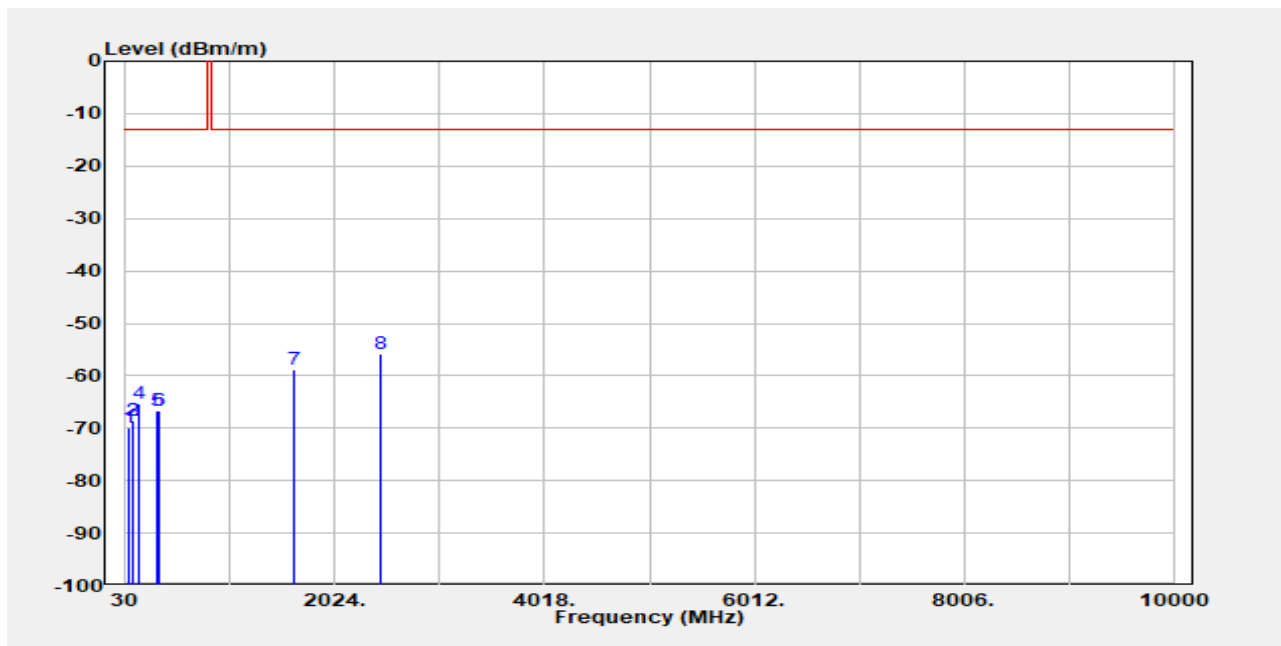

Freq. MHz	EIRP/ERP dBm	SG Output Level dBm	Antenna Gain dBi/dBd	Cable Loss dB	Limit dBm	Margin dB
60.72	-69.82	-59.70	-9.38	-0.74	-13.00	-56.82
101.13	-68.59	-66.70	-0.88	-1.02	-13.00	-55.59
107.60	-68.50	-66.03	-1.42	-1.04	-13.00	-55.50
149.63	-65.30	-62.53	-1.62	-1.15	-13.00	-52.30
335.55	-66.59	-68.97	4.28	-1.90	-13.00	-53.59
348.48	-66.61	-69.12	4.52	-2.01	-13.00	-53.61
1638.00	-58.88	-64.12	9.48	-4.24	-13.00	-45.87
2457.00	-55.90	-61.26	10.51	-5.15	-13.00	-42.89

Unless otherwise stated the results shown in this test report refer only to the sample(s) tested and such sample(s) are retained for 90 days only.

除非另有說明，此報告結果僅對測試之樣品負責，同時此樣品僅保留90天。本報告未經本公司書面許可，不可部份複製。

This document is issued by the Company subject to its General Conditions of Service printed overleaf, available on request or accessible at <http://www.sgs.com.tw/Terms-and-Conditions> and for electronic format documents, subject to Terms and Conditions for Electronic Documents at <http://www.sgs.com.tw/Terms-and-Conditions>. Attention is drawn to the limitation of liability, indemnification and jurisdiction issues defined therein. Any holder of this document is advised that information contained hereon reflects the Company's findings at the time of its intervention only and within the limits of Client's instructions, if any. The Company's sole responsibility is to its Client and this document does not exonerate parties to a transaction from exercising all their rights and obligations under the transaction documents. This document cannot be reproduced except in full, without prior written approval of the Company. Any unauthorized alteration, forgery or falsification of the content or appearance of this document is unlawful and offenders may be prosecuted to the fullest extent of the law.

Report Number :ER/2021/A0027
 Operation Mode :LTE B26 Part90
 Test Mode :Tx CH Mid
 EUT Pol :H Plane
 Test Frequency :819 MHz

Test Site :SAC 1
 Test Date :2021-11-12
 Temp./Humi. :23.8/53
 Antenna Pol. :Horizontal
 Engineer :GN Lin

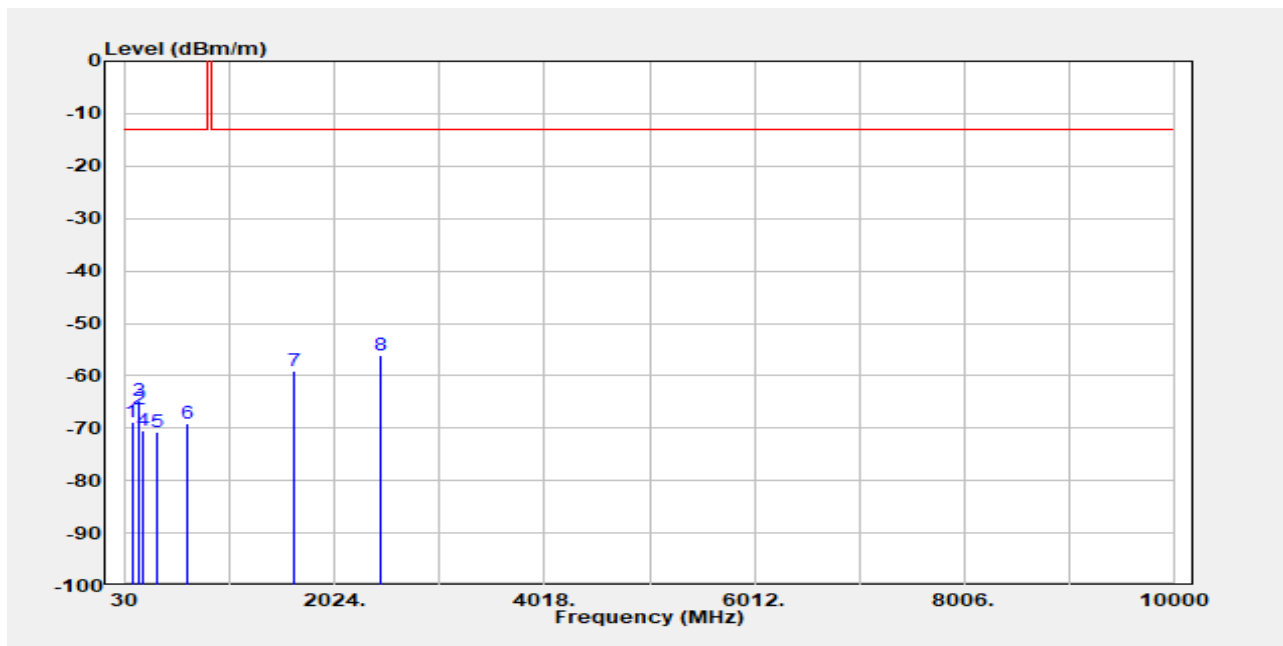

Freq. MHz	EIRP/ERP dBm	SG Output Level dBm	Antenna Gain dBi/dBd	Cable Loss dB	Limit dBm	Margin dB
89.82	-68.83	-67.42	-0.43	-0.98	-13.00	-55.83
149.63	-66.38	-63.61	-1.62	-1.15	-13.00	-53.38
164.18	-64.88	-62.75	-0.88	-1.26	-13.00	-51.88
191.67	-70.58	-72.65	3.50	-1.43	-13.00	-57.58
335.55	-70.64	-73.03	4.28	-1.90	-13.00	-57.64
610.38	-69.01	-70.00	3.48	-2.50	-13.00	-56.01
1638.00	-59.20	-64.43	9.48	-4.24	-13.00	-46.19
2457.00	-56.05	-61.41	10.51	-5.15	-13.00	-43.04

Unless otherwise stated the results shown in this test report refer only to the sample(s) tested and such sample(s) are retained for 90 days only.

除非另有說明，此報告結果僅對測試之樣品負責，同時此樣品僅保留90天。本報告未經本公司書面許可，不可部份複製。

This document is issued by the Company subject to its General Conditions of Service printed overleaf, available on request or accessible at <http://www.sgs.com.tw/Terms-and-Conditions> and for electronic format documents, subject to Terms and Conditions for Electronic Documents at <http://www.sgs.com.tw/Terms-and-Conditions>. Attention is drawn to the limitation of liability, indemnification and jurisdiction issues defined therein. Any holder of this document is advised that information contained hereon reflects the Company's findings at the time of its intervention only and within the limits of Client's instructions, if any. The Company's sole responsibility is to its Client and this document does not exonerate parties to a transaction from exercising all their rights and obligations under the transaction documents. This document cannot be reproduced except in full, without prior written approval of the Company. Any unauthorized alteration, forgery or falsification of the content or appearance of this document is unlawful and offenders may be prosecuted to the fullest extent of the law.

Report Number :ER/2021/A0027
 Operation Mode :LTE B26 Part90
 Test Mode :Tx CH High
 EUT Pol :H Plane
 Test Frequency :822.5 MHz

Test Site :SAC 1
 Test Date :2021-11-12
 Temp./Humi. :23.8/53
 Antenna Pol. :Vertical
 Engineer :GN Lin

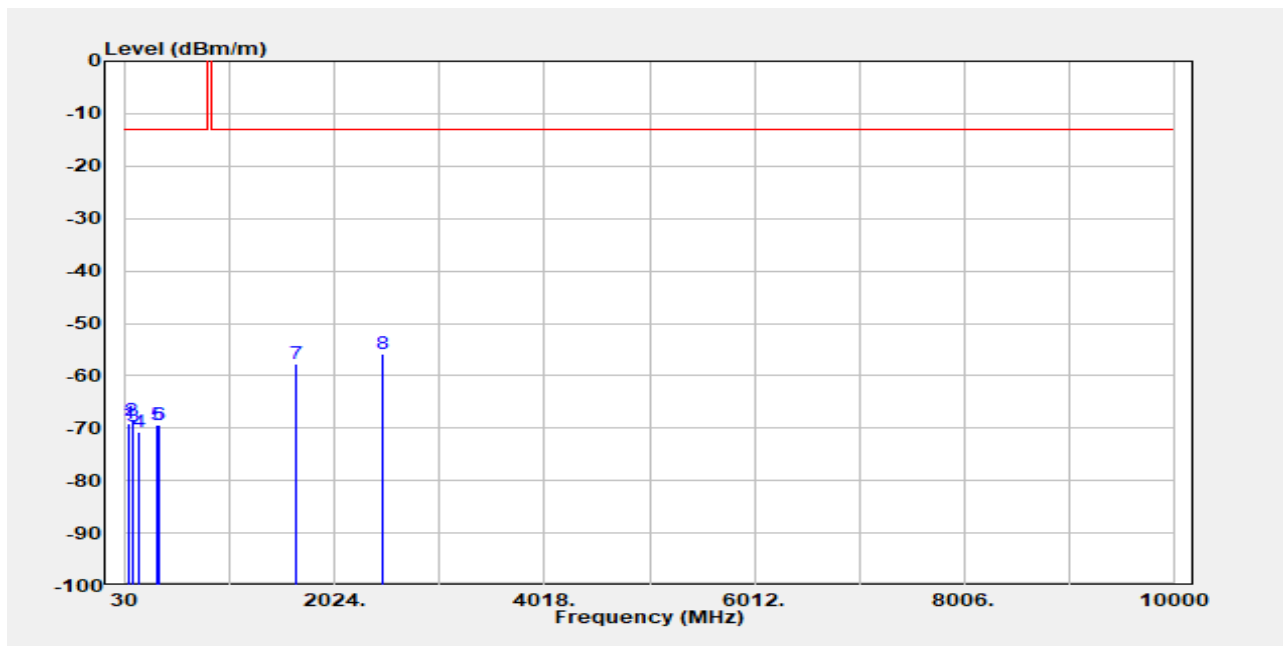

Freq. MHz	EIRP/ERP dBm	SG Output Level dBm	Antenna Gain dBi/dBd	Cable Loss dB	Limit dBm	Margin dB
60.72	-69.05	-58.92	-9.38	-0.74	-13.00	-56.05
89.82	-68.58	-67.17	-0.43	-0.98	-13.00	-55.58
101.13	-69.59	-67.69	-0.88	-1.02	-13.00	-56.59
164.18	-70.79	-68.66	-0.88	-1.26	-13.00	-57.79
335.55	-69.46	-71.85	4.28	-1.90	-13.00	-56.46
348.48	-69.43	-71.94	4.52	-2.01	-13.00	-56.43
1645.00	-57.70	-62.94	9.49	-4.25	-13.00	-44.69
2467.50	-55.92	-61.29	10.54	-5.16	-13.00	-42.91

Unless otherwise stated the results shown in this test report refer only to the sample(s) tested and such sample(s) are retained for 90 days only.

除非另有說明，此報告結果僅對測試之樣品負責，同時此樣品僅保留90天。本報告未經本公司書面許可，不可部份複製。

This document is issued by the Company subject to its General Conditions of Service printed overleaf, available on request or accessible at <http://www.sgs.com.tw/Terms-and-Conditions> and for electronic format documents, subject to Terms and Conditions for Electronic Documents at <http://www.sgs.com.tw/Terms-and-Conditions>. Attention is drawn to the limitation of liability, indemnification and jurisdiction issues defined therein. Any holder of this document is advised that information contained hereon reflects the Company's findings at the time of its intervention only and within the limits of Client's instructions, if any. The Company's sole responsibility is to its Client and this document does not exonerate parties to a transaction from exercising all their rights and obligations under the transaction documents. This document cannot be reproduced except in full, without prior written approval of the Company. Any unauthorized alteration, forgery or falsification of the content or appearance of this document is unlawful and offenders may be prosecuted to the fullest extent of the law.

Report Number :ER/2021/A0027
 Operation Mode :LTE B26 Part90
 Test Mode :Tx CH High
 EUT Pol :H Plane
 Test Frequency :822.5 MHz

Test Site :SAC 1
 Test Date :2021-11-12
 Temp./Humi. :23.8/53
 Antenna Pol. :Horizontal
 Engineer :GN Lin

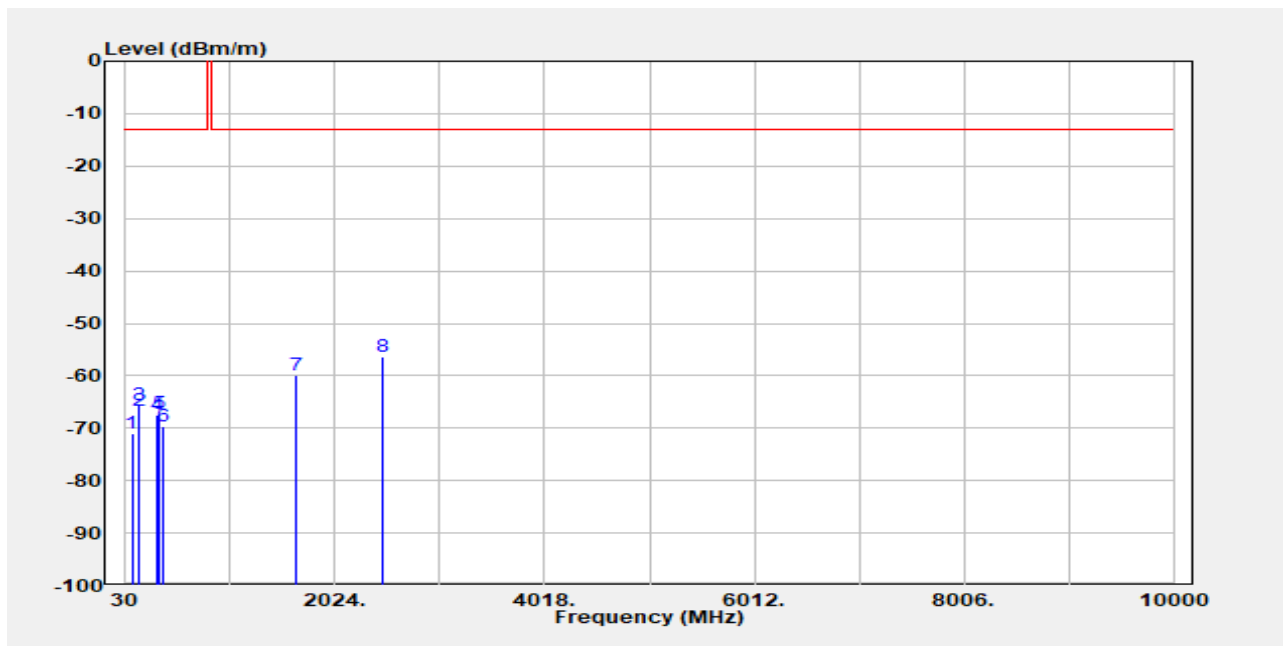

Freq. MHz	EIRP/ERP dBm	SG Output Level dBm	Antenna Gain dBi/dBd	Cable Loss dB	Limit dBm	Margin dB
89.82	-70.98	-69.57	-0.43	-0.98	-13.00	-57.98
149.63	-66.70	-63.93	-1.62	-1.15	-13.00	-53.70
164.18	-65.58	-63.45	-0.88	-1.26	-13.00	-52.58
335.55	-67.44	-69.83	4.28	-1.90	-13.00	-54.44
348.48	-67.11	-69.62	4.52	-2.01	-13.00	-54.11
388.90	-69.69	-72.05	4.40	-2.04	-13.00	-56.69
1645.00	-60.02	-65.26	9.49	-4.25	-13.00	-47.01
2467.50	-56.39	-61.76	10.54	-5.16	-13.00	-43.38

Unless otherwise stated the results shown in this test report refer only to the sample(s) tested and such sample(s) are retained for 90 days only.

除非另有說明，此報告結果僅對測試之樣品負責，同時此樣品僅保留90天。本報告未經本公司書面許可，不可部份複製。

This document is issued by the Company subject to its General Conditions of Service printed overleaf, available on request or accessible at <http://www.sgs.com.tw/Terms-and-Conditions> and for electronic format documents, subject to Terms and Conditions for Electronic Documents at <http://www.sgs.com.tw/Terms-and-Conditions>. Attention is drawn to the limitation of liability, indemnification and jurisdiction issues defined therein. Any holder of this document is advised that information contained hereon reflects the Company's findings at the time of its intervention only and within the limits of Client's instructions, if any. The Company's sole responsibility is to its Client and this document does not exonerate parties to a transaction from exercising all their rights and obligations under the transaction documents. This document cannot be reproduced except in full, without prior written approval of the Company. Any unauthorized alteration, forgery or falsification of the content or appearance of this document is unlawful and offenders may be prosecuted to the fullest extent of the law.

Report Number :ER/2021/A0027
 Operation Mode :LTE B30
 Test Mode :Tx CH Mid
 EUT Pol :H Plane
 Test Frequency :2310 MHz

Test Site :SAC 1
 Test Date :2021-12-21
 Temp./Humi. :23.3/65
 Antenna Pol. :Vertical
 Engineer :GN Lin

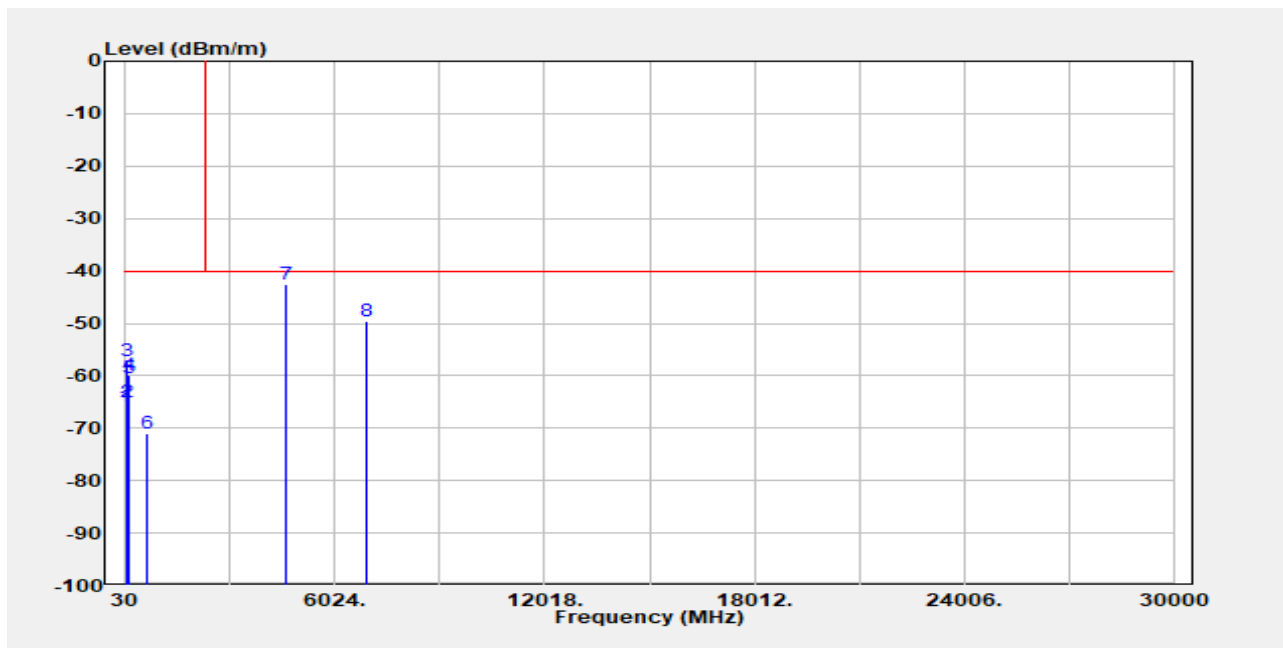

Freq. MHz	EIRP/ERP dBm	SG Output Level dBm	Antenna Gain dBi/dBd	Cable Loss dB	Limit dBm	Margin dB
36.47	-65.85	-51.54	-13.67	-0.64	-40.00	-25.85
44.55	-65.00	-51.45	-12.85	-0.69	-40.00	-25.00
59.10	-57.12	-46.79	-9.60	-0.73	-40.00	-17.12
110.83	-59.83	-57.33	-1.44	-1.06	-40.00	-19.83
139.93	-60.36	-57.04	-2.00	-1.32	-40.00	-20.36
665.35	-71.08	-72.00	3.73	-2.81	-40.00	-31.08
4620.00	-42.65	-47.98	12.42	-7.09	-40.00	-2.65
6930.00	-49.59	-51.52	11.74	-9.82	-40.00	-9.59

Unless otherwise stated the results shown in this test report refer only to the sample(s) tested and such sample(s) are retained for 90 days only.

除非另有說明，此報告結果僅對測試之樣品負責，同時此樣品僅保留90天。本報告未經本公司書面許可，不可部份複製。

This document is issued by the Company subject to its General Conditions of Service printed overleaf, available on request or accessible at <http://www.sgs.com.tw/Terms-and-Conditions> and for electronic format documents, subject to Terms and Conditions for Electronic Documents at <http://www.sgs.com.tw/Terms-and-Conditions>. Attention is drawn to the limitation of liability, indemnification and jurisdiction issues defined therein. Any holder of this document is advised that information contained hereon reflects the Company's findings at the time of its intervention only and within the limits of Client's instructions, if any. The Company's sole responsibility is to its Client and this document does not exonerate parties to a transaction from exercising all their rights and obligations under the transaction documents. This document cannot be reproduced except in full, without prior written approval of the Company. Any unauthorized alteration, forgery or falsification of the content or appearance of this document is unlawful and offenders may be prosecuted to the fullest extent of the law.

Report Number :ER/2021/A0027
 Operation Mode :LTE B30
 Test Mode :Tx CH Mid
 EUT Pol :H Plane
 Test Frequency :2310 MHz

Test Site :SAC 1
 Test Date :2021-12-21
 Temp./Humi. :23.3/65
 Antenna Pol. :Horizontal
 Engineer :GN Lin

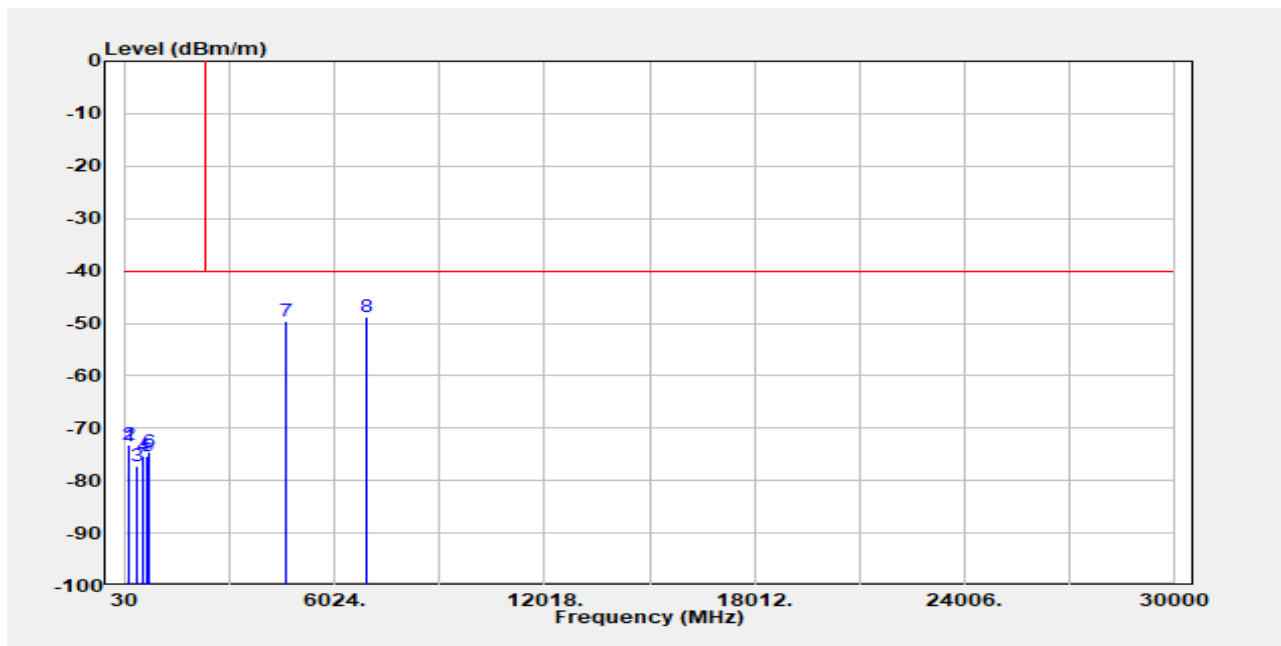

Freq. MHz	EIRP/ERP dBm	SG Output Level dBm	Antenna Gain dBi/dBd	Cable Loss dB	Limit dBm	Margin dB
138.32	-73.57	-70.24	-2.03	-1.30	-40.00	-33.57
146.40	-73.05	-70.11	-1.73	-1.21	-40.00	-33.05
367.88	-77.29	-79.69	4.38	-1.98	-40.00	-37.29
519.85	-75.34	-77.24	4.10	-2.20	-40.00	-35.34
655.65	-75.26	-76.47	3.61	-2.41	-40.00	-35.26
704.15	-74.44	-75.15	3.55	-2.84	-40.00	-34.44
4620.00	-49.52	-54.85	12.42	-7.09	-40.00	-9.52
6930.00	-48.76	-50.68	11.74	-9.82	-40.00	-8.76

Unless otherwise stated the results shown in this test report refer only to the sample(s) tested and such sample(s) are retained for 90 days only.

除非另有說明，此報告結果僅對測試之樣品負責，同時此樣品僅保留90天。本報告未經本公司書面許可，不可部份複製。

This document is issued by the Company subject to its General Conditions of Service printed overleaf, available on request or accessible at <http://www.sgs.com.tw/Terms-and-Conditions> and for electronic format documents, subject to Terms and Conditions for Electronic Documents at <http://www.sgs.com.tw/Terms-and-Conditions>. Attention is drawn to the limitation of liability, indemnification and jurisdiction issues defined therein. Any holder of this document is advised that information contained hereon reflects the Company's findings at the time of its intervention only and within the limits of Client's instructions, if any. The Company's sole responsibility is to its Client and this document does not exonerate parties to a transaction from exercising all their rights and obligations under the transaction documents. This document cannot be reproduced except in full, without prior written approval of the Company. Any unauthorized alteration, forgery or falsification of the content or appearance of this document is unlawful and offenders may be prosecuted to the fullest extent of the law.

Report Number :ER/2021/A0027
 Operation Mode :LTE B38
 Test Mode :Tx CH Low
 EUT Pol :H Plane
 Test Frequency :2577.5 MHz

Test Site :SAC 1
 Test Date :2021-11-12
 Temp./Humi. :23.8/53
 Antenna Pol. :Vertical
 Engineer :GN Lin

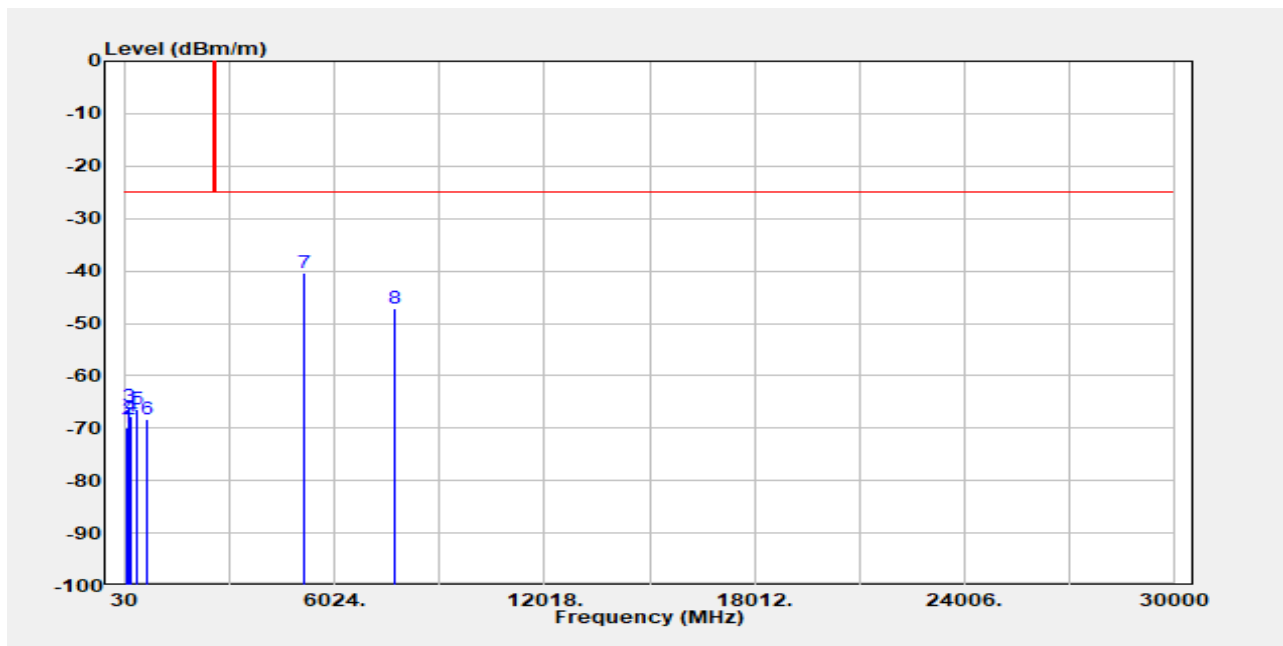

Freq. MHz	EIRP/ERP dBm	SG Output Level dBm	Antenna Gain dBi/dBd	Cable Loss dB	Limit dBm	Margin dB
62.33	-69.96	-60.37	-8.83	-0.76	-25.00	-44.96
107.60	-68.39	-65.92	-1.42	-1.04	-25.00	-43.39
149.63	-65.94	-63.17	-1.62	-1.15	-25.00	-40.94
164.18	-67.64	-65.51	-0.88	-1.26	-25.00	-42.64
335.55	-66.32	-68.71	4.28	-1.90	-25.00	-41.32
658.88	-68.17	-69.45	3.66	-2.38	-25.00	-43.17
5155.00	-40.34	-44.53	12.13	-7.93	-25.00	-15.33
7732.50	-47.12	-48.45	11.50	-10.17	-25.00	-22.11

Unless otherwise stated the results shown in this test report refer only to the sample(s) tested and such sample(s) are retained for 90 days only.

除非另有說明，此報告結果僅對測試之樣品負責，同時此樣品僅保留90天。本報告未經本公司書面許可，不可部份複製。

This document is issued by the Company subject to its General Conditions of Service printed overleaf, available on request or accessible at <http://www.sgs.com.tw/Terms-and-Conditions> and for electronic format documents, subject to Terms and Conditions for Electronic Documents at <http://www.sgs.com.tw/Terms-and-Conditions>. Attention is drawn to the limitation of liability, indemnification and jurisdiction issues defined therein. Any holder of this document is advised that information contained hereon reflects the Company's findings at the time of its intervention only and within the limits of Client's instructions, if any. The Company's sole responsibility is to its Client and this document does not exonerate parties to a transaction from exercising all their rights and obligations under the transaction documents. This document cannot be reproduced except in full, without prior written approval of the Company. Any unauthorized alteration, forgery or falsification of the content or appearance of this document is unlawful and offenders may be prosecuted to the fullest extent of the law.

Report Number :ER/2021/A0027
 Operation Mode :LTE B38
 Test Mode :Tx CH Low
 EUT Pol :H Plane
 Test Frequency :2577.5 MHz

Test Site :SAC 1
 Test Date :2021-11-12
 Temp./Humi. :23.8/53
 Antenna Pol. :Horizontal
 Engineer :GN Lin

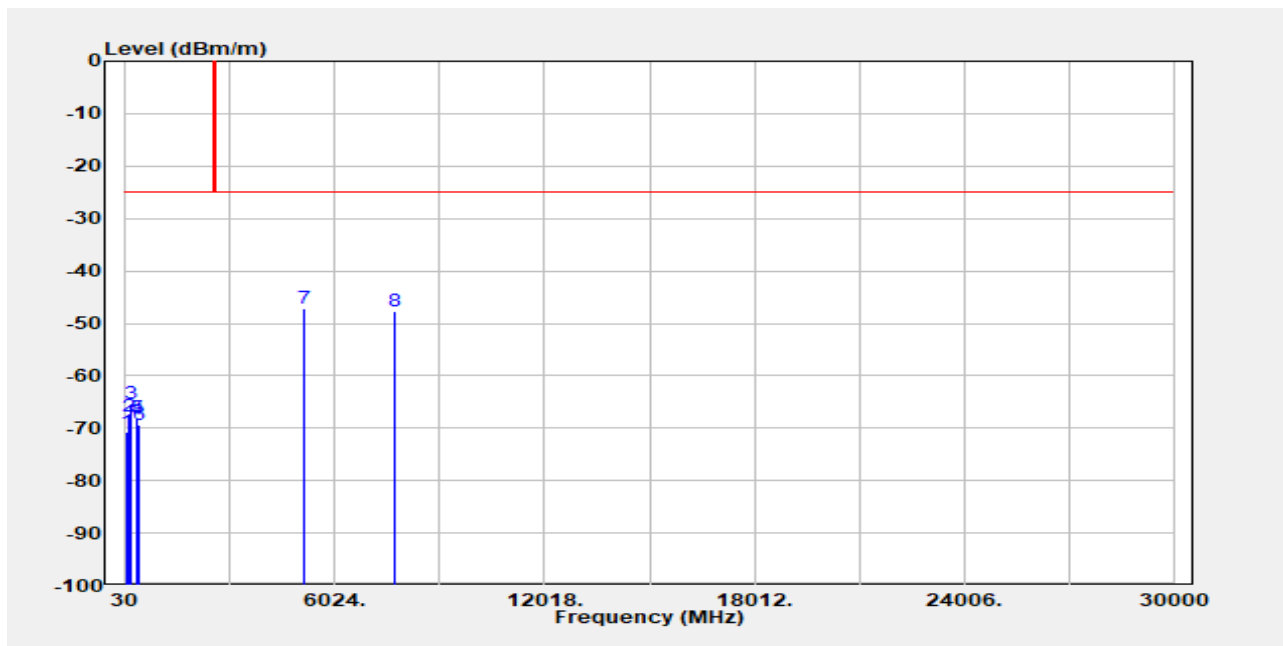

Freq. MHz	EIRP/ERP dBm	SG Output Level dBm	Antenna Gain dBi/dBd	Cable Loss dB	Limit dBm	Margin dB
89.82	-70.63	-69.22	-0.43	-0.98	-25.00	-45.63
149.63	-67.68	-64.91	-1.62	-1.15	-25.00	-42.68
164.18	-65.42	-63.28	-0.88	-1.26	-25.00	-40.42
335.55	-68.28	-70.66	4.28	-1.90	-25.00	-43.28
348.48	-68.08	-70.59	4.52	-2.01	-25.00	-43.08
388.90	-69.46	-71.82	4.40	-2.04	-25.00	-44.46
5155.00	-47.13	-51.33	12.13	-7.93	-25.00	-22.12
7732.50	-47.59	-48.92	11.50	-10.17	-25.00	-22.58

Unless otherwise stated the results shown in this test report refer only to the sample(s) tested and such sample(s) are retained for 90 days only.

除非另有說明，此報告結果僅對測試之樣品負責，同時此樣品僅保留90天。本報告未經本公司書面許可，不可部份複製。

This document is issued by the Company subject to its General Conditions of Service printed overleaf, available on request or accessible at <http://www.sgs.com.tw/Terms-and-Conditions> and for electronic format documents, subject to Terms and Conditions for Electronic Documents at <http://www.sgs.com.tw/Terms-and-Conditions>. Attention is drawn to the limitation of liability, indemnification and jurisdiction issues defined therein. Any holder of this document is advised that information contained hereon reflects the Company's findings at the time of its intervention only and within the limits of Client's instructions, if any. The Company's sole responsibility is to its Client and this document does not exonerate parties to a transaction from exercising all their rights and obligations under the transaction documents. This document cannot be reproduced except in full, without prior written approval of the Company. Any unauthorized alteration, forgery or falsification of the content or appearance of this document is unlawful and offenders may be prosecuted to the fullest extent of the law.

Report Number :ER/2021/A0027
 Operation Mode :LTE B38
 Test Mode :Tx CH Mid
 EUT Pol :H Plane
 Test Frequency :2595 MHz

Test Site :SAC 1
 Test Date :2021-11-12
 Temp./Humi. :23.8/53
 Antenna Pol. :Vertical
 Engineer :GN Lin

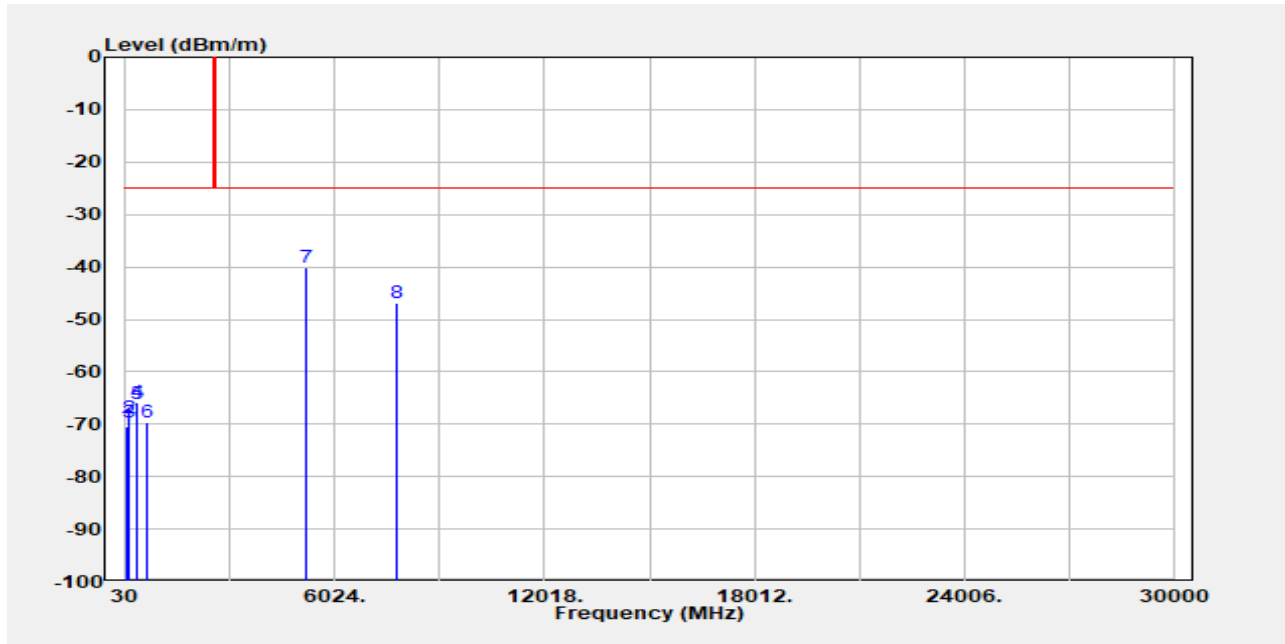

Freq. MHz	EIRP/ERP dBm	SG Output Level dBm	Antenna Gain dBi/dBd	Cable Loss dB	Limit dBm	Margin dB
60.72	-70.37	-60.25	-9.38	-0.74	-25.00	-45.37
107.60	-68.94	-66.47	-1.42	-1.04	-25.00	-43.94
149.63	-69.67	-66.90	-1.62	-1.15	-25.00	-44.67
335.55	-65.93	-68.31	4.28	-1.90	-25.00	-40.93
348.48	-66.25	-68.76	4.52	-2.01	-25.00	-41.25
623.32	-69.60	-70.75	3.47	-2.32	-25.00	-44.60
5190.00	-40.00	-44.45	12.34	-7.89	-25.00	-14.99
7785.00	-46.79	-47.78	11.50	-10.51	-25.00	-21.78

Unless otherwise stated the results shown in this test report refer only to the sample(s) tested and such sample(s) are retained for 90 days only.

除非另有說明，此報告結果僅對測試之樣品負責，同時此樣品僅保留90天。本報告未經本公司書面許可，不可部份複製。

This document is issued by the Company subject to its General Conditions of Service printed overleaf, available on request or accessible at <http://www.sgs.com.tw/Terms-and-Conditions> and for electronic format documents, subject to Terms and Conditions for Electronic Documents at <http://www.sgs.com.tw/Terms-and-Conditions>. Attention is drawn to the limitation of liability, indemnification and jurisdiction issues defined therein. Any holder of this document is advised that information contained hereon reflects the Company's findings at the time of its intervention only and within the limits of Client's instructions, if any. The Company's sole responsibility is to its Client and this document does not exonerate parties to a transaction from exercising all their rights and obligations under the transaction documents. This document cannot be reproduced except in full, without prior written approval of the Company. Any unauthorized alteration, forgery or falsification of the content or appearance of this document is unlawful and offenders may be prosecuted to the fullest extent of the law.

Report Number :ER/2021/A0027
 Operation Mode :LTE B38
 Test Mode :Tx CH Mid
 EUT Pol :H Plane
 Test Frequency :2595 MHz

Test Site :SAC 1
 Test Date :2021-11-12
 Temp./Humi. :23.8/53
 Antenna Pol. :Horizontal
 Engineer :GN Lin

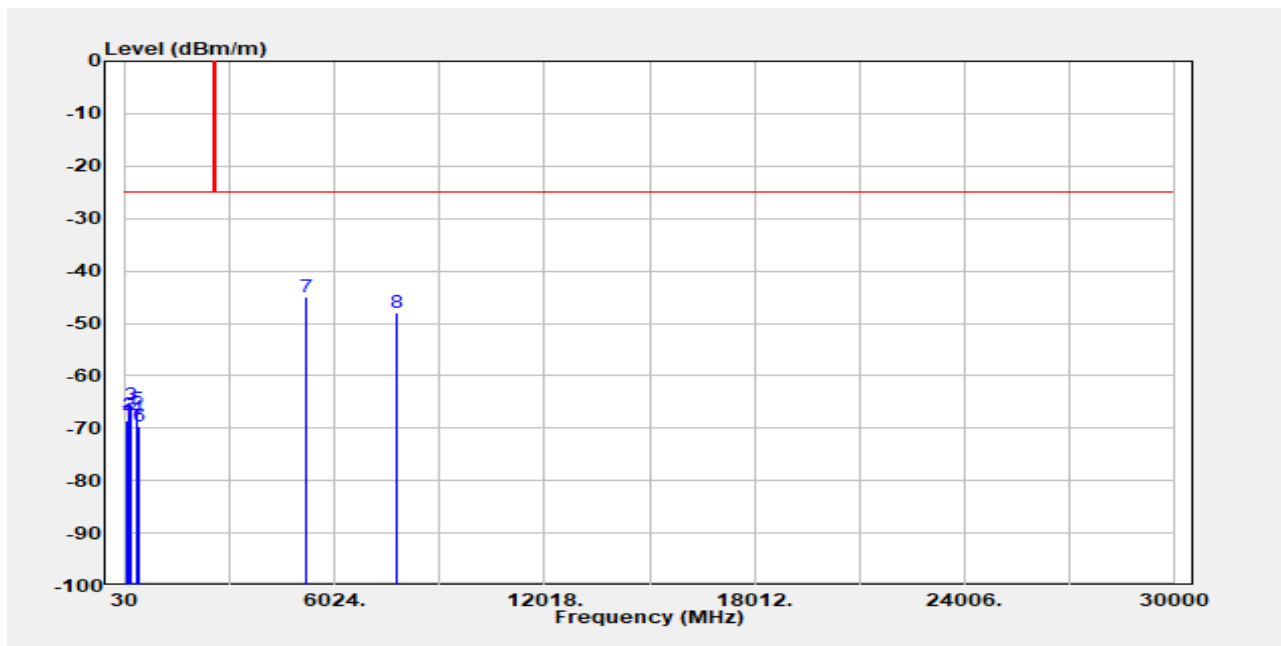

Freq. MHz	EIRP/ERP dBm	SG Output Level dBm	Antenna Gain dBi/dBd	Cable Loss dB	Limit dBm	Margin dB
89.82	-68.61	-67.20	-0.43	-0.98	-25.00	-43.61
149.63	-67.44	-64.67	-1.62	-1.15	-25.00	-42.44
164.18	-65.47	-63.34	-0.88	-1.26	-25.00	-40.47
335.55	-68.02	-70.40	4.28	-1.90	-25.00	-43.02
348.48	-66.38	-68.89	4.52	-2.01	-25.00	-41.38
388.90	-69.54	-71.90	4.40	-2.04	-25.00	-44.54
5190.00	-45.02	-49.47	12.34	-7.89	-25.00	-20.01
7785.00	-47.89	-48.88	11.50	-10.51	-25.00	-22.88

Unless otherwise stated the results shown in this test report refer only to the sample(s) tested and such sample(s) are retained for 90 days only.

除非另有說明，此報告結果僅對測試之樣品負責，同時此樣品僅保留90天。本報告未經本公司書面許可，不可部份複製。

This document is issued by the Company subject to its General Conditions of Service printed overleaf, available on request or accessible at <http://www.sgs.com.tw/Terms-and-Conditions> and for electronic format documents, subject to Terms and Conditions for Electronic Documents at <http://www.sgs.com.tw/Terms-and-Conditions>. Attention is drawn to the limitation of liability, indemnification and jurisdiction issues defined therein. Any holder of this document is advised that information contained hereon reflects the Company's findings at the time of its intervention only and within the limits of Client's instructions, if any. The Company's sole responsibility is to its Client and this document does not exonerate parties to a transaction from exercising all their rights and obligations under the transaction documents. This document cannot be reproduced except in full, without prior written approval of the Company. Any unauthorized alteration, forgery or falsification of the content or appearance of this document is unlawful and offenders may be prosecuted to the fullest extent of the law.

Report Number :ER/2021/A0027
 Operation Mode :LTE B38
 Test Mode :Tx CH High
 EUT Pol :H Plane
 Test Frequency :2612.5 MHz

Test Site :SAC 1
 Test Date :2021-11-12
 Temp./Humi. :23.8/53
 Antenna Pol. :Vertical
 Engineer :GN Lin

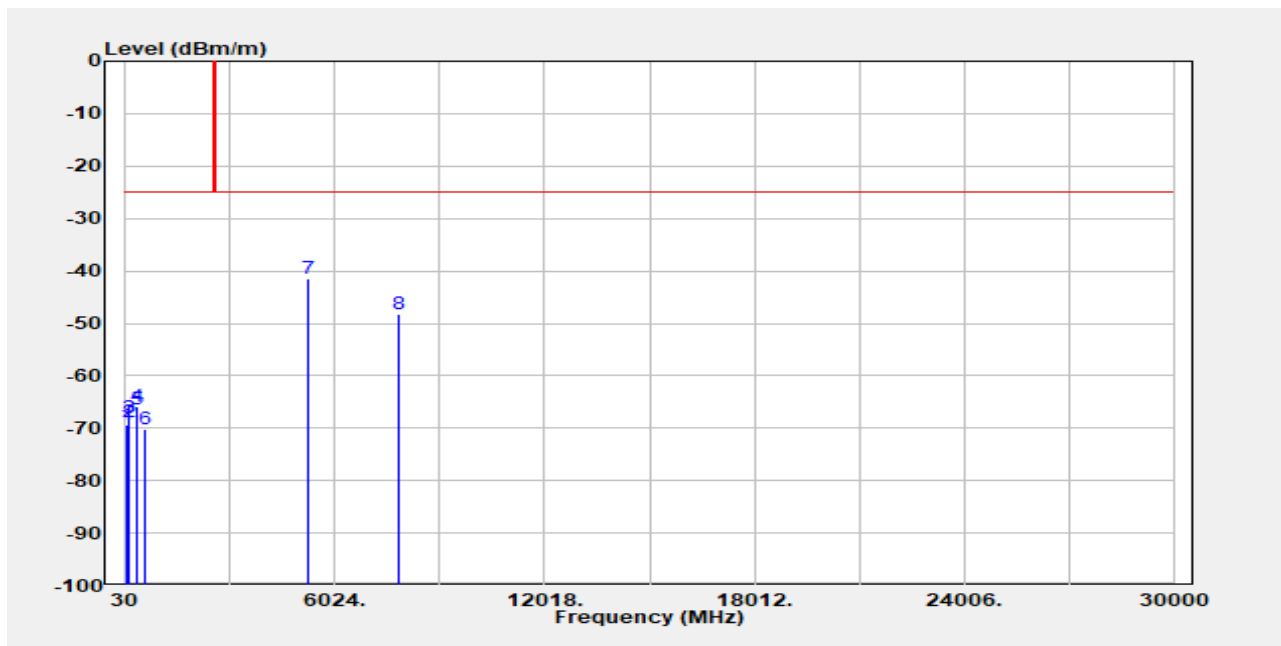

Freq. MHz	EIRP/ERP dBm	SG Output Level dBm	Antenna Gain dBi/dBd	Cable Loss dB	Limit dBm	Margin dB
62.33	-69.38	-59.80	-8.83	-0.76	-25.00	-44.38
99.52	-68.92	-67.19	-0.72	-1.01	-25.00	-43.92
149.63	-68.06	-65.29	-1.62	-1.15	-25.00	-43.06
335.55	-65.83	-68.21	4.28	-1.90	-25.00	-40.83
348.48	-66.51	-69.02	4.52	-2.01	-25.00	-41.51
610.38	-70.22	-71.21	3.48	-2.50	-25.00	-45.22
5225.00	-41.35	-46.00	12.60	-7.96	-25.00	-16.34
7837.50	-48.30	-49.04	11.35	-10.62	-25.00	-23.29

Unless otherwise stated the results shown in this test report refer only to the sample(s) tested and such sample(s) are retained for 90 days only.

除非另有說明，此報告結果僅對測試之樣品負責，同時此樣品僅保留90天。本報告未經本公司書面許可，不可部份複製。

This document is issued by the Company subject to its General Conditions of Service printed overleaf, available on request or accessible at <http://www.sgs.com.tw/Terms-and-Conditions> and for electronic format documents, subject to Terms and Conditions for Electronic Documents at <http://www.sgs.com.tw/Terms-and-Conditions>. Attention is drawn to the limitation of liability, indemnification and jurisdiction issues defined therein. Any holder of this document is advised that information contained hereon reflects the Company's findings at the time of its intervention only and within the limits of Client's instructions, if any. The Company's sole responsibility is to its Client and this document does not exonerate parties to a transaction from exercising all their rights and obligations under the transaction documents. This document cannot be reproduced except in full, without prior written approval of the Company. Any unauthorized alteration, forgery or falsification of the content or appearance of this document is unlawful and offenders may be prosecuted to the fullest extent of the law.

Report Number :ER/2021/A0027
 Operation Mode :LTE B38
 Test Mode :Tx CH High
 EUT Pol :H Plane
 Test Frequency :2612.5 MHz

Test Site :SAC 1
 Test Date :2021-11-12
 Temp./Humi. :23.8/53
 Antenna Pol. :Horizontal
 Engineer :GN Lin

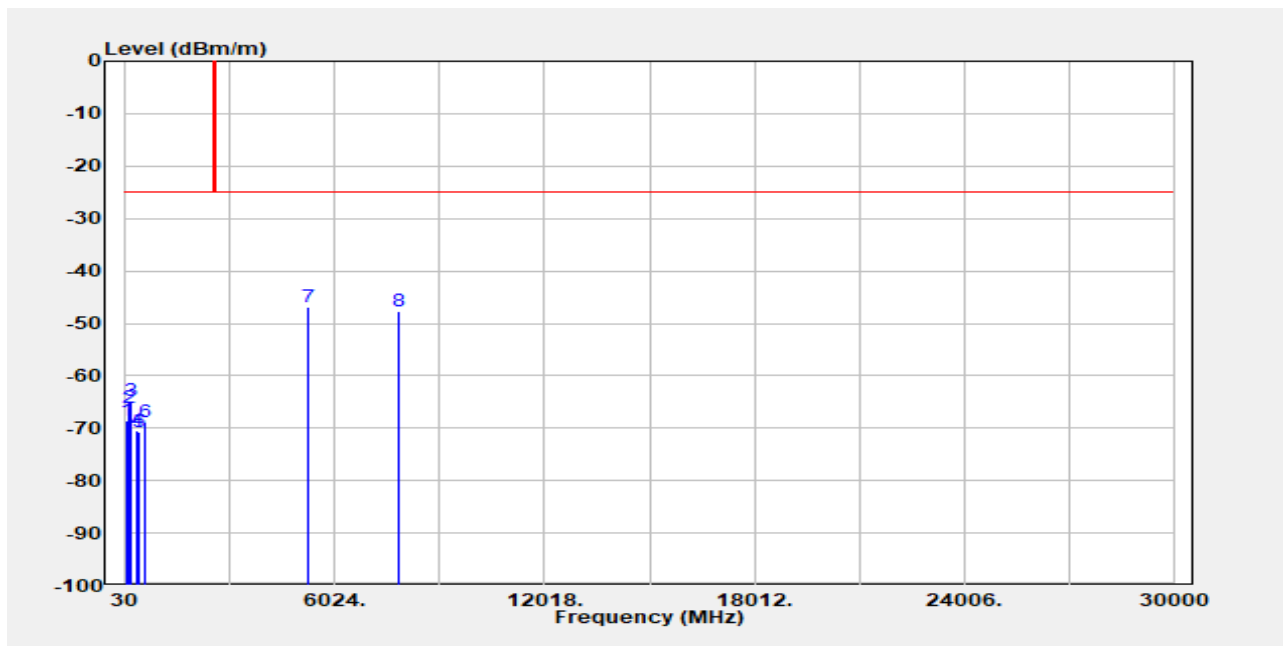

Freq. MHz	EIRP/ERP dBm	SG Output Level dBm	Antenna Gain dBi/dBd	Cable Loss dB	Limit dBm	Margin dB
89.82	-68.56	-67.15	-0.43	-0.98	-25.00	-43.56
149.63	-66.04	-63.28	-1.62	-1.15	-25.00	-41.04
164.18	-64.86	-62.72	-0.88	-1.26	-25.00	-39.86
335.55	-70.47	-72.85	4.28	-1.90	-25.00	-45.47
388.90	-70.63	-72.99	4.40	-2.04	-25.00	-45.63
610.38	-68.78	-69.77	3.48	-2.50	-25.00	-43.78
5225.00	-47.00	-51.64	12.60	-7.96	-25.00	-21.99
7837.50	-47.73	-48.46	11.35	-10.62	-25.00	-22.72

Unless otherwise stated the results shown in this test report refer only to the sample(s) tested and such sample(s) are retained for 90 days only.

除非另有說明，此報告結果僅對測試之樣品負責，同時此樣品僅保留90天。本報告未經本公司書面許可，不可部份複製。

This document is issued by the Company subject to its General Conditions of Service printed overleaf, available on request or accessible at <http://www.sgs.com.tw/Terms-and-Conditions> and for electronic format documents, subject to Terms and Conditions for Electronic Documents at <http://www.sgs.com.tw/Terms-and-Conditions>. Attention is drawn to the limitation of liability, indemnification and jurisdiction issues defined therein. Any holder of this document is advised that information contained hereon reflects the Company's findings at the time of its intervention only and within the limits of Client's instructions, if any. The Company's sole responsibility is to its Client and this document does not exonerate parties to a transaction from exercising all their rights and obligations under the transaction documents. This document cannot be reproduced except in full, without prior written approval of the Company. Any unauthorized alteration, forgery or falsification of the content or appearance of this document is unlawful and offenders may be prosecuted to the fullest extent of the law.

Report Number :ER/2021/A0027
 Operation Mode :LTE B41
 Test Mode :Tx CH Low
 EUT Pol :H Plane
 Test Frequency :2506 MHz

Test Site :SAC 1
 Test Date :2021-12-03
 Temp./Humi. :23.0/45
 Antenna Pol. :Vertical
 Engineer :GN Lin

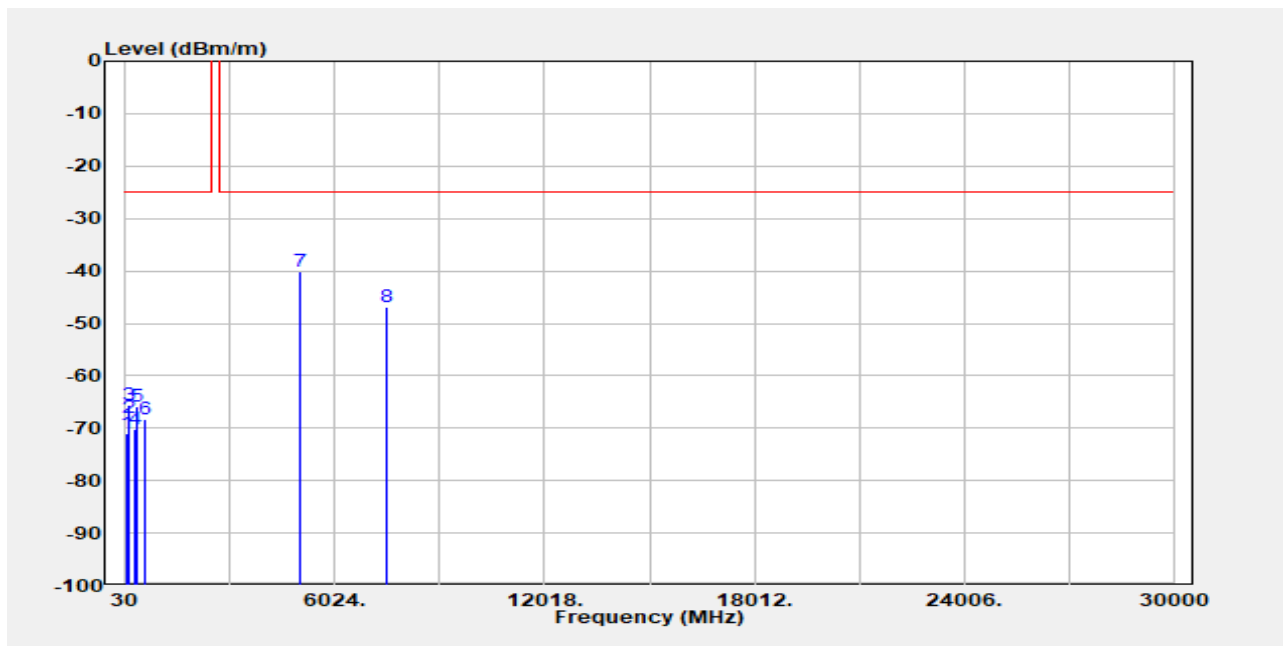

Freq. MHz	EIRP/ERP dBm	SG Output Level dBm	Antenna Gain dBi/dBd	Cable Loss dB	Limit dBm	Margin dB
60.72	-71.11	-60.98	-9.38	-0.74	-25.00	-46.11
107.60	-68.07	-65.60	-1.42	-1.04	-25.00	-43.07
149.63	-65.59	-62.82	-1.62	-1.15	-25.00	-40.59
321.00	-70.07	-72.58	4.19	-1.68	-25.00	-45.07
335.55	-65.92	-68.30	4.28	-1.90	-25.00	-40.92
610.38	-68.29	-69.27	3.48	-2.50	-25.00	-43.29
5012.00	-39.98	-44.90	12.40	-7.48	-25.00	-14.97
7518.00	-46.97	-48.75	11.04	-9.25	-25.00	-21.96

Unless otherwise stated the results shown in this test report refer only to the sample(s) tested and such sample(s) are retained for 90 days only.

除非另有說明，此報告結果僅對測試之樣品負責，同時此樣品僅保留90天。本報告未經本公司書面許可，不可部份複製。

This document is issued by the Company subject to its General Conditions of Service printed overleaf, available on request or accessible at <http://www.sgs.com.tw/Terms-and-Conditions> and for electronic format documents, subject to Terms and Conditions for Electronic Documents at <http://www.sgs.com.tw/Terms-and-Conditions>. Attention is drawn to the limitation of liability, indemnification and jurisdiction issues defined therein. Any holder of this document is advised that information contained hereon reflects the Company's findings at the time of its intervention only and within the limits of Client's instructions, if any. The Company's sole responsibility is to its Client and this document does not exonerate parties to a transaction from exercising all their rights and obligations under the transaction documents. This document cannot be reproduced except in full, without prior written approval of the Company. Any unauthorized alteration, forgery or falsification of the content or appearance of this document is unlawful and offenders may be prosecuted to the fullest extent of the law.

Report Number :ER/2021/A0027
 Operation Mode :LTE B41
 Test Mode :Tx CH Low
 EUT Pol :H Plane
 Test Frequency :2506 MHz

Test Site :SAC 1
 Test Date :2021-12-03
 Temp./Humi. :23.0/45
 Antenna Pol. :Horizontal
 Engineer :GN Lin

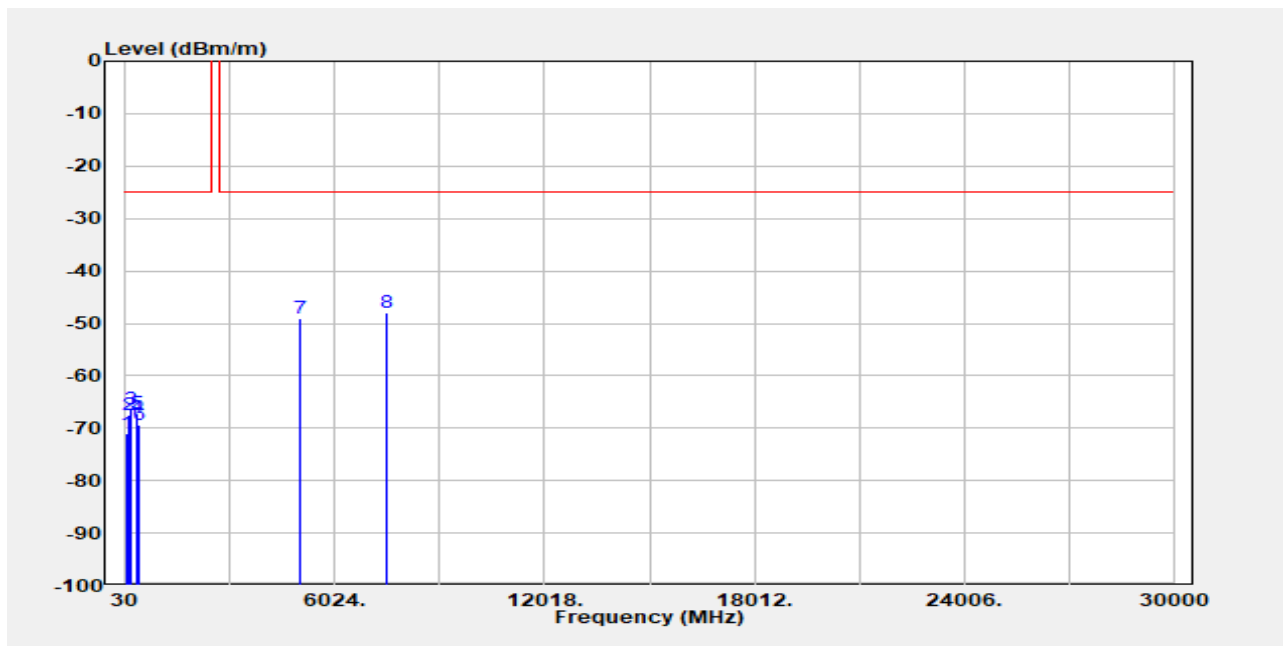

Freq. MHz	EIRP/ERP dBm	SG Output Level dBm	Antenna Gain dBi/dBd	Cable Loss dB	Limit dBm	Margin dB
89.82	-70.88	-69.47	-0.43	-0.98	-25.00	-45.88
149.63	-67.36	-64.59	-1.62	-1.15	-25.00	-42.36
164.18	-66.35	-64.22	-0.88	-1.26	-25.00	-41.35
335.55	-68.15	-70.53	4.28	-1.90	-25.00	-43.15
348.48	-67.26	-69.77	4.52	-2.01	-25.00	-42.26
388.90	-69.34	-71.70	4.40	-2.04	-25.00	-44.34
5012.00	-49.18	-54.10	12.40	-7.48	-25.00	-24.17
7518.00	-47.95	-49.73	11.04	-9.25	-25.00	-22.94

Unless otherwise stated the results shown in this test report refer only to the sample(s) tested and such sample(s) are retained for 90 days only.

除非另有說明，此報告結果僅對測試之樣品負責，同時此樣品僅保留90天。本報告未經本公司書面許可，不可部份複製。

This document is issued by the Company subject to its General Conditions of Service printed overleaf, available on request or accessible at <http://www.sgs.com.tw/Terms-and-Conditions> and for electronic format documents, subject to Terms and Conditions for Electronic Documents at <http://www.sgs.com.tw/Terms-and-Conditions>. Attention is drawn to the limitation of liability, indemnification and jurisdiction issues defined therein. Any holder of this document is advised that information contained hereon reflects the Company's findings at the time of its intervention only and within the limits of Client's instructions, if any. The Company's sole responsibility is to its Client and this document does not exonerate parties to a transaction from exercising all their rights and obligations under the transaction documents. This document cannot be reproduced except in full, without prior written approval of the Company. Any unauthorized alteration, forgery or falsification of the content or appearance of this document is unlawful and offenders may be prosecuted to the fullest extent of the law.

Report Number :ER/2021/A0027
 Operation Mode :LTE B41
 Test Mode :Tx CH Mid
 EUT Pol :H Plane
 Test Frequency :2593 MHz

Test Site :SAC 1
 Test Date :2021-12-03
 Temp./Humi. :23.0/45
 Antenna Pol. :Vertical
 Engineer :GN Lin

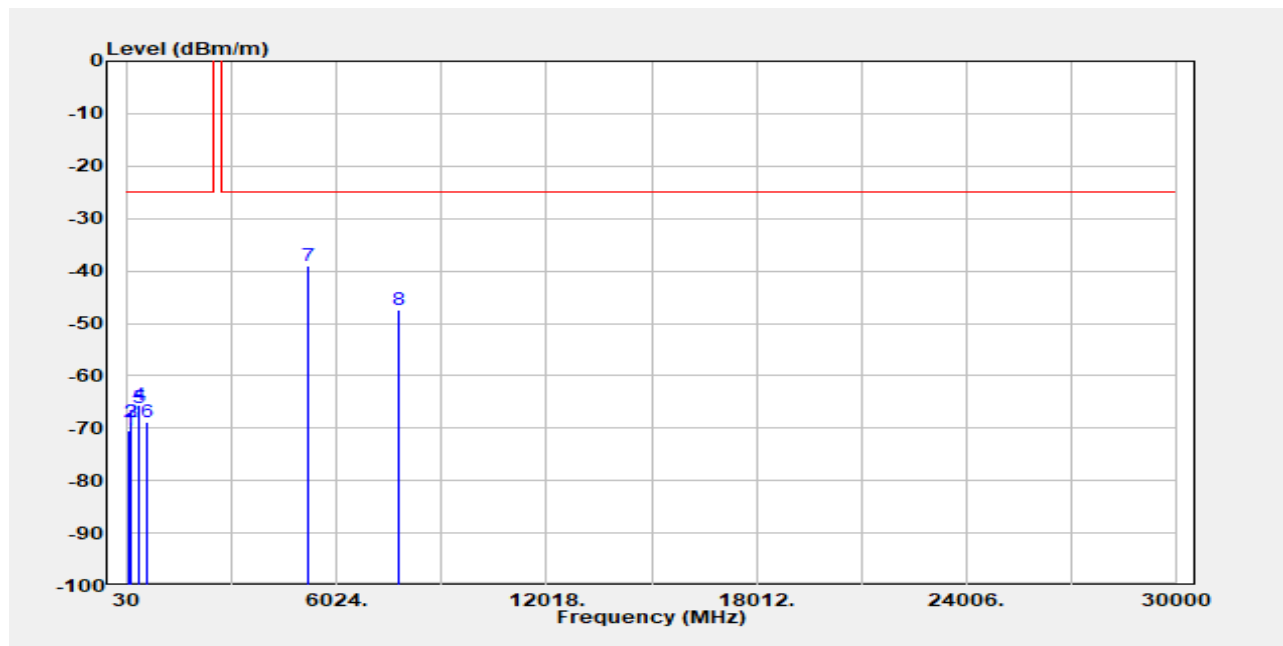

Freq. MHz	EIRP/ERP dBm	SG Output Level dBm	Antenna Gain dBi/dBd	Cable Loss dB	Limit dBm	Margin dB
62.33	-70.35	-60.77	-8.83	-0.76	-25.00	-45.35
107.60	-68.90	-66.43	-1.42	-1.04	-25.00	-43.90
149.63	-68.90	-66.13	-1.62	-1.15	-25.00	-43.90
335.55	-65.46	-67.85	4.28	-1.90	-25.00	-40.46
348.48	-66.18	-68.69	4.52	-2.01	-25.00	-41.18
610.38	-68.86	-69.85	3.48	-2.50	-25.00	-43.86
5186.00	-39.10	-43.53	12.32	-7.89	-25.00	-14.09
7779.00	-47.48	-48.51	11.50	-10.47	-25.00	-22.47

Unless otherwise stated the results shown in this test report refer only to the sample(s) tested and such sample(s) are retained for 90 days only.

除非另有說明，此報告結果僅對測試之樣品負責，同時此樣品僅保留90天。本報告未經本公司書面許可，不可部份複製。

This document is issued by the Company subject to its General Conditions of Service printed overleaf, available on request or accessible at <http://www.sgs.com.tw/Terms-and-Conditions> and for electronic format documents, subject to Terms and Conditions for Electronic Documents at <http://www.sgs.com.tw/Terms-and-Conditions>. Attention is drawn to the limitation of liability, indemnification and jurisdiction issues defined therein. Any holder of this document is advised that information contained hereon reflects the Company's findings at the time of its intervention only and within the limits of Client's instructions, if any. The Company's sole responsibility is to its Client and this document does not exonerate parties to a transaction from exercising all their rights and obligations under the transaction documents. This document cannot be reproduced except in full, without prior written approval of the Company. Any unauthorized alteration, forgery or falsification of the content or appearance of this document is unlawful and offenders may be prosecuted to the fullest extent of the law.

Report Number :ER/2021/A0027
 Operation Mode :LTE B41
 Test Mode :Tx CH Mid
 EUT Pol :H Plane
 Test Frequency :2593 MHz

Test Site :SAC 1
 Test Date :2021-12-03
 Temp./Humi. :23.0/45
 Antenna Pol. :Horizontal
 Engineer :GN Lin

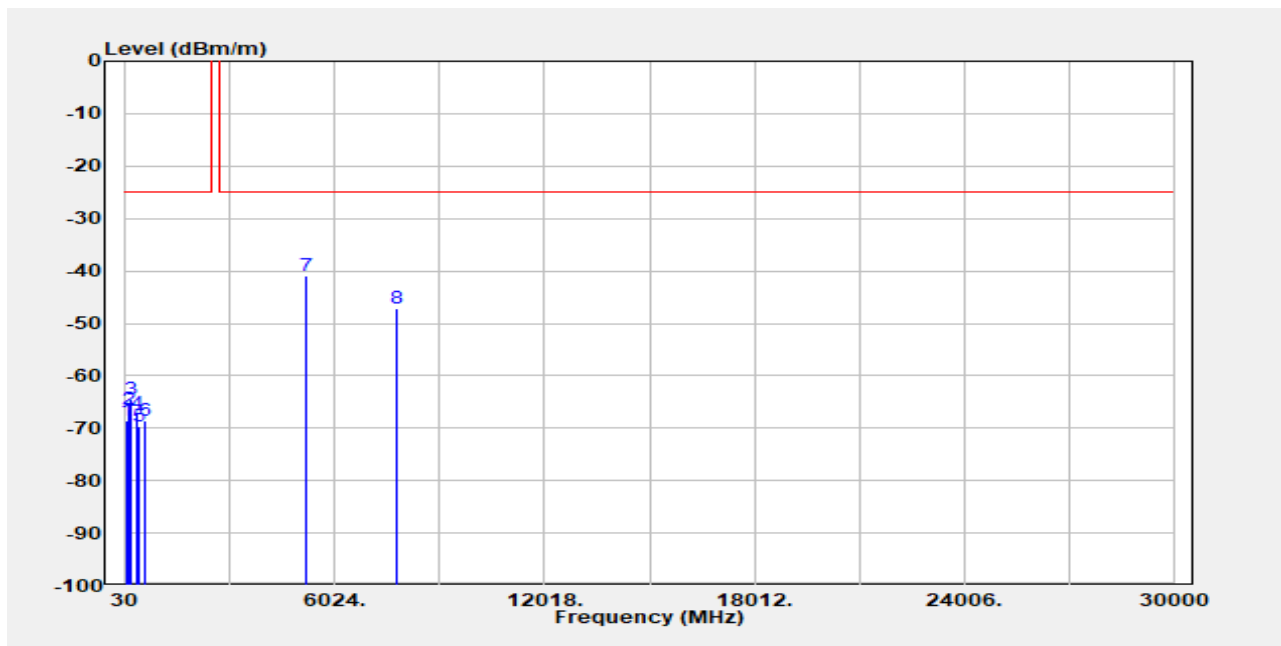

Freq. MHz	EIRP/ERP dBm	SG Output Level dBm	Antenna Gain dBi/dBd	Cable Loss dB	Limit dBm	Margin dB
89.82	-68.48	-67.07	-0.43	-0.98	-25.00	-43.48
149.63	-66.50	-63.74	-1.62	-1.15	-25.00	-41.50
164.18	-64.43	-62.29	-0.88	-1.26	-25.00	-39.43
348.48	-67.33	-69.84	4.52	-2.01	-25.00	-42.33
388.90	-69.62	-71.98	4.40	-2.04	-25.00	-44.62
610.38	-68.45	-69.44	3.48	-2.50	-25.00	-43.45
5186.00	-40.86	-45.28	12.32	-7.89	-25.00	-15.85
7779.00	-47.21	-48.24	11.50	-10.47	-25.00	-22.20

Unless otherwise stated the results shown in this test report refer only to the sample(s) tested and such sample(s) are retained for 90 days only.

除非另有說明，此報告結果僅對測試之樣品負責，同時此樣品僅保留90天。本報告未經本公司書面許可，不可部份複製。

This document is issued by the Company subject to its General Conditions of Service printed overleaf, available on request or accessible at <http://www.sgs.com.tw/Terms-and-Conditions> and for electronic format documents, subject to Terms and Conditions for Electronic Documents at <http://www.sgs.com.tw/Terms-and-Conditions>. Attention is drawn to the limitation of liability, indemnification and jurisdiction issues defined therein. Any holder of this document is advised that information contained hereon reflects the Company's findings at the time of its intervention only and within the limits of Client's instructions, if any. The Company's sole responsibility is to its Client and this document does not exonerate parties to a transaction from exercising all their rights and obligations under the transaction documents. This document cannot be reproduced except in full, without prior written approval of the Company. Any unauthorized alteration, forgery or falsification of the content or appearance of this document is unlawful and offenders may be prosecuted to the fullest extent of the law.

Report Number :ER/2021/A0027
 Operation Mode :LTE B41
 Test Mode :Tx CH High
 EUT Pol :H Plane
 Test Frequency :2680 MHz

Test Site :SAC 1
 Test Date :2021-12-03
 Temp./Humi. :23.0/45
 Antenna Pol. :Vertical
 Engineer :GN Lin

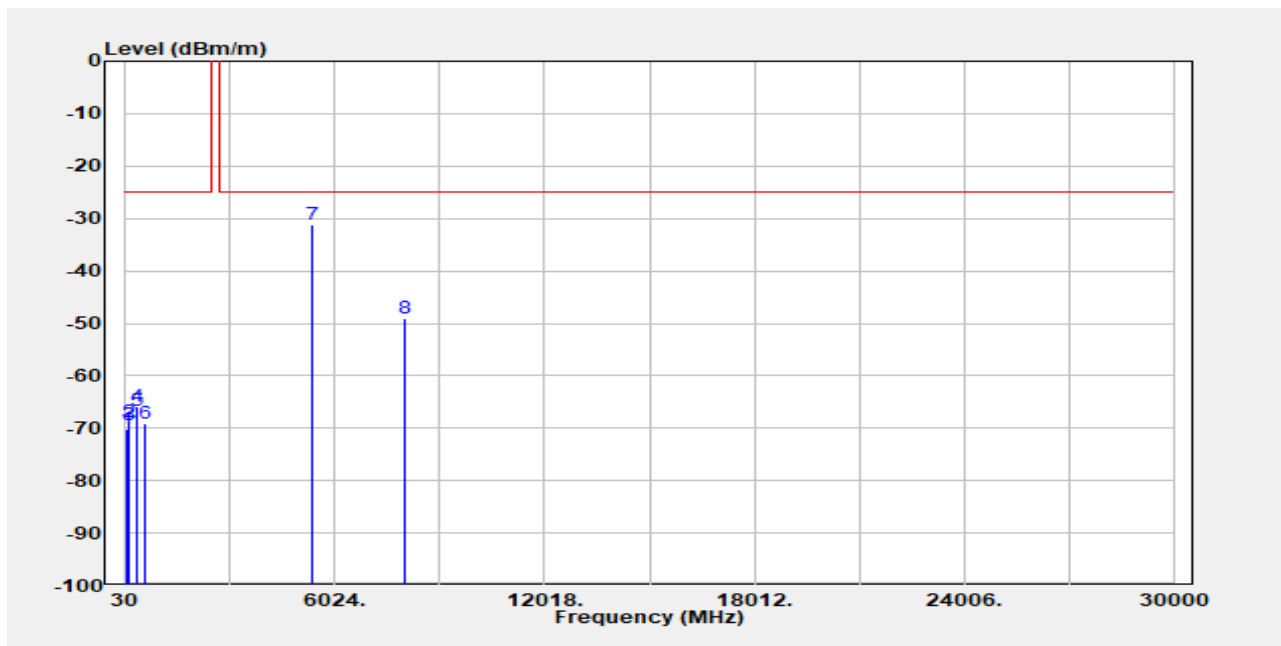

Freq. MHz	EIRP/ERP dBm	SG Output Level dBm	Antenna Gain dBi/dBd	Cable Loss dB	Limit dBm	Margin dB
60.72	-70.19	-60.07	-9.38	-0.74	-25.00	-45.19
107.60	-68.71	-66.25	-1.42	-1.04	-25.00	-43.71
149.63	-69.33	-66.56	-1.62	-1.15	-25.00	-44.33
335.55	-65.87	-68.25	4.28	-1.90	-25.00	-40.87
348.48	-66.68	-69.19	4.52	-2.01	-25.00	-41.68
610.38	-69.17	-70.16	3.48	-2.50	-25.00	-44.17
5360.00	-31.20	-35.32	12.96	-8.84	-25.00	-6.19
8040.00	-49.12	-49.25	11.00	-10.87	-25.00	-24.11

Unless otherwise stated the results shown in this test report refer only to the sample(s) tested and such sample(s) are retained for 90 days only.

除非另有說明，此報告結果僅對測試之樣品負責，同時此樣品僅保留90天。本報告未經本公司書面許可，不可部份複製。

This document is issued by the Company subject to its General Conditions of Service printed overleaf, available on request or accessible at <http://www.sgs.com.tw/Terms-and-Conditions> and for electronic format documents, subject to Terms and Conditions for Electronic Documents at <http://www.sgs.com.tw/Terms-and-Conditions>. Attention is drawn to the limitation of liability, indemnification and jurisdiction issues defined therein. Any holder of this document is advised that information contained hereon reflects the Company's findings at the time of its intervention only and within the limits of Client's instructions, if any. The Company's sole responsibility is to its Client and this document does not exonerate parties to a transaction from exercising all their rights and obligations under the transaction documents. This document cannot be reproduced except in full, without prior written approval of the Company. Any unauthorized alteration, forgery or falsification of the content or appearance of this document is unlawful and offenders may be prosecuted to the fullest extent of the law.

Report Number :ER/2021/A0027
 Operation Mode :LTE B41
 Test Mode :Tx CH High
 EUT Pol :H Plane
 Test Frequency :2680 MHz

Test Site :SAC 1
 Test Date :2021-12-03
 Temp./Humi. :23.0/45
 Antenna Pol. :Horizontal
 Engineer :GN Lin

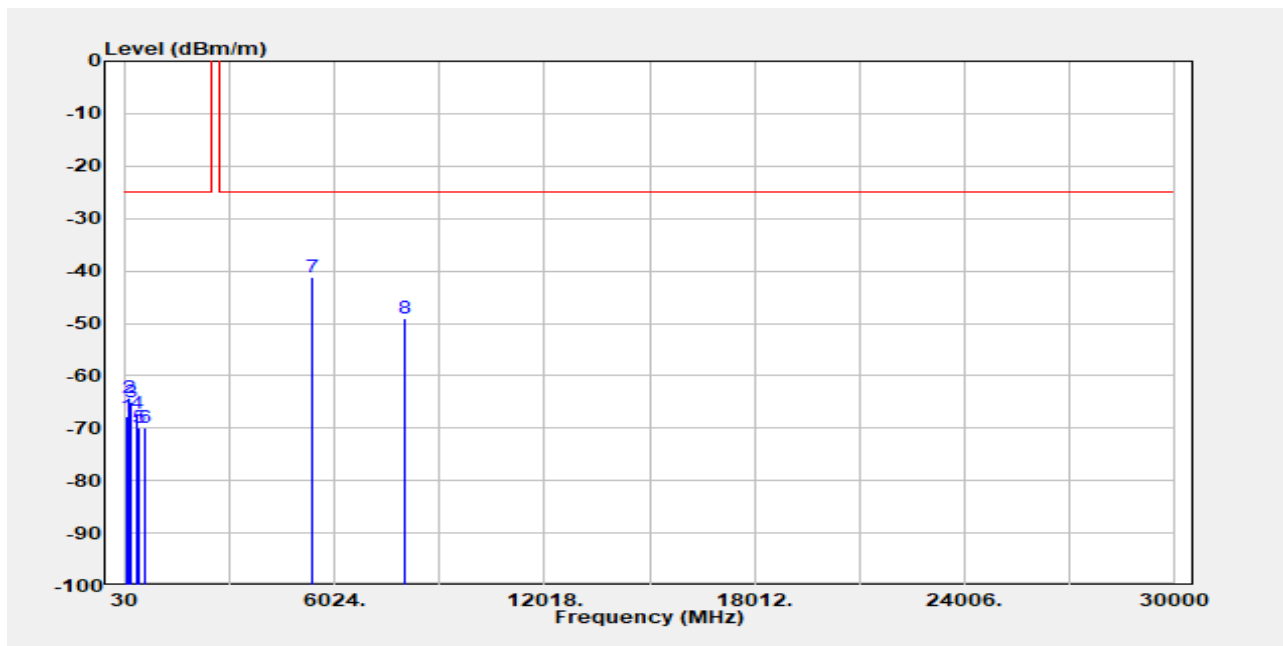

Freq. MHz	EIRP/ERP dBm	SG Output Level dBm	Antenna Gain dBi/dBd	Cable Loss dB	Limit dBm	Margin dB
89.82	-67.75	-66.34	-0.43	-0.98	-25.00	-42.75
149.63	-64.18	-61.41	-1.62	-1.15	-25.00	-39.18
170.65	-64.97	-63.49	-0.21	-1.27	-25.00	-39.97
342.02	-67.08	-69.52	4.36	-1.92	-25.00	-42.08
388.90	-69.91	-72.27	4.40	-2.04	-25.00	-44.91
610.38	-70.04	-71.03	3.48	-2.50	-25.00	-45.04
5360.00	-41.12	-45.24	12.96	-8.84	-25.00	-16.11
8040.00	-48.93	-49.06	11.00	-10.87	-25.00	-23.92

Unless otherwise stated the results shown in this test report refer only to the sample(s) tested and such sample(s) are retained for 90 days only.

除非另有說明，此報告結果僅對測試之樣品負責，同時此樣品僅保留90天。本報告未經本公司書面許可，不可部份複製。

This document is issued by the Company subject to its General Conditions of Service printed overleaf, available on request or accessible at <http://www.sgs.com.tw/Terms-and-Conditions> and for electronic format documents, subject to Terms and Conditions for Electronic Documents at <http://www.sgs.com.tw/Terms-and-Conditions>. Attention is drawn to the limitation of liability, indemnification and jurisdiction issues defined therein. Any holder of this document is advised that information contained hereon reflects the Company's findings at the time of its intervention only and within the limits of Client's instructions, if any. The Company's sole responsibility is to its Client and this document does not exonerate parties to a transaction from exercising all their rights and obligations under the transaction documents. This document cannot be reproduced except in full, without prior written approval of the Company. Any unauthorized alteration, forgery or falsification of the content or appearance of this document is unlawful and offenders may be prosecuted to the fullest extent of the law.

Report Number :ER/2021/A0027
 Operation Mode :LTE B66
 Test Mode :Tx CH Low
 EUT Pol :H Plane
 Test Frequency :1711.5 MHz

Test Site :SAC 1
 Test Date :2021-11-12
 Temp./Humi. :23.8/53
 Antenna Pol. :Vertical
 Engineer :GN Lin

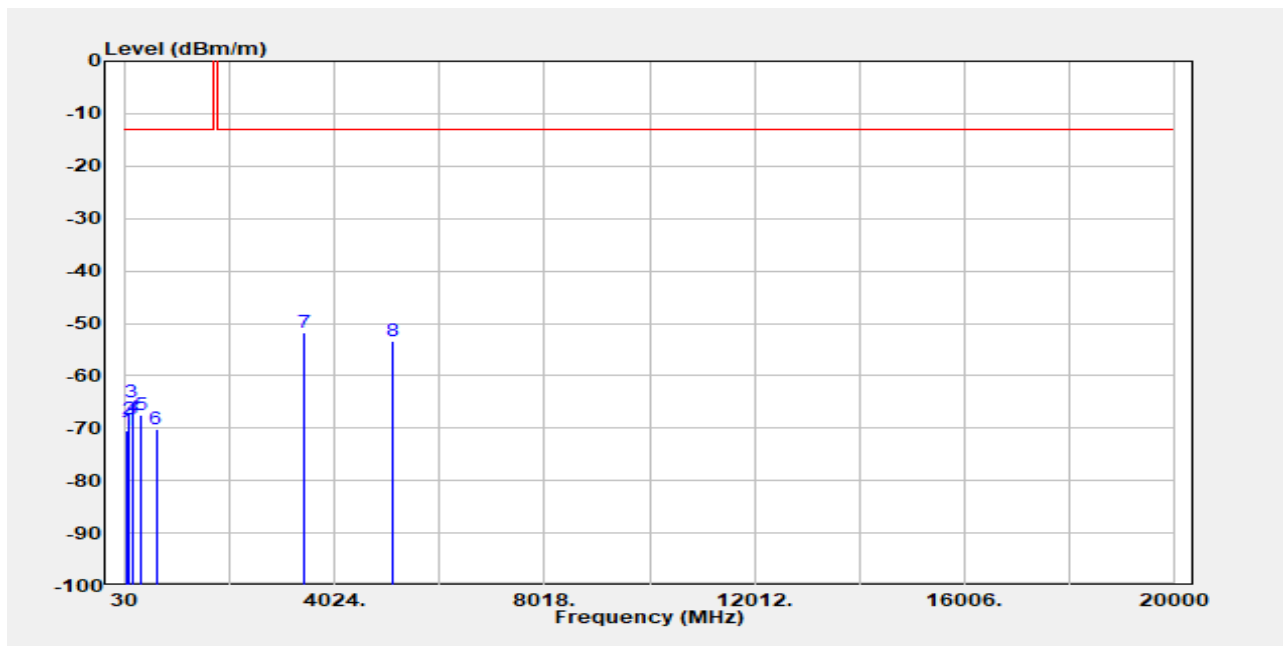

Freq. MHz	EIRP/ERP dBm	SG Output Level dBm	Antenna Gain dBi/dBd	Cable Loss dB	Limit dBm	Margin dB
60.72	-70.50	-60.38	-9.38	-0.74	-13.00	-57.50
107.60	-68.34	-65.87	-1.42	-1.04	-13.00	-55.34
149.63	-64.93	-62.16	-1.62	-1.15	-13.00	-51.93
164.18	-68.08	-65.95	-0.88	-1.26	-13.00	-55.08
335.55	-67.35	-69.73	4.28	-1.90	-13.00	-54.35
610.38	-70.14	-71.13	3.48	-2.50	-13.00	-57.14
3423.00	-51.88	-58.59	12.55	-5.84	-13.00	-38.88
5134.50	-53.42	-57.56	12.10	-7.96	-13.00	-40.42

Unless otherwise stated the results shown in this test report refer only to the sample(s) tested and such sample(s) are retained for 90 days only.

除非另有說明，此報告結果僅對測試之樣品負責，同時此樣品僅保留90天。本報告未經本公司書面許可，不可部份複製。

This document is issued by the Company subject to its General Conditions of Service printed overleaf, available on request or accessible at <http://www.sgs.com.tw/Terms-and-Conditions> and for electronic format documents, subject to Terms and Conditions for Electronic Documents at <http://www.sgs.com.tw/Terms-and-Conditions>. Attention is drawn to the limitation of liability, indemnification and jurisdiction issues defined therein. Any holder of this document is advised that information contained hereon reflects the Company's findings at the time of its intervention only and within the limits of Client's instructions, if any. The Company's sole responsibility is to its Client and this document does not exonerate parties to a transaction from exercising all their rights and obligations under the transaction documents. This document cannot be reproduced except in full, without prior written approval of the Company. Any unauthorized alteration, forgery or falsification of the content or appearance of this document is unlawful and offenders may be prosecuted to the fullest extent of the law.

Report Number :ER/2021/A0027
 Operation Mode :LTE B66
 Test Mode :Tx CH Low
 EUT Pol :H Plane
 Test Frequency :1711.5 MHz

Test Site :SAC 1
 Test Date :2021-11-12
 Temp./Humi. :23.8/53
 Antenna Pol. :Horizontal
 Engineer :GN Lin

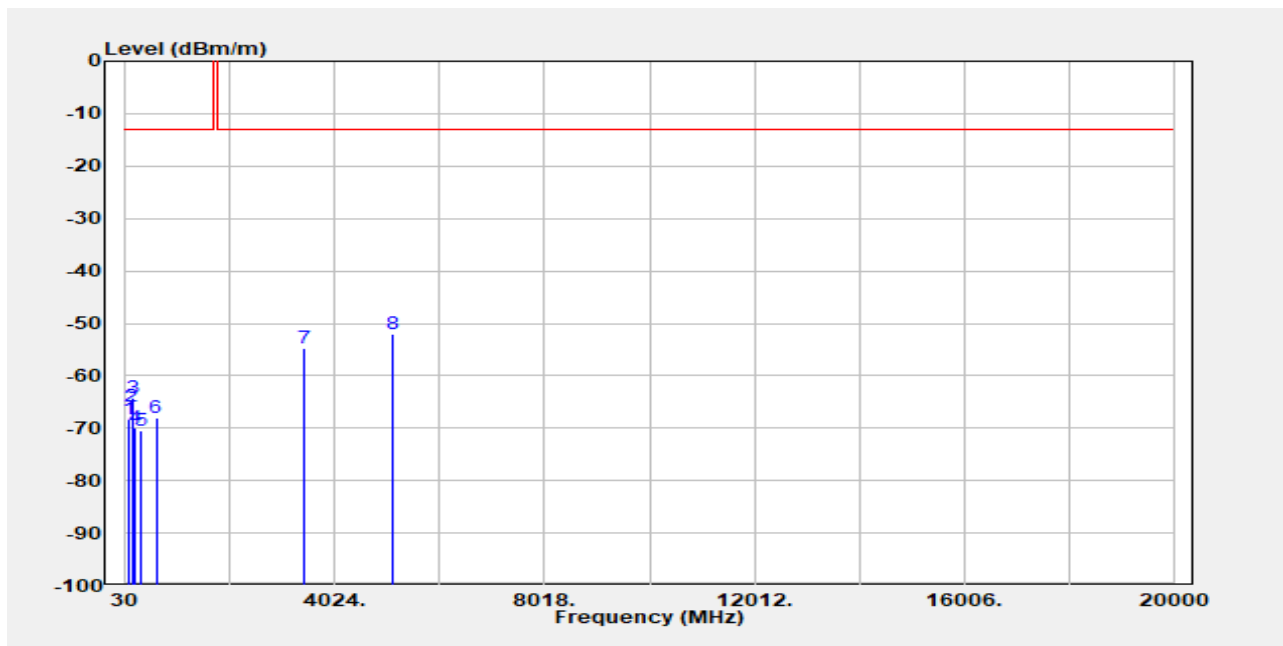

Freq. MHz	EIRP/ERP dBm	SG Output Level dBm	Antenna Gain dBi/dBd	Cable Loss dB	Limit dBm	Margin dB
89.82	-68.35	-66.94	-0.43	-0.98	-13.00	-55.35
149.63	-65.75	-62.98	-1.62	-1.15	-13.00	-52.75
164.18	-64.11	-61.98	-0.88	-1.26	-13.00	-51.11
191.67	-69.88	-71.94	3.50	-1.43	-13.00	-56.88
335.55	-70.50	-72.89	4.28	-1.90	-13.00	-57.50
610.38	-67.94	-68.92	3.48	-2.50	-13.00	-54.94
3423.00	-54.70	-61.41	12.55	-5.84	-13.00	-41.69
5134.50	-52.15	-56.29	12.10	-7.96	-13.00	-39.14

Unless otherwise stated the results shown in this test report refer only to the sample(s) tested and such sample(s) are retained for 90 days only.

除非另有說明，此報告結果僅對測試之樣品負責，同時此樣品僅保留90天。本報告未經本公司書面許可，不可部份複製。

This document is issued by the Company subject to its General Conditions of Service printed overleaf, available on request or accessible at <http://www.sgs.com.tw/Terms-and-Conditions> and for electronic format documents, subject to Terms and Conditions for Electronic Documents at <http://www.sgs.com.tw/Terms-and-Conditions>. Attention is drawn to the limitation of liability, indemnification and jurisdiction issues defined therein. Any holder of this document is advised that information contained hereon reflects the Company's findings at the time of its intervention only and within the limits of Client's instructions, if any. The Company's sole responsibility is to its Client and this document does not exonerate parties to a transaction from exercising all their rights and obligations under the transaction documents. This document cannot be reproduced except in full, without prior written approval of the Company. Any unauthorized alteration, forgery or falsification of the content or appearance of this document is unlawful and offenders may be prosecuted to the fullest extent of the law.

Report Number :ER/2021/A0027
 Operation Mode :LTE B66
 Test Mode :Tx CH Mid
 EUT Pol :H Plane
 Test Frequency :1745 MHz

Test Site :SAC 1
 Test Date :2021-11-12
 Temp./Humi. :23.8/53
 Antenna Pol. :Vertical
 Engineer :GN Lin

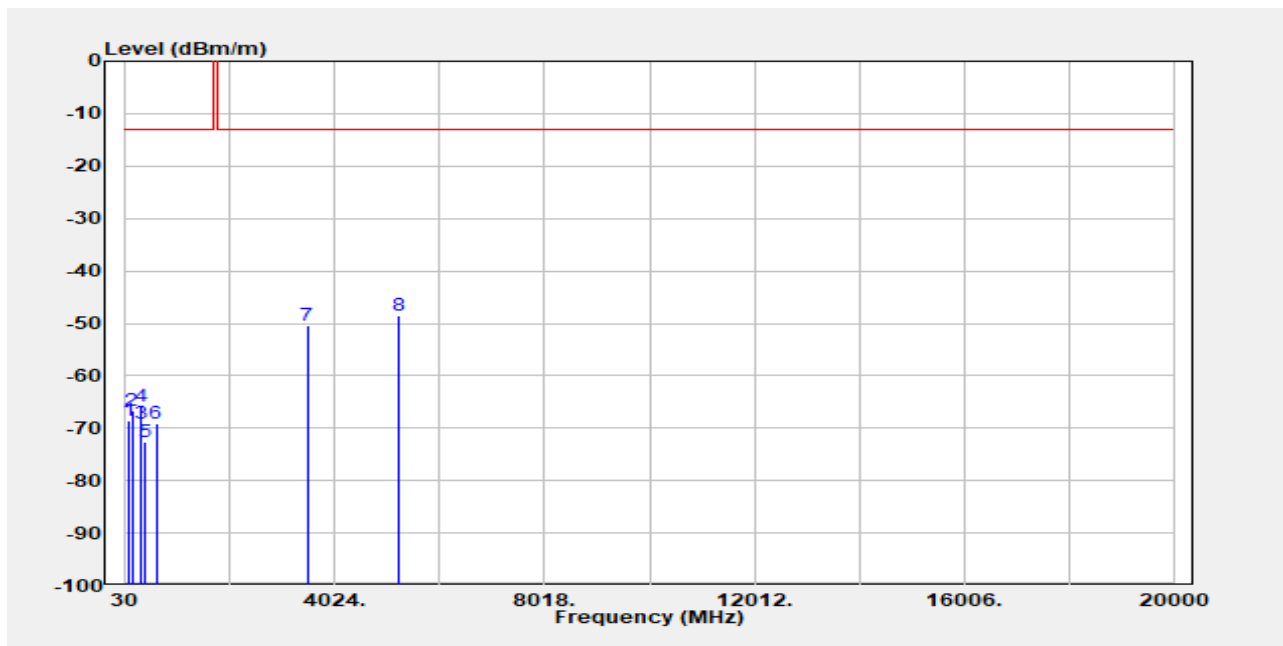

Freq. MHz	EIRP/ERP dBm	SG Output Level dBm	Antenna Gain dBi/dBd	Cable Loss dB	Limit dBm	Margin dB
107.60	-68.67	-66.20	-1.42	-1.04	-13.00	-55.67
149.63	-66.80	-64.03	-1.62	-1.15	-13.00	-53.80
321.00	-69.18	-71.69	4.19	-1.68	-13.00	-56.18
335.55	-65.88	-68.27	4.28	-1.90	-13.00	-52.88
388.90	-72.56	-74.92	4.40	-2.04	-13.00	-59.56
610.38	-69.20	-70.19	3.48	-2.50	-13.00	-56.20
3490.00	-50.47	-56.62	12.42	-6.26	-13.00	-37.46
5235.00	-48.50	-53.19	12.68	-7.99	-13.00	-35.49

Unless otherwise stated the results shown in this test report refer only to the sample(s) tested and such sample(s) are retained for 90 days only.

除非另有說明，此報告結果僅對測試之樣品負責，同時此樣品僅保留90天。本報告未經本公司書面許可，不可部份複製。

This document is issued by the Company subject to its General Conditions of Service printed overleaf, available on request or accessible at <http://www.sgs.com.tw/Terms-and-Conditions> and for electronic format documents, subject to Terms and Conditions for Electronic Documents at <http://www.sgs.com.tw/Terms-and-Conditions>. Attention is drawn to the limitation of liability, indemnification and jurisdiction issues defined therein. Any holder of this document is advised that information contained hereon reflects the Company's findings at the time of its intervention only and within the limits of Client's instructions, if any. The Company's sole responsibility is to its Client and this document does not exonerate parties to a transaction from exercising all their rights and obligations under the transaction documents. This document cannot be reproduced except in full, without prior written approval of the Company. Any unauthorized alteration, forgery or falsification of the content or appearance of this document is unlawful and offenders may be prosecuted to the fullest extent of the law.

Report Number :ER/2021/A0027
 Operation Mode :LTE B66
 Test Mode :Tx CH Mid
 EUT Pol :H Plane
 Test Frequency :1745 MHz

Test Site :SAC 1
 Test Date :2021-11-12
 Temp./Humi. :23.8/53
 Antenna Pol. :Horizontal
 Engineer :GN Lin

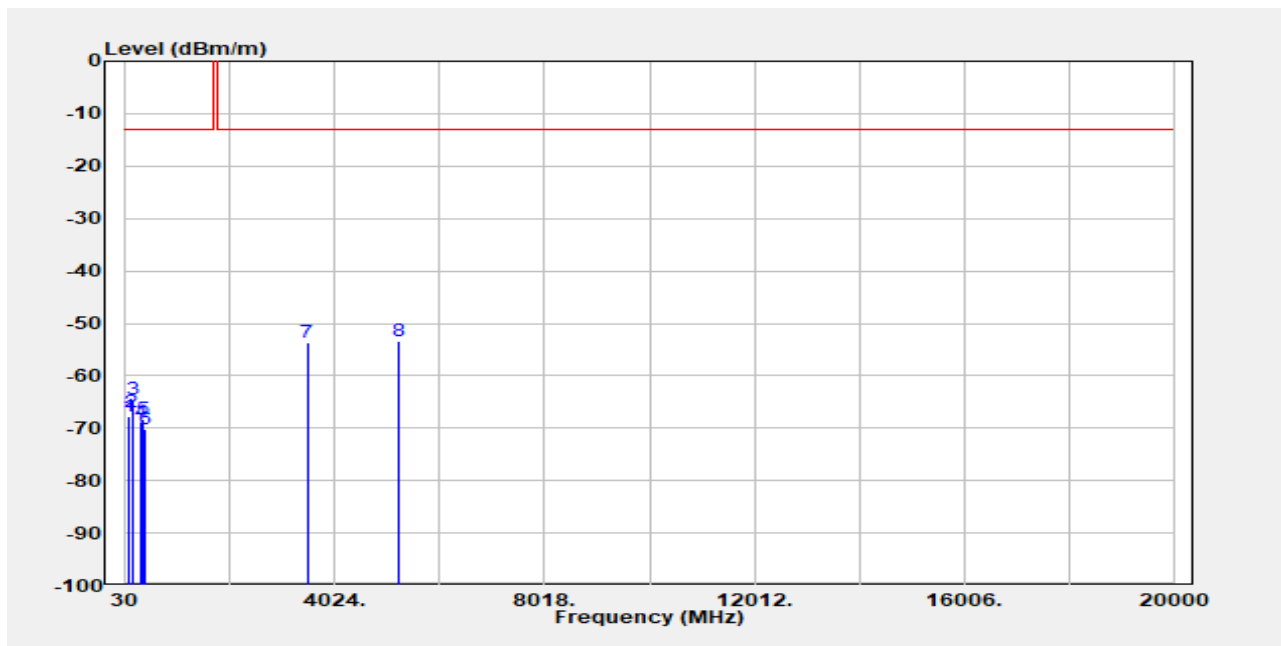

Freq. MHz	EIRP/ERP dBm	SG Output Level dBm	Antenna Gain dBi/dBd	Cable Loss dB	Limit dBm	Margin dB
89.82	-67.68	-66.27	-0.43	-0.98	-13.00	-54.68
149.63	-66.84	-64.07	-1.62	-1.15	-13.00	-53.84
164.18	-64.58	-62.45	-0.88	-1.26	-13.00	-51.58
335.55	-68.76	-71.15	4.28	-1.90	-13.00	-55.76
348.48	-68.25	-70.76	4.52	-2.01	-13.00	-55.25
388.90	-70.15	-72.51	4.40	-2.04	-13.00	-57.15
3490.00	-53.72	-59.88	12.42	-6.26	-13.00	-40.71
5235.00	-53.32	-58.02	12.68	-7.99	-13.00	-40.31

Unless otherwise stated the results shown in this test report refer only to the sample(s) tested and such sample(s) are retained for 90 days only.

除非另有說明，此報告結果僅對測試之樣品負責，同時此樣品僅保留90天。本報告未經本公司書面許可，不可部份複製。

This document is issued by the Company subject to its General Conditions of Service printed overleaf, available on request or accessible at <http://www.sgs.com.tw/Terms-and-Conditions> and for electronic format documents, subject to Terms and Conditions for Electronic Documents at <http://www.sgs.com.tw/Terms-and-Conditions>. Attention is drawn to the limitation of liability, indemnification and jurisdiction issues defined therein. Any holder of this document is advised that information contained hereon reflects the Company's findings at the time of its intervention only and within the limits of Client's instructions, if any. The Company's sole responsibility is to its Client and this document does not exonerate parties to a transaction from exercising all their rights and obligations under the transaction documents. This document cannot be reproduced except in full, without prior written approval of the Company. Any unauthorized alteration, forgery or falsification of the content or appearance of this document is unlawful and offenders may be prosecuted to the fullest extent of the law.

Report Number :ER/2021/A0027
 Operation Mode :LTE B66
 Test Mode :Tx CH High
 EUT Pol :H Plane
 Test Frequency :1778.5 MHz

Test Site :SAC 1
 Test Date :2021-11-12
 Temp./Humi. :23.8/53
 Antenna Pol. :Vertical
 Engineer :GN Lin

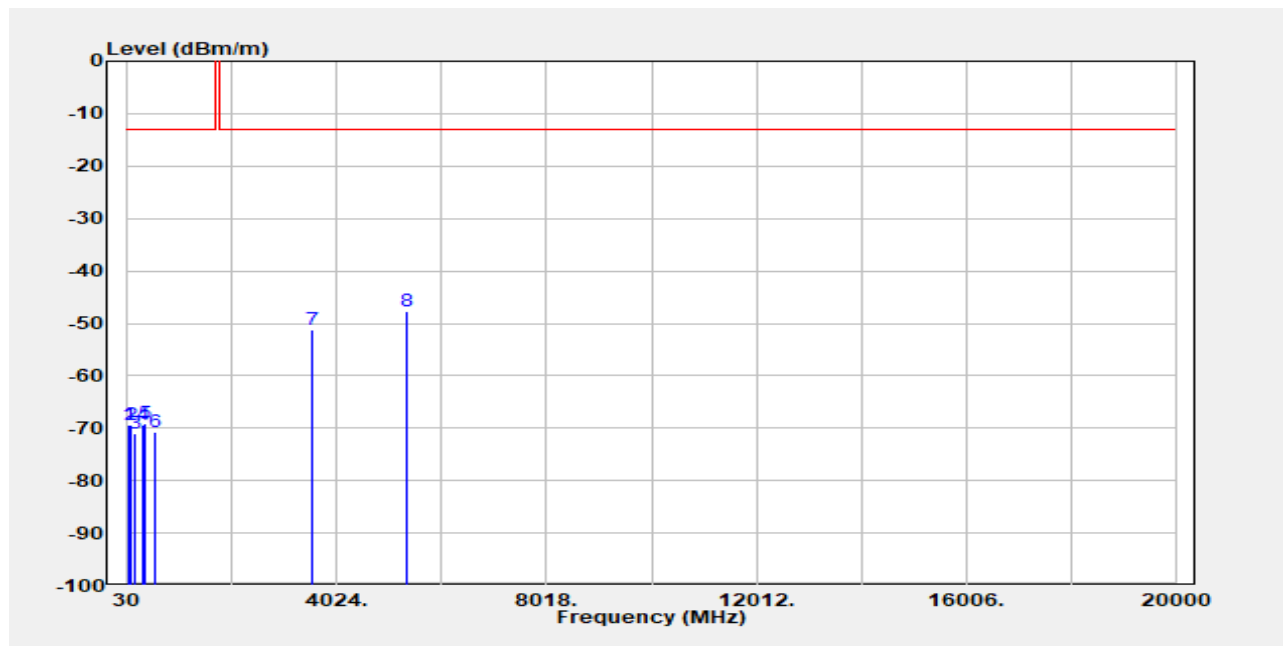

Freq. MHz	EIRP/ERP dBm	SG Output Level dBm	Antenna Gain dBi/dBd	Cable Loss dB	Limit dBm	Margin dB
60.72	-69.36	-59.24	-9.38	-0.74	-13.00	-56.36
101.13	-69.38	-67.49	-0.88	-1.02	-13.00	-56.38
164.18	-71.06	-68.93	-0.88	-1.26	-13.00	-58.06
335.55	-69.30	-71.68	4.28	-1.90	-13.00	-56.30
348.48	-69.14	-71.65	4.52	-2.01	-13.00	-56.14
563.50	-70.77	-72.31	4.16	-2.62	-13.00	-57.77
3557.00	-51.35	-57.18	12.37	-6.54	-13.00	-38.34
5335.50	-47.60	-52.02	13.00	-8.58	-13.00	-34.59

Unless otherwise stated the results shown in this test report refer only to the sample(s) tested and such sample(s) are retained for 90 days only.

除非另有說明，此報告結果僅對測試之樣品負責，同時此樣品僅保留90天。本報告未經本公司書面許可，不可部份複製。

This document is issued by the Company subject to its General Conditions of Service printed overleaf, available on request or accessible at <http://www.sgs.com.tw/Terms-and-Conditions> and for electronic format documents, subject to Terms and Conditions for Electronic Documents at <http://www.sgs.com.tw/Terms-and-Conditions>. Attention is drawn to the limitation of liability, indemnification and jurisdiction issues defined therein. Any holder of this document is advised that information contained hereon reflects the Company's findings at the time of its intervention only and within the limits of Client's instructions, if any. The Company's sole responsibility is to its Client and this document does not exonerate parties to a transaction from exercising all their rights and obligations under the transaction documents. This document cannot be reproduced except in full, without prior written approval of the Company. Any unauthorized alteration, forgery or falsification of the content or appearance of this document is unlawful and offenders may be prosecuted to the fullest extent of the law.

Report Number :ER/2021/A0027
 Operation Mode :LTE B66
 Test Mode :Tx CH High
 EUT Pol :H Plane
 Test Frequency :1778.5 MHz

Test Site :SAC 1
 Test Date :2021-11-12
 Temp./Humi. :23.8/53
 Antenna Pol. :Horizontal
 Engineer :GN Lin

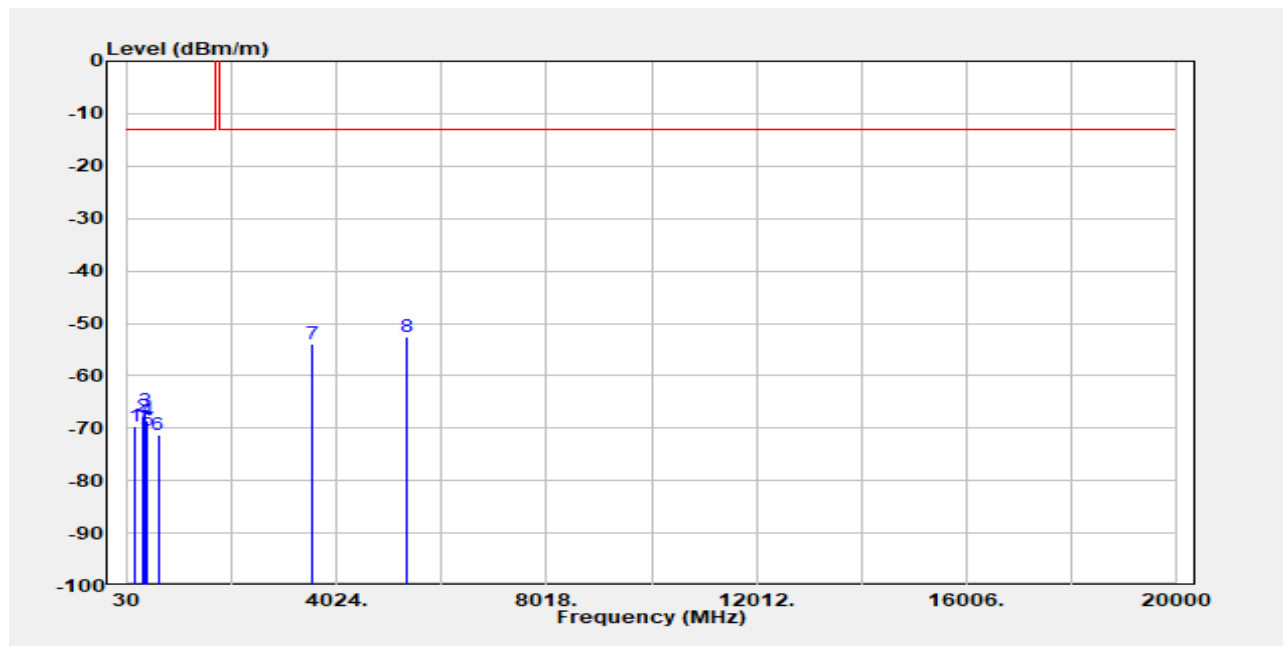

Freq. MHz	EIRP/ERP dBm	SG Output Level dBm	Antenna Gain dBi/dBd	Cable Loss dB	Limit dBm	Margin dB
164.18	-69.75	-67.62	-0.88	-1.26	-13.00	-56.75
335.55	-67.76	-70.15	4.28	-1.90	-13.00	-54.76
348.48	-66.79	-69.30	4.52	-2.01	-13.00	-53.79
388.90	-68.66	-71.02	4.40	-2.04	-13.00	-55.66
401.83	-70.50	-72.74	4.32	-2.08	-13.00	-57.50
610.38	-71.20	-72.19	3.48	-2.50	-13.00	-58.20
3557.00	-53.94	-59.77	12.37	-6.54	-13.00	-40.93
5335.50	-52.60	-57.02	13.00	-8.58	-13.00	-39.59

Unless otherwise stated the results shown in this test report refer only to the sample(s) tested and such sample(s) are retained for 90 days only.

除非另有說明，此報告結果僅對測試之樣品負責，同時此樣品僅保留90天。本報告未經本公司書面許可，不可部份複製。

This document is issued by the Company subject to its General Conditions of Service printed overleaf, available on request or accessible at <http://www.sgs.com.tw/Terms-and-Conditions> and for electronic format documents, subject to Terms and Conditions for Electronic Documents at <http://www.sgs.com.tw/Terms-and-Conditions>. Attention is drawn to the limitation of liability, indemnification and jurisdiction issues defined therein. Any holder of this document is advised that information contained hereon reflects the Company's findings at the time of its intervention only and within the limits of Client's instructions, if any. The Company's sole responsibility is to its Client and this document does not exonerate parties to a transaction from exercising all their rights and obligations under the transaction documents. This document cannot be reproduced except in full, without prior written approval of the Company. Any unauthorized alteration, forgery or falsification of the content or appearance of this document is unlawful and offenders may be prosecuted to the fullest extent of the law.

Report Number :ER/2021/A0027
 Operation Mode :LTE B71
 Test Mode :Tx CH Low
 EUT Pol :H Plane
 Test Frequency :673 MHz

Test Site :SAC 1
 Test Date :2021-11-12
 Temp./Humi. :23.8/53
 Antenna Pol. :Vertical
 Engineer :GN Lin

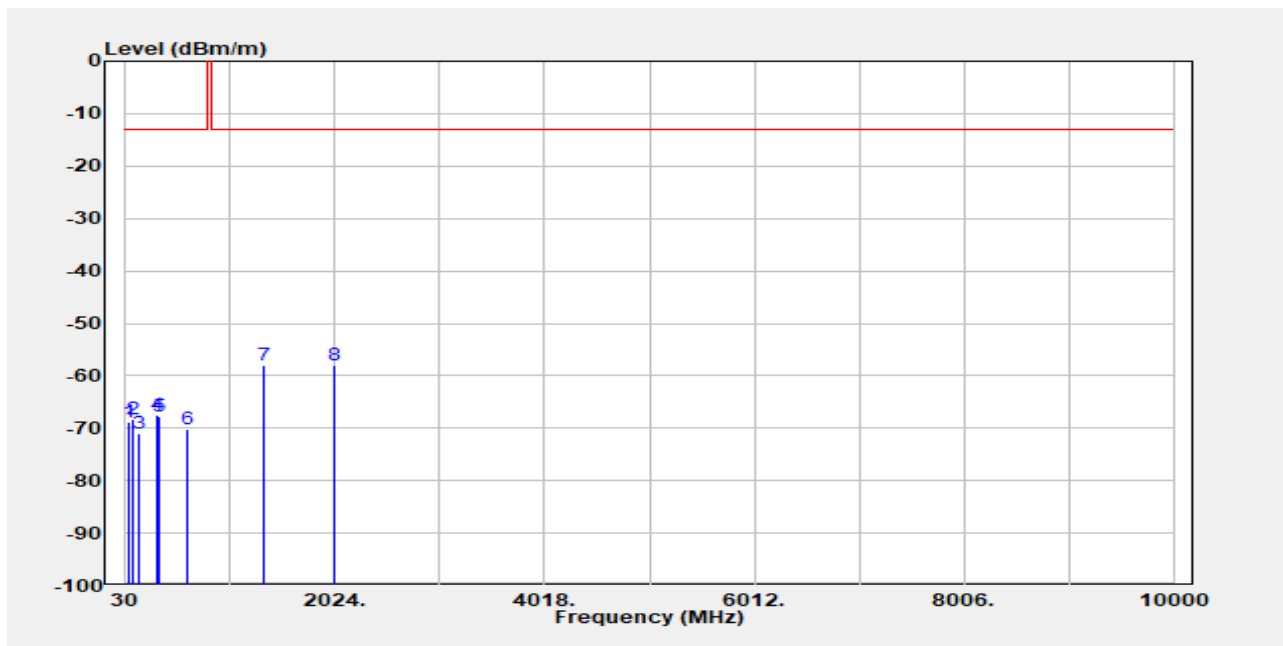

Freq. MHz	EIRP/ERP dBm	SG Output Level dBm	Antenna Gain dBi/dBd	Cable Loss dB	Limit dBm	Margin dB
60.72	-68.86	-58.74	-9.38	-0.74	-13.00	-55.86
101.13	-68.16	-66.26	-0.88	-1.02	-13.00	-55.16
164.18	-70.99	-68.86	-0.88	-1.26	-13.00	-57.99
335.55	-67.58	-69.96	4.28	-1.90	-13.00	-54.58
348.48	-67.80	-70.31	4.52	-2.01	-13.00	-54.80
610.38	-70.31	-71.30	3.48	-2.50	-13.00	-57.31
1346.00	-58.04	-61.37	7.11	-3.78	-13.00	-45.03
2019.00	-58.09	-63.55	10.16	-4.70	-13.00	-45.08

Unless otherwise stated the results shown in this test report refer only to the sample(s) tested and such sample(s) are retained for 90 days only.

除非另有說明，此報告結果僅對測試之樣品負責，同時此樣品僅保留90天。本報告未經本公司書面許可，不可部份複製。

This document is issued by the Company subject to its General Conditions of Service printed overleaf, available on request or accessible at <http://www.sgs.com.tw/Terms-and-Conditions> and for electronic format documents, subject to Terms and Conditions for Electronic Documents at <http://www.sgs.com.tw/Terms-and-Conditions>. Attention is drawn to the limitation of liability, indemnification and jurisdiction issues defined therein. Any holder of this document is advised that information contained hereon reflects the Company's findings at the time of its intervention only and within the limits of Client's instructions, if any. The Company's sole responsibility is to its Client and this document does not exonerate parties to a transaction from exercising all their rights and obligations under the transaction documents. This document cannot be reproduced except in full, without prior written approval of the Company. Any unauthorized alteration, forgery or falsification of the content or appearance of this document is unlawful and offenders may be prosecuted to the fullest extent of the law.

Report Number :ER/2021/A0027
 Operation Mode :LTE B71
 Test Mode :Tx CH Low
 EUT Pol :H Plane
 Test Frequency :673 MHz

Test Site :SAC 1
 Test Date :2021-11-12
 Temp./Humi. :23.8/53
 Antenna Pol. :Horizontal
 Engineer :GN Lin

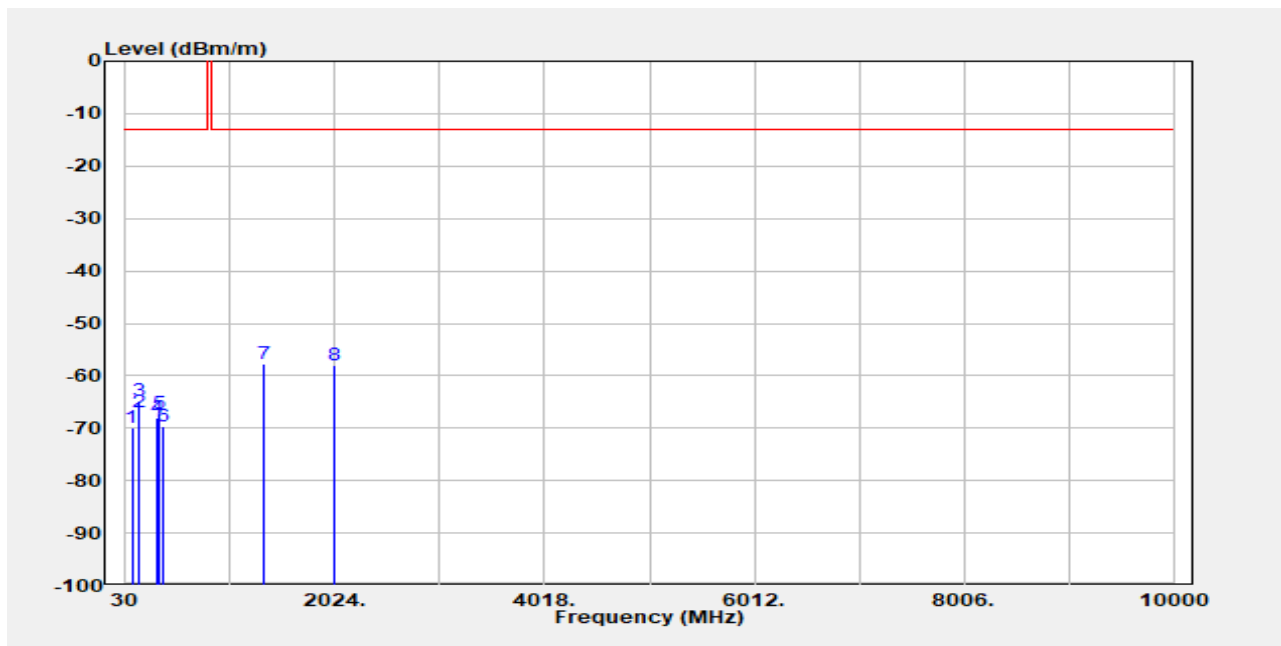

Freq. MHz	EIRP/ERP dBm	SG Output Level dBm	Antenna Gain dBi/dBd	Cable Loss dB	Limit dBm	Margin dB
89.82	-69.85	-68.44	-0.43	-0.98	-13.00	-56.85
149.63	-67.06	-64.29	-1.62	-1.15	-13.00	-54.06
164.18	-64.76	-62.63	-0.88	-1.26	-13.00	-51.76
335.55	-68.11	-70.49	4.28	-1.90	-13.00	-55.11
348.48	-67.15	-69.66	4.52	-2.01	-13.00	-54.15
388.90	-69.60	-71.96	4.40	-2.04	-13.00	-56.60
1346.00	-57.66	-60.99	7.11	-3.78	-13.00	-44.65
2019.00	-57.95	-63.41	10.16	-4.70	-13.00	-44.94

Unless otherwise stated the results shown in this test report refer only to the sample(s) tested and such sample(s) are retained for 90 days only.

除非另有說明，此報告結果僅對測試之樣品負責，同時此樣品僅保留90天。本報告未經本公司書面許可，不可部份複製。

This document is issued by the Company subject to its General Conditions of Service printed overleaf, available on request or accessible at <http://www.sgs.com.tw/Terms-and-Conditions> and for electronic format documents, subject to Terms and Conditions for Electronic Documents at <http://www.sgs.com.tw/Terms-and-Conditions>. Attention is drawn to the limitation of liability, indemnification and jurisdiction issues defined therein. Any holder of this document is advised that information contained hereon reflects the Company's findings at the time of its intervention only and within the limits of Client's instructions, if any. The Company's sole responsibility is to its Client and this document does not exonerate parties to a transaction from exercising all their rights and obligations under the transaction documents. This document cannot be reproduced except in full, without prior written approval of the Company. Any unauthorized alteration, forgery or falsification of the content or appearance of this document is unlawful and offenders may be prosecuted to the fullest extent of the law.

Report Number :ER/2021/A0027
 Operation Mode :LTE B71
 Test Mode :Tx CH Mid
 EUT Pol :H Plane
 Test Frequency :680.5 MHz

Test Site :SAC 1
 Test Date :2021-11-12
 Temp./Humi. :23.8/53
 Antenna Pol. :Vertical
 Engineer :GN Lin

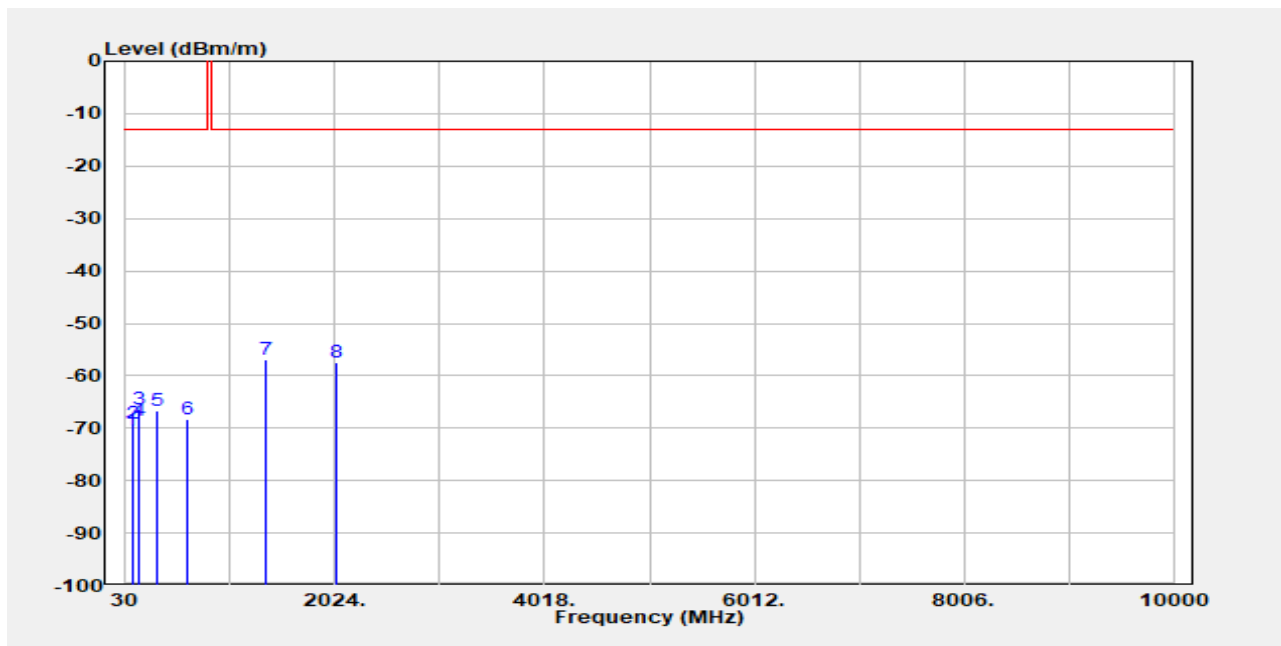

Freq. MHz	EIRP/ERP dBm	SG Output Level dBm	Antenna Gain dBi/dBd	Cable Loss dB	Limit dBm	Margin dB
89.82	-70.39	-68.98	-0.43	-0.98	-13.00	-57.39
107.60	-69.05	-66.58	-1.42	-1.04	-13.00	-56.05
149.63	-66.53	-63.76	-1.62	-1.15	-13.00	-53.53
164.18	-68.53	-66.40	-0.88	-1.26	-13.00	-55.53
335.55	-66.78	-69.16	4.28	-1.90	-13.00	-53.78
610.38	-68.20	-69.19	3.48	-2.50	-13.00	-55.20
1361.00	-56.82	-60.23	7.21	-3.79	-13.00	-43.81
2041.50	-57.45	-62.84	10.12	-4.72	-13.00	-44.44

Unless otherwise stated the results shown in this test report refer only to the sample(s) tested and such sample(s) are retained for 90 days only.

除非另有說明，此報告結果僅對測試之樣品負責，同時此樣品僅保留90天。本報告未經本公司書面許可，不可部份複製。

This document is issued by the Company subject to its General Conditions of Service printed overleaf, available on request or accessible at <http://www.sgs.com.tw/Terms-and-Conditions> and for electronic format documents, subject to Terms and Conditions for Electronic Documents at <http://www.sgs.com.tw/Terms-and-Conditions>. Attention is drawn to the limitation of liability, indemnification and jurisdiction issues defined therein. Any holder of this document is advised that information contained hereon reflects the Company's findings at the time of its intervention only and within the limits of Client's instructions, if any. The Company's sole responsibility is to its Client and this document does not exonerate parties to a transaction from exercising all their rights and obligations under the transaction documents. This document cannot be reproduced except in full, without prior written approval of the Company. Any unauthorized alteration, forgery or falsification of the content or appearance of this document is unlawful and offenders may be prosecuted to the fullest extent of the law.

Report Number :ER/2021/A0027
 Operation Mode :LTE B71
 Test Mode :Tx CH Mid
 EUT Pol :H Plane
 Test Frequency :680.5 MHz

Test Site :SAC 1
 Test Date :2021-11-12
 Temp./Humi. :23.8/53
 Antenna Pol. :Horizontal
 Engineer :GN Lin

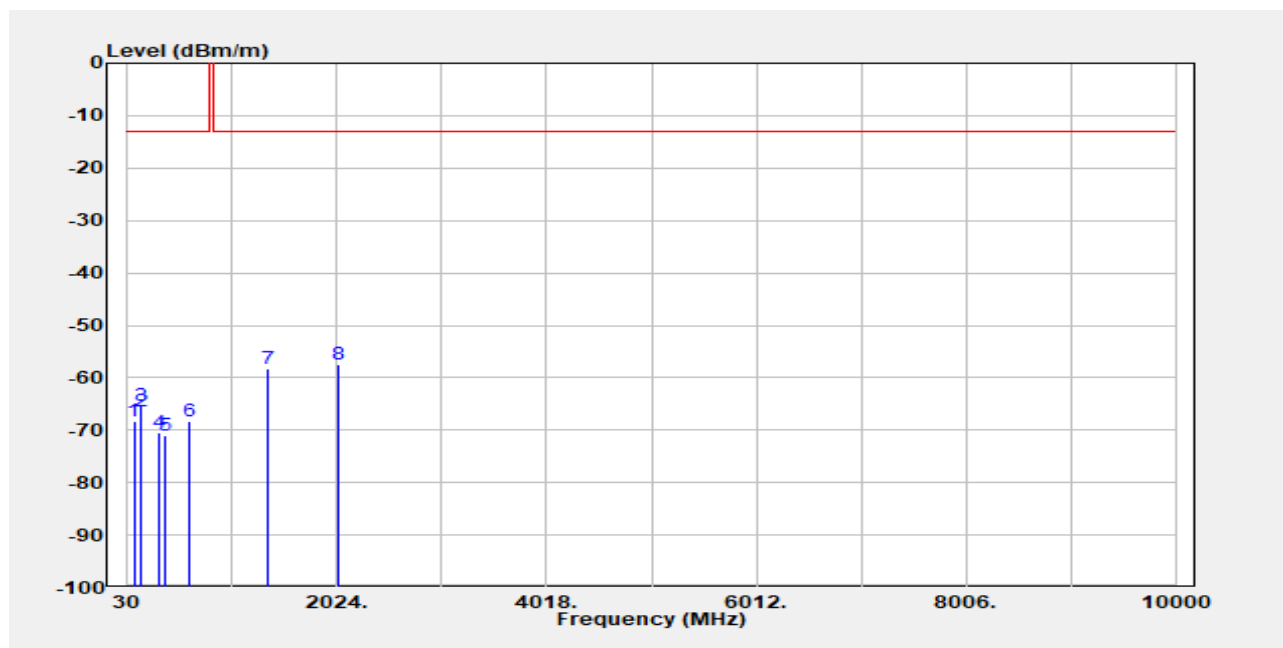

Freq. MHz	EIRP/ERP dBm	SG Output Level dBm	Antenna Gain dBi/dBd	Cable Loss dB	Limit dBm	Margin dB
89.82	-68.33	-66.92	-0.43	-0.98	-13.00	-55.33
149.63	-66.37	-63.60	-1.62	-1.15	-13.00	-53.37
164.18	-65.33	-63.20	-0.88	-1.26	-13.00	-52.33
335.55	-70.42	-72.81	4.28	-1.90	-13.00	-57.42
388.90	-71.08	-73.44	4.40	-2.04	-13.00	-58.08
610.38	-68.35	-69.33	3.48	-2.50	-13.00	-55.35
1361.00	-58.32	-61.74	7.21	-3.79	-13.00	-45.31
2041.50	-57.41	-62.80	10.12	-4.72	-13.00	-44.40

Unless otherwise stated the results shown in this test report refer only to the sample(s) tested and such sample(s) are retained for 90 days only.

除非另有說明，此報告結果僅對測試之樣品負責，同時此樣品僅保留90天。本報告未經本公司書面許可，不可部份複製。

This document is issued by the Company subject to its General Conditions of Service printed overleaf, available on request or accessible at <http://www.sgs.com.tw/Terms-and-Conditions> and for electronic format documents, subject to Terms and Conditions for Electronic Documents at <http://www.sgs.com.tw/Terms-and-Conditions>. Attention is drawn to the limitation of liability, indemnification and jurisdiction issues defined therein. Any holder of this document is advised that information contained hereon reflects the Company's findings at the time of its intervention only and within the limits of Client's instructions, if any. The Company's sole responsibility is to its Client and this document does not exonerate parties to a transaction from exercising all their rights and obligations under the transaction documents. This document cannot be reproduced except in full, without prior written approval of the Company. Any unauthorized alteration, forgery or falsification of the content or appearance of this document is unlawful and offenders may be prosecuted to the fullest extent of the law.

Report Number :ER/2021/A0027
 Operation Mode :LTE B71
 Test Mode :Tx CH High
 EUT Pol :H Plane
 Test Frequency :688 MHz

Test Site :SAC 1
 Test Date :2021-11-12
 Temp./Humi. :23.8/53
 Antenna Pol. :Vertical
 Engineer :GN Lin

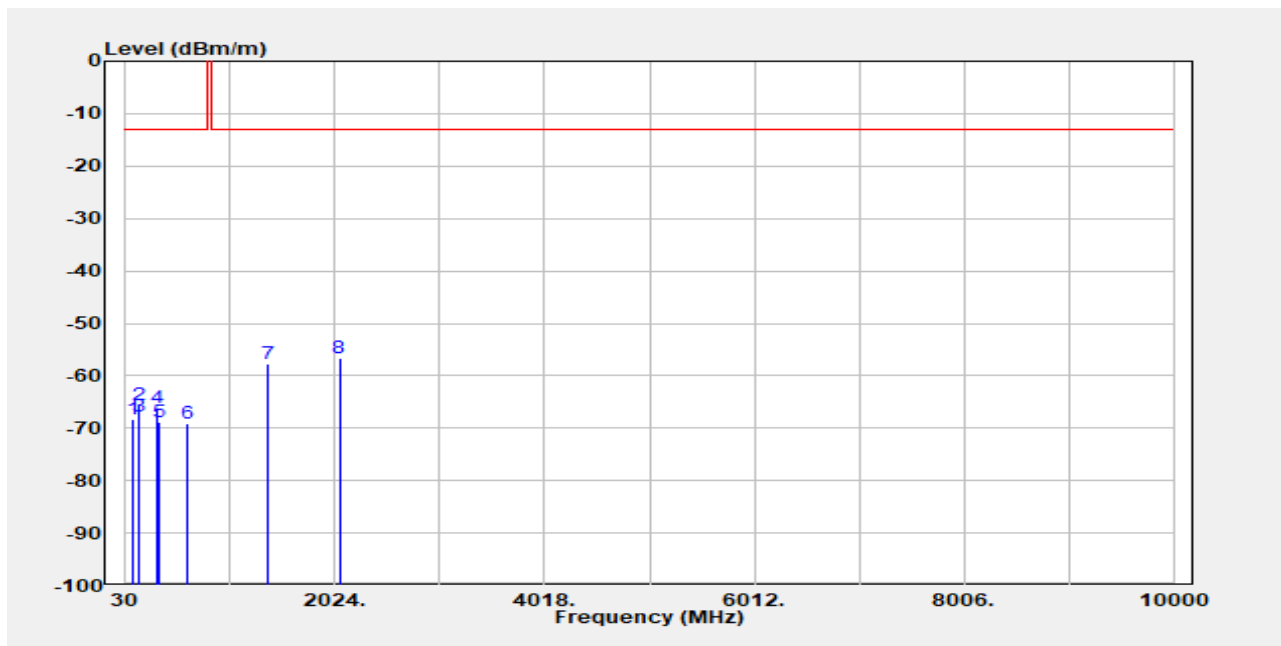

Freq. MHz	EIRP/ERP dBm	SG Output Level dBm	Antenna Gain dBi/dBd	Cable Loss dB	Limit dBm	Margin dB
107.60	-68.42	-65.95	-1.42	-1.04	-13.00	-55.42
149.63	-65.62	-62.85	-1.62	-1.15	-13.00	-52.62
164.18	-67.76	-65.63	-0.88	-1.26	-13.00	-54.76
335.55	-66.01	-68.39	4.28	-1.90	-13.00	-53.01
348.48	-68.77	-71.28	4.52	-2.01	-13.00	-55.77
610.38	-69.15	-70.14	3.48	-2.50	-13.00	-56.15
1376.00	-57.59	3.72	7.36	-3.81	-13.00	-44.59
2064.00	-56.69	3.77	10.04	-4.74	-13.00	-43.69

Unless otherwise stated the results shown in this test report refer only to the sample(s) tested and such sample(s) are retained for 90 days only.

除非另有說明，此報告結果僅對測試之樣品負責，同時此樣品僅保留90天。本報告未經本公司書面許可，不可部份複製。

This document is issued by the Company subject to its General Conditions of Service printed overleaf, available on request or accessible at <http://www.sgs.com.tw/Terms-and-Conditions> and for electronic format documents, subject to Terms and Conditions for Electronic Documents at <http://www.sgs.com.tw/Terms-and-Conditions>. Attention is drawn to the limitation of liability, indemnification and jurisdiction issues defined therein. Any holder of this document is advised that information contained hereon reflects the Company's findings at the time of its intervention only and within the limits of Client's instructions, if any. The Company's sole responsibility is to its Client and this document does not exonerate parties to a transaction from exercising all their rights and obligations under the transaction documents. This document cannot be reproduced except in full, without prior written approval of the Company. Any unauthorized alteration, forgery or falsification of the content or appearance of this document is unlawful and offenders may be prosecuted to the fullest extent of the law.

Report Number :ER/2021/A0027
 Operation Mode :LTE B71
 Test Mode :Tx CH High
 EUT Pol :H Plane
 Test Frequency :688 MHz

Test Site :SAC 1
 Test Date :2021-11-12
 Temp./Humi. :23.8/53
 Antenna Pol. :Horizontal
 Engineer :GN Lin

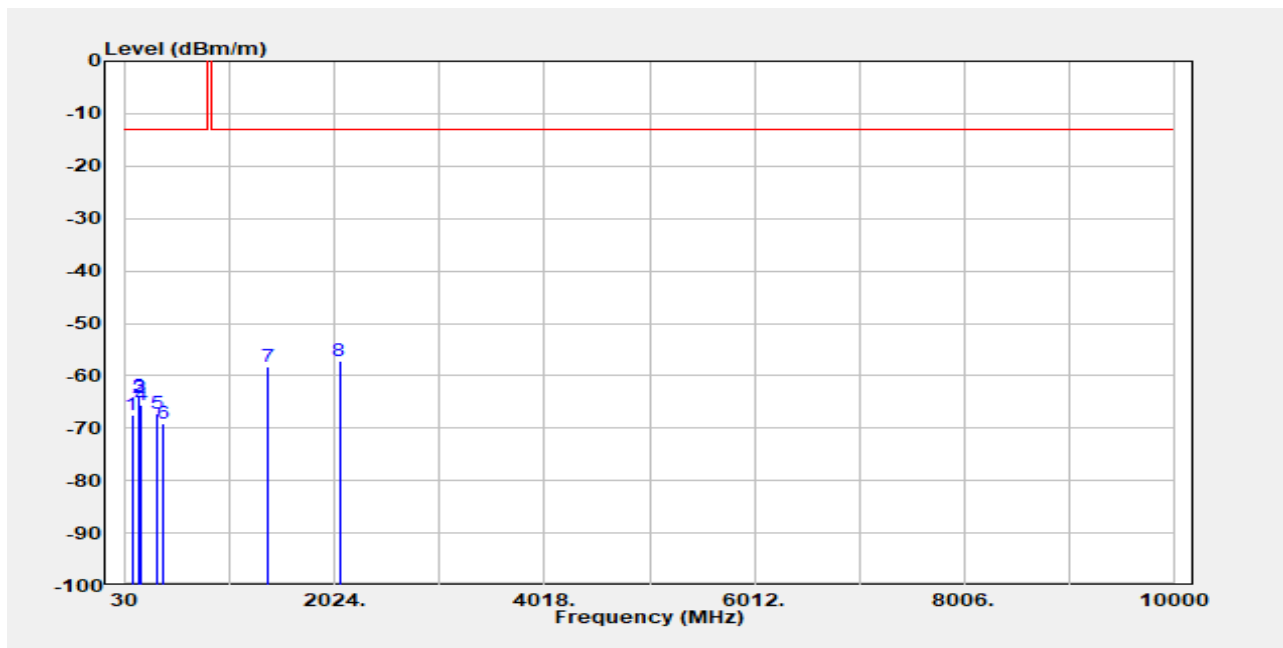

Freq. MHz	EIRP/ERP dBm	SG Output Level dBm	Antenna Gain dBi/dBd	Cable Loss dB	Limit dBm	Margin dB
89.82	-67.45	-66.04	-0.43	-0.98	-13.00	-54.45
149.63	-64.25	-61.48	-1.62	-1.15	-13.00	-51.25
164.18	-64.00	-61.87	-0.88	-1.26	-13.00	-51.00
181.97	-65.70	-66.19	1.87	-1.39	-13.00	-52.70
335.55	-67.17	-69.56	4.28	-1.90	-13.00	-54.17
388.90	-69.09	-71.45	4.40	-2.04	-13.00	-56.09
1376.00	-58.25	3.68	7.36	-3.81	-13.00	-45.25
2064.00	-57.16	3.80	10.04	-4.74	-13.00	-44.16

Unless otherwise stated the results shown in this test report refer only to the sample(s) tested and such sample(s) are retained for 90 days only.

除非另有說明，此報告結果僅對測試之樣品負責，同時此樣品僅保留90天。本報告未經本公司書面許可，不可部份複製。

This document is issued by the Company subject to its General Conditions of Service printed overleaf, available on request or accessible at <http://www.sgs.com.tw/Terms-and-Conditions> and for electronic format documents, subject to Terms and Conditions for Electronic Documents at <http://www.sgs.com.tw/Terms-and-Conditions>. Attention is drawn to the limitation of liability, indemnification and jurisdiction issues defined therein. Any holder of this document is advised that information contained hereon reflects the Company's findings at the time of its intervention only and within the limits of Client's instructions, if any. The Company's sole responsibility is to its Client and this document does not exonerate parties to a transaction from exercising all their rights and obligations under the transaction documents. This document cannot be reproduced except in full, without prior written approval of the Company. Any unauthorized alteration, forgery or falsification of the content or appearance of this document is unlawful and offenders may be prosecuted to the fullest extent of the law.

11 FREQUENCY STABILITY MEASUREMENT

11.1 Standard Applicabl

The frequency stability shall be sufficient to ensure that the fundamental emission stays within the authorized frequency block.

11.2 Test Set-up

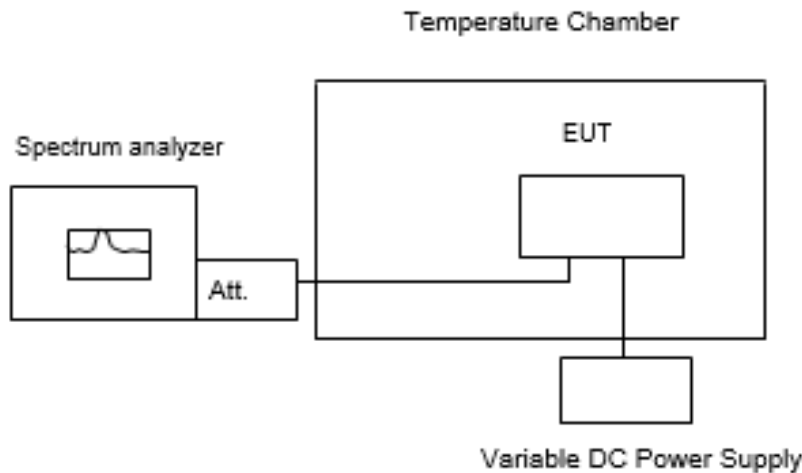

Note: Measurement setup for testing on Antenna connector

11.3 Measurement Procedure

The equipment under test was connected to an external AC or DC power supply and input rated voltage. RF output was connected to a frequency counter or spectrum analyzer via feed through attenuators. The EUT was placed inside the temperature chamber. Set the spectrum analyzer RBW low enough to obtain the desired frequency resolution and measure EUT 25°C operating frequency as reference frequency. Turn EUT off and set the chamber temperature to -30°C. After the temperature stabilized for approximately 30 minutes recorded the frequency. Repeat step measure with 10°C increased per stage until the highest temperature of +50°C reached.

Set chamber temperature to 25°C. Use a variable AC power supply / DC power source to power the EUT and set the voltage to rated voltage. Set the spectrum analyzer RBW low enough to obtain the desired frequency resolution and recorded the frequency.

Reduce the input voltage to specify extreme voltage variation (+/- 15%) and endpoint as declared by the manufacturer, record the maximum frequency change.

11.4 Measurement Result

Unless otherwise stated the results shown in this test report refer only to the sample(s) tested and such sample(s) are retained for 90 days only.

除非另有說明，此報告結果僅對測試之樣品負責，同時此樣品僅保留90天。本報告未經本公司書面許可，不可部份複製。

This document is issued by the Company subject to its General Conditions of Service printed overleaf, available on request or accessible at <http://www.sgs.com.tw/Terms-and-Conditions> and for electronic format documents, subject to Terms and Conditions for Electronic Documents at <http://www.sgs.com.tw/Terms-and-Conditions>. Attention is drawn to the limitation of liability, indemnification and jurisdiction issues defined therein. Any holder of this document is advised that information contained hereon reflects the Company's findings at the time of its intervention only and within the limits of Client's instructions, if any. The Company's sole responsibility is to its Client and this document does not exonerate parties to a transaction from exercising all their rights and obligations under the transaction documents. This document cannot be reproduced except in full, without prior written approval of the Company. Any unauthorized alteration, forgery or falsification of the content or appearance of this document is unlawful and offenders may be prosecuted to the fullest extent of the law.

Reference Freq.:		LTE B2 Mid Channel		1880.0000	MHz 10M QPSK CH 18900
Power Supply Vdc	Temp. (°C)	Freq. (MHz)	(ppm)	Limit	
Freq. ERROR vs. VOLTAGE					
3.795	25	1879.999993	-0.0037	+/- 2.5 ppm	
3.3	25	1880.000006	0.0032		
2.805	25	1880.000011	0.0059		
2.4 (End Point)	25	1879.999995	-0.0027		
Freq. ERROR vs. Temp.					
3.3	-30	1879.999991	-0.0048	+/- 2.5 ppm	
3.3	-20	1880.000001	0.0005		
3.3	-10	1880.000010	0.0053		
3.3	0	1879.999992	-0.0043		
3.3	10	1880.000007	0.0037		
3.3	20	1880.000003	0.0016		
3.3	30	1879.999999	-0.0005		
3.3	40	1879.999991	-0.0048		
3.3	50	1880.000002	0.0011		
Reference Freq.:		LTE B4 Mid Channel		1732.5000	MHz 10M QPSK CH 20175
Power Supply Vdc	Temp. (°C)	Freq. (MHz)	(ppm)	Limit	
Freq. ERROR vs. VOLTAGE					
3.795	25	1732.499999	-0.0006	+/- 2.5 ppm	
3.3	25	1732.500003	0.0017		
2.805	25	1732.499993	-0.0040		
2.4 (End Point)	25	1732.500006	0.0035		
Freq. ERROR vs. Temp.					
3.3	-30	1732.500007	0.0040	+/- 2.5 ppm	
3.3	-20	1732.499990	-0.0058		
3.3	-10	1732.500005	0.0029		
3.3	0	1732.500009	0.0052		
3.3	10	1732.500011	0.0063		
3.3	20	1732.499997	-0.0017		
3.3	30	1732.500005	0.0029		
3.3	40	1732.500001	0.0006		
3.3	50	1732.499994	-0.0035		

Unless otherwise stated the results shown in this test report refer only to the sample(s) tested and such sample(s) are retained for 90 days only.

除非另有說明，此報告結果僅對測試之樣品負責，同時此樣品僅保留90天。本報告未經本公司書面許可，不可部份複製。

This document is issued by the Company subject to its General Conditions of Service printed overleaf, available on request or accessible at <http://www.sgs.com.tw/Terms-and-Conditions> and for electronic format documents, subject to Terms and Conditions for Electronic Documents at <http://www.sgs.com.tw/Terms-and-Conditions>. Attention is drawn to the limitation of liability, indemnification and jurisdiction issues defined therein. Any holder of this document is advised that information contained hereon reflects the Company's findings at the time of its intervention only and within the limits of Client's instructions, if any. The Company's sole responsibility is to its Client and this document does not exonerate parties to a transaction from exercising all their rights and obligations under the transaction documents. This document cannot be reproduced except in full, without prior written approval of the Company. Any unauthorized alteration, forgery or falsification of the content or appearance of this document is unlawful and offenders may be prosecuted to the fullest extent of the law.

Reference Freq.:		LTE B5 Mid Channel		836.5000	MHz 10M QPSK CH 20525
Power Supply Vdc	Temp. (°C)	Freq. (MHz)	(ppm)	Limit	
Freq. ERROR vs. VOLTAGE					
3.795	25	836.500002	0.0024	+/- 2.5 ppm	
3.3	25	836.499997	-0.0036		
2.805	25	836.499989	-0.0132		
2.4 (End Point)	25	836.500006	0.0072		
Freq. ERROR vs. Temp.					
3.3	-30	836.499989	-0.0132	+/- 2.5 ppm	
3.3	-20	836.500004	0.0048		
3.3	-10	836.499993	-0.0084		
3.3	0	836.499990	-0.0120		
3.3	10	836.499992	-0.0096		
3.3	20	836.499996	-0.0048		
3.3	30	836.500006	0.0072		
3.3	40	836.500005	0.0060		
3.3	50	836.500008	0.0096		
Reference Freq.:		LTE B7 Mid Channel		2535.0000	MHz 10M QPSK CH 21100
Power Supply Vdc	Temp. (°C)	Freq. (MHz)	(ppm)	Limit	
Freq. ERROR vs. VOLTAGE					
3.795	25	2535.000004	0.0016	+/- 2.5 ppm	
3.3	25	2534.999998	-0.0008		
2.805	25	2535.000011	0.0043		
2.4 (End Point)	25	2534.999993	-0.0028		
Freq. ERROR vs. Temp.					
3.3	-30	2535.000007	0.0028	+/- 2.5 ppm	
3.3	-20	2534.999994	-0.0024		
3.3	-10	2534.999997	-0.0012		
3.3	0	2534.999989	-0.0043		
3.3	10	2535.000009	0.0036		
3.3	20	2535.000001	0.0004		
3.3	30	2535.000008	0.0032		
3.3	40	2535.000004	0.0016		
3.3	50	2535.000006	0.0024		

Unless otherwise stated the results shown in this test report refer only to the sample(s) tested and such sample(s) are retained for 90 days only.

除非另有說明，此報告結果僅對測試之樣品負責，同時此樣品僅保留90天。本報告未經本公司書面許可，不可部份複製。

This document is issued by the Company subject to its General Conditions of Service printed overleaf, available on request or accessible at <http://www.sgs.com.tw/Terms-and-Conditions> and for electronic format documents, subject to Terms and Conditions for Electronic Documents at <http://www.sgs.com.tw/Terms-and-Conditions>. Attention is drawn to the limitation of liability, indemnification and jurisdiction issues defined therein. Any holder of this document is advised that information contained hereon reflects the Company's findings at the time of its intervention only and within the limits of Client's instructions, if any. The Company's sole responsibility is to its Client and this document does not exonerate parties to a transaction from exercising all their rights and obligations under the transaction documents. This document cannot be reproduced except in full, without prior written approval of the Company. Any unauthorized alteration, forgery or falsification of the content or appearance of this document is unlawful and offenders may be prosecuted to the fullest extent of the law.

Reference Freq.:		LTE B12 Mid Channel		707.5000	MHz 10M QPSK CH 23095
Power Supply Vdc	Temp. (°C)	Freq. (MHz)	(ppm)	Limit	
Freq. ERROR vs. VOLTAGE					
3.795	25	707.499990	-0.0141	+/- 2.5 ppm	
3.3	25	707.499992	-0.0113		
2.805	25	707.500001	0.0014		
2.4 (End Point)	25	707.500009	0.0127		
Freq. ERROR vs. Temp.					
3.3	-30	707.499991	-0.0127	+/- 2.5 ppm	
3.3	-20	707.500008	0.0113		
3.3	-10	707.500011	0.0155		
3.3	0	707.500003	0.0042		
3.3	10	707.500007	0.0099		
3.3	20	707.499994	-0.0085		
3.3	30	707.500001	0.0014		
3.3	40	707.500008	0.0113		
3.3	50	707.499990	-0.0141		
Reference Freq.:		LTE B13 Mid Channel		782.0000	MHz 10M QPSK CH 23230
Power Supply Vdc	Temp. (°C)	Freq. (MHz)	(ppm)	Limit	
Freq. ERROR vs. VOLTAGE					
3.795	25	781.999999	-0.0013	+/- 2.5 ppm	
3.3	25	781.999996	-0.0051		
2.805	25	781.999990	-0.0128		
2.4 (End Point)	25	782.000006	0.0077		
Freq. ERROR vs. Temp.					
3.3	-30	781.999999	-0.0013	+/- 2.5 ppm	
3.3	-20	782.000003	0.0038		
3.3	-10	781.999990	-0.0128		
3.3	0	782.000007	0.0090		
3.3	10	781.999997	-0.0038		
3.3	20	781.999996	-0.0051		
3.3	30	781.999998	-0.0026		
3.3	40	781.999991	-0.0115		
3.3	50	782.000003	0.0038		

Unless otherwise stated the results shown in this test report refer only to the sample(s) tested and such sample(s) are retained for 90 days only.

除非另有說明，此報告結果僅對測試之樣品負責，同時此樣品僅保留90天。本報告未經本公司書面許可，不可部份複製。

This document is issued by the Company subject to its General Conditions of Service printed overleaf, available on request or accessible at <http://www.sgs.com.tw/Terms-and-Conditions> and for electronic format documents, subject to Terms and Conditions for Electronic Documents at <http://www.sgs.com.tw/Terms-and-Conditions>. Attention is drawn to the limitation of liability, indemnification and jurisdiction issues defined therein. Any holder of this document is advised that information contained hereon reflects the Company's findings at the time of its intervention only and within the limits of Client's instructions, if any. The Company's sole responsibility is to its Client and this document does not exonerate parties to a transaction from exercising all their rights and obligations under the transaction documents. This document cannot be reproduced except in full, without prior written approval of the Company. Any unauthorized alteration, forgery or falsification of the content or appearance of this document is unlawful and offenders may be prosecuted to the fullest extent of the law.

Reference Freq.:		LTE B14 Mid Channel		793.0000	MHz 10M QPSK CH 23330
Power Supply Vdc	Temp. (°C)	Freq. (MHz)	(ppm)	Limit = +/- 1.25 ppm (Hz)	
Freq. ERROR vs. VOLTAGE					
3.795	25	792.999999	-0.0013	+/- 2.5 ppm	
3.3	25	793.000010	0.0126		
2.805	25	792.999994	-0.0076		
2.4 (End Point)	25	793.000003	0.0038		
Freq. ERROR vs. Temp.					
3.3	-30	792.999991	-0.0113	+/- 2.5 ppm	
3.3	-20	793.000011	0.0139		
3.3	-10	792.999994	-0.0076		
3.3	0	793.000002	0.0025		
3.3	10	793.000007	0.0088		
3.3	20	793.000010	0.0126		
3.3	30	792.999997	-0.0038		
3.3	40	792.999994	-0.0076		
3.3	50	792.999993	-0.0088		
Reference Freq.:		LTE B17 Mid Channel			
Power Supply Vdc	Temp. (°C)	Freq. (MHz)	(ppm)	Limit	
Freq. ERROR vs. VOLTAGE					
3.795	25	709.999991	-0.0127	+/- 2.5 ppm	
3.3	25	710.000003	0.0042		
2.805	25	709.999992	-0.0113		
2.4 (End Point)	25	709.999993	-0.0099		
Freq. ERROR vs. Temp.					
3.3	-30	709.999997	-0.0042	+/- 2.5 ppm	
3.3	-20	710.000010	0.0141		
3.3	-10	709.999989	-0.0155		
3.3	0	710.000008	0.0113		
3.3	10	709.999994	-0.0085		
3.3	20	710.000002	0.0028		
3.3	30	710.000011	0.0155		
3.3	40	710.000007	0.0099		
3.3	50	710.000003	0.0042		

Unless otherwise stated the results shown in this test report refer only to the sample(s) tested and such sample(s) are retained for 90 days only.

除非另有說明，此報告結果僅對測試之樣品負責，同時此樣品僅保留90天。本報告未經本公司書面許可，不可部份複製。

This document is issued by the Company subject to its General Conditions of Service printed overleaf, available on request or accessible at <http://www.sgs.com.tw/Terms-and-Conditions> and for electronic format documents, subject to Terms and Conditions for Electronic Documents at <http://www.sgs.com.tw/Terms-and-Conditions>. Attention is drawn to the limitation of liability, indemnification and jurisdiction issues defined therein. Any holder of this document is advised that information contained hereon reflects the Company's findings at the time of its intervention only and within the limits of Client's instructions, if any. The Company's sole responsibility is to its Client and this document does not exonerate parties to a transaction from exercising all their rights and obligations under the transaction documents. This document cannot be reproduced except in full, without prior written approval of the Company. Any unauthorized alteration, forgery or falsification of the content or appearance of this document is unlawful and offenders may be prosecuted to the fullest extent of the law.

Reference Freq.:		LTE B25 Mid Channel		1882.5000	MHz 10M QPSK CH 26365
Power Supply Vdc	Temp. (°C)	Freq. (MHz)	Delta (Hz)	Limit = +/- 2.5 ppm (Hz)	
Freq. ERROR vs. VOLTAGE					
3.795	25	1882.499995	-0.0027	+/- 2.5 ppm	
3.3	25	1882.499996	-0.0021		
2.805	25	1882.500009	0.0048		
2.4 (End Point)	25	1882.499990	-0.0053		
Freq. ERROR vs. Temp.					
3.3	-30	1882.499993	-0.0037	+/- 2.5 ppm	
3.3	-20	1882.499995	-0.0027		
3.3	-10	1882.500002	0.0011		
3.3	0	1882.500010	0.0053		
3.3	10	1882.500004	0.0021		
3.3	20	1882.500009	0.0048		
3.3	30	1882.499997	-0.0016		
3.3	40	1882.499992	-0.0042		
3.3	50	1882.500005	0.0027		
Reference Freq.:		Part 90 LTE B26 Mid Channel			
Power Supply Vdc	Temp. (°C)	Freq. (MHz)	(ppm)	Limit	
Freq. ERROR vs. VOLTAGE (LTE B26 for Part 90S)					
3.795	25	818.999995	-0.0061	+/- 2.5 ppm	
3.3	25	818.999993	-0.0085		
2.805	25	818.999989	-0.0134		
2.4 (End Point)	25	819.000009	0.0110		
Freq. ERROR vs. Temp.					
3.3	-30	819.000005	0.0061	+/- 2.5 ppm	
3.3	-20	819.000004	0.0049		
3.3	-10	819.000009	0.0110		
3.3	0	818.999991	-0.0110		
3.3	10	819.000012	0.0147		
3.3	20	819.000007	0.0085		
3.3	30	818.999994	-0.0073		
3.3	40	819.000008	0.0098		
3.3	50	818.999990	-0.0122		

Unless otherwise stated the results shown in this test report refer only to the sample(s) tested and such sample(s) are retained for 90 days only.

除非另有說明，此報告結果僅對測試之樣品負責，同時此樣品僅保留90天。本報告未經本公司書面許可，不可部份複製。

This document is issued by the Company subject to its General Conditions of Service printed overleaf, available on request or accessible at <http://www.sgs.com.tw/Terms-and-Conditions> and for electronic format documents, subject to Terms and Conditions for Electronic Documents at <http://www.sgs.com.tw/Terms-and-Conditions>. Attention is drawn to the limitation of liability, indemnification and jurisdiction issues defined therein. Any holder of this document is advised that information contained hereon reflects the Company's findings at the time of its intervention only and within the limits of Client's instructions, if any. The Company's sole responsibility is to its Client and this document does not exonerate parties to a transaction from exercising all their rights and obligations under the transaction documents. This document cannot be reproduced except in full, without prior written approval of the Company. Any unauthorized alteration, forgery or falsification of the content or appearance of this document is unlawful and offenders may be prosecuted to the fullest extent of the law.

Reference Freq.:		LTE B26 Mid Channel		831.5000	MHz 10M QPSK CH 26865
Power Supply Vdc	Temp. (°C)	Freq. (MHz)	(ppm)	Limit	
Freq. ERROR vs. VOLTAGE					
3.795	25	831.499991	-0.0108	+/- 2.5 ppm	
3.3	25	831.500010	0.0120		
2.805	25	831.499995	-0.0060		
2.4 (End Point)	25	831.500006	0.0072		
Freq. ERROR vs. Temp.					
3.3	-30	831.499991	-0.0108	+/- 2.5 ppm	
3.3	-20	831.500002	0.0024		
3.3	-10	831.499996	-0.0048		
3.3	0	831.499994	-0.0072		
3.3	10	831.500007	0.0084		
3.3	20	831.499989	-0.0132		
3.3	30	831.499992	-0.0096		
3.3	40	831.500006	0.0072		
3.3	50	831.499990	-0.0120		
Reference Freq.:		LTE B30 Mid Channel		2310.0000	MHz 10M QPSK CH 27710
Power Supply Vdc	Temp. (°C)	Freq. (MHz)	(ppm)	Limit	
Freq. ERROR vs. VOLTAGE					
3.795	25	2310.000008	0.0035	+/- 2.5 ppm	
3.3	25	2309.999989	-0.0048		
2.805	25	2309.999994	-0.0026		
2.4 (End Point)	25	2309.999996	-0.0017		
Freq. ERROR vs. Temp.					
3.3	-30	2310.000010	0.0043	+/- 2.5 ppm	
3.3	-20	2309.999999	-0.0004		
3.3	-10	2310.000002	0.0009		
3.3	0	2309.999993	-0.0030		
3.3	10	2310.000006	0.0026		
3.3	20	2310.000011	0.0048		
3.3	30	2309.999990	-0.0043		
3.3	40	2309.999992	-0.0035		
3.3	50	2309.999995	-0.0022		

Unless otherwise stated the results shown in this test report refer only to the sample(s) tested and such sample(s) are retained for 90 days only.

除非另有說明，此報告結果僅對測試之樣品負責，同時此樣品僅保留90天。本報告未經本公司書面許可，不可部份複製。

This document is issued by the Company subject to its General Conditions of Service printed overleaf, available on request or accessible at <http://www.sgs.com.tw/Terms-and-Conditions> and for electronic format documents, subject to Terms and Conditions for Electronic Documents at <http://www.sgs.com.tw/Terms-and-Conditions>. Attention is drawn to the limitation of liability, indemnification and jurisdiction issues defined therein. Any holder of this document is advised that information contained hereon reflects the Company's findings at the time of its intervention only and within the limits of Client's instructions, if any. The Company's sole responsibility is to its Client and this document does not exonerate parties to a transaction from exercising all their rights and obligations under the transaction documents. This document cannot be reproduced except in full, without prior written approval of the Company. Any unauthorized alteration, forgery or falsification of the content or appearance of this document is unlawful and offenders may be prosecuted to the fullest extent of the law.

Reference Freq.:		LTE B38 Mid Channel		2595.0000	MHz 10M QPSK CH 38000
Power Supply Vdc	Temp. (°C)	Freq. (MHz)	(ppm)	Limit	
Freq. ERROR vs. VOLTAGE					
3.795	25	2594.999991	-0.0035	+/- 2.5 ppm	
3.3	25	2594.999996	-0.0015		
2.805	25	2595.000011	0.0042		
2.4 (End Point)	25	2595.000006	0.0023		
Freq. ERROR vs. Temp.					
3.3	-30	2595.000006	0.0023	+/- 2.5 ppm	
3.3	-20	2594.999993	-0.0027		
3.3	-10	2595.000009	0.0035		
3.3	0	2594.999990	-0.0039		
3.3	10	2595.000003	0.0012		
3.3	20	2595.000005	0.0019		
3.3	30	2594.999989	-0.0042		
3.3	40	2594.999998	-0.0008		
3.3	50	2594.999992	-0.0031		
Reference Freq.:		LTE B41 Mid Channel		2593.0000	MHz 10M QPSK CH 40620
Power Supply Vdc	Temp. (°C)	Freq. (MHz)	(ppm)	Limit	
Freq. ERROR vs. VOLTAGE					
3.795	25	2592.999997	-0.0012	+/- 2.5 ppm	
3.3	25	2592.999992	-0.0031		
2.805	25	2593.000004	0.0015		
2.4 (End Point)	25	2593.000011	0.0042		
Freq. ERROR vs. Temp.					
3.3	-30	2593.000002	0.0008	+/- 2.5 ppm	
3.3	-20	2592.999994	-0.0023		
3.3	-10	2593.000007	0.0027		
3.3	0	2593.000003	0.0012		
3.3	10	2592.999990	-0.0039		
3.3	20	2592.999993	-0.0027		
3.3	30	2593.000007	0.0027		
3.3	40	2592.999997	-0.0012		
3.3	50	2593.000001	0.0004		

Unless otherwise stated the results shown in this test report refer only to the sample(s) tested and such sample(s) are retained for 90 days only.

除非另有說明，此報告結果僅對測試之樣品負責，同時此樣品僅保留90天。本報告未經本公司書面許可，不可部份複製。

This document is issued by the Company subject to its General Conditions of Service printed overleaf, available on request or accessible at <http://www.sgs.com.tw/Terms-and-Conditions> and for electronic format documents, subject to Terms and Conditions for Electronic Documents at <http://www.sgs.com.tw/Terms-and-Conditions>. Attention is drawn to the limitation of liability, indemnification and jurisdiction issues defined therein. Any holder of this document is advised that information contained hereon reflects the Company's findings at the time of its intervention only and within the limits of Client's instructions, if any. The Company's sole responsibility is to its Client and this document does not exonerate parties to a transaction from exercising all their rights and obligations under the transaction documents. This document cannot be reproduced except in full, without prior written approval of the Company. Any unauthorized alteration, forgery or falsification of the content or appearance of this document is unlawful and offenders may be prosecuted to the fullest extent of the law.

Reference Freq.:		LTE B66 Mid Channel		1745.0000	MHz 10M QPSK CH 132322
Power Supply Vdc	Temp. (°C)	Freq. (MHz)	(ppm)	Limit	
Freq. ERROR vs. VOLTAGE					
3.795	25	1744.999994	-0.0034	+/- 2.5 ppm	
3.3	25	1745.000008	0.0046		
2.805	25	1745.000010	0.0057		
2.4 (End Point)	25	1744.999991	-0.0052		
Freq. ERROR vs. Temp.					
3.3	-30	1744.999992	-0.0046	+/- 2.5 ppm	
3.3	-20	1745.000005	0.0029		
3.3	-10	1744.999993	-0.0040		
3.3	0	1744.999990	-0.0057		
3.3	10	1745.000002	0.0011		
3.3	20	1744.999997	-0.0017		
3.3	30	1745.000011	0.0063		
3.3	40	1745.000007	0.0040		
3.3	50	1745.000009	0.0052		
Reference Freq.:		LTE B71 Mid Channel		680.5000	MHz 10M QPSK CH 133297
Power Supply Vdc	Temp. (°C)	Freq. (MHz)	(ppm)	Limit	
Freq. ERROR vs. VOLTAGE					
3.795	25	680.499997	-0.0044	+/- 2.5 ppm	
3.3	25	680.500011	0.0162		
2.805	25	680.499995	-0.0073		
2.4 (End Point)	25	680.500008	0.0118		
Freq. ERROR vs. Temp.					
3.3	-30	680.499998	-0.0029	+/- 2.5 ppm	
3.3	-20	680.500011	0.0162		
3.3	-10	680.500006	0.0088		
3.3	0	680.499996	-0.0059		
3.3	10	680.500008	0.0118		
3.3	20	680.500005	0.0073		
3.3	30	680.500009	0.0132		
3.3	40	680.499996	-0.0059		
3.3	50	680.499993	-0.0103		

Unless otherwise stated the results shown in this test report refer only to the sample(s) tested and such sample(s) are retained for 90 days only.

除非另有說明，此報告結果僅對測試之樣品負責，同時此樣品僅保留90天。本報告未經本公司書面許可，不可部份複製。

This document is issued by the Company subject to its General Conditions of Service printed overleaf, available on request or accessible at <http://www.sgs.com.tw/Terms-and-Conditions> and for electronic format documents, subject to Terms and Conditions for Electronic Documents at <http://www.sgs.com.tw/Terms-and-Conditions>. Attention is drawn to the limitation of liability, indemnification and jurisdiction issues defined therein. Any holder of this document is advised that information contained hereon reflects the Company's findings at the time of its intervention only and within the limits of Client's instructions, if any. The Company's sole responsibility is to its Client and this document does not exonerate parties to a transaction from exercising all their rights and obligations under the transaction documents. This document cannot be reproduced except in full, without prior written approval of the Company. Any unauthorized alteration, forgery or falsification of the content or appearance of this document is unlawful and offenders may be prosecuted to the fullest extent of the law.

12 PEAK TO AVERAGE RATIO

12.1 Standard Applicable

The peak-to-average ratio (PAR) of the transmission may not exceed 13dB.

12.2 Test SET-UP

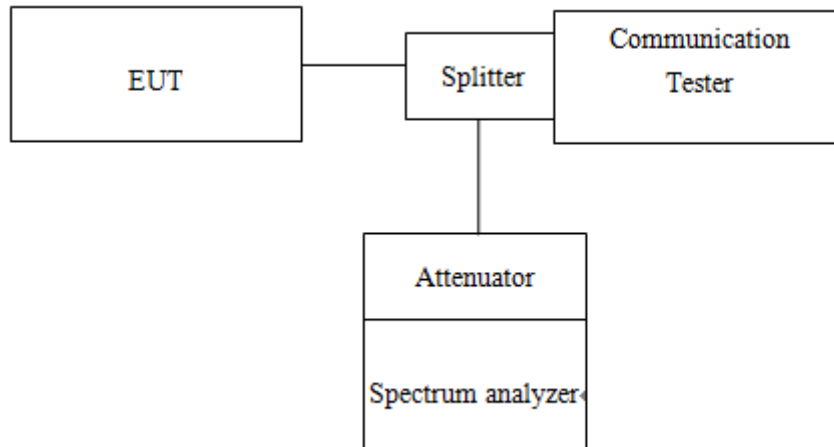

12.3 Measurement Procedure

1. KDB 971168 D01 is employed as the following procedure is proper adjusted accordingly:
2. Set resolution/measurement bandwidth \geq signal's occupied bandwidth; & internal =1ms
3. Set the number of counts to a value that stabilizes the measured CCDF curve.

Unless otherwise stated the results shown in this test report refer only to the sample(s) tested and such sample(s) are retained for 90 days only.

除非另有說明，此報告結果僅對測試之樣品負責，同時此樣品僅保留90天。本報告未經本公司書面許可，不可部份複製。

This document is issued by the Company subject to its General Conditions of Service printed overleaf, available on request or accessible at <http://www.sgs.com.tw/Terms-and-Conditions> and for electronic format documents, subject to Terms and Conditions for Electronic Documents at <http://www.sgs.com.tw/Terms-and-Conditions>. Attention is drawn to the limitation of liability, indemnification and jurisdiction issues defined therein. Any holder of this document is advised that information contained hereon reflects the Company's findings at the time of its intervention only and within the limits of Client's instructions, if any. The Company's sole responsibility is to its Client and this document does not exonerate parties to a transaction from exercising all their rights and obligations under the transaction documents. This document cannot be reproduced except in full, without prior written approval of the Company. Any unauthorized alteration, forgery or falsification of the content or appearance of this document is unlawful and offenders may be prosecuted to the fullest extent of the law.

12.4 Measurement Result

LTE BAND 2							
Channel bandwidth: 1.4MHz				Channel bandwidth: 3MHz			
Freq. (MHz)	CH	PAPR (dB)		Freq. (MHz)	CH	PAPR (dB)	
		64QAM	Limit			64QAM	Limit
1850.7	18607	6.76	13	1851.5	18615	6.69	13
1880.0	18900	6.83	13	1880.0	18900	6.77	13
1909.3	19193	6.79	13	1908.5	19185	6.41	13

LTE BAND 2							
Channel bandwidth: 5MHz				Channel bandwidth: 10MHz			
Freq. (MHz)	CH	PAPR (dB)		Freq. (MHz)	CH	PAPR (dB)	
		64QAM	Limit			64QAM	Limit
1852.5	18625	6.55	13	1855.0	18650	6.25	13
1880.0	18900	6.72	13	1880.0	18900	6.61	13
1907.5	19175	6.47	13	1905.0	19150	6.74	13

LTE BAND 2							
Channel bandwidth: 15MHz				Channel bandwidth: 20MHz			
Freq. (MHz)	CH	PAPR (dB)		Freq. (MHz)	CH	PAPR (dB)	
		64QAM	Limit			64QAM	Limit
1857.5	18675	6.98	13	1860.0	18700	6.88	13
1880.0	18900	7.08	13	1880.0	18900	7.20	13
1902.5	19125	6.91	13	1900.0	19100	7.08	13

Unless otherwise stated the results shown in this test report refer only to the sample(s) tested and such sample(s) are retained for 90 days only.

除非另有說明，此報告結果僅對測試之樣品負責，同時此樣品僅保留90天。本報告未經本公司書面許可，不可部份複製。

This document is issued by the Company subject to its General Conditions of Service printed overleaf, available on request or accessible at <http://www.sgs.com.tw/Terms-and-Conditions> and for electronic format documents, subject to Terms and Conditions for Electronic Documents at <http://www.sgs.com.tw/Terms-and-Conditions>. Attention is drawn to the limitation of liability, indemnification and jurisdiction issues defined therein. Any holder of this document is advised that information contained hereon reflects the Company's findings at the time of its intervention only and within the limits of Client's instructions, if any. The Company's sole responsibility is to its Client and this document does not exonerate parties to a transaction from exercising all their rights and obligations under the transaction documents. This document cannot be reproduced except in full, without prior written approval of the Company. Any unauthorized alteration, forgery or falsification of the content or appearance of this document is unlawful and offenders may be prosecuted to the fullest extent of the law.

LTE BAND 4							
Channel bandwidth: 1.4MHz				Channel bandwidth: 3MHz			
Freq. (MHz)	CH	PAPR (dB)		Freq. (MHz)	CH	PAPR (dB)	
		64QAM	Limit			64QAM	Limit
1710.7	19957	6.73	13	1711.5	19965	6.34	13
1732.5	20175	6.90	13	1732.5	20175	6.97	13
1754.3	20393	6.00	13	1753.5	20385	6.15	13

LTE BAND 4							
Channel bandwidth: 5MHz				Channel bandwidth: 10MHz			
Freq. (MHz)	CH	PAPR (dB)		Freq. (MHz)	CH	PAPR (dB)	
		64QAM	Limit			64QAM	Limit
1712.5	19975	6.41	13	1715.0	20000	6.34	13
1732.5	20175	6.96	13	1732.5	20175	6.54	13
1752.5	20375	6.15	13	1750.0	20350	6.58	13

LTE BAND 4							
Channel bandwidth: 15MHz				Channel bandwidth: 20MHz			
Freq. (MHz)	CH	PAPR (dB)		Freq. (MHz)	CH	PAPR (dB)	
		64QAM	Limit			64QAM	Limit
1717.5	20025	6.29	13	1720.0	20050	6.39	13
1732.5	20175	6.81	13	1732.5	20175	6.88	13
1747.5	20325	7.14	13	1745.0	20300	6.99	13

LTE BAND 5							
Channel bandwidth: 1.4MHz				Channel bandwidth: 3MHz			
Freq. (MHz)	CH	PAPR (dB)		Freq. (MHz)	CH	PAPR (dB)	
		64QAM	Limit			64QAM	Limit
824.7	20407	6.15	13	825.5	20415	6.34	13
836.5	20525	6.77	13	836.5	20525	6.55	13
848.3	20643	6.75	13	847.5	20635	6.48	13

LTE BAND 5							
Channel bandwidth: 5MHz				Channel bandwidth: 10MHz			
Freq. (MHz)	CH	PAPR (dB)		Freq. (MHz)	CH	PAPR (dB)	
		64QAM	Limit			64QAM	Limit
826.5	20425	6.54	13	829.0	20450	6.56	13
836.5	20525	6.68	13	836.5	20525	6.69	13
846.5	20625	6.44	13	844.0	20600	6.55	13

Unless otherwise stated the results shown in this test report refer only to the sample(s) tested and such sample(s) are retained for 90 days only.

除非另有說明，此報告結果僅對測試之樣品負責，同時此樣品僅保留90天。本報告未經本公司書面許可，不可部份複製。

This document is issued by the Company subject to its General Conditions of Service printed overleaf, available on request or accessible at <http://www.sgs.com.tw/Terms-and-Conditions> and for electronic format documents, subject to Terms and Conditions for Electronic Documents at <http://www.sgs.com.tw/Terms-and-Conditions>. Attention is drawn to the limitation of liability, indemnification and jurisdiction issues defined therein. Any holder of this document is advised that information contained hereon reflects the Company's findings at the time of its intervention only and within the limits of Client's instructions, if any. The Company's sole responsibility is to its Client and this document does not exonerate parties to a transaction from exercising all their rights and obligations under the transaction documents. This document cannot be reproduced except in full, without prior written approval of the Company. Any unauthorized alteration, forgery or falsification of the content or appearance of this document is unlawful and offenders may be prosecuted to the fullest extent of the law.

LTE BAND 7							
Channel bandwidth: 5MHz				Channel bandwidth: 10MHz			
Freq. (MHz)	CH	PAPR (dB)		Freq. (MHz)	CH	PAPR (dB)	
		64QAM	Limit			64QAM	Limit
2502.5	20775	6.35	13	2505.0	20800	6.40	13
2535.0	21100	6.31	13	2535.0	21100	6.48	13
2567.5	21375	6.38	13	2565.0	21350	6.32	13

LTE BAND 7							
Channel bandwidth: 15MHz				Channel bandwidth: 20MHz			
Freq. (MHz)	CH	PAPR (dB)		Freq. (MHz)	CH	PAPR (dB)	
		64QAM	Limit			64QAM	Limit
2507.5	20825	6.46	13	2510	20850	6.49	13
2535.0	21100	6.32	13	2535	21100	6.49	13
2562.5	21375	6.56	13	2560	21350	6.24	13

LTE BAND 12							
Channel bandwidth: 1.4MHz				Channel bandwidth: 3MHz			
Freq. (MHz)	CH	PAPR (dB)		Freq. (MHz)	CH	PAPR (dB)	
		64QAM	Limit			64QAM	Limit
699.7	23017	6.64	13	700.5	23025	6.63	13
707.5	23095	6.84	13	707.5	23095	6.64	13
715.3	23173	6.18	13	714.5	23165	6.24	13

LTE BAND 12							
Channel bandwidth: 5MHz				Channel bandwidth: 10MHz			
Freq. (MHz)	CH	PAPR (dB)		Freq. (MHz)	CH	PAPR (dB)	
		64QAM	Limit			64QAM	Limit
701.5	23035	6.32	13	704.0	23060	6.50	13
707.5	23095	6.59	13	707.5	23095	6.57	13
713.5	23155	6.59	13	711.0	23130	6.66	13

LTE BAND 13							
Channel bandwidth: 5MHz				Channel bandwidth: 10MHz			
Freq. (MHz)	CH	PAPR (dB)		Freq. (MHz)	CH	PAPR (dB)	
		64QAM	Limit			64QAM	Limit
779.5	23205	6.79	13	782.0	23230	6.45	13
782.0	23230	6.65	13				
784.5	23255	6.83	13				

Unless otherwise stated the results shown in this test report refer only to the sample(s) tested and such sample(s) are retained for 90 days only.

除非另有說明，此報告結果僅對測試之樣品負責，同時此樣品僅保留90天。本報告未經本公司書面許可，不可部份複製。

This document is issued by the Company subject to its General Conditions of Service printed overleaf, available on request or accessible at <http://www.sgs.com.tw/Terms-and-Conditions> and for electronic format documents, subject to Terms and Conditions for Electronic Documents at <http://www.sgs.com.tw/Terms-and-Conditions>. Attention is drawn to the limitation of liability, indemnification and jurisdiction issues defined therein. Any holder of this document is advised that information contained hereon reflects the Company's findings at the time of its intervention only and within the limits of Client's instructions, if any. The Company's sole responsibility is to its Client and this document does not exonerate parties to a transaction from exercising all their rights and obligations under the transaction documents. This document cannot be reproduced except in full, without prior written approval of the Company. Any unauthorized alteration, forgery or falsification of the content or appearance of this document is unlawful and offenders may be prosecuted to the fullest extent of the law.

LTE BAND 14							
Channel bandwidth: 5MHz				Channel bandwidth: 10MHz			
Freq. (MHz)	CH	PAPR (dB)		Freq. (MHz)	CH	PAPR (dB)	
		64QAM	Limit			64QAM	Limit
790.5	23305	6.78	13	793.0	23330	6.35	13
793	23330	6.46	13				
795.5	23355	6.36	13				
LTE BAND 17							
Channel bandwidth: 5MHz				Channel bandwidth: 10MHz			
Freq. (MHz)	CH	PAPR (dB)		Freq. (MHz)	CH	PAPR (dB)	
		64QAM	Limit			64QAM	Limit
706.5	23755	5.89	13	709.0	23780	6.51	13
710.0	23790	6.69	13	710.0	23790	6.71	13
713.5	23825	6.14	13	711.0	23800	6.14	13
LTE BAND 25							
Channel bandwidth: 1.4MHz				Channel bandwidth: 3MHz			
Freq. (MHz)	CH	PAPR (dB)		Freq. (MHz)	CH	PAPR (dB)	
		64QAM	Limit			64QAM	Limit
1850.7	26047	7.03	13	1851.5	26055	6.72	13
1882.5	26365	6.96	13	1882.5	26365	6.79	13
1914.3	26683	6.39	13	1913.5	26675	6.46	13

LTE BAND 25							
Channel bandwidth: 5MHz				Channel bandwidth: 10MHz			
Freq. (MHz)	CH	PAPR (dB)		Freq. (MHz)	CH	PAPR (dB)	
		64QAM	Limit			64QAM	Limit
1852.5	26065	6.76	13	1855.0	26090	6.77	13
1882.5	26365	7.06	13	1882.5	26365	6.70	13
1912.5	26665	6.54	13	1910.0	26640	6.70	13

LTE BAND 25							
Channel bandwidth: 15MHz				Channel bandwidth: 20MHz			
Freq. (MHz)	CH	PAPR (dB)		Freq. (MHz)	CH	PAPR (dB)	
		64QAM	Limit			64QAM	Limit
1857.5	26115	7.05	13	1860.0	26140	6.85	13
1882.5	26365	7.00	13	1882.5	26365	7.02	13
1907.5	26615	6.10	13	1905.0	26590	6.59	13

Unless otherwise stated the results shown in this test report refer only to the sample(s) tested and such sample(s) are retained for 90 days only.

除非另有說明，此報告結果僅對測試之樣品負責，同時此樣品僅保留90天。本報告未經本公司書面許可，不可部份複製。

This document is issued by the Company subject to its General Conditions of Service printed overleaf, available on request or accessible at <http://www.sgs.com.tw/Terms-and-Conditions> and for electronic format documents, subject to Terms and Conditions for Electronic Documents at <http://www.sgs.com.tw/Terms-and-Conditions>. Attention is drawn to the limitation of liability, indemnification and jurisdiction issues defined therein. Any holder of this document is advised that information contained hereon reflects the Company's findings at the time of its intervention only and within the limits of Client's instructions, if any. The Company's sole responsibility is to its Client and this document does not exonerate parties to a transaction from exercising all their rights and obligations under the transaction documents. This document cannot be reproduced except in full, without prior written approval of the Company. Any unauthorized alteration, forgery or falsification of the content or appearance of this document is unlawful and offenders may be prosecuted to the fullest extent of the law.

LTE BAND 26 for part 90S							
Channel bandwidth: 1.4MHz				Channel bandwidth: 3MHz			
Freq. (MHz)	CH	PAPR (dB)		Freq. (MHz)	CH	PAPR (dB)	
		64QAM	Limit			64QAM	Limit
814.7	26697	6.50	13	815.5	26705	6.51	13
819.0	26740	6.89	13	819	26740	6.94	13
823.3	26783	6.27	13	822.5	26775	6.11	13

LTE BAND 26 for part 90S							
Channel bandwidth: 5MHz				Channel bandwidth: 10MHz			
Freq. (MHz)	CH	PAPR (dB)		Freq. (MHz)	CH	PAPR (dB)	
		64QAM	Limit			64QAM	Limit
816.5	26715	6.59	13	819.0	26740	6.58	13
819.0	26740	6.96	13				
821.5	26765	6.73	13				

LTE BAND 26							
Channel bandwidth: 1.4MHz				Channel bandwidth: 3MHz			
Freq. (MHz)	CH	PAPR (dB)		Freq. (MHz)	CH	PAPR (dB)	
		64QAM	Limit			64QAM	Limit
814.7	26697	6.19	13	815.5	26705	6.29	13
831.5	26865	6.81	13	831.5	26865	6.69	13
848.3	27033	6.48	13	847.5	27025	6.53	13

LTE BAND 26							
Channel bandwidth: 5MHz				Channel bandwidth: 10MHz			
Freq. (MHz)	CH	PAPR (dB)		Freq. (MHz)	CH	PAPR (dB)	
		64QAM	Limit			64QAM	Limit
816.5	26715	6.32	13	820.0	26750	6.57	13
831.5	26865	6.52	13	831.5	26865	6.42	13
846.5	27015	6.46	13	844.0	26990	6.55	13

LTE BAND 26							
Channel bandwidth: 15MHz							
Freq. (MHz)	CH	PAPR (dB)					
		64QAM	Limit				
822.5	26775	6.62	13				
831.5	26865	6.20	13				
841.5	26965	6.74	13				

Unless otherwise stated the results shown in this test report refer only to the sample(s) tested and such sample(s) are retained for 90 days only.

除非另有說明，此報告結果僅對測試之樣品負責，同時此樣品僅保留90天。本報告未經本公司書面許可，不可部份複製。

This document is issued by the Company subject to its General Conditions of Service printed overleaf, available on request or accessible at <http://www.sgs.com.tw/Terms-and-Conditions> and for electronic format documents, subject to Terms and Conditions for Electronic Documents at <http://www.sgs.com.tw/Terms-and-Conditions>. Attention is drawn to the limitation of liability, indemnification and jurisdiction issues defined therein. Any holder of this document is advised that information contained hereon reflects the Company's findings at the time of its intervention only and within the limits of Client's instructions, if any. The Company's sole responsibility is to its Client and this document does not exonerate parties to a transaction from exercising all their rights and obligations under the transaction documents. This document cannot be reproduced except in full, without prior written approval of the Company. Any unauthorized alteration, forgery or falsification of the content or appearance of this document is unlawful and offenders may be prosecuted to the fullest extent of the law.

LTE BAND 30							
Channel bandwidth: 5MHz				Channel bandwidth: 10MHz			
Freq. (MHz)	CH	PAPR (dB)		Freq. (MHz)	CH	PAPR (dB)	
		64QAM	Limit			64QAM	Limit
2307.5	27685	6.25	13	2310.0	27710	6.42	13
2310.0	27710	6.41	13				
2312.5	27735	6.45	13				

LTE BAND 38							
Channel bandwidth: 15MHz				Channel bandwidth: 20MHz			
Freq. (MHz)	CH	PAPR (dB)		Freq. (MHz)	CH	PAPR (dB)	
		64QAM	Limit			64QAM	Limit
2577.5	37825	9.91	13	2580.0	37850	6.27	13
2595.0	38000	6.86	13	2595.0	38000	6.66	13
2612.5	38175	6.54	13	2610.0	38150	6.55	13

LTE BAND 41							
Channel bandwidth: 5MHz				Channel bandwidth: 10MHz			
Freq. (MHz)	CH	PAPR (dB)		Freq. (MHz)	CH	PAPR (dB)	
		64QAM	Limit			64QAM	Limit
2498.5	39675	8.37	13	2501.0	39700	6.47	13
2593.0	40620	7.98	13	2593.0	40620	6.68	13
2687.5	41565	7.76	13	2685.0	41540	6.59	13

LTE BAND 41							
Channel bandwidth: 15MHz				Channel bandwidth: 20MHz			
Freq. (MHz)	CH	PAPR (dB)		Freq. (MHz)	CH	PAPR (dB)	
		64QAM	Limit			64QAM	Limit
2503.5	39725	6.74	13	2506.0	39750	7.85	13
2593.0	40620	6.33	13	2593.0	40620	7.74	13
2682.5	41515	6.78	13	2680.0	41490	8.57	13

Unless otherwise stated the results shown in this test report refer only to the sample(s) tested and such sample(s) are retained for 90 days only.

除非另有說明，此報告結果僅對測試之樣品負責，同時此樣品僅保留90天。本報告未經本公司書面許可，不可部份複製。

This document is issued by the Company subject to its General Conditions of Service printed overleaf, available on request or accessible at <http://www.sgs.com.tw/Terms-and-Conditions> and for electronic format documents, subject to Terms and Conditions for Electronic Documents at <http://www.sgs.com.tw/Terms-and-Conditions>. Attention is drawn to the limitation of liability, indemnification and jurisdiction issues defined therein. Any holder of this document is advised that information contained hereon reflects the Company's findings at the time of its intervention only and within the limits of Client's instructions, if any. The Company's sole responsibility is to its Client and this document does not exonerate parties to a transaction from exercising all their rights and obligations under the transaction documents. This document cannot be reproduced except in full, without prior written approval of the Company. Any unauthorized alteration, forgery or falsification of the content or appearance of this document is unlawful and offenders may be prosecuted to the fullest extent of the law.

LTE BAND 66							
Channel bandwidth: 1.4MHz				Channel bandwidth: 3MHz			
Freq. (MHz)	CH	PAPR (dB)		Freq. (MHz)	CH	PAPR (dB)	
		64QAM	Limit			64QAM	Limit
1710.7	131979	6.47	13	1711.5	131987	6.38	13
1745.0	132322	7.01	13	1745.0	132322	6.78	13
1779.3	132665	6.24	13	1778.5	132657	6.27	13

LTE BAND 66							
Channel bandwidth: 5MHz				Channel bandwidth: 10MHz			
Freq. (MHz)	CH	PAPR (dB)		Freq. (MHz)	CH	PAPR (dB)	
		64QAM	Limit			64QAM	Limit
1712.5	131997	6.24	13	1715.0	132022	6.12	13
1745.0	132322	6.61	13	1745.0	132322	6.66	13
1777.5	132647	6.08	13	1775.0	132622	6.86	13

LTE BAND 66							
Channel bandwidth: 15MHz				Channel bandwidth: 20MHz			
Freq. (MHz)	CH	PAPR (dB)		Freq. (MHz)	CH	PAPR (dB)	
		64QAM	Limit			64QAM	Limit
1717.5	132047	6.45	13	1720.0	132072	6.39	13
1745.0	132322	6.87	13	1745.0	132322	7.00	13
1772.5	132597	6.69	13	1770.0	132572	6.56	13

LTE BAND 71							
Channel bandwidth: 5MHz				Channel bandwidth: 10MHz			
Freq. (MHz)	CH	PAPR (dB)		Freq. (MHz)	CH	PAPR (dB)	
		64QAM	Limit			64QAM	Limit
665.5	133147	6.95	13	668.0	133172	6.80	13
680.5	133297	6.96	13	680.5	133297	6.46	13
695.5	133447	6.50	13	693.0	133422	6.42	13

LTE BAND 71							
Channel bandwidth: 15MHz				Channel bandwidth: 20MHz			
Freq. (MHz)	CH	PAPR (dB)		Freq. (MHz)	CH	PAPR (dB)	
		64QAM	Limit			64QAM	Limit
670.5	133197	6.60	13	673.0	133222	6.99	13
680.5	133297	6.61	13	680.5	133297	6.68	13
690.5	133397	6.64	13	688.0	133372	6.79	13

Unless otherwise stated the results shown in this test report refer only to the sample(s) tested and such sample(s) are retained for 90 days only.

除非另有說明，此報告結果僅對測試之樣品負責，同時此樣品僅保留90天。本報告未經本公司書面許可，不可部份複製。

This document is issued by the Company subject to its General Conditions of Service printed overleaf, available on request or accessible at <http://www.sgs.com.tw/Terms-and-Conditions> and for electronic format documents, subject to Terms and Conditions for Electronic Documents at <http://www.sgs.com.tw/Terms-and-Conditions>. Attention is drawn to the limitation of liability, indemnification and jurisdiction issues defined therein. Any holder of this document is advised that information contained hereon reflects the Company's findings at the time of its intervention only and within the limits of Client's instructions, if any. The Company's sole responsibility is to its Client and this document does not exonerate parties to a transaction from exercising all their rights and obligations under the transaction documents. This document cannot be reproduced except in full, without prior written approval of the Company. Any unauthorized alteration, forgery or falsification of the content or appearance of this document is unlawful and offenders may be prosecuted to the fullest extent of the law.

Band2_1.4MHz_64QAM_RB6_0_CH18607

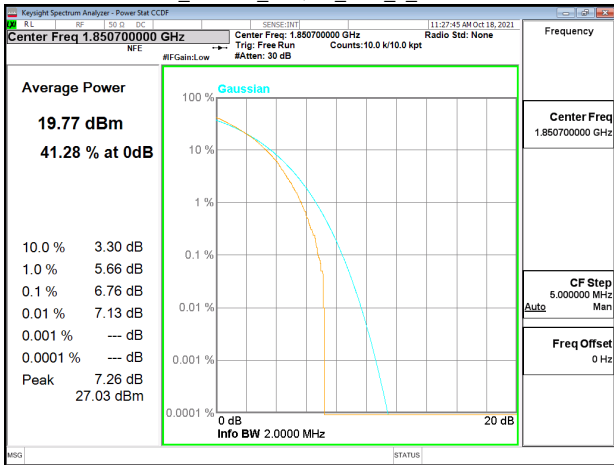

Band2_3MHz_64QAM_RB15_0_CH18615

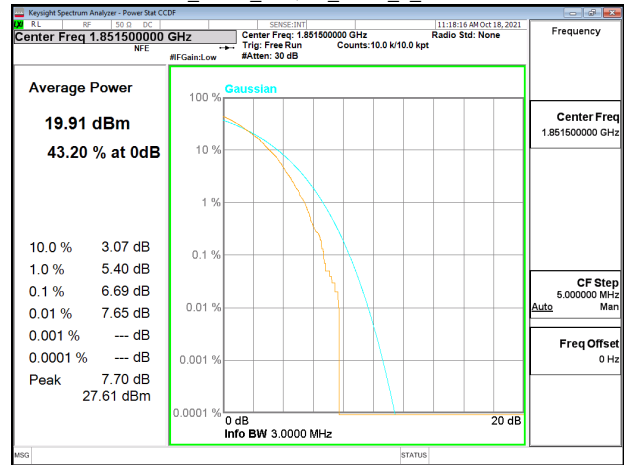

Band2_1.4MHz_64QAM_RB6_0_CH18900

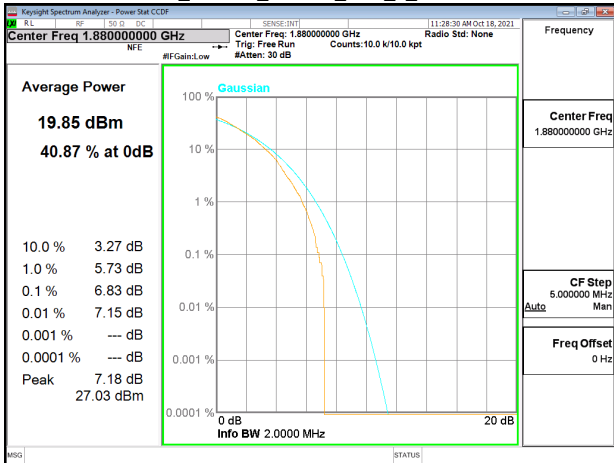

Band2_3MHz_64QAM_RB15_0_CH18900

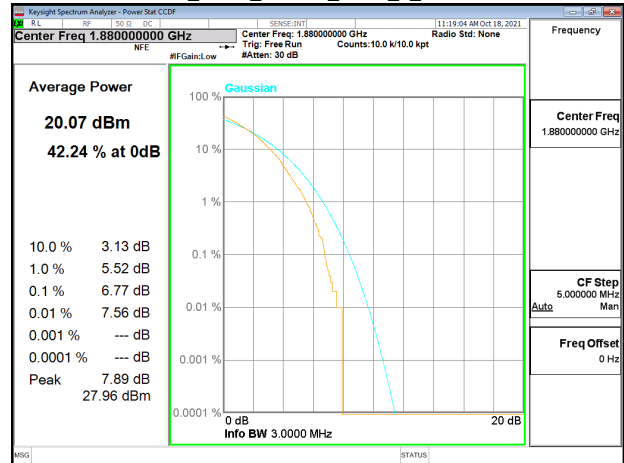

Band2_1.4MHz_64QAM_RB6_0_CH19193

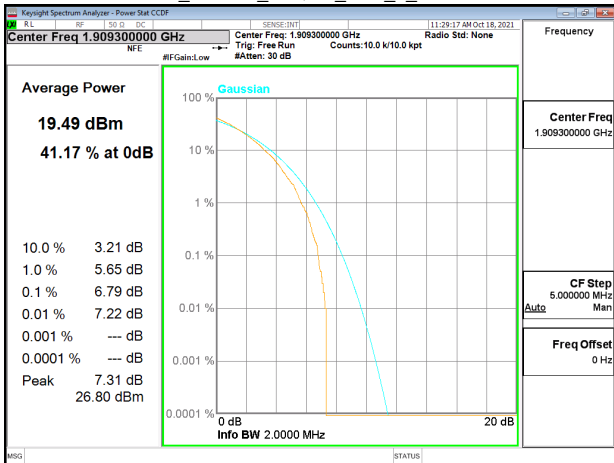

Band2_3MHz_64QAM_RB15_0_CH19185

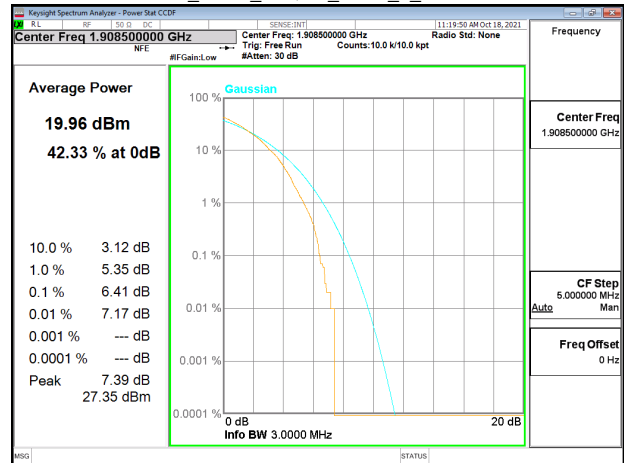

Unless otherwise stated the results shown in this test report refer only to the sample(s) tested and such sample(s) are retained for 90 days only.

除非另有說明，此報告結果僅對測試之樣品負責，同時此樣品僅保留90天。本報告未經本公司書面許可，不可部份複製。

This document is issued by the Company subject to its General Conditions of Service printed overleaf, available on request or accessible at <http://www.sgs.com.tw/Terms-and-Conditions> and for electronic format documents, subject to Terms and Conditions for Electronic Documents at <http://www.sgs.com.tw/Terms-and-Conditions>. Attention is drawn to the limitation of liability, indemnification and jurisdiction issues defined therein. Any holder of this document is advised that information contained herein reflects the Company's findings at the time of its intervention only and within the limits of Client's instructions, if any. The Company's sole responsibility is to its Client and this document does not exonerate parties to a transaction from exercising all their rights and obligations under the transaction documents. This document cannot be reproduced except in full, without prior written approval of the Company. Any unauthorized alteration, forgery or falsification of the content or appearance of this document is unlawful and offenders may be prosecuted to the fullest extent of the law.

Band2_5MHz_64QAM_RB25_0_CH18625

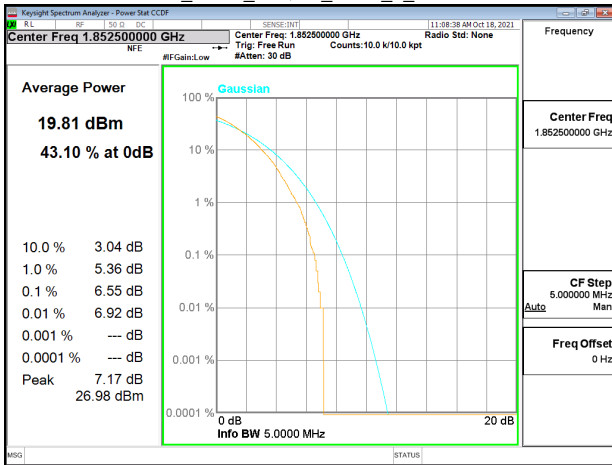

Band2_10MHz_64QAM_RB50_0_CH18650

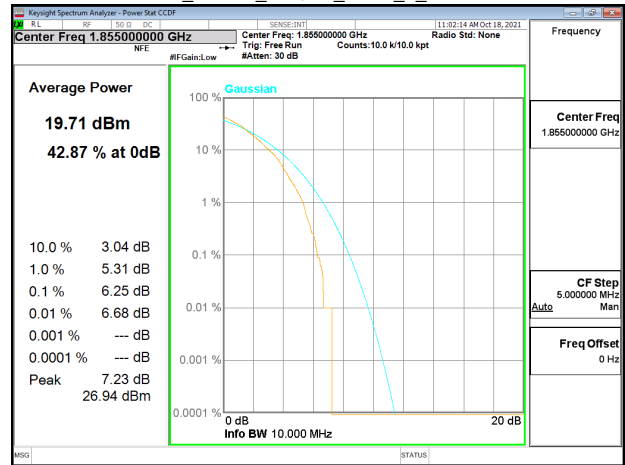

Band2_5MHz_64QAM_RB25_0_CH18900

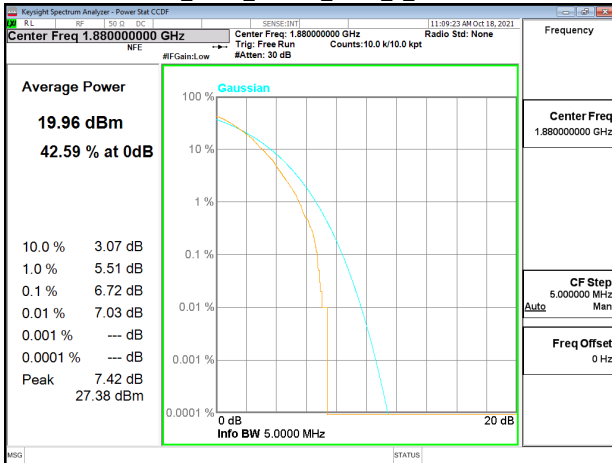

Band2_10MHz_64QAM_RB50_0_CH18900

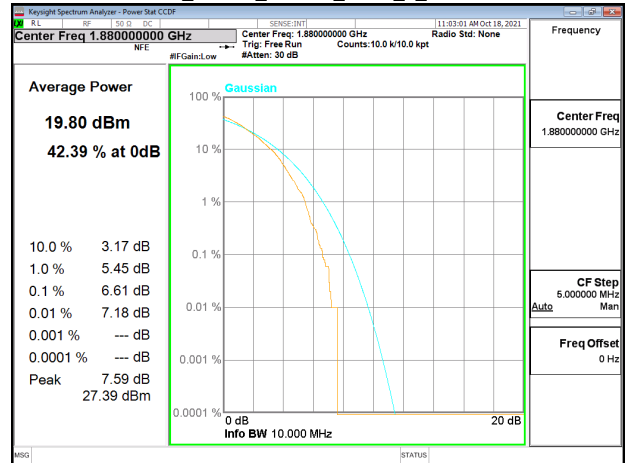

Band2_5MHz_64QAM_RB25_0_CH19175

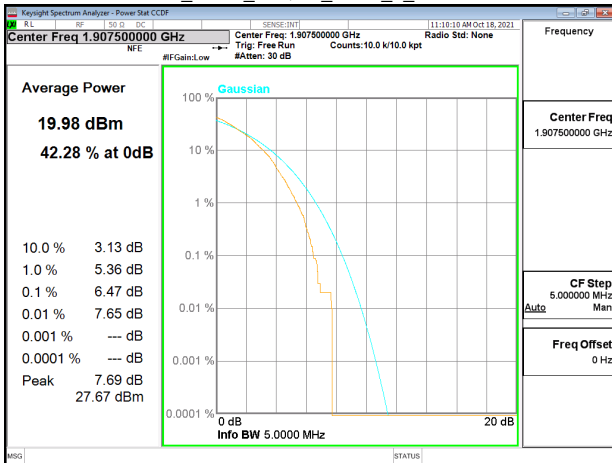

Band2_10MHz_64QAM_RB50_0_CH19150

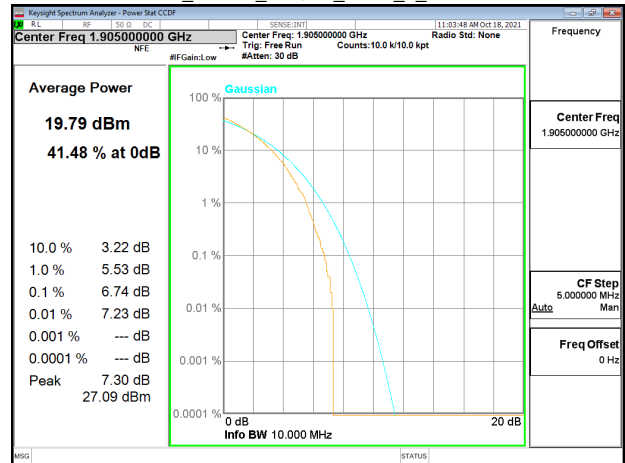

Unless otherwise stated the results shown in this test report refer only to the sample(s) tested and such sample(s) are retained for 90 days only.

除非另有說明，此報告結果僅對測試之樣品負責，同時此樣品僅保留90天。本報告未經本公司書面許可，不可部份複製。
This document is issued by the Company subject to its General Conditions of Service printed overleaf, available on request or accessible at <http://www.sgs.com.tw/Terms-and-Conditions> and for electronic format documents, subject to Terms and Conditions for Electronic Documents at <http://www.sgs.com.tw/Terms-and-Conditions>. Attention is drawn to the limitation of liability, indemnification and jurisdiction issues defined therein. Any holder of this document is advised that information contained herein reflects the Company's findings at the time of its intervention only and within the limits of Client's instructions, if any. The Company's sole responsibility is to its Client and this document does not exonerate parties to a transaction from exercising all their rights and obligations under the transaction documents. This document cannot be reproduced except in full, without prior written approval of the Company. Any unauthorized alteration, forgery or falsification of the content or appearance of this document is unlawful and offenders may be prosecuted to the fullest extent of the law.

Band2_15MHz_64QAM_RB75_0_CH18675

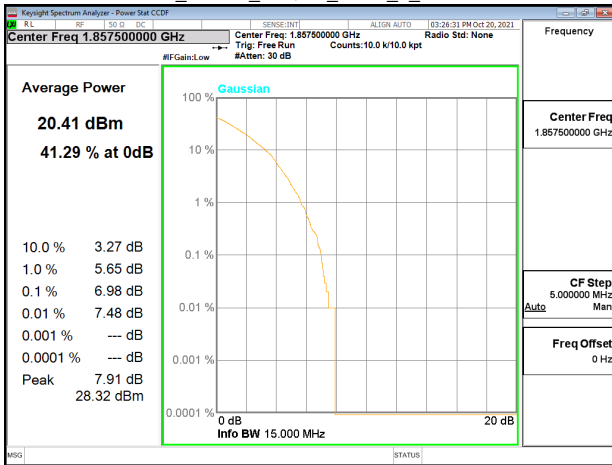

Band2_20MHz_64QAM_RB100_0_CH18700

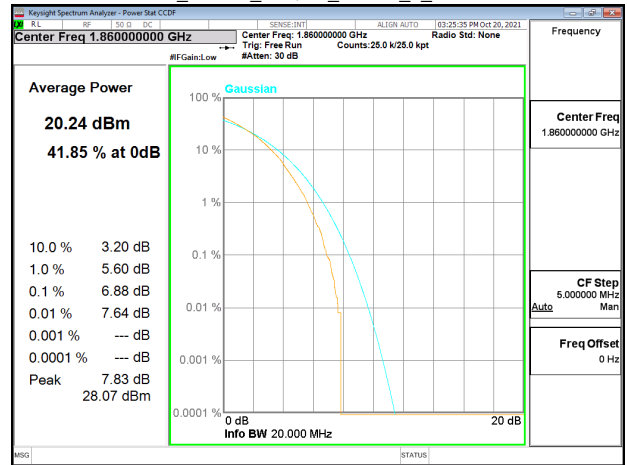

Band2_15MHz_64QAM_RB75_0_CH18900

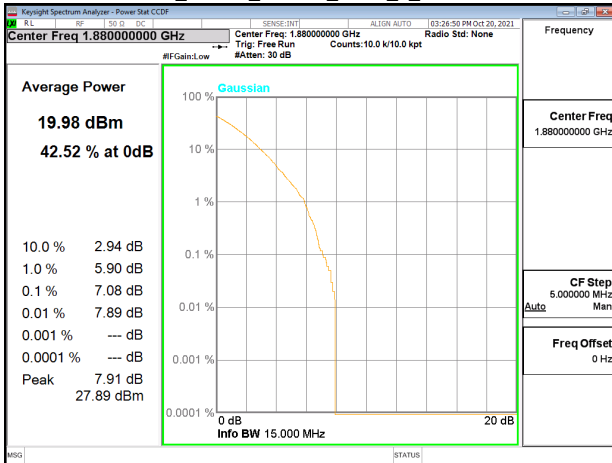

Band2_20MHz_64QAM_RB100_0_CH18900

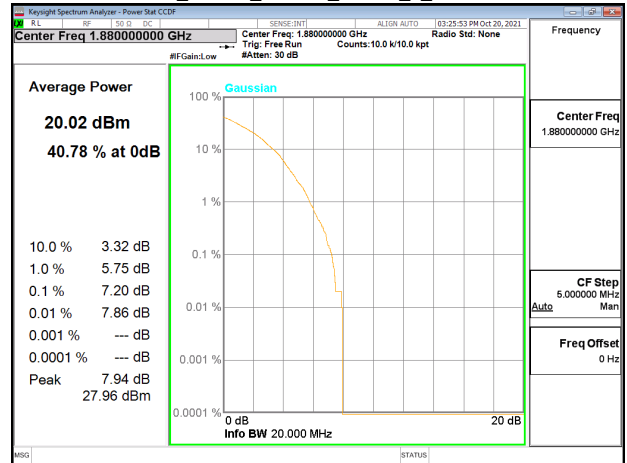

Band2_15MHz_64QAM_RB75_0_CH19125

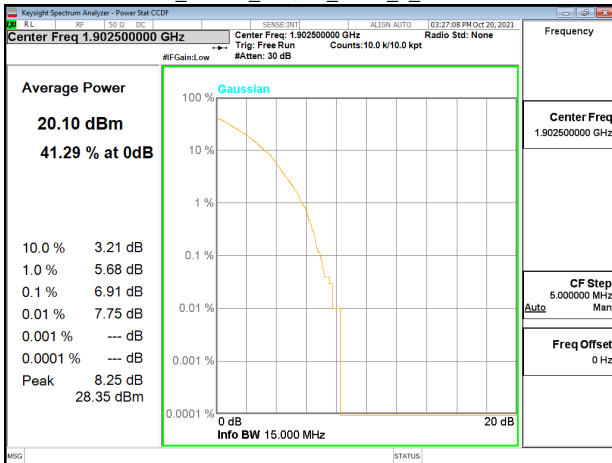

Band2_20MHz_64QAM_RB100_0_CH19100

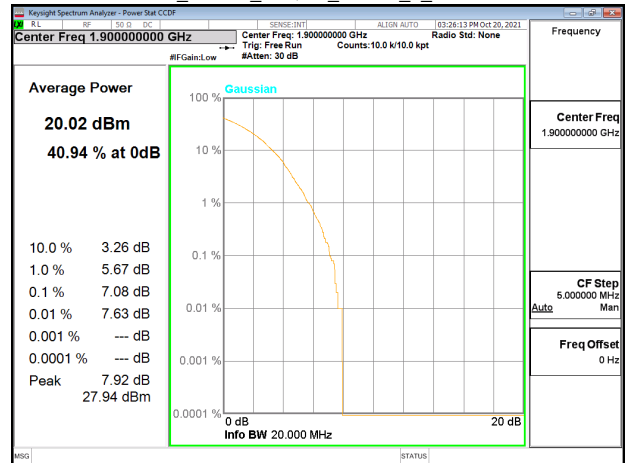

Unless otherwise stated the results shown in this test report refer only to the sample(s) tested and such sample(s) are retained for 90 days only.

除非另有說明，此報告結果僅對測試之樣品負責，同時此樣品僅保留90天。本報告未經本公司書面許可，不可部份複製。

This document is issued by the Company subject to its General Conditions of Service printed overleaf, available on request or accessible at <http://www.sgs.com.tw/Terms-and-Conditions> and for electronic format documents, subject to Terms and Conditions for Electronic Documents at <http://www.sgs.com.tw/Terms-and-Conditions>. Attention is drawn to the limitation of liability, indemnification and jurisdiction issues defined therein. Any holder of this document is advised that information contained hereon reflects the Company's findings at the time of its intervention only and within the limits of Client's instructions, if any. The Company's sole responsibility is to its Client and this document does not exonerate parties to a transaction from exercising all their rights and obligations under the transaction documents. This document cannot be reproduced except in full, without prior written approval of the Company. Any unauthorized alteration, forgery or falsification of the content or appearance of this document is unlawful and offenders may be prosecuted to the fullest extent of the law.

Band4_1.4MHz_64QAM_RB6_0_CH19957

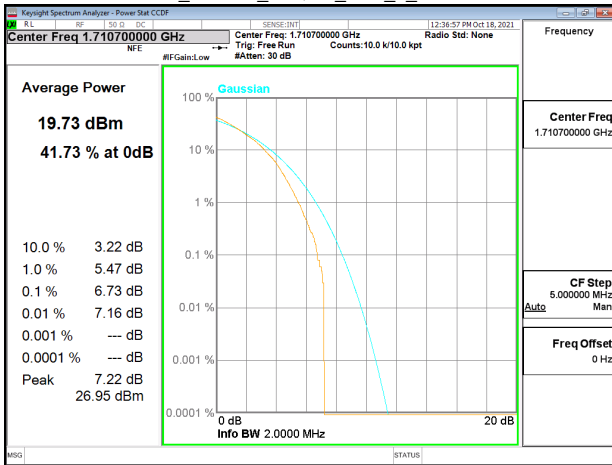

Band4_3MHz_64QAM_RB15_0_CH19965

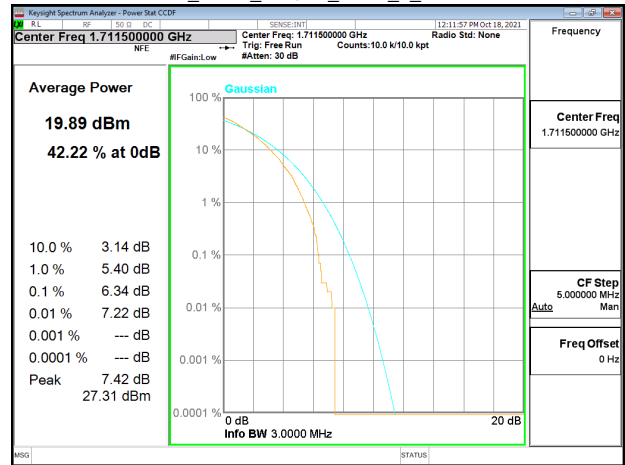

Band4_1.4MHz_64QAM_RB6_0_CH20175

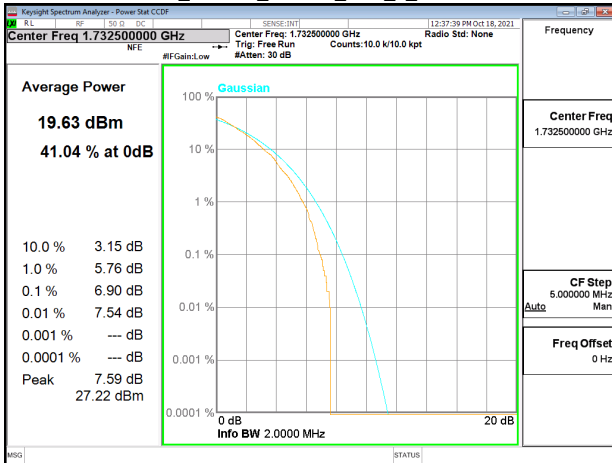

Band4_3MHz_64QAM_RB15_0_CH20175

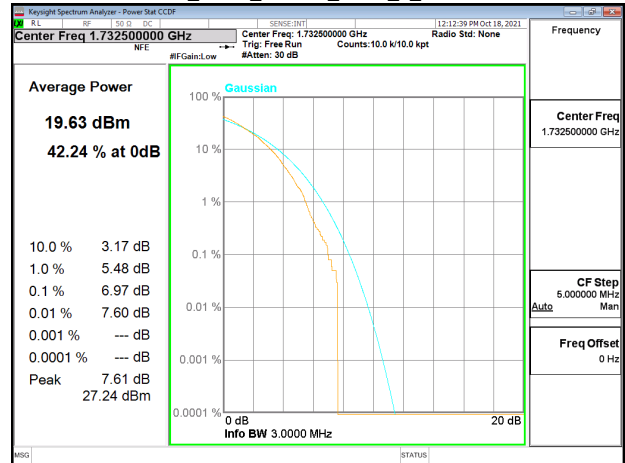

Band4_1.4MHz_64QAM_RB6_0_CH20393

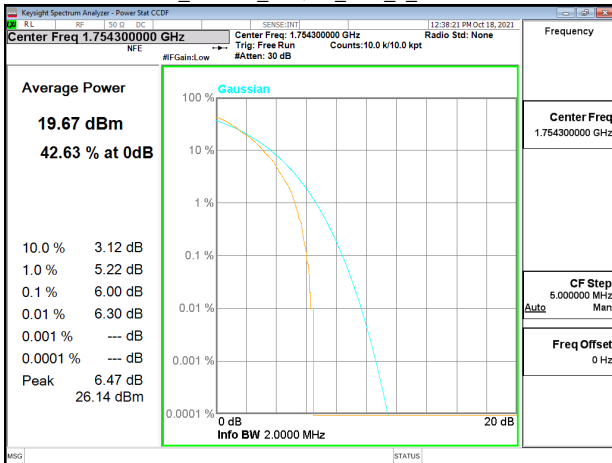

Band4_3MHz_64QAM_RB15_0_CH20385

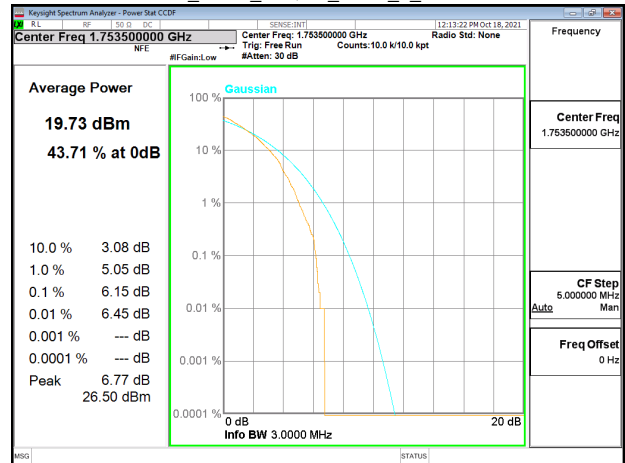

Unless otherwise stated the results shown in this test report refer only to the sample(s) tested and such sample(s) are retained for 90 days only.

除非另有說明，此報告結果僅對測試之樣品負責，同時此樣品僅保留90天。本報告未經本公司書面許可，不可部份複製。
This document is issued by the Company subject to its General Conditions of Service printed overleaf, available on request or accessible at <http://www.sgs.com.tw/Terms-and-Conditions> and for electronic format documents, subject to Terms and Conditions for Electronic Documents at <http://www.sgs.com.tw/Terms-and-Conditions>. Attention is drawn to the limitation of liability, indemnification and jurisdiction issues defined therein. Any holder of this document is advised that information contained herein reflects the Company's findings at the time of its intervention only and within the limits of Client's instructions, if any. The Company's sole responsibility is to its Client and this document does not exonerate parties to a transaction from exercising all their rights and obligations under the transaction documents. This document cannot be reproduced except in full, without prior written approval of the Company. Any unauthorized alteration, forgery or falsification of the content or appearance of this document is unlawful and offenders may be prosecuted to the fullest extent of the law.

Band4_5MHz_64QAM_RB25_0_CH19975

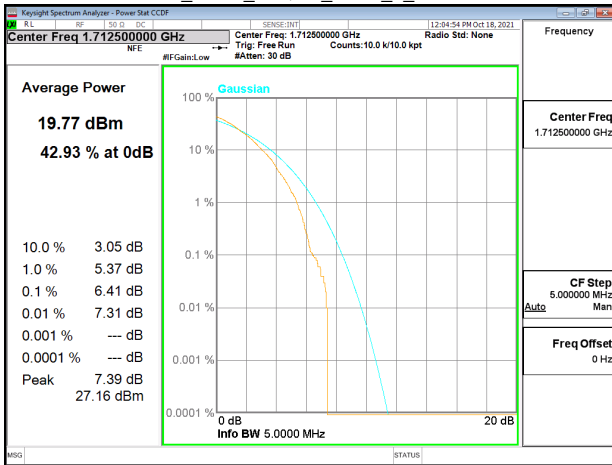

Band4_10MHz_64QAM_RB50_0_CH20000

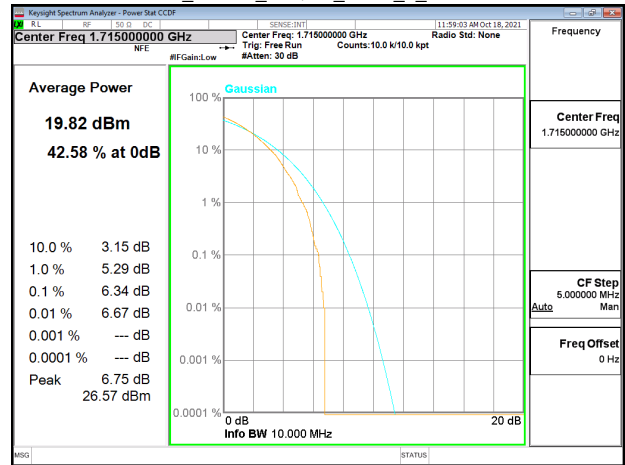

Band4_5MHz_64QAM_RB25_0_CH20175

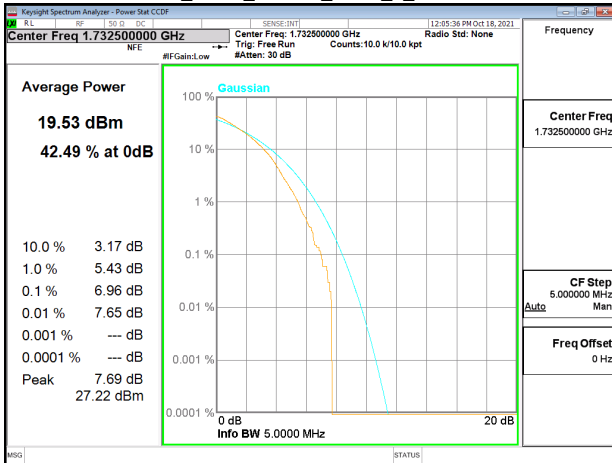

Band4_10MHz_64QAM_RB50_0_CH20175

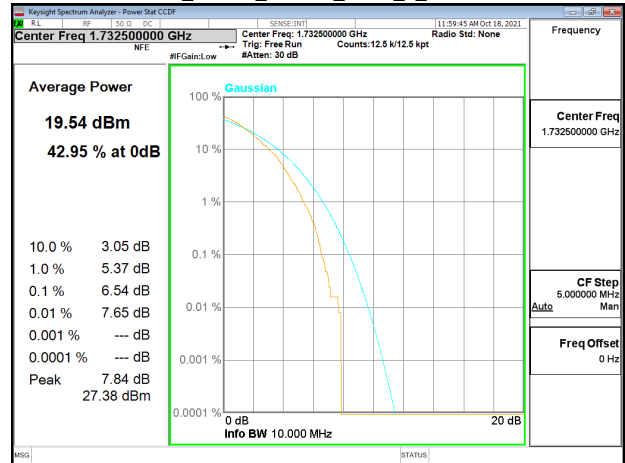

Band4_5MHz_64QAM_RB25_0_CH20375

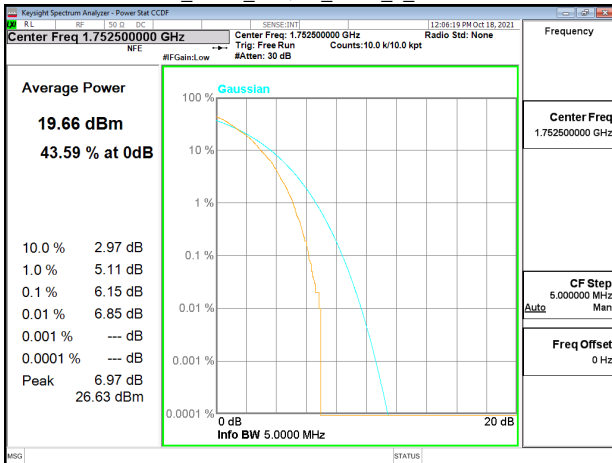

Band4_10MHz_64QAM_RB50_0_CH20350

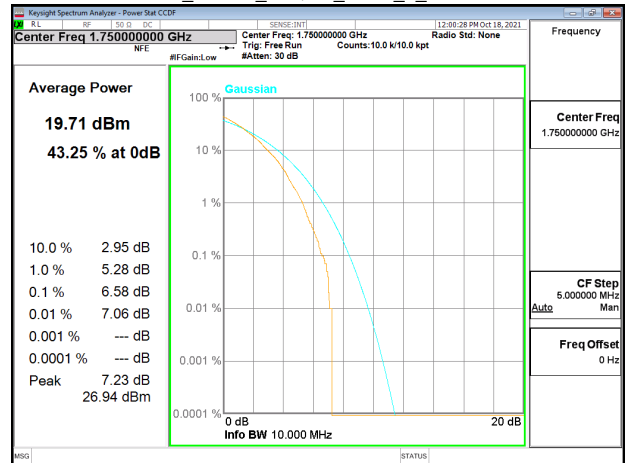

Unless otherwise stated the results shown in this test report refer only to the sample(s) tested and such sample(s) are retained for 90 days only.

除非另有說明，此報告結果僅對測試之樣品負責，同時此樣品僅保留90天。本報告未經本公司書面許可，不可部份複製。

This document is issued by the Company subject to its General Conditions of Service printed overleaf, available on request or accessible at <http://www.sgs.com.tw/Terms-and-Conditions> and for electronic format documents, subject to Terms and Conditions for Electronic Documents at <http://www.sgs.com.tw/Terms-and-Conditions>. Attention is drawn to the limitation of liability, indemnification and jurisdiction issues defined therein. Any holder of this document is advised that information contained herein reflects the Company's findings at the time of its intervention only and within the limits of Client's instructions, if any. The Company's sole responsibility is to its Client and this document does not exonerate parties to a transaction from exercising all their rights and obligations under the transaction documents. This document cannot be reproduced except in full, without prior written approval of the Company. Any unauthorized alteration, forgery or falsification of the content or appearance of this document is unlawful and offenders may be prosecuted to the fullest extent of the law.