



Test report No:  
 NIE: 66136RRF.002A1

## Test Report

Reference Standard:  
 USA FCC Part 27  
 CANADA RSS-130, RSS-139

(*) Identification of item tested	LTE Wireless module
(*) Trademark	Telit
(*) Model and /or type reference	LE910C1-SAX
Other identification of the product	HW version: 1.10 SW version: M0F.313002 FCC ID: R17LE910CXSA IC: 5131A-LE910CXSA
(*) Features	GNSS, Audio: VoLTE
Applicant	Telit Wireless Solutions Co., LTD 13th Fl., Shinyoung Securities Bld, 6, Gukjegeumyung-ro 8-gil, Yeongdeungpo-gu, Seoul, 07330, South Korea
Test method requested, standard	USA FCC Part 27 (10-1-19 Edition). CANADA RSS-130 Issue 2, Feb. 2019. CANADA RSS-139 Issue 3, Jul. 2015. ANSI C63.26: 2015. KDB 971168 D01 Power Meas License Digital Systems v03r01, April. 2018.
Summary	IN COMPLIANCE
Approved by (name / position & signature)	Rafael López Martín EMC Consumer & RF Lab. Manager
Date of issue	2020-11-20
Report template No	FDT08_22 (*) "Data provided by the client"

# Index

Competences and guarantees .....	3
General conditions .....	3
Uncertainty.....	3
Data provided by the client .....	3
Usage of samples .....	4
Test sample description.....	5
Identification of the client .....	6
Testing period and place .....	6
Document history.....	6
Environmental conditions .....	6
Remarks and comments.....	7
Testing verdicts.....	8
Summary .....	8
Appendix A: Test results for FCC PART 27 / RSS-130, RSS-139 .....	9

## Competences and guarantees

---

DEKRA Testing and Certification S.A.U. is a testing laboratory competent to carry out the tests described in this report.

DEKRA Testing and Certification is a FCC-recognized accredited testing laboratory with appropriate scope of accreditation that include testing performed in this test report.

In order to assure the traceability to other national and international laboratories, DEKRA Testing and Certification S.A.U. has a calibration and maintenance program for its measurement equipment.

DEKRA Testing and Certification S.A.U. guarantees the reliability of the data presented in this report, which is the result of the measurements and the tests performed to the item under test on the date and under the conditions stated on the report and, it is based on the knowledge and technical facilities available at DEKRA Testing and Certification S.A.U. at the time of performance of the test.

DEKRA Testing and Certification S.A.U. is liable to the client for the maintenance of the confidentiality of all information related to the item under test and the results of the test.

The results presented in this Test Report apply only to the particular item under test established in this document.

**IMPORTANT:** No parts of this report may be reproduced or quoted out of context, in any form or by any means, except in full, without the previous written permission of DEKRA Testing and Certification S.A.U.

## General conditions

---

1. This report is only referred to the item that has undergone the test.
2. This report does not constitute or imply on its own an approval of the product by the Certification Bodies or competent Authorities.
3. This document is only valid if complete; no partial reproduction can be made without previous written permission of DEKRA Testing and Certification S.A.U.
4. This test report cannot be used partially or in full for publicity and/or promotional purposes without previous written permission of DEKRA Testing and Certification S.A.U. and the Accreditation Bodies.

## Uncertainty

---

Uncertainty (factor  $k=2$ ) was calculated according to the DEKRA Testing and Certification S.A.U. internal document PODT000.

## Data provided by the client

---

The following data has been provided by the client:

1. Information relating to the description of the sample ("Identification of the item tested", "Trademark", "Model and/or type reference tested").
2. The sample of the model LE910C1-SAX is a LTE Wireless module with LTE Cat.1; LTE bands: FDD B2, B4, B12, B66; Data Capability: LTE CAT1 10/5 Mb.

DEKRA Testing and Certification S.A.U. declines any responsibility with respect to the information provided by the client and that may affect the validity of results.

## Usage of samples

Samples undergoing test have been selected by: The client.

- Sample S/01 is composed of the following elements:

Control Nº	Description	Model	Serial Nº	Date of reception
66136/011	LTE Wireless module	LE910C1-SAX	--	2020/09/23
66136/017	Antenna	--	--	2020/09/23
66136/018	Antenna	--	--	2020/09/23
66136/020	Antenna	--	--	2020/09/23

Auxiliary elements used with the Sample S/01:

Control Nº	Description	Model	Serial Nº	Date of reception
66136/012	Cradle	--	--	2020/09/23
66136/026	Power Cable DC	--	--	2020/09/23

Sample S/01 has undergone the following test(s): The Radiated tests indicated in Appendix A.

- Sample S/02 is composed of the following elements:

Control Nº	Description	Model	Serial Nº	Date of reception
66136/011	LTE Wireless module	LE910C1-SAX	--	2020/09/23

Auxiliary elements used with the Sample S/01:

Control Nº	Description	Model	Serial Nº	Date of reception
66136/012	Cradle	--	--	2020/09/23
66136/026	Power Cable DC	--	--	2020/09/23

Sample S/02 has undergone the following test(s): The Conducted tests indicated in Appendix A.

## Test sample description

Ports.....:	Port name and description	Cable					
		Specified max length [m]	Attached during test	Shielded	Coupled to patient <sup>(3)</sup>		
	Main(Primary) port	x	<input type="checkbox"/>	<input type="checkbox"/>	<input type="checkbox"/>		
	Diversity port	x	<input type="checkbox"/>	<input type="checkbox"/>	<input type="checkbox"/>		
	GNSS port	x	<input type="checkbox"/>	<input type="checkbox"/>	<input type="checkbox"/>		
			<input type="checkbox"/>	<input type="checkbox"/>	<input type="checkbox"/>		
Supplementary information to the ports.....:	SMA type connectors						
Rated power supply 3.4~4.2V, typ 3.8V	Voltage and Frequency		Reference poles				
			L1	L2	L3	N	PE
	<input type="checkbox"/>	AC:	<input type="checkbox"/>	<input type="checkbox"/>	<input type="checkbox"/>	<input type="checkbox"/>	<input type="checkbox"/>
	<input type="checkbox"/>	AC:	<input type="checkbox"/>	<input type="checkbox"/>	<input type="checkbox"/>	<input type="checkbox"/>	<input type="checkbox"/>
	<input checked="" type="checkbox"/>	DC: 3.4~4.2V, typ 3.8V					
<input type="checkbox"/>	DC:						
Rated Power .....	0.2W						
Clock frequencies.....:	19.2MHz						
Other parameters .....							
Software version .....	M0F.313002						
Hardware version .....	1.10						
Dimensions in cm (W x H x D) .....	28.2 x 28.2 x 2.2mm						
Mounting position .....	<input type="checkbox"/>	Table top equipment					
	<input type="checkbox"/>	Wall/Ceiling mounted equipment					
	<input type="checkbox"/>	Floor standing equipment					
	<input type="checkbox"/>	Hand-held equipment					
	<input checked="" type="checkbox"/>	Other: Variable equipment					
Modules/parts.....:	Module/parts of test item		Type	Manufacturer			
Accessories (not part of the test item) .....	Description		Type	Manufacturer			
Documents as provided by the applicant .....	Description		File name	Issue date			
	Hardware_Design_Guide		LE910Cx_Hardware_Design_Guide	2020-07-31			

(3) Only for Medical Equipment

## Identification of the client

Telit Wireless Solutions Co., LTD  
 13th Fl.,Shinyoung Securities Bld, 6, Gukjegeumyung-ro 8-gil, Yeongdeungpo-gu, Seoul, 07330, South Korea

## Testing period and place

Test Location	DEKRA Testing and Certification S.A.U.
Date (start)	2020-09-23
Date (finish)	2020-10-21

## Document history

Report number	Date	Description
66136RRF.002	2020-11-05	First release
66136RRF.002A1	2020-11-20	Second release: First modification due to typos. This modification test report cancels and replaces the test report 66136RRF.002

## Environmental conditions

In the control chamber, the following limits were not exceeded during the test:

Temperature	Min. = 15 °C Max. = 35 °C
Relative humidity	Min. = 20 % Max. = 75 %

In the semianechoic chamber, the following limits were not exceeded during the test.

Temperature	Min. = 15 °C Max. = 35 °C
Relative humidity	Min. = 20 % Max. = 75 %

In the chamber for conducted measurements, the following limits were not exceeded during the test:

Temperature	Min. = 15 °C Max. = 35 °C
Relative humidity	Min. = 20 % Max. = 75 %

## Remarks and comments

The tests have been performed by the technical personnel: Cristina Calle, Miguel Manuel López, Javier Miguel Nadales and Verónica García.

Used instrumentation:

### Conducted Measurements

	Last Calibration	Due Calibration
1. Shielded Room ETS LINDGREN S101	N.A.	N.A.
2. Chamber HERAEUS VMT 04/35	2020/07	2022/07
3. DC Power Supply, 30V/5A KEYSIGHT TECHNOLOGIES U8002A	N.A.	N.A.
4. Signal and Spectrum Analyzer 10 Hz - 40 GHz ROHDE AND SCHWARZ FSV40	2019/09	2021/09
5. Wideband Radio Communication Tester ROHDE AND SCHWARZ CMW500	2020/04	2021/04
6. RF Attenuator 10 dB, 5W, DC-40 GHz Aeroflex Weinschel 75A-10-11	2020/05	2021/05
7. Digital Multimeter FLUKE 179	2020/10	2021/10
8. Signal Analyzer 20 Hz to 8 GHz ROHDE AND SCHWARZ FSQ8	2020/10	2022/10

### Radiated Measurements

	Last Calibration	Due Calibration
1. Semianechoic Absorber Lined Chamber ETS LINDGREN FACT 3 200 STP	N.A.	N.A.
2. Shielded Room ETS LINDGREN S101	N.A.	N.A.
3. Horn Antenna 1-18 GHz SCHWARZBECK MESS-ELEKTRONIK BBHA 9120 D	2019/11	2022/11
4. Biconical/Log Antenna 30 MHz - 6 GHz ETS LINDGREN 3142E	2020/04	2023/04
5. RF Preamplifier, 40 dB ,1-18 GHz BONN ELEKTRONIK BLMA 0118-1M	2020/05	2021/05
6. Preamplifier G>40dB 10MHz-6GHz, BONN ELEKTRONIK, BLNA 0160-01N	2020/02	2021/02
7. Spectrum Analyzer ROHDE AND SCHWARZ FSW50	2020/07	2022/07
8. EMI Test Receiver 7 GHz ROHDE AND SCHWARZ ESR7	2019/10	2021/10
9. Wideband Radio Communication Tester ROHDE AND SCHWARZ CMW500	2020/04	2021/04
10. DC Power Supply, 30V/5A KEYSIGHT TECHNOLOGIES U8002A	N.A.	N.A.
11. Digital multimeter FLUKE 179	2020/06	2021/06

## Testing verdicts

Not applicable:	N/A
Pass:	P
Fail:	F
Not measured:	N/M

## Summary

FCC PART 27 / RSS-130, RSS-139 PARAGRAPH		
Requirement – Test case	Verdict	Remark
FCC 27.50 / RSS-130 4.6., RSS-139 6.5.: RF Output Power	P	
FCC 2.1047 / RSS-130 4.1., RSS-139 6.2.: Modulation Characteristics	P	
FCC 27.54 / RSS-130 4.5., RSS-139 6.4.: Frequency Stability	P	
FCC 2.1049: Occupied Bandwidth	P	
FCC 27.53 / RSS-130 4.7., RSS-139 6.6.: Spurious Emissions at Antenna Terminals	P	
FCC 27.53 / RSS-130 4.7., RSS-139 6.6.: Radiated Emissions	P	
<u>Supplementary information and remarks:</u>		
None.		



## Appendix A: Test results for FCC PART 27 / RSS-130, RSS-139

## INDEX

TEST CONDITIONS.....	11
RF Output Power .....	13
Modulation Characteristics .....	37
Frequency Stability .....	40
Occupied Bandwidth.....	44
Spurious emissions at antenna terminals .....	79
Spurious emissions at antenna terminals at Block Edges.....	99
Radiated emissions .....	130

## TEST CONDITIONS

### POWER SUPPLY (V):

Vn: 3.80 Vdc  
 Vmin: 3.23 Vdc (\*)  
 Vmax: 4.37 Vdc (\*)

Type of Power Supply: Internal DC.

The subscripts 'n', 'min' and 'max' indicate voltage test conditions (nominal, minimum and maximum respectively), as declared by the applicant.

### ANTENNA:

LOW Bands		ANTENNA TYPE
LTE Band 12	+3 dBi	External (Dipole)

MIDDLE Bands		ANTENNA TYPE
LTE Band 66	+3.5 dBi	External (Dipole)

### TEST FREQUENCIES:

#### LTE Band 4. QPSK AND 16QAM MODULATION:

	Channel (Frequency. MHz)					
	BW = 1.4 MHz	BW = 3 MHz	BW = 5 MHz	BW = 10 MHz	BW = 15 MHz	BW = 20 MHz
Lowest	19957 (1710.7)	19965 (1711.5)	19975 (1712.5)	20000 (1715.0)	20025 (1717.5)	20050 (1720.0)
Middle	20175 (1732.5)	20175 (1732.5)	20175 (1732.5)	20175 (1732.5)	20175 (1732.5)	20175 (1732.5)
Highest	20393 (1754.3)	20385 (1753.5)	20375 (1752.5)	20350 (1750.0)	20325 (1747.5)	20300 (1745.0)

NOTE: This band is completely included in LTE Band 66, so the channels of Band 66 were tested to give conformity to the assigned block.

#### LTE Band 12. QPSK AND 16QAM MODULATION:

	Channel (Frequency)			
	BW = 1.4 MHz	BW = 3 MHz	BW = 5 MHz	BW = 10 MHz
Low	23017 (699.7 MHz)	23025 (700.5 MHz)	23035 (701.5 MHz)	23060 (704.0 MHz)
Middle	23095 (707.5 MHz)	23095 (707.5 MHz)	23095 (707.5 MHz)	23095 (707.5 MHz)
High	23173 (715.3 MHz)	23165 (714.5 MHz)	23155 (713.5 MHz)	23130 (711.0 MHz)

Note: LTE Category 1 device, so for BW=10 MHz the 16QAM modulation does not support transmission in RB=All.

LTE Band 66. QPSK AND 16QAM MODULATION:

	Channel (Frequency)					
	BW = 1.4 MHz	BW = 3 MHz	BW = 5 MHz	BW = 10 MHz	BW = 15 MHz	BW = 20 MHz
Low	131979 (1710.7 MHz)	131987 (1711.5 MHz)	131997 (1712.5 MHz)	132022 (1715.0 MHz)	132047 (1717.5 MHz)	132072 (1720.0 MHz)
Middle	132322 (1745.0 MHz)	132322 (1745.0 MHz)	132322 (1745.0 MHz)	132322 (1745.0 MHz)	132322 (1745.0 MHz)	132322 (1745.0 MHz)
High	132665 (1779.3 MHz)	132657 (1778.5 MHz)	132647 (1777.5 MHz)	132622 (1775.0 MHz)	132597 (1772.5 MHz)	132572 (1770.0 MHz)

Note: LTE Category 1 device, so for BW=10 MHz, 15 MHz and 20 MHz the 16QAM modulation does not support transmission in RB=All.

## RF Output Power

### SPECIFICATION:

#### FCC §27.50 (c) (10):

(10) Portable stations (hand-held devices) in the 600 MHz uplink band and the 698-746 MHz band, and fixed and mobile stations in the 600 MHz uplink band are limited to 3 watts ERP.

#### FCC §27.50 (d) (4) & (5):

(4) Fixed, mobile, and portable (hand-held) stations operating in the 1710-1755 MHz band and mobile and portable stations operating in the 1695-1710 MHz and 1755-1780 MHz bands are limited to 1 watt EIRP. Fixed stations operating in the 1710-1755 MHz band are limited to a maximum antenna height of 10 meters above ground. Mobile and portable stations operating in these bands must employ a means for limiting power to the minimum necessary for successful communications.

(5) Equipment employed must be authorized in accordance with the provisions of §24.51. Power measurements for transmissions by stations authorized under this section may be made either in accordance with a Commission-approved average power technique or in compliance with paragraph (d)(6) of this section. In measuring transmissions in this band using an average power technique, the peak-to-average ratio (PAR) of the transmission may not exceed 13 dB.

#### RSS-130 Clause 4.6:

##### 4.6.1 General

The transmitter output power shall be measured in terms of average power. In addition, the peak-to-average power ratio (PAPR) of the transmitter shall not exceed 13 dB for more than 0.1% of the time and shall use a signal corresponding to the High PAPR during periods of continuous transmission.

##### 4.6.2 Frequency bands 617-652 MHz and 663-698 MHz

The e.r.p. shall not exceed 3 watts for mobile equipment, fixed subscriber equipment and portable equipment.

For base and fixed equipment other than fixed subscriber equipment, refer to SRSP-518 for the equivalent isotropically radiated power (e.i.r.p.) limits.

##### 4.6.3 Frequency bands 698-756 MHz and 777-787 MHz

The e.r.p. shall not exceed 30 watts for mobile equipment and outdoor fixed subscriber equipment. The e.r.p. shall not exceed 3 watts for portable equipment and indoor fixed subscriber equipment.

For base and fixed equipment other than fixed subscriber equipment, refer to SRSP-518 for the e.i.r.p. limits.

#### RSS-139 Clause 6.5:

The equivalent isotropically radiated power (e.i.r.p.) for mobile and portable transmitters shall not exceed one watt. The e.i.r.p. for fixed and base stations in the band 1710-1780 MHz shall not exceed one watt.

Consult SRSP-513 for e.i.r.p. limits on fixed and base stations operating in the band 2110-2180 MHz.

In addition, the peak to average power ratio (PAPR) of the equipment shall not exceed 13 dB for more than 0.1% of the time, using a signal that corresponds to the High PAPR during periods of continuous transmission.

**METHOD:**

The conducted RF output power measurements were made at the RF output terminals of the EUT using the power meter of the Universal Radio Communication tester R&S CMW500, selecting maximum transmission power of the EUT and different modes of modulation.

The maximum equivalent isotropically radiated power (e.i.r.p.) is calculated by adding the declared maximum antenna gain (dBi).

The maximum effective radiated power e.r.p. is calculated from the maximum equivalent isotropically radiated power (e.i.r.p.) by subtracting 2.15 dB:

$$E.R.P. = E.I.R.P. - 2.15 \text{ dB}$$

The peak-to-average power ratio (PAPR) is measured using an attenuator, power splitter and spectrum analyser with a Complementary Cumulative Distribution Function implemented.  
The EUT was controlled via the Universal Radio Communication tester R&S CMW500 selecting maximum transmission power of the EUT and different modes of modulation.

**TEST SETUP:**

1. CONDUCTED AVERAGE POWER:

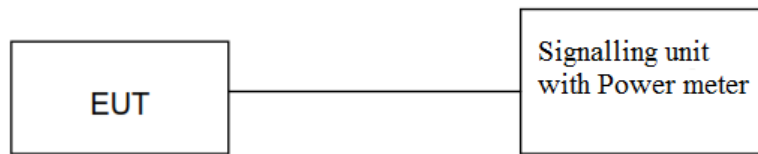

2. PEAK-TO-AVERAGE POWER RATIO (PAPR) and Conducted Average power:

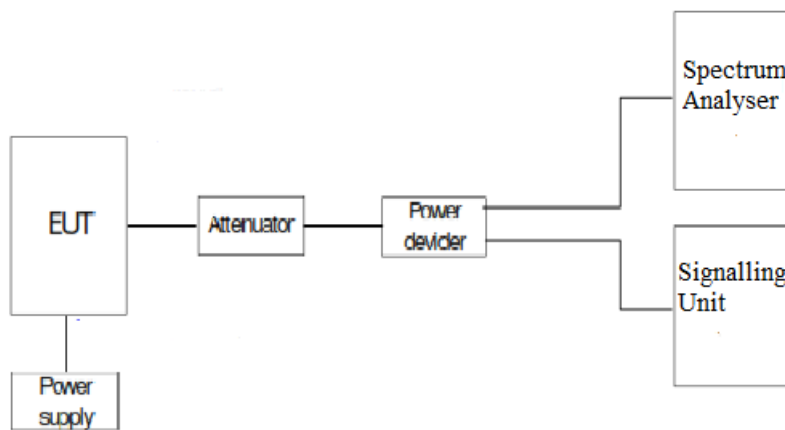

**RESULTS:**

**1. CONDUCTED AVERAGE POWER:**

LTE Band 12:

LTE Band 12. QPSK MODULATION. Bandwidth = 1.4 MHz.

Channel	Low	Middle	High
Maximum declared antenna gain (dBi)	+3	+3	+3
Measured maximum average power (dBm) at antenna port	23.27	22.94	23.13
Maximum equivalent isotropically radiated power (E.I.R.P.) (dBm)	26.27	25.94	26.13
Maximum effective radiated power E.R.P. (dBm)	24.12	23.79	23.98
PAPR (dB)	(*)	(*)	(*)
Measurement uncertainty (dB)	<±1.58		

Worst case AVERAGE POWER: Modulation QPSK. RB Size: 1. RB Offset: 0.  
 (\*): Preliminary measurements determined that the modulation 16QAM, RB Size: 6, RB Offset: 0 as the worst case. The results in the next tables shows the results for this configuration.

LTE Band 12. 16QAM MODULATION. Bandwidth = 1.4 MHz.

Channel	Low	Middle	High
Maximum declared antenna gain (dBi)	+3	+3	+3
Measured maximum average power (dBm) at antenna port	21.79	22.11	22.51
Maximum equivalent isotropically radiated power (E.I.R.P.) (dBm)	24.79	25.11	25.51
Maximum effective radiated power E.R.P. (dBm)	22.64	22.96	23.36
PAPR (dB)	6.15	5.96	5.98
Measurement uncertainty (dB)	<±1.58		

Worst case AVERAGE POWER: Modulation 16QAM. RB Size: 1. RB Offset: 0.  
 Worst case PAPR: Modulation 16QAM. RB Size: 6. RB Offset: 0.

LTE Band 12. QPSK MODULATION. Bandwidth = 3 MHz.

Channel	Low	Middle	High
Maximum declared antenna gain (dBi)	+3	+3	+3
Measured maximum average power (dBm) at antenna port	23.19	23.25	23.19
Maximum equivalent isotropically radiated power (E.I.R.P.) (dBm)	26.19	26.25	26.19
Maximum effective radiated power E.R.P. (dBm)	24.04	24.10	24.04
PAPR (dB)	(*)	(*)	(*)
Measurement uncertainty (dB)	<±1.58		

Worst case AVERAGE POWER: Modulation QPSK. RB Size: 1. RB Offset: 7.  
 (\*): Preliminary measurements determined that the modulation 16QAM, RB Size: 15, RB Offset: 0 as the worst case. The results in the next tables shows the results for this configuration.

LTE Band 12. 16QAM MODULATION. Bandwidth = 3 MHz.

Channel	Low	Middle	High
Maximum declared antenna gain (dBi)	+3	+3	+3
Measured maximum average power (dBm) at antenna port	22.31	22.45	21.84
Maximum equivalent isotropically radiated power (E.I.R.P.) (dBm)	25.31	25.45	24.84
Maximum effective radiated power E.R.P. (dBm)	23.16	23.30	22.69
PAPR (dB)	6.11	6.09	6.09
Measurement uncertainty (dB)	<±1.58		

Worst case AVERAGE POWER: Modulation 16QAM. RB Size: 1. RB Offset: 0.  
 Worst case PAPR: Modulation 16QAM. RB Size: 15. RB Offset: 0.

LTE Band 12. QPSK MODULATION. Bandwidth = 5 MHz.

Channel	Low	Middle	High
Maximum declared antenna gain (dBi)	+3	+3	+3
Measured maximum average power (dBm) at antenna port	22.75	23.03	22.28
Maximum equivalent isotropically radiated power (E.I.R.P.) (dBm)	25.75	26.03	25.28
Maximum effective radiated power E.R.P. (dBm)	23.60	23.88	23.13
PAPR (dB)	(*)	(*)	(*)
Measurement uncertainty (dB)	<±1.58		

Worst case AVERAGE POWER: Modulation QPSK. RB Size: 1. RB Offset: 0.  
 (\*): Preliminary measurements determined that the modulation 16QAM, RB Size: 25, RB Offset: 0 as the worst case. The results in the next tables shows the results for this configuration.



LTE Band 12. 16QAM MODULATION. Bandwidth = 5 MHz.

Channel	Low	Middle	High
Maximum declared antenna gain (dBi)	+3	+3	+3
Measured maximum average power (dBm) at antenna port	21.17	21.93	21.82
Maximum equivalent isotropically radiated power (E.I.R.P.) (dBm)	24.17	24.93	24.82
Maximum effective radiated power E.R.P. (dBm)	22.02	22.78	22.67
PAPR (dB)	6.12	5.93	6.09
Measurement uncertainty (dB)	<±1.58		

Worst case AVERAGE POWER: Modulation 16QAM. RB Size: 1. RB Offset: 12.  
 Worst case PAPR: Modulation 16QAM. RB Size: 25. RB Offset: 0.

LTE Band 12. QPSK MODULATION. Bandwidth = 10 MHz.

Channel	Low	Middle	High
Maximum declared antenna gain (dBi)	+3	+3	+3
Measured maximum average power (dBm) at antenna port	23.25	23.29	23.22
Maximum equivalent isotropically radiated power (E.I.R.P.) (dBm)	26.25	26.29	26.22
Maximum effective radiated power E.R.P. (dBm)	24.10	24.14	24.07
PAPR (dB)	(*)	(*)	(*)
Measurement uncertainty (dB)	<±1.58		

Worst case AVERAGE POWER: Modulation QPSK. RB Size: 1. RB Offset: 24.  
 (\*): Preliminary measurements determined that the modulation 16QAM, RB Size: 25, RB Offset: 24 as the worst case. The results in the next tables shows the results for this configuration.

LTE Band 12. 16QAM MODULATION. Bandwidth = 10 MHz.

Channel	Low	Middle	High
Maximum declared antenna gain (dBi)	+3	+3	+3
Measured maximum average power (dBm) at antenna port	22.08	22.78	22.82
Maximum equivalent isotropically radiated power (E.I.R.P.) (dBm)	25.08	25.78	25.82
Maximum effective radiated power E.R.P. (dBm)	22.93	23.63	23.67
PAPR (dB)	5.74	5.82	5.95
Measurement uncertainty (dB)	<±1.58		

Worst case AVERAGE POWER: Modulation 16QAM. RB Size: 1. RB Offset: 24.  
 Worst case PAPR (\*): Modulation 16QAM. RB Size: 25. RB Offset: 24.

(\*): Not supported RB Size: 50, RB Offset: 0.

**LTE Band 66:**

LTE Band 66. QPSK MODULATION. Bandwidth = 1.4 MHz.

Channel	Low	Middle	High
Maximum declared antenna gain (dBi)	+3.5	+3.5	+3.5
Measured maximum average power (dBm) at antenna port	22.84	23.28	22.91
Maximum equivalent isotropically radiated power (E.I.R.P.) (dBm)	26.34	26.78	26.41
PAPR (dB)	(*)	(*)	(*)
Measurement uncertainty (dB)	<±1.58		

Worst case AVERAGE POWER: Modulation QPSK. RB Size: 1. RB Offset: 0.  
 (\*): Preliminary measurements determined that the modulation 16QAM, RB Size: 6, RB Offset: 0 as the worst case.  
 The results in the next tables shows the results for this configuration.

LTE Band 66. 16QAM MODULATION. Bandwidth = 1.4 MHz.

Channel	Low	Middle	High
Maximum declared antenna gain (dBi)	+3.5	+3.5	+3.5
Measured maximum average power (dBm) at antenna port	22.12	22.70	21.85
Maximum equivalent isotropically radiated power (E.I.R.P.) (dBm)	25.62	26.20	25.35
PAPR (dB)	5.59	5.34	5.34
Measurement uncertainty (dB)	<±1.58		

Worst case AVERAGE POWER: Modulation 16QAM. RB Size: 1. RB Offset: 2.  
 Worst case PAPR: Modulation 16QAM. RB Size: 6. RB Offset: 0.

LTE Band 66. QPSK MODULATION. Bandwidth = 3 MHz.

Channel	Low	Middle	High
Maximum declared antenna gain (dBi)	+3.5	+3.5	+3.5
Measured maximum average power (dBm) at antenna port	22.97	23.16	22.91
Maximum equivalent isotropically radiated power (E.I.R.P.) (dBm)	26.47	26.66	26.41
PAPR (dB)	(*)	(*)	(*)
Measurement uncertainty (dB)	<±1.58		

Worst case AVERAGE POWER: Modulation QPSK. RB Size: 1. RB Offset: 7.  
 (\*): Preliminary measurements determined that the modulation 16QAM, RB Size: 15, RB Offset: 0 as the worst case.  
 The results in the next tables shows the results for this configuration.

LTE Band 66. 16QAM MODULATION. Bandwidth = 3 MHz.

Channel	Low	Middle	High
Maximum declared antenna gain (dBi)	+3.5	+3.5	+3.5
Measured maximum average power (dBm) at antenna port	22.45	22.63	22.11
Maximum equivalent isotropically radiated power (E.I.R.P.) (dBm)	25.95	26.13	25.61
PAPR (dB)	5.74	5.50	5.58
Measurement uncertainty (dB)	<±1.58		

Worst case AVERAGE POWER: Modulation 16QAM. RB Size: 1. RB Offset: 0.  
 Worst case PAPR: Modulation 16QAM. RB Size: 15. RB Offset: 0.

LTE Band 66. QPSK MODULATION. Bandwidth = 5 MHz.

Channel	Low	Middle	High
Maximum declared antenna gain (dBi)	+3.5	+3.5	+3.5
Measured maximum average power (dBm) at antenna port	22.96	23.16	23.05
Maximum equivalent isotropically radiated power (E.I.R.P.) (dBm)	26.46	26.66	26.55
PAPR (dB)	(*)	(*)	(*)
Measurement uncertainty (dB)	<±1.58		

Worst case AVERAGE POWER: Modulation QPSK. RB Size: 1. RB Offset: 12.  
 (\*): Preliminary measurements determined that the modulation 16QAM, RB Size: 25, RB Offset: 0 as the worst case. The results in the next tables shows the results for this configuration.

LTE Band 66. 16QAM MODULATION. Bandwidth = 5 MHz.

Channel	Low	Middle	High
Maximum declared antenna gain (dBi)	+3.5	+3.5	+3.5
Measured maximum average power (dBm) at antenna port	21.7	22.65	22.34
Maximum equivalent isotropically radiated power (E.I.R.P.) (dBm)	25.2	26.15	25.84
PAPR (dB)	5.51	5.53	5.69
Measurement uncertainty (dB)	<±1.58		

Worst case AVERAGE POWER: Modulation 16QAM. RB Size: 1. RB Offset: 12.  
 Worst case PAPR: Modulation 16QAM. RB Size: 25. RB Offset: 0.

LTE Band 66. QPSK MODULATION. Bandwidth = 10 MHz.

Channel	Low	Middle	High
Maximum declared antenna gain (dBi)	+3.5	+3.5	+3.5
Measured maximum average power (dBm) at antenna port	23.10	23.41	22.84
Maximum equivalent isotropically radiated power (E.I.R.P.) (dBm)	26.60	26.91	26.34
PAPR (dB)	(*)	(*)	(*)
Measurement uncertainty (dB)	<±1.58		

Worst case AVERAGE POWER: Modulation QPSK. RB Size: 1. RB Offset: 0.  
 (\*): Preliminary measurements determined that the modulation 16QAM, RB Size: 25, RB Offset: 24 as the worst case. The results in the next tables shows the results for this configuration.

LTE Band 66. 16QAM MODULATION. Bandwidth = 10 MHz.

Channel	Low	Middle	High
Maximum declared antenna gain (dBi)	+3.5	+3.5	+3.5
Measured maximum average power (dBm) at antenna port	22.59	22.72	21.75
Maximum equivalent isotropically radiated power (E.I.R.P.) (dBm)	26.09	26.22	25.25
PAPR (dB)	5.48	5.18	5.24
Measurement uncertainty (dB)	<±1.58		

Worst case AVERAGE POWER: Modulation 16QAM. RB Size: 1. RB Offset: 0.  
 Worst case PAPR (\*): Modulation 16QAM. RB Size: 25. RB Offset: 24.

(\*): Not supported RB Size: 50, RB Offset: 0.

LTE Band 66. QPSK MODULATION. Bandwidth = 15 MHz.

Channel	Low	Middle	High
Maximum declared antenna gain (dBi)	+3.5	+3.5	+3.5
Measured maximum average power (dBm) at antenna port	23.13	23.25	23
Maximum equivalent isotropically radiated power (E.I.R.P.) (dBm)	26.63	26.75	26.5
PAPR (dB)	(*)	(*)	(*)
Measurement uncertainty (dB)	<±1.58		

Worst case AVERAGE POWER: Modulation QPSK. RB Size: 1. RB Offset: 74.  
 (\*): Preliminary measurements determined that the modulation 16QAM, RB Size: 1, RB Offset: 0 as the worst case. The results in the next tables shows the results for this configuration.

LTE Band 66. 16QAM MODULATION. Bandwidth = 15 MHz.

Channel	Low	Middle	High
Maximum declared antenna gain (dBi)	+3.5	+3.5	+3.5
Measured maximum average power (dBm) at antenna port	23.07	22.6	22.51
Maximum equivalent isotropically radiated power (E.I.R.P.) (dBm)	26.57	26.1	26.01
PAPR (dB)	4.74	4.76	3.96
Measurement uncertainty (dB)	<±1.58		

Worst case AVERAGE POWER: Modulation 16QAM. RB Size: 1. RB Offset: 37.  
 Worst case PAPR: Modulation 16QAM. RB Size: 1. RB Offset: 0.

LTE Band 66. QPSK MODULATION. Bandwidth = 20 MHz.

Channel	Low	Middle	High
Maximum declared antenna gain (dBi)	+3.5	+3.5	+3.5
Measured maximum average power (dBm) at antenna port	22.80	23.20	22.97
Maximum equivalent isotropically radiated power (E.I.R.P.) (dBm)	26.30	26.70	26.47
PAPR (dB)	4.86	4.71	4.55
Measurement uncertainty (dB)	<±1.58		

Worst case AVERAGE POWER: Modulation QPSK. RB Size: 1. RB Offset: 49.  
 Worst case PAPR: Modulation QPSK. RB Size: 100. RB Offset: 0.

The results in the next tables shows the results for this configuration.

LTE Band 66. 16QAM MODULATION. Bandwidth = 20 MHz.

Channel	Low	Middle	High
Maximum declared antenna gain (dBi)	+3.5	+3.5	+3.5
Measured maximum average power (dBm) at antenna port	21.93	22.20	21.89
Maximum equivalent isotropically radiated power (E.I.R.P.) (dBm)	25.43	25.70	25.39
PAPR (dB)	(*)	(*)	(*)
Measurement uncertainty (dB)	<±1.58		

Worst case AVERAGE POWER: Modulation 16QAM. RB Size: 1. RB Offset: 0.  
 (\*):- Preliminary measurements determined that the modulation QPSK, RB Size: 100, RB Offset: 0 as the worst case.  
 - Not supported in the Middle Channel: RB Size: 50, RB Offset: 0; RB Size: 50, RB Offset: 24; RB Size: 50, RB Offset: 49; RB Size: 100, RB Offset: 0.

The results in the next tables shows the results for this configuration.

Verdict: PASS

## 2. PEAK-TO-AVERAGE POWER RATIO (PAPR):

LTE Band 12. Bandwidth = 1.4 MHz. Modulation 16QAM. RB Size: 6. RB Offset: 0.

Low Channel:

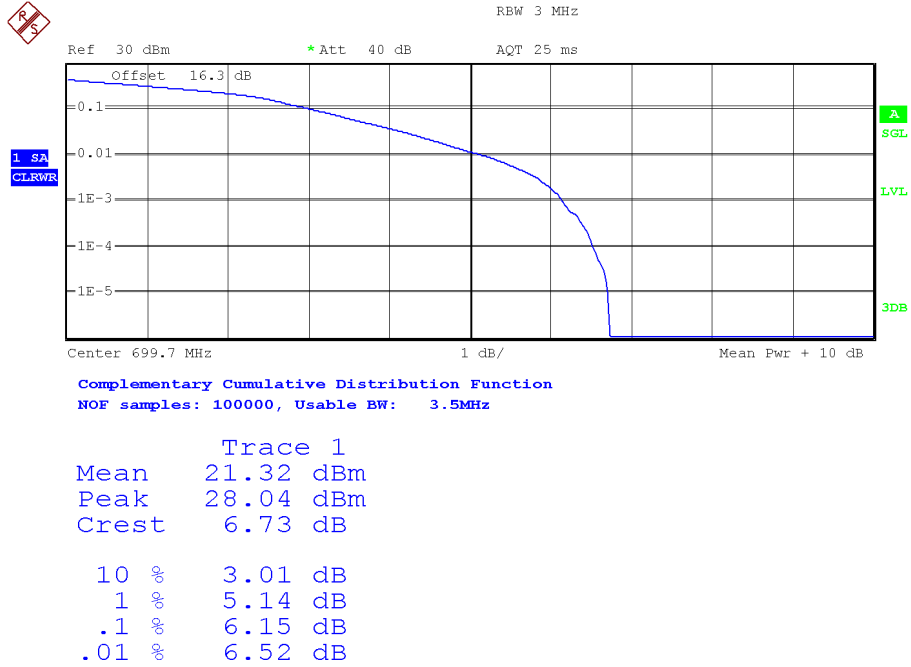

Middle Channel:

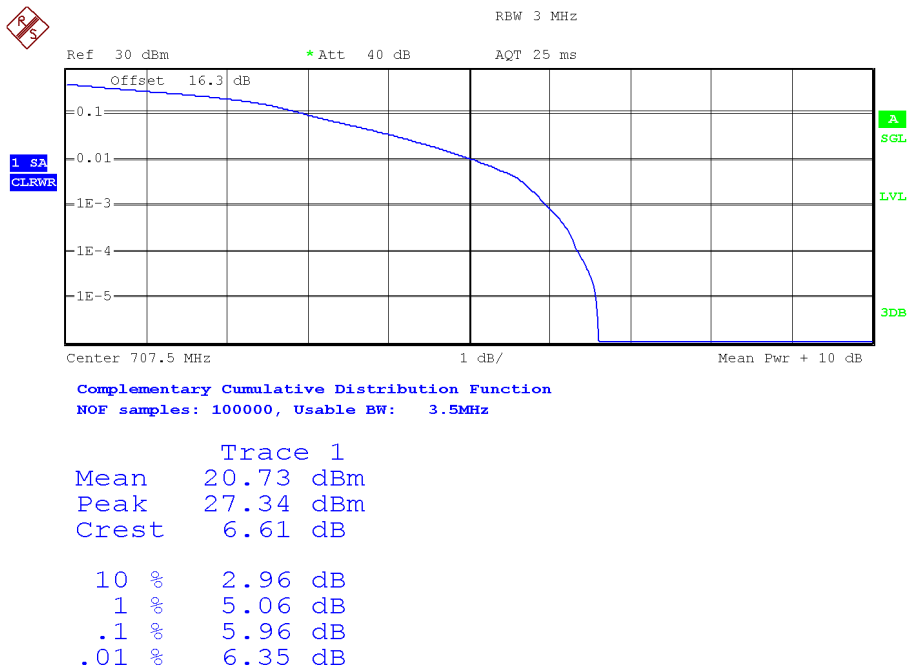

High Channel:

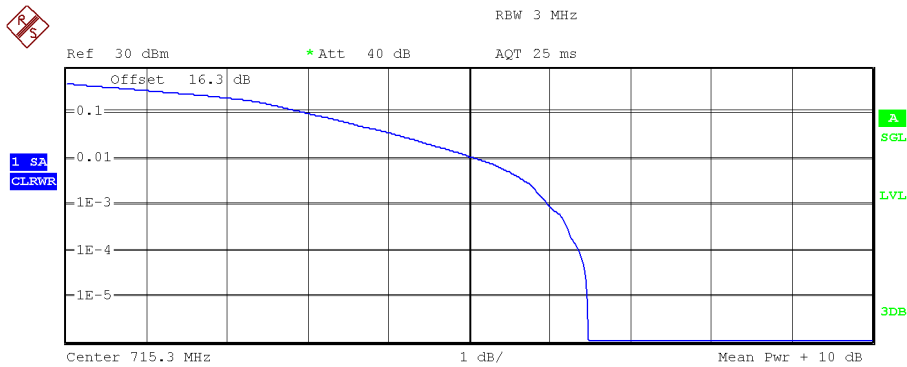

Complementary Cumulative Distribution Function  
 NOF samples: 100000, Usable BW: 3.5MHz

Trace 1	
Mean	21.35 dBm
Peak	27.82 dBm
Crest	6.47 dB
10 %	2.98 dB
1 %	5.11 dB
.1 %	5.98 dB
.01 %	6.36 dB

LTE Band 12.

Bandwidth = 3 MHz. Modulation 16QAM. RB Size: 15. RB Offset: 0.

Low Channel:

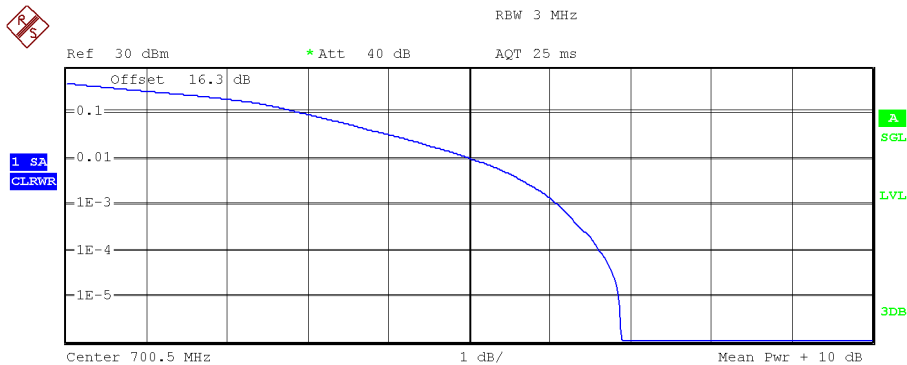

Complementary Cumulative Distribution Function  
 NOF samples: 100000, Usable BW: 3.5MHz

Trace 1	
Mean	21.23 dBm
Peak	28.11 dBm
Crest	6.89 dB
10 %	2.93 dB
1 %	5.03 dB
.1 %	6.11 dB
.01 %	6.62 dB

Middle Channel:

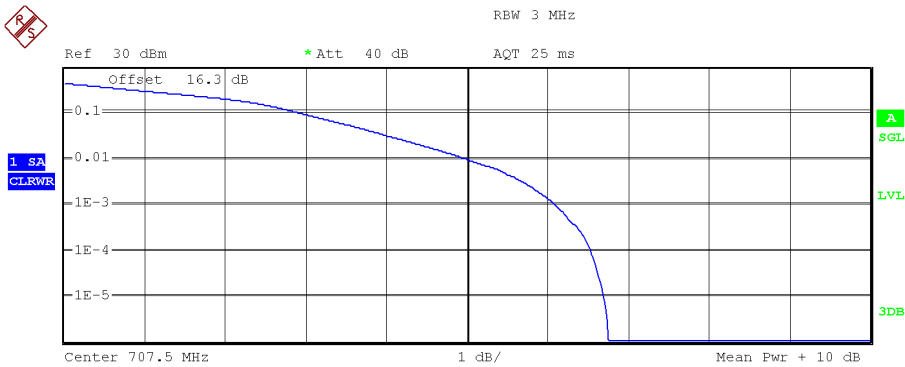

Complementary Cumulative Distribution Function  
 NOF samples: 100000, Usable BW: 3.5MHz

	Trace 1
Mean	20.65 dBm
Peak	27.41 dBm
Crest	6.76 dB
10 %	2.92 dB
1 %	4.98 dB
.1 %	6.09 dB
.01 %	6.54 dB

High Channel:

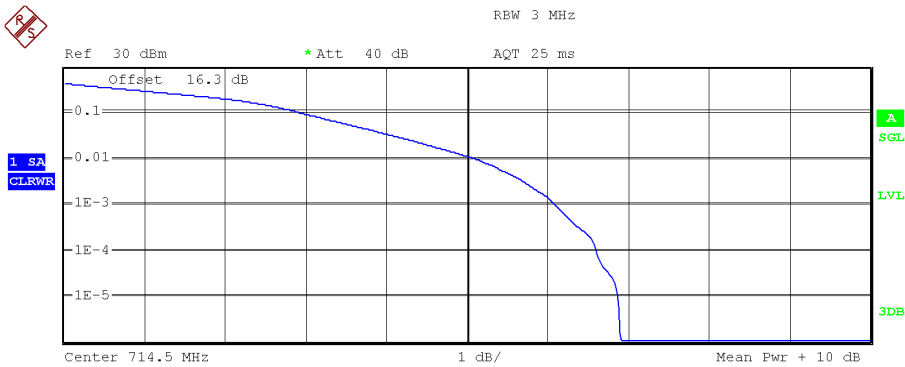

Complementary Cumulative Distribution Function  
 NOF samples: 100000, Usable BW: 3.5MHz

	Trace 1
Mean	21.28 dBm
Peak	28.18 dBm
Crest	6.90 dB
10 %	2.95 dB
1 %	5.11 dB
.1 %	6.09 dB
.01 %	6.60 dB



LTE Band 12.

Bandwidth = 5 MHz. Modulation 16QAM. RB Size: 25. RB Offset: 0.

Low Channel:

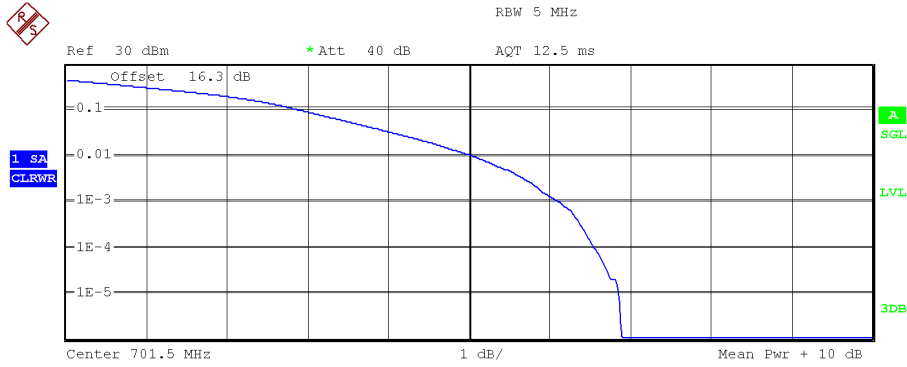

Center 701.5 MHz 1 dB/ Mean Pwr + 10 dB  
 Complementary Cumulative Distribution Function  
 NOF samples: 100000, Usable BW: 7.1MHz

Trace 1	
Mean	21.23 dBm
Peak	28.11 dBm
Crest	6.89 dB
10 %	2.90 dB
1 %	5.05 dB
.1 %	6.12 dB
.01 %	6.55 dB

Middle Channel:

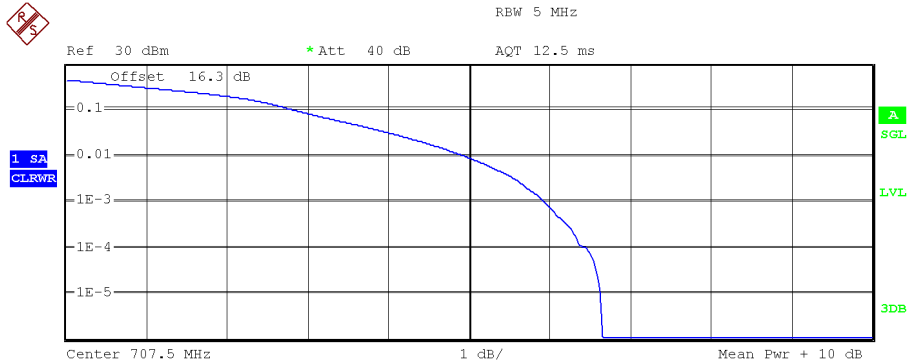

Center 707.5 MHz 1 dB/ Mean Pwr + 10 dB  
 Complementary Cumulative Distribution Function  
 NOF samples: 100000, Usable BW: 7.1MHz

Trace 1	
Mean	20.76 dBm
Peak	27.41 dBm
Crest	6.65 dB
10 %	2.84 dB
1 %	4.94 dB
.1 %	5.93 dB
.01 %	6.44 dB

High Channel:

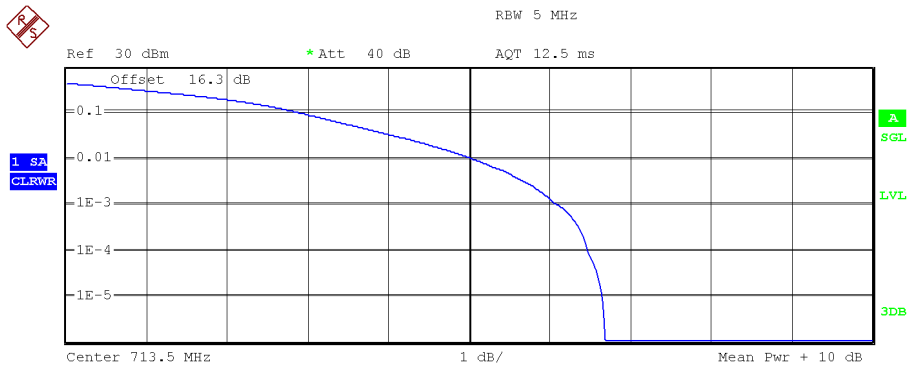

Complementary Cumulative Distribution Function  
 NOF samples: 100000, Usable BW: 7.1MHz

Trace 1	
Mean	21.28 dBm
Peak	27.97 dBm
Crest	6.68 dB
10 %	2.92 dB
1 %	5.05 dB
.1 %	6.09 dB
.01 %	6.47 dB

LTE Band 12.

Bandwidth = 10 MHz. Modulation 16QAM. RB Size: 25. RB Offset: 24.

Low Channel:

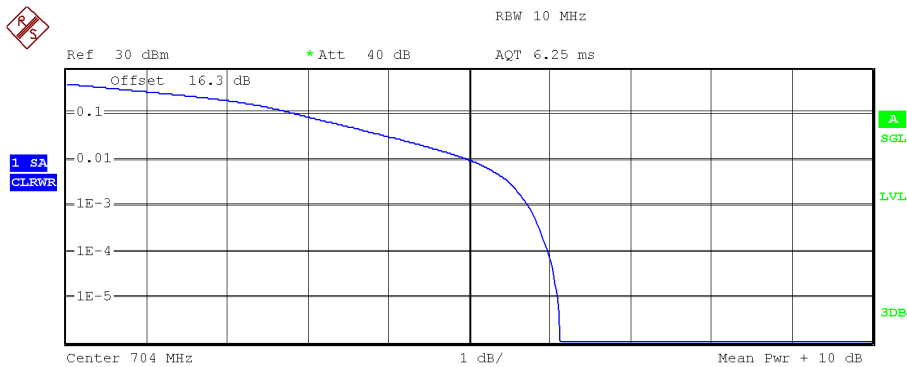

Complementary Cumulative Distribution Function  
 NOF samples: 100000, Usable BW: 11.2MHz

Trace 1	
Mean	20.98 dBm
Peak	27.11 dBm
Crest	6.13 dB
10 %	2.87 dB
1 %	5.00 dB
.1 %	5.74 dB
.01 %	5.98 dB

Middle Channel:

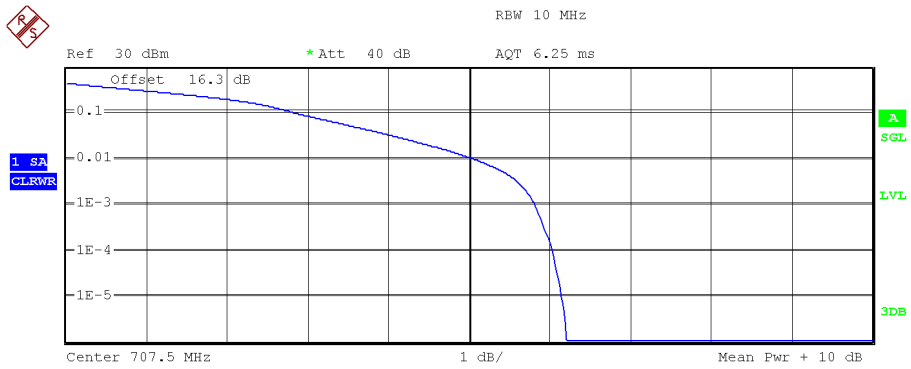

Complementary Cumulative Distribution Function  
 NOF samples: 100000, Usable BW: 11.2MHz

	Trace 1	
Mean	20.83	dBm
Peak	27.04	dBm
Crest	6.21	dB
10 %	2.85	dB
1 %	5.06	dB
.1 %	5.82	dB
.01 %	6.04	dB

High Channel:

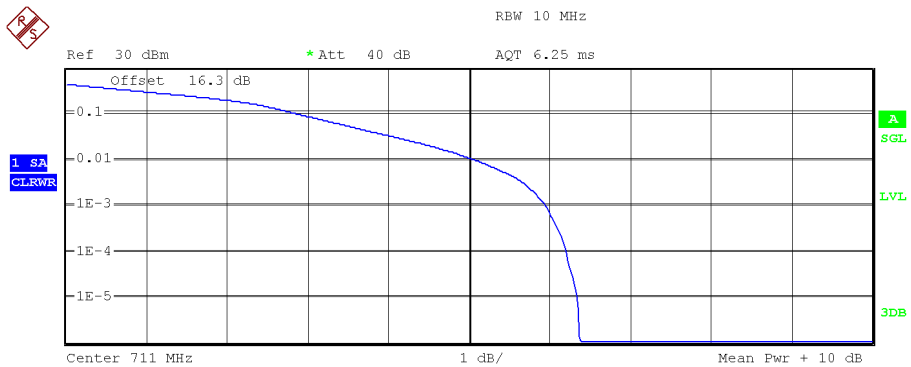

Complementary Cumulative Distribution Function  
 NOF samples: 100000, Usable BW: 11.2MHz

	Trace 1	
Mean	21.16	dBm
Peak	27.53	dBm
Crest	6.37	dB
10 %	2.88	dB
1 %	5.08	dB
.1 %	5.95	dB
.01 %	6.22	dB

LTE Band 66.

Bandwidth = 1.4 MHz. Modulation 16QAM. RB Size: 6. RB Offset: 0.

Low Channel:

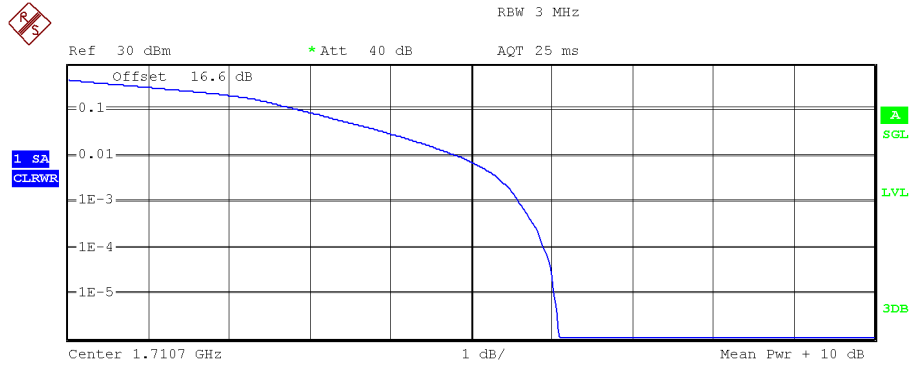

Complementary Cumulative Distribution Function  
 NOF samples: 100000, Usable BW: 3.5MHz

Trace 1	
Mean	21.29 dBm
Peak	27.38 dBm
Crest	6.09 dB
10 %	2.87 dB
1 %	4.84 dB
.1 %	5.59 dB
.01 %	5.90 dB

Middle Channel:

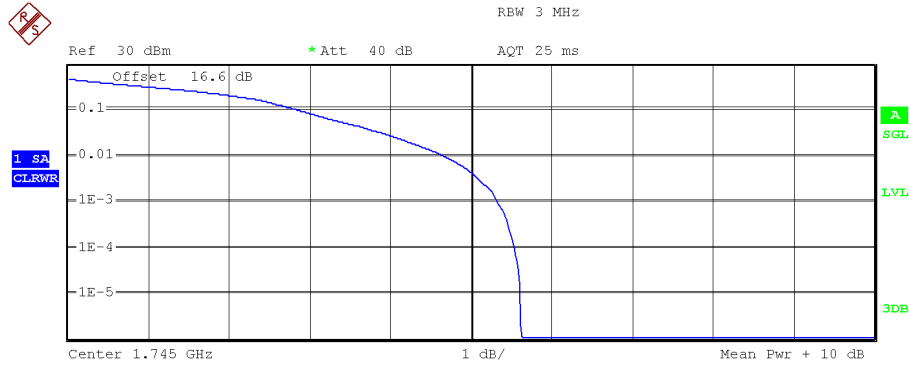

Complementary Cumulative Distribution Function  
 NOF samples: 100000, Usable BW: 3.5MHz

Trace 1	
Mean	21.12 dBm
Peak	26.74 dBm
Crest	5.62 dB
10 %	2.85 dB
1 %	4.65 dB
.1 %	5.34 dB
.01 %	5.54 dB

High Channel:

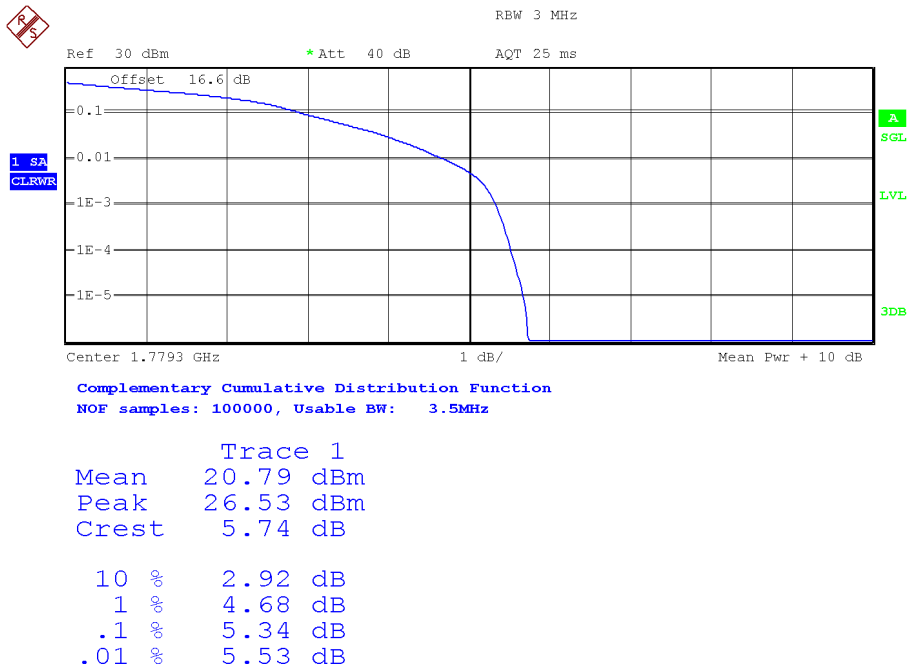

LTE Band 66.

Bandwidth = 3 MHz. Modulation 16QAM. RB Size: 15. RB Offset: 0.

Low Channel:

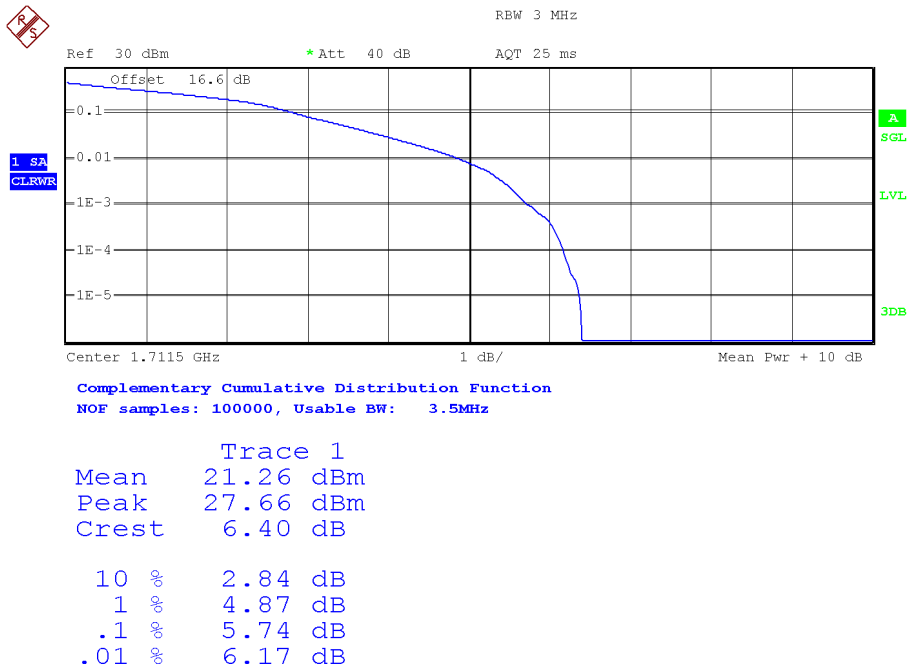

Middle Channel:

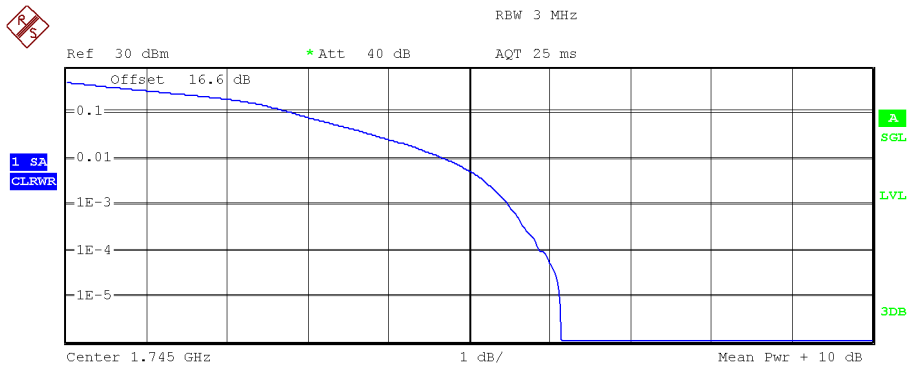

Center 1.745 GHz 1 dB/ Mean Pwr + 10 dB  
 Complementary Cumulative Distribution Function  
 NOF samples: 100000, Usable BW: 3.5MHz

Trace 1	
Mean	21.30 dBm
Peak	27.45 dBm
Crest	6.14 dB
10 %	2.82 dB
1 %	4.70 dB
.1 %	5.50 dB
.01 %	5.88 dB

High Channel:

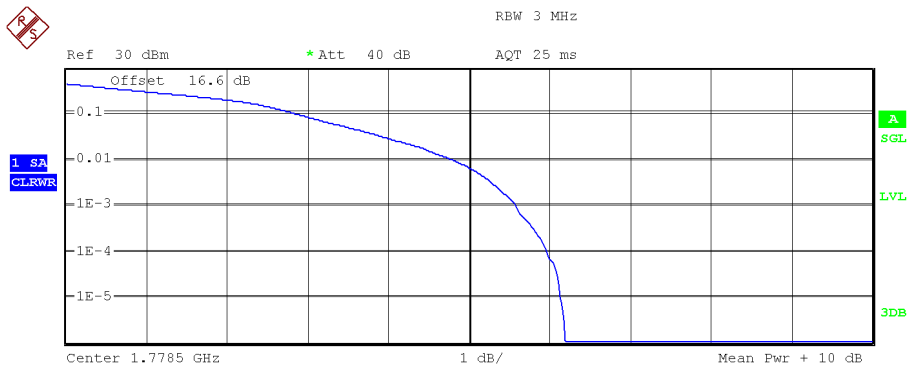

Center 1.7785 GHz 1 dB/ Mean Pwr + 10 dB  
 Complementary Cumulative Distribution Function  
 NOF samples: 100000, Usable BW: 3.5MHz

Trace 1	
Mean	20.76 dBm
Peak	26.95 dBm
Crest	6.20 dB
10 %	2.87 dB
1 %	4.79 dB
.1 %	5.58 dB
.01 %	5.96 dB

LTE Band 66.

Bandwidth = 5 MHz. Modulation 16QAM. RB Size: 25. RB Offset: 0.

Low Channel:

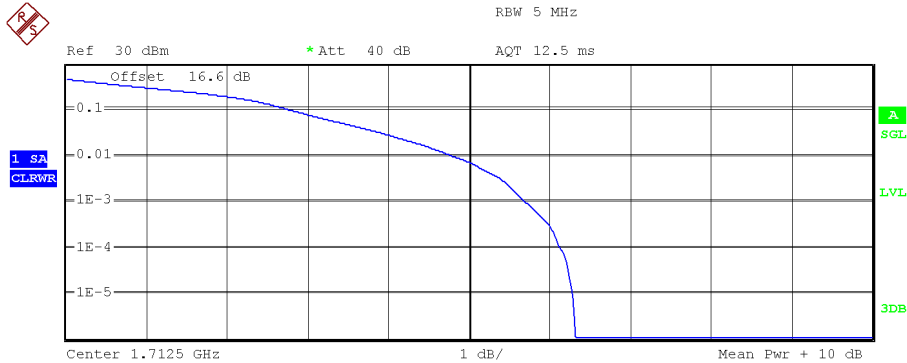

Complementary Cumulative Distribution Function  
 NOF samples: 100000, Usable BW: 7.1MHz

Trace 1	
Mean	21.27 dBm
Peak	27.59 dBm
Crest	6.32 dB
10 %	2.77 dB
1 %	4.79 dB
.1 %	5.69 dB
.01 %	6.14 dB

Middle Channel:

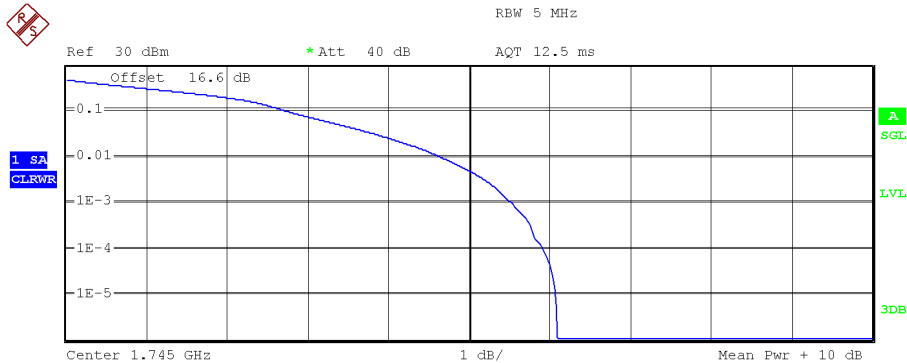

Complementary Cumulative Distribution Function  
 NOF samples: 100000, Usable BW: 7.1MHz

Trace 1	
Mean	21.00 dBm
Peak	27.09 dBm
Crest	6.09 dB
10 %	2.72 dB
1 %	4.63 dB
.1 %	5.53 dB
.01 %	5.91 dB

High Channel:

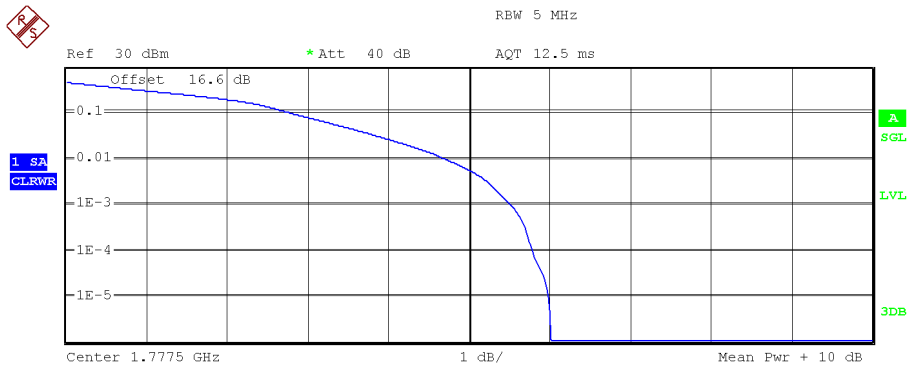

Complementary Cumulative Distribution Function  
 NOF samples: 100000, Usable BW: 7.1MHz

Trace 1	
Mean	20.87 dBm
Peak	26.88 dBm
Crest	6.02 dB
10 %	2.79 dB
1 %	4.70 dB
.1 %	5.51 dB
.01 %	5.80 dB

LTE Band 66.

Bandwidth = 10 MHz. Modulation 16QAM. RB Size: 25. RB Offset: 24.

Low Channel:

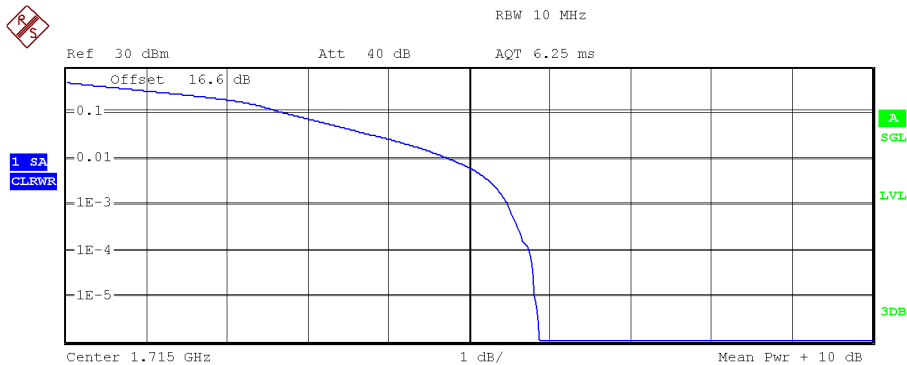

Complementary Cumulative Distribution Function  
 NOF samples: 100000, Usable BW: 11.2MHz

Trace 1	
Mean	21.45 dBm
Peak	27.32 dBm
Crest	5.88 dB
10 %	2.71 dB
1 %	4.76 dB
.1 %	5.48 dB
.01 %	5.75 dB



Middle Channel:

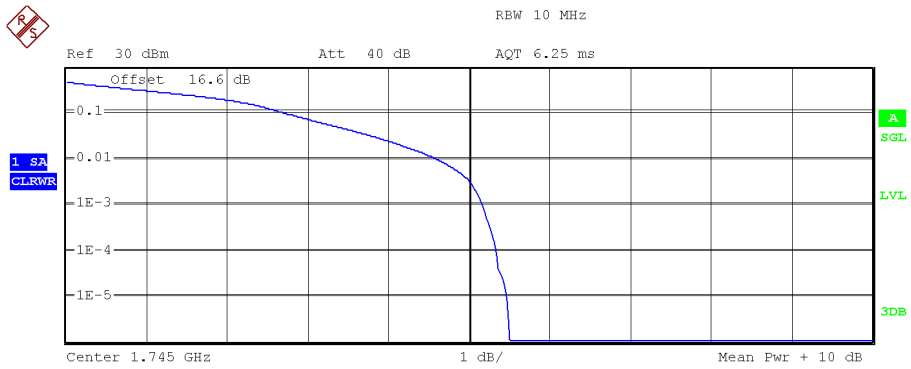

Complementary Cumulative Distribution Function  
 NOF samples: 100000, Usable BW: 11.2MHz

Trace 1	
Mean	21.39 dBm
Peak	26.89 dBm
Crest	5.50 dB
10 %	2.71 dB
1 %	4.60 dB
.1 %	5.18 dB
.01 %	5.34 dB

High Channel:

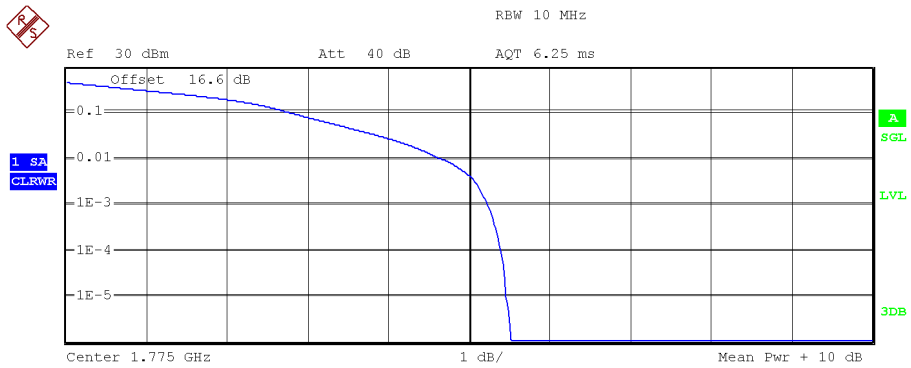

Complementary Cumulative Distribution Function  
 NOF samples: 100000, Usable BW: 11.2MHz

Trace 1	
Mean	21.07 dBm
Peak	26.60 dBm
Crest	5.52 dB
10 %	2.79 dB
1 %	4.66 dB
.1 %	5.24 dB
.01 %	5.40 dB

LTE Band 66.

Bandwidth = 15 MHz. Modulation 16QAM. RB Size: 1. RB Offset: 0.

Low Channel:

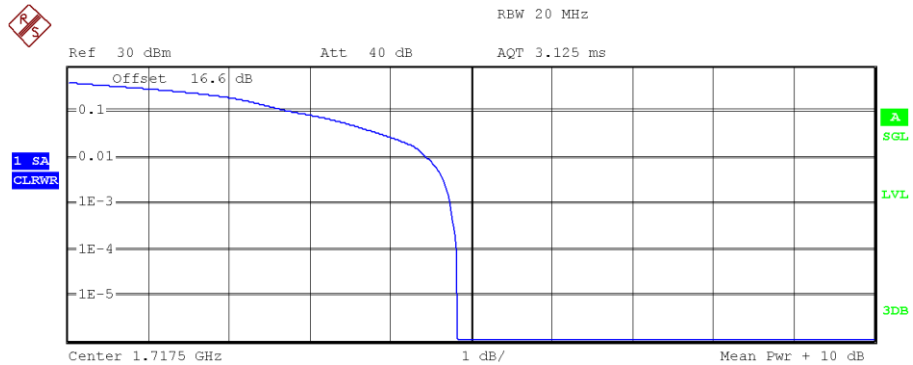

Complementary Cumulative Distribution Function  
 NOF samples: 100000, Usable BW: 23.7MHz

Trace 1	
Mean	22.68 dBm
Peak	27.51 dBm
Crest	4.83 dB
10 %	2.80 dB
1 %	4.46 dB
.1 %	4.74 dB
.01 %	4.82 dB

Middle Channel:

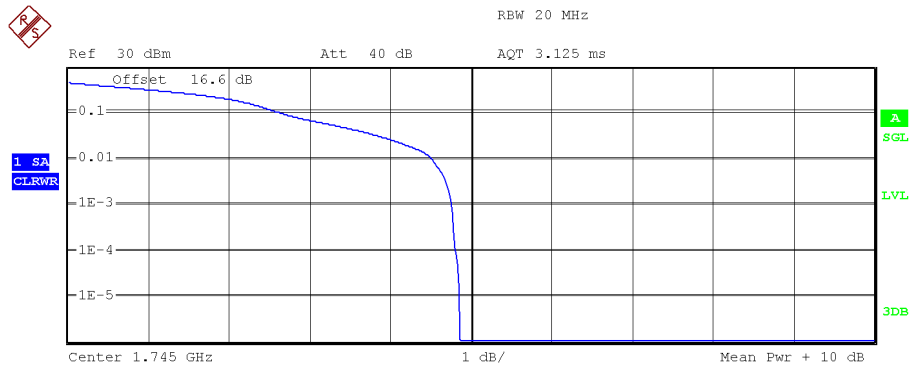

Complementary Cumulative Distribution Function  
 NOF samples: 100000, Usable BW: 23.7MHz

Trace 1	
Mean	21.37 dBm
Peak	26.23 dBm
Crest	4.86 dB
10 %	2.64 dB
1 %	4.50 dB
.1 %	4.76 dB
.01 %	4.81 dB

High Channel:

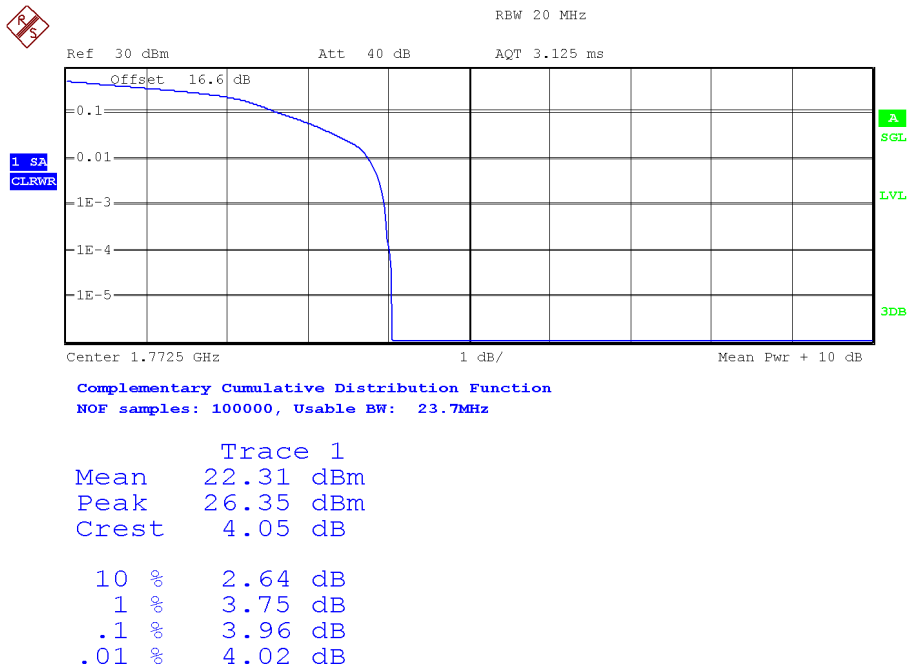

LTE Band 66.

Bandwidth = 20 MHz. Modulation QPSK. RB Size: 100. RB Offset: 0.

Low Channel:

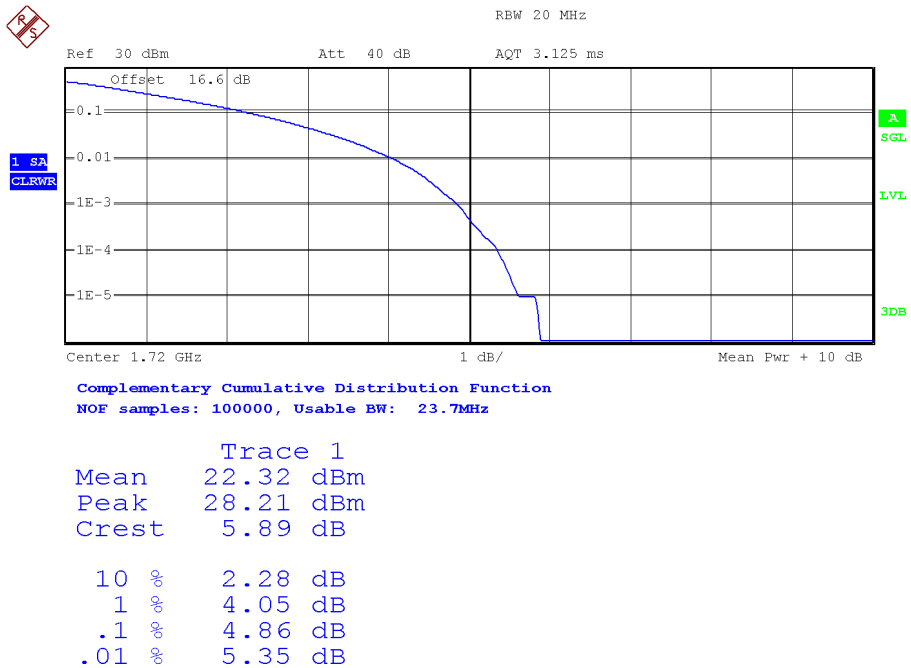

Middle Channel:

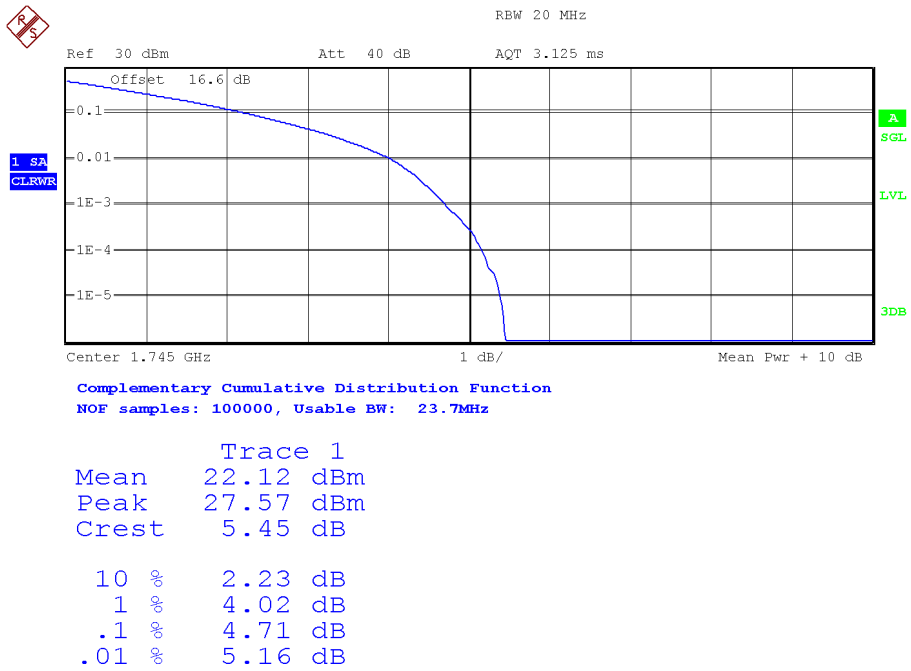

High Channel:

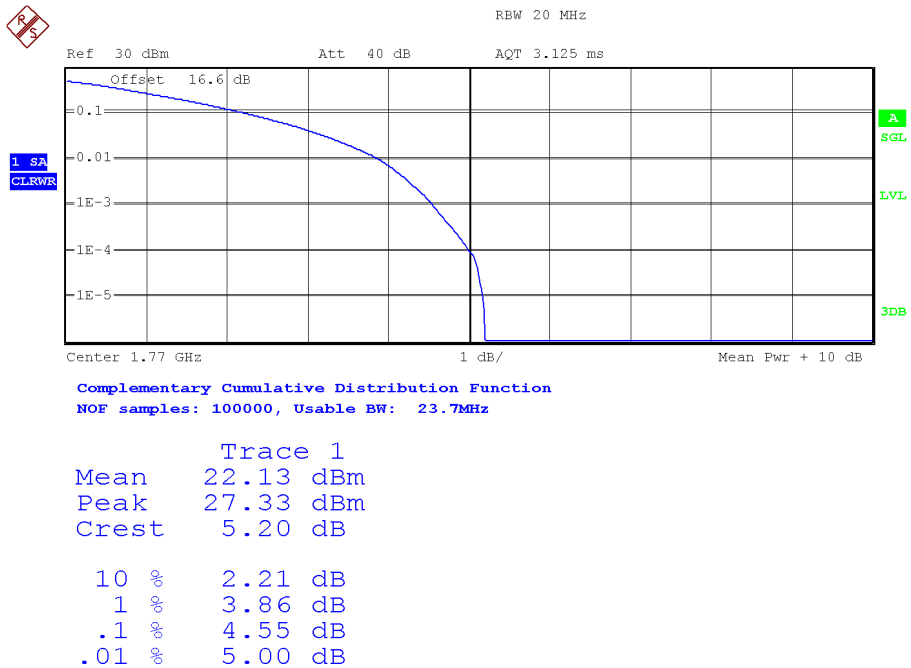

Verdict: PASS

## Modulation Characteristics

### SPECIFICATION:

FCC §2.1047: Measurements required: Modulation characteristics.

RSS-130 Clause 4.2: Equipment certified under this standard shall employ digital modulation.

RSS-139 Clause 6.2. : Modulation characteristics.

### METHOD:

For LTE the EUT operates with QPSK and 16QAM modulation modes in which the information is digitised and coded into a bit stream. The RF transmission is multiplexed using *Orthogonal Frequency Division Multiplexing (OFDM)* using different possible arrangement of subcarriers (Resource Blocks RB).

### TEST SETUP:

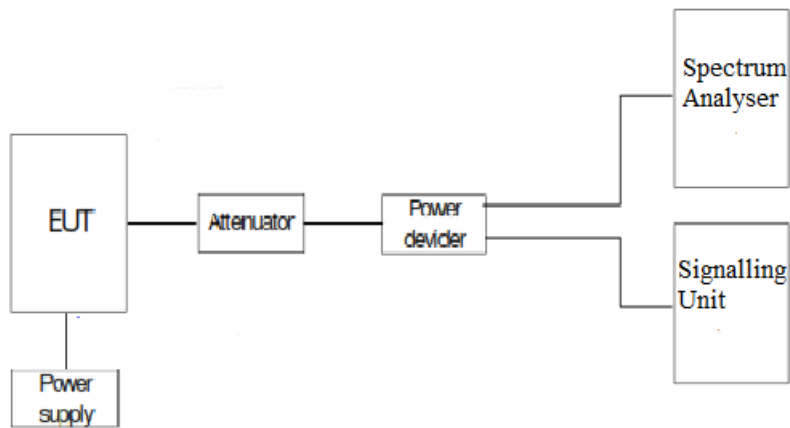

**RESULTS:**

The following plots show the modulation schemes in the EUT.

**LTE Band 12. QPSK MODULATION. BW = 10 MHz.**

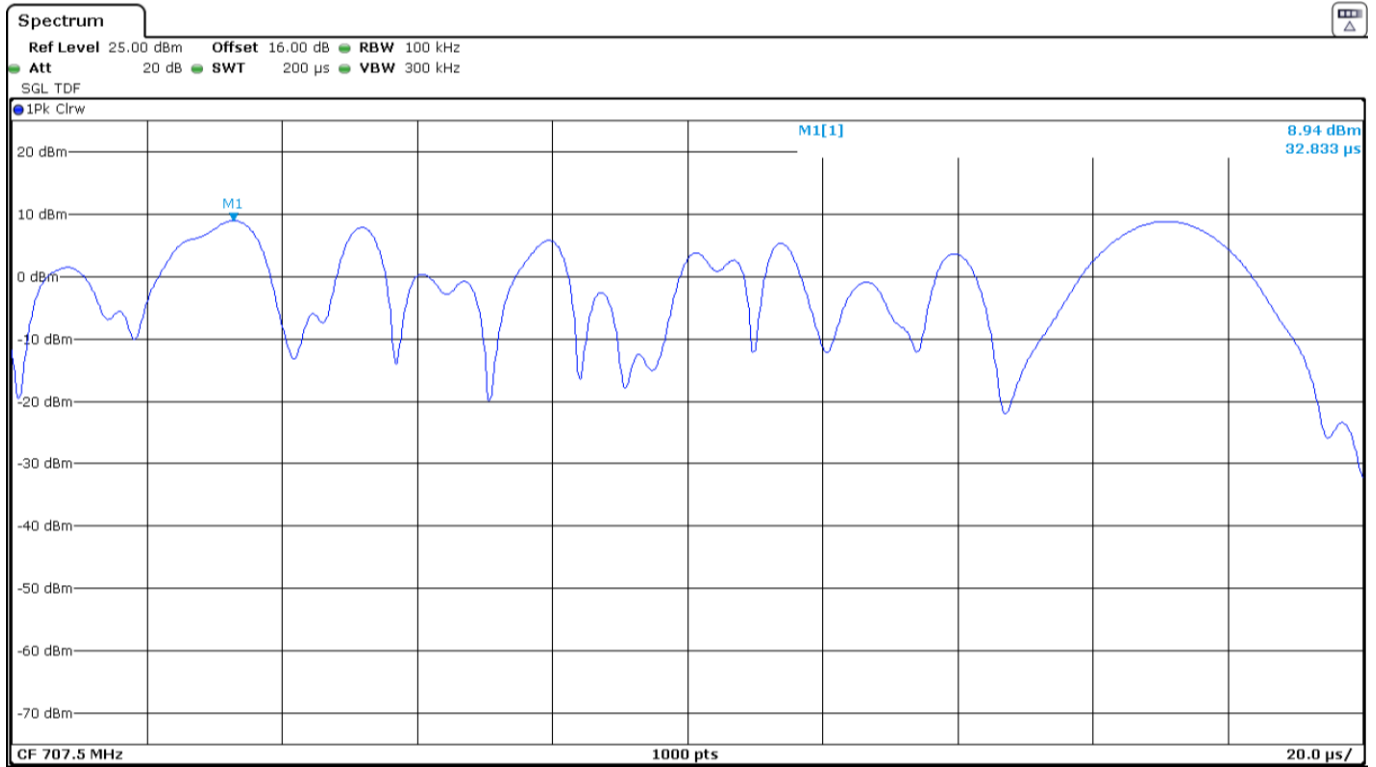

**LTE Band 12. 16QAM MODULATION. BW = 10 MHz.**

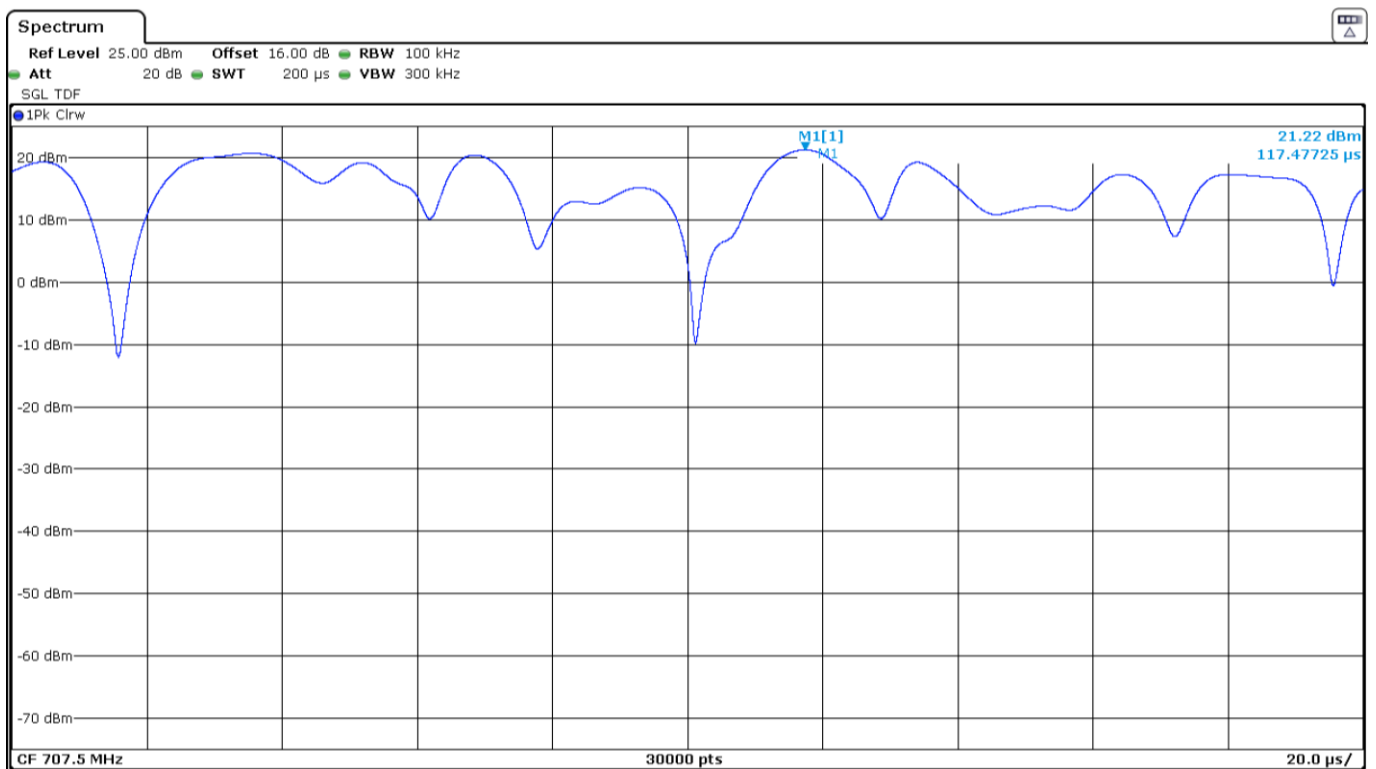

LTE Band 66. QPSK MODULATION. BW = 10 MHz.

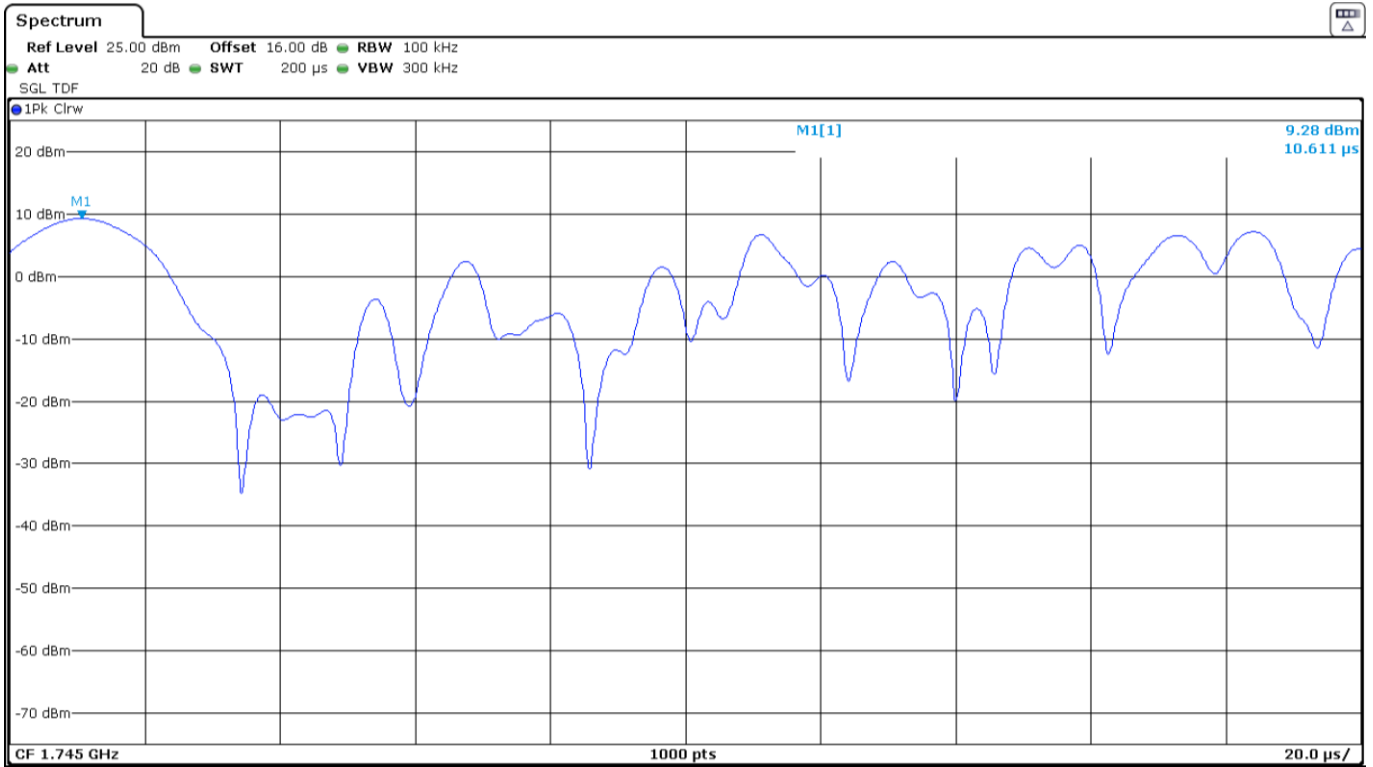

LTE Band 66. 16QAM MODULATION. BW = 10 MHz.

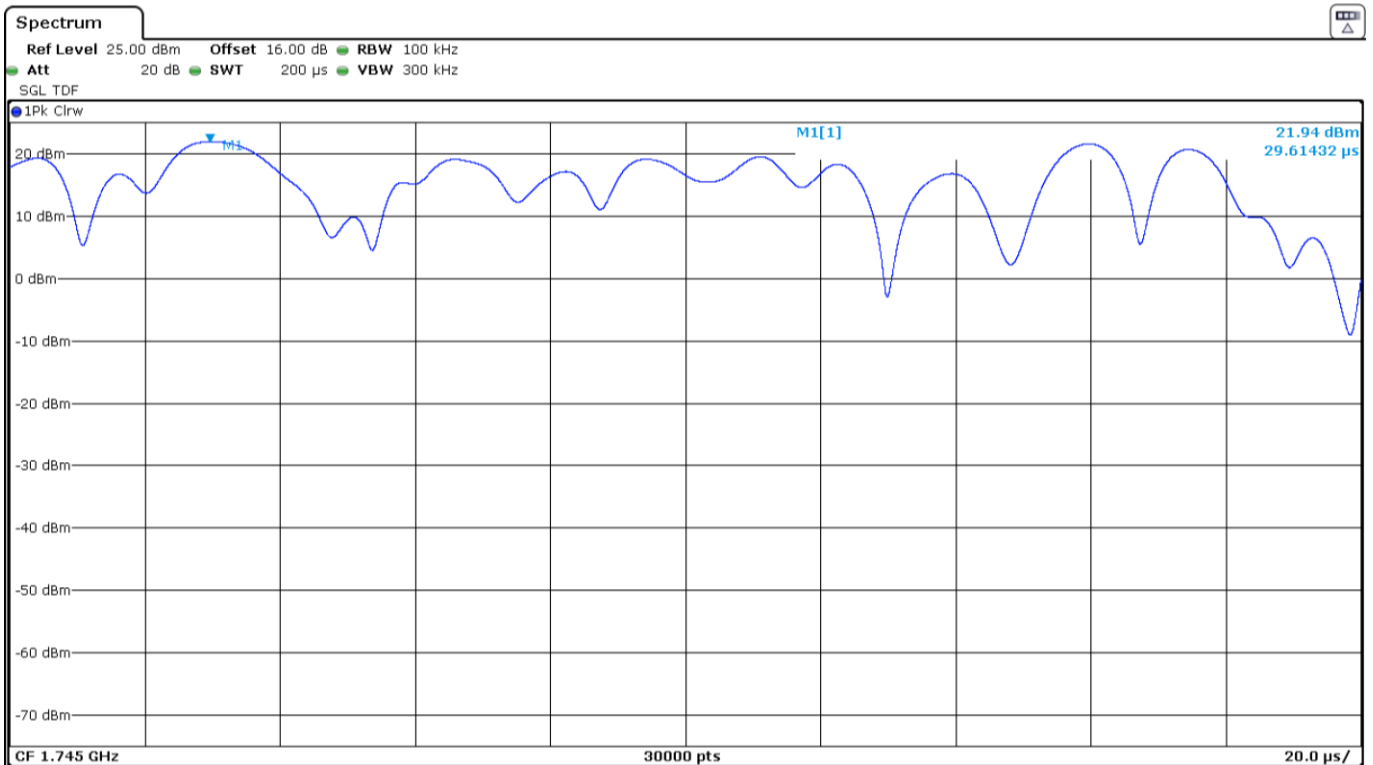

## Frequency Stability

### SPECIFICATION:

#### FCC §27.54 & §2.1055:

The frequency stability shall be sufficient to ensure that the fundamental emissions stay within the authorized bands of operation.

#### RSS-130 Clause 4.5:

For equipment that is capable of transmitting numerous channels simultaneously for different applications (e.g. LTE and narrowband – Internet of Things (IoT)), the occupied bandwidth shall be the bandwidth representing the sum of the occupied bandwidths of these channels.

The frequency stability shall be sufficient to ensure that the occupied bandwidth remains within each operating frequency block range when tested at the temperature and supply voltage variations specified in RSS-Gen.

#### RSS-139 Clause 6.4:

The frequency stability shall be sufficient to ensure that the occupied bandwidth stays within the operating frequency block when tested to the temperature and supply voltage variations specified in RSS-Gen.

### METHOD:

The frequency tolerance measurements over temperature variations were made over the temperature range of  $-30^{\circ}\text{C}$  to  $+50^{\circ}\text{C}$ . The EUT was placed inside a climatic chamber and the temperature was raised hourly in  $10^{\circ}\text{C}$  steps from  $-30^{\circ}\text{C}$  up to  $+50^{\circ}\text{C}$ .

The supply voltage was varied between 85% and 115% of nominal voltage.

The EUT was set in “Radio Resource Control (RRC) mode” in the middle channel using the Universal Radio Communication tester R&S CMW500 and the maximum frequency error was measured using the built-in calibrated frequency meter.

The worst case LTE mode for conducted power was used for the test.

In order to check that the frequency stability is sufficient such that the fundamental emissions stay within the authorized bands of operation, a reference point is established at the applicable unwanted emissions limit using a RBW equal to the RBW required by the unwanted emissions specification of the applicable regulatory standard. These reference points measured using the Low and High Channel of operation are identified as fL and fH respectively. The worst-case frequency offset determined in the above methods is added or subtracted from the values of fL and fH to check that the resulting frequencies remain within the band.

The reference point measurements were made at the RF output terminals of the EUT using an attenuator, power splitter and spectrum analyser. The EUT was controlled via the Universal Radio Communication tester R&S CMW500 selecting maximum transmission power of the EUT and different modes of modulation.



TEST SETUP:

1. Frequency Tolerance:

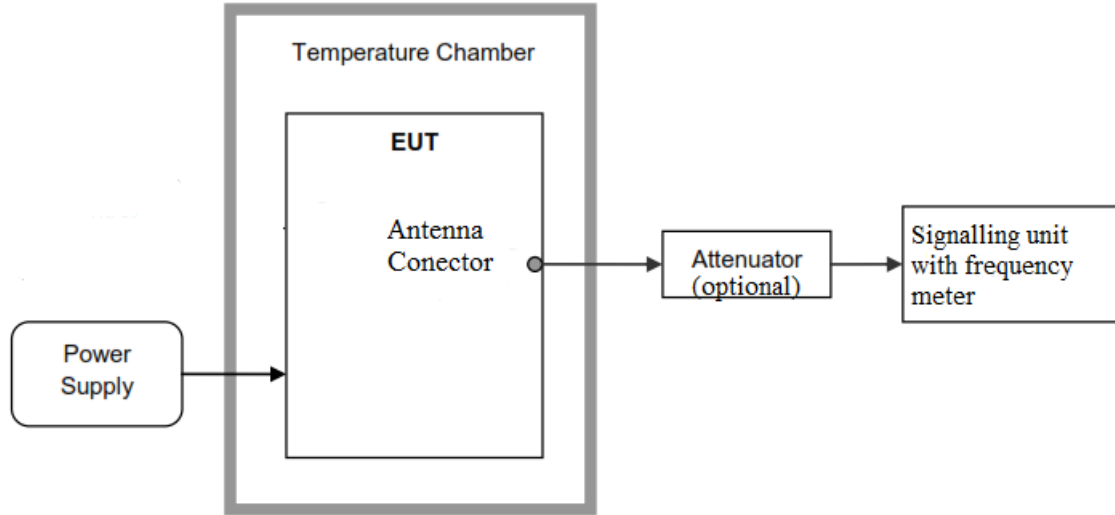

2. Reference Frequency Points  $f_L$  and  $f_H$ :

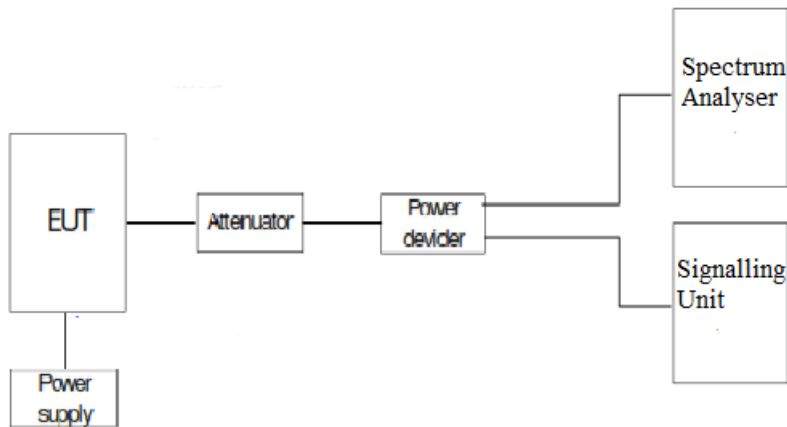

**RESULTS:**

**1. FREQUENCY TOLERANCE:**

• **Frequency Stability over Temperature Variations:**

LTE Band 12. QPSK MODULATION. BW = 10 MHz.

Temperature (°C)	Frequency Error (Hz)	Frequency Error (ppm)
+50	-0.37	-0.000522968
+40	0.23	0.000325088
+30	0.01	1.41343E-05
+20	-0.11	-0.000155477
+10	1.17	0.00165371
0	1.14	0.001611307
-10	0.97	0.001371025
-20	1.10	0.00155477
-30	0.06	8.48057E-05

LTE Band 66. QPSK MODULATION. BW = 10 MHz.

Temperature (°C)	Frequency Error (Hz)	Frequency Error (ppm)
+50	-2.63	-0.001507163
+40	-2.86	-0.001638968
+30	-3.42	-0.001959885
+20	-3.19	-0.00182808
+10	-1.19	-0.000681948
0	-0.60	-0.00034384
-10	-3.05	-0.001747851
-20	-3.18	-0.00182235
-30	-1.95	-0.001117479

• **Frequency Stability over Voltage Variations.**

LTE Band 12. QPSK MODULATION. BW = 10 MHz.

Battery Supply voltage	Voltage (V)	Frequency Error (Hz)	Frequency Error (ppm)
Vmax	4.37	-0.43	-0.000607774
Vmin(*)	3.23	0.74	0.001045936

(\*): Operating end point specified by the manufacturer.

LTE Band 66. QPSK MODULATION. BW = 10 MHz.

Battery Supply voltage	Voltage (V)	Frequency Error (Hz)	Frequency Error (ppm)
Vmax	4.37	-2.90	-0.001661891
Vmin(*)	3.23	-3.45	-0.001977077

(\*): Operating end point specified by the manufacturer.

## 2. REFERENCE FREQUENCY POINTS $f_L$ AND $f_H$ :

The worst-case frequency offsets added or subtracted per band and bandwidth:

### LTE Band 12:

	LTE QPSK MODULATION. BW = 10 MHz
$f_L$ (MHz)	699.2390
$f_H$ (MHz)	715.7750

### LTE Band 66:

	LTE QPSK MODULATION. BW = 10 MHz
$f_L$ (MHz)	1710.1454
$f_H$ (MHz)	1779.8586

The reference frequency points  $f_L$  and  $f_H$  stay within the authorized blocks for all the bands above.

Verdict: PASS

## Occupied Bandwidth

### SPECIFICATION:

FCC §2.1049: Measurements required: Occupied bandwidth.

RSS-Gen Clause 6.7: Occupied bandwidth (or 99% emission bandwidth) and x dB bandwidth.

### METHOD:

The occupied bandwidth measurement was performed at the output terminals of the EUT using an attenuator, power splitter and spectrum analyser. The EUT was controlled via the Universal Radio Communication tester R&S CMW500 selecting maximum transmission power of the EUT and different modes of modulation. The 99% occupied bandwidth and the -26 dBc bandwidth were measured directly using the built-in bandwidth measuring option of spectrum analyser.

### TEST SETUP:

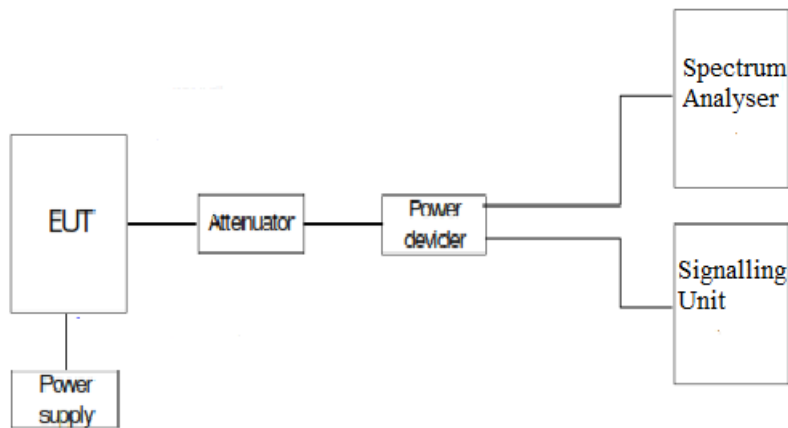

**RESULTS:**

**LTE Band:** The worst case of Occupied Bandwidth corresponds to all Resource Blocks (RB) with Offset 0, regardless the nominal bandwidth selected.

**LTE Band 12:**

LTE Band 12. QPSK MODULATION. BW = 1.4 MHz.

	Low Channel	Middle Channel	High Channel
99% Occupied bandwidth (kHz)	1.109	1.092	1.102
-26 dBc bandwidth (kHz)	1.321	1.301	1.326
Measurement uncertainty (kHz)	<±4.05		

LTE Band 12. 16QAM MODULATION. BW = 1.4 MHz.

	Low Channel	Middle Channel	High Channel
99% Occupied bandwidth (kHz)	1.095	1.093	1.107
-26 dBc bandwidth (kHz)	1.309	1.305	1.318
Measurement uncertainty (kHz)	<±4.05		

LTE Band 12. QPSK MODULATION. BW = 3 MHz.

	Low Channel	Middle Channel	High Channel
99% Occupied bandwidth (kHz)	2.744	2.742	2.728
-26 dBc bandwidth (kHz)	3.085	3.071	3.056
Measurement uncertainty (kHz)	<±12.71		

LTE Band 12. 16QAM MODULATION. BW = 3 MHz.

	Low Channel	Middle Channel	High Channel
99% Occupied bandwidth (kHz)	2.734	2.740	2.738
-26 dBc bandwidth (kHz)	3.059	3.063	3.062
Measurement uncertainty (kHz)	<±12.71		

LTE Band 12. QPSK MODULATION. BW = 5 MHz.

	Low Channel	Middle Channel	High Channel
99% Occupied bandwidth (kHz)	4.500	4.547	4.493
-26 dBc bandwidth (kHz)	4.993	5.077	5.014
Measurement uncertainty (kHz)	<±13.48		

LTE Band 12. 16QAM MODULATION. BW = 5 MHz.

	Low Channel	Middle Channel	High Channel
99% Occupied bandwidth (kHz)	4.500	4.510	4.490
-26 dBc bandwidth (kHz)	5.013	5.064	4.990
Measurement uncertainty (kHz)	<±13.48		

LTE Band 12. QPSK MODULATION. BW = 10 MHz.

	Low Channel	Middle Channel	High Channel
99% Occupied bandwidth (kHz)	8.960	9.040	9.053
-26 dBc bandwidth (kHz)	10.075	10.041	10.154
Measurement uncertainty (kHz)	<±15.40		

LTE Band 12. 16QAM MODULATION. BW = 10 MHz.

	Low Channel	Middle Channel	High Channel
99% Occupied bandwidth (kHz)	4.513	4.527	4.527
-26 dBc bandwidth (kHz)	5.246	5.293	5.223
Measurement uncertainty (kHz)	<±15.40		

LTE Band 66:

LTE Band 66. QPSK MODULATION. BW = 1.4 MHz.

	Low Channel	Middle Channel	High Channel
99% Occupied bandwidth (MHz)	1.097	1.101	1.090
-26 dBc bandwidth (MHz)	1.300	1.383	1.306
Measurement uncertainty (kHz)	<±4.05		

LTE Band 66. 16QAM MODULATION. BW = 1.4 MHz.

	Low Channel	Middle Channel	High Channel
99% Occupied bandwidth (MHz)	1.106	1.096	1.094
-26 dBc bandwidth (MHz)	1.323	1.315	1.309
Measurement uncertainty (kHz)	<±4.05		

LTE Band 66. QPSK MODULATION. BW = 3 MHz.

	Low Channel	Middle Channel	High Channel
99% Occupied bandwidth (MHz)	2.740	2.744	2.746
-26 dBc bandwidth (MHz)	3.073	3.088	3.093
Measurement uncertainty (kHz)	<±12.71		

LTE Band 66. 16QAM MODULATION. BW = 3 MHz.

	Low Channel	Middle Channel	High Channel
99% Occupied bandwidth (MHz)	2.736	2.746	2.728
-26 dBc bandwidth (MHz)	3.069	3.070	3.069
Measurement uncertainty (kHz)	<±12.71		

LTE Band 66. QPSK MODULATION. BW = 5 MHz.

	Low Channel	Middle Channel	High Channel
99% Occupied bandwidth (MHz)	4.537	4.513	4.500
-26 dBc bandwidth (MHz)	5.091	5.015	5.027
Measurement uncertainty (kHz)	<±13.48		

LTE Band 66. 16QAM MODULATION. BW = 5 MHz.

	Low Channel	Middle Channel	High Channel
99% Occupied bandwidth (MHz)	4.513	4.510	4.500
-26 dBc bandwidth (MHz)	5.061	5.038	5.004
Measurement uncertainty (kHz)	<±13.48		

LTE Band 66. QPSK MODULATION. BW = 10 MHz.

	Low Channel	Middle Channel	High Channel
99% Occupied bandwidth (MHz)	9.027	9.027	9.040
-26 dBc bandwidth (MHz)	10.219	10.199	10.069
Measurement uncertainty (kHz)	<±15.40		

LTE Band 66. 16QAM MODULATION. BW = 10 MHz.

	Low Channel	Middle Channel	High Channel
99% Occupied bandwidth (MHz)	4,540	4,533	4,527
-26 dBc bandwidth (MHz)	5,303	5,274	5,357
Measurement uncertainty (kHz)	<±15.40		

LTE Band 66. QPSK MODULATION. BW = 15 MHz.

	Low Channel	Middle Channel	High Channel
99% Occupied bandwidth (MHz)	13.430	13.460	13.460
-26 dBc bandwidth (MHz)	14.681	14.806	14.868
Measurement uncertainty (kHz)	<±17.34		

LTE Band 66. 16QAM MODULATION. BW = 15 MHz.

	Low Channel	Middle Channel	High Channel
99% Occupied bandwidth (MHz)	4,520	4,530	4,530
-26 dBc bandwidth (MHz)	5,236	5,277	5,461
Measurement uncertainty (kHz)	<±17.34		

LTE Band 66. QPSK MODULATION. BW = 20 MHz.

	Low Channel	Middle Channel	High Channel
99% Occupied bandwidth (MHz)	17.867	17.880	17.867
-26 dBc bandwidth (MHz)	19.448	19.351	19.475
Measurement uncertainty (kHz)	<±19.26		

LTE Band 66. 16QAM MODULATION. BW = 20 MHz.

	Low Channel	Middle Channel	High Channel
99% Occupied bandwidth (MHz)	4,573	4,573	4,573
-26 dBc bandwidth (MHz)	5,505	5,532	5,657
Measurement uncertainty (kHz)	<±19.26		



LTE Band 12. QPSK MODULATION. BW = 1.4 MHz.

Low Channel:

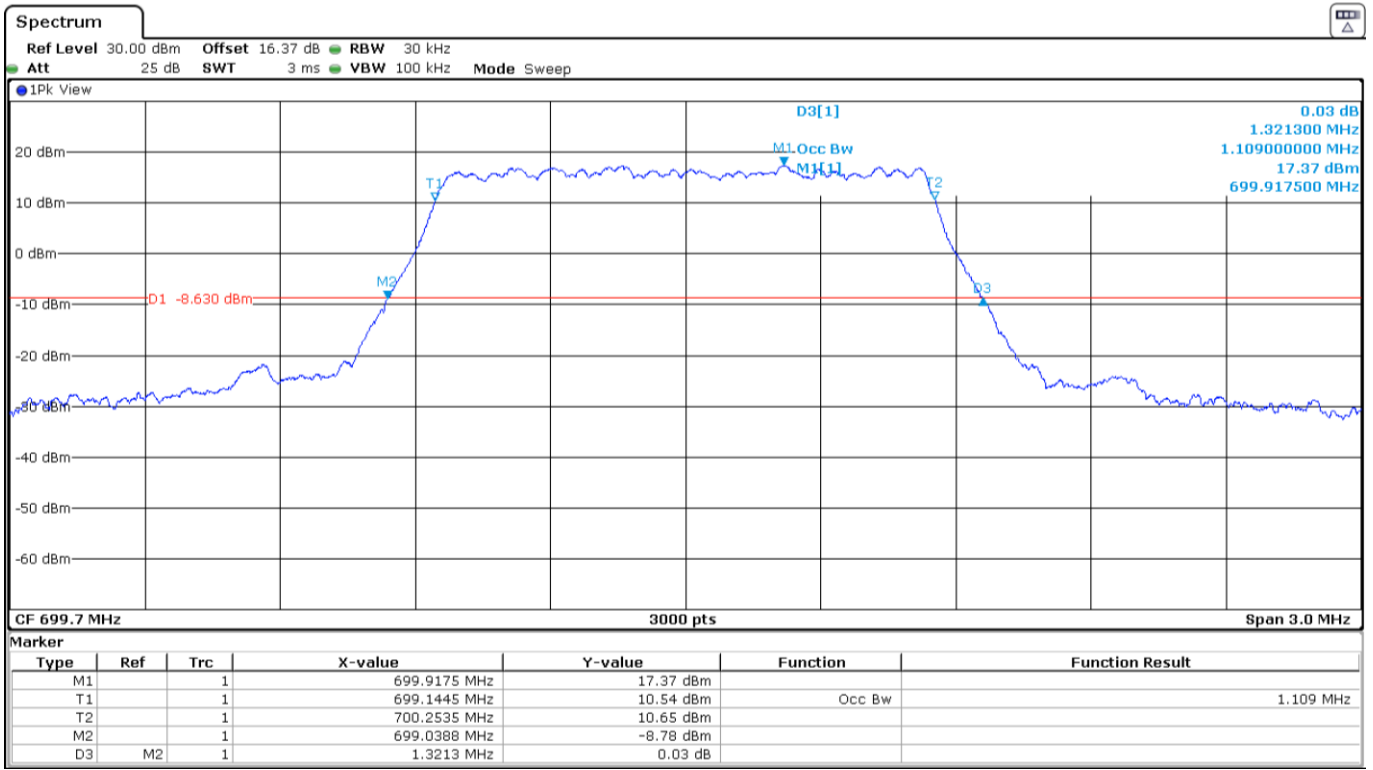

Middle Channel:

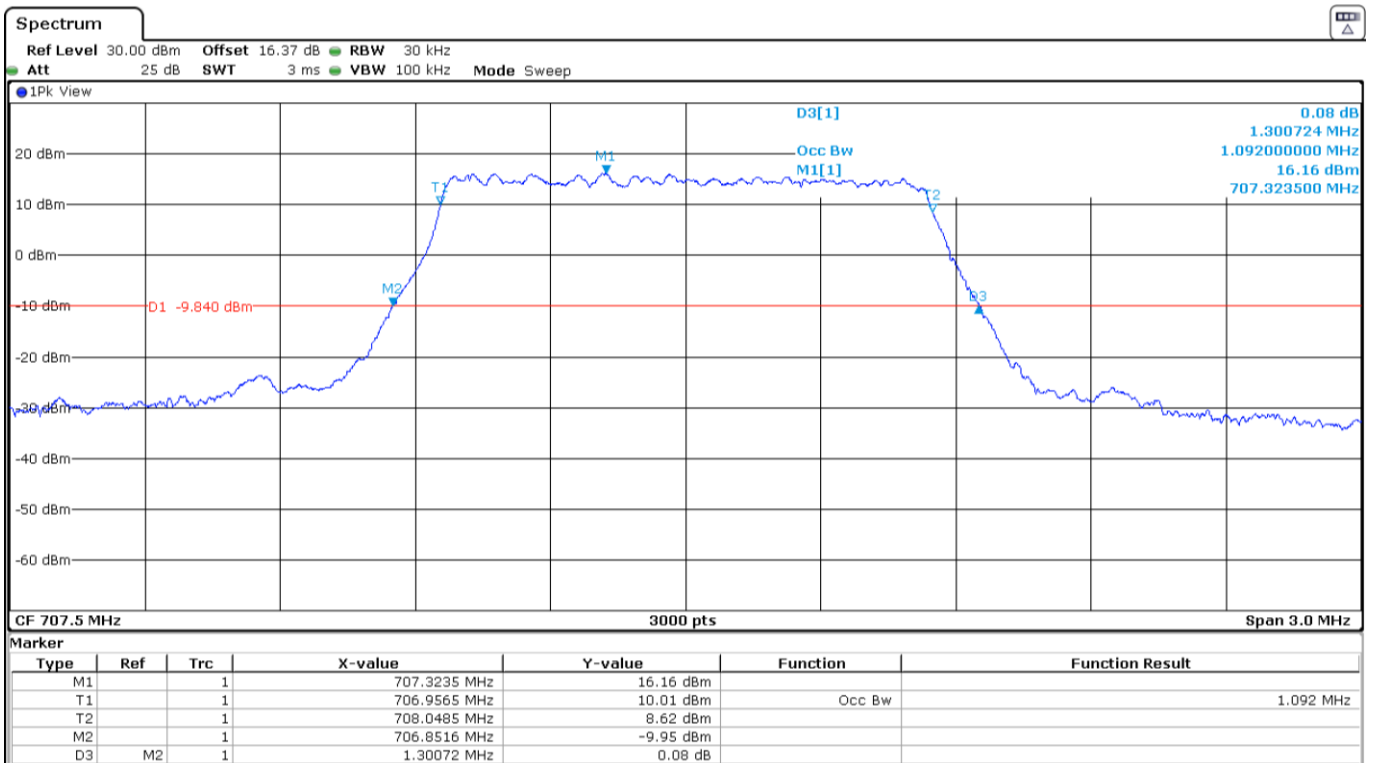

High Channel:

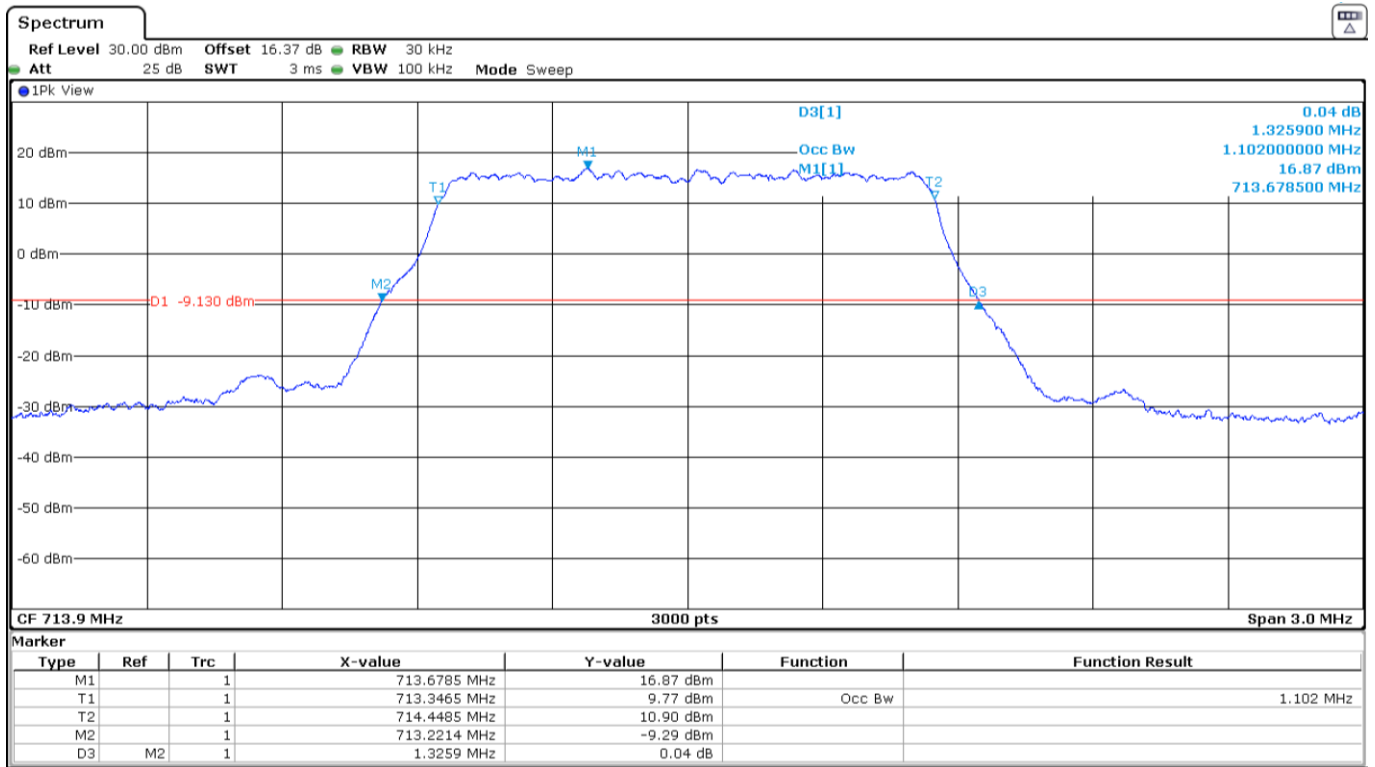

LTE Band 12. 16QAM MODULATION. BW = 1.4 MHz.

Low Channel:

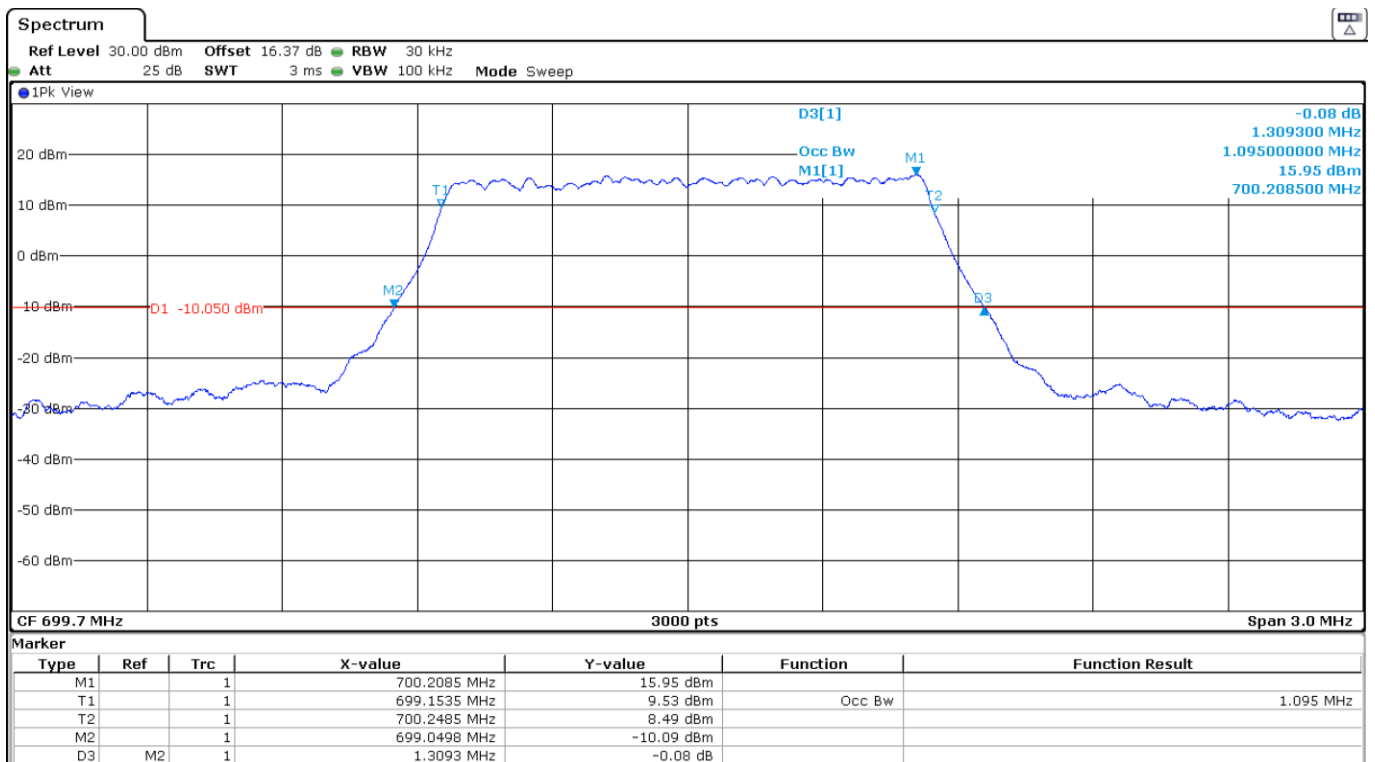

Middle Channel:

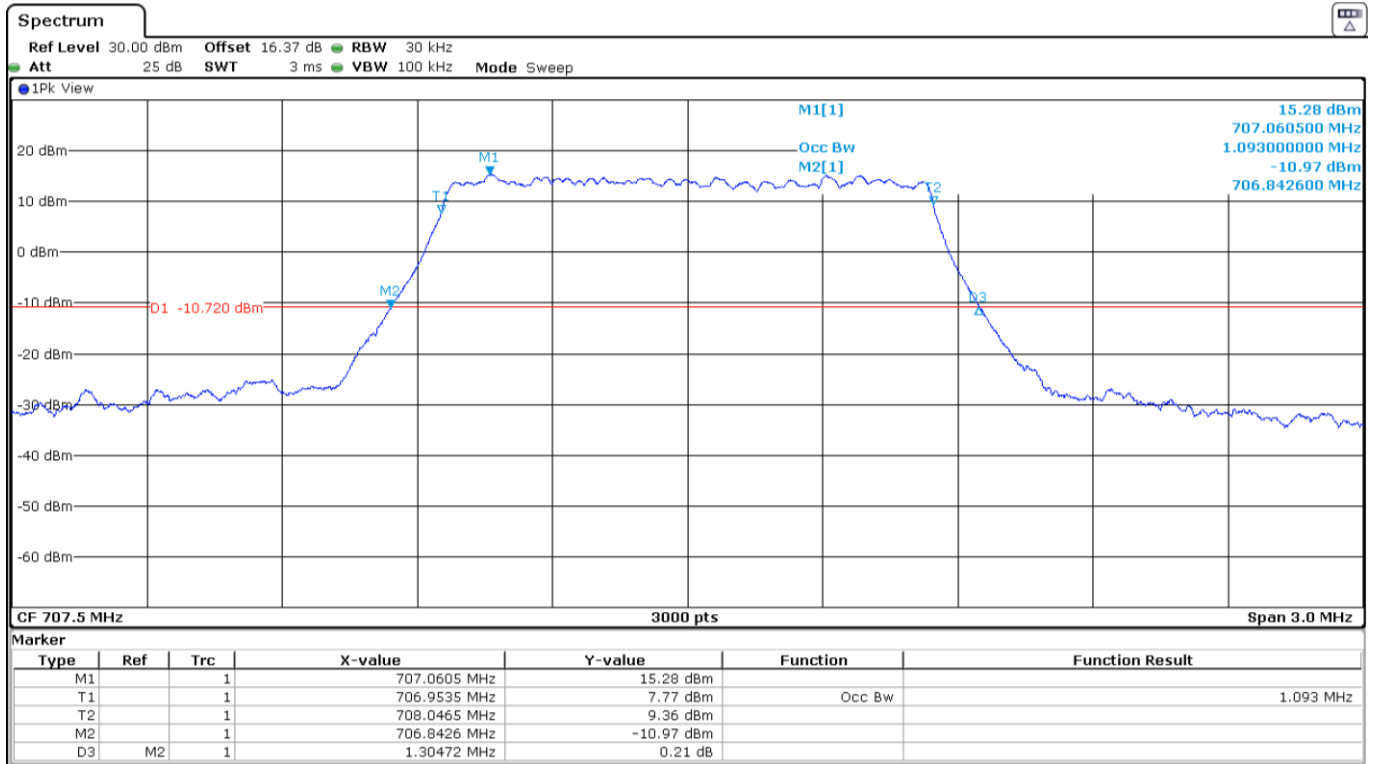

High Channel:

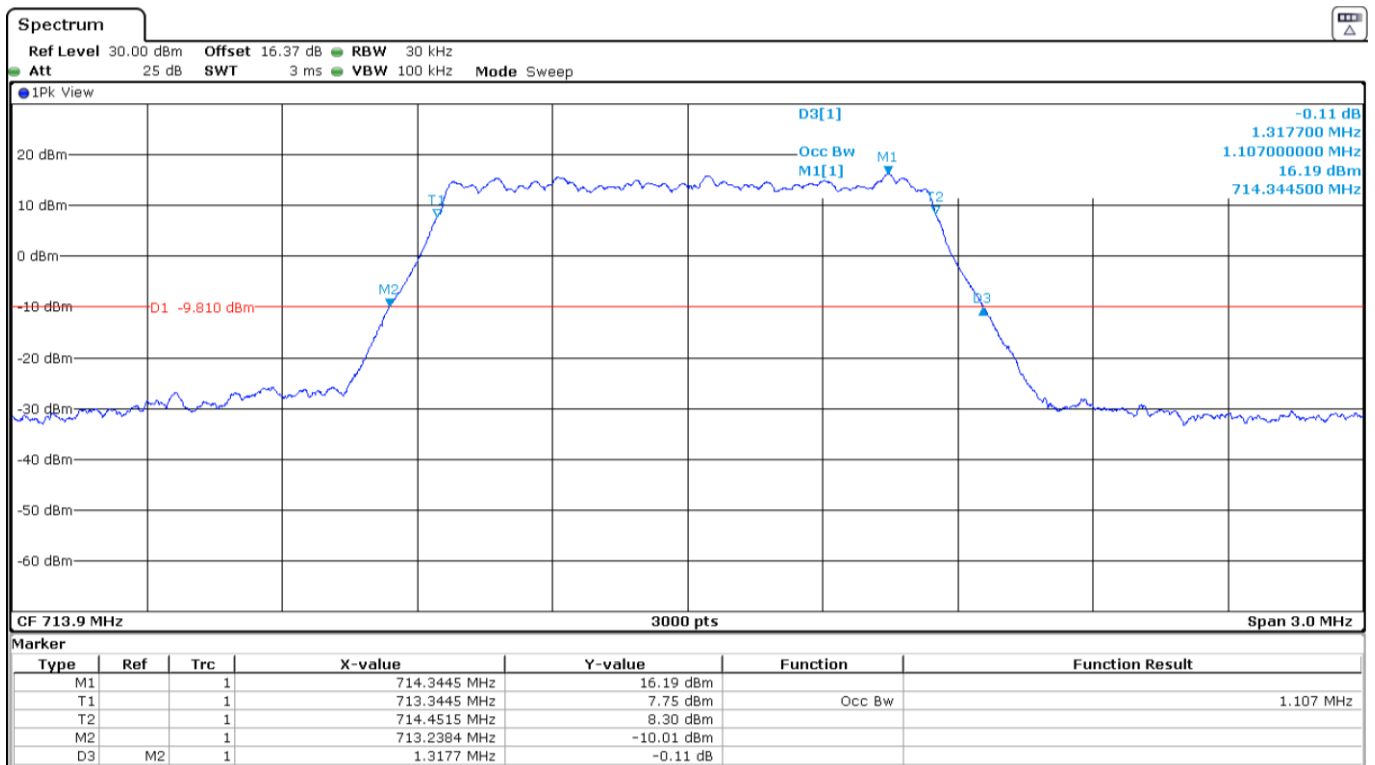

**LTE Band 12. QPSK MODULATION. BW = 3 MHz.**

**Low Channel:**

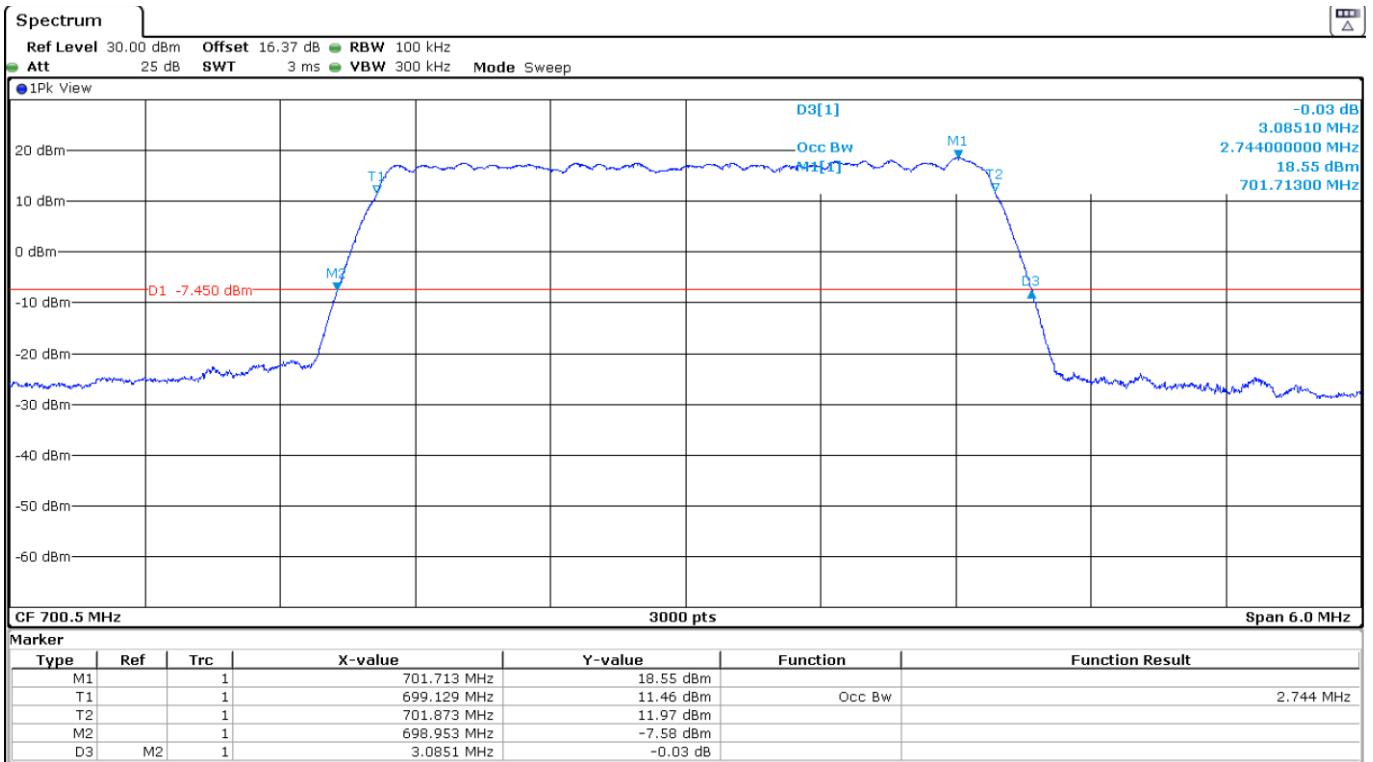

**Middle Channel:**

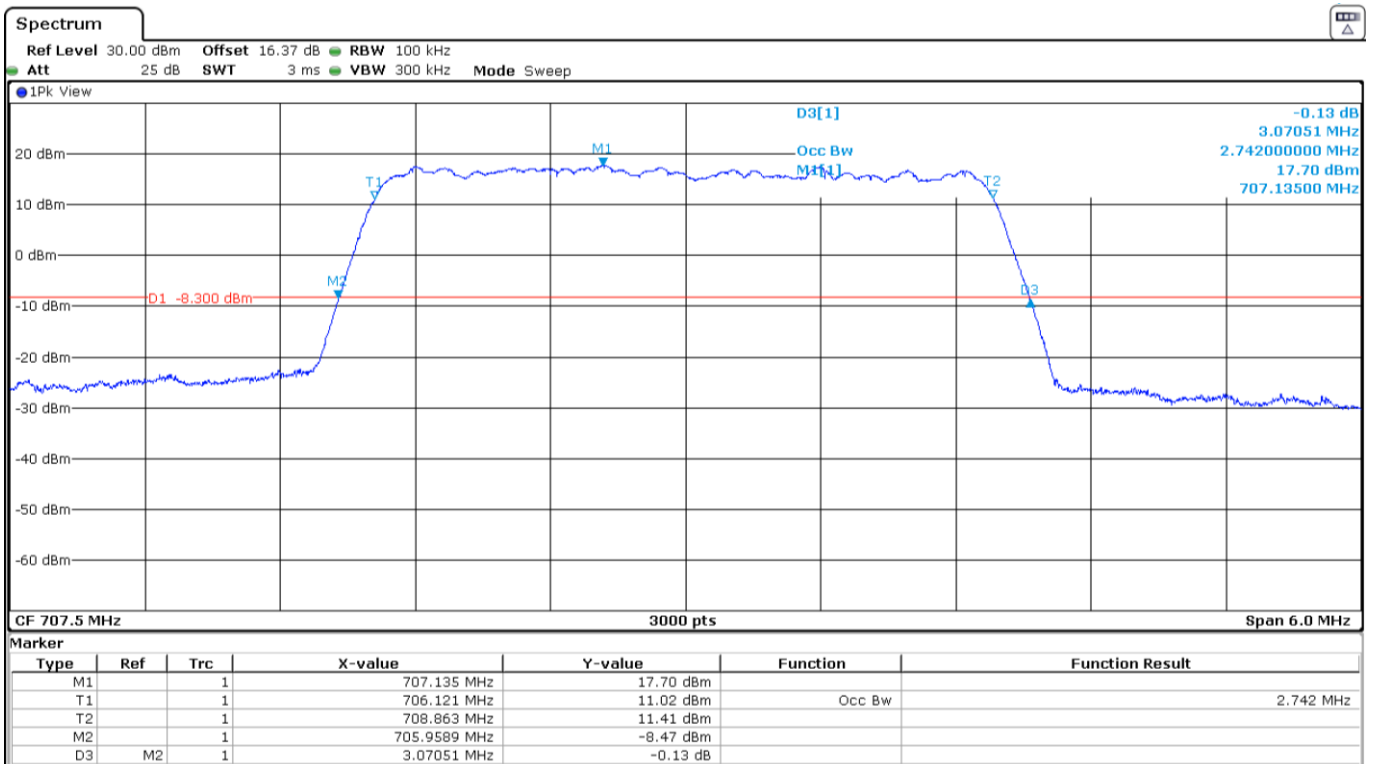

High Channel:

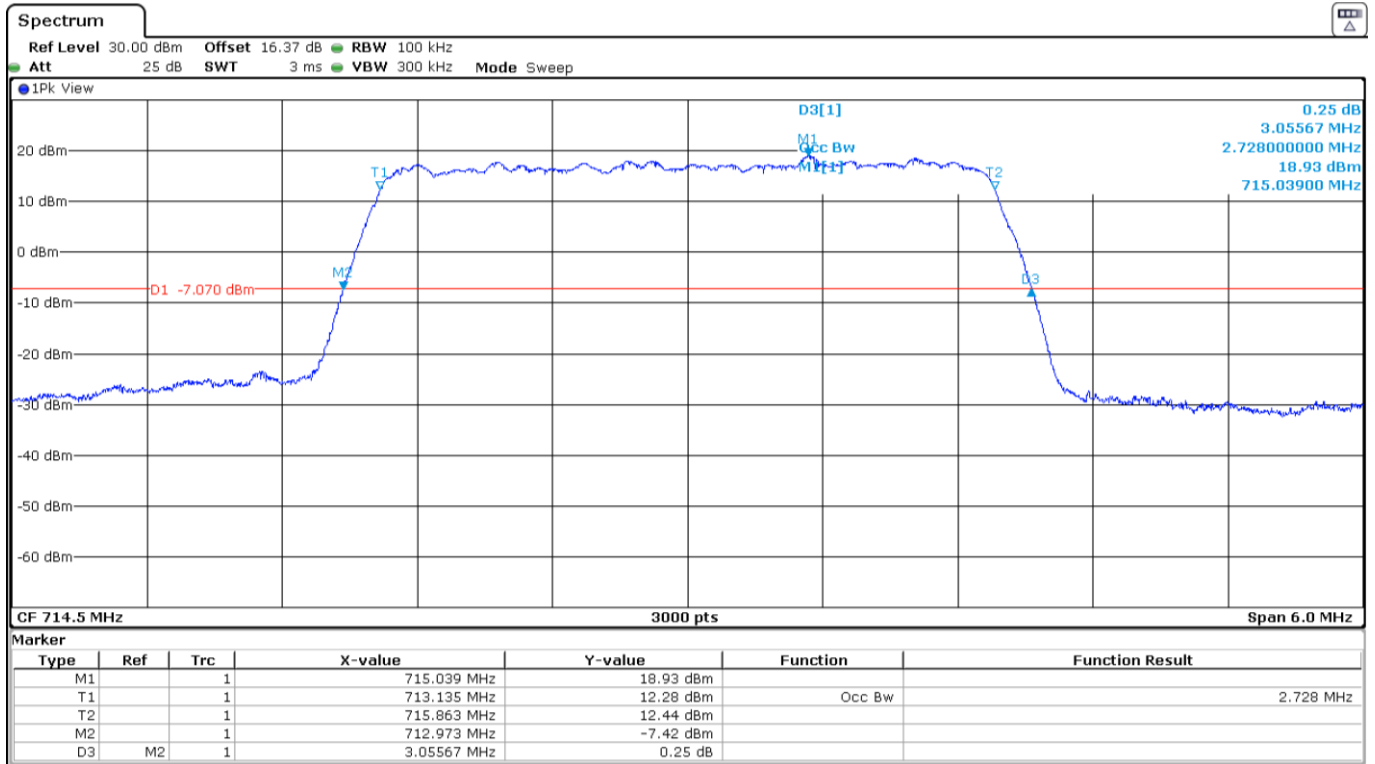

LTE Band 12. 16QAM MODULATION. BW = 3 MHz.

Low Channel:

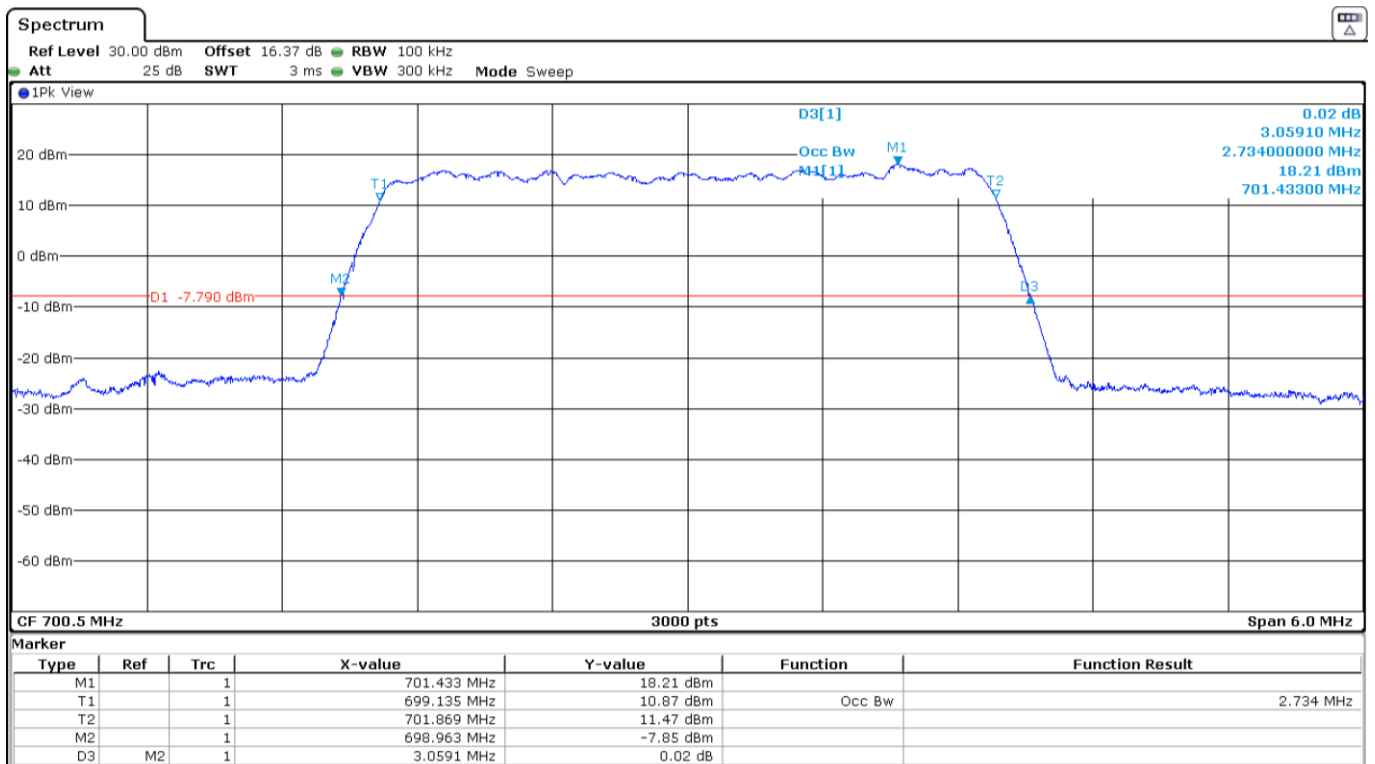

Middle Channel:

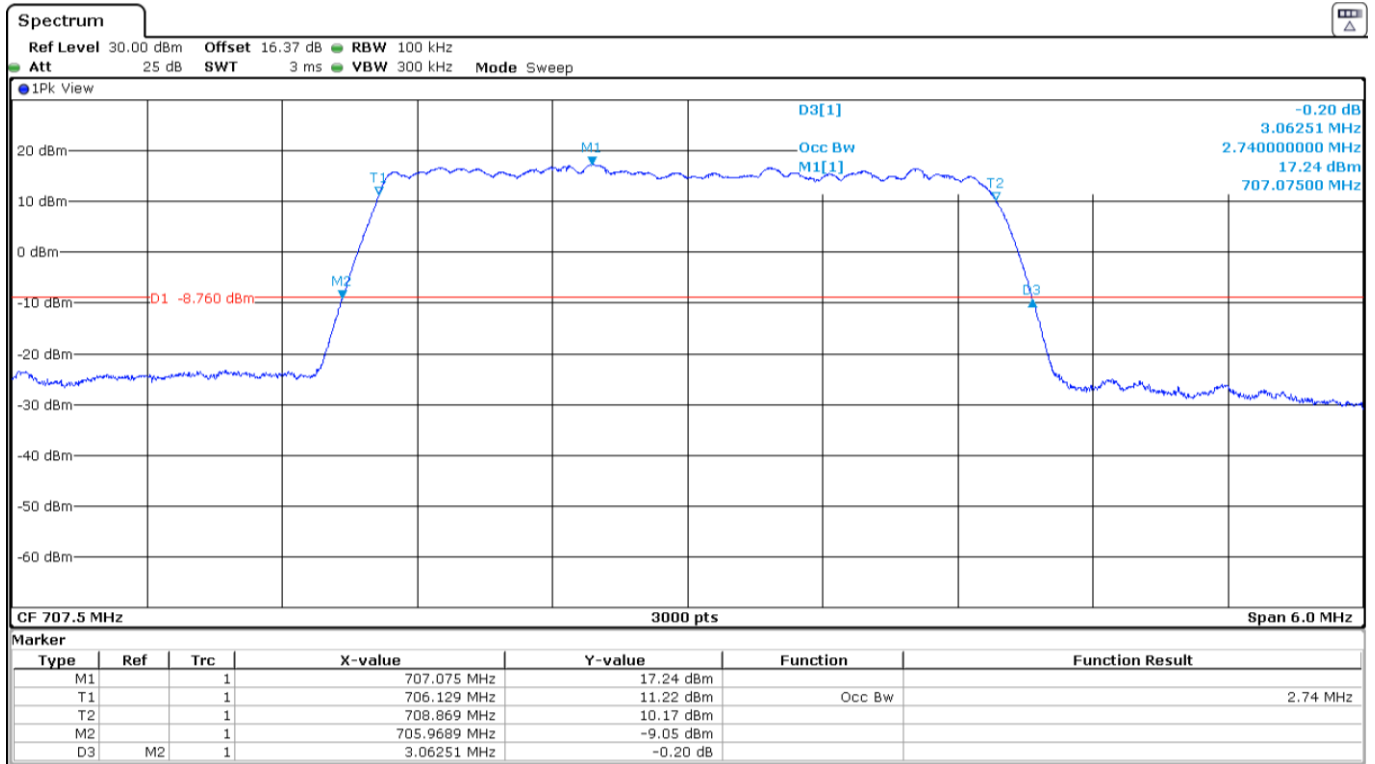

High Channel:

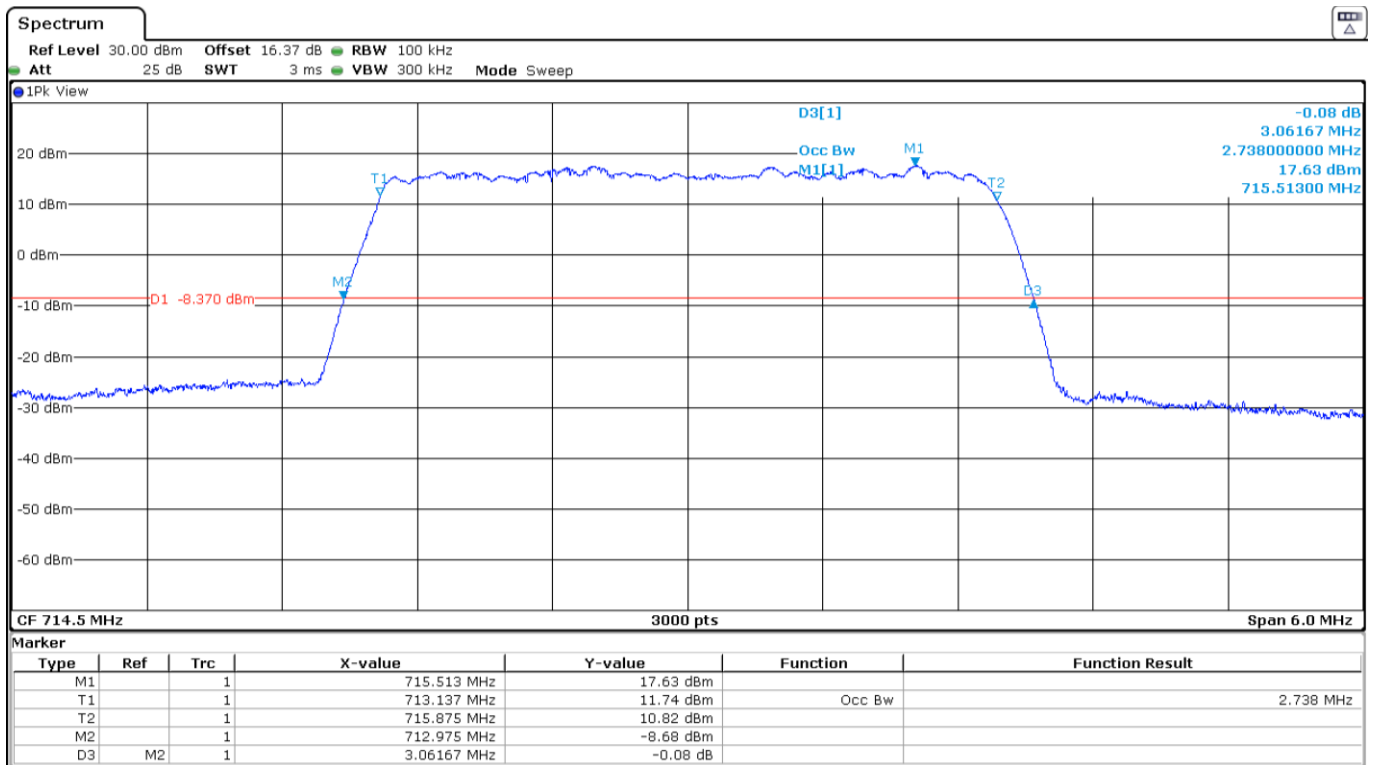

LTE Band 12. QPSK MODULATION. BW = 5 MHz.

Low Channel:

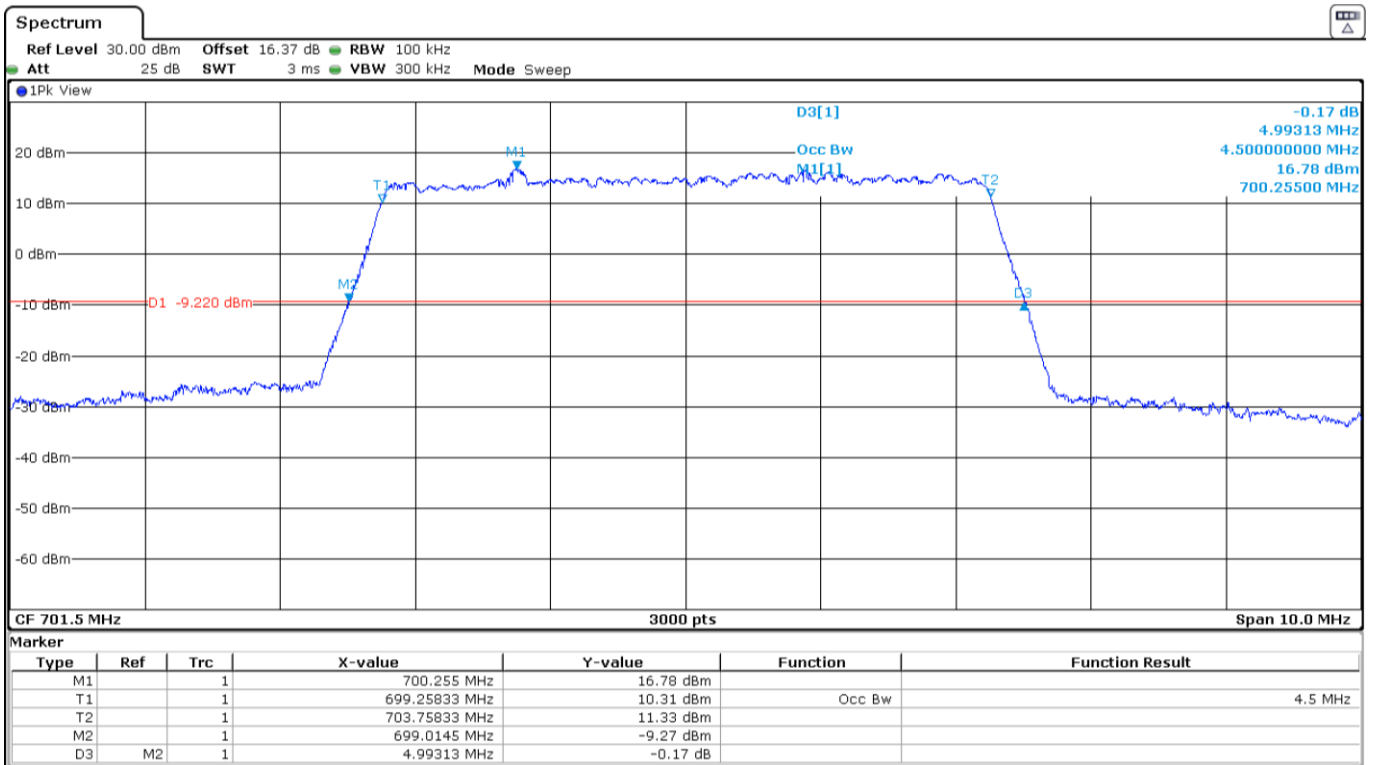

Middle Channel:

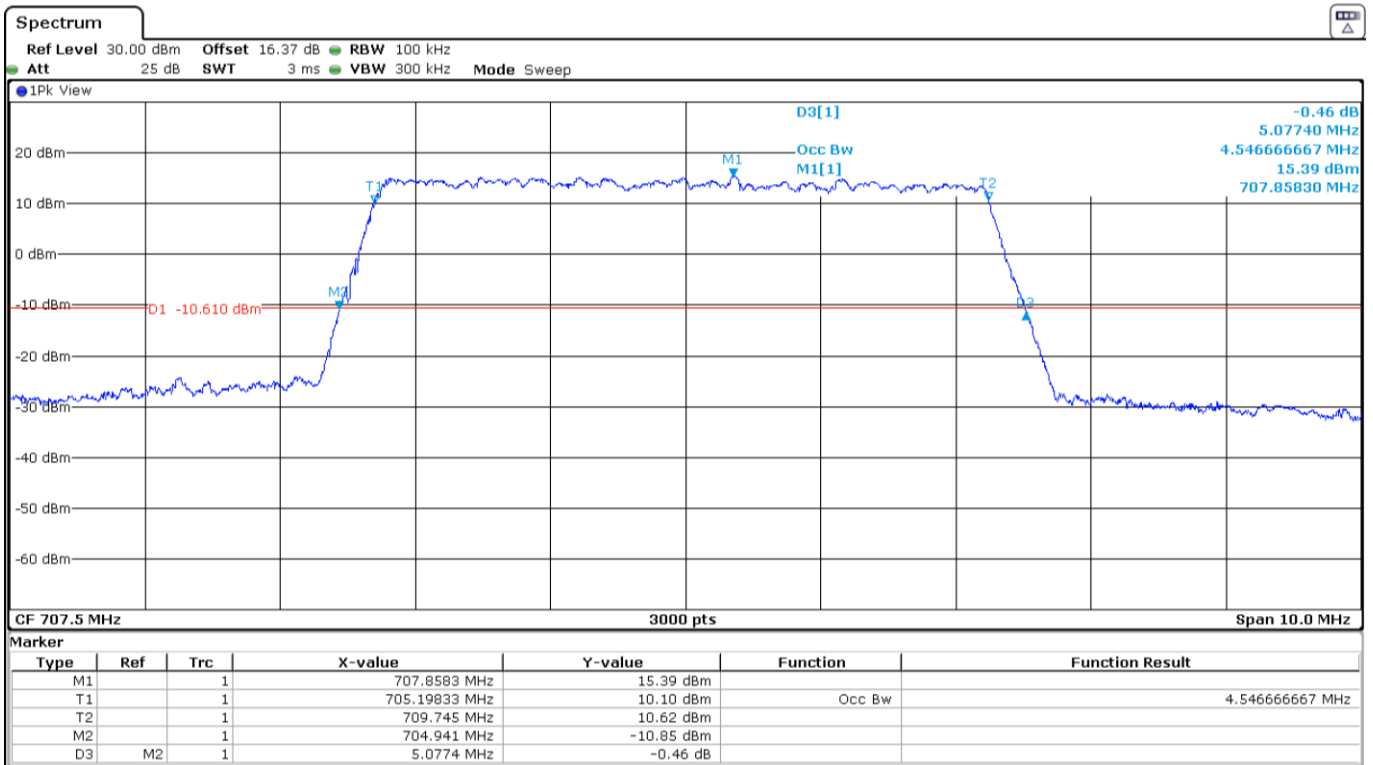

High Channel:

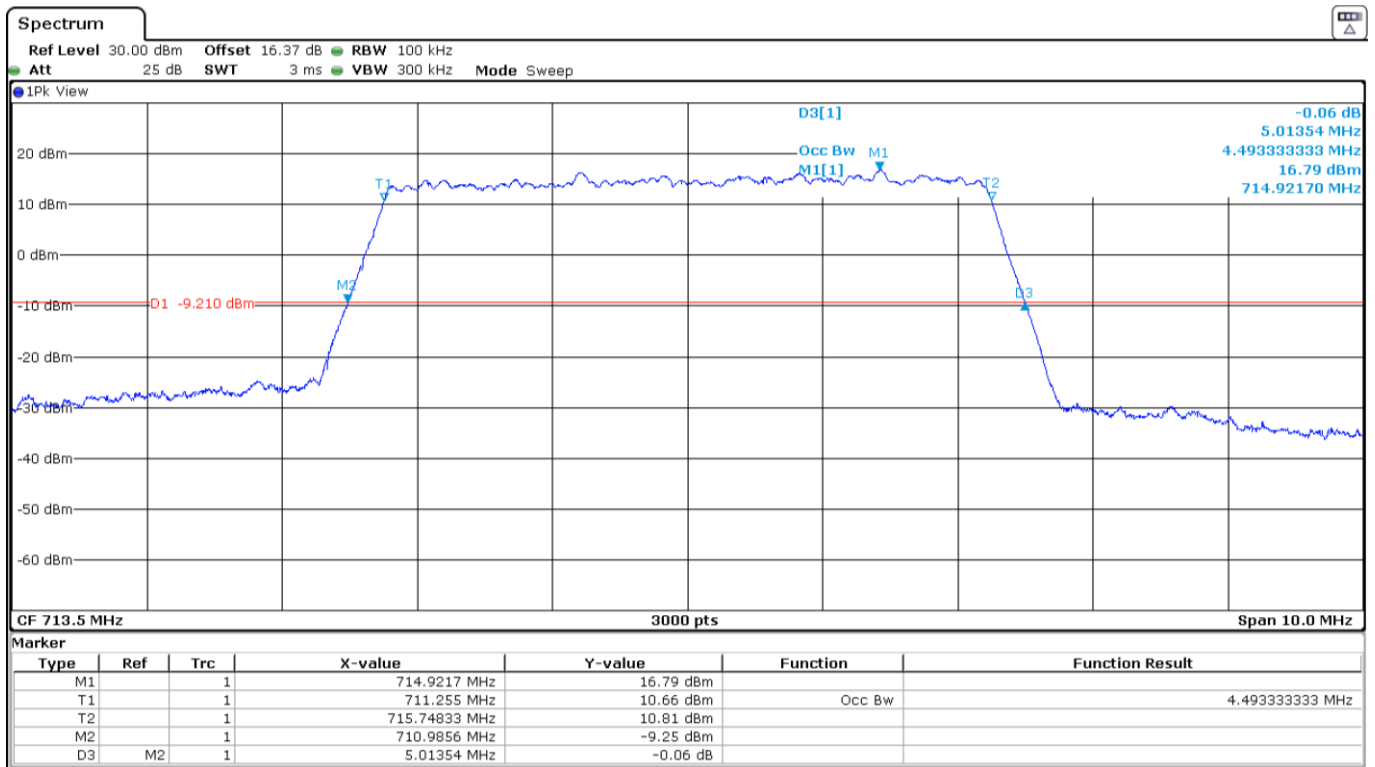

LTE Band 12. 16QAM MODULATION. BW = 5 MHz.

Low Channel:

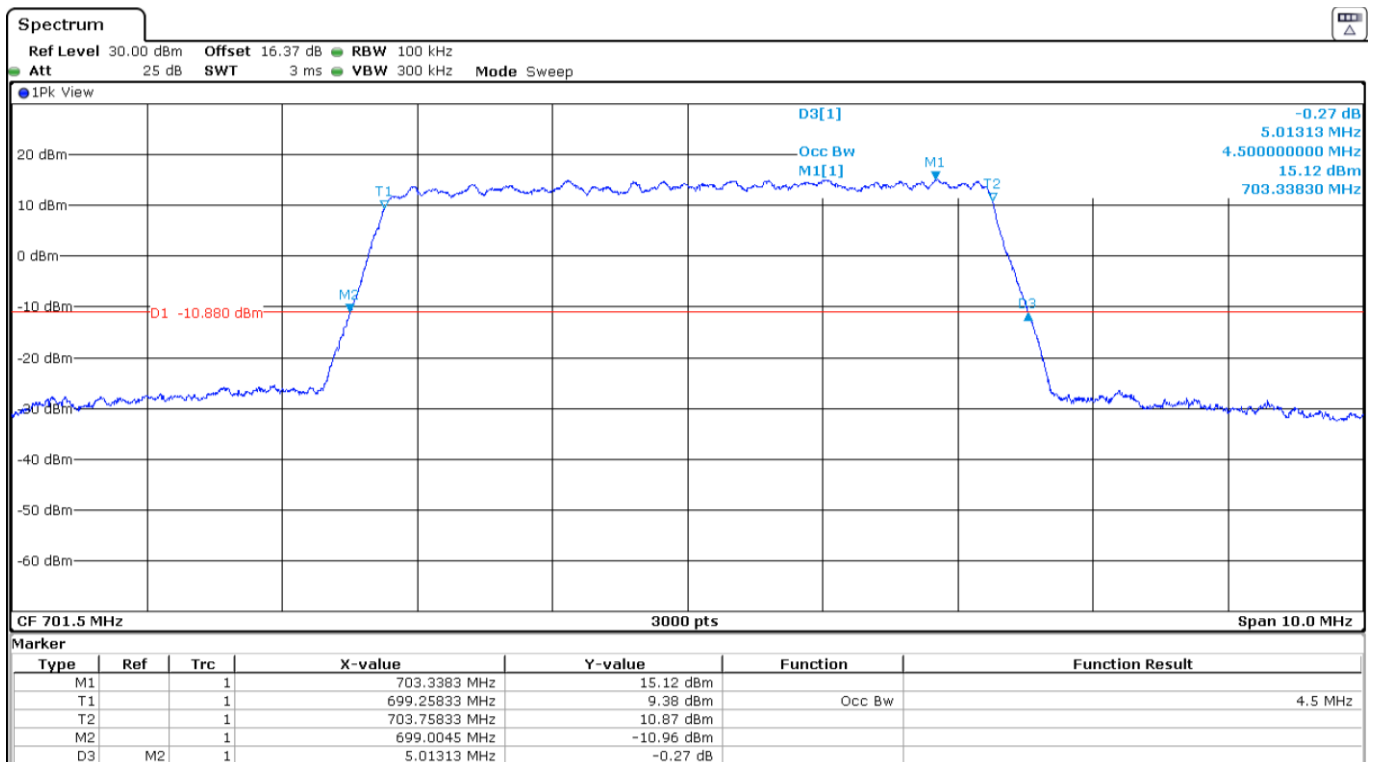



Middle Channel:

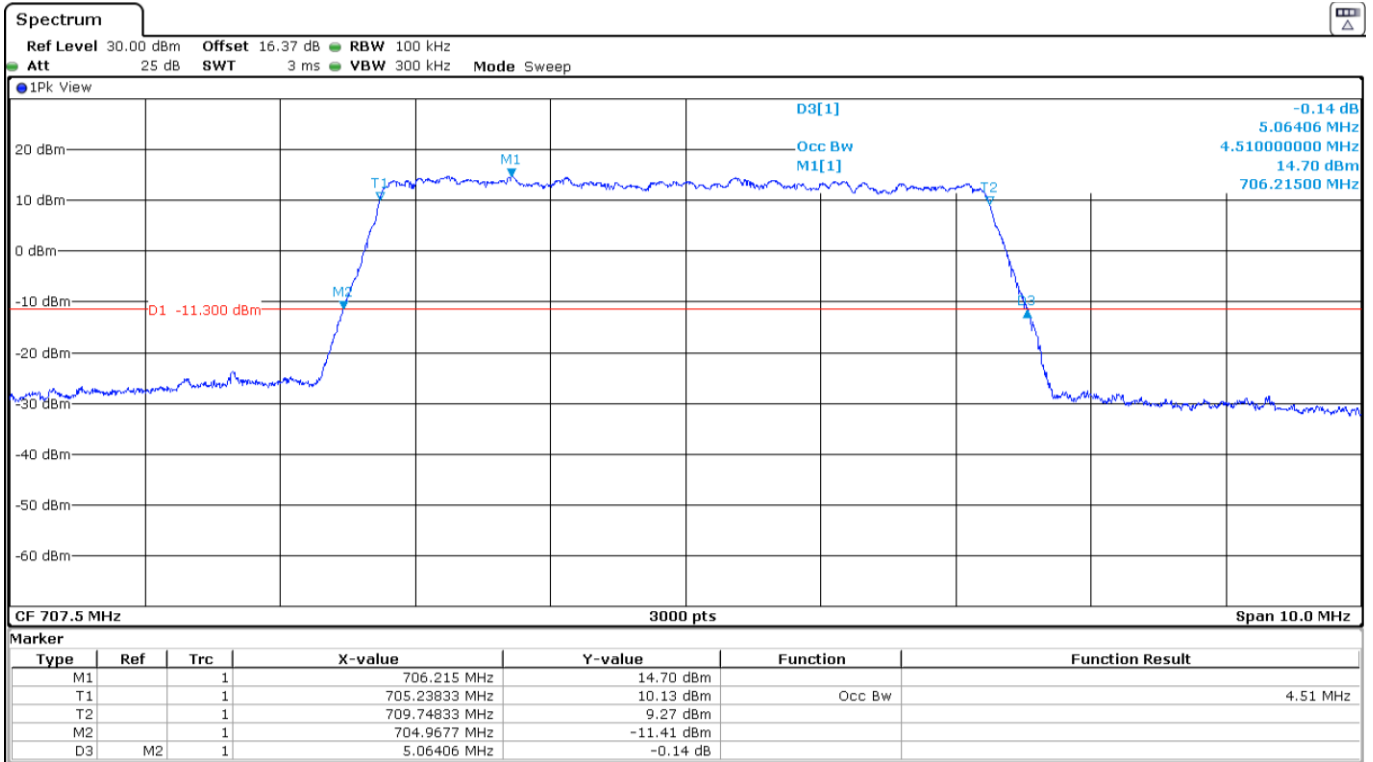

High Channel:

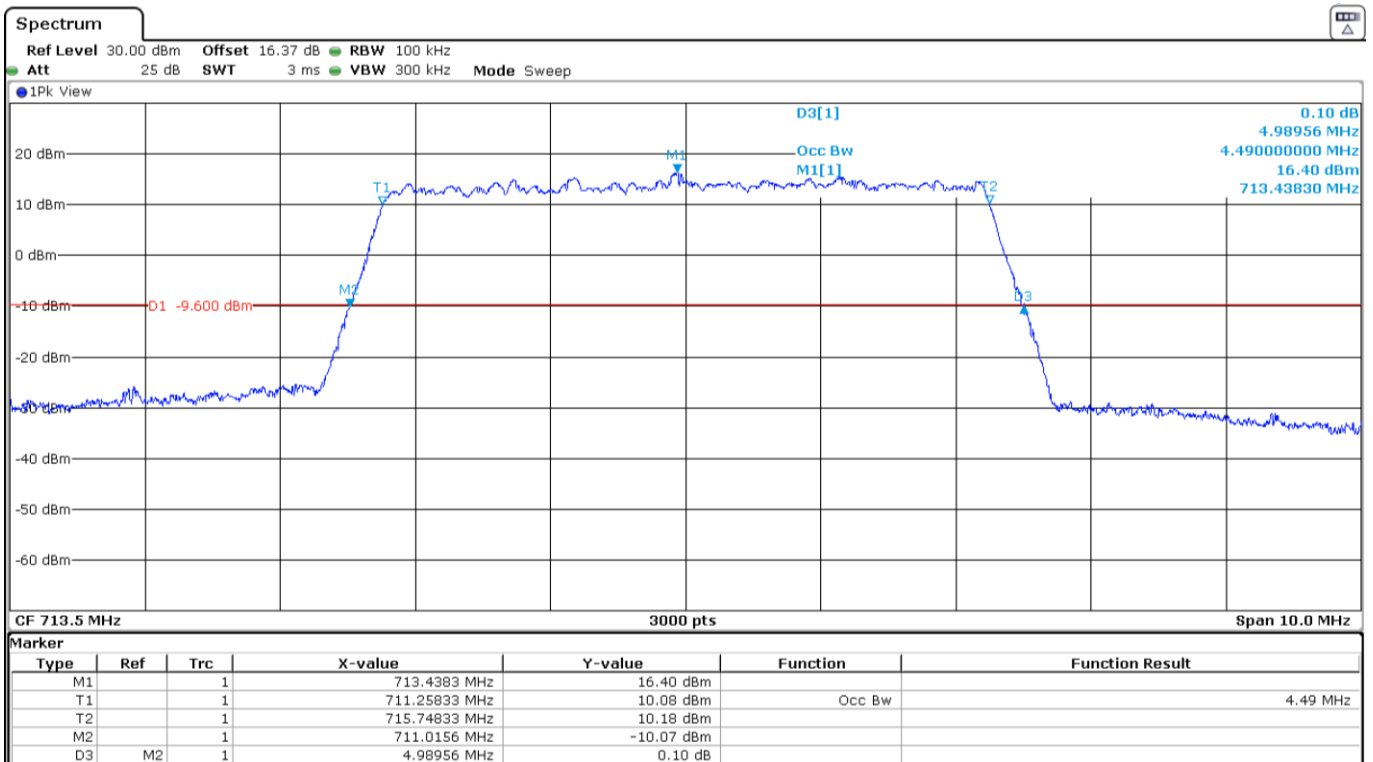

LTE Band 12. QPSK MODULATION. BW = 10 MHz.

Low Channel:

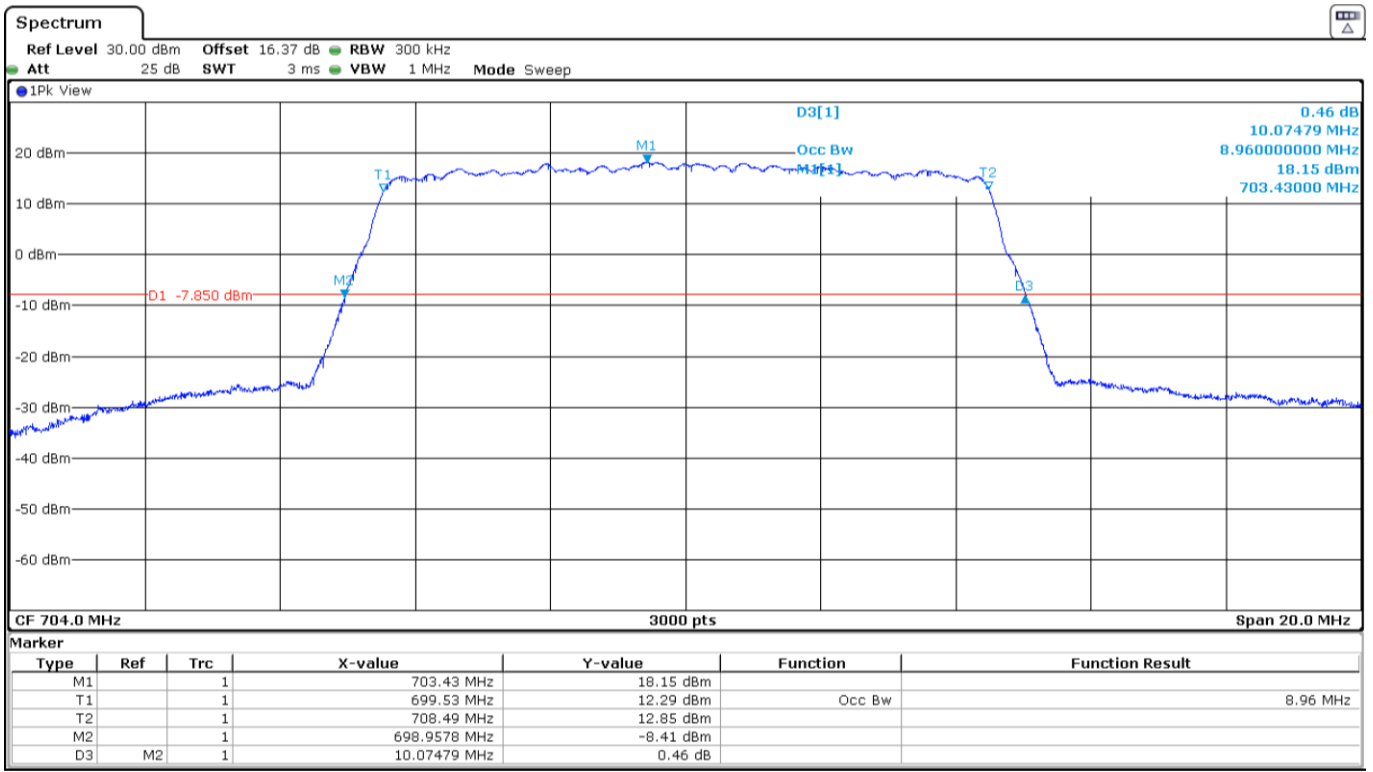

Middle Channel:

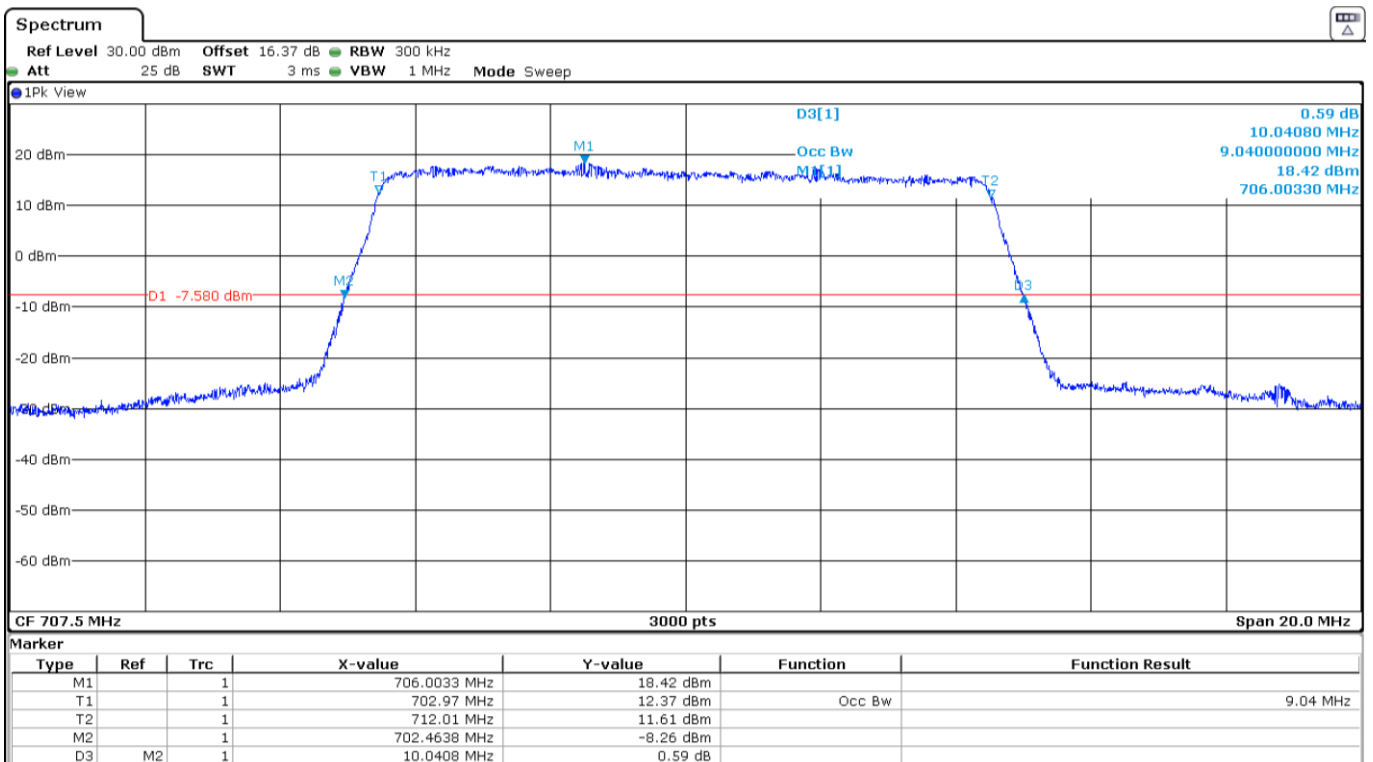

High Channel:

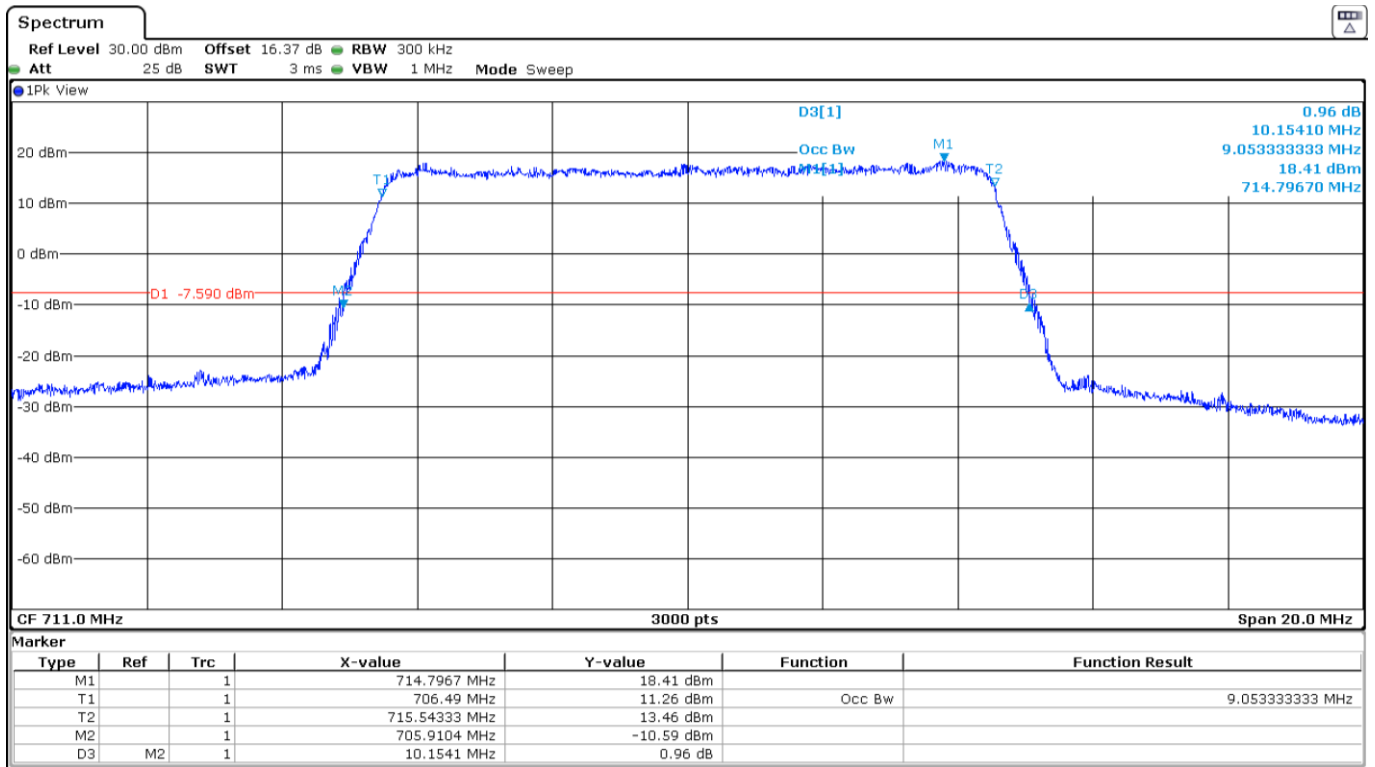

LTE Band 12. 16QAM MODULATION. BW = 10 MHz.

Low Channel:

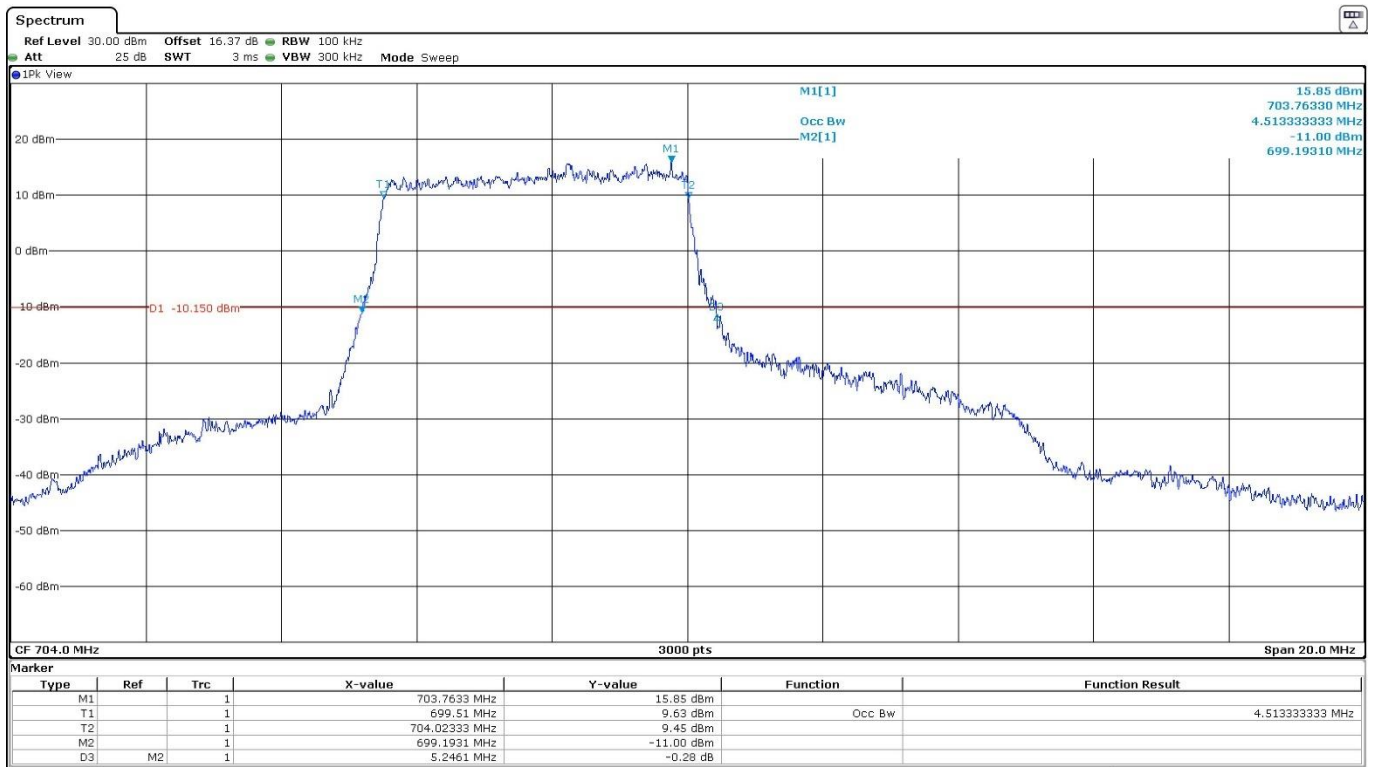

Middle Channel:

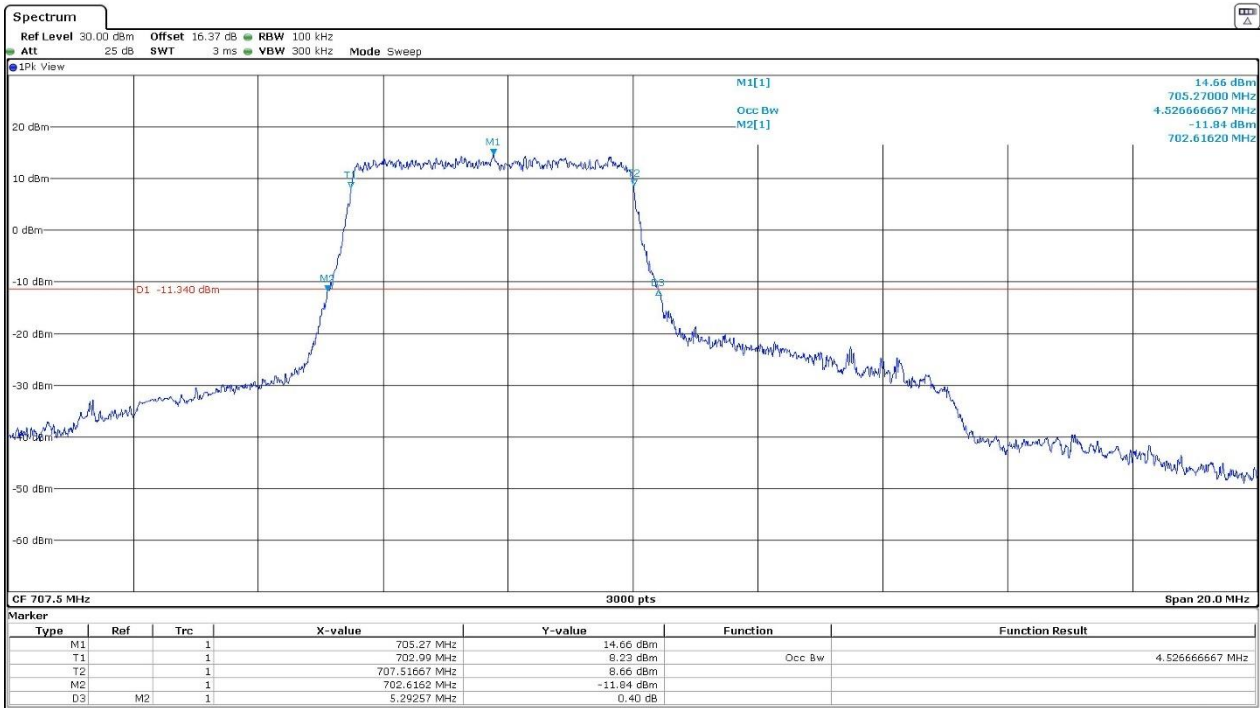

High Channel:

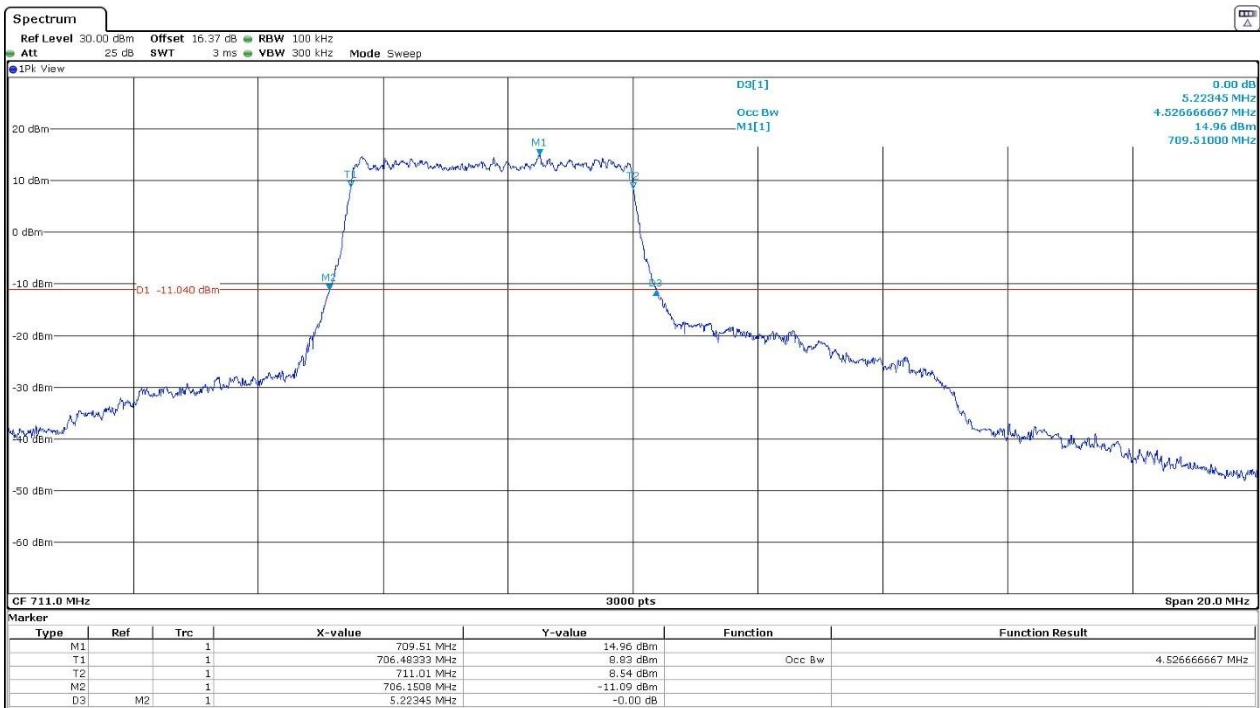

LTE Band 66. QPSK MODULATION. BW = 1.4 MHz.

Low Channel:

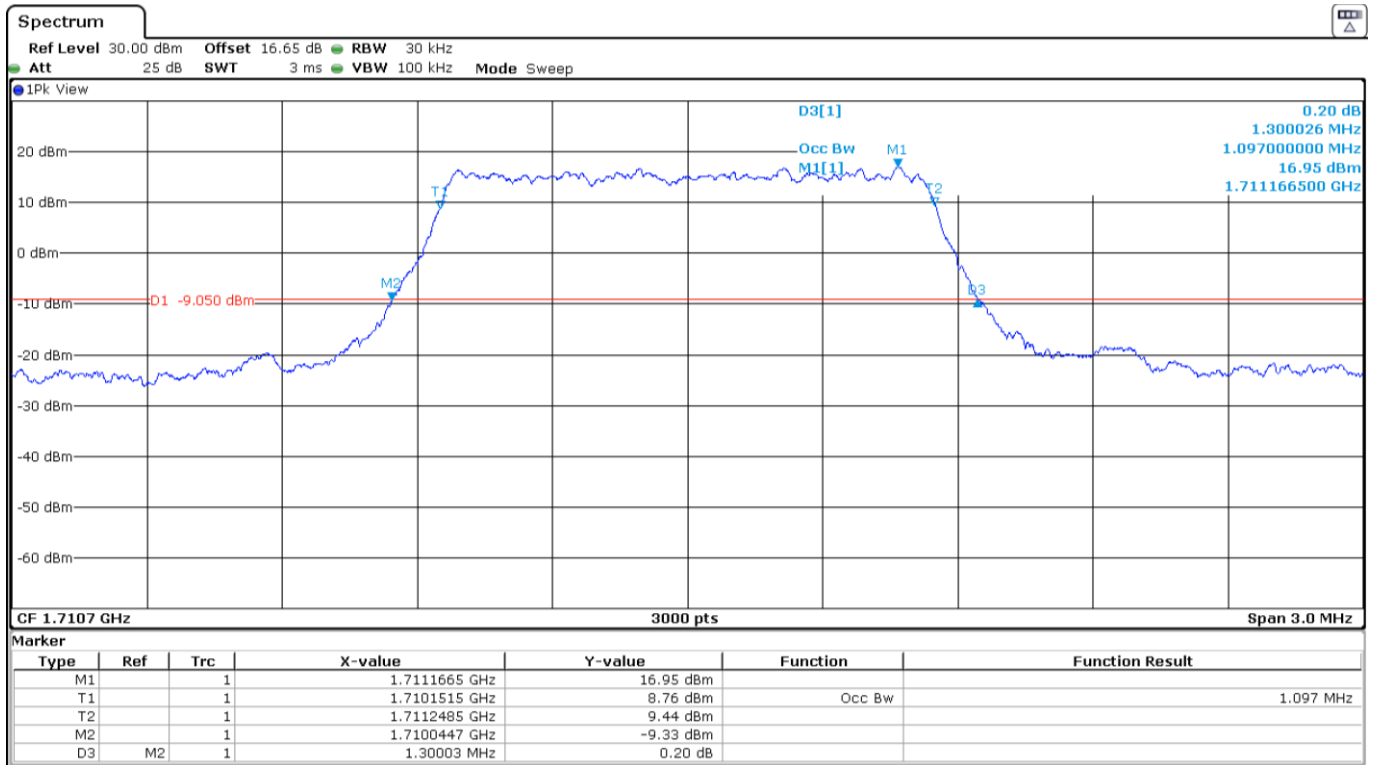

Middle Channel:

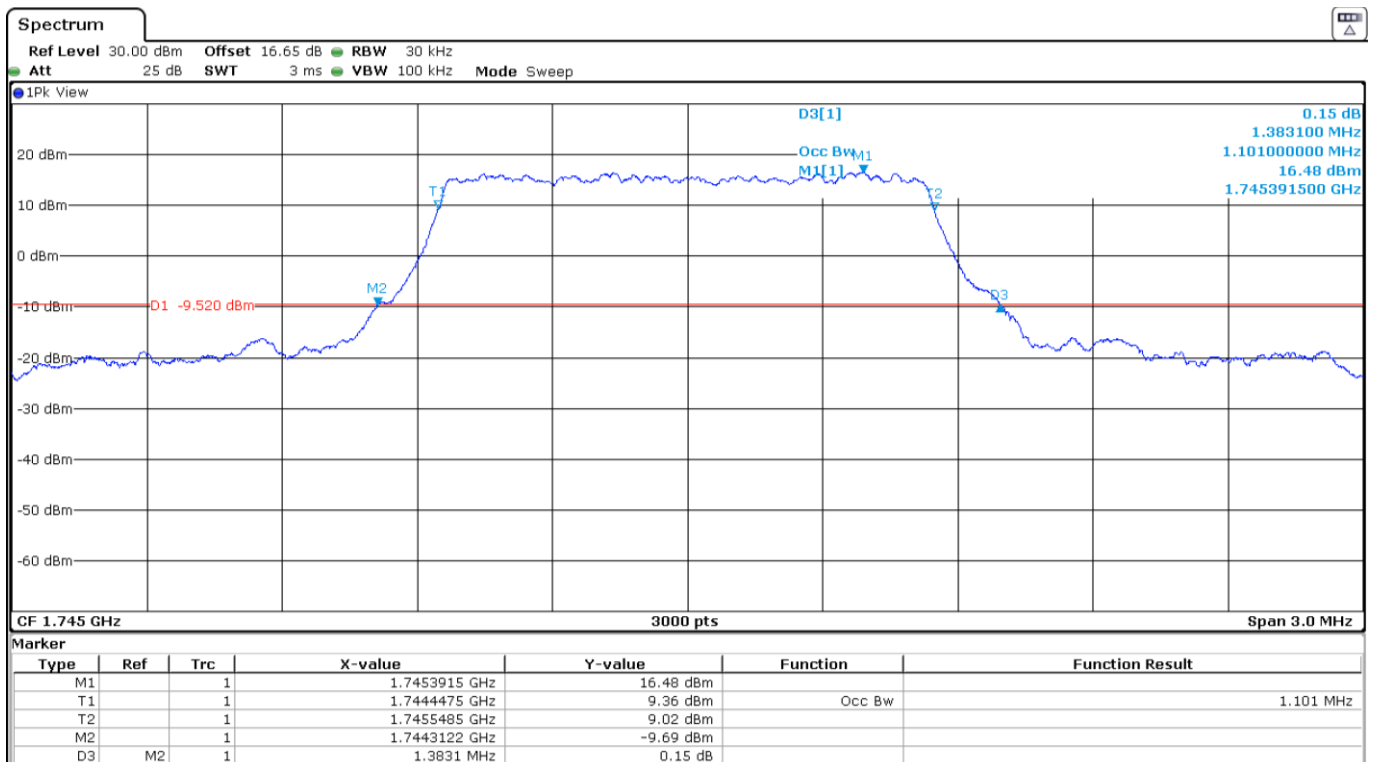

High Channel:

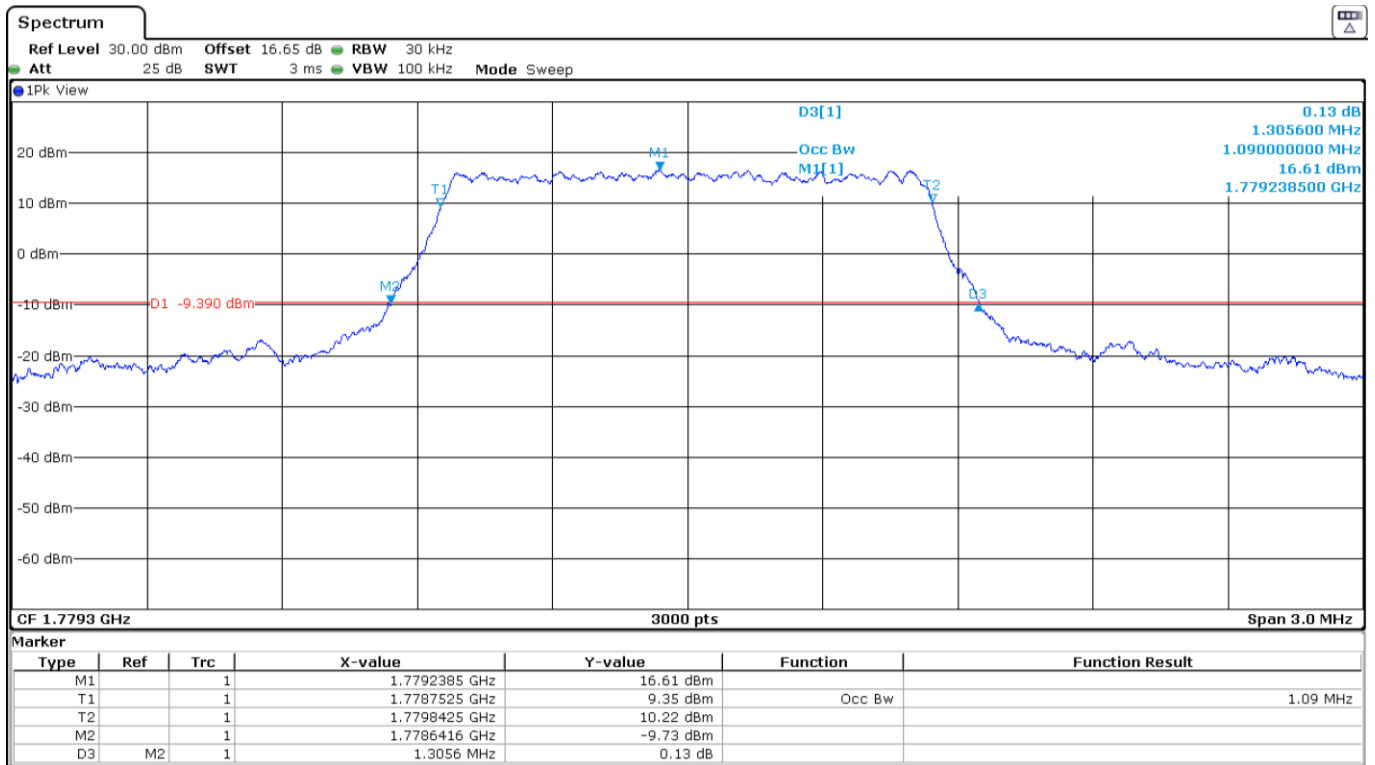

LTE Band 66. 16QAM MODULATION. BW = 1.4 MHz.

Low Channel:

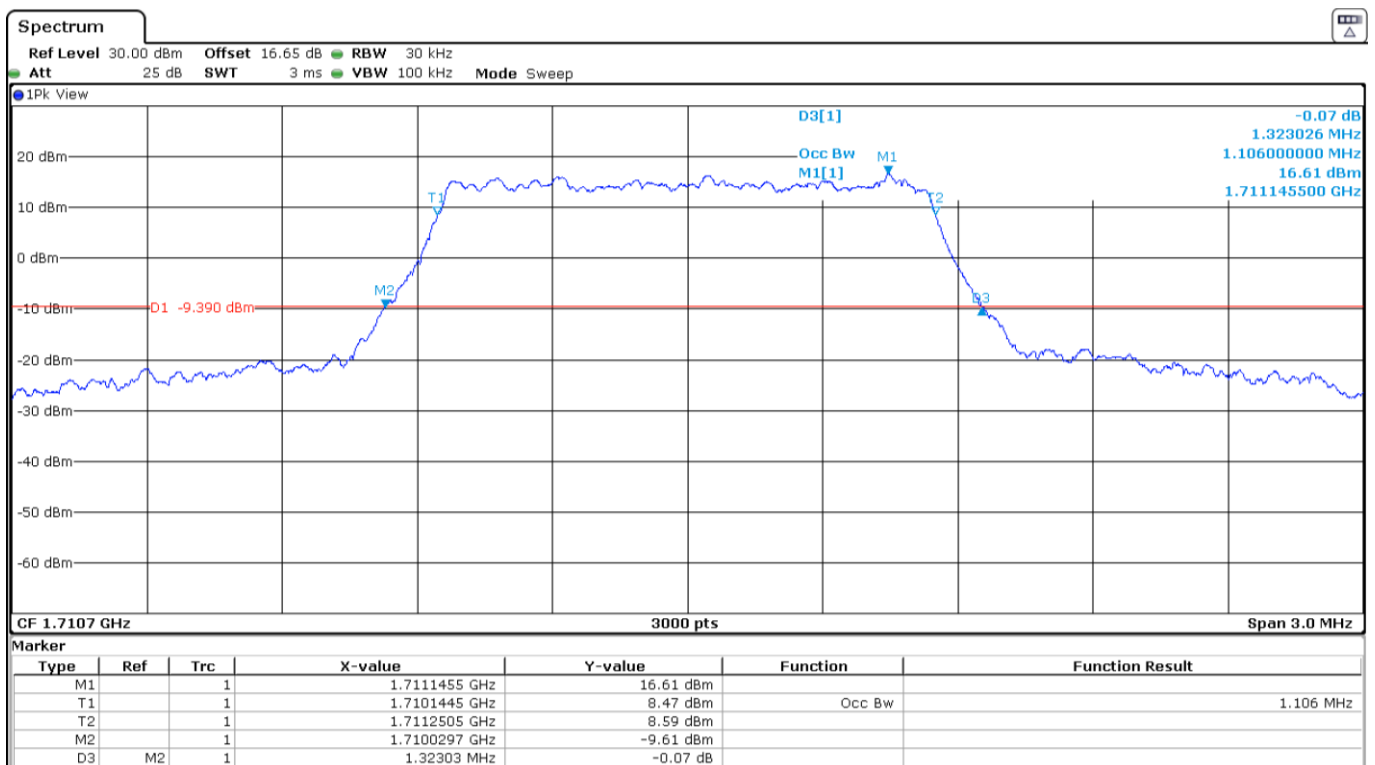

Middle Channel:

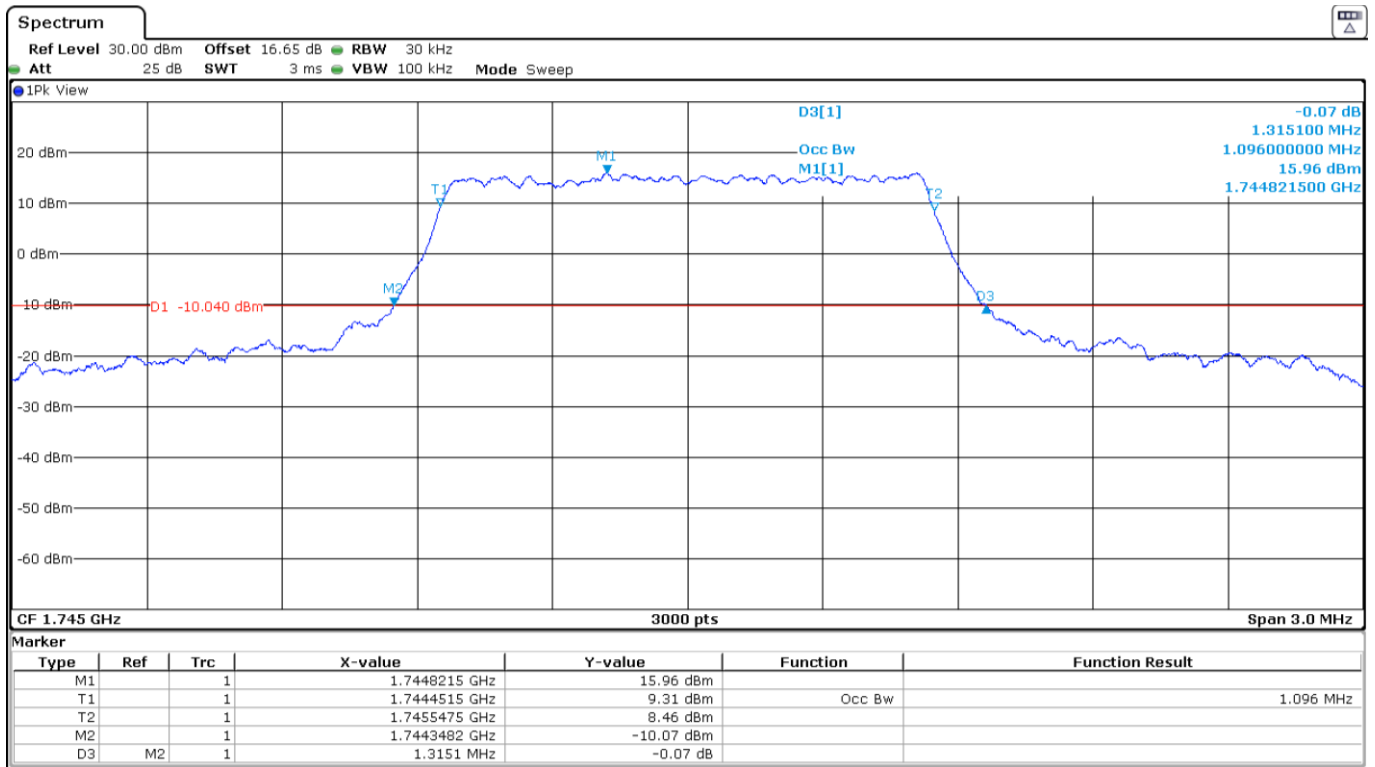

High Channel:

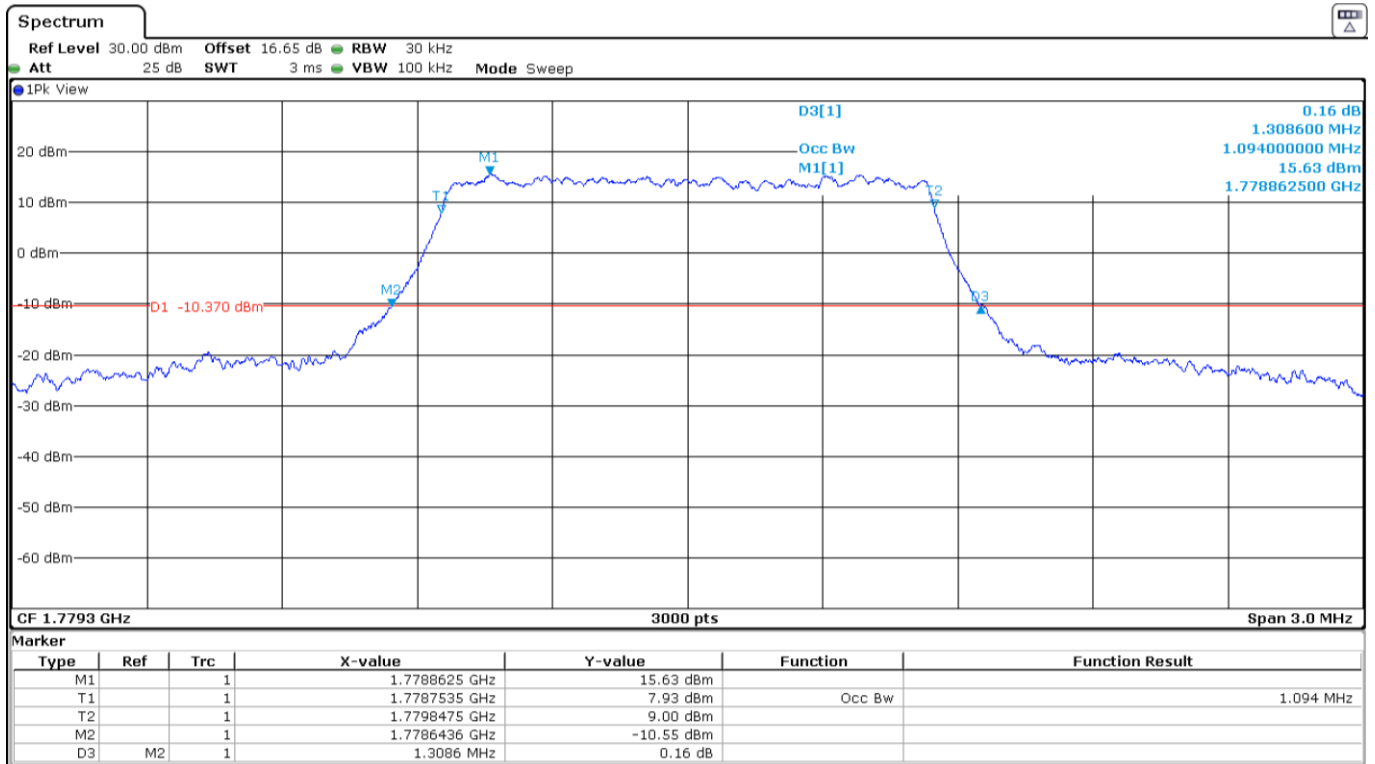

LTE Band 66. QPSK MODULATION. BW = 3 MHz.

Low Channel:

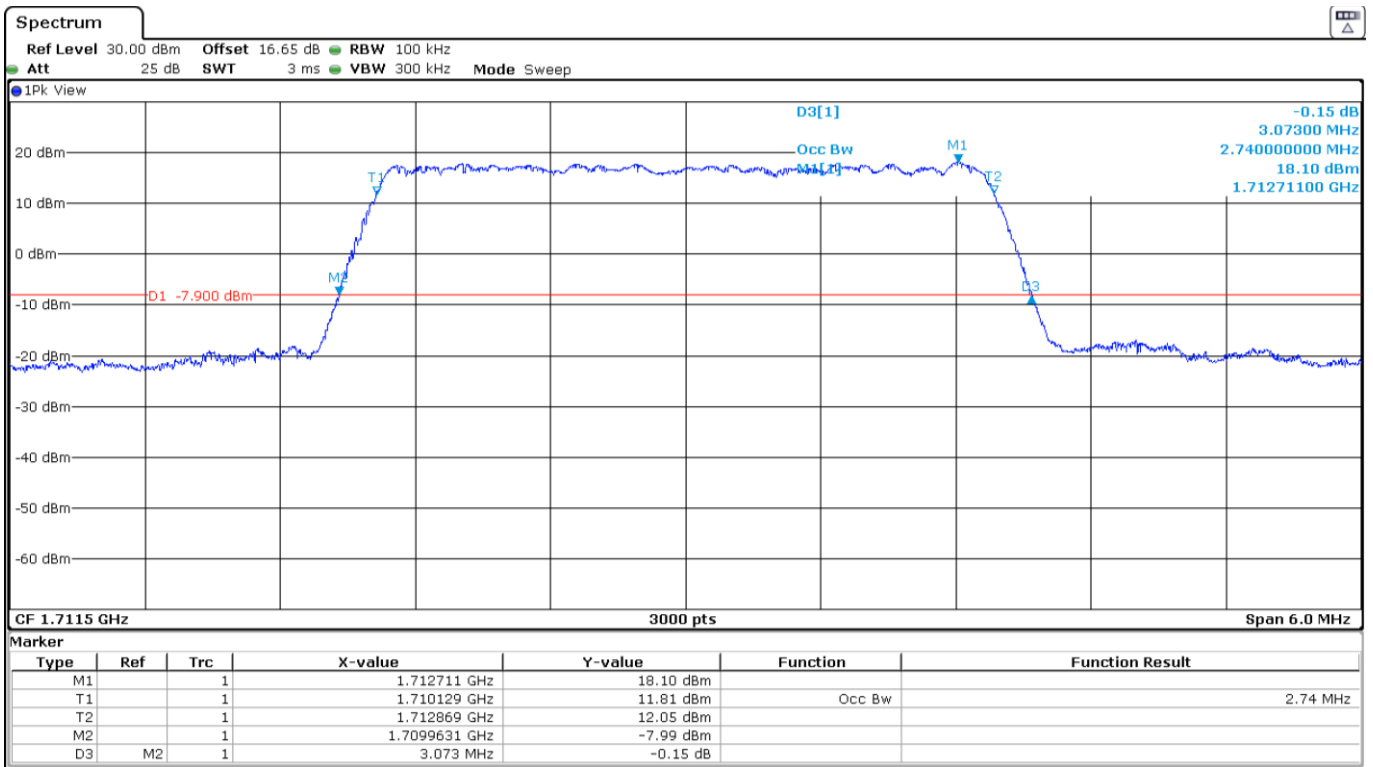

Middle Channel:

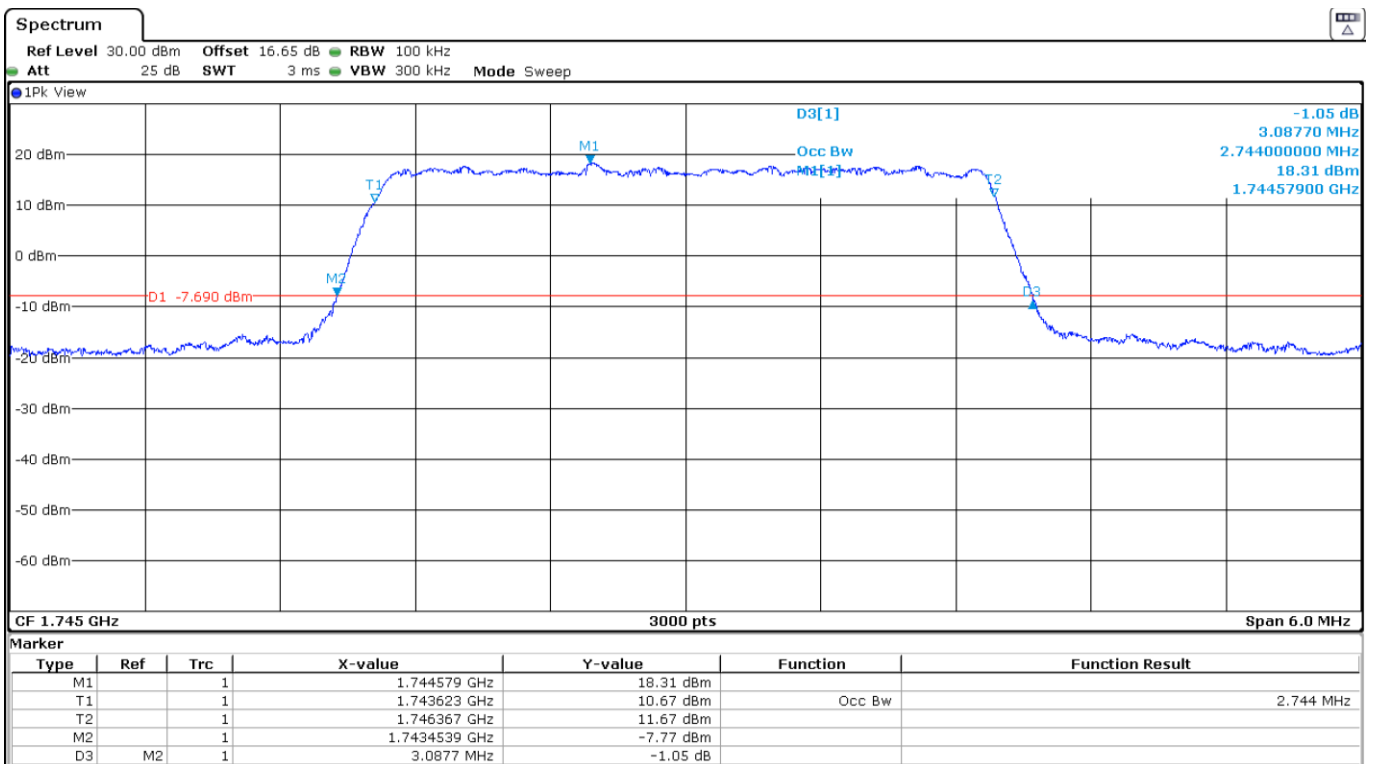



High Channel:

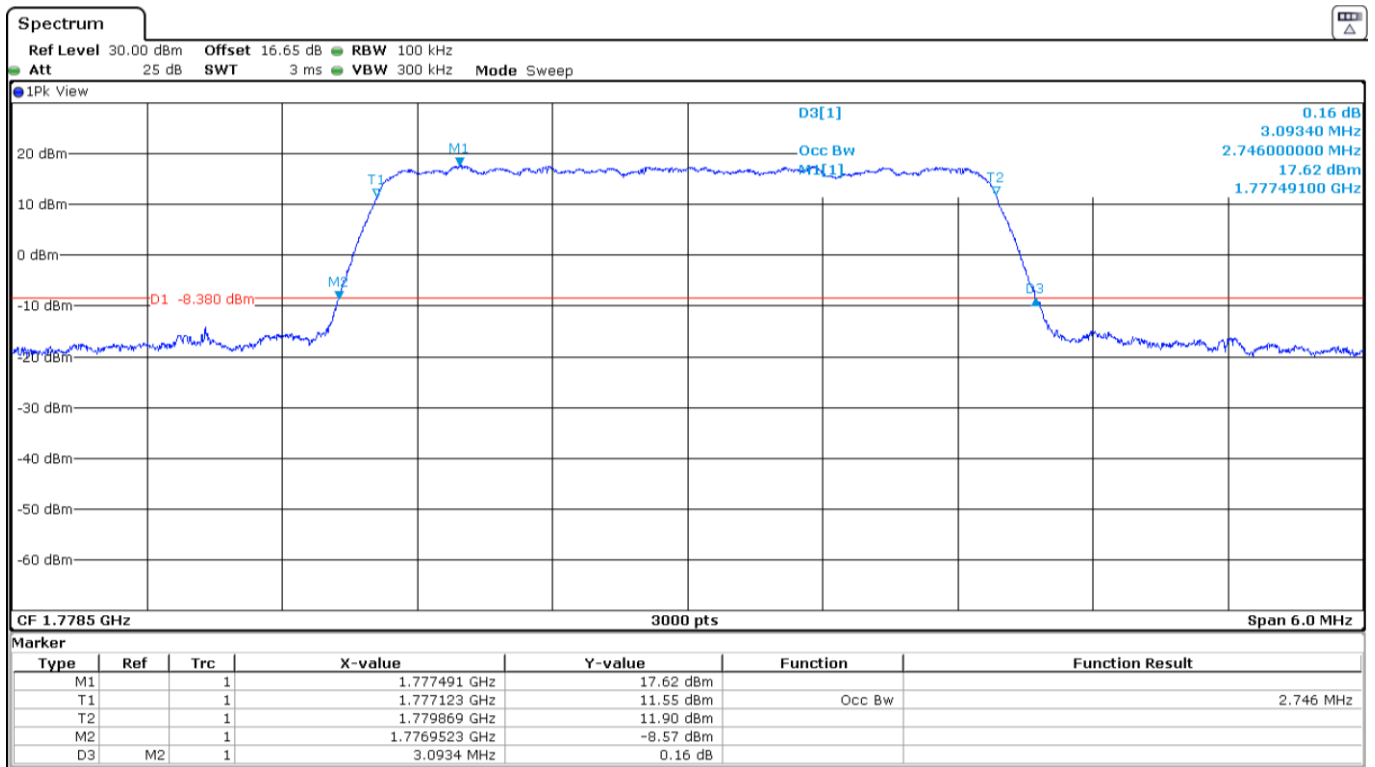

LTE Band 66. 16QAM MODULATION. BW = 3 MHz.

Low Channel:

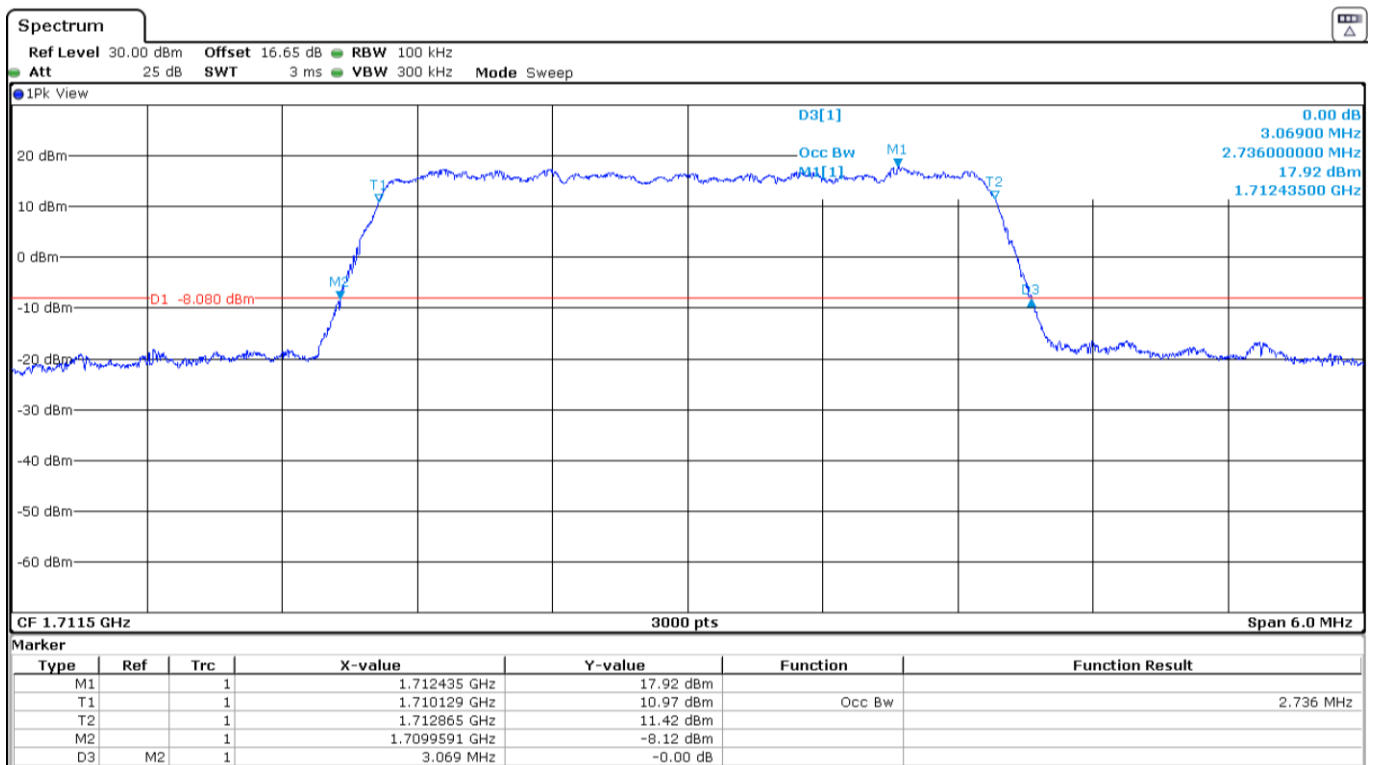

Middle Channel:

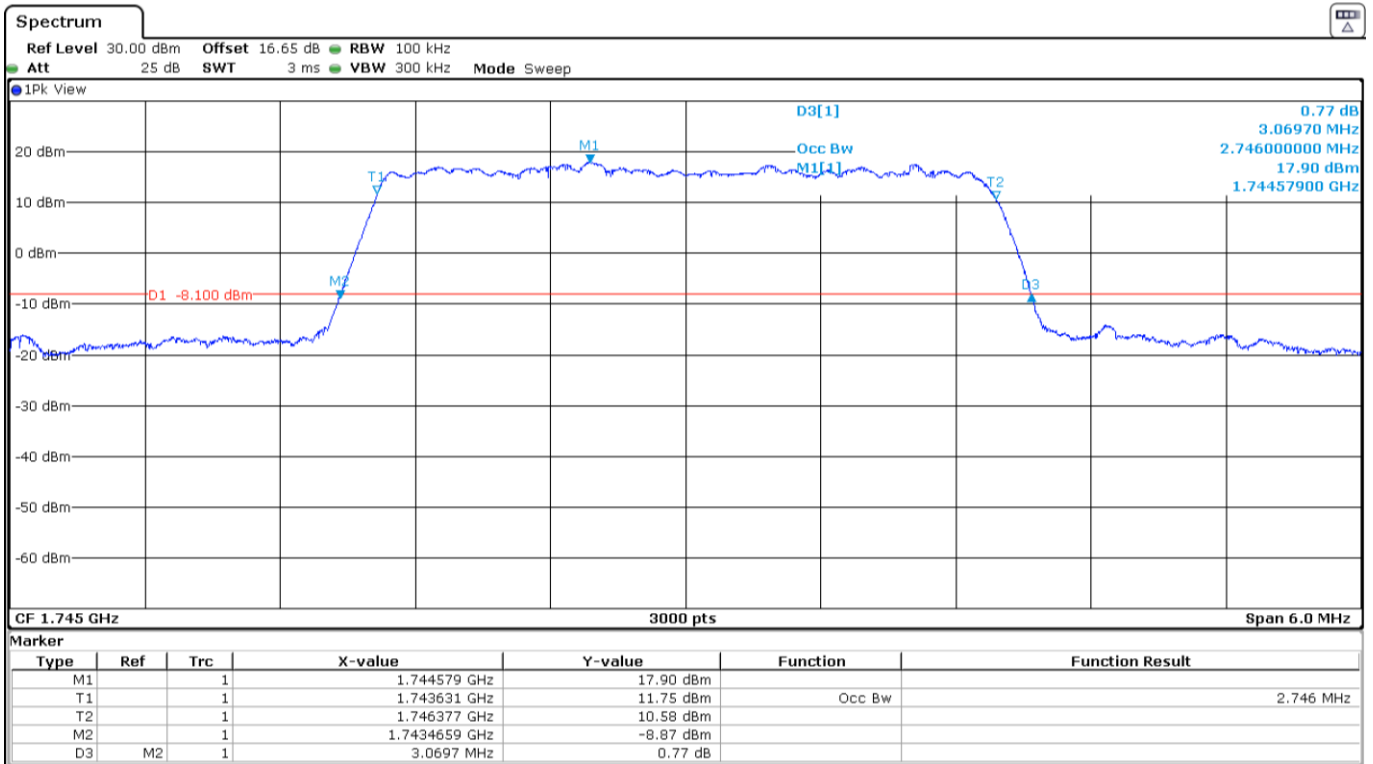

High Channel:

