

Product	LE910C1-NA		
Test Mode	Spurious Emission (Conducted)		
Date of Test	2017/02/08	Test Site	CTR
Test Condition	LTE-Band 2 (5M)	Test Range	30MHz~20GHz

LTE- Band 2 (5M) 16QAM(1,12) CH19175 (1907.5MHz)

Frequency (MHz)	Reading Level (dBm)	Path Loss (dB)	Emission Level (dBm)	Limit (dBm)
3815	-55.590	1.1	-54.490	-13
5723	-51.120	1.23	-49.890	-13
7630	-57.950	1.59	-56.360	-13
9528	-65.090	1.89	-63.200	-13
11455	-65.914	2.07	-63.844	-13
13338	-63.657	2.26	-61.397	-13
15260	-61.496	2.64	-58.856	-13
17168	-60.074	3.5	-56.574	-13
19070	-59.980	3.7	-56.280	-13

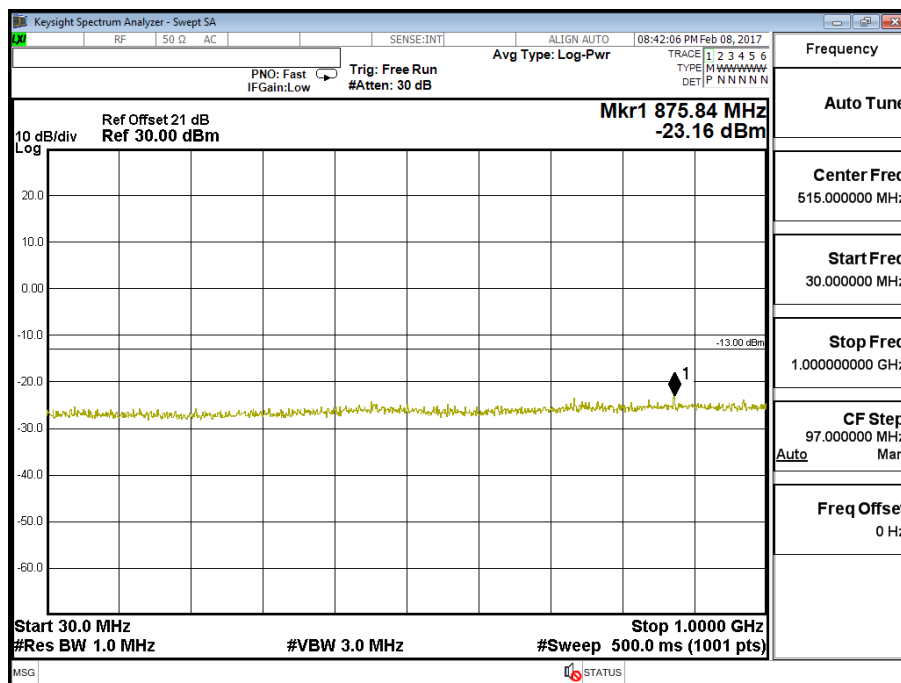

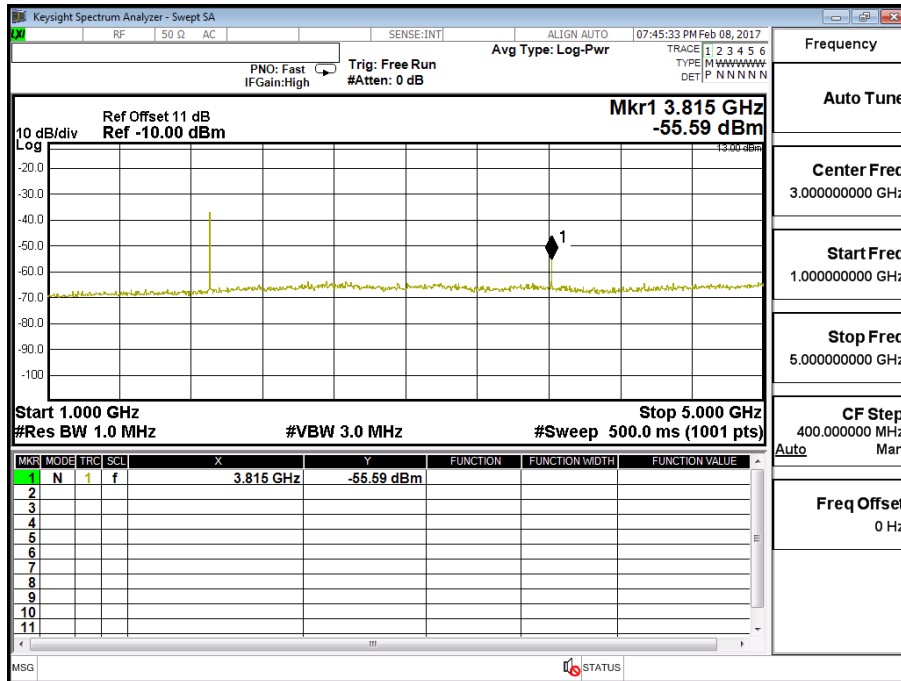

Frequency	Auto Tune
Center Freq	3.000000000 GHz
Start Freq	1.000000000 GHz
Stop Freq	5.000000000 GHz
CF Step	400.0000000 MHz
Freq Offset	0 Hz

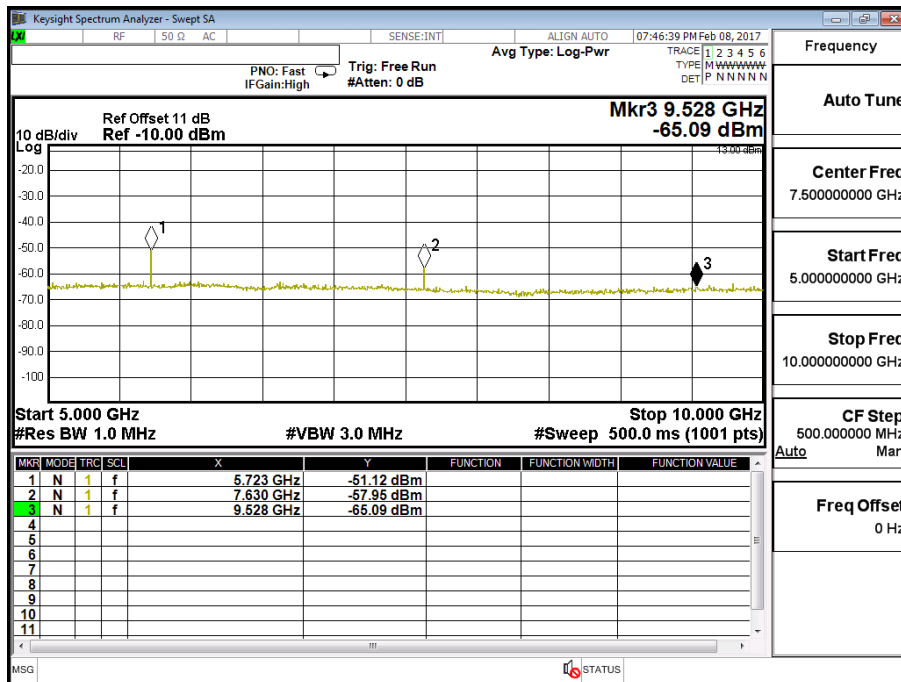

Frequency	Auto Tune
Center Freq	7.500000000 GHz
Start Freq	5.000000000 GHz
Stop Freq	10.000000000 GHz
CF Step	500.0000000 MHz
Freq Offset	0 Hz

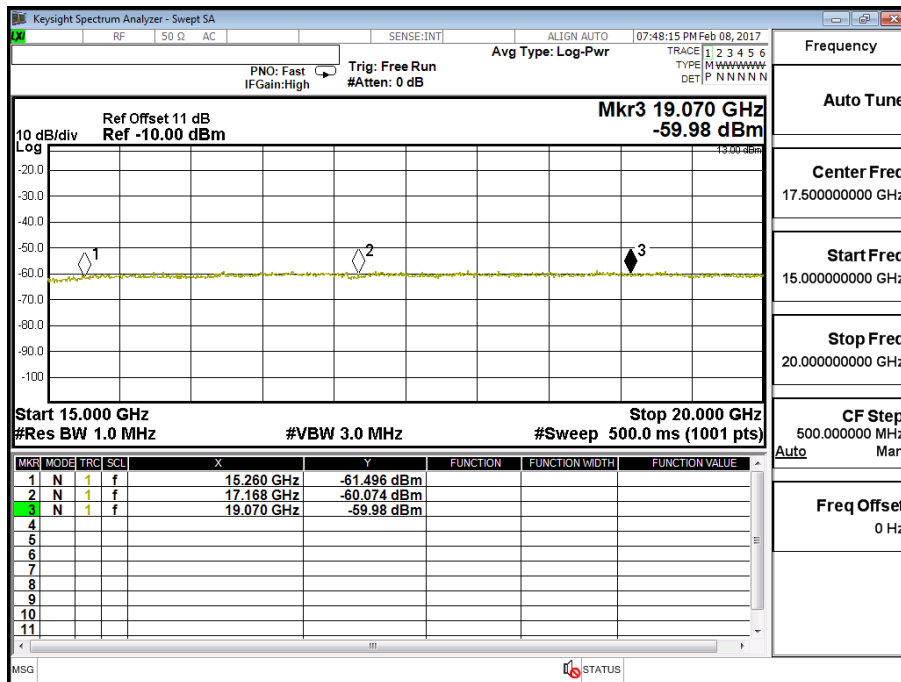
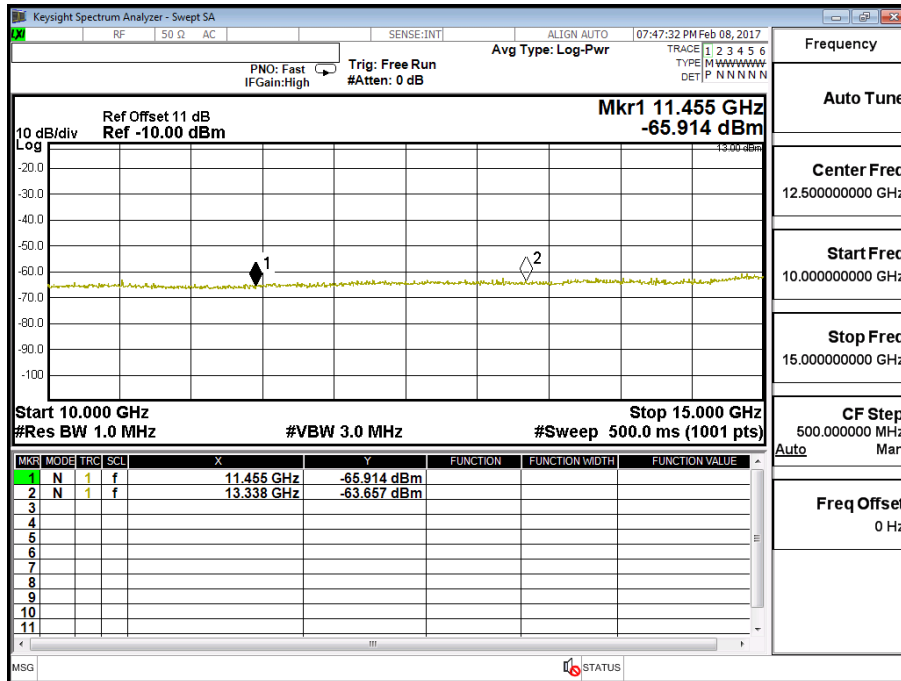

Product	LE910C1-NA		
Test Mode	Spurious Emission (Conducted)		
Date of Test	2017/02/08	Test Site	CTR
Test Condition	LTE-Band 2 (10M)	Test Range	30MHz~20GHz

LTE- Band 2 (10M) QPSK(1,24) CH18650 (1855MHz)

Frequency (MHz)	Reading Level (dBm)	Path Loss (dB)	Emission Level (dBm)	Limit (dBm)
3700	-55.960	1.1	-54.860	-13
5550	-54.620	1.23	-53.390	-13
7405	-57.280	1.59	-55.690	-13
9255	-64.530	1.89	-62.640	-13
11130	-65.001	2.07	-62.931	-13
12985	-64.342	2.26	-62.082	-13
14840	-61.984	2.64	-59.344	-13
16685	-59.370	3.5	-55.870	-13
18550	-60.289	3.7	-56.589	-13

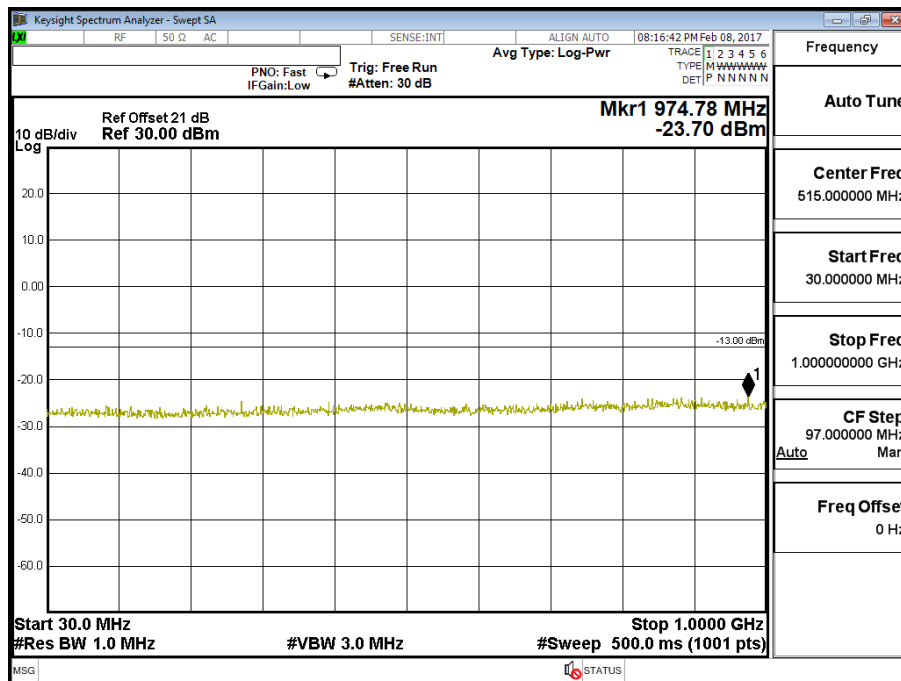

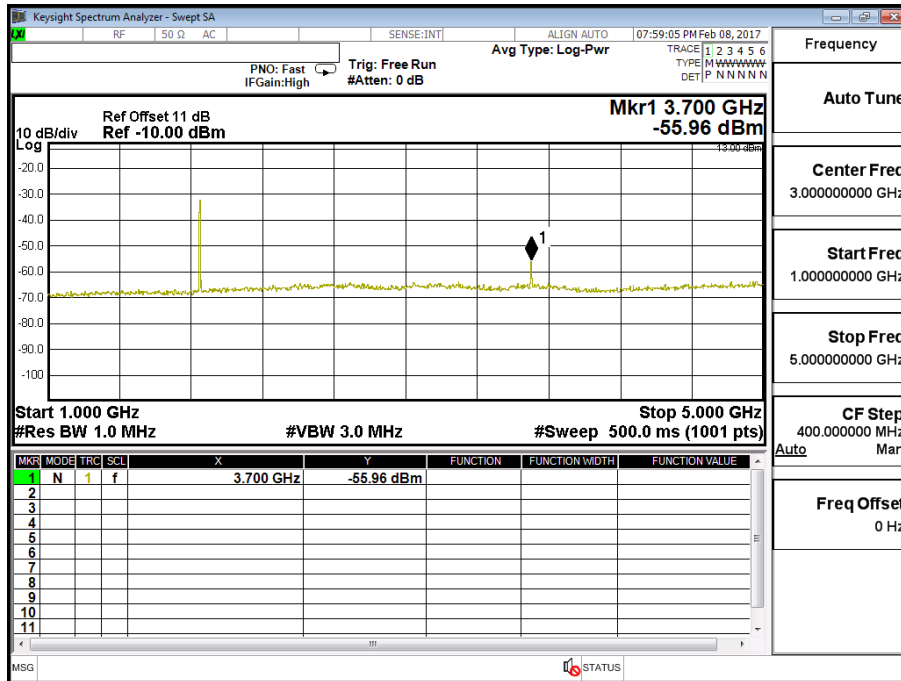

Frequency	Auto Tune
Center Freq	3.000000000 GHz
Start Freq	1.000000000 GHz
Stop Freq	5.000000000 GHz
CF Step	400.0000000 MHz
Auto Man	Auto
Freq Offset	0 Hz

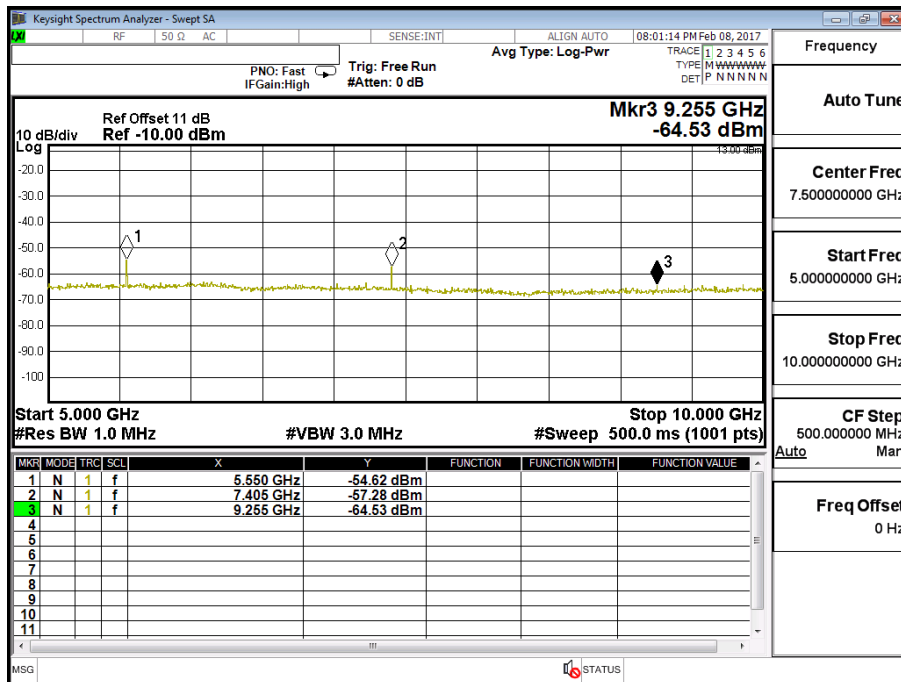

Frequency	Auto Tune
Center Freq	7.500000000 GHz
Start Freq	5.000000000 GHz
Stop Freq	10.000000000 GHz
CF Step	500.0000000 MHz
Auto Man	Auto
Freq Offset	0 Hz

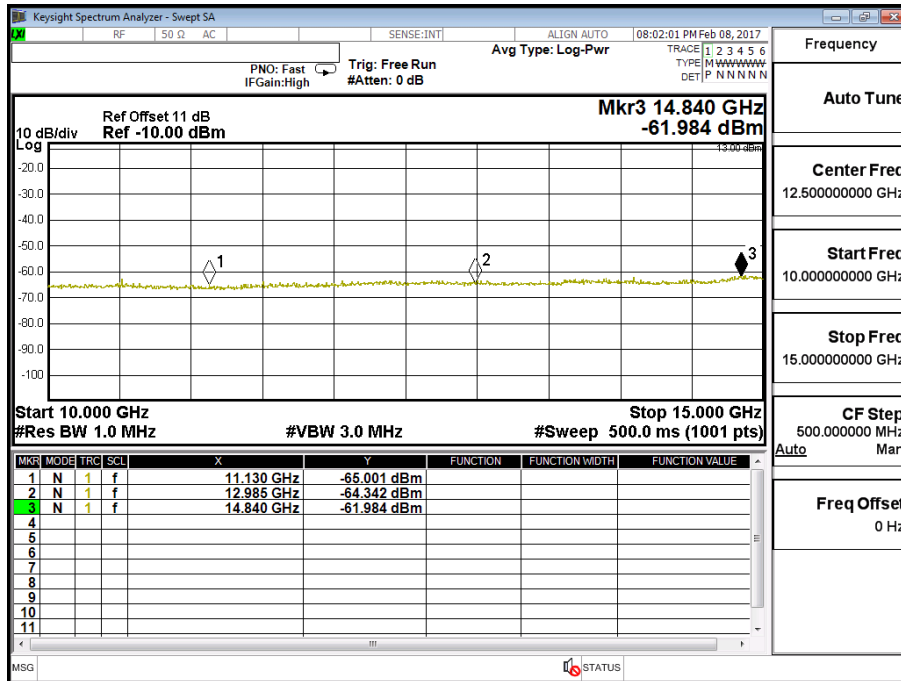

Frequency	Auto Tune
Center Freq	12.500000000 GHz
Start Freq	10.000000000 GHz
Stop Freq	15.000000000 GHz
CF Step	500.0000000 MHz
	Auto Man
Freq Offset	0 Hz

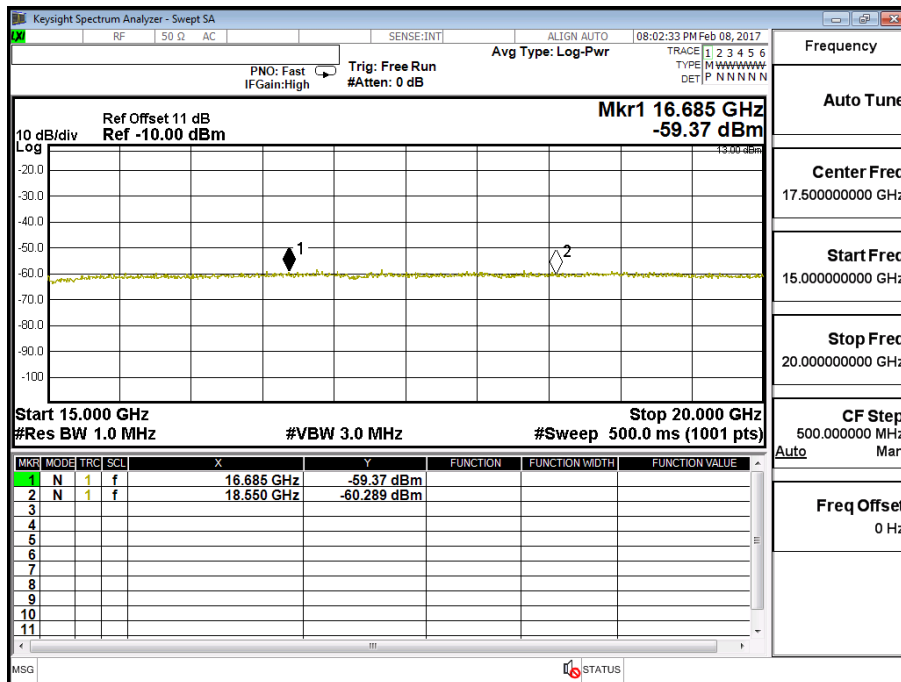

Frequency	Auto Tune
Center Freq	17.500000000 GHz
Start Freq	15.000000000 GHz
Stop Freq	20.000000000 GHz
CF Step	500.0000000 MHz
	Auto Man
Freq Offset	0 Hz

Product	LE910C1-NA		
Test Mode	Spurious Emission (Conducted)		
Date of Test	2017/02/08	Test Site	CTR
Test Condition	LTE-Band 4 (1.4M)	Test Range	30MHz~20GHz

LTE-Band 4 (1.4M) QPSK(3,2) CH19957 (1710.7MHz)

Frequency (MHz)	Reading Level (dBm)	Path Loss (dB)	Emission Level (dBm)	Limit (dBm)
3421	-49.920	1.1	-48.820	-13
5130	-42.625	1.23	-41.394	-13
6843	-47.354	1.59	-45.764	-13
8554	-44.309	1.89	-42.419	-13
10264	-66.139	2.07	-64.069	-13
11975	-66.340	2.26	-64.080	-13
13686	-64.073	2.64	-61.433	-13
15396	-61.280	3.5	-57.780	-13
17107	-61.809	3.7	-58.109	-13

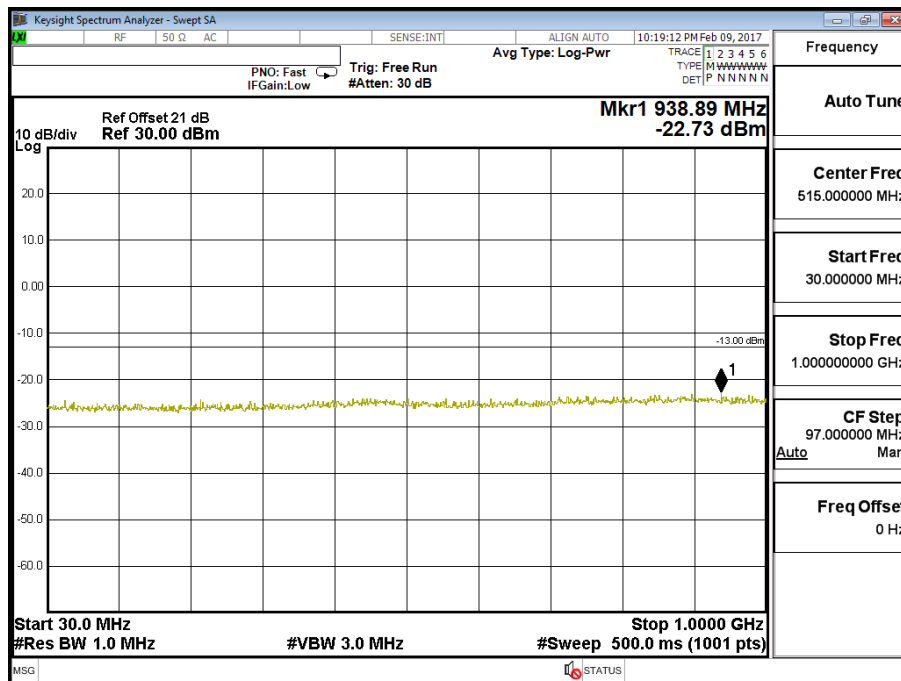

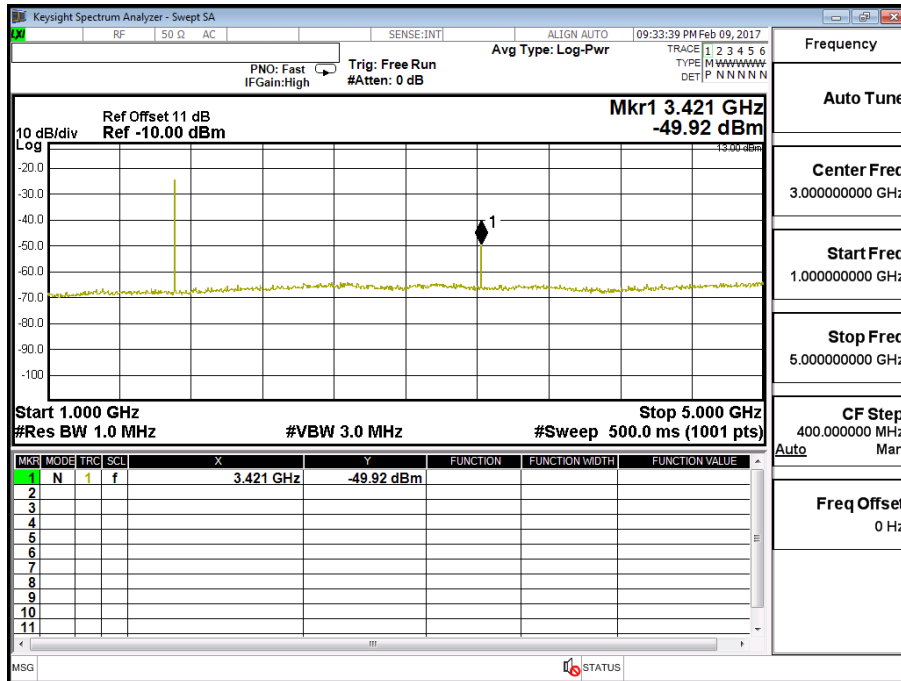

Frequency	Auto Tune
Center Freq	3.000000000 GHz
Start Freq	1.000000000 GHz
Stop Freq	5.000000000 GHz
CF Step	400.0000000 MHz
	Auto Man
Freq Offset	0 Hz

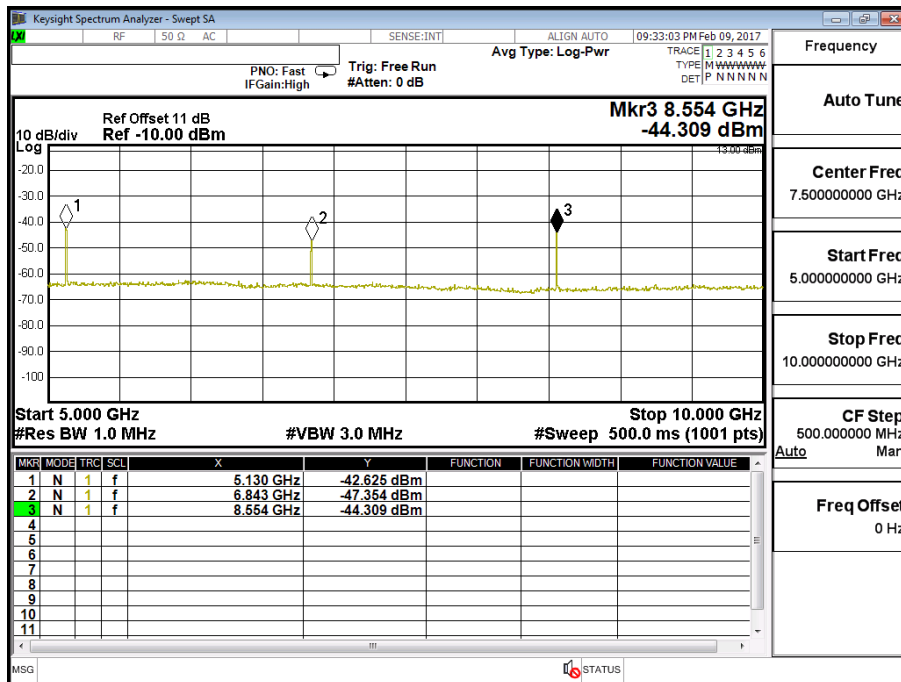

Frequency	Auto Tune
Center Freq	7.500000000 GHz
Start Freq	5.000000000 GHz
Stop Freq	10.000000000 GHz
CF Step	500.0000000 MHz
	Auto Man
Freq Offset	0 Hz

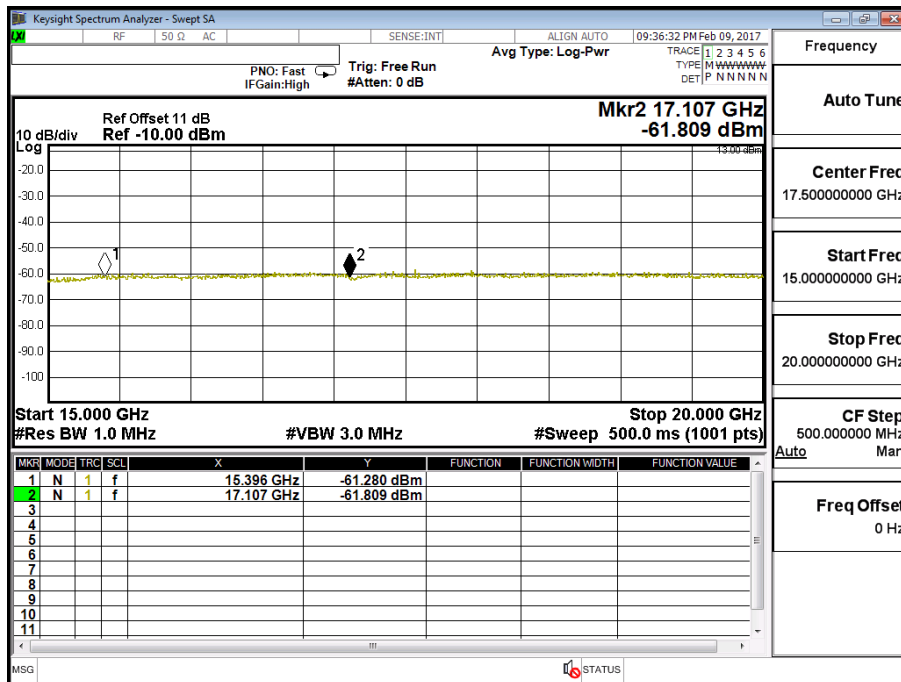
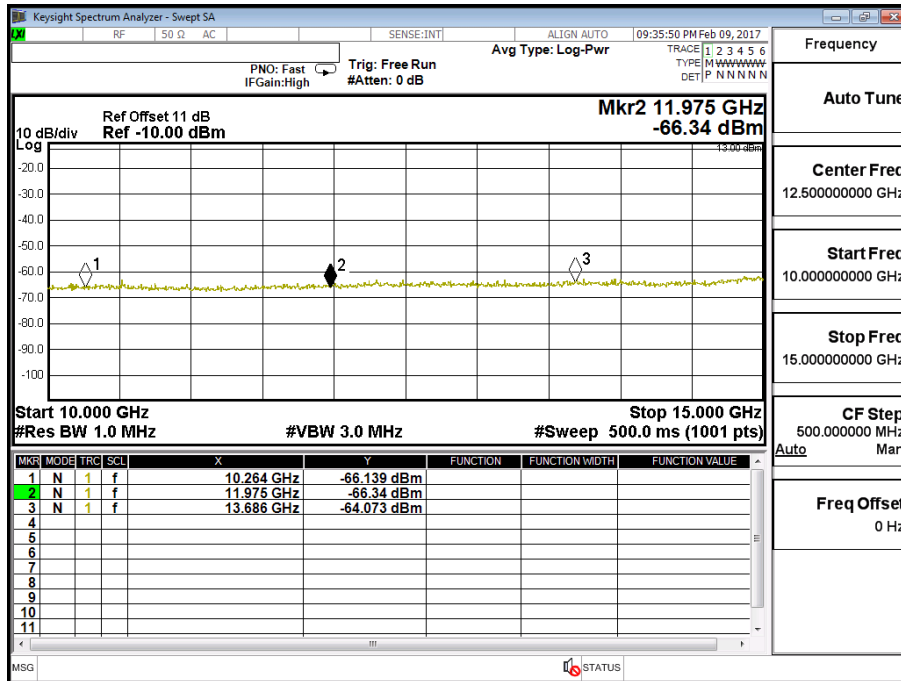

Product	LE910C1-NA		
Test Mode	Spurious Emission (Conducted)		
Date of Test	2017/02/08	Test Site	CTR
Test Condition	LTE-Band 4 (1.4M)	Test Range	30MHz~20GHz

LTE-Band 4 (1.4M) 16QAM(3,3) CH19957 (1710.7MHz)

Frequency (MHz)	Reading Level (dBm)	Path Loss (dB)	Emission Level (dBm)	Limit (dBm)
3421	-50.188	1.1	-49.088	-13
5135	-42.600	1.23	-41.370	-13
6843	-47.726	1.59	-46.136	-13
8554	-43.898	1.89	-42.008	-13
10264	-64.995	2.07	-62.925	-13
11975	-65.540	2.26	-63.280	-13
13686	-64.444	2.64	-61.804	-13
15396	-59.675	3.5	-56.175	-13
17107	-61.317	3.7	-57.617	-13

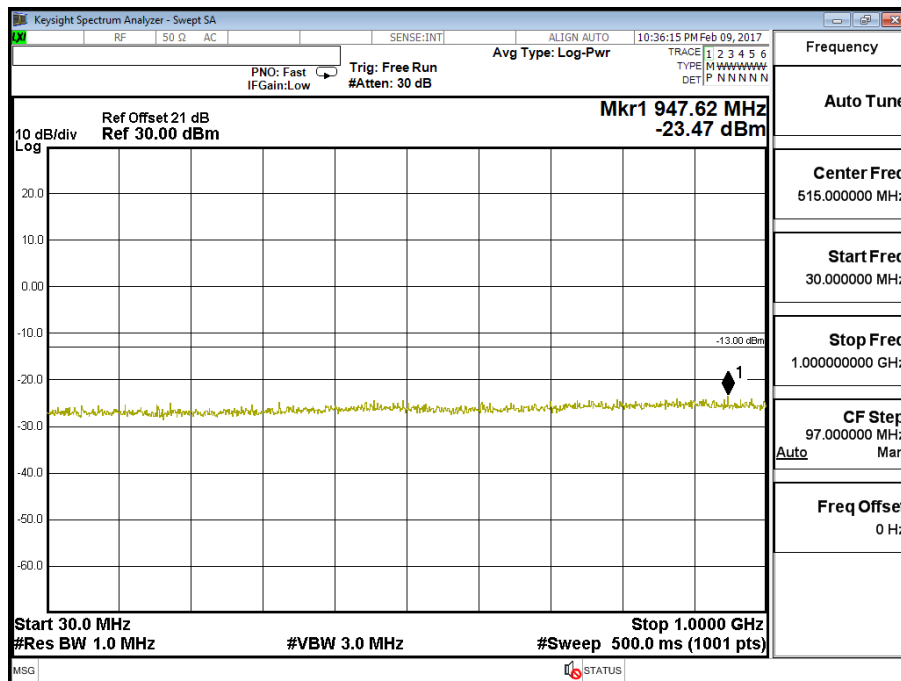

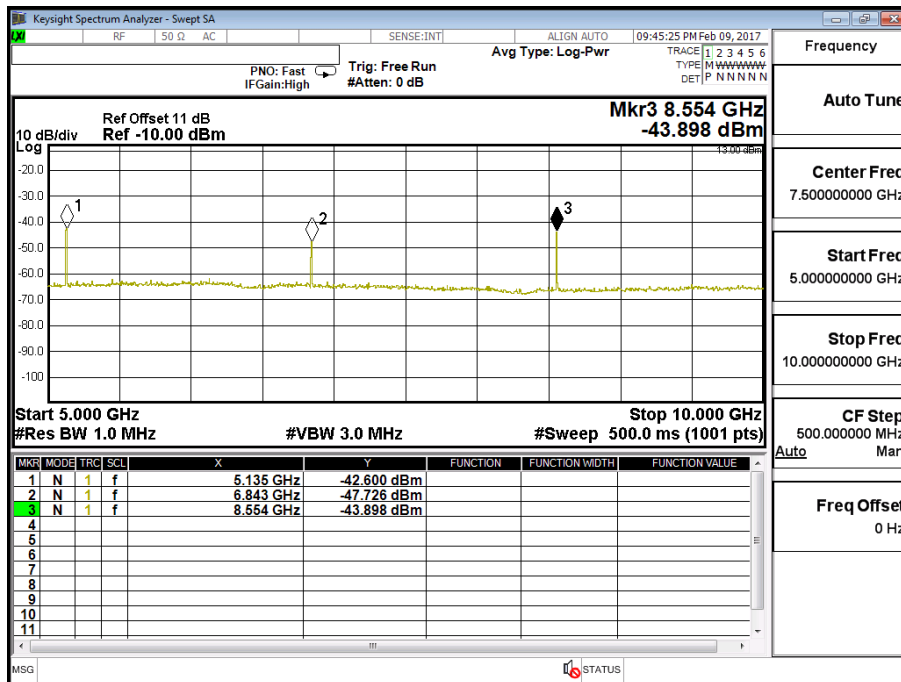
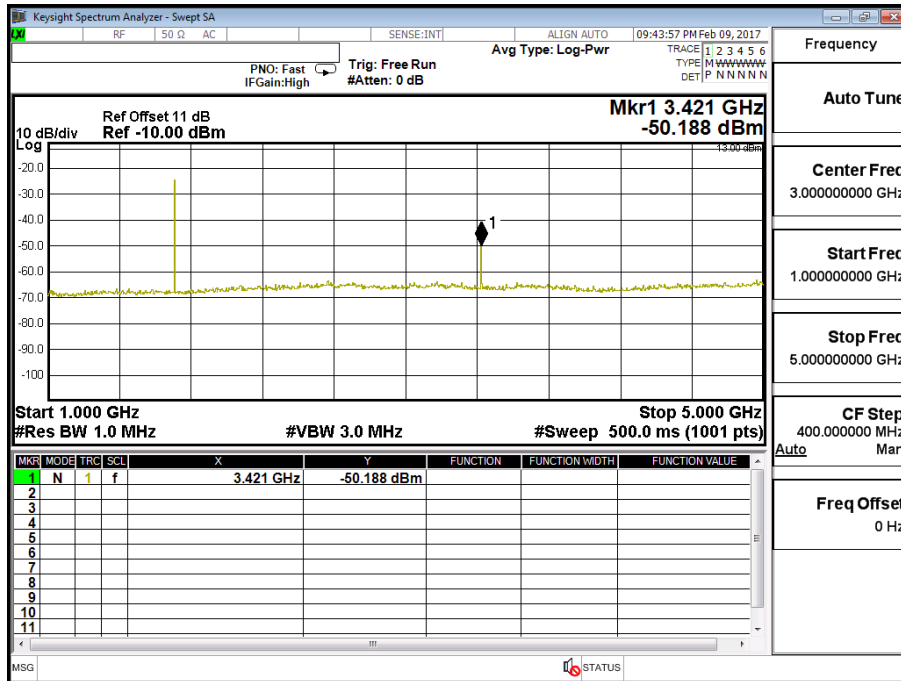

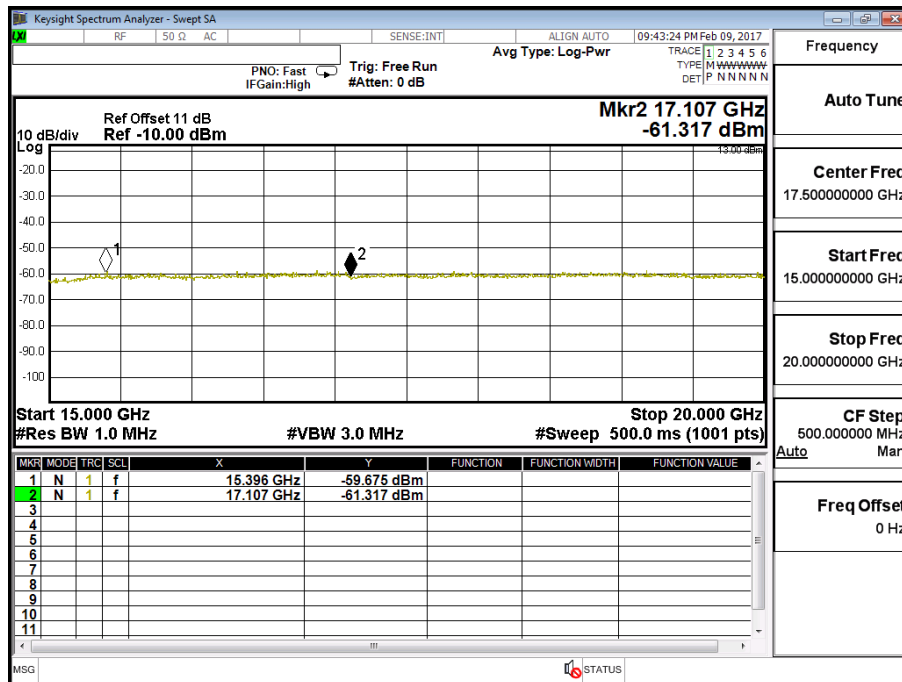
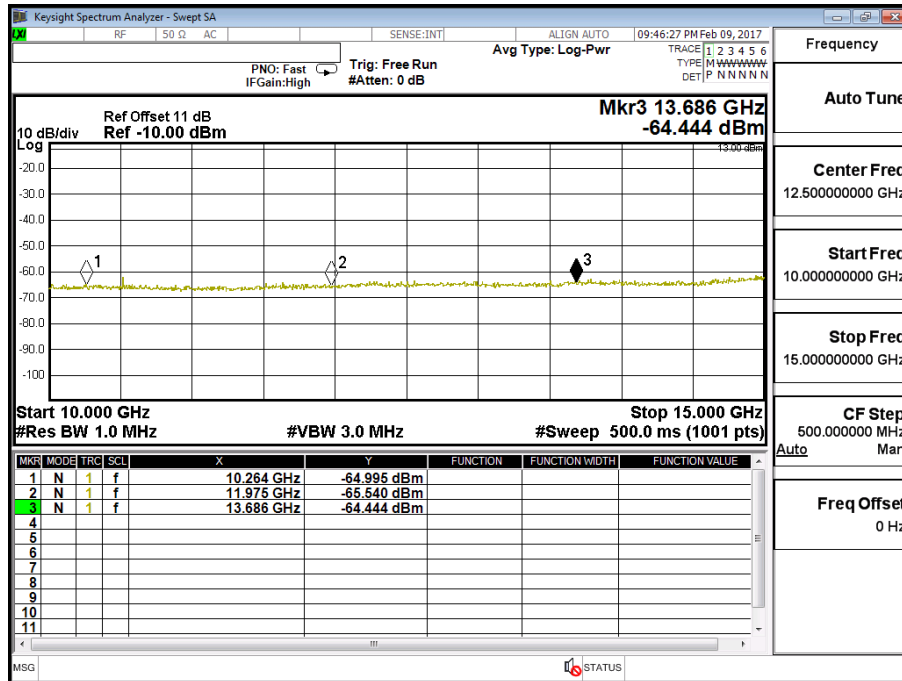

Product	LE910C1-NA		
Test Mode	Spurious Emission (Conducted)		
Date of Test	2017/02/08	Test Site	CTR
Test Condition	LTE-Band 4 (3M)	Test Range	30MHz~20GHz

LTE-Band 4 (3M) QPSK(1,7) CH19965 (1711.5MHz)

Frequency (MHz)	Reading Level (dBm)	Path Loss (dB)	Emission Level (dBm)	Limit (dBm)
3423	-49.796	1.1	-48.696	-13
5135	-43.400	1.23	-42.170	-13
6846	-48.690	1.59	-47.100	-13
8558	-43.110	1.89	-41.220	-13
10269	-65.639	2.07	-63.569	-13
11981	-64.476	2.26	-62.216	-13
13692	-64.334	2.64	-61.694	-13
15404	-61.596	3.5	-58.096	-13
17115	-61.317	3.7	-57.617	-13

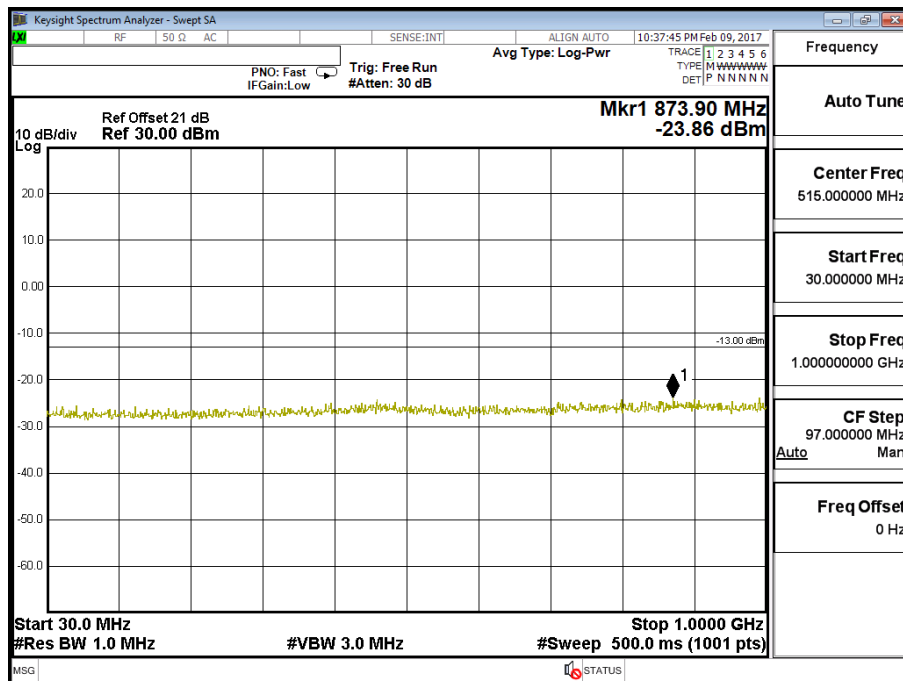

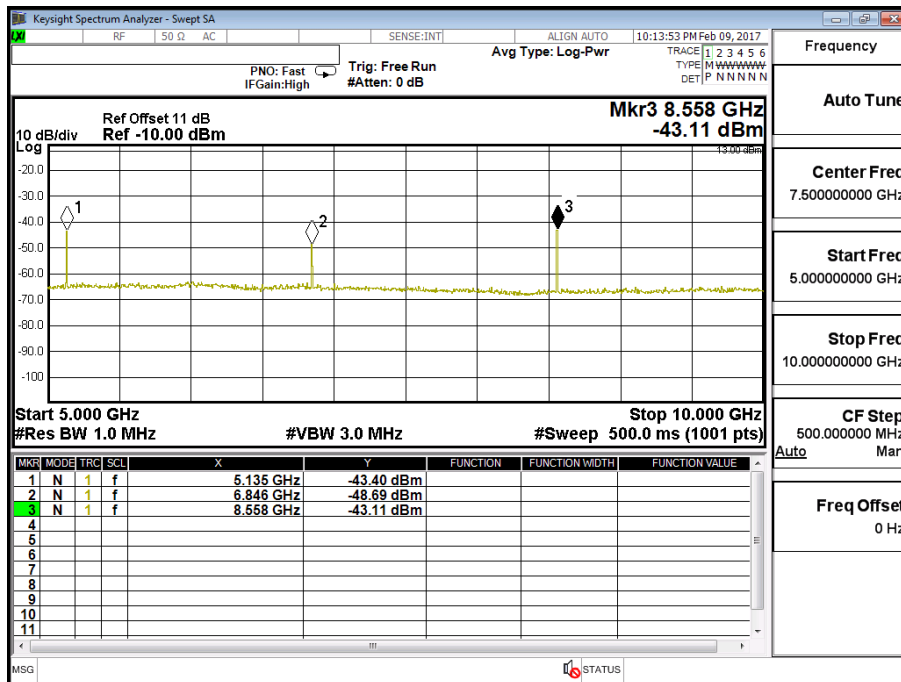
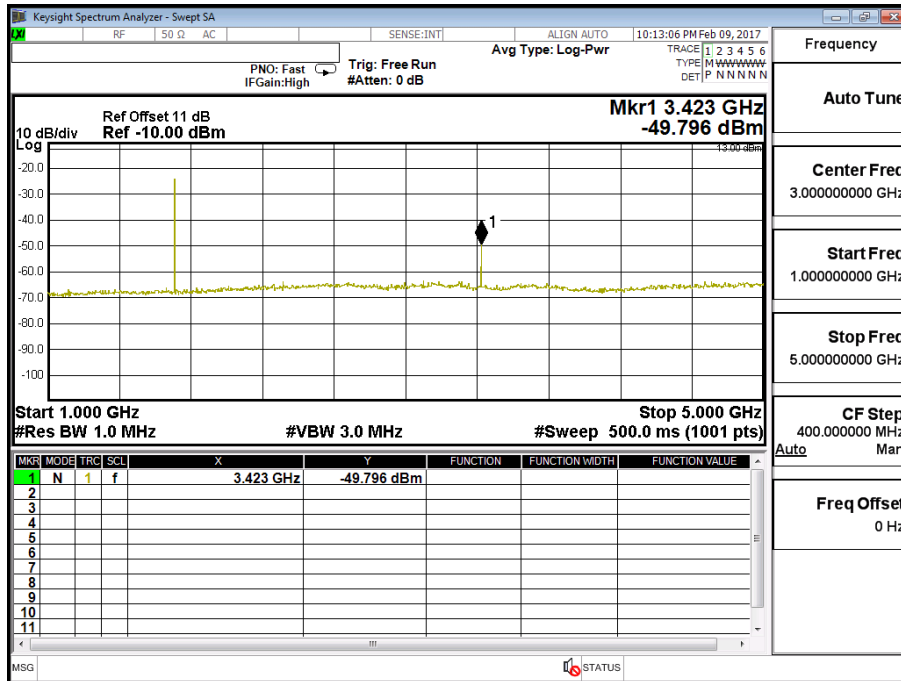

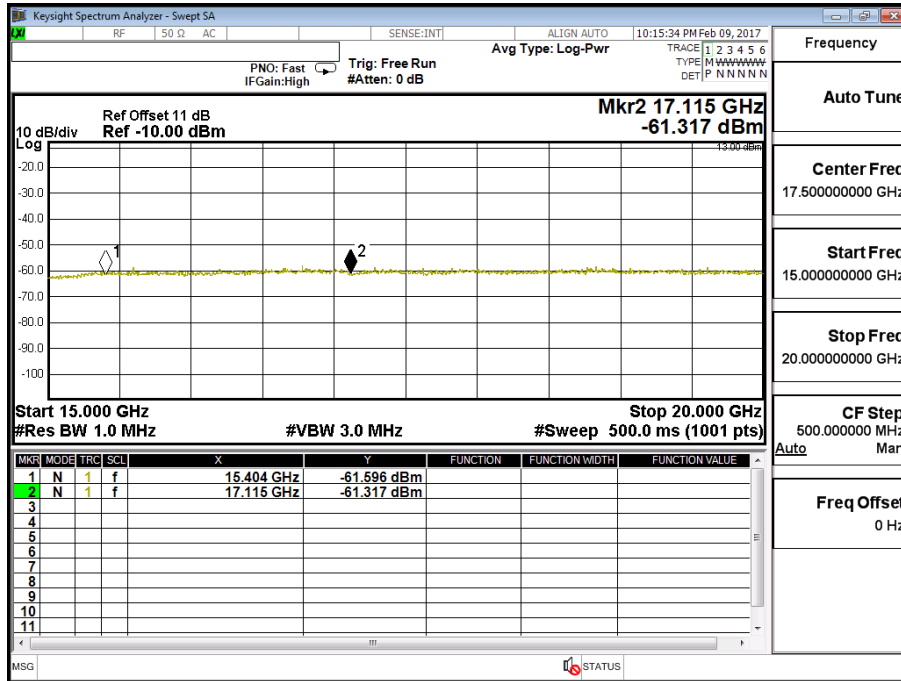
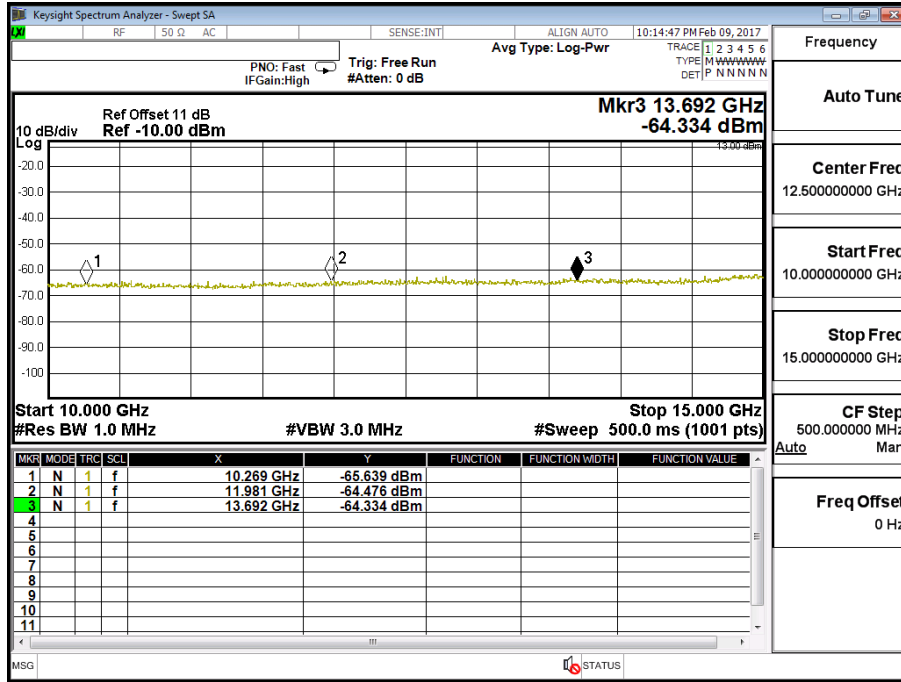

Product	LE910C1-NA		
Test Mode	Spurious Emission (Conducted)		
Date of Test	2017/02/08	Test Site	CTR
Test Condition	LTE-Band 4 (3M)	Test Range	30MHz~20GHz

LTE-Band 4 (3M) 16QAM(1,0) CH19965 (1711.5MHz)

Frequency (MHz)	Reading Level (dBm)	Path Loss (dB)	Emission Level (dBm)	Limit (dBm)
3424	-53.500	1.1	-52.400	-13
5130	-41.669	1.23	-40.439	-13
6840	-47.599	1.59	-46.009	-13
8550	-43.279	1.89	-41.389	-13
10269	-65.798	2.07	-63.728	-13
11981	-65.511	2.26	-63.251	-13
13692	-63.935	2.64	-61.295	-13
15409	-59.980	3.5	-56.480	-13
17115	-61.600	3.7	-57.900	-13

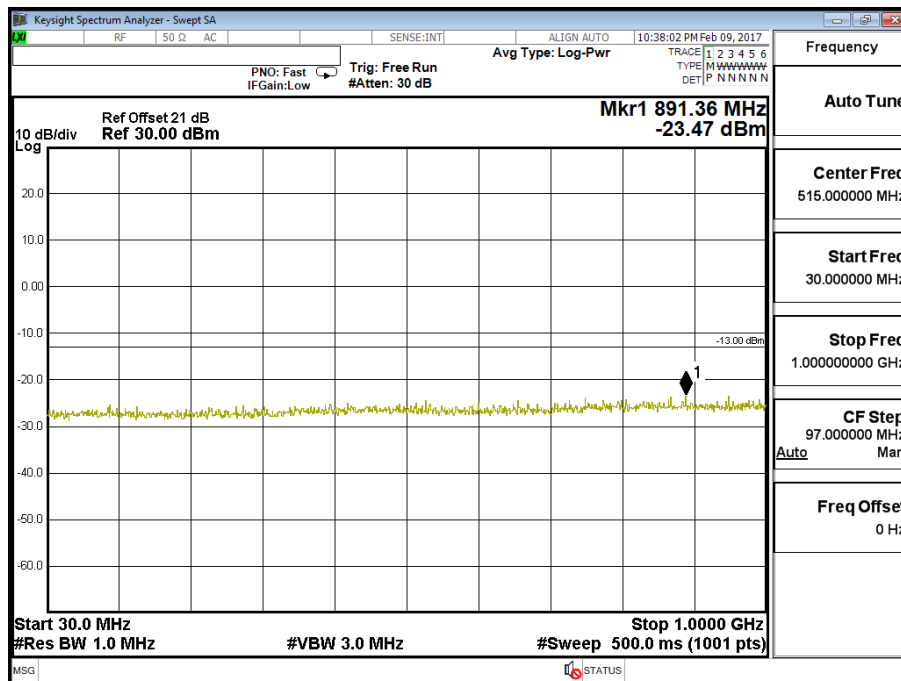

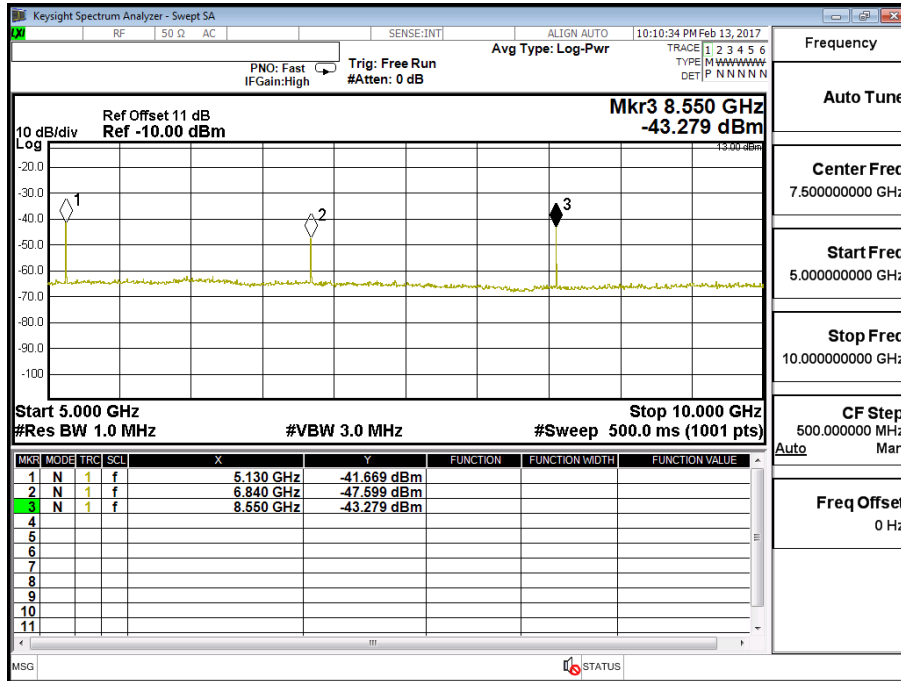
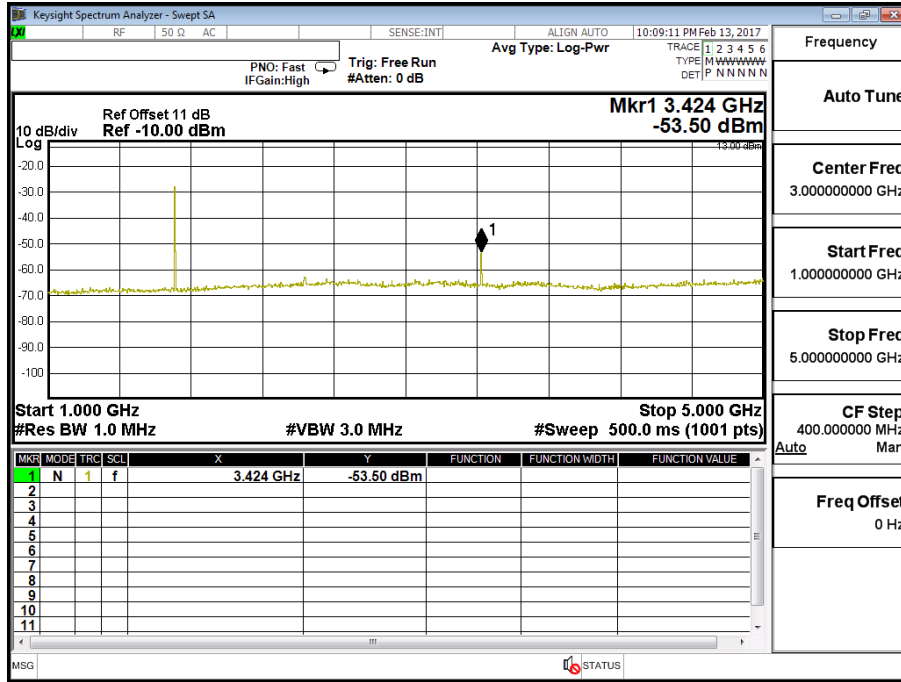

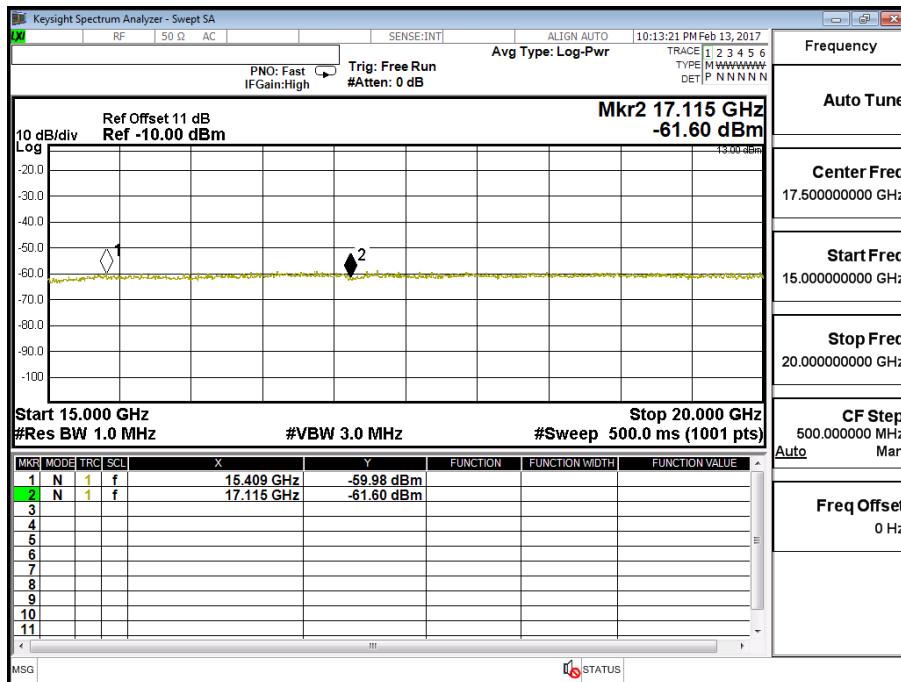
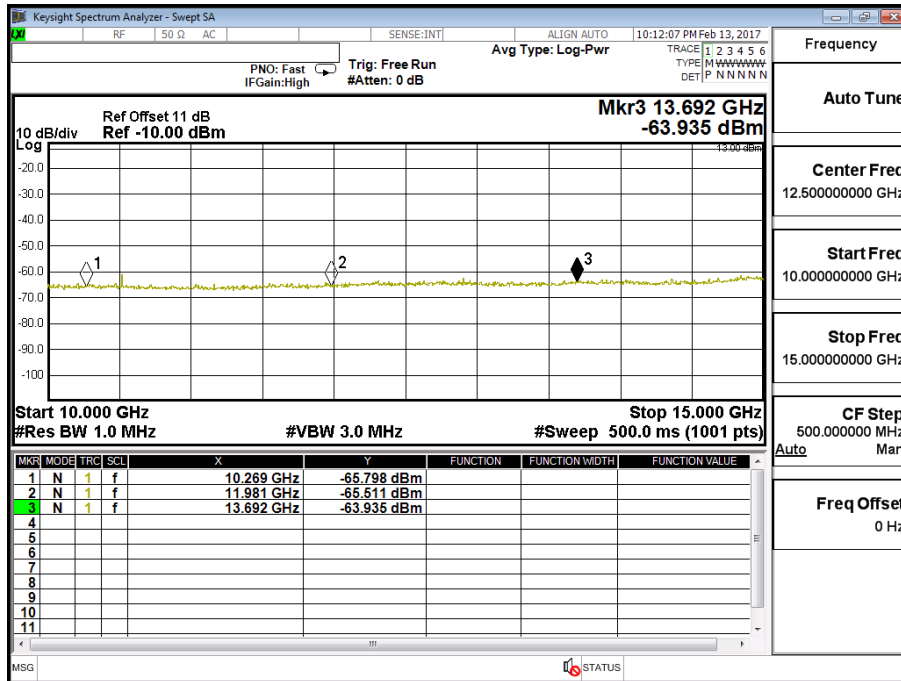

Product	LE910C1-NA		
Test Mode	Spurious Emission (Conducted)		
Date of Test	2017/02/08	Test Site	CTR
Test Condition	LTE-Band 4 (5M)	Test Range	30MHz~20GHz

LTE-Band 4 (5M) QPSK(1,0) CH19975 (1712.5MHz)

Frequency (MHz)	Reading Level (dBm)	Path Loss (dB)	Emission Level (dBm)	Limit (dBm)
3420	-50.460	1.1	-49.360	-13
5130	-42.324	1.23	-41.094	-13
6840	-49.146	1.59	-47.556	-13
8550	-43.547	1.89	-41.657	-13
10275	-65.895	2.07	-63.825	-13
11988	-65.746	2.26	-63.486	-13
13700	-64.585	2.64	-61.945	-13
15413	-61.105	3.5	-57.605	-13
17125	-61.323	3.7	-57.623	-13

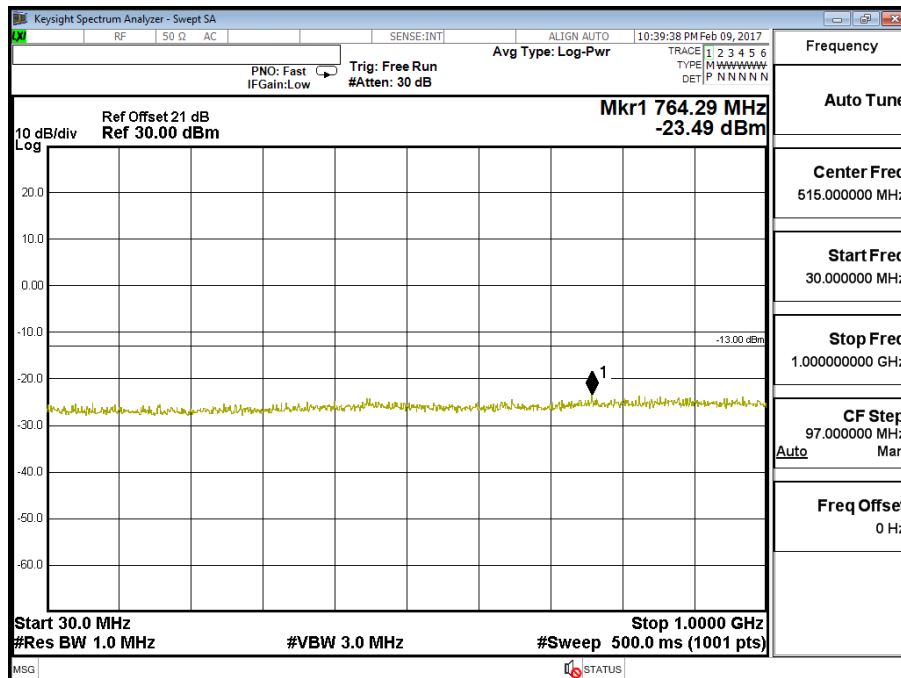

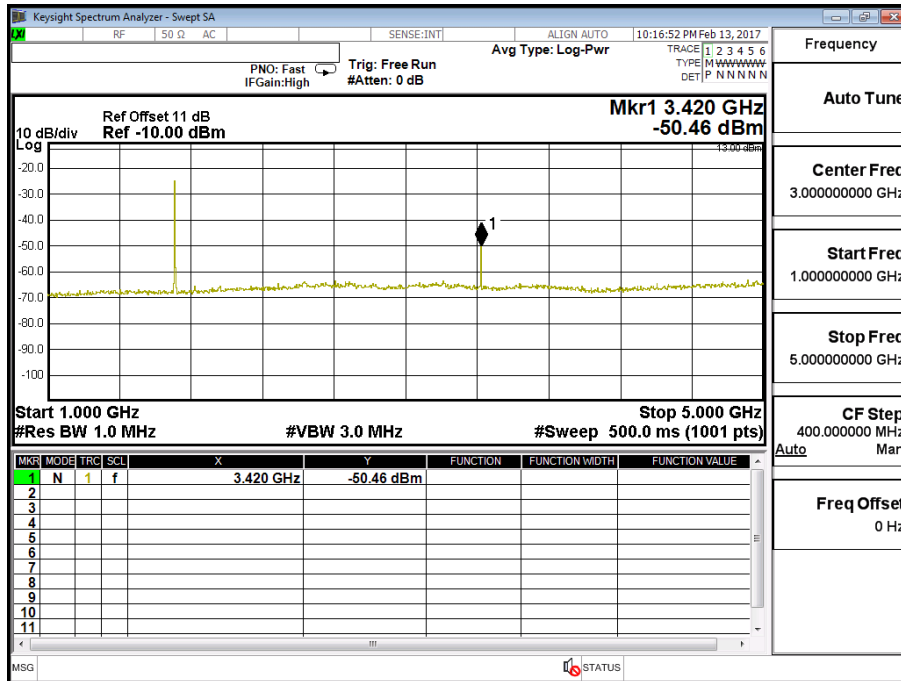

Frequency	
Auto Tune	
Center Freq	3.00000000 GHz
Start Freq	1.00000000 GHz
Stop Freq	5.00000000 GHz
CF Step	400.000000 MHz
	Auto Man
Freq Offset	0 Hz

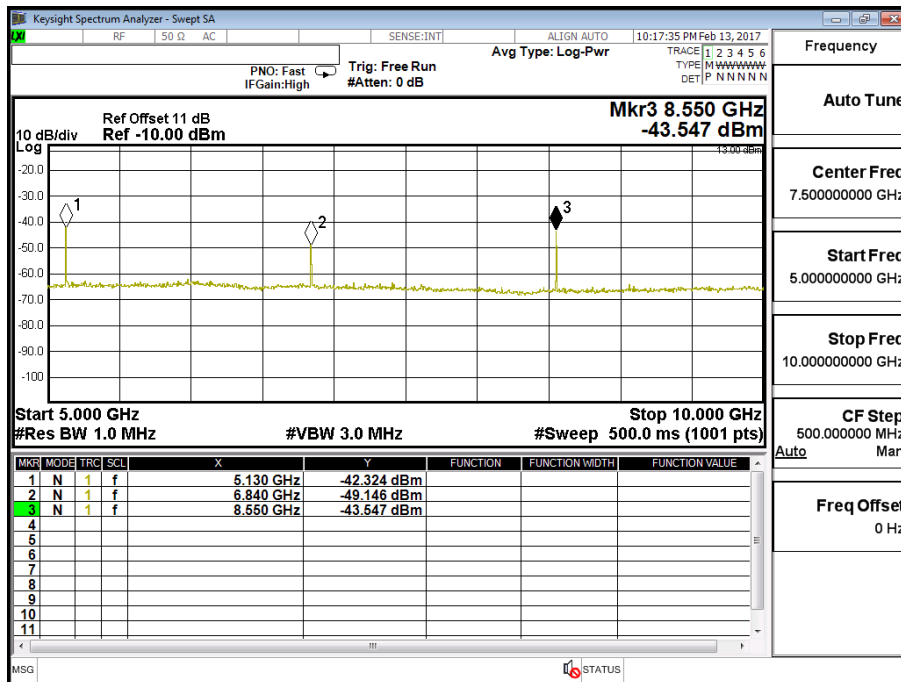

Frequency	
Auto Tune	
Center Freq	7.50000000 GHz
Start Freq	5.00000000 GHz
Stop Freq	10.00000000 GHz
CF Step	500.000000 MHz
	Auto Man
Freq Offset	0 Hz

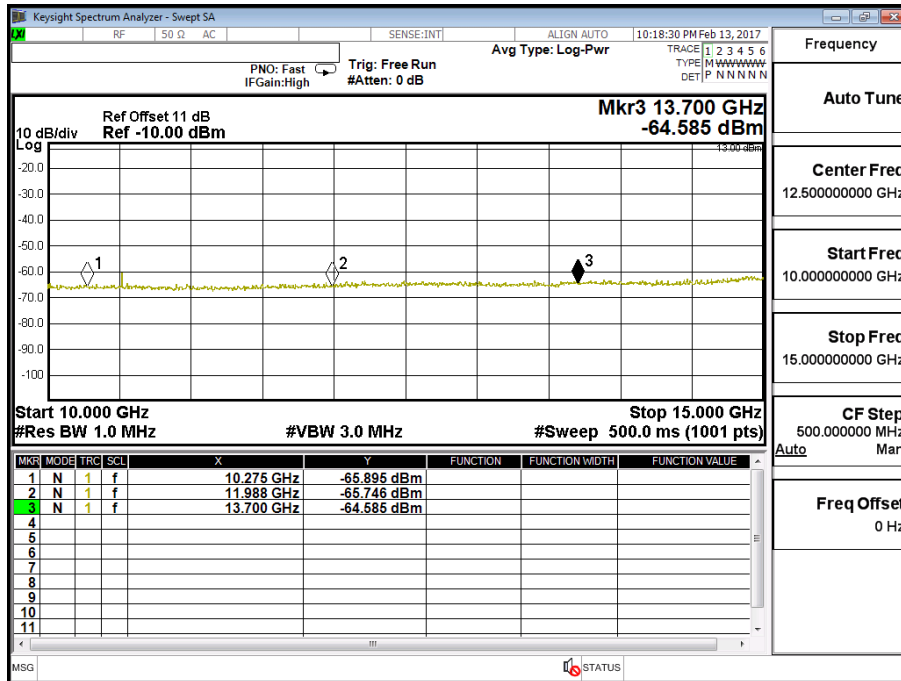

Frequency	Auto Tune
Center Freq	12.500000000 GHz
Start Freq	10.000000000 GHz
Stop Freq	15.000000000 GHz
CF Step	500.0000000 MHz
	Auto Man
Freq Offset	0 Hz

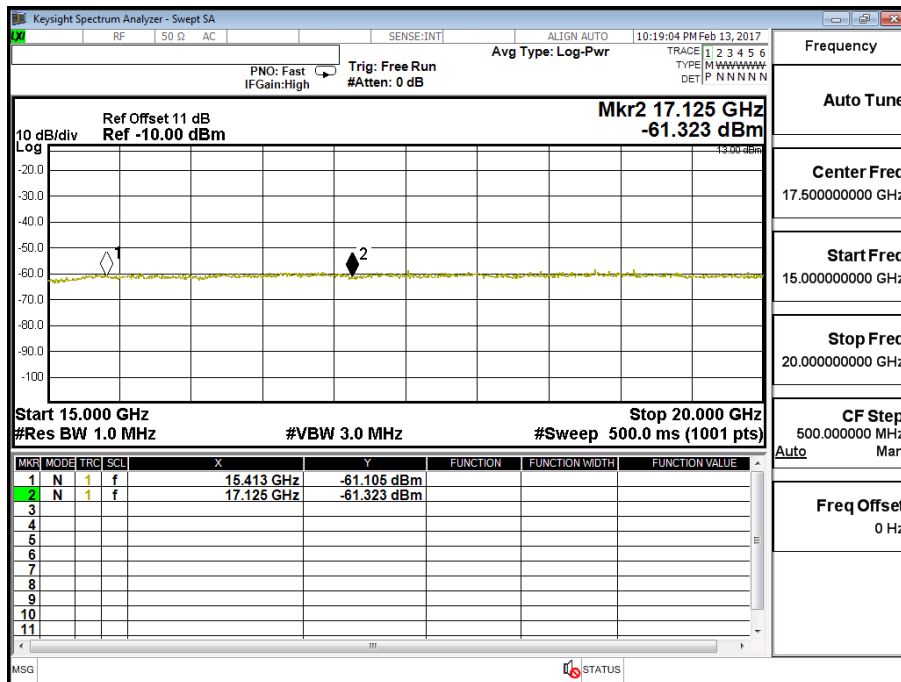

Frequency	Auto Tune
Center Freq	17.500000000 GHz
Start Freq	15.000000000 GHz
Stop Freq	20.000000000 GHz
CF Step	500.0000000 MHz
	Auto Man
Freq Offset	0 Hz

Product	LE910C1-NA		
Test Mode	Spurious Emission (Conducted)		
Date of Test	2017/02/08	Test Site	CTR
Test Condition	LTE-Band 4 (5M)	Test Range	30MHz~20GHz

LTE- Band 4 (5M) 16QAM(1,0) CH19975 (1712.5MHz)

Frequency (MHz)	Reading Level (dBm)	Path Loss (dB)	Emission Level (dBm)	Limit (dBm)
3420	-50.190	1.1	-49.090	-13
5130	-43.070	1.23	-41.840	-13
6840	-50.461	1.59	-48.871	-13
8550	-43.372	1.89	-41.482	-13
10275	-65.161	2.07	-63.091	-13
11988	-64.624	2.26	-62.364	-13
13705	-63.591	2.64	-60.951	-13
15413	-61.672	3.5	-58.172	-13
17125	-61.545	3.7	-57.845	-13

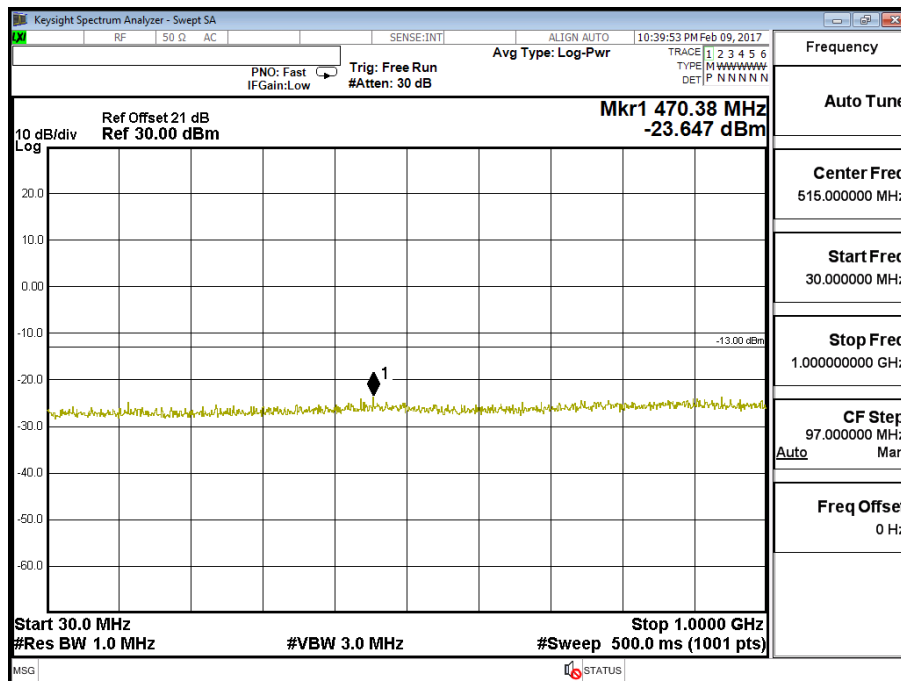

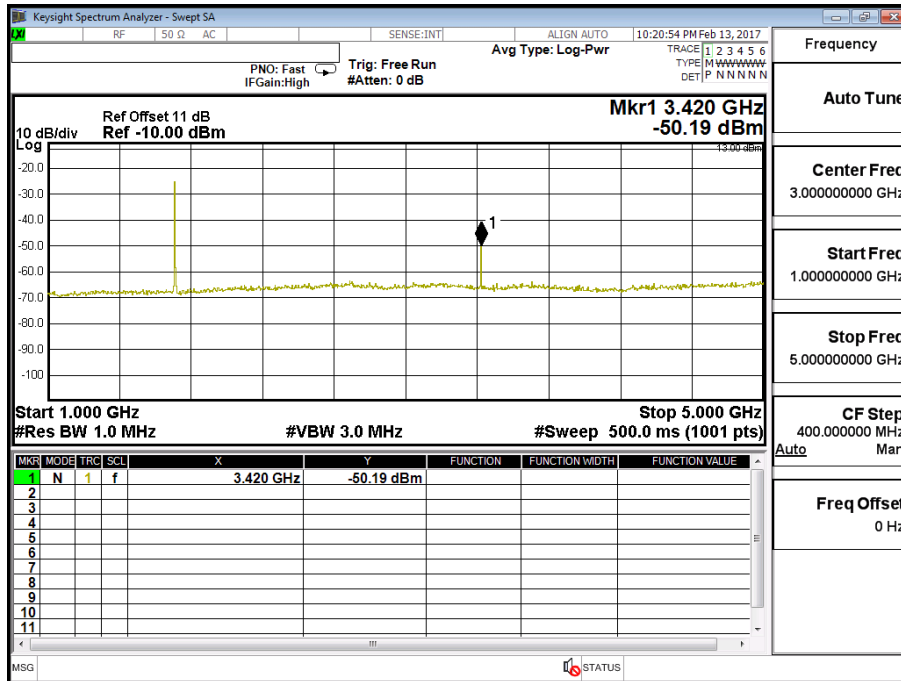

Frequency	Auto Tune
Center Freq	3.000000000 GHz
Start Freq	1.000000000 GHz
Stop Freq	5.000000000 GHz
CF Step	400.0000000 MHz
Auto Man	Man
Freq Offset	0 Hz

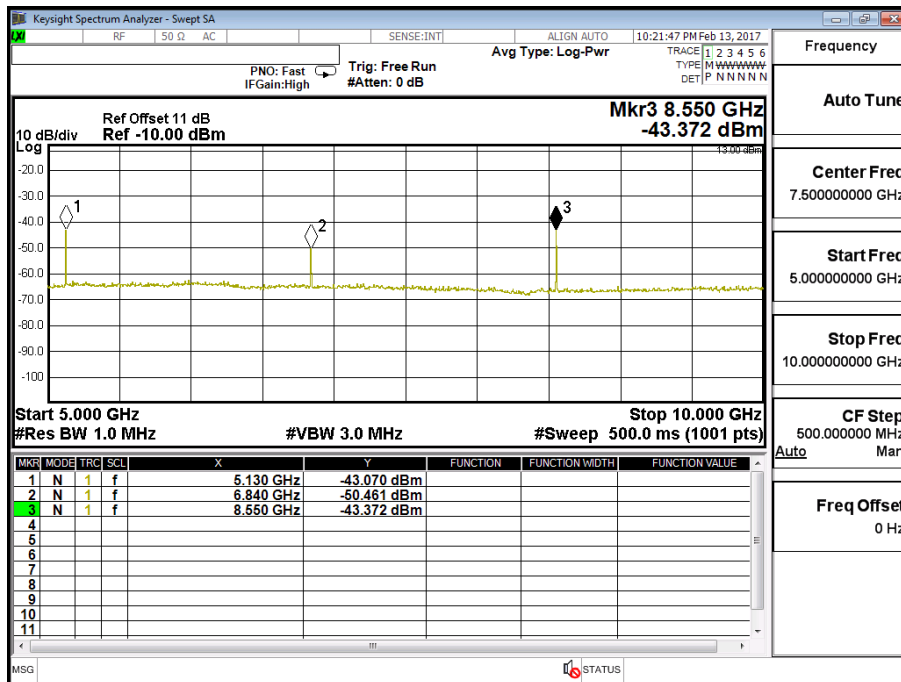

Frequency	Auto Tune
Center Freq	7.500000000 GHz
Start Freq	5.000000000 GHz
Stop Freq	10.000000000 GHz
CF Step	500.0000000 MHz
Auto Man	Man
Freq Offset	0 Hz

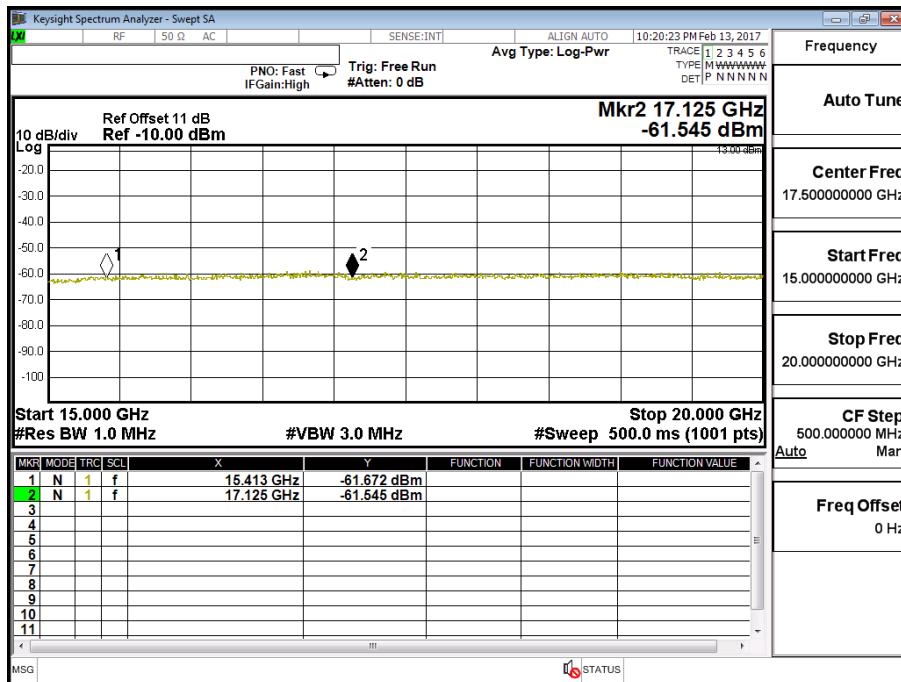
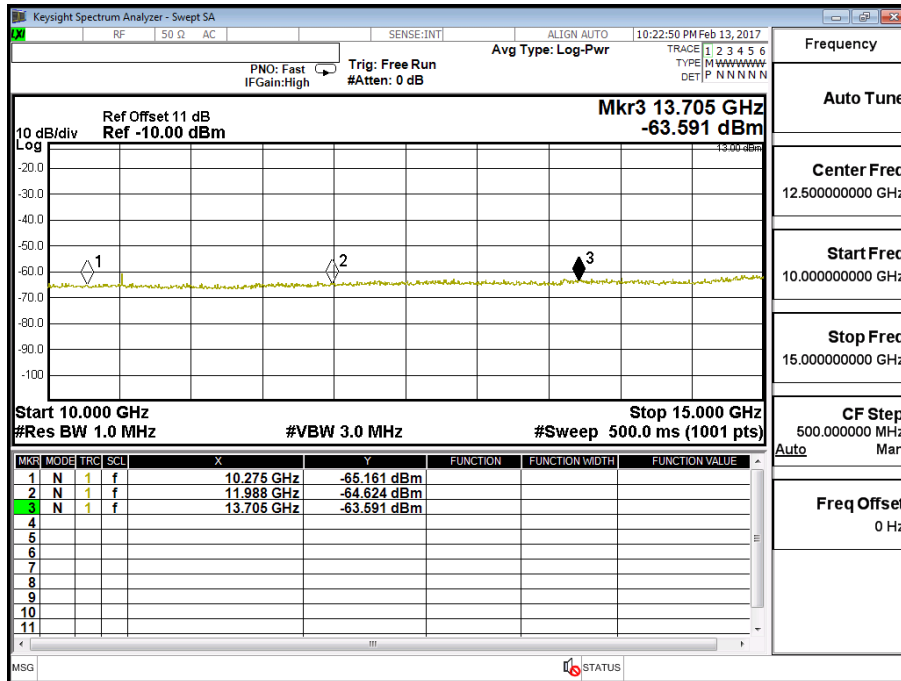

Product	LE910C1-NA		
Test Mode	Spurious Emission (Conducted)		
Date of Test	2017/02/08	Test Site	CTR
Test Condition	LTE-Band 4 (10M)	Test Range	30MHz~20GHz

LTE- Band 4 (10M) QPSK(1,24) CH20000 (1715MHz)

Frequency (MHz)	Reading Level (dBm)	Path Loss (dB)	Emission Level (dBm)	Limit (dBm)
3428	-51.350	1.1	-50.250	-13
5145	-44.469	1.23	-43.239	-13
6860	-48.842	1.59	-47.252	-13
8575	-44.975	1.89	-43.085	-13
10290	-63.826	2.07	-61.756	-13
12005	-64.004	2.26	-61.744	-13
13725	-63.360	2.64	-60.720	-13
15435	-61.457	3.5	-57.957	-13
17150	-61.030	3.7	-57.330	-13

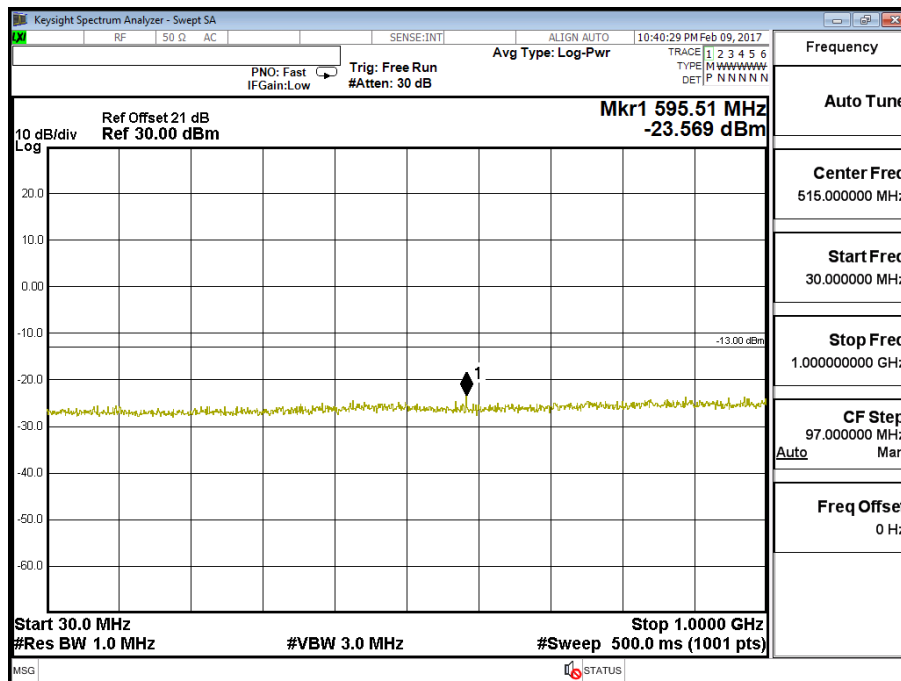

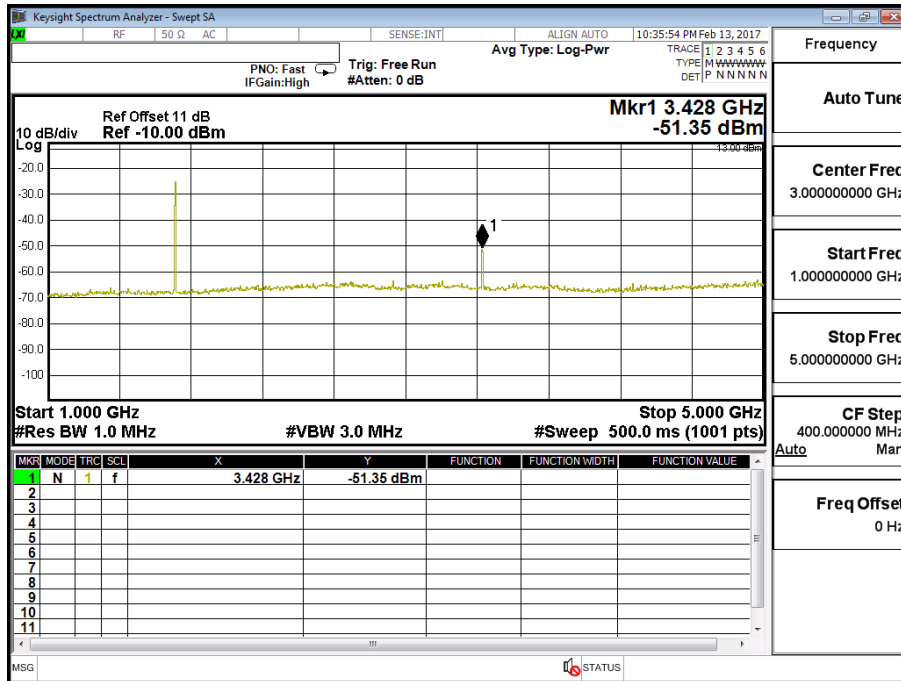

Frequency	Auto Tune
Center Freq	3.000000000 GHz
Start Freq	1.000000000 GHz
Stop Freq	5.000000000 GHz
CF Step	400.0000000 MHz
Freq Offset	0 Hz

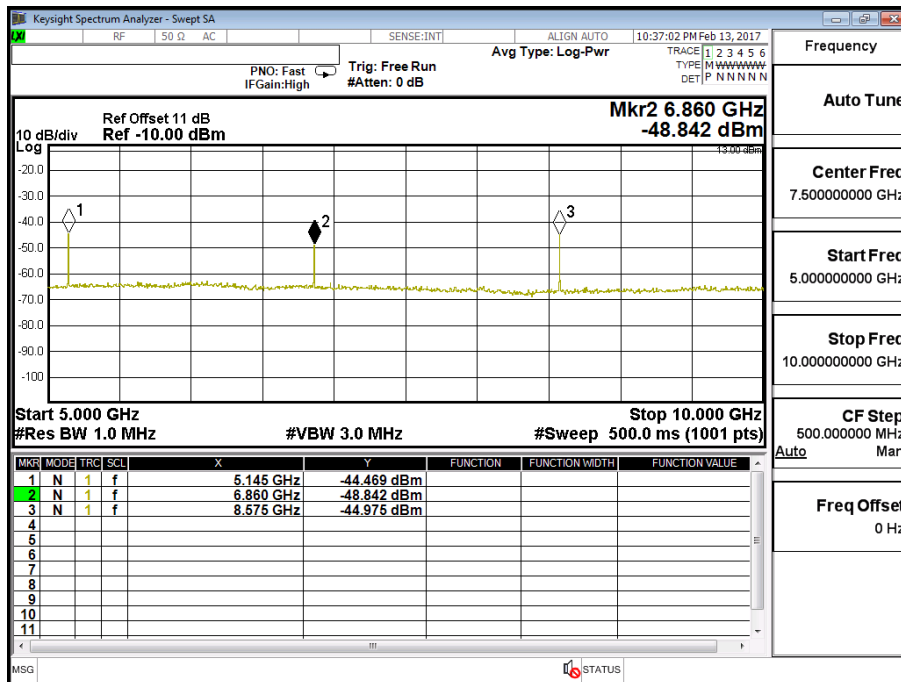

Frequency	Auto Tune
Center Freq	7.500000000 GHz
Start Freq	5.000000000 GHz
Stop Freq	10.000000000 GHz
CF Step	500.0000000 MHz
Freq Offset	0 Hz

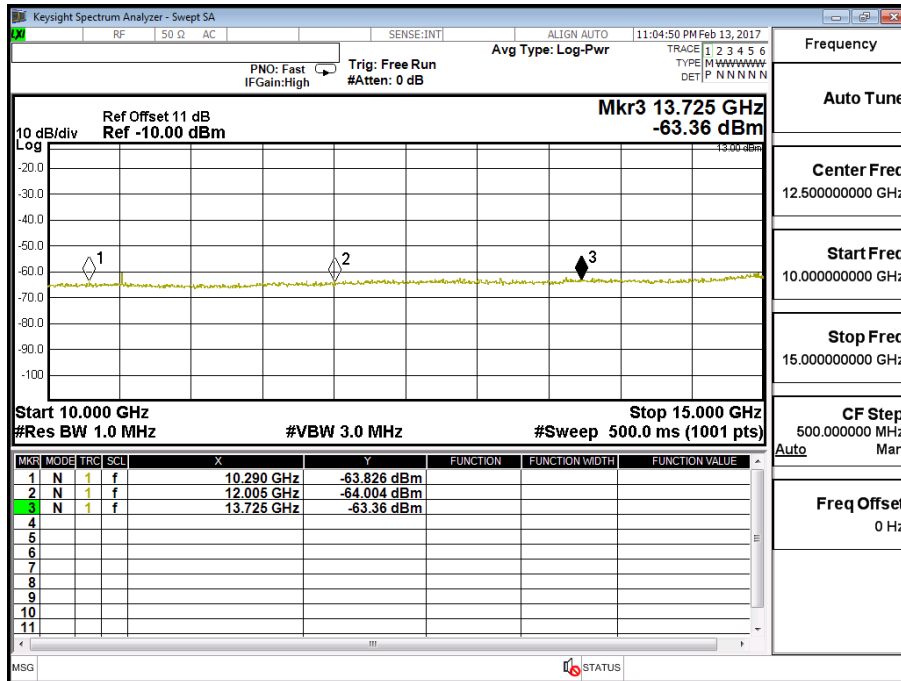

Frequency	Auto Tune
Center Freq	12.500000000 GHz
Start Freq	10.000000000 GHz
Stop Freq	15.000000000 GHz
CF Step	500.0000000 MHz
	Auto Man
Freq Offset	0 Hz

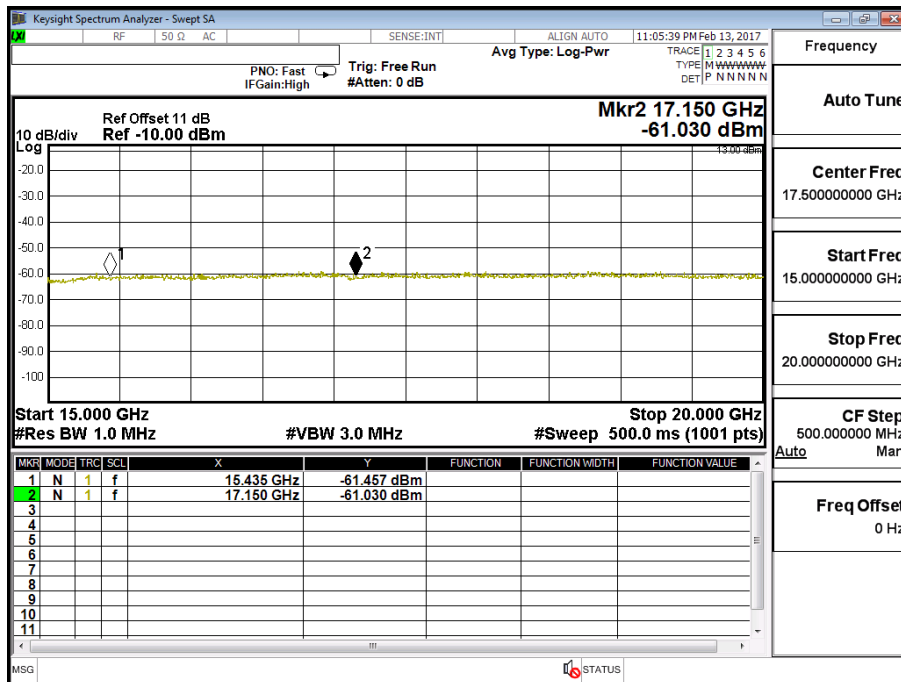

Frequency	Auto Tune
Center Freq	17.500000000 GHz
Start Freq	15.000000000 GHz
Stop Freq	20.000000000 GHz
CF Step	500.0000000 MHz
	Auto Man
Freq Offset	0 Hz

Product	LE910C1-NA		
Test Mode	Spurious Emission (Conducted)		
Date of Test	2017/02/08	Test Site	CTR
Test Condition	LTE-Band 12 (1.4M)	Test Range	30MHz~10GHz

LTE-Band 12 (1.4M) QPSK(3,3) CH23173 (715.3MHz)

Frequency (MHz)	Reading Level (dBm)	Path Loss (dB)	Emission Level (dBm)	Limit (dBm)
1431	-56.913	0.58	-56.333	-13
2146	-62.868	0.7	-62.168	-13
2864	-60.929	1.01	-59.919	-13
3577	-60.583	1.18	-59.403	-13
4294	-51.466	1.23	-50.236	-13
5007	-64.415	1.45	-62.965	-13
5722	-64.125	1.56	-62.565	-13
6438	-64.186	1.59	-62.596	-13
7153	-65.844	1.82	-64.024	-13

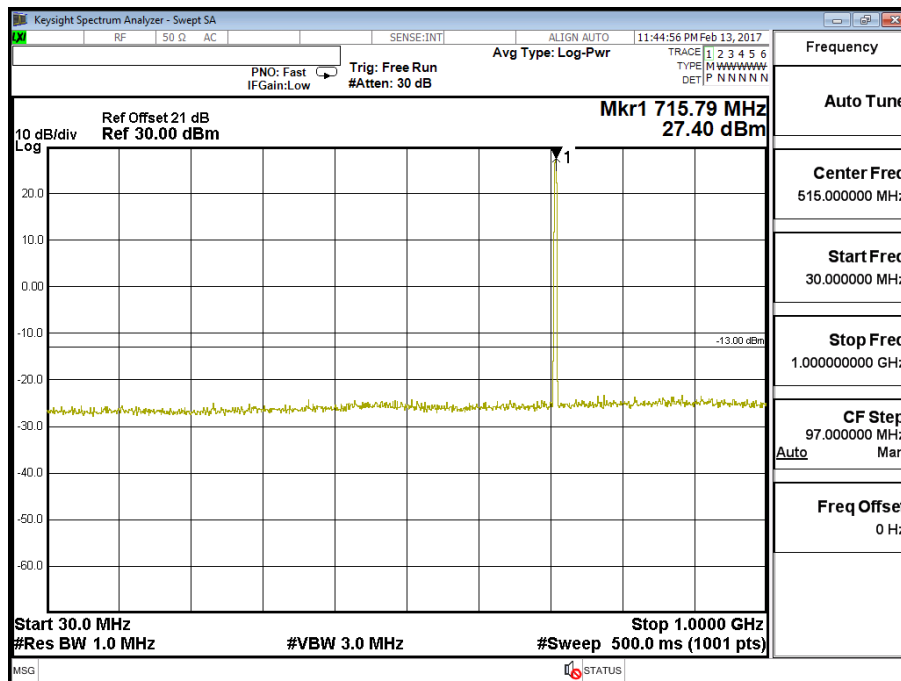

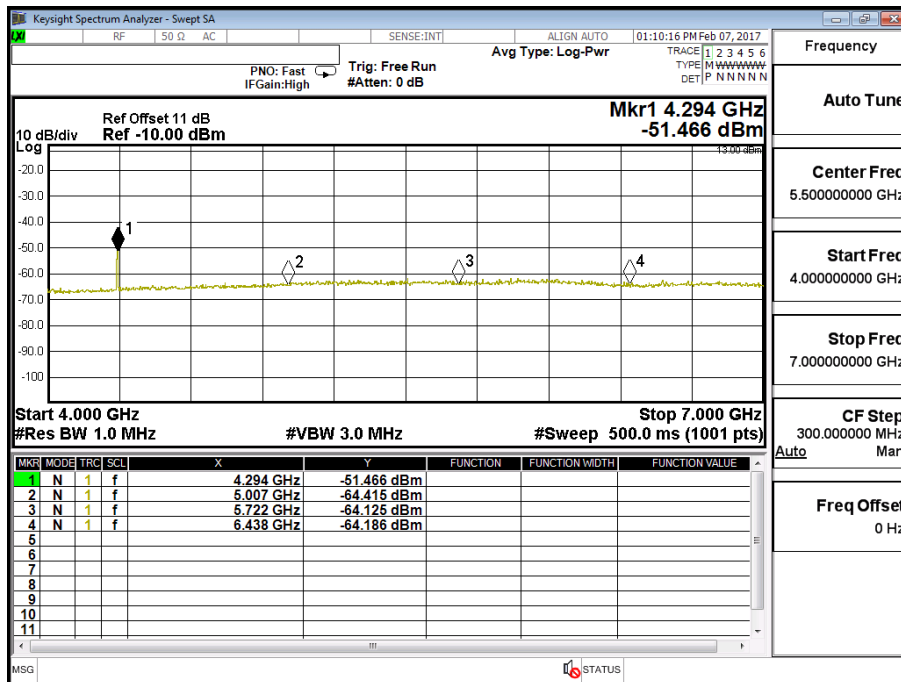
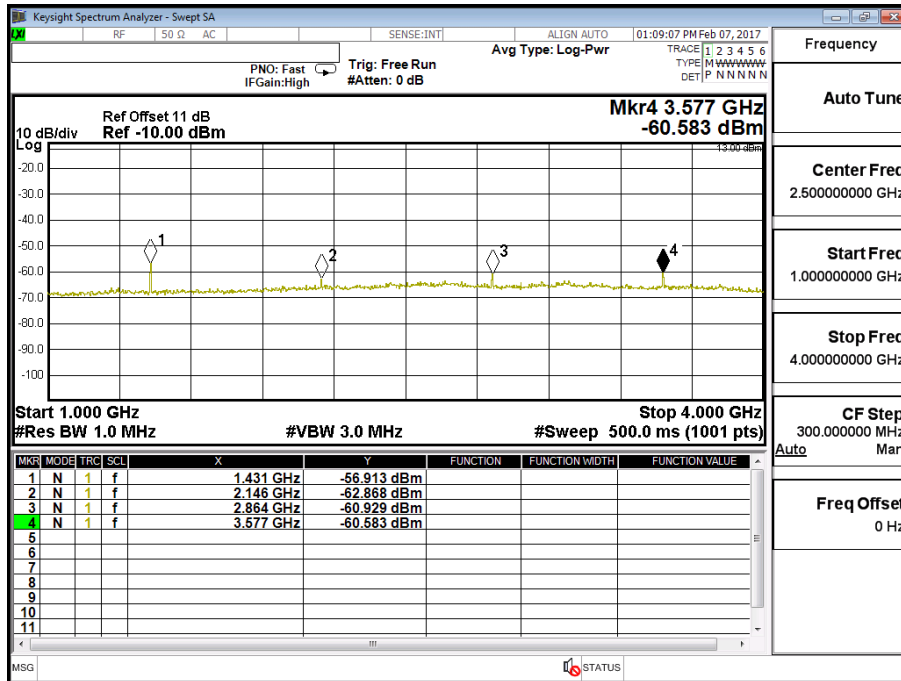

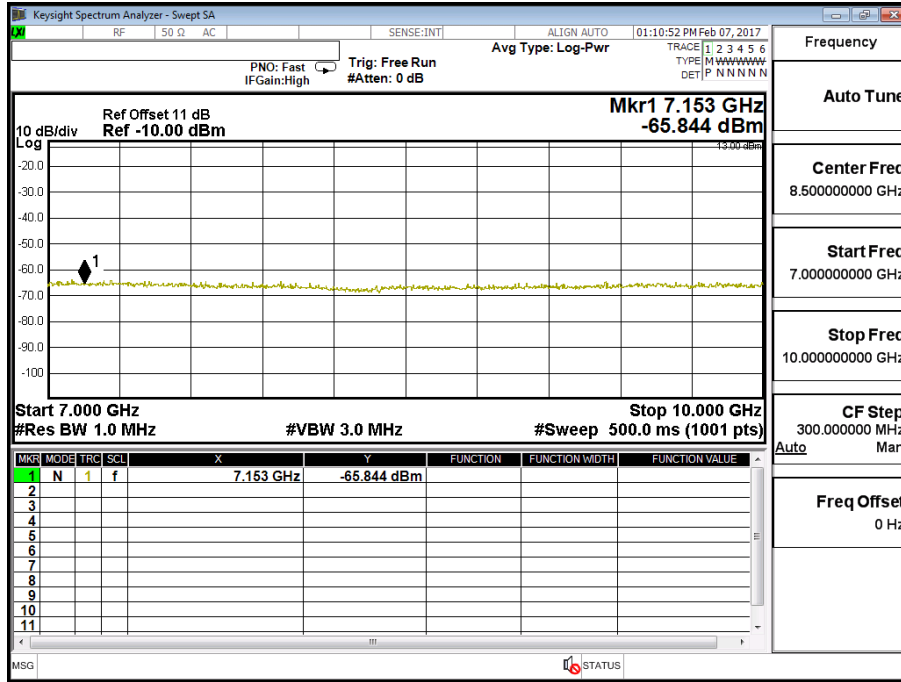

Product	LE910C1-NA		
Test Mode	Spurious Emission (Conducted)		
Date of Test	2017/02/08	Test Site	CTR
Test Condition	LTE-Band 12 (1.4M)	Test Range	30MHz~10GHz

LTE-Band 12 (1.4M) 16QAM(3,3) CH23173 (715.3MHz)

Frequency (MHz)	Reading Level (dBm)	Path Loss (dB)	Emission Level (dBm)	Limit (dBm)
1431	-58.526	0.58	-57.946	-13
2146	-63.118	0.7	-62.418	-13
2864	-61.427	1.01	-60.417	-13
3577	-59.543	1.18	-58.363	-13
4294	-50.752	1.23	-49.522	-13
5007	-63.917	1.45	-62.467	-13
5722	-64.229	1.56	-62.669	-13
6435	-63.559	1.59	-61.969	-13
7153	-65.832	1.82	-64.012	-13

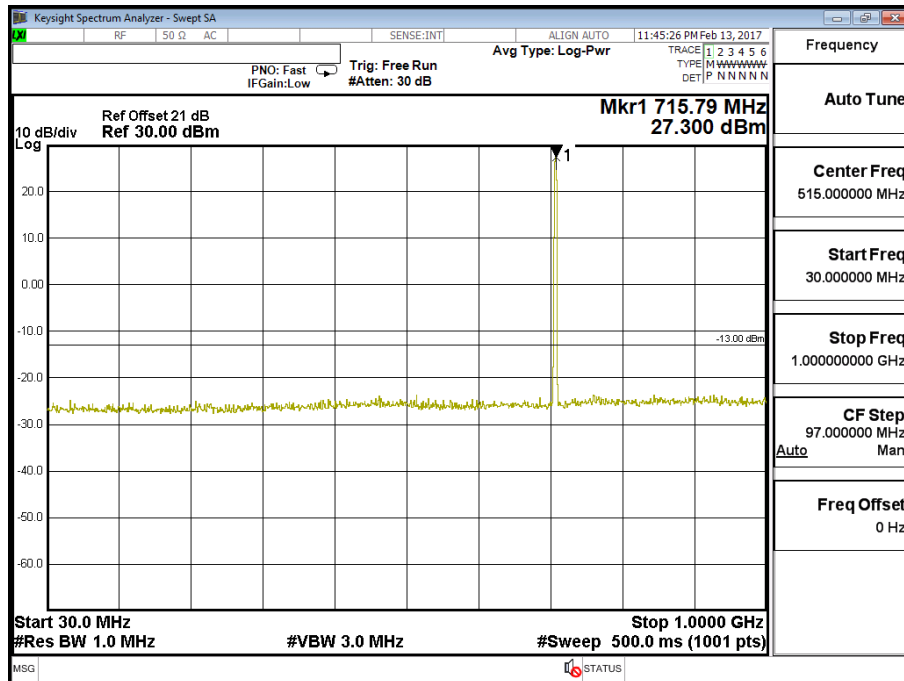

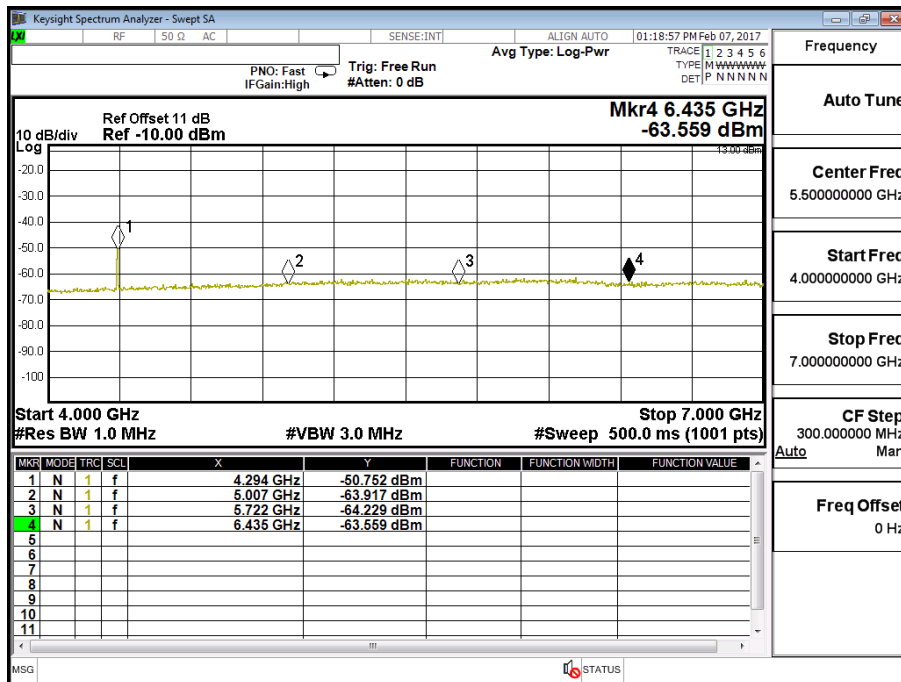
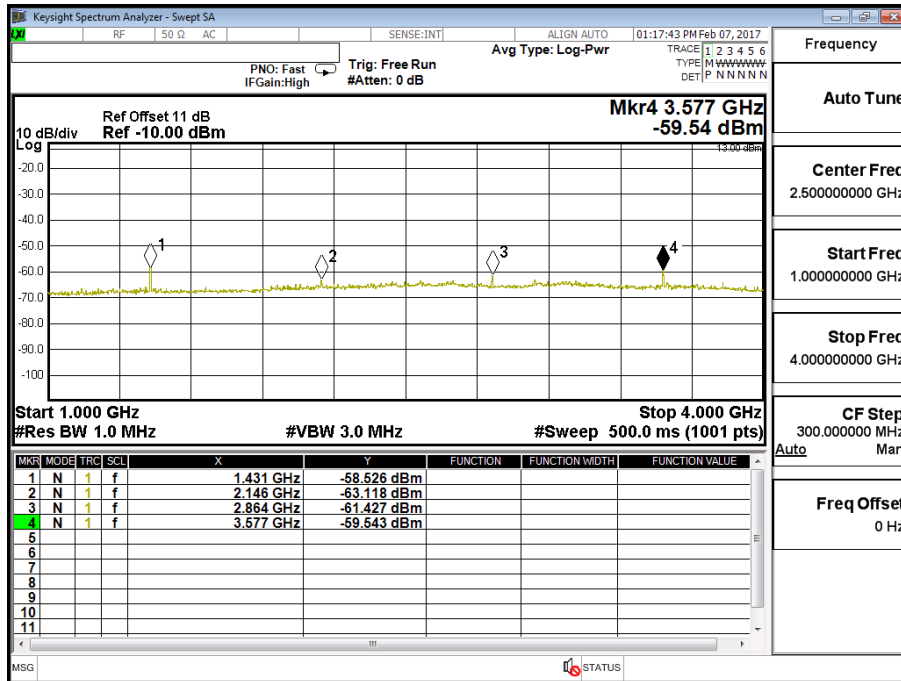

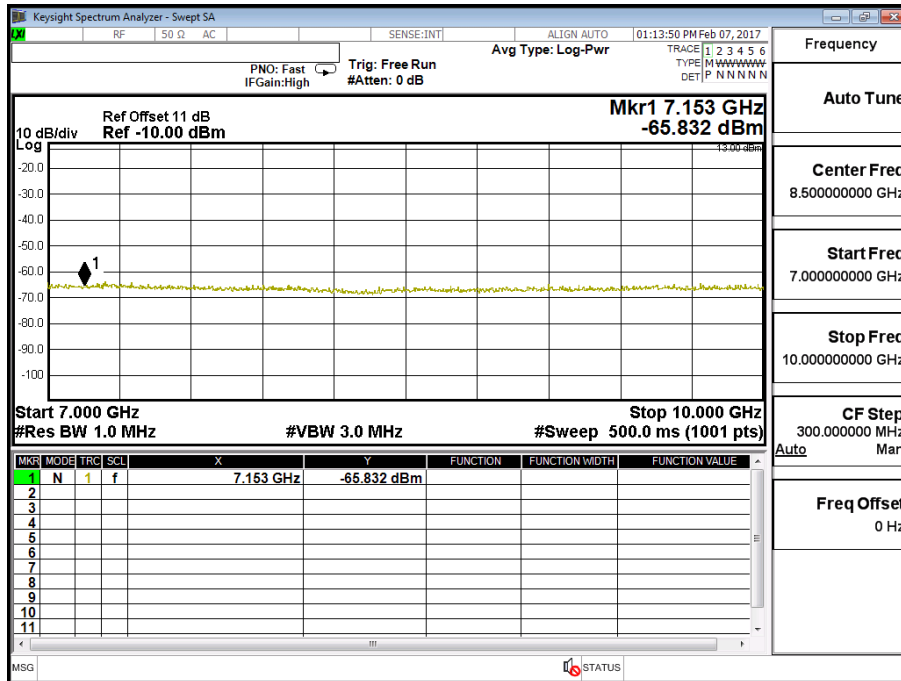

Product	LE910C1-NA		
Test Mode	Spurious Emission (Conducted)		
Date of Test	2017/02/08	Test Site	CTR
Test Condition	LTE-Band 12 (3M)	Test Range	30MHz~10GHz

LTE-Band 12 (3M) QPSK(1,7) CH23165 (714.5MHz)

Frequency (MHz)	Reading Level (dBm)	Path Loss (dB)	Emission Level (dBm)	Limit (dBm)
1429	-48.896	0.58	-48.316	-13
2144	-60.054	0.7	-59.354	-13
2858	-59.642	1.01	-58.632	-13
3571	-58.163	1.18	-56.983	-13
4287	-50.694	1.23	-49.464	-13
5002	-64.219	1.45	-62.769	-13
5716	-63.649	1.56	-62.089	-13
6425	-63.913	1.59	-62.323	-13
7145	-65.775	1.82	-63.955	-13

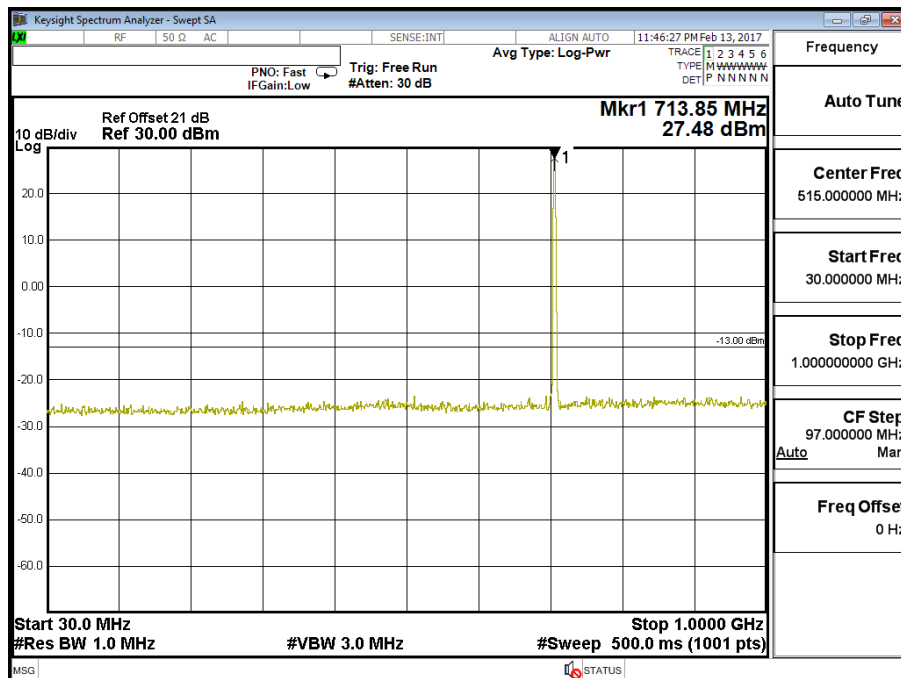

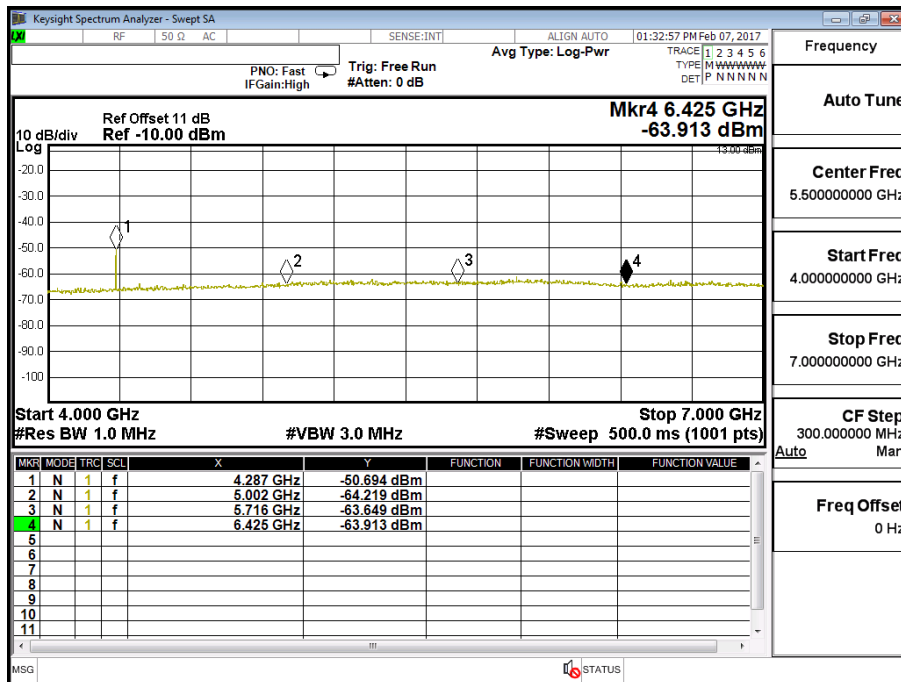
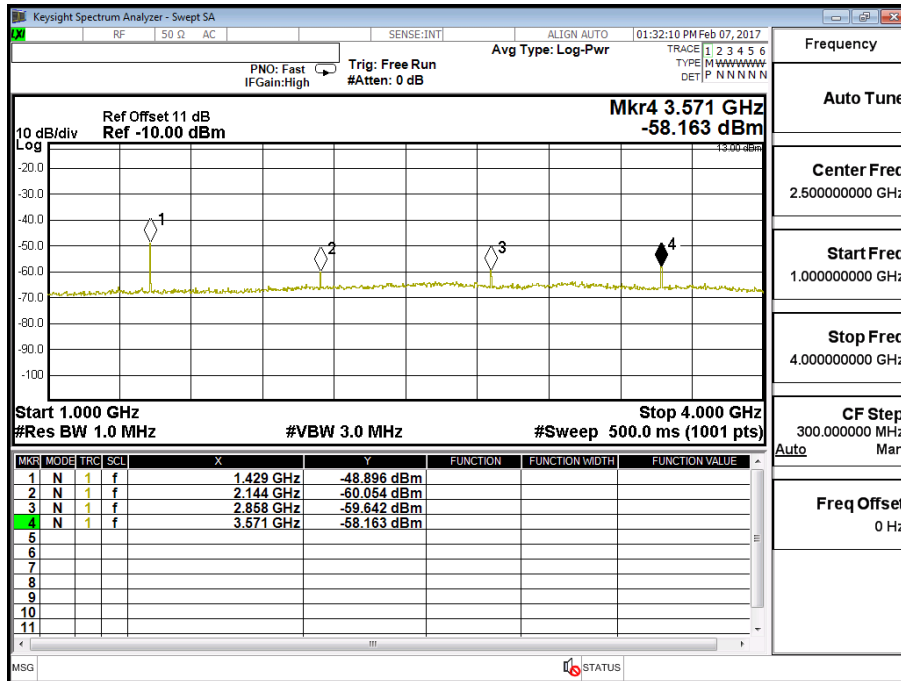

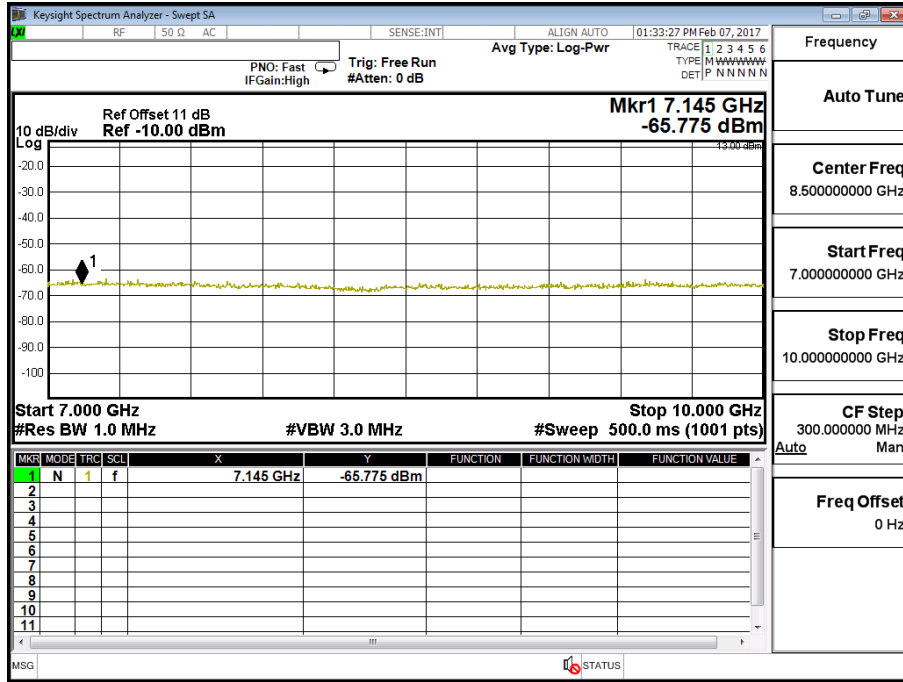

Product	LE910C1-NA		
Test Mode	Spurious Emission (Conducted)		
Date of Test	2017/02/08	Test Site	CTR
Test Condition	LTE-Band 12 (3M)	Test Range	30MHz~10GHz

LTE-Band 12 (3M) 16QAM(1,7) CH23165 (714.5MHz)

Frequency (MHz)	Reading Level (dBm)	Path Loss (dB)	Emission Level (dBm)	Limit (dBm)
1429	-48.623	0.58	-48.043	-13
2144	-60.558	0.7	-59.858	-13
2858	-59.894	1.01	-58.884	-13
3573	-58.408	1.18	-57.228	-13
4288	-50.817	1.23	-49.587	-13
5002	-63.431	1.45	-61.981	-13
5716	-62.039	1.56	-60.479	-13
6431	-63.948	1.59	-62.358	-13
7145	-65.457	1.82	-63.637	-13

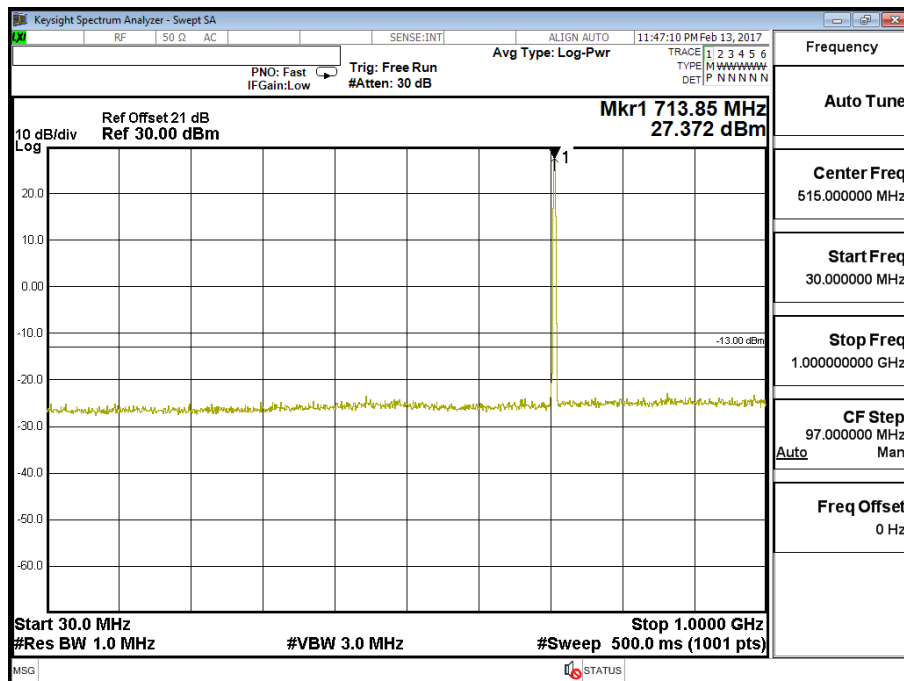

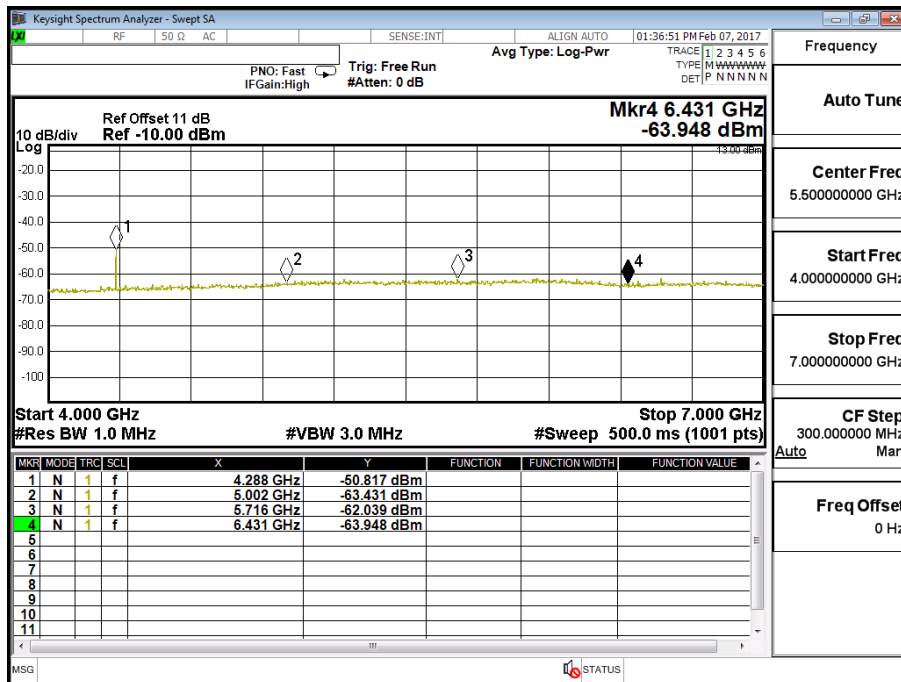
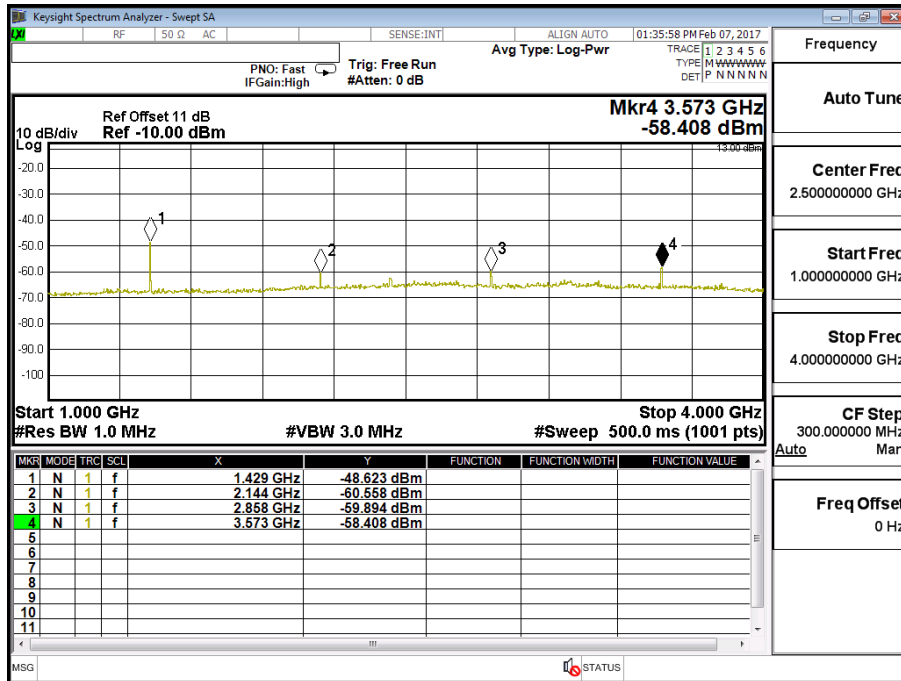

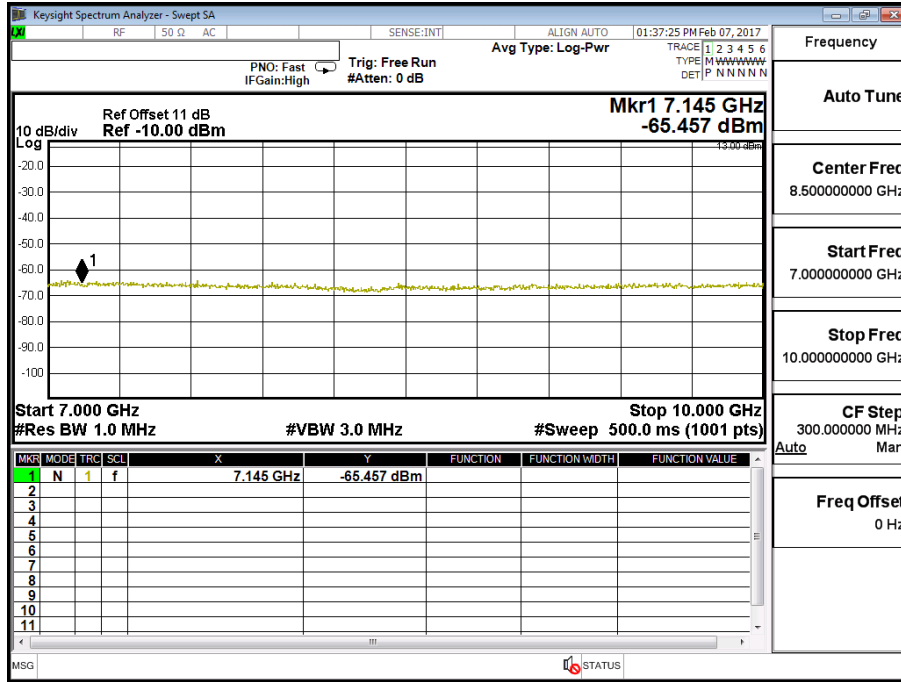

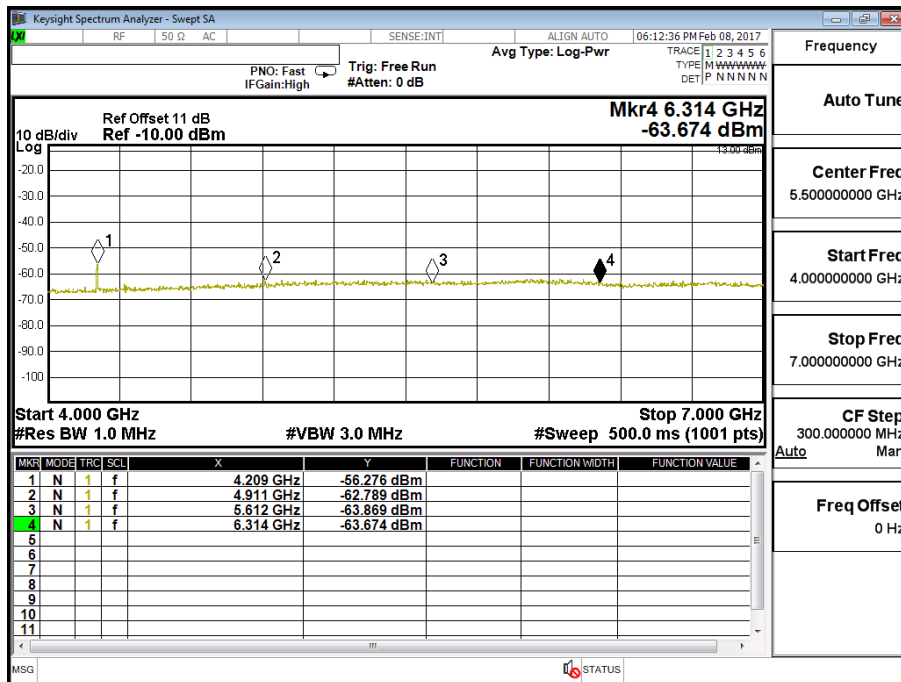
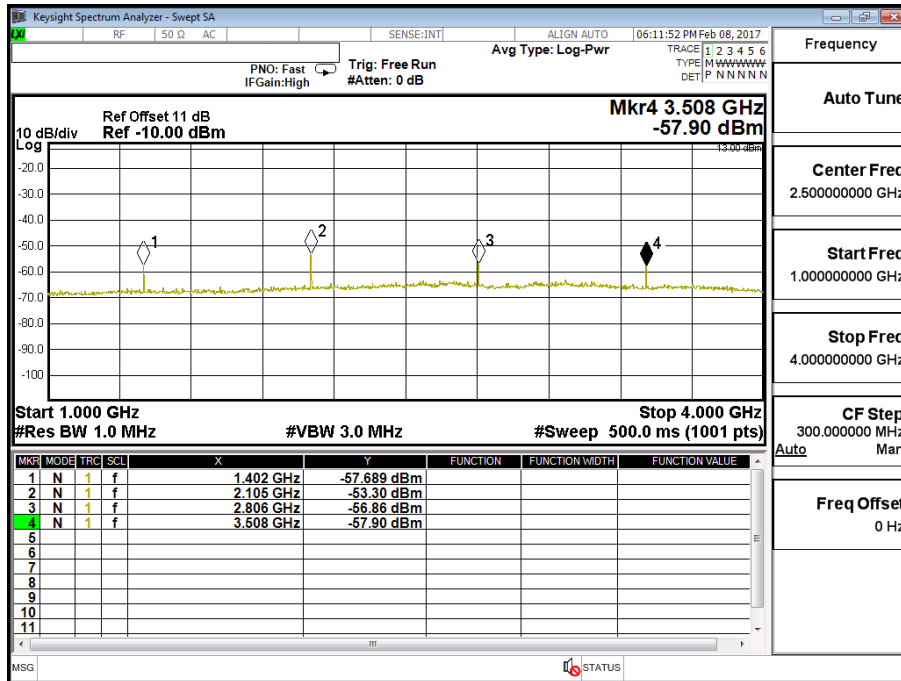

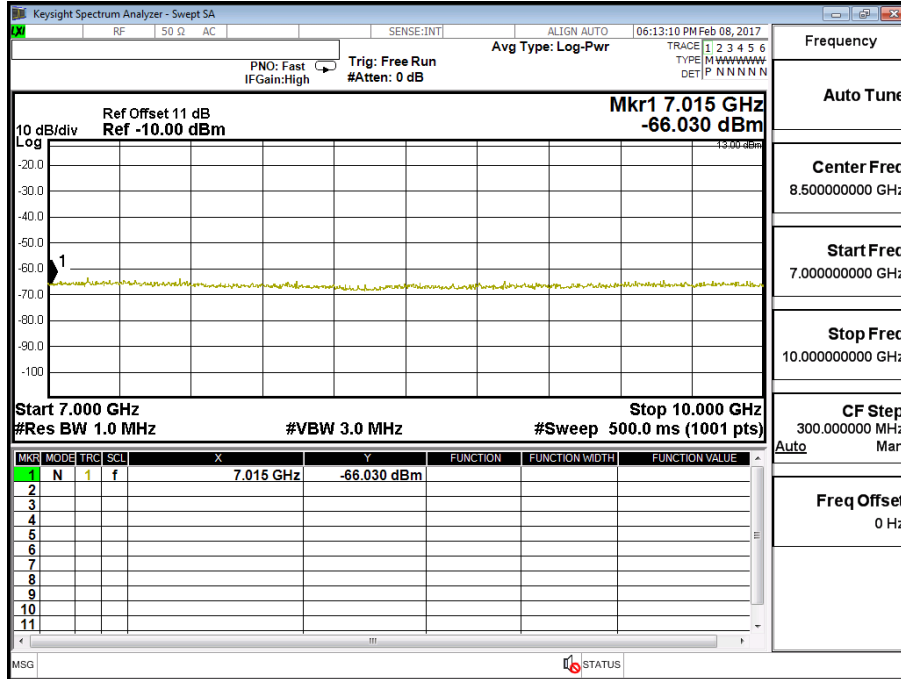

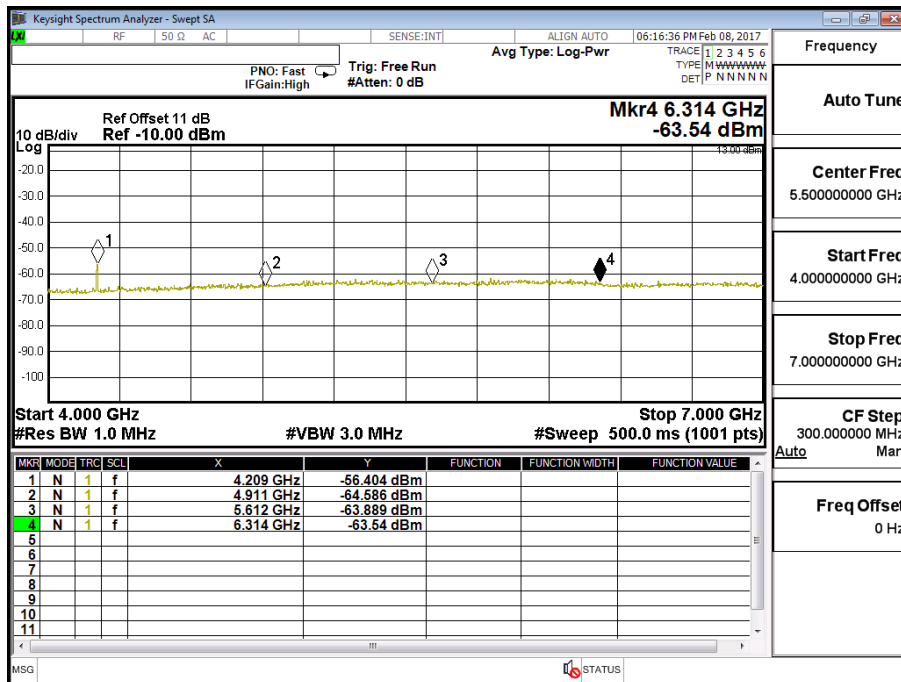
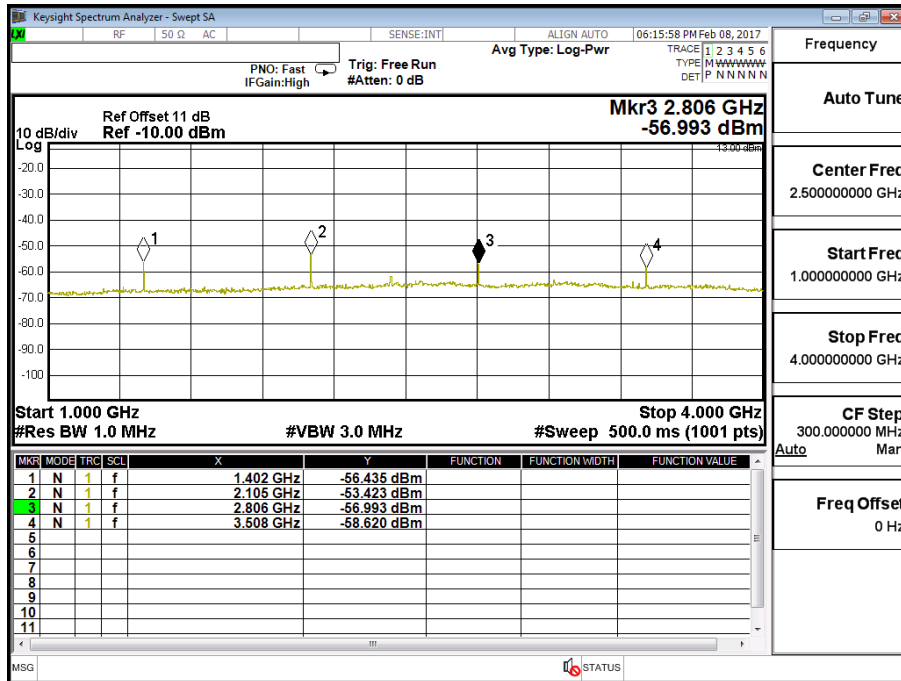

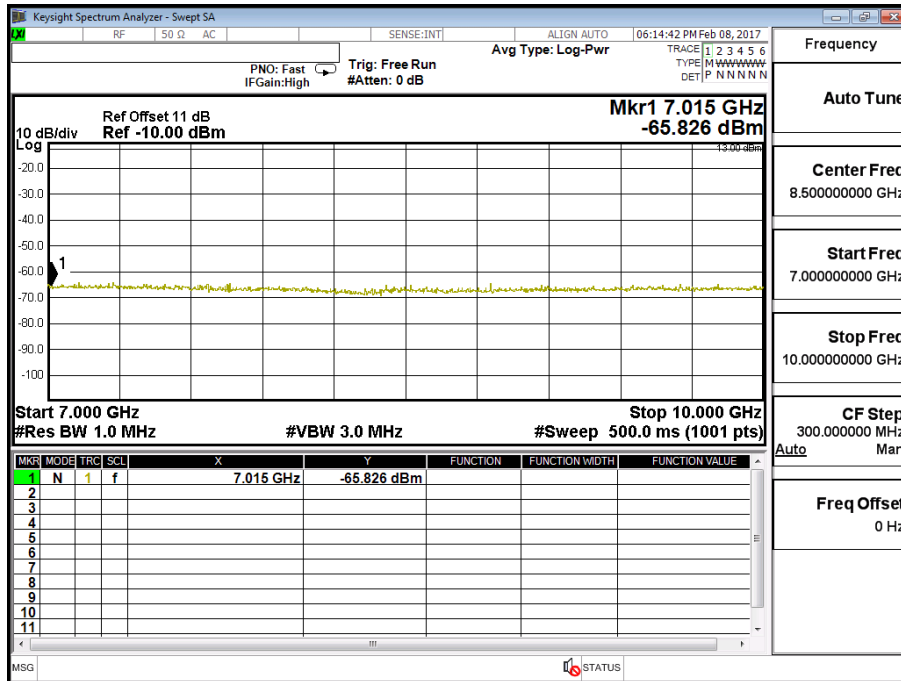

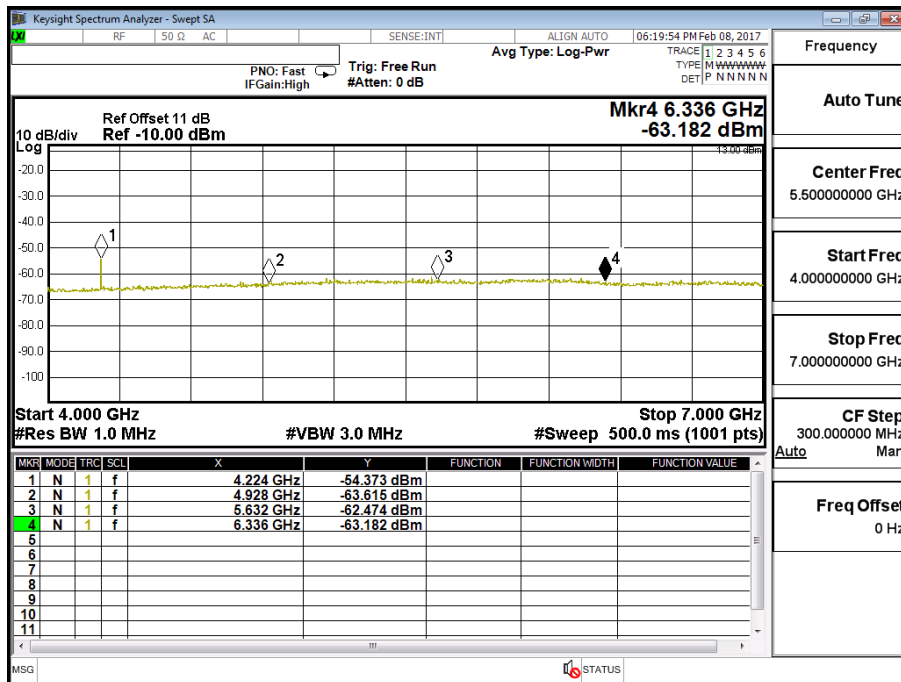
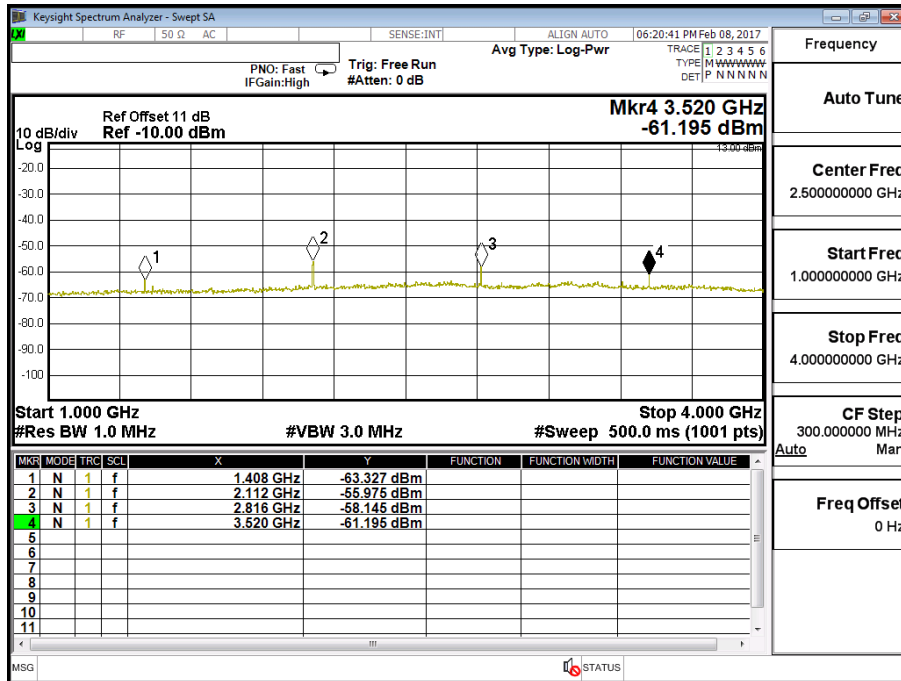

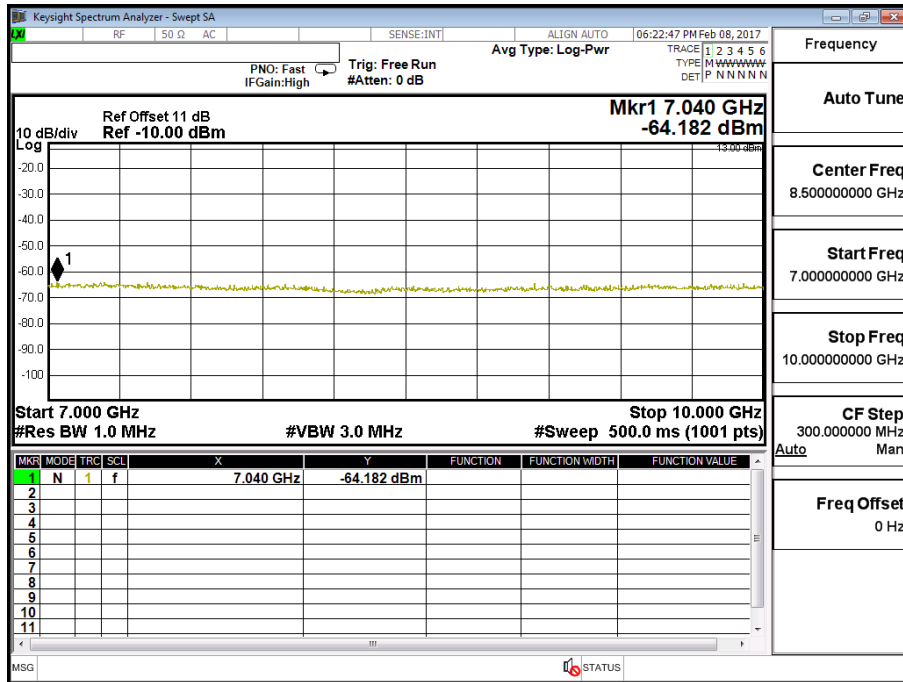

Product	LE910C1-NA		
Test Mode	Spurious Emission (Radiated)		
Date of Test	2017/02/08	Test Site	Site3
Test Condition	Band 2 (1.4M) QPSK(3,2)	Test Range	9kHz ~20GHz

Frequency	Reading Level	Signal Generator Level	Cable Loss	Antenna Gain	EIRP Value	Limit
(GHz)	(dBm)	(dBm)	(dB)	(dBi)	(dBm)	(dBm)

Horizontal Emissions Band 2 (1.4M) QPSK(3,2) CH18607(1850.7MHz)

3701	-62.070	-62.682	2.530	12.600	-52.612	-13
5552	-63.844	-60.460	3.050	13.100	-50.410	-13
7403	-64.905	-50.223	3.650	11.500	-42.373	-13
9254	-63.444	-48.612	3.850	12.000	-40.462	-13
11104	-64.073	-46.524	4.580	12.000	-39.104	-13

Vertical Emissions Band 2 (1.4M) QPSK(3,2) CH18607(1850.7MHz)

3701	-61.342	-59.707	2.530	12.600	-49.637	-13
5552	-60.229	-56.244	3.050	13.100	-46.194	-13
7403	-64.328	-49.248	3.650	11.500	-41.398	-13
9254	-63.623	-48.202	3.850	12.000	-40.052	-13
11104	-63.971	-46.309	4.580	12.000	-38.889	-13

Note:

1. Receiver setting (Peak Detector) : RBW:1MHz; VBW:3MHz
2. EIRP Value = Signal Generator Level + Antenna Gain - Cable Loss
3. Spurious emissions past 12 GHz are not shown, due to the magnitude of spurious emissions attenuated more than 20 dB below the limit.

Product	LE910C1-NA		
Test Mode	Spurious Emission (Radiated)		
Date of Test	2017/02/08	Test Site	Site3
Test Condition	Band 2 (3M) QPSK(1,7)	Test Range	9kHz ~20GHz

Frequency	Reading Level	Signal Generator Level	Cable Loss	Antenna Gain	EIRP Value	Limit
(GHz)	(dBm)	(dBm)	(dB)	(dBi)	(dBm)	(dBm)

Horizontal Emissions Band 2 (3M) QPSK(1,7) CH18615 (1851.5MHz)

3703	-61.905	-62.517	2.530	12.600	-52.447	-13
5555	-63.798	-60.414	3.050	13.100	-50.364	-13
7406	-63.592	-48.938	3.650	11.500	-41.088	-13
9258	-62.590	-47.717	3.850	12.000	-39.567	-13
11109	-64.793	-47.302	4.580	12.000	-39.882	-13

Vertical Emissions Band 2 (3M) QPSK(1,7) CH18615 (1851.5MHz)

3703	-61.075	-59.440	2.530	12.600	-49.370	-13
5555	-58.569	-54.584	3.050	13.100	-44.534	-13
7406	-64.187	-49.100	3.650	11.500	-41.250	-13
9258	-63.180	-47.706	3.850	12.000	-39.556	-13
11109	-64.867	-47.205	4.580	12.000	-39.785	-13

Note:

1. Receiver setting (Peak Detector) : RBW:1MHz; VBW:3MHz
2. EIRP Value = Signal Generator Level + Antenna Gain - Cable Loss
3. Spurious emissions past 12 GHz are not shown, due to the magnitude of spurious emissions attenuated more than 20 dB below the limit.

Product	LE910C1-NA		
Test Mode	Spurious Emission (Radiated)		
Date of Test	2017/02/08	Test Site	Site3
Test Condition	Band 2 (5M) QPSK(1,12)	Test Range	9kHz ~20GHz

Frequency	Reading Level	Signal Generator Level	Cable Loss	Antenna Gain	EIRP Value	Limit
(GHz)	(dBm)	(dBm)	(dB)	(dBi)	(dBm)	(dBm)

Horizontal Emissions Band 2 (5M) QPSK(1,12) CH18625 (1852.5MHz)

3705	-61.336	-61.948	2.530	12.600	-51.878	-13
5558	-63.718	-60.414	3.050	13.100	-50.364	-13
7410	-64.132	-49.478	3.650	11.500	-41.628	-13
9263	-63.537	-48.663	3.850	12.000	-40.513	-13
11115	-64.317	-46.827	4.580	12.000	-39.407	-13

Vertical Emissions Band 2 (5M) QPSK(1,12) CH18625 (1852.5MHz)

3705	-60.117	-58.482	2.530	12.600	-48.412	-13
5558	-59.039	-55.054	3.050	13.100	-45.004	-13
7410	-64.384	-49.297	3.650	11.500	-41.447	-13
9263	-62.548	-47.074	3.850	12.000	-38.924	-13
11115	-64.868	-47.206	4.580	12.000	-39.786	-13

Note:

1. Receiver setting (Peak Detector) : RBW:3MHz; VBW:3MHz
2. EIRP Value = Signal Generator Level + Antenna Gain - Cable Loss
3. Spurious emissions past 12 GHz are not shown, due to the magnitude of spurious emissions attenuated more than 20 dB below the limit.

Product	LE910C1-NA		
Test Mode	Spurious Emission (Radiated)		
Date of Test	2017/02/08	Test Site	Site3
Test Condition	Band 2 (10M) QPSK(1,24)	Test Range	9KHz ~20GHz

Frequency	Reading Level	Signal Generator Level	Cable Loss	Antenna Gain	EIRP Value	Limit
(GHz)	(dBm)	(dBm)	(dB)	(dBi)	(dBm)	(dBm)

Horizontal Emissions Band 2 (10M) QPSK(1,24) CH18650 (1855MHz)

3710	-61.552	-62.126	2.530	12.600	-52.056	-13
5565	-64.205	-60.901	3.050	13.100	-50.851	-13
7420	-64.921	-50.294	3.650	11.500	-42.444	-13
9275	-63.576	-48.661	3.850	12.000	-40.511	-13
11130	-64.836	-47.463	4.580	12.000	-40.043	-13

Vertical Emissions Band 2 (10M) QPSK(1,24) CH18650 (1855MHz)

3710	-59.884	-58.200	2.530	12.600	-48.130	-13
5565	-59.422	-55.495	3.050	13.100	-45.445	-13
7420	-64.824	-49.740	3.650	11.500	-41.890	-13
9275	-63.774	-48.246	3.850	12.000	-40.096	-13
11130	-65.111	-47.647	4.580	12.000	-40.227	-13

Note:

1. Receiver setting (Peak Detector) : RBW:1MHz; VBW:3MHz
2. ERP Value = Signal Generator Level + Antenna Gain - Cable Loss
3. Spurious emissions past 12 GHz are not shown, due to the magnitude of spurious emissions attenuated more than 20 dB below the limit.

Product	LE910C1-NA		
Test Mode	Spurious Emission (Radiated)		
Date of Test	2017/02/08	Test Site	Site3
Test Condition	Band 4 (1.4M) QPSK(3,2)	Test Range	9kHz ~20GHz

Frequency	Reading Level	Signal Generator Level	Cable Loss	Antenna Gain	EIRP Value	Limit
(GHz)	(dBm)	(dBm)	(dB)	(dBi)	(dBm)	(dBm)

Horizontal Emissions Band 4 (1.4M) QPSK(3,2) CH19957 (1710.7MHz)

3421	-51.857	-53.124	2.530	12.600	-43.054	-13
5132	-61.005	-56.768	3.050	13.100	-46.718	-13
6843	-61.837	-50.948	3.650	11.500	-43.098	-13
8554	-62.978	-47.719	3.850	12.000	-39.569	-13
10264	-63.104	-46.795	4.580	12.000	-39.375	-13
11975	-65.165	-48.711	4.800	13.300	-40.211	-13

Vertical Emissions Band 4 (1.4M) QPSK(3,2) CH19957 (1710.7MHz)

3424	-52.818	-53.087	2.530	12.600	-43.017	-13
5130	-53.099	-48.544	3.050	13.100	-38.494	-13
6840	-56.493	-44.997	3.650	11.500	-37.147	-13
8554	-62.307	-46.675	3.850	12.000	-38.525	-13
10264	-63.914	-47.768	4.580	12.000	-40.348	-13
11975	-65.213	-48.543	4.800	13.300	-40.043	-13

Note:

1. Receiver setting (Peak Detector) : RBW:1MHz; VBW:3MHz
2. EIRP Value = Signal Generator Level + Antenna Gain - Cable Loss
3. Spurious emissions past 12 GHz are not shown, due to the magnitude of spurious emissions attenuated more than 20 dB below the limit.

Product	LE910C1-NA		
Test Mode	Spurious Emission (Radiated)		
Date of Test	2017/02/08	Test Site	Site3
Test Condition	Band 4 (3M) QPSK(1,7)	Test Range	9kHz ~20GHz

Frequency	Reading Level	Signal Generator Level	Cable Loss	Antenna Gain	EIRP Value	Limit
(GHz)	(dBm)	(dBm)	(dB)	(dBi)	(dBm)	(dBm)

Horizontal Emissions Band 4 (3M) QPSK(1,7) CH19965 (1711.5MHz)

3424	-51.689	-52.955	2.530	12.600	-42.885	-13
5135	-60.328	-56.090	3.050	13.100	-46.040	-13
6846	-61.544	-50.599	3.650	11.500	-42.749	-13
8558	-62.108	-46.849	3.850	12.000	-38.699	-13
10269	-63.602	-47.284	4.580	12.000	-39.864	-13
11981	-65.293	-48.912	4.800	13.300	-40.412	-13

Vertical Emissions Band 4 (3M) QPSK(1,7) CH19965 (1711.5MHz)

3424	-52.240	-52.509	2.530	12.600	-42.439	-13
5120	-52.703	-48.117	3.050	13.100	-38.067	-13
6850	-56.932	-45.377	3.650	11.500	-37.527	-13
8558	-63.562	-47.930	3.850	12.000	-39.780	-13
10269	-63.467	-47.326	4.580	12.000	-39.906	-13
11981	-65.370	-48.780	4.800	13.300	-40.280	-13

Note:

1. Receiver setting (Peak Detector) : RBW:1MHz; VBW:3MHz
2. EIRP Value = Signal Generator Level + Antenna Gain - Cable Loss
3. Spurious emissions past 12 GHz are not shown, due to the magnitude of spurious emissions attenuated more than 20 dB below the limit.

Product	LE910C1-NA		
Test Mode	Spurious Emission (Radiated)		
Date of Test	2017/02/08	Test Site	Site3
Test Condition	Band 4 (5M) QPSK(1,0)	Test Range	9kHz ~20GHz

Frequency	Reading Level	Signal Generator Level	Cable Loss	Antenna Gain	EIRP Value	Limit
(GHz)	(dBm)	(dBm)	(dB)	(dBi)	(dBm)	(dBm)

Horizontal Emissions Band 4 (5M) QPSK(1,0) CH19975 (1712.5MHz)

3424	-52.745	-54.012	2.530	12.600	-43.942	-13
5130	-58.986	-54.749	3.050	13.100	-44.699	-13
6850	-62.739	-51.850	3.650	11.500	-44.000	-13
8563	-62.548	-47.307	3.850	12.000	-39.157	-13
10275	-62.678	-46.359	4.580	12.000	-38.939	-13
11988	-64.408	-47.998	4.800	13.300	-39.498	-13

Vertical Emissions Band 4 (5M) QPSK(1,0) CH19975 (1712.5MHz)

3424	-51.549	-51.818	2.530	12.600	-41.748	-13
5130	-51.471	-46.917	3.050	13.100	-36.867	-13
6840	-55.990	-44.494	3.650	11.500	-36.644	-13
8563	-62.070	-46.465	3.850	12.000	-38.315	-13
10275	-62.153	-46.011	4.580	12.000	-38.591	-13
11988	-65.216	-48.706	4.800	13.300	-40.206	-13

Note:

1. Receiver setting (Peak Detector) : RBW:1MHz; VBW:3MHz
2. EIRP Value = Signal Generator Level + Antenna Gain - Cable Loss
3. Spurious emissions past 12 GHz are not shown, due to the magnitude of spurious emissions attenuated more than 20 dB below the limit.

Product	LE910C1-NA		
Test Mode	Spurious Emission (Radiated)		
Date of Test	2017/02/08	Test Site	Site3
Test Condition	Band 4 (10M) QPSK(1,24)	Test Range	9KHz ~20GHz

Frequency	Reading Level	Signal Generator Level	Cable Loss	Antenna Gain	EIRP Value	Limit
(GHz)	(dBm)	(dBm)	(dB)	(dBi)	(dBm)	(dBm)

Horizontal Emissions Band 4 (10M) QPSK(1,24) CH20000 (1715MHz)

3430	-62.824	-63.996	2.530	12.600	-53.926	-13
5145	-62.612	-58.375	3.050	13.100	-48.325	-13
6860	-63.590	-52.589	3.650	11.500	-44.739	-13
8575	-62.775	-47.481	3.850	12.000	-39.331	-13
10290	-62.002	-45.675	4.580	12.000	-38.255	-13

Vertical Emissions Band 4 (10M) QPSK(1,24) CH20000 (1715MHz)

3430	-62.142	-62.337	2.530	12.600	-52.267	-13
5145	-62.959	-58.501	3.050	13.100	-48.451	-13
6860	-63.991	-52.376	3.650	11.500	-44.526	-13
8575	-62.208	-46.630	3.850	12.000	-38.480	-13
10290	-63.649	-47.515	4.580	12.000	-40.095	-13

Note:

1. Receiver setting (Peak Detector) : RBW:1MHz; VBW:3MHz
2. EIRP Value = Signal Generator Level + Antenna Gain - Cable Loss
3. Spurious emissions past 12 GHz are not shown, due to the magnitude of spurious emissions attenuated more than 20 dB below the limit.

Product	LE910C1-NA		
Test Mode	Spurious Emission (Radiated)		
Date of Test	2017/02/08	Test Site	Site3
Test Condition	Band 12 (1.4M) QPSK(3,3)	Test Range	9KHz ~10GHz

Frequency	Reading Level	Signal Generator Level	Cable Loss	Antenna Gain	EIRP Value	Limit
(GHz)	(dBm)	(dBm)	(dB)	(dBi)	(dBm)	(dBm)

Horizontal Emissions Band 12 (1.4M) QPSK(3,3) CH23173 (715.3MHz)

1431	-60.169	-64.695	1.630	9.800	-56.525	-13
2146	-64.655	-64.887	2.100	10.600	-56.387	-13
2861	-63.700	-65.623	2.350	12.300	-55.673	-13
3577	-62.175	-62.648	2.700	12.600	-52.748	-13
4292	-61.535	-59.218	2.830	12.700	-49.348	-13
5007	-64.558	-60.178	3.200	13.000	-50.378	-13
5722	-63.392	-60.138	3.200	12.100	-51.238	-13

Vertical Emissions Band 12 (1.4M) QPSK(3,3) CH23173 (715.3MHz)

1431	-56.431	-59.875	1.630	9.800	-51.705	-13
2146	-63.050	-63.632	2.100	10.600	-55.132	-13
2861	-62.684	-63.388	2.350	12.300	-53.438	-13
3577	-62.325	-60.963	2.700	12.600	-51.063	-13
4292	-61.584	-58.059	2.830	12.700	-48.189	-13
5007	-63.946	-58.863	3.200	13.000	-49.063	-13
5722	-63.762	-60.401	3.200	12.100	-51.501	-13

Note:

1. Receiver setting (Peak Detector) : RBW:1MHz; VBW:3MHz
2. EIRP Value = Signal Generator Level + Antenna Gain - Cable Loss
3. Spurious emissions past 6 GHz are not shown, due to the magnitude of spurious emissions attenuated more than 20 dB below the limit.

Product	LE910C1-NA		
Test Mode	Spurious Emission (Radiated)		
Date of Test	2017/02/08	Test Site	Site3
Test Condition	Band 12 (3M) QPSK(1,7)	Test Range	9KHz ~10GHz

Frequency	Reading Level	Signal Generator Level	Cable Loss	Antenna Gain	EIRP Value	Limit
(GHz)	(dBm)	(dBm)	(dB)	(dBi)	(dBm)	(dBm)

Horizontal Emissions Band 12 (3M) QPSK(1,7) CH23165 (714.5MHz)

1429	-55.804	-60.307	1.630	9.800	-52.137	-13
2144	-62.580	-62.812	2.100	10.600	-54.312	-13
2858	-61.392	-63.315	2.350	12.300	-53.365	-13
3573	-61.842	-62.314	2.700	12.600	-52.414	-13
4287	-62.768	-60.465	2.830	12.700	-50.595	-13
5002	-63.295	-58.939	3.200	13.000	-49.139	-13
5716	-63.354	-60.062	3.200	12.100	-51.162	-13

Vertical Emissions Band 12 (3M) QPSK(1,7) CH23165 (714.5MHz)

1429	-47.353	-50.785	1.630	9.800	-42.615	-13
2144	-57.908	-58.490	2.100	10.600	-49.990	-13
2858	-59.758	-60.462	2.350	12.300	-50.512	-13
3573	-60.512	-59.150	2.700	12.600	-49.250	-13
4287	-59.072	-55.698	2.830	12.700	-45.828	-13
5002	-63.024	-57.942	3.200	13.000	-48.142	-13
5716	-63.863	-60.467	3.200	12.100	-51.567	-13

Note:

1. Receiver setting (Peak Detector) : RBW:1MHz; VBW:3MHz
2. EIRP Value = Signal Generator Level + Antenna Gain - Cable Loss
3. Spurious emissions past 6 GHz are not shown, due to the magnitude of spurious emissions attenuated more than 20 dB below the limit.

Product	LE910C1-NA		
Test Mode	Spurious Emission (Radiated)		
Date of Test	2017/02/08	Test Site	Site3
Test Condition	Band 12 (5M) QPSK(1,12)	Test Range	9KHz ~10GHz

Frequency	Reading Level	Signal Generator Level	Cable Loss	Antenna Gain	EIRP Value	Limit
(GHz)	(dBm)	(dBm)	(dB)	(dBi)	(dBm)	(dBm)

Horizontal Emissions Band 12 (5M) QPSK(1,12) CH23035 (701.5MHz)

1403	-62.981	-67.393	1.630	9.800	-59.223	-13
2105	-63.604	-64.282	2.100	10.600	-55.782	-13
2806	-62.924	-64.691	2.350	12.300	-54.741	-13
3508	-61.911	-62.331	2.700	12.600	-52.431	-13
4209	-62.618	-61.399	2.830	12.700	-51.529	-13
4911	-64.390	-60.323	3.200	13.000	-50.523	-13
5612	-64.135	-60.104	3.200	12.100	-51.204	-13

Vertical Emissions Band 12 (5M) QPSK(1,12) CH23035 (701.5MHz)

1403	-56.390	-59.813	1.630	9.800	-51.643	-13
2105	-59.925	-60.698	2.100	10.600	-52.198	-13
2806	-60.705	-61.172	2.350	12.300	-51.222	-13
3508	-61.614	-60.931	2.700	12.600	-51.031	-13
4209	-62.881	-60.402	2.830	12.700	-50.532	-13
4911	-64.129	-59.662	3.200	13.000	-49.862	-13
5612	-64.451	-59.800	3.200	12.100	-50.900	-13

Note:

1. Receiver setting (Peak Detector) : RBW:1MHz; VBW:3MHz
2. EIRP Value = Signal Generator Level + Antenna Gain - Cable Loss
3. Spurious emissions past 6 GHz are not shown, due to the magnitude of spurious emissions attenuated more than 20 dB below the limit.

Product	LE910C1-NA		
Test Mode	Spurious Emission (Radiated)		
Date of Test	2017/02/08	Test Site	Site3
Test Condition	Band 12 (10M) QPSK(1,24)	Test Range	9KHz ~10GHz

Frequency	Reading Level	Signal Generator Level	Cable Loss	Antenna Gain	EIRP Value	Limit
(GHz)	(dBm)	(dBm)	(dB)	(dBi)	(dBm)	(dBm)

Horizontal Emissions Band 12 (10M) QPSK(1,24) CH23060 (704MHz)

1408	-62.808	-67.243	1.630	9.800	-59.073	-13
2112	-63.490	-64.104	2.100	10.600	-55.604	-13
2816	-61.704	-63.505	2.350	12.300	-53.555	-13
3520	-62.043	-62.472	2.700	12.600	-52.572	-13
4224	-62.610	-61.205	2.830	12.700	-51.335	-13
4928	-63.694	-59.573	3.200	13.000	-49.773	-13
5632	-62.283	-58.298	3.200	12.100	-49.398	-13

Vertical Emissions Band 12 (10M) QPSK(1,24) CH23060 (704MHz)

1408	-58.284	-61.680	1.630	9.800	-53.510	-13
2112	-57.805	-58.542	2.100	10.600	-50.042	-13
2816	-61.784	-62.304	2.350	12.300	-52.354	-13
3520	-62.039	-61.233	2.700	12.600	-51.333	-13
4224	-61.694	-59.077	2.830	12.700	-49.207	-13
4928	-62.967	-58.368	3.200	13.000	-48.568	-13
5632	-63.784	-59.376	3.200	12.100	-50.476	-13

Note:

1. Receiver setting (Peak Detector) : RBW:1MHz; VBW:3MHz
2. EIRP Value = Signal Generator Level + Antenna Gain - Cable Loss
3. Spurious emissions past 6 GHz are not shown, due to the magnitude of spurious emissions attenuated more than 20 dB below the limit.

7. Frequency Stability Under Temperature & Voltage Variations

7.1. Test Specification

According to FCC Part 2.1055, 24.235, 27.54
 RSS GEN, RSS 130, RSS 133, RSS 139

7.2. Test Setup

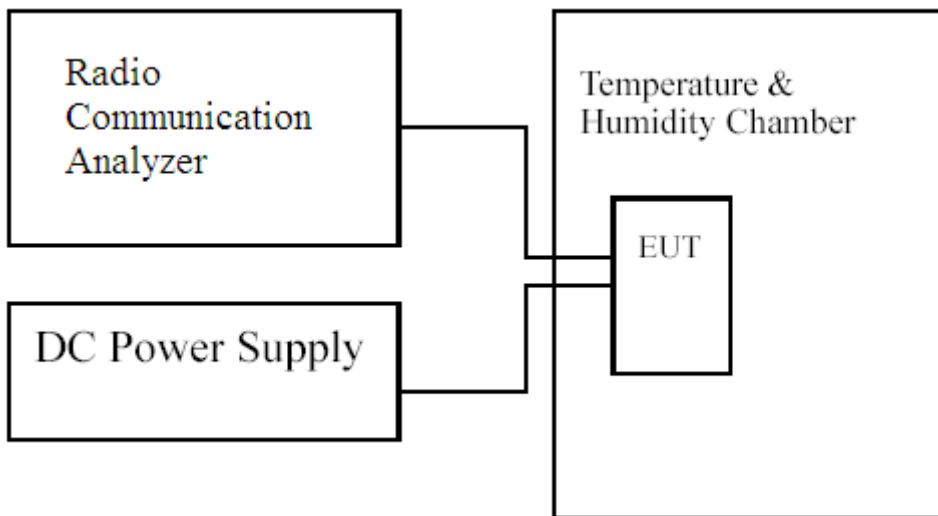

7.3. Limits

Limit	<±2.5ppm
--------------	--------------------

7.4. Test Procedure

The frequency stability of transmitter is measured by:

- (a) Temperature: The temperature is varied from -30 °C to 50 °C in 10 °C increment using a standard temperature & Humidity chamber.
- (b) Primary Supply Voltage: The primary supply voltage is varied 85% to 115% of the nominal value for non hand-carried equipment. For hand-carried, battery-powered equipment, primary supply voltage is reduced to the battery operating endpoint which shall be specified by the manufacturer.

The EUT was connected via the base station simulator. Universal Radio Communication Tester, (MT8820C), was used to measure The Frequency Error. The maximum result of measurements was recorded.

7.5. Test Result of Frequency Stability Under Temperature Variations

Product	LE910C1-NA		
Test Mode	Frequency Stability Under Temperature Variations & Voltage Variations		
Date of Test	2017/02/21	Test Site	CTR
Test Condition	Band 2 (1.4M) CH18900(1880MHz) –QPSK	Test Range	-20°C ~+50°C

Frequency Stability Under Temperature Variations

Temperature Interval(°C)	Test Frequency (GHz)	Deviation (kHz)	Limit (kHz)
-30	1.88	-0.0118	±4.70
-20	1.88	-0.0084	±4.70
-10	1.88	-0.0109	±4.70
0	1.88	-0.0103	±4.70
10	1.88	-0.0078	±4.70
20	1.88	-0.0090	±4.70
30	1.88	-0.0089	±4.70
40	1.88	-0.0076	±4.70
50	1.88	-0.0095	±4.70

Voltage Variations

AC Voltage (V)	Test Frequency (GHz)	Deviation (kHz)	Limit (kHz)
138	1.88	-0.0088	±4.70
120	1.88	-0.0090	±4.70
102	1.88	-0.0078	±4.70

Product	LE910C1-NA		
Test Mode	Frequency Stability Under Temperature Variations & Voltage Variations		
Date of Test	2017/02/21	Test Site	CTR
Test Condition	Band 2 (1.4M) CH18900(1880MHz) -16QAM	Test Range	-20°C ~+50°C

Frequency Stability Under Temperature Variations

Temperature Interval(°C)	Test Frequency (GHz)	Deviation (kHz)	Limit (kHz)
-30	1.88	-0.0098	±4.70
-20	1.88	-0.0052	±4.70
-10	1.88	-0.0069	±4.70
0	1.88	-0.0055	±4.70
10	1.88	-0.0083	±4.70
20	1.88	-0.0097	±4.70
30	1.88	-0.0101	±4.70
40	1.88	-0.0092	±4.70
50	1.88	-0.0079	±4.70

Voltage Variations

AC Voltage (V)	Test Frequency (GHz)	Deviation (kHz)	Limit (kHz)
138	1.88	-0.0097	±4.70
120	1.88	-0.0097	±4.70
102	1.88	-0.0096	±4.70

Product	LE910C1-NA		
Test Mode	Frequency Stability Under Temperature Variations & Voltage Variations		
Date of Test	2017/02/21	Test Site	CTR
Test Condition	Band 2 (3M) CH18900(1880MHz) –QPSK	Test Range	-30°C ~+50°C

Frequency Stability Under Temperature Variations

Temperature Interval(°C)	Test Frequency (GHz)	Deviation (kHz)	Limit (kHz)
-30	1.88	-0.0095	±4.70
-20	1.88	-0.0069	±4.70
-10	1.88	-0.0096	±4.70
0	1.88	-0.0128	±4.70
10	1.88	-0.0072	±4.70
20	1.88	-0.0101	±4.70
30	1.88	-0.0093	±4.70
40	1.88	-0.0095	±4.70
50	1.88	-0.0091	±4.70

Voltage Variations

AC Voltage (V)	Test Frequency (GHz)	Deviation (kHz)	Limit (kHz)
138	1.88	0.0094	±4.70
120	1.88	-0.0101	±4.70
102	1.88	-0.0097	±4.70

Product	LE910C1-NA		
Test Mode	Frequency Stability Under Temperature Variations & Voltage Variations		
Date of Test	2017/02/21	Test Site	CTR
Test Condition	Band 2 (3M) CH18900(1880MHz) -16QAM	Test Range	-30°C ~+50°C

Frequency Stability Under Temperature Variations

Temperature Interval(°C)	Test Frequency (GHz)	Deviation (kHz)	Limit (kHz)
-30	1.88	-0.0079	±4.70
-20	1.88	-0.0085	±4.70
-10	1.88	-0.0078	±4.70
0	1.88	-0.0113	±4.70
10	1.88	-0.0089	±4.70
20	1.88	-0.0077	±4.70
30	1.88	-0.0058	±4.70
40	1.88	-0.0083	±4.70
50	1.88	-0.0079	±4.70

Voltage Variations

AC Voltage (V)	Test Frequency (GHz)	Deviation (kHz)	Limit (kHz)
138	1.88	-0.0095	±4.70
120	1.88	-0.0077	±4.70
102	1.88	0.0051	±4.70

Product	LE910C1-NA		
Test Mode	Frequency Stability Under Temperature Variations & Voltage Variations		
Date of Test	2017/02/21	Test Site	CTR
Test Condition	Band 2 (5M) CH18900(1880MHz) –QPSK	Test Range	-20°C ~+50°C

Frequency Stability Under Temperature Variations

Temperature Interval(°C)	Test Frequency (GHz)	Deviation (kHz)	Limit (kHz)
-30	1.88	-0.0107	±4.70
-20	1.88	-0.0106	±4.70
-10	1.88	-0.0078	±4.70
0	1.88	-0.0091	±4.70
10	1.88	-0.0072	±4.70
20	1.88	-0.0090	±4.70
30	1.88	-0.0097	±4.70
40	1.88	-0.0089	±4.70
50	1.88	-0.0075	±4.70

Voltage Variations

AC Voltage (V)	Test Frequency (GHz)	Deviation (kHz)	Limit (kHz)
138	1.88	-0.0077	±4.70
120	1.88	-0.0090	±4.70
102	1.88	-0.0085	±4.70

Product	LE910C1-NA		
Test Mode	Frequency Stability Under Temperature Variations & Voltage Variations		
Date of Test	2017/02/21	Test Site	CTR
Test Condition	Band 2 (5M) CH18900(1880MHz) –16QAM	Test Range	-20°C ~+50°C

Frequency Stability Under Temperature Variations

Temperature Interval(°C)	Test Frequency (GHz)	Deviation (kHz)	Limit (kHz)
-30	1.88	-0.0088	±4.70
-20	1.88	-0.0105	±4.70
-10	1.88	-0.0081	±4.70
0	1.88	-0.0079	±4.70
10	1.88	-0.0086	±4.70
20	1.88	-0.0075	±4.70
30	1.88	-0.0095	±4.70
40	1.88	-0.0081	±4.70
50	1.88	-0.0086	±4.70

Voltage Variations

AC Voltage (V)	Test Frequency (GHz)	Deviation (kHz)	Limit (kHz)
138	1.88	-0.0070	±4.70
120	1.88	-0.0075	±4.70
102	1.88	-0.0083	±4.70

Product	LE910C1-NA		
Test Mode	Frequency Stability Under Temperature Variations & Voltage Variations		
Date of Test	2017/02/21	Test Site	CTR
Test Condition	Band 2 (10M) CH18900(1880MHz) -QPSK	Test Range	-30°C ~+50°C

Frequency Stability Under Temperature Variations

Temperature Interval(°C)	Test Frequency (GHz)	Deviation (kHz)	Limit (kHz)
-30	1.88	-0.0100	±4.70
-20	1.88	-0.0074	±4.70
-10	1.88	-0.0069	±4.70
0	1.88	-0.0071	±4.70
10	1.88	-0.0063	±4.70
20	1.88	-0.0079	±4.70
30	1.88	-0.0068	±4.70
40	1.88	-0.0072	±4.70
50	1.88	-0.0098	±4.70

Voltage Variations

AC Voltage (V)	Test Frequency (GHz)	Deviation (kHz)	Limit (kHz)
138	1.88	-0.0071	±4.70
120	1.88	-0.0079	±4.70
102	1.88	-0.0097	±4.70

Product	LE910C1-NA		
Test Mode	Frequency Stability Under Temperature Variations & Voltage Variations		
Date of Test	2017/02/21	Test Site	CTR
Test Condition	Band 4 (1.4M) CH20175(1732.5MHz) –QPSK	Test Range	-20°C ~+50°C

Frequency Stability Under Temperature Variations

Temperature Interval(°C)	Test Frequency (GHz)	Deviation (kHz)	Limit (kHz)
-30	1.73	0.0047	±4.33
-20	1.73	0.0062	±4.33
-10	1.73	0.0100	±4.33
0	1.73	0.0091	±4.33
10	1.73	0.0076	±4.33
20	1.73	0.0078	±4.33
30	1.73	-0.0060	±4.33
40	1.73	0.0043	±4.33
50	1.73	0.0052	±4.33

Voltage Variations

AC Voltage (V)	Test Frequency (GHz)	Deviation (kHz)	Limit (kHz)
138	1.73	-0.0072	±4.33
120	1.73	0.0078	±4.33
102	1.73	0.0089	±4.33

Product	LE910C1-NA		
Test Mode	Frequency Stability Under Temperature Variations & Voltage Variations		
Date of Test	2017/02/21	Test Site	CTR
Test Condition	Band 4 (1.4M) CH20175(1732.5MHz) –16QAM	Test Range	-20°C ~+50°C

Frequency Stability Under Temperature Variations

Temperature Interval(°C)	Test Frequency (GHz)	Deviation (kHz)	Limit (kHz)
-30	1.73	-0.0052	±4.33
-20	1.73	0.0076	±4.33
-10	1.73	0.0064	±4.33
0	1.73	0.0090	±4.33
10	1.73	0.0053	±4.33
20	1.73	0.0058	±4.33
30	1.73	0.0046	±4.33
40	1.73	-0.0055	±4.33
50	1.73	-0.0050	±4.33

Voltage Variations

AC Voltage (V)	Test Frequency (GHz)	Deviation (kHz)	Limit (kHz)
138	1.73	0.0058	±4.33
120	1.73	0.0058	±4.33
102	1.73	0.0063	±4.33

Product	LE910C1-NA		
Test Mode	Frequency Stability Under Temperature Variations & Voltage Variations		
Date of Test	2017/02/21	Test Site	CTR
Test Condition	Band 4 (3M) CH20175(1732.5MHz) –QPSK	Test Range	-30°C ~+50°C

Frequency Stability Under Temperature Variations

Temperature Interval(°C)	Test Frequency (GHz)	Deviation (kHz)	Limit (kHz)
-30	1.73	0.0085	±4.33
-20	1.73	0.0144	±4.33
-10	1.73	0.0088	±4.33
0	1.73	0.0089	±4.33
10	1.73	0.0102	±4.33
20	1.73	0.0076	±4.33
30	1.73	0.0058	±4.33
40	1.73	0.0065	±4.33
50	1.73	0.0060	±4.33

Voltage Variations

AC Voltage (V)	Test Frequency (GHz)	Deviation (kHz)	Limit (kHz)
138	1.73	0.0061	±4.33
120	1.73	0.0076	±4.33
102	1.73	0.0070	±4.33

Product	LE910C1-NA		
Test Mode	Frequency Stability Under Temperature Variations & Voltage Variations		
Date of Test	2017/02/21	Test Site	CTR
Test Condition	Band 4 (3M) CH20175(1732.5MHz) -16QAM	Test Range	-30°C ~+50°C

Frequency Stability Under Temperature Variations

Temperature Interval(°C)	Test Frequency (GHz)	Deviation (kHz)	Limit (kHz)
-30	1.73	0.0068	±4.33
-20	1.73	0.0096	±4.33
-10	1.73	-0.0074	±4.33
0	1.73	0.0085	±4.33
10	1.73	0.0096	±4.33
20	1.73	0.0092	±4.33
30	1.73	-0.0082	±4.33
40	1.73	0.0071	±4.33
50	1.73	-0.0067	±4.33

Voltage Variations

AC Voltage (V)	Test Frequency (GHz)	Deviation (kHz)	Limit (kHz)
138	1.73	0.0095	±4.33
120	1.73	0.0092	±4.33
102	1.73	0.0087	±4.33

Product	LE910C1-NA		
Test Mode	Frequency Stability Under Temperature Variations & Voltage Variations		
Date of Test	2017/02/21	Test Site	CTR
Test Condition	Band 4 (5M) CH20175(1732.5MHz) –QPSK	Test Range	-20°C ~+50°C

Frequency Stability Under Temperature Variations

Temperature Interval(°C)	Test Frequency (GHz)	Deviation (kHz)	Limit (kHz)
-30	1.73	0.0072	±4.33
-20	1.73	0.0056	±4.33
-10	1.73	0.0064	±4.33
0	1.73	0.0072	±4.33
10	1.73	0.0074	±4.33
20	1.73	0.0077	±4.33
30	1.73	0.0064	±4.33
40	1.73	0.0052	±4.33
50	1.73	0.0061	±4.33

Voltage Variations

AC Voltage (V)	Test Frequency (GHz)	Deviation (kHz)	Limit (kHz)
138	1.73	0.0086	±4.33
120	1.73	0.0077	±4.33
102	1.73	-0.0051	±4.33

Product	LE910C1-NA		
Test Mode	Frequency Stability Under Temperature Variations & Voltage Variations		
Date of Test	2017/02/21	Test Site	CTR
Test Condition	Band 4 (5M) CH20175(1732.5MHz) –16QAM	Test Range	-20°C ~+50°C

Frequency Stability Under Temperature Variations

Temperature Interval(°C)	Test Frequency (GHz)	Deviation (kHz)	Limit (kHz)
-30	1.73	-0.0078	±4.33
-20	1.73	-0.0064	±4.33
-10	1.73	0.0094	±4.33
0	1.73	0.0074	±4.33
10	1.73	0.0065	±4.33
20	1.73	0.0061	±4.33
30	1.73	0.0049	±4.33
40	1.73	0.0070	±4.33
50	1.73	-0.0062	±4.33

Voltage Variations

AC Voltage (V)	Test Frequency (GHz)	Deviation (kHz)	Limit (kHz)
138	1.73	0.0052	±4.33
120	1.73	0.0061	±4.33
102	1.73	0.0065	±4.33

Product	LE910C1-NA		
Test Mode	Frequency Stability Under Temperature Variations & Voltage Variations		
Date of Test	2017/02/21	Test Site	CTR
Test Condition	Band 4 (10M) CH20175(1732.5MHz)-QPSK	Test Range	-30°C ~+50°C

Frequency Stability Under Temperature Variations

Temperature Interval(°C)	Test Frequency (GHz)	Deviation (kHz)	Limit (kHz)
-30	1.73	0.0065	±4.33
-20	1.73	0.0079	±4.33
-10	1.73	0.0072	±4.33
0	1.73	0.0050	±4.33
10	1.73	0.0080	±4.33
20	1.73	0.0070	±4.33
30	1.73	-0.0064	±4.33
40	1.73	-0.0075	±4.33
50	1.73	0.0090	±4.33

Voltage Variations

AC Voltage (V)	Test Frequency (GHz)	Deviation (kHz)	Limit (kHz)
138	1.73	0.0074	±4.33
120	1.73	0.0070	±4.33
102	1.73	0.0082	±4.33

Product	LE910C1-NA		
Test Mode	Frequency Stability Under Temperature Variations & Voltage Variations		
Date of Test	2017/02/21	Test Site	CTR
Test Condition	Band 12 (1.4M) CH23095(707.5MHz)-QPSK	Test Range	-30°C ~+50°C

Frequency Stability Under Temperature Variations

Temperature Interval(°C)	Test Frequency (GHz)	Deviation (kHz)	Limit (kHz)
-30	0.708	-0.0050	±1.77
-20	0.708	0.0030	±1.77
-10	0.708	0.0045	±1.77
0	0.708	0.0049	±1.77
10	0.708	0.0044	±1.77
20	0.708	0.0061	±1.77
30	0.708	0.0047	±1.77
40	0.708	-0.0038	±1.77
50	0.708	0.0042	±1.77

Voltage Variations

AC Voltage (V)	Test Frequency (GHz)	Deviation (kHz)	Limit (kHz)
138	0.708	0.0047	±1.77
120	0.708	0.0061	±1.77
102	0.708	-0.0031	±1.77

Product	LE910C1-NA		
Test Mode	Frequency Stability Under Temperature Variations & Voltage Variations		
Date of Test	2017/02/21	Test Site	CTR
Test Condition	Band 12 (1.4M) CH23095(707.5MHz)-16QAM	Test Range	-30°C ~+50°C

Frequency Stability Under Temperature Variations

Temperature Interval(°C)	Test Frequency (GHz)	Deviation (kHz)	Limit (kHz)
-30	0.708	-0.0052	±1.77
-20	0.708	0.0042	±1.77
-10	0.708	0.0066	±1.77
0	0.708	-0.0035	±1.77
10	0.708	0.0037	±1.77
20	0.708	0.0045	±1.77
30	0.708	-0.0045	±1.77
40	0.708	0.0046	±1.77
50	0.708	-0.0054	±1.77

Voltage Variations

AC Voltage (V)	Test Frequency (GHz)	Deviation (kHz)	Limit (kHz)
138	0.708	0.0033	±1.77
120	0.708	0.0045	±1.77
102	0.708	0.0042	±1.77

Product	LE910C1-NA		
Test Mode	Frequency Stability Under Temperature Variations & Voltage Variations		
Date of Test	2017/02/21	Test Site	CTR
Test Condition	Band 12 (3M) CH23095(707.5MHz)-QPSK	Test Range	-30°C ~+50°C

Frequency Stability Under Temperature Variations

Temperature Interval(°C)	Test Frequency (GHz)	Deviation (kHz)	Limit (kHz)
-30	0.708	0.0048	±1.77
-20	0.708	0.0035	±1.77
-10	0.708	0.0059	±1.77
0	0.708	0.0070	±1.77
10	0.708	-0.0061	±1.77
20	0.708	0.0075	±1.77
30	0.708	-0.0061	±1.77
40	0.708	-0.0050	±1.77
50	0.708	-0.0042	±1.77

Voltage Variations

AC Voltage (V)	Test Frequency (GHz)	Deviation (kHz)	Limit (kHz)
138	0.708	0.0052	±1.77
120	0.708	0.0075	±1.77
102	0.708	0.0047	±1.77

Product	LE910C1-NA		
Test Mode	Frequency Stability Under Temperature Variations & Voltage Variations		
Date of Test	2017/02/21	Test Site	CTR
Test Condition	Band 12 (3M) CH23095(707.5MHz)-16QAM	Test Range	-30°C ~+50°C

Frequency Stability Under Temperature Variations

Temperature Interval(°C)	Test Frequency (GHz)	Deviation (kHz)	Limit (kHz)
-30	0.708	-0.0044	±1.77
-20	0.708	-0.0041	±1.77
-10	0.708	0.0052	±1.77
0	0.708	0.0036	±1.77
10	0.708	-0.0044	±1.77
20	0.708	0.0053	±1.77
30	0.708	0.0049	±1.77
40	0.708	-0.0054	±1.77
50	0.708	-0.0037	±1.77

Voltage Variations

AC Voltage (V)	Test Frequency (GHz)	Deviation (kHz)	Limit (kHz)
138	0.708	0.0069	±1.77
120	0.708	0.0053	±1.77
102	0.708	-0.0042	±1.77

Product	LE910C1-NA		
Test Mode	Frequency Stability Under Temperature Variations & Voltage Variations		
Date of Test	2017/02/21	Test Site	CTR
Test Condition	Band 12 (5M) CH23095(707.5MHz)-QPSK	Test Range	-30°C ~+50°C

Frequency Stability Under Temperature Variations

Temperature Interval(°C)	Test Frequency (GHz)	Deviation (kHz)	Limit (kHz)
-30	0.708	-0.0032	±1.77
-20	0.708	-0.0026	±1.77
-10	0.708	0.0034	±1.77
0	0.708	0.0047	±1.77
10	0.708	-0.0035	±1.77
20	0.708	0.0032	±1.77
30	0.708	-0.0048	±1.77
40	0.708	-0.0031	±1.77
50	0.708	0.0038	±1.77

Voltage Variations

AC Voltage (V)	Test Frequency (GHz)	Deviation (kHz)	Limit (kHz)
138	0.708	0.0030	±1.77
120	0.708	0.0032	±1.77
102	0.708	0.0048	±1.77

Product	LE910C1-NA		
Test Mode	Frequency Stability Under Temperature Variations & Voltage Variations		
Date of Test	2017/02/21	Test Site	CTR
Test Condition	Band 12 (5M) CH23095(707.5MHz)-16QAM	Test Range	-30°C ~+50°C

Frequency Stability Under Temperature Variations

Temperature Interval(°C)	Test Frequency (GHz)	Deviation (kHz)	Limit (kHz)
-30	0.708	-0.0041	±1.77
-20	0.708	-0.0031	±1.77
-10	0.708	0.0033	±1.77
0	0.708	0.0049	±1.77
10	0.708	-0.0031	±1.77
20	0.708	0.0041	±1.77
30	0.708	-0.0039	±1.77
40	0.708	-0.0045	±1.77
50	0.708	-0.0037	±1.77

Voltage Variations

AC Voltage (V)	Test Frequency (GHz)	Deviation (kHz)	Limit (kHz)
138	0.708	-0.0044	±1.77
120	0.708	0.0041	±1.77
102	0.708	-0.0032	±1.77

Product	LE910C1-NA		
Test Mode	Frequency Stability Under Temperature Variations & Voltage Variations		
Date of Test	2017/02/21	Test Site	CTR
Test Condition	Band 12 (10M) CH23095(707.5MHz)-QPSK	Test Range	-30°C ~+50°C

Frequency Stability Under Temperature Variations

Temperature Interval(°C)	Test Frequency (GHz)	Deviation (kHz)	Limit (kHz)
-30	0.708	0.0038	±1.77
-20	0.708	-0.0042	±1.77
-10	0.708	-0.0041	±1.77
0	0.708	-0.0035	±1.77
10	0.708	0.0036	±1.77
20	0.708	0.0045	±1.77
30	0.708	0.0031	±1.77
40	0.708	-0.0028	±1.77
50	0.708	-0.0042	±1.77

Voltage Variations

AC Voltage (V)	Test Frequency (GHz)	Deviation (kHz)	Limit (kHz)
138	0.708	0.0038	±1.77
120	0.708	0.0045	±1.77
102	0.708	-0.0032	±1.77

8. Peak to Average Ratio

8.1 Test Specification

According to Part 24.232, 27.50(a), RSS 130, RSS 133, RSS 139

8.2 Test Setup

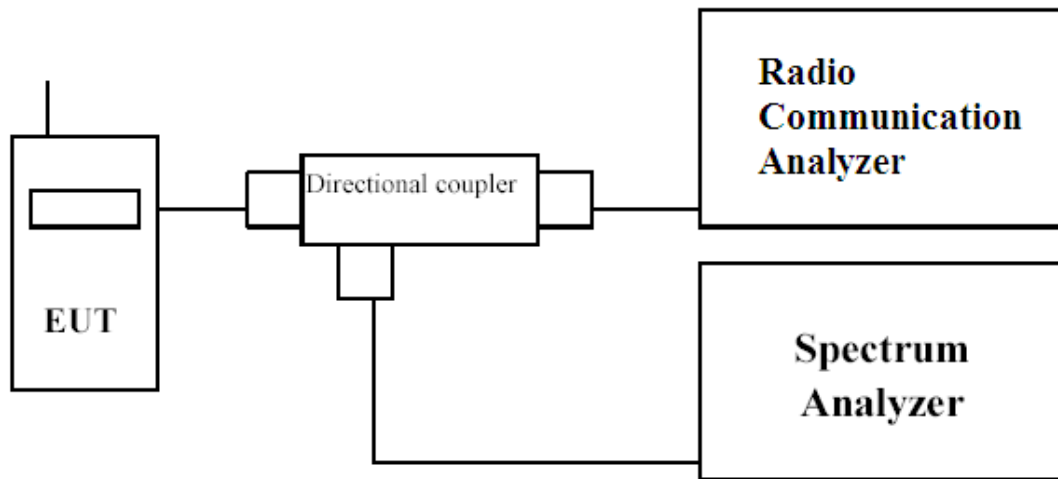

8.3 Limits

The peak-to-average power ratio (PAPR) of the transmitter output power must not exceed 13 dB. The PAPR measurements should be made using either an instrument with complementary cumulative distribution function (CCDF) capabilities to determine that PAPR will not exceed 13 dB for more than 0.1 percent of the time or other Commission approved procedure.

8.4 Test Procedure

- a) Refer to instrument's analyzer instruction manual for details on how to use the power statistics/CCDF function;
- b) Set resolution/measurement bandwidth \geq signal's occupied bandwidth;
- c) Set the number of counts to a value that stabilizes the measured CCDF curve;
- d) Set the measurement interval as follows:
 - 1) for continuous transmissions, set to 1 ms,
 - 2) for burst transmissions, employ an external trigger that is synchronized with the EUT burst timing sequence, or use the internal burst trigger with a trigger level that allows the burst to stabilize and set the measurement interval to a time that is less than or equal to the burst duration.
- e) Record the maximum PAPR level associated with a probability of 0.1%.

8.5 Test Result of Spurious Emission

Product	LE910C1-NA		
Test Mode	Peak to Average Ratio		
Date of Test	2016/12/15	Test Site	CTR
Test Condition	LTE-Band 2		

Band 2 (1.4M) QPSK CH18900 (1880MHz)

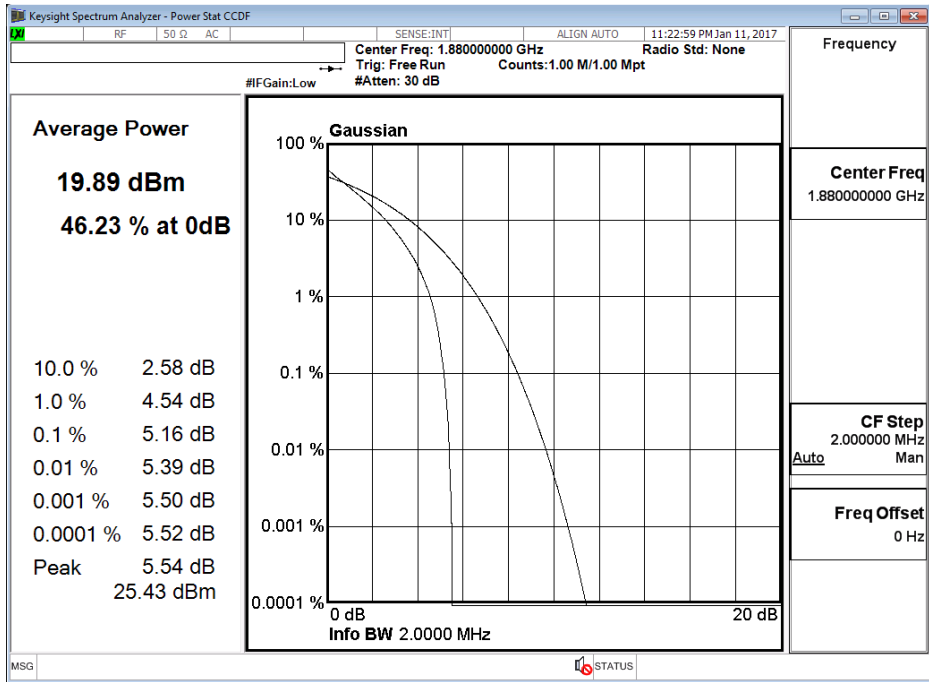

Band 2 (3M) QPSK CH18900 (1880MHz)

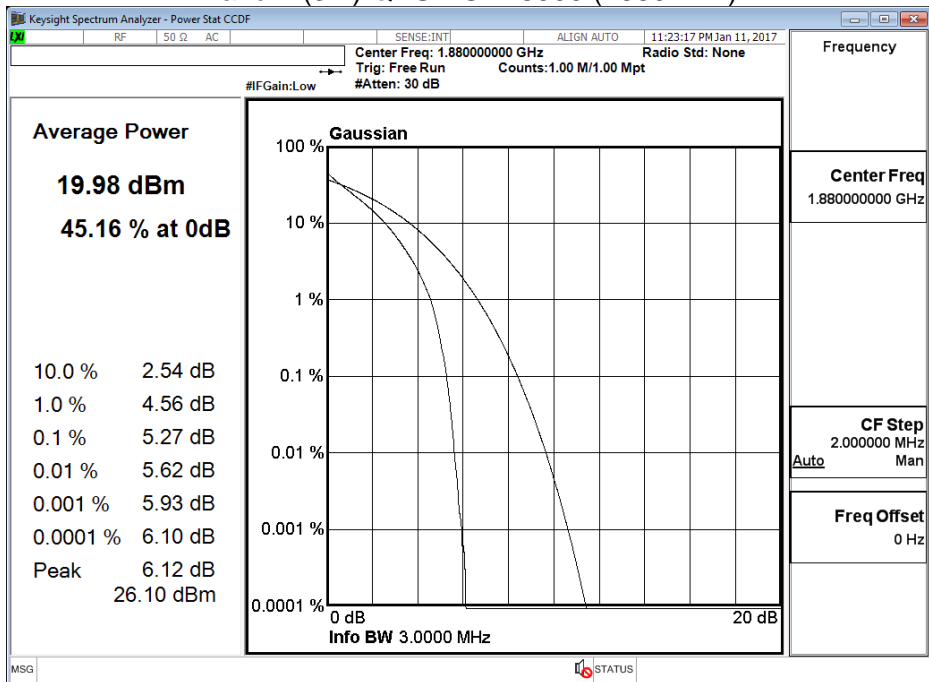

Band 2 (5M) QPSK CH18900 (1880MHz)

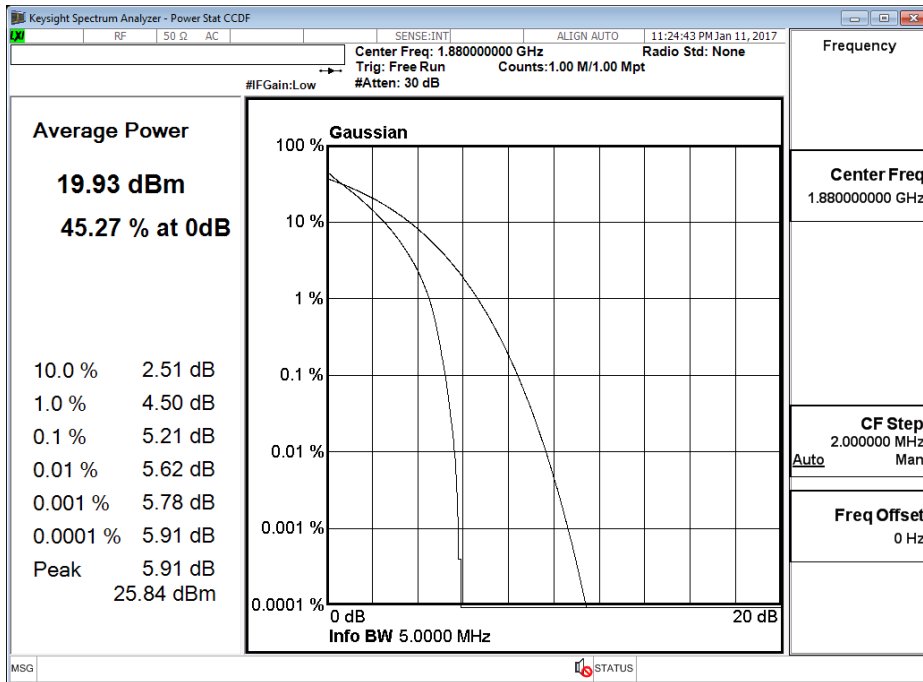

Band 2 (10M) QPSK CH18900 (1880MHz)

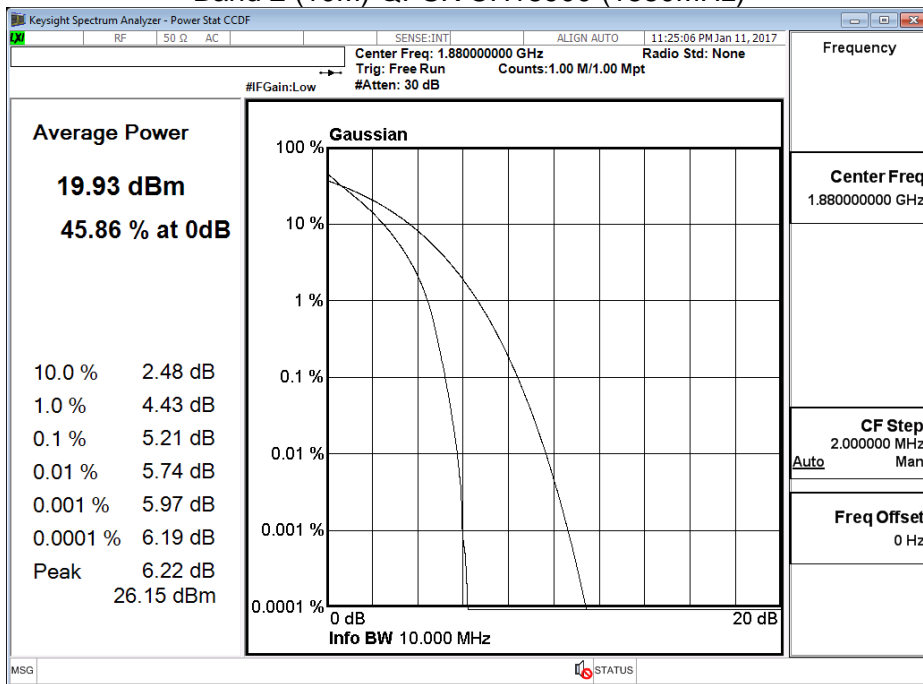

Band 2 (1.4M) 16QAM CH18900 (1880MHz)

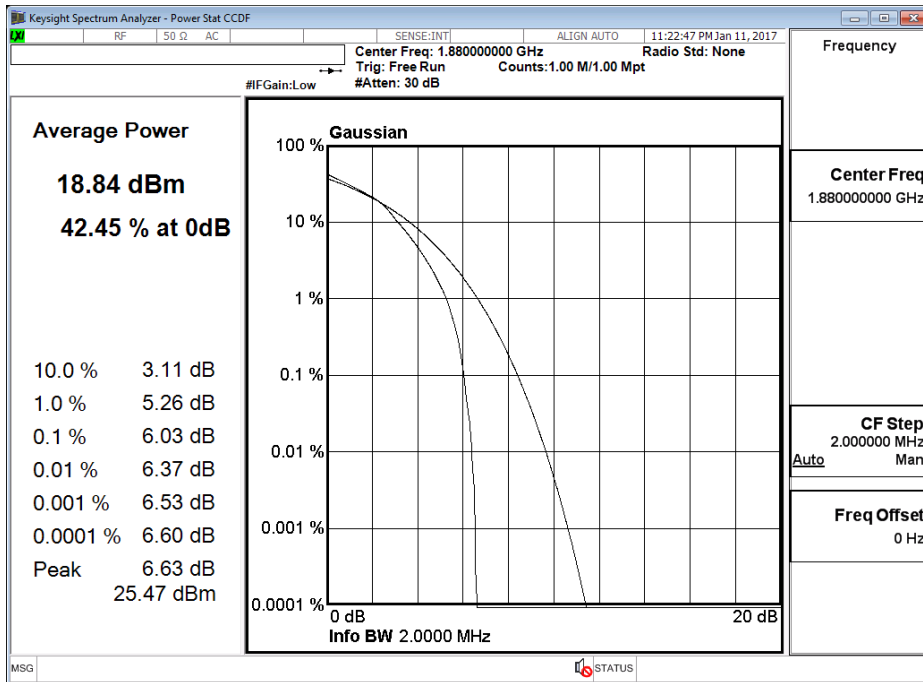

Band 2 (3M) 16QAM CH18900 (1880MHz)

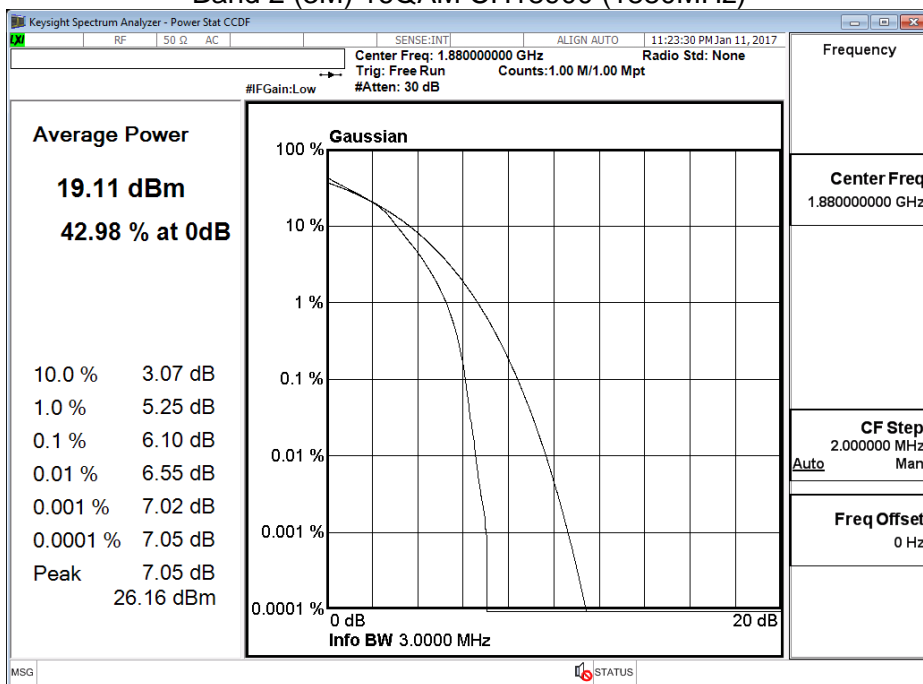

Band 2 (5M) 16QAM CH18900 (1880MHz)

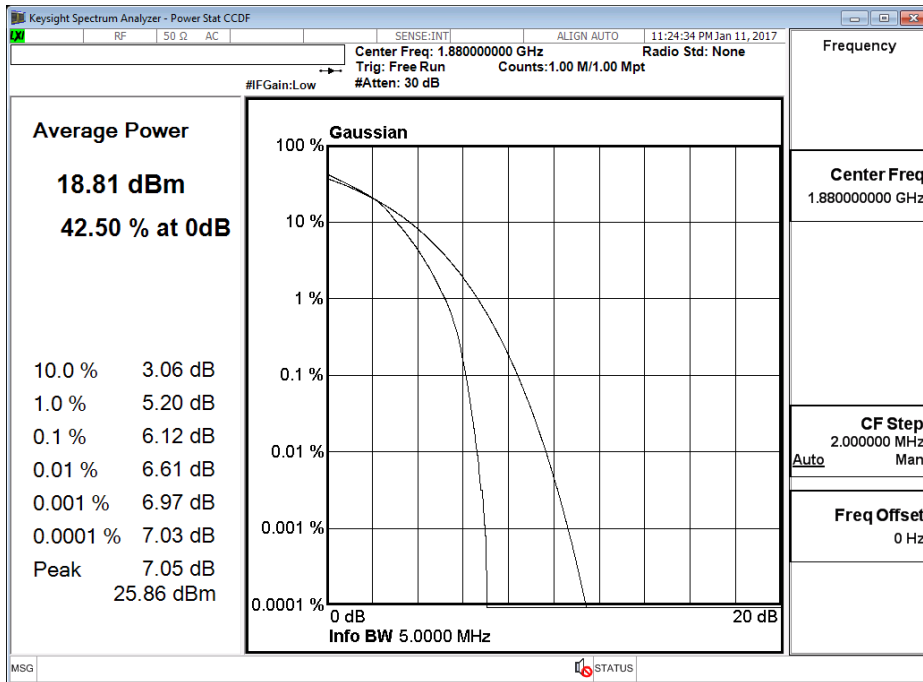

Product	LE910C1-NA		
Test Mode	Peak to Average Ratio		
Date of Test	2016/12/15	Test Site	CTR
Test Condition	LTE-Band 4		

Band 4 (1.4M) QPSK CH20175 (1732.5MHz)

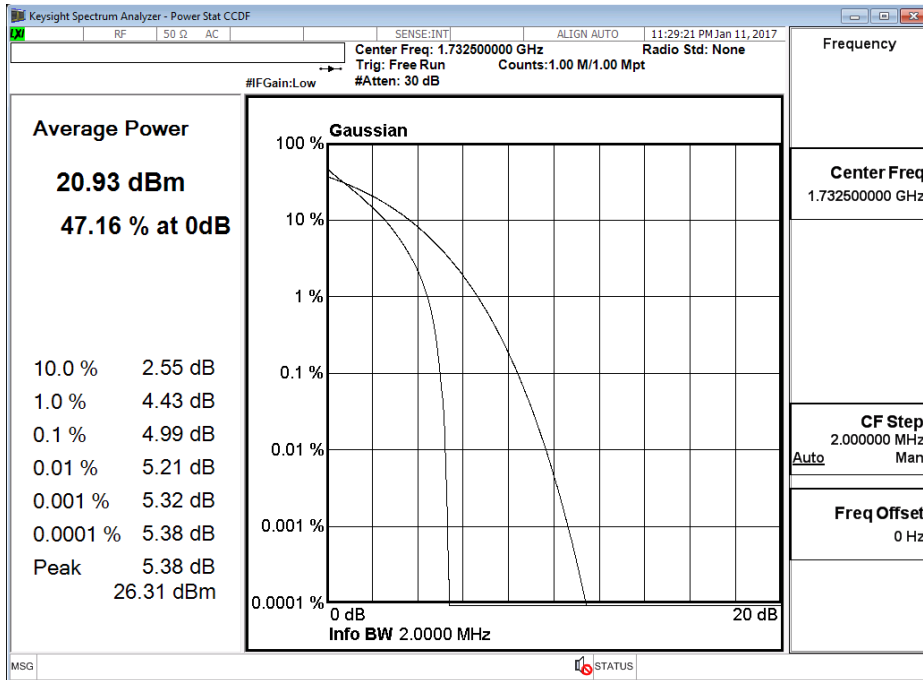

Band 4 (3M) QPSK CH20175 (1732.5MHz)

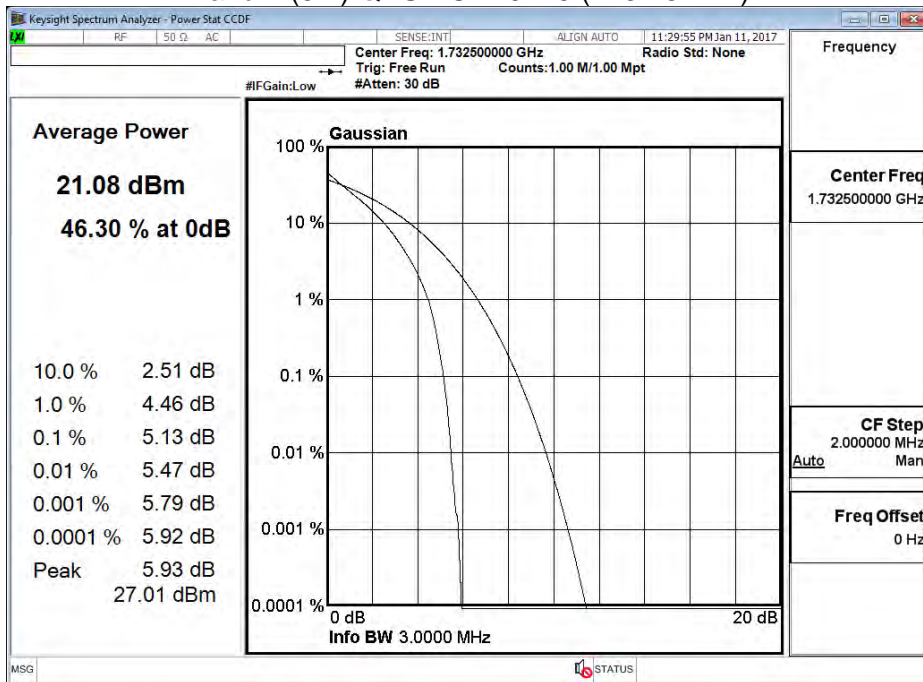

Band 4 (5M) QPSK CH20175 (1732.5MHz)

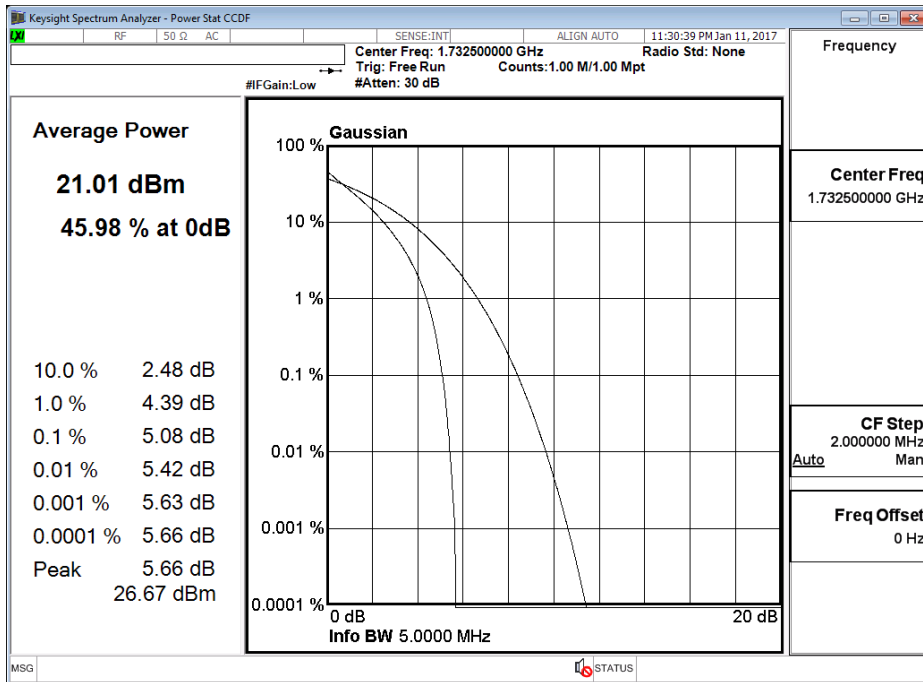

Band 4 (10M) QPSK CH20175 (1732.5MHz)

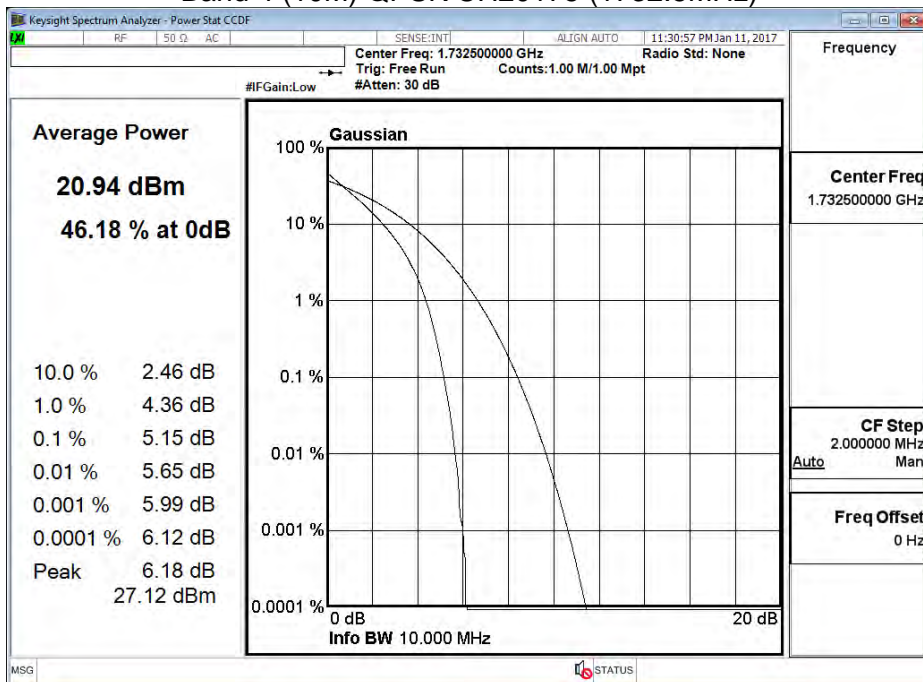

Band 4 (1.4M) 16QAM CH20175 (1732.5MHz)

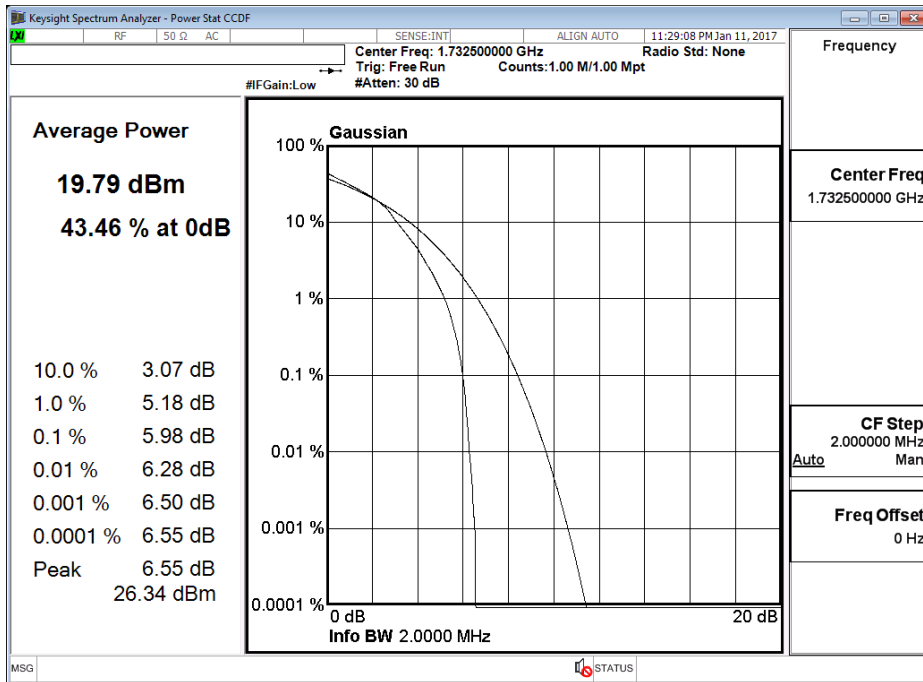

Band 4 (3M) 16QAM CH20175 (1732.5MHz)

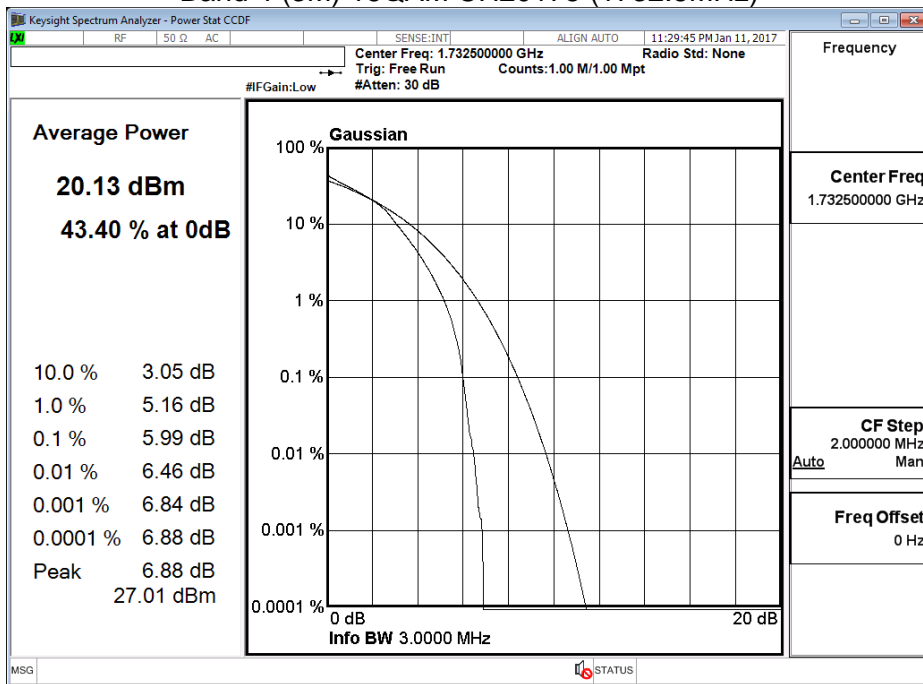

Band 4 (5M) 16QAM CH20175 (1732.5MHz)

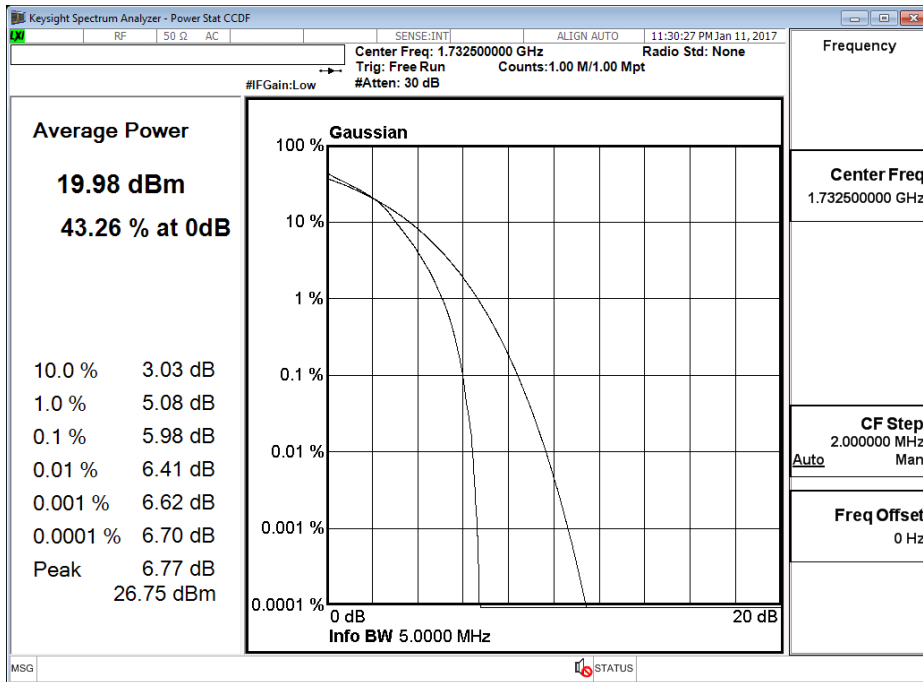

Product	LE910C1-NA		
Test Mode	Peak to Average Ratio		
Date of Test	2016/12/15	Test Site	CTR
Test Condition	LTE-Band 12		

Band 12 (1.4M) QPSK CH23095 (707.5MHz)

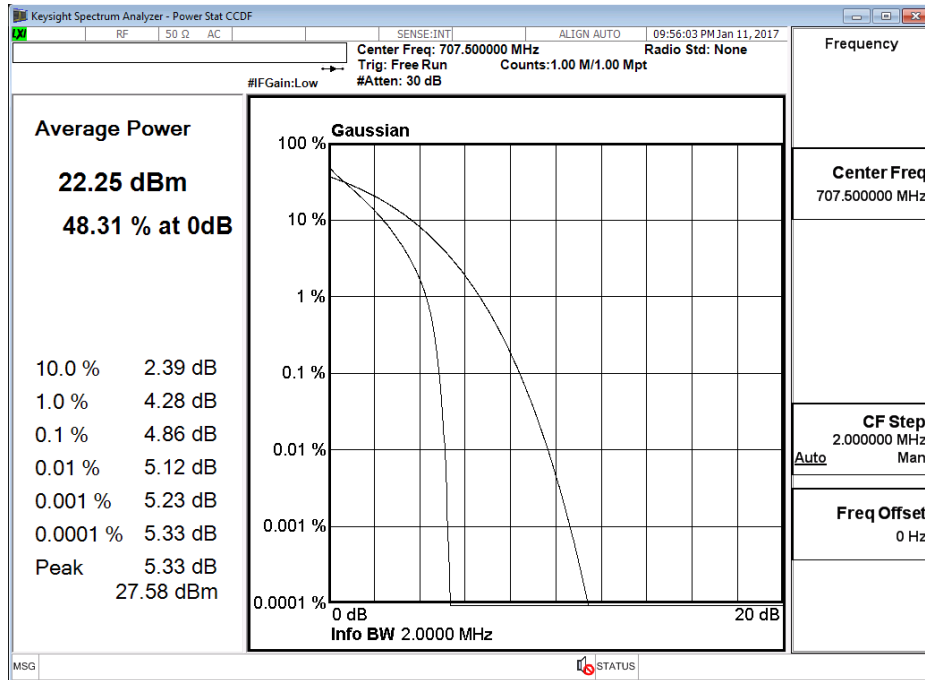

Band 12 (3M) QPSK CH23095 (707.5MHz)

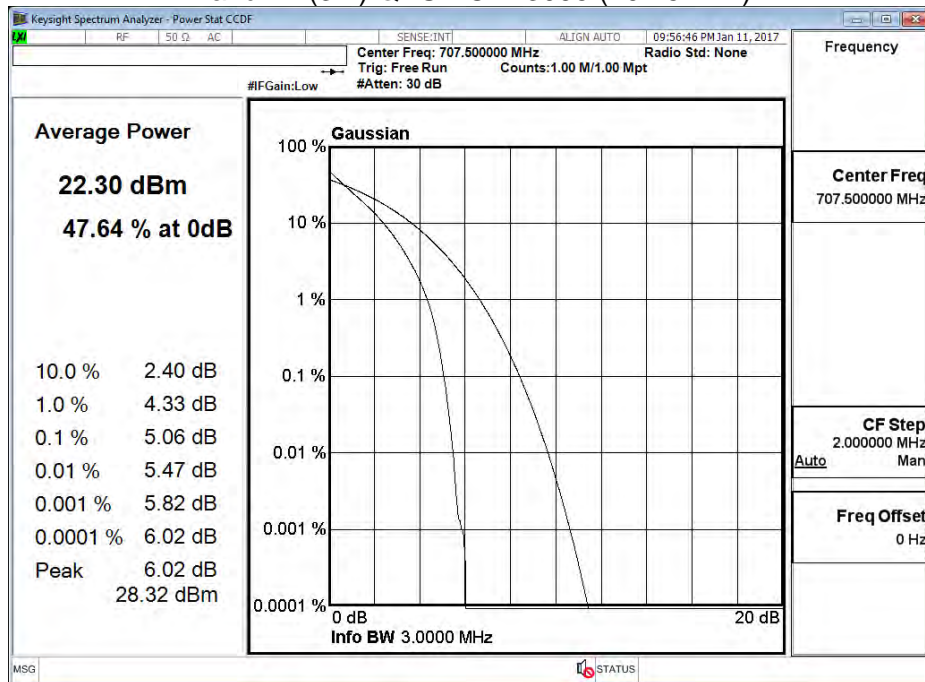

Band 12 (5M) QPSK CH23095 (707.5MHz)

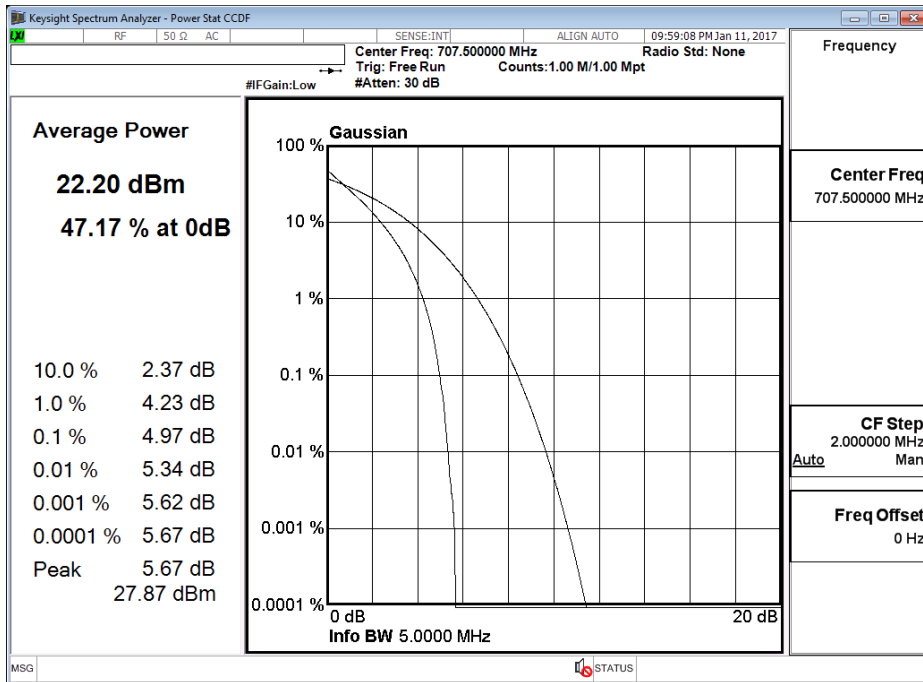

Band 12 (10M) QPSK CH23095 (707.5MHz)

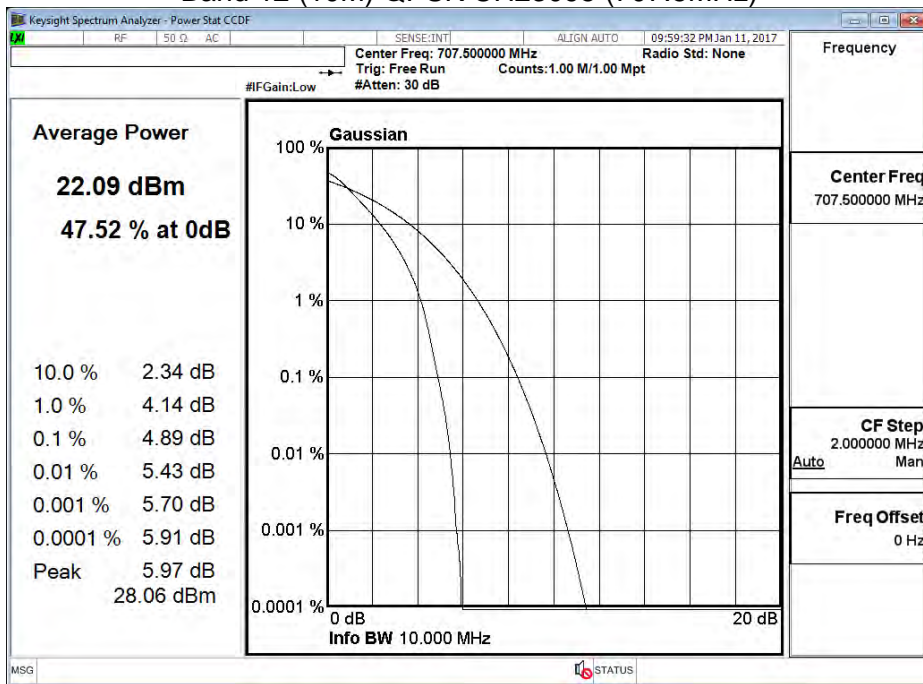

Band 12 (1.4M) 16QAM CH23095 (707.5MHz)

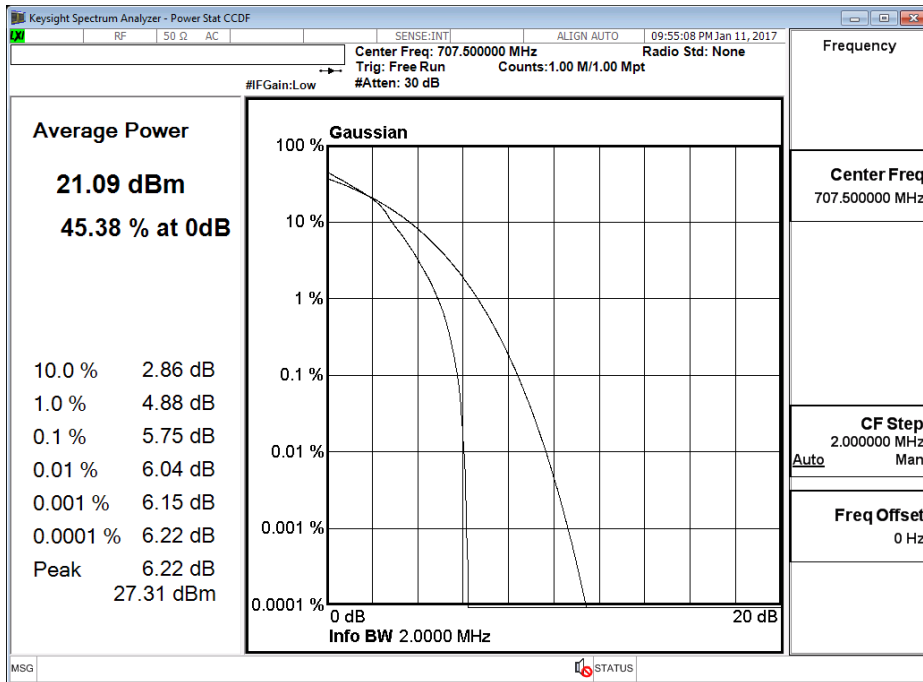

Band 12 (3M) 16QAM CH23095 (707.5MHz)

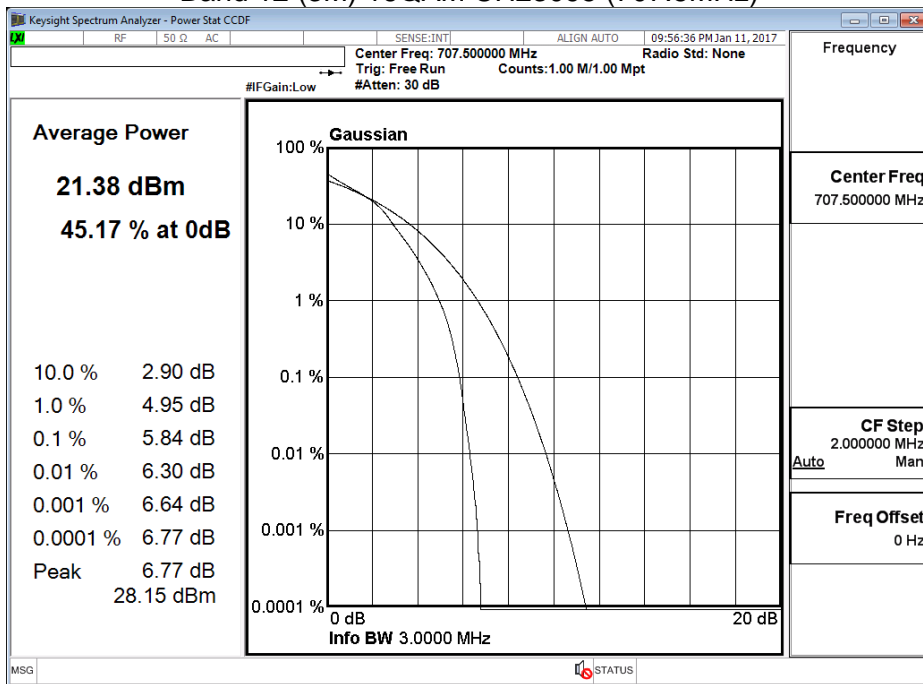

Band 12 (5M) 16QAM CH23095 (707.5MHz)

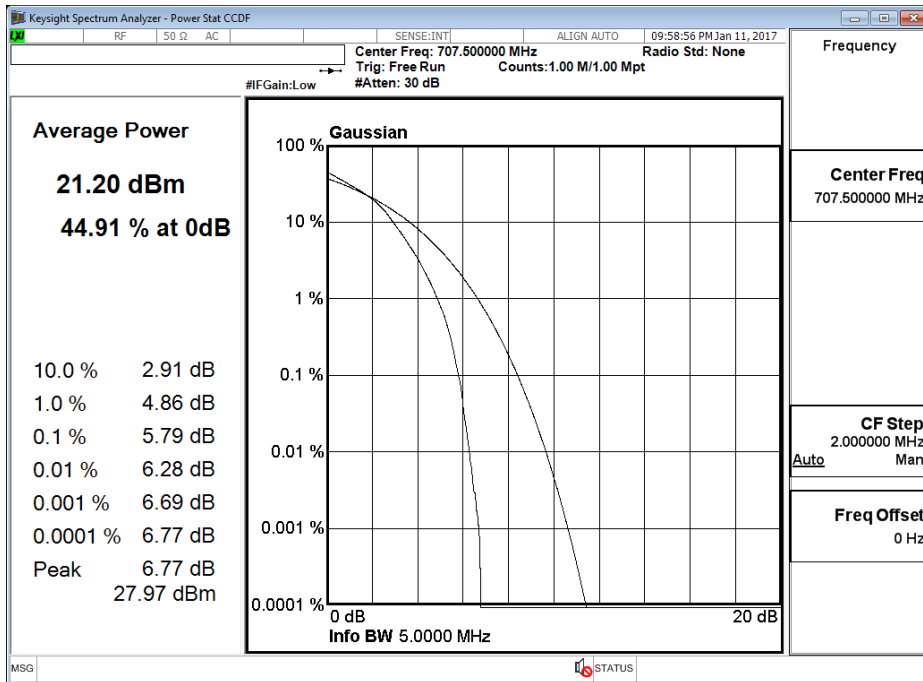

Attachment 1: EUT Test Photographs

Attachment 2: EUT Detailed Photographs