

FCC/IC Test Report

Product Name : LE910C1-NA
Trade Name : 
Model No. : LE910C1-NA
FCC ID. : RI7LE910C1NA
IC ID. : 5131A-LE910C1NA

Applicant : Telit Communications S.p.A.
Address : Viale Stazione di Prosecco, 5/B, 34010 Sgonico,
Trieste, Italy

Date of Receipt : Dec. 29, 2016
Issued Date : Feb. 24, 2017
Report No. : 1710065R-HPUSP40V00
Report Version : V1.0



The test results relate only to the samples tested.

The test report shall not be reproduced except in full without the written approval of DEKRA Testing and Certification Co., Ltd..

Test Report Certification

Issued Date : Feb. 24, 2017

Report No. :1710065R-HPUSP40V00



Product Name : LE910C1-NA
Applicant : Telit Communications S.p.A.
Address : Viale Stazione di Prosecco, 5/B, 34010 Sgonico, Trieste, Italy
Manufacturer : Telit Wireless Solutions Ltd.
Model No. : LE910C1-NA
FCC ID. : RI7LE910C1NA
IC ID. : 5131A-LE910C1NA
EUT Voltage : DC 3.8V
Testing Voltage : DC 3.8V
Trade Name : 
Applicable Standard : FCC CFR Title 47 Part 2
FCC CFR Title 47 Part 27 Subpart M
ANSI/TIA-603-D-2010
RSS Gen Issue 4
RSS 139 Issue 3
Test Lab : Hsin Chu Laboratory
Test Result : Complied

The test results relate only to the samples tested.

The test report shall not be reproduced except in full without the written approval of DEKRA Testing and Certification Co., Ltd..

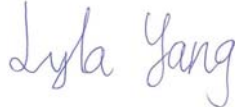
Documented By : 

(Lyla Yang / Engineering Adm. Assistant)

Tested By : 

(JuBo Shen / Senior Engineer)

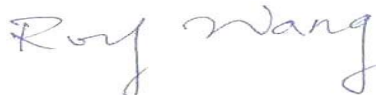
Approved By : 

(Roy Wang / Director)

Laboratory Information

We, **DEKRA Testing and Certification Co., Ltd.**, are an independent RF consultancy that was established the whole facility in our laboratories. The test facility has been accredited/accepted (audited or listed) by the following related bodies in compliance with ISO 17025 specified testing scopes:

Taiwan R.O.C. : TAF, Accreditation Number: 3024
USA : FCC, Registration Number: 834100
Canada : IC, Submission No: 181665
IC Registration Number: 22397-1 / 22397-2

The related certificate for our laboratories about the test site and management system can be downloaded from DEKRA Testing and Certification Co., Ltd. Web Site:

<http://www.dekra.com.tw/english/about/certificates.aspx?bval=5>

The address and introduction of DEKRA Testing and Certification Co., Ltd. laboratories can be founded in our Web site : http://www.dekra.com.tw/index_en.aspx

If you have any comments, Please don't hesitate to contact us. Our contact information is as below:

Hsin Chu Laboratory :

No. 75-2, 3rd Lin, WangYe Keng, Yonghxing Tsuen, Qionglin Shiang, Hsinchu County 307, Taiwan (R.O.C.)
TEL:+886-3-592-8858 / FAX:+886-3-592-8859 E-Mail : info.tw@dekra.com
No.372, Sec. 4, Zhongxing Rd., Zhudong Township, Hsinchu County 31061, Taiwan
No.372-2, Sec. 4, Zhongxing Rd., Zhudong Township, Hsinchu County 31061, Taiwan
TEL: +886-3-582-8001 / FAX: +886-3-582-8958 E-Mail : info.tw@dekra.com

Lin Kou Laboratory :

No. 5-22, Ruishukeng, Linkou Dist., New Taipei City 24451, Taiwan (R.O.C.)
TEL : +886-2-8601-3788 / FAX : +886-2-8601-3789 E-Mail : info.tw@dekra.com

TABLE OF CONTENTS

Description	Page
1. General Information	7
1.1. EUT Description	7
1.2. Test Mode.....	8
1.3. Tested System Details.....	9
1.4. Configuration of tested System	10
1.5. EUT Exercise Software	10
2. Technical Test.....	11
2.1. Summary of Test Result	11
2.2. Test Environment	11
3. Peak Output Power	12
3.1. Test Equipment	12
3.2. Test Setup	13
3.3. Limits.....	14
3.4. Test Procedure	14
3.5. Uncertainty	14
3.6. Test Result	15
4. Occupied Bandwidth.....	21
4.1. Test Equipment	21
4.2. Test Setup	21
4.3. Limits.....	21
4.4. Test Procedure	21
4.5. Uncertainty	21
4.6. Test Result	22
5. Band Edge	34
5.1. Test Equipment	34
5.2. Test Setup	34
5.3. Limits.....	34
5.4. Test Procedure	35
5.5. Uncertainty	35
5.6. Test Result	36
6. Conducted Spurious Emission.....	37
6.1. Test Equipment	37
6.2. Test Setup	37
6.3. Limits.....	38
6.4. Test Procedure	38
6.5. Uncertainty	38
6.6. Test Result	39
7. Radiated Spurious Emission.....	45
7.1. Test Equipment	45
7.2. Test Setup	45

7.3.	Limits	46
7.4.	Test Procedure	47
7.5.	Uncertainty	47
7.6.	Test Result	48
8.	Frequency Stability Over Temperatures Variation	96
8.1.	Test Equipment	96
8.2.	Test Setup	96
8.3.	Limits	96
8.4.	Test Procedure	96
8.5.	Uncertainty	96
8.6.	Test Result	97
9.	Frequency Stability Over Voltage Variation	99
9.1.	Test Equipment	99
9.2.	Test Setup	99
9.3.	Limits	99
9.4.	Test Procedure	100
9.5.	Uncertainty	100
9.6.	Test Result	101
Attachment 1	102
	Test Setup Photograph.....	102
Attachment 2	109
	EUT External Photograph	112
Attachment 3	113
	EUT Internal Photograph.....	113

1. General Information

1.1. EUT Description

Product Name	LE910C1-NA
Model No.	LE910C1-NA
Trade Name	
Tx Frequency Range/Channel number	WCDMA Band 4: 1712.4-1752.6 MHz
Rx Frequency Range/Channel number	WCDMA Band 4: 2112.4-2152.6 MHz
Type of Modulation	WCDMA: QPSK (Uplink); HSDPA: QPSK (Uplink)
HW Version	1.00
SW Version	25.00.211

Antenna Information	
Antenna Type	Dipole Antenna
Antenna Gain	0.99 dBi (698-960 MHz) 2.37 dBi (1710-2170 MHz) 2.81 dBi (2400-2700MHz)

Note:

This LE910C1-NA included GSM 850, DCS 1900, WCDMA Band 2, WCDMA Band 4 and WCDMA Band 5 transmitting and receiving function.

1.2. Test Mode

DEKRA has verified the construction and function in typical operation. The preliminary tests were performed in different data rate, and to find the worst condition, which was shown in this test report. The following table is the final test mode.

Final Test Model	
TX	Mode 1: WCDMA Band 4_Link Mode Mode 2: WCDMA Band 4_Idle Mode Mode 3: WCDMA Band 4_HSUPA Mode Mode 4: WCDMA Band 4_HSDPA Mode

1.3. Tested System Details

The types for all equipments, plus descriptions of all cables used in the tested system (including inserted cards) are:

Product	Manufacturer	Model No.	Serial No.	FCC ID	Power Cord
1 Fixture	Telit	CS1742C	1742C180000037	DoC	--
2 Horn	ELECTRO METRICS	EM6961	103326	DoC	--
3 Base Station Simulator	JRC	NJZ-2000	ET00477	DoC	--

1.4. Configuration of tested System

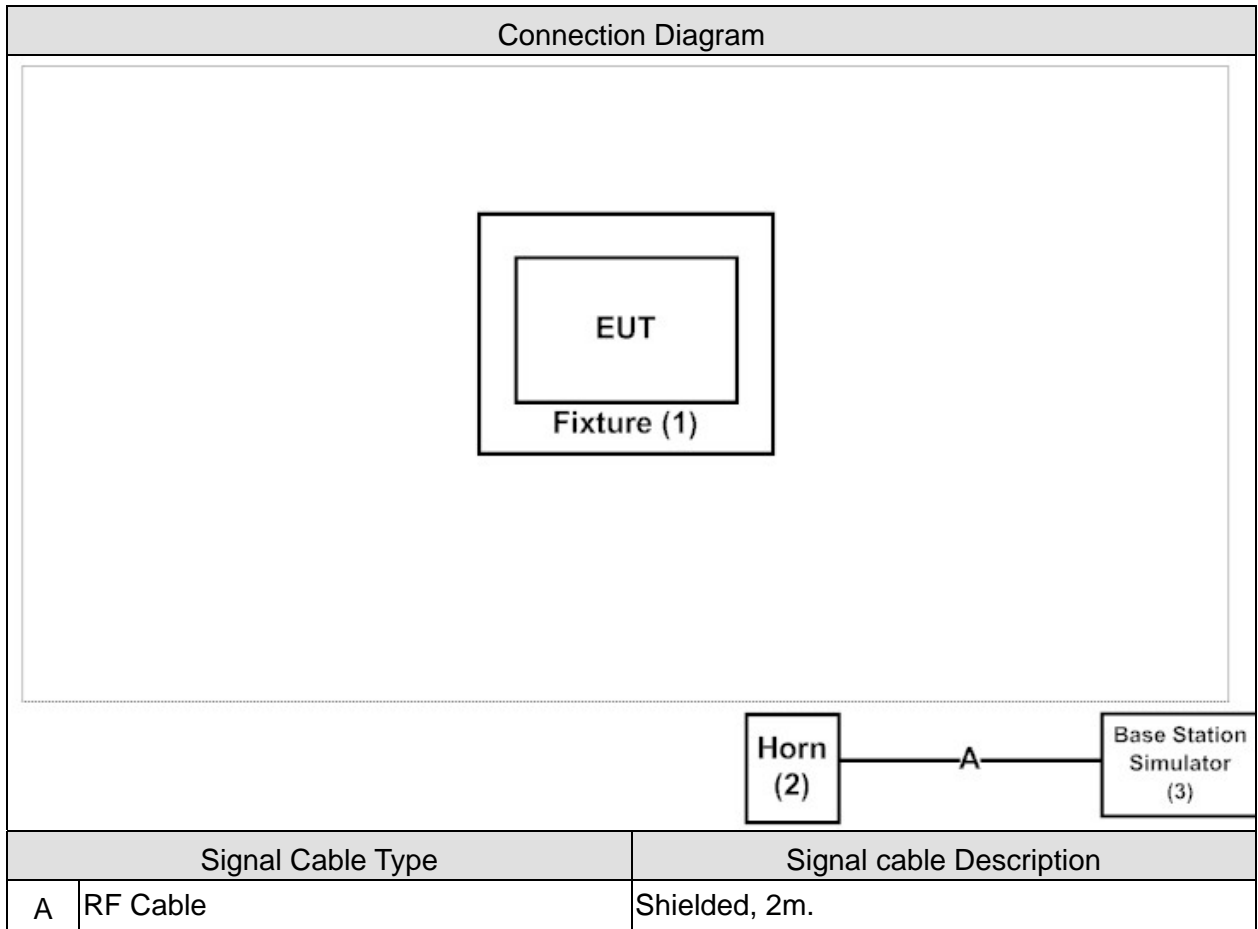

1.5. EUT Exercise Software

1	Setup the EUT and simulators as shown on 1.4.
2	Turn on the power of all equipment. Horn link with base station.
3	The EUT link with base station and it will continue receive the signal from WCDMA function.
4	Repeat the above procedure.

2. Technical Test

2.1. Summary of Test Result

Performed Item	FCC References	IC References	Result
Peak Output Power	FCC PART 2.1046 and PART 27.50(h)(2)	RSS -139 §6.5	Pass
Occupied Bandwidth	FCC PART 2.1049 and PART 27.53(l)(6)	RSS - Gen §6.6	Pass
Spurious Emission At Antenna Terminals (+/- 1MHz)	FCC PART 2.1051 and PART 27.53(l)(4)(6)	RSS - 139 §6.6	Pass
Spurious Emission	FCC PART 2.1051 and PART 27.53(l)(4)(6)	RSS - 139 §6.6	Pass
Frequency Stability Under Temperature & Voltage Variations	FCC PART 2.1055(a)(l) and PART 27.54	RSS - 139 §6.4	Pass

2.2. Test Environment

Items	Required (IEC 68-1)	Actual
Temperature (°C)	15-35	23
Humidity (%RH)	25-75	52
Barometric pressure (mbar)	860-1060	950-1000

3. Peak Output Power

3.1. Test Equipment

The following test equipments are used during the test:

Peak Output Power - Conducted Measurement /SR10-H

Instrument	Manufacturer	Model No.	Serial No	Next Cal. Date
High Speed Peak Power Meter Dual Input	Anritsu	ML2496A	1602004	2017/02/09
Multisystem UE Tester	Japan radio	NJZ-2000	ET00477	2017/09/19
Directional coupler	Agilent	778D	20402	2017/10/06

Peak Output Power - Radiated Measurement /CB4-H

Instrument	Manufacturer	Model No.	Serial No	Next Cal. Date
Bilog Antenna	Schaffner	CBL6112B	2891	2017/08/14
Horn Antenna	Schwarzbeck	BBHA 9120	D312	2017/10/25
Pre-Amplifier	EMCI	EMC0031835	980233	2018/02/02
Pre-Amplifier	Schwarzbeck	DBL-1840N506	013	2017/09/29
Pre-Amplifier	Miteq	JS41-001040000-58-5P	1573954	2017/10/04
Horn Antenna	Schwarzbeck	BBHA 9170	203	2017/08/28
Signal & Spectrum Analyzer	R&S	FSV40	101049	2018/01/05

Note: All equipments are calibrated with traceable calibrations. Each calibration is traceable to the national or international standards.

3.2. Test Setup

RF Conducted Measurement:

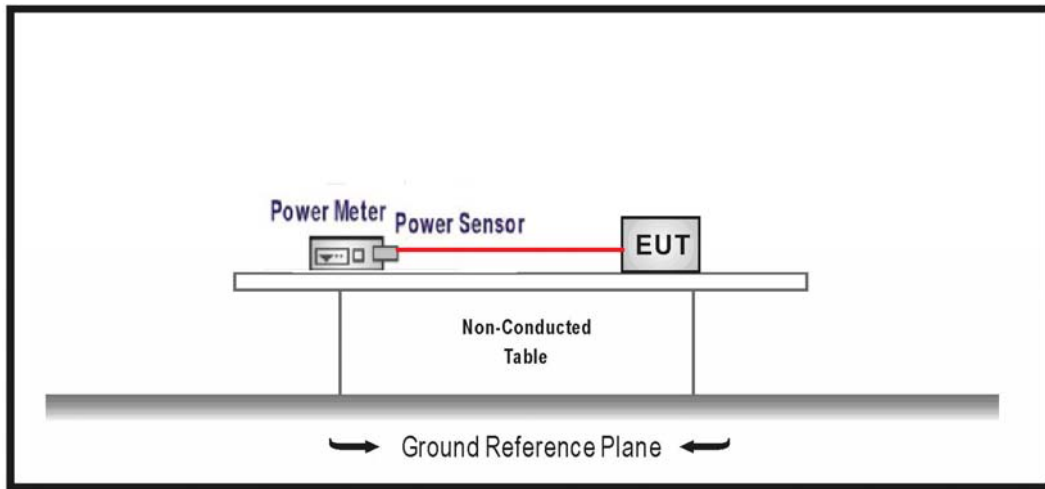

RF Radiated Measurement:

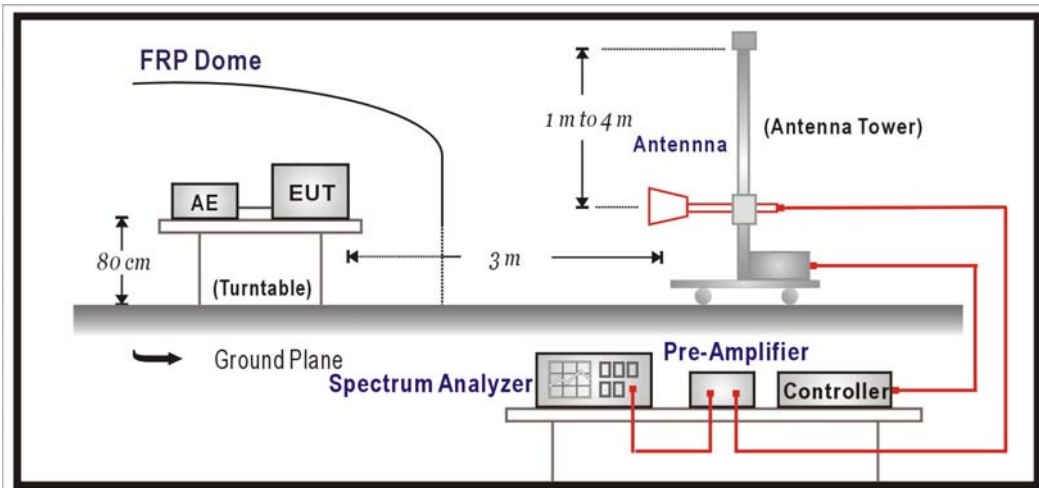

Substitution Measurement Setup:

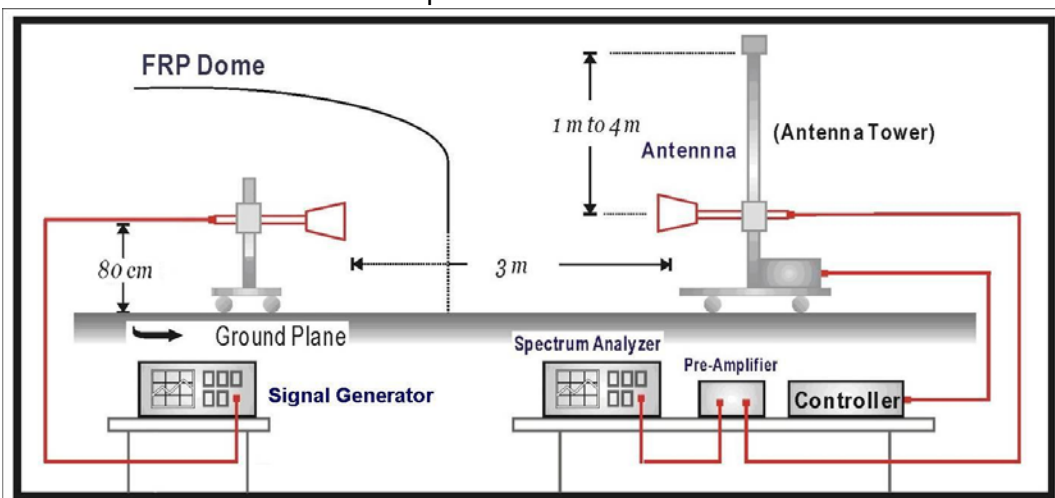

3.3. Limits

- (1) Main, Booster and Base Stations: Maximum E.I.R.P shall not exceed $33 \text{ dBW} + 10\log(X/Y)$ dBW, where X is the actual channel width in MHz and Y is either 6 MHz if prior to transition or the station is in the MBS following transition or 5.5 MHz if the station is in the LBS and UBS following transition.
- (2) Mobile and Other User Stations: 2.0 Watts EIRP.

3.4. Test Procedure

The conducted peak output power is measured using R&S Spectrum Analyzer. The EUT was set up for the rated peak power. All measurements were done at 3 channels: low, middle and high operational frequency range.

For measuring E.I.R.P peak power, EUT was placed on the turn-table which was rotated around 360 degrees to search the maximum radiation power and receiver antenna was rotated vertical and horizontal polarization to find the maximum polarization radiated power.

The EUT is replaced by a horn antenna connected to a signal generator tuned to the frequency of emission and level of signal generator adjusted to same level of emission. Both horizontal and vertical polarization of the antenna are set on measurement.

The radiated E.I.R.P power was calculated via the Correct factor, Reading Level, and Antenna gain as follows:

$$\text{E.I.R.P} = \text{Reading Level} + \text{Correct Factor} = \text{S.G.} - \text{Cable Loss} + \text{Antenna Gain}$$

3.5. Uncertainty

The measurement uncertainty is defined as $\pm 1.27 \text{ dB}$

3.6. Test Result

Product	LE910C1-NA		
Test Item	Peak Output Power		
Test Mode	Mode 1: WCDMA Band 4_Link mode		
Date of Test	2017/02/13	Test Site	SR10-H

Frequency (MHz)	Peak Power		Average Power		Limit (dBm)
	Reading Level (dBm)	Measure Level (dBm)	Reading Level (dBm)	Measure Level (dBm)	
1712.4	27.13	29.5	24.44	27.25	30
1732.6	27.14	29.51	24.55	27.36	30
1752.6	26.9	29.27	24.05	26.86	30

Note: Measure Level=Reading Level + Antenna Gain

Product	LE910C1-NA		
Test Item	Peak Output Power		
Test Mode	Mode 3: WCDMA Band 4_HSUPA Mode		
Date of Test	2017/02/13	Test Site	SR10-H

Frequency (MHz)	Peak Power		Average Power		Limit (dBm)
	Reading Level (dBm)	Measure Level (dBm)	Reading Level (dBm)	Measure Level (dBm)	
1712.4	27.24	29.61	22.14	24.51	30
1732.6	27.34	29.71	22.37	24.74	30
1752.6	27.19	29.56	21.87	24.24	30

Note: Measure Level=Reading Level + Antenna Gain

Product	LE910C1-NA		
Test Item	Peak Output Power		
Test Mode	Mode 4: WCDMA Band 4_HSDPA Mode		
Date of Test	2017/02/13	Test Site	SR10-H

Frequency (MHz)	Peak Power		Average Power		Limit (dBm)
	Reading Level (dBm)	Measure Level (dBm)	Reading Level (dBm)	Measure Level (dBm)	
1712.4	27.42	29.79	23.45	25.82	30
1732.6	27.29	29.66	23.77	26.14	30
1752.6	27.09	29.46	23.41	25.78	30

Note: Measure Level=Reading Level + Antenna Gain

Product	LE910C1-NA		
Test Item	Peak Output Power_ Radiated		
Test Mode	Mode 1: WCDMA Band 4_Link mode		
Date of Test	2017/02/17	Test Site	CB4-H

Frequency (MHz)	Measure Level (dBm)	Limit (dBm)
1712.4	25.77	30
1732.6	26.92	30
1752.6	25.98	30

Product	LE910C1-NA		
Test Item	Peak Output Power_ Radiated		
Test Mode	Mode 3: WCDMA Band 4_HSUPA Mode		
Date of Test	2017/02/17	Test Site	CB4-H

Frequency (MHz)	Measure Level (dBm)	Limit (dBm)
1712.4	26.85	30
1732.6	26.84	30
1752.6	26.87	30

Product	LE910C1-NA		
Test Item	Peak Output Power_ Radiated		
Test Mode	Mode 4: WCDMA Band 4_HSDPA Mode		
Date of Test	2017/02/17	Test Site	CB4-H

Frequency (MHz)	Measure Level (dBm)	Limit (dBm)
1712.4	26.53	30
1732.6	26.58	30
1752.6	26.52	30

4. Occupied Bandwidth

4.1. Test Equipment

The following test equipments are used during the test:

Occupied Bandwidth/ SR10-H

Instrument	Manufacturer	Model No.	Serial No.	Next Cal. Date
Signal & Spectrum Analyzer	R&S	FSVA40	101455	2017/11/27
Multisystem UE Tester	Japan radio	NJZ-2000	ET00477	2017/09/19
Directional coupler	Agilent	778D	20402	2017/10/06

Note: All equipments are calibrated with traceable calibrations.

Each calibration is traceable to the national or international standards.

4.2. Test Setup

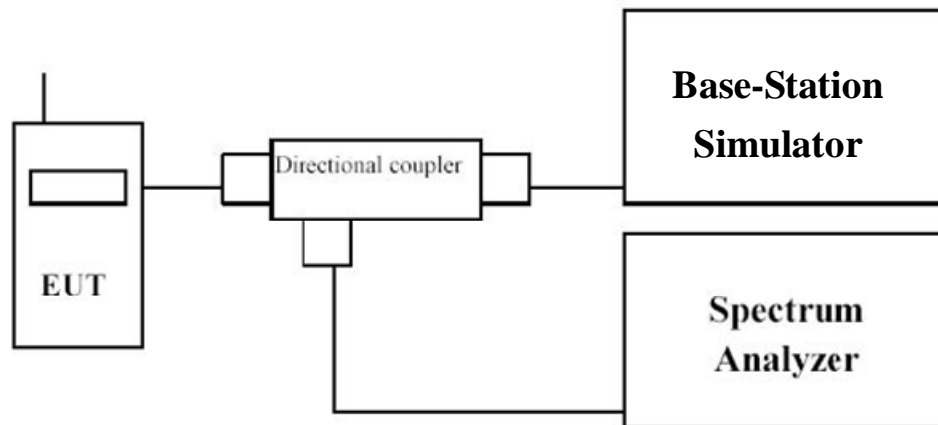

4.3. Limits

The emission bandwidth is defined as the width of the signal between two points, one below the carrier center frequency and one above the carrier center frequency, outside of which all emissions are attenuated at least 26 dB below the transmitter power.

4.4. Test Procedure

The occupied bandwidth is measured using R&S Spectrum Analyzer with a resolution bandwidth of 100 kHz, video bandwidth of 300 kHz and span of 10 MHz. The EUT was set up for the rated peak power under transmission mode and specific channel frequency. The standards required a measurement bandwidth is the fundamental emission below 26dB bandwidth.

4.5. Uncertainty

The measurement uncertainty is defined as ± 50 KHz

4.6. Test Result

Product	LE910C1-NA		
Test Item	Occupied Bandwidth		
Test Mode	Mode 1: WCDMA Band 4_Link mode		
Date of Test	2017/01/06	Test Site	SR10-H

Frequency (MHz)	-26dB BW Measure Level (MHz)	99% BW Measure Level (MHz)	Limit (MHz)
1712.4	4.638	4.130	N/A
1732.6	4.644	4.134	N/A
1752.6	4.652	4.128	N/A

1712.4 MHz (-26dB BW)

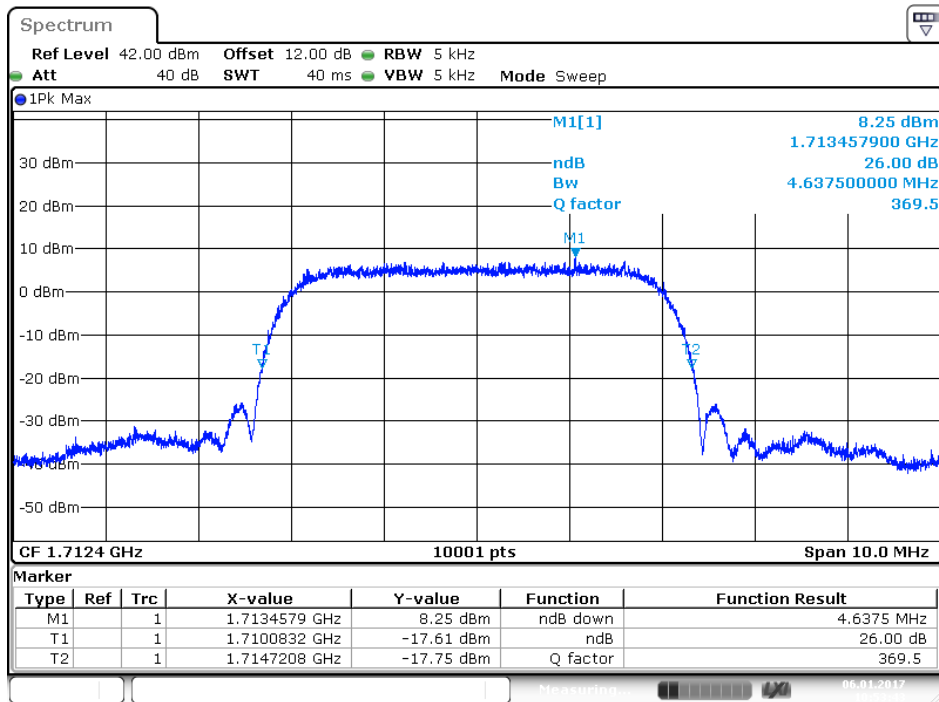

Date: 6 JAN 2017 10:53:43

1712.4 MHz (99% BW)

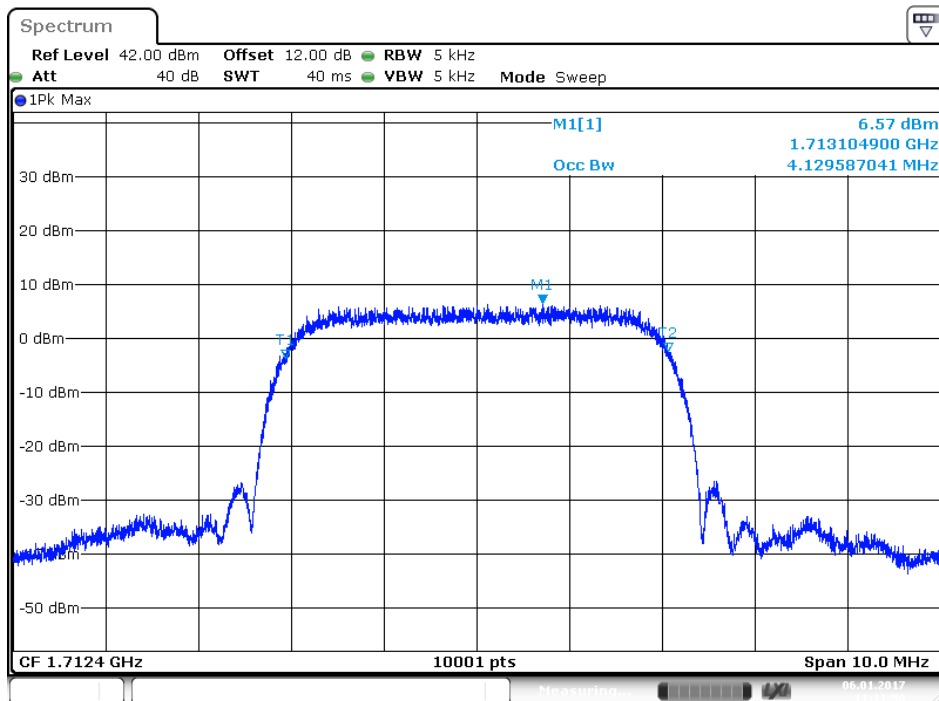

Date: 6 JAN 2017 11:11:50

1732.6 MHz (-26dB BW)

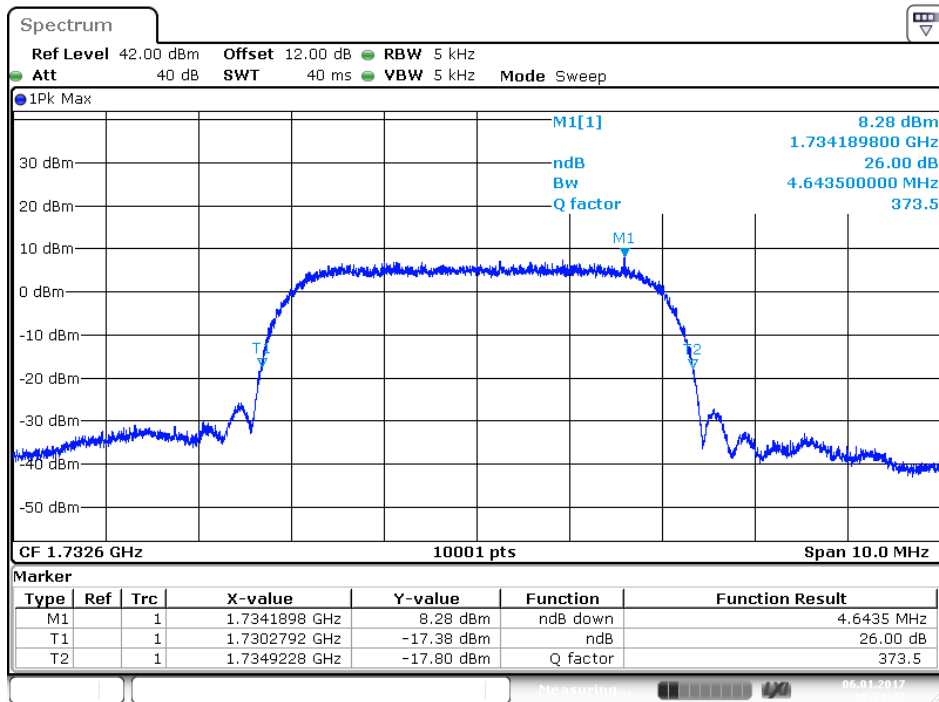

Date: 6 JAN 2017 10:58:47

1732.6 MHz (99% BW)

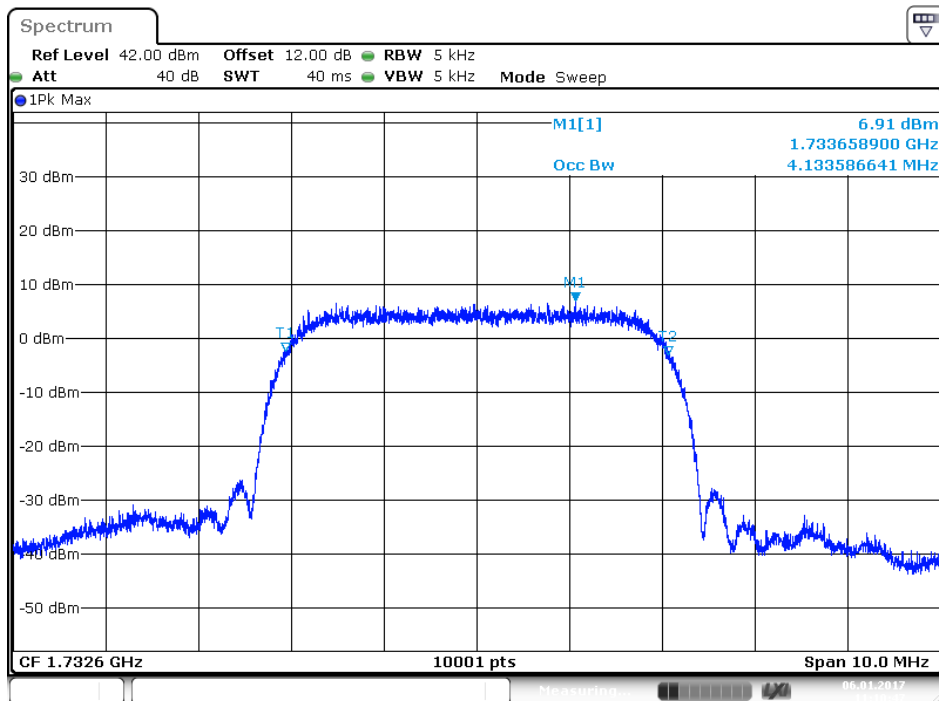

Date: 6 JAN 2017 11:10:47

1752.6MHz (-26dB BW)

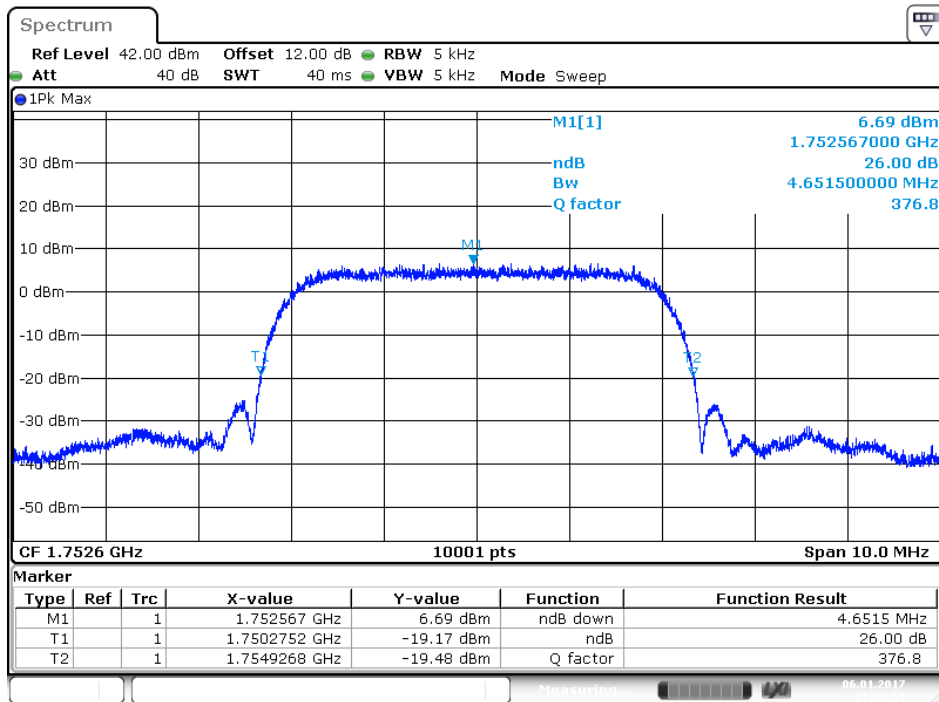

Date: 6 JAN 2017 11:00:54

1752.6MHz (99% BW)

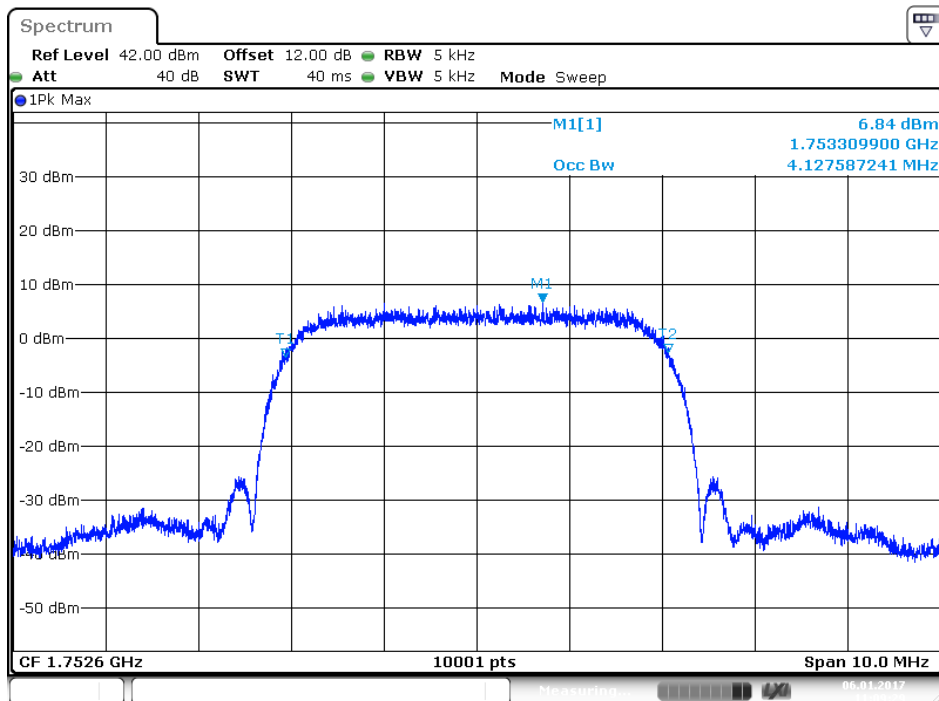

Date: 6 JAN 2017 11:09:30

Product	LE910C1-NA		
Test Item	Occupied Bandwidth		
Test Mode	Mode 3: WCDMA Band 4_HSUPA Mode		
Date of Test	2017/02/23	Test Site	SR10-H

Frequency (MHz)	-26dB BW Measure Level (MHz)	99% BW Measure Level (MHz)	Limit (MHz)
1712.4	4.654	4.131	N/A
1732.6	4.646	4.129	N/A
1752.6	4.632	4.121	N/A

1712.4 MHz (-26dB BW)

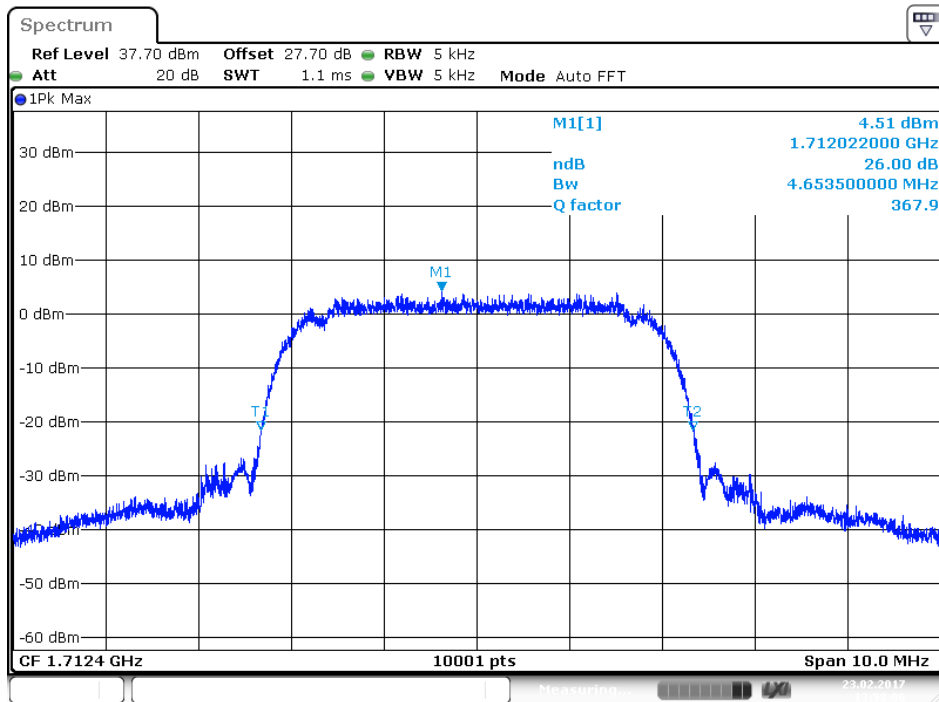

Date: 23.FEB.2017 13:58:07

1712.4 MHz (99% BW)

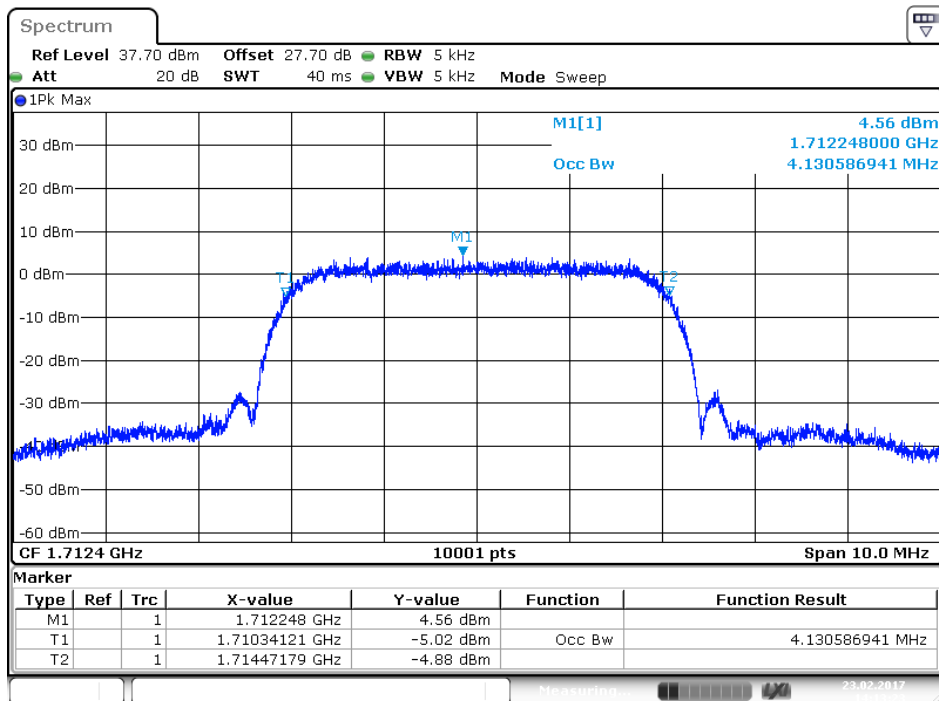

Date: 23.FEB.2017 14:13:23

1732.6 MHz (-26dB BW)

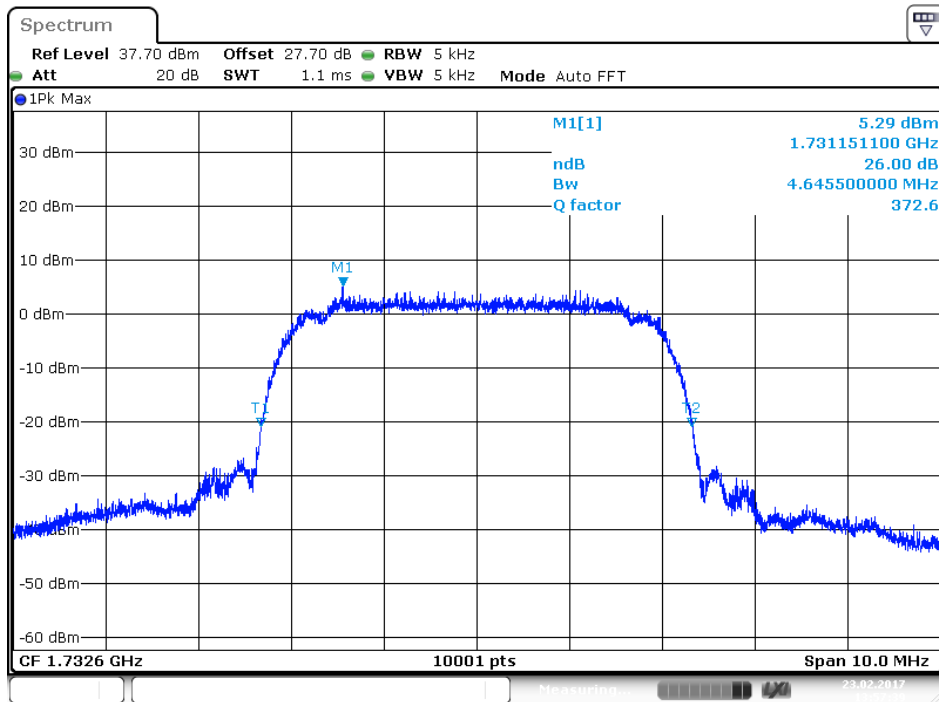

Date: 23.FEB.2017 13:57:39

1732.6 MHz (99% BW)

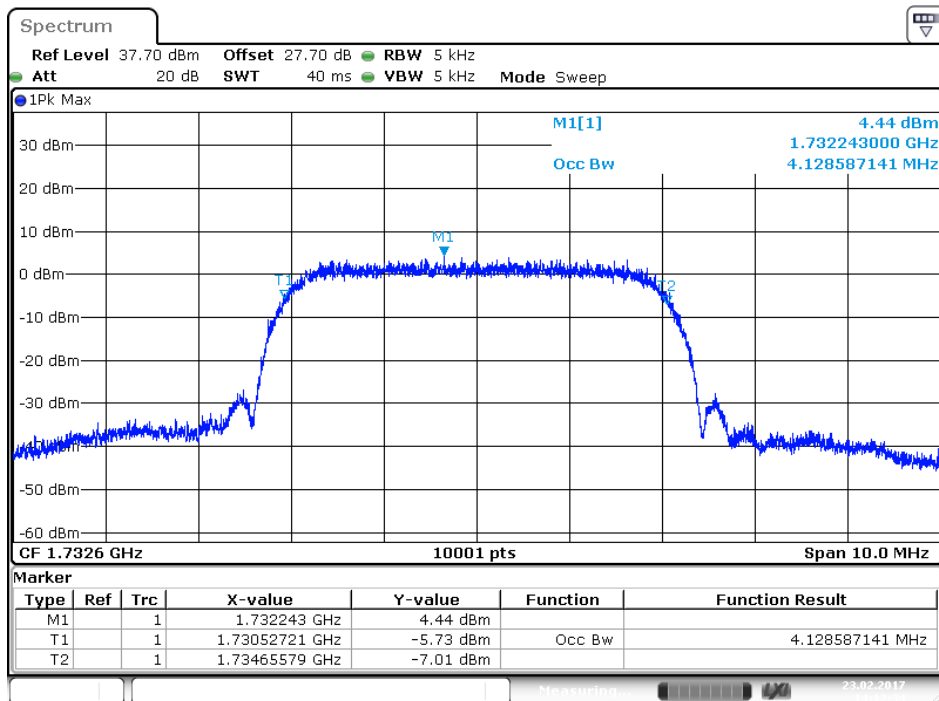

Date: 23.FEB.2017 14:12:35

1752.6MHz (-26dB BW)

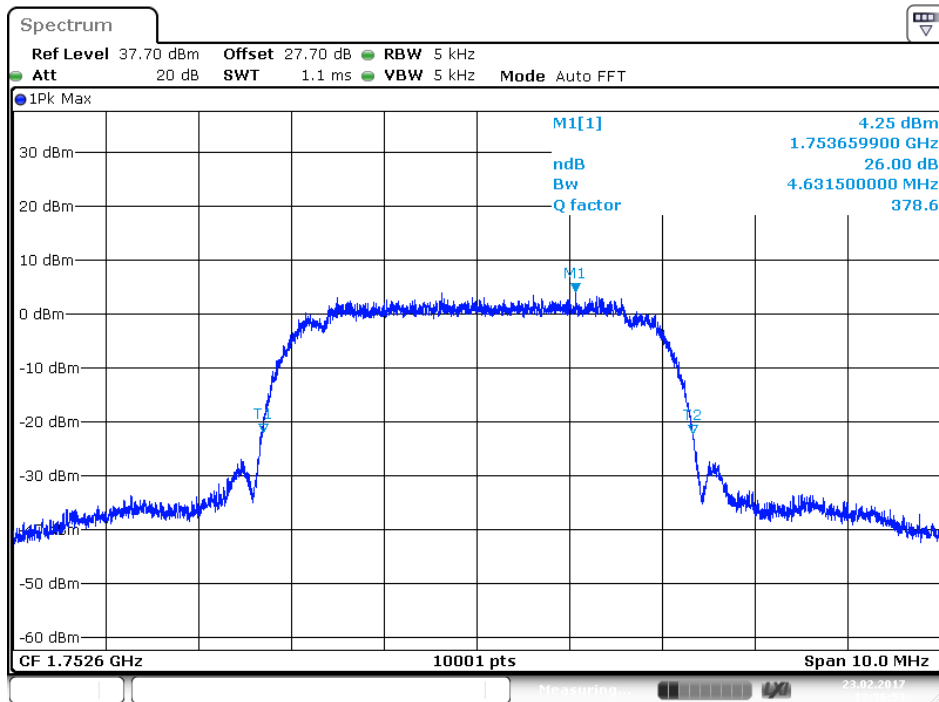

Date: 23.FEB.2017 13:56:53

1752.6MHz (99% BW)

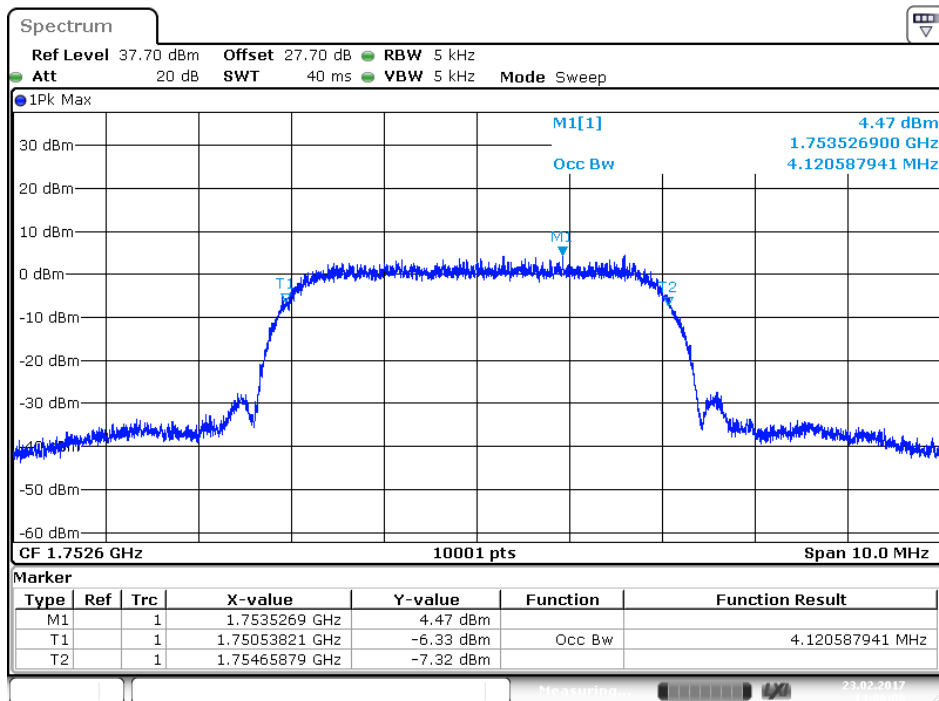

Date: 23.FEB.2017 14:06:06

Product	LE910C1-NA		
Test Item	Occupied Bandwidth		
Test Mode	Mode 4: WCDMA Band 4_HSDPA Mode		
Date of Test	2017/02/23	Test Site	SR10-H

Frequency (MHz)	-26dB BW Measure Level (MHz)	99% BW Measure Level (MHz)	Limit (MHz)
1712.4	4.640	4.134	N/A
1732.6	4.625	4.133	N/A
1752.6	4.629	4.126	N/A

1712.4 MHz (-26dB BW)

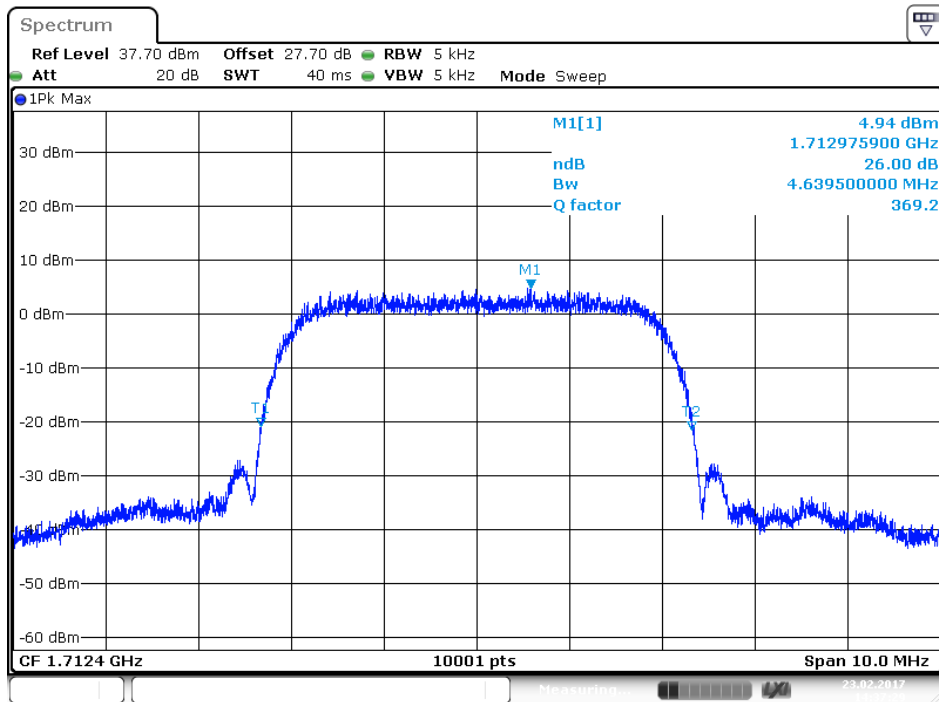

Date: 23.FEB.2017 14:37:29

1712.4 MHz (99% BW)

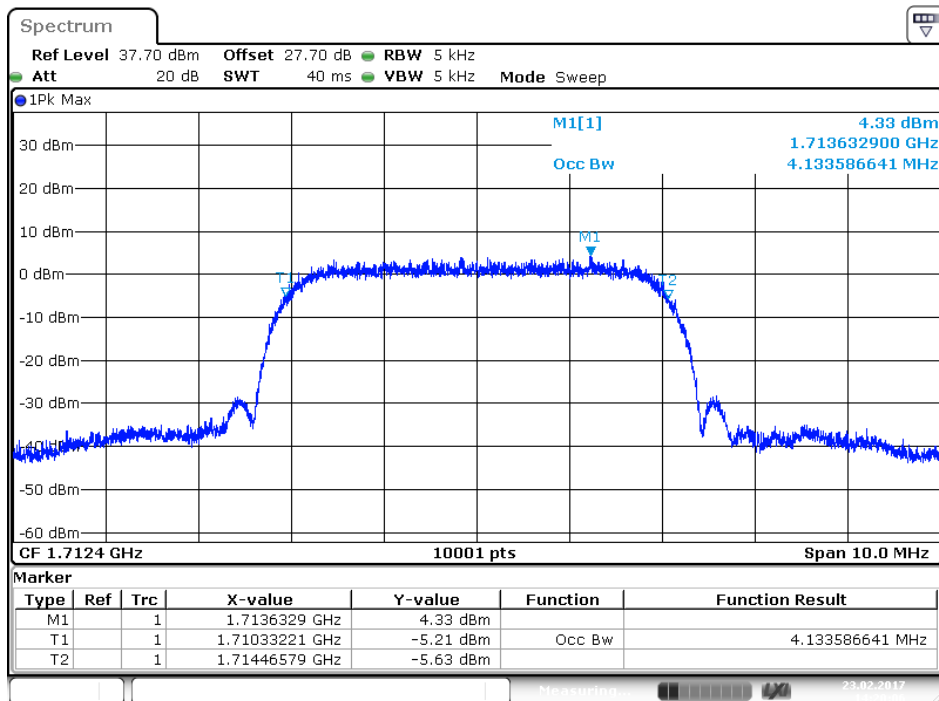

Date: 23.FEB.2017 14:20:06

1732.6 MHz (-26dB BW)

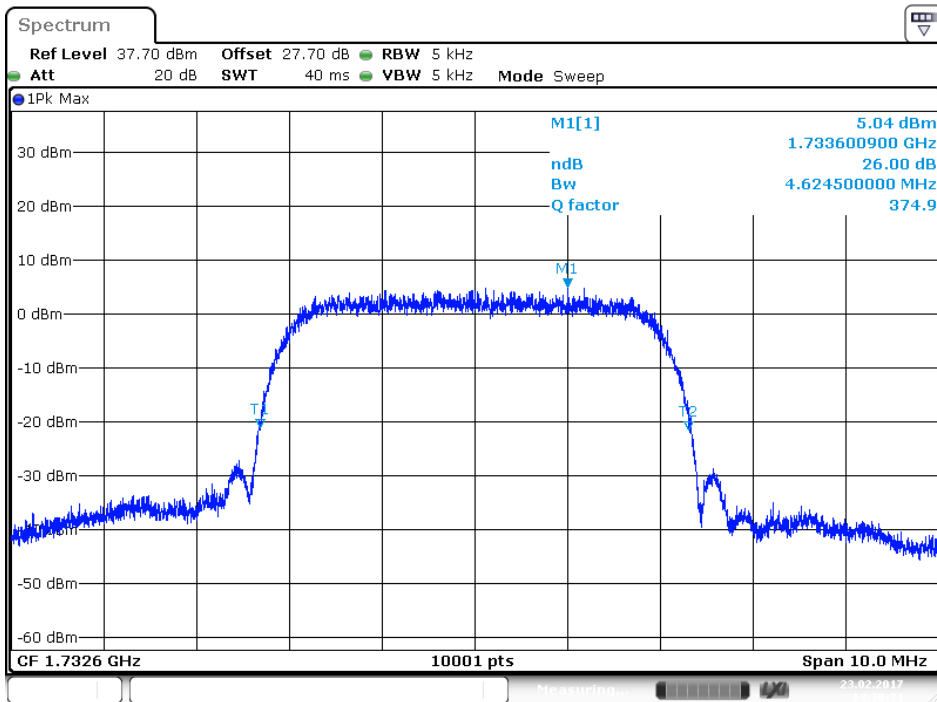

Date: 23.FEB.2017 14:38:31

1732.6 MHz (99% BW)

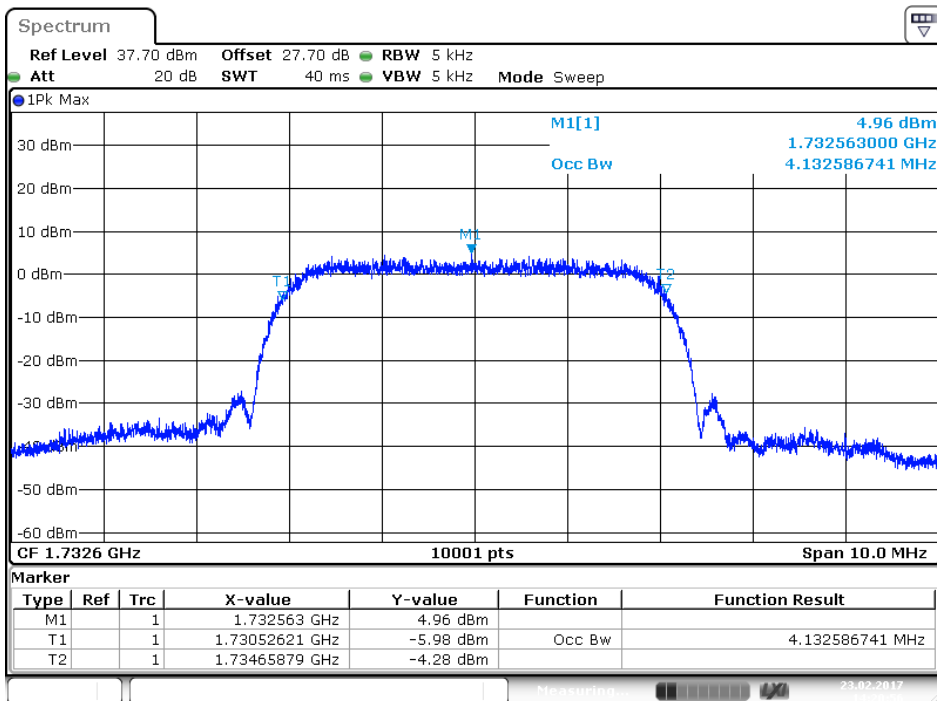

Date: 23.FEB.2017 14:20:56

1752.6MHz (-26dB BW)

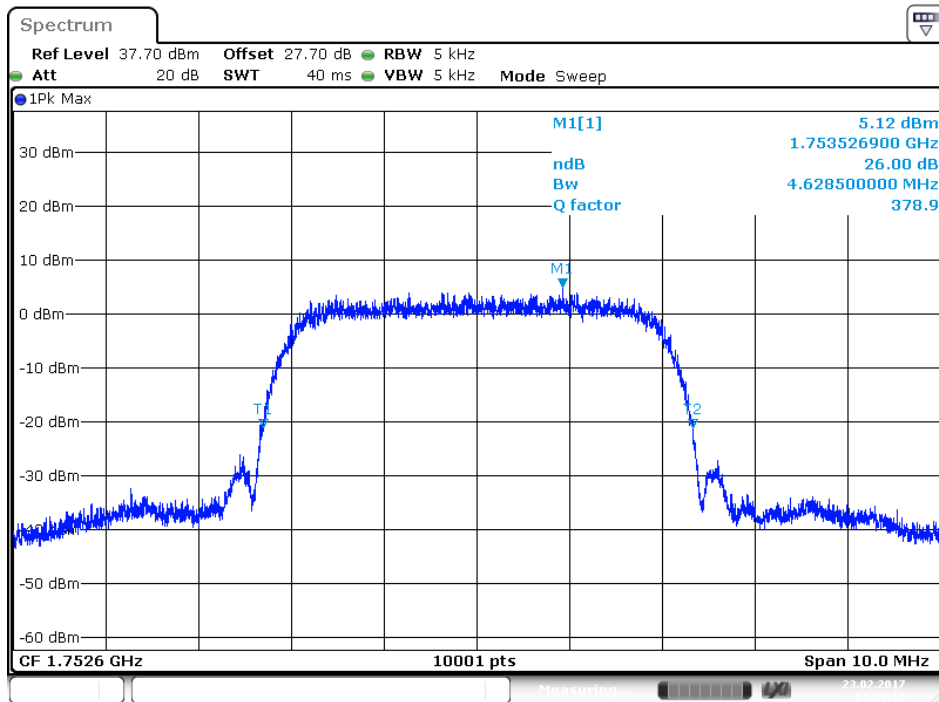

Date: 23.FEB.2017 14:39:12

1752.6MHz (99% BW)

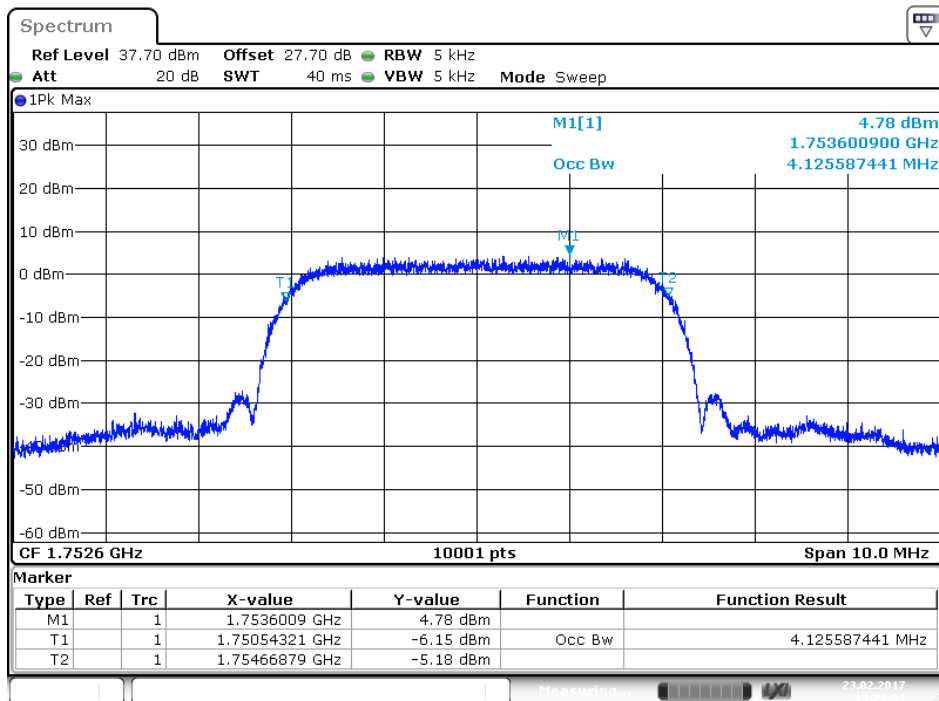

Date: 23.FEB.2017 14:21:51

5. Band Edge

5.1. Test Equipment

The following test equipment are used during the test:

Band edge / SR10-H

Instrument	Manufacturer	Model No.	Serial No.	Next Cal. Date
Signal & Spectrum Analyzer	R&S	FSVA40	101455	2017/11/27
Multisystem UE Tester	Japan radio	NJZ-2000	ET00477	2017/09/19
Directional coupler	Agilent	778D	20402	2017/10/06

Note: All equipments that need to calibrate are with calibration period of 1 year.

5.2. Test Setup

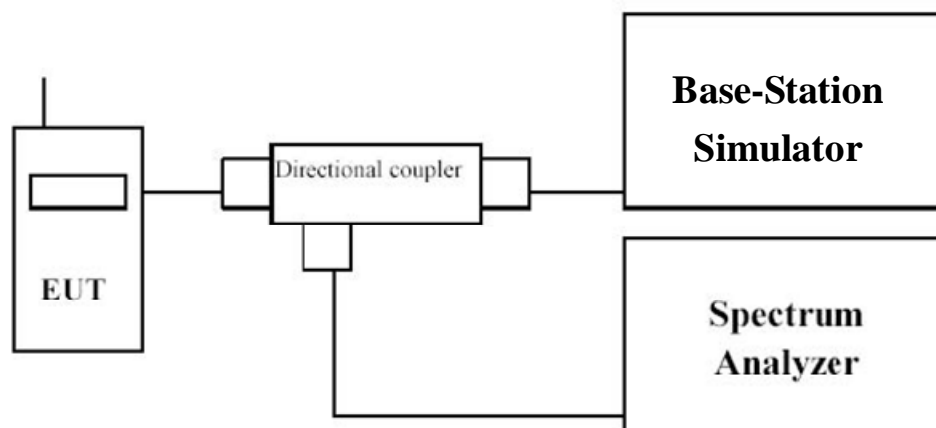

5.3. Limits

- (1) Fixed and Temporary Fixed Digital Stations: not less than $43 + \log (P)$ dB
- (2) Mobile Digital Stations: not less than $43 + \log (P)$ dB at the channel edge and $55 + \log (P)$ dB at 5.5 MHz from the channel edges

Sample Calculation:

Assume the EUT Output Power is $2 \text{ W} = 33 \text{ dBm}$

$$43 + \log (P) \text{ dB}$$

$$43 + \log (2) = 46 \text{ dB}$$

$$33 \text{ dBm} - 46 \text{ dB} = -13 \text{ dBm}$$

$$55 + \log (2) = 58 \text{ dB}$$

$$33 \text{ dBm} - 58 \text{ dB} = -25 \text{ dBm}$$

5.4. Test Procedure

Conducted Measurement :

The EUT was set up for the rated peak power. The band edge was measured with Spectrum Analyzer with a resolution bandwidth of 100 kHz and video bandwidth of 300 kHz. All measurements were done at 2 channels: low and high operational frequency range.

The center frequency of spectrum is the band edge frequency and span is 7.5 MHz for test mode 1 (5 MHz bandwidth) and 15 MHz for test mode 2 (10 MHz bandwidth). The resolution bandwidth of spectrum is 100 kHz and video bandwidth of spectrum is 300 kHz.

Record the max trace plot into the test report.

Radiated Measurement :

EUT was placed on the turn-table which was rotated around 360 degrees to search the maximum radiation power and receiver antenna was rotated vertical and horizontal polarization to find the maximum polarization radiated power.

The EUT is replaced by a horn antenna connected to a signal generator tuned to the frequency of emission and level of signal generator adjusted to same level of emission. Both horizontal and vertical polarization of the antenna are set on measurement.

On any frequency, the limits shown are based on measuring equipment employing a peak detector function. The resolution bandwidth of spectrum analyzer is 100KHz. and video bandwidth is 300KHz.

The radiated band edge emission was calculated via the Correct factor, Reading Level, and Antenna gain as follows:

Emission Level = Reading Level + Correct Factor = S.G. – Cable Loss + Antenna Gain

5.5. Uncertainty

The measurement uncertainty

Conducted is defined as $\pm 1.27\text{dB}$

Radiated is defined as $\pm 3.9\text{dB}$

5.6. Test Result

Product	LE910C1-NA		
Test Item	Band Edge		
Test Mode	Mode 1: WCDMA Band 4_Link mode		
Date of Test	2017/01/09	Test Site	SR10-H

Low Channel (1712.4 MHz)

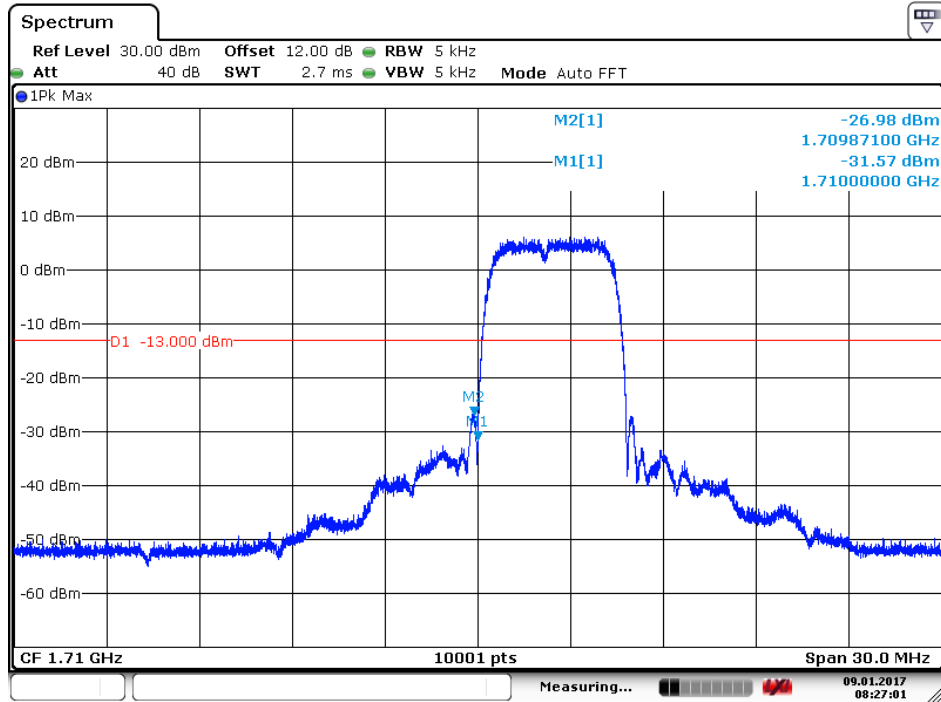

Date: 9 JAN. 2017 08:27:01

High Channel (1752.6 MHz)

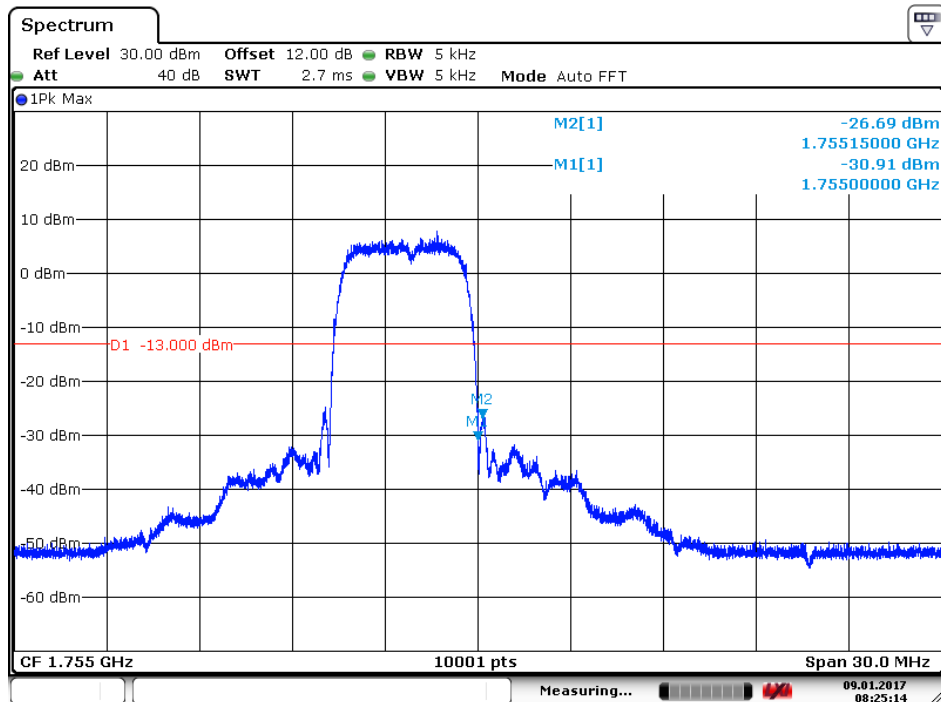

Date: 9 JAN. 2017 08:25:14

6. Conducted Spurious Emission

6.1. Test Equipment

The following test equipments are used during the test:

Conducted Spurious Emission / SR10-H

Instrument	Manufacturer	Model No.	Serial No.	Next Cal. Date
Signal & Spectrum Analyzer	R&S	FSVA40	101455	2017/11/27
Multisystem UE Tester	Japan radio	NJZ-2000	ET00477	2017/09/19
Directional coupler	Agilent	778D	20402	2017/10/06

Note: All equipments are calibrated with traceable calibrations. Each calibration is traceable to the national or international standards.

6.2. Test Setup

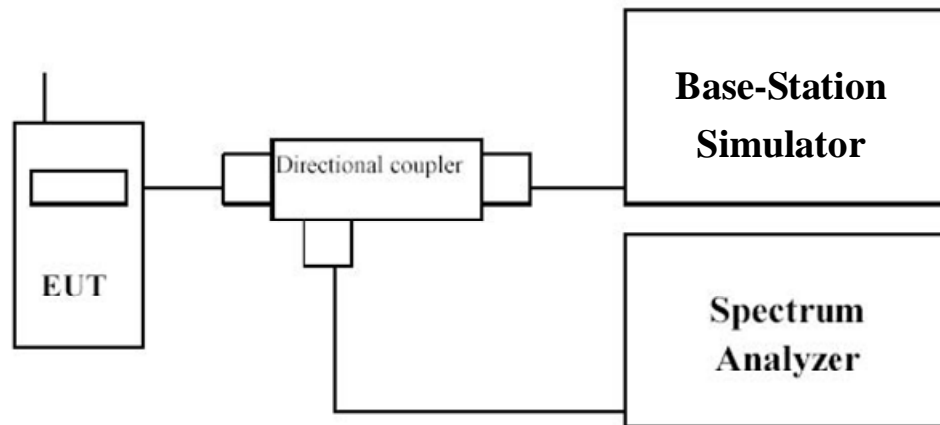

6.3. Limits

- (1) Fixed and Temporary Fixed Digital Stations: not less than $43 + \log (P)$ dB
- (2) Mobile Digital Stations: not less than $43 + \log (P)$ dB at the channel edge and $55 + \log (P)$ dB at 5.5 MHz from the channel edges

Sample Calculation:

Assume the EUT Output Power is $2 \text{ W} = 33 \text{ dBm}$

$43 + \log (P)$ dB

$43 + \log (2) = 46 \text{ dB}$

$33 \text{ dBm} - 46 \text{ dB} = -13 \text{ dBm}$

$55 + \log (2) = 58 \text{ dB}$

$33 \text{ dBm} - 58 \text{ dB} = -25 \text{ dBm}$

6.4. Test Procedure

The EUT was set up for the rated peak power. The power was measured with R&S Spectrum Analyzer. All measurements were done at 3 channels: low, middle and high operational frequency range.

When the spectrum scanned from 30MHz to 27GHz, it connected to the 10dB attenuator to the carried frequency. The spectrum set RBW = 1MHz, VBW = 3MHz. and using peak detection mode.

6.5. Uncertainty

The measurement uncertainty is defined as $\pm 1.27 \text{ dB}$

6.6. Test Result

Product	LE910C1-NA		
Test Item	Conducted Spurious Emission		
Test Mode	Mode 1: WCDMA Band 4_Link mode		
Date of Test	2017/01/09	Test Site	SR10-H

1712.4 MHz

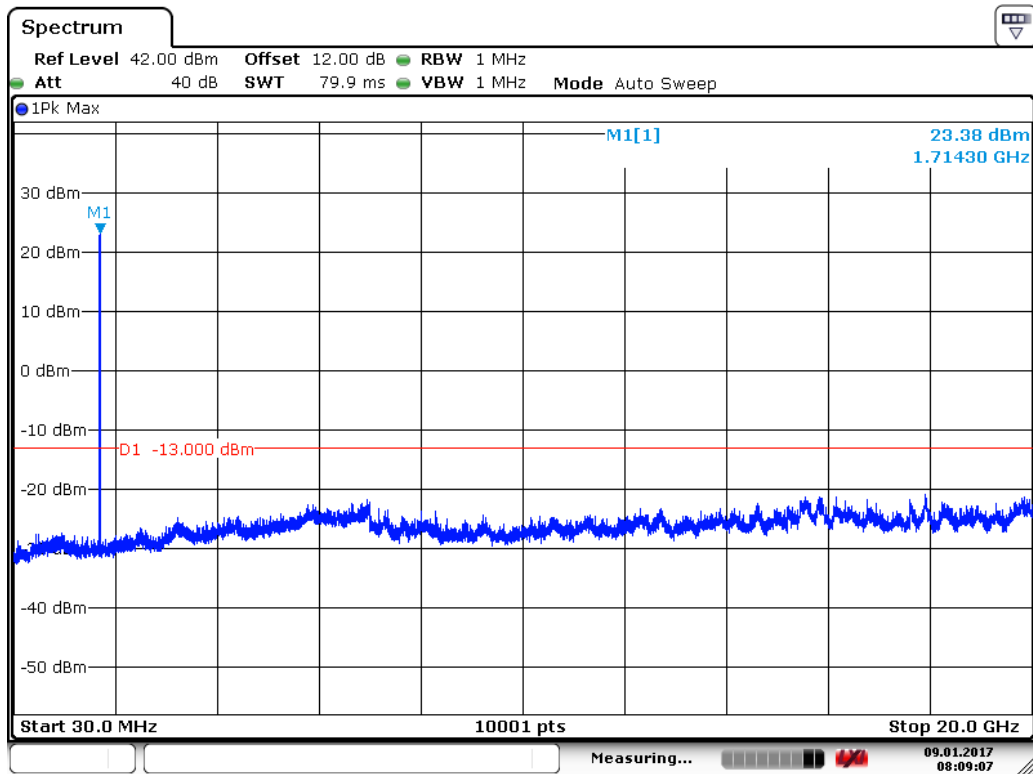

Date: 9 JAN 2017 08:09:07

1732.6 MHz

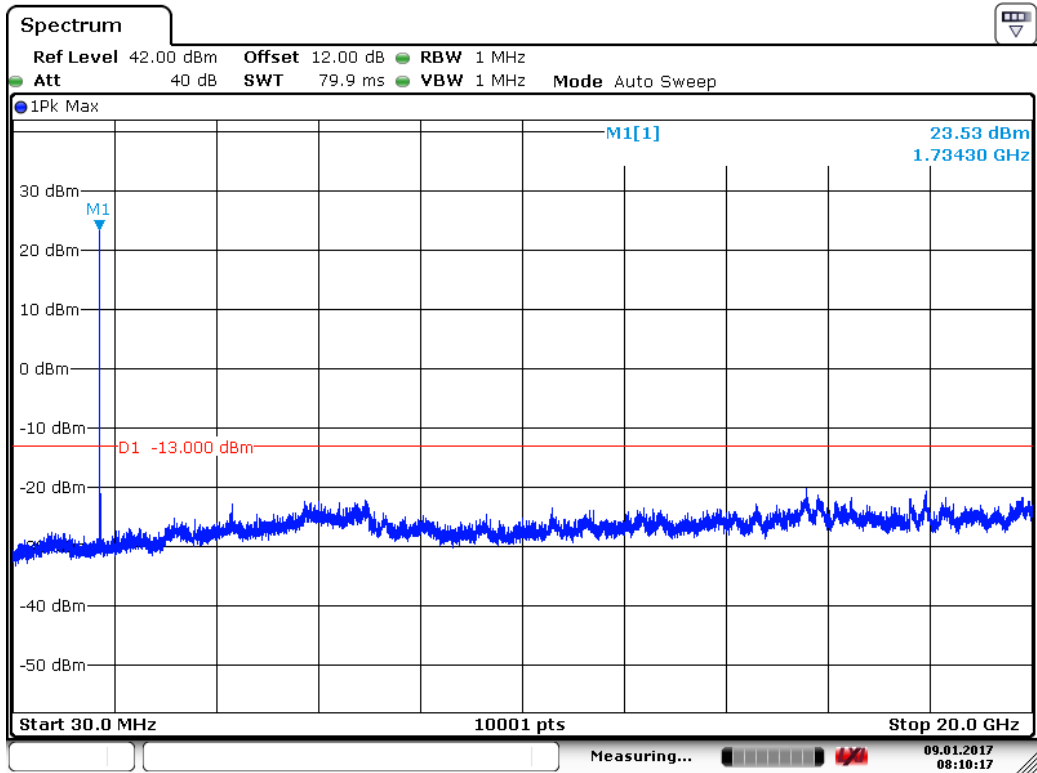

Date: 9 JAN 2017 08:10:18

1752.6 MHz

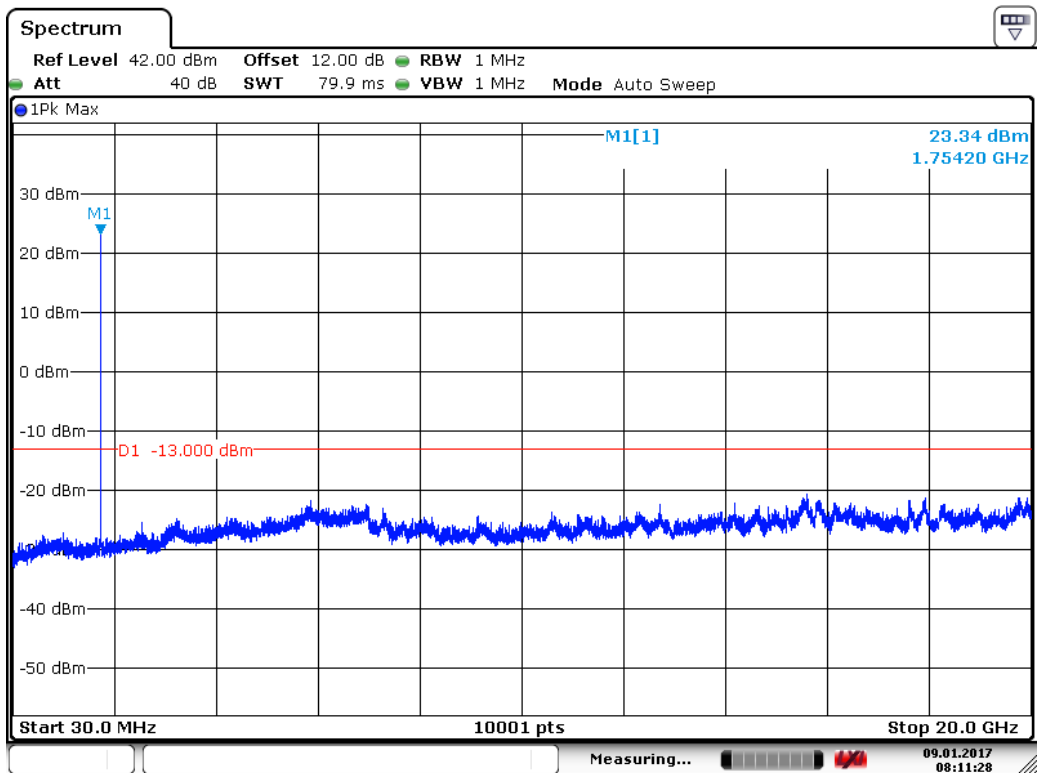

Date: 9 JAN 2017 08:11:28

Product	LE910C1-NA		
Test Item	Conducted Spurious Emission		
Test Mode	Mode 3: WCDMA Band 4_HSUPA Mode		
Date of Test	2017/02/23	Test Site	SR10-H

1712.4 MHz

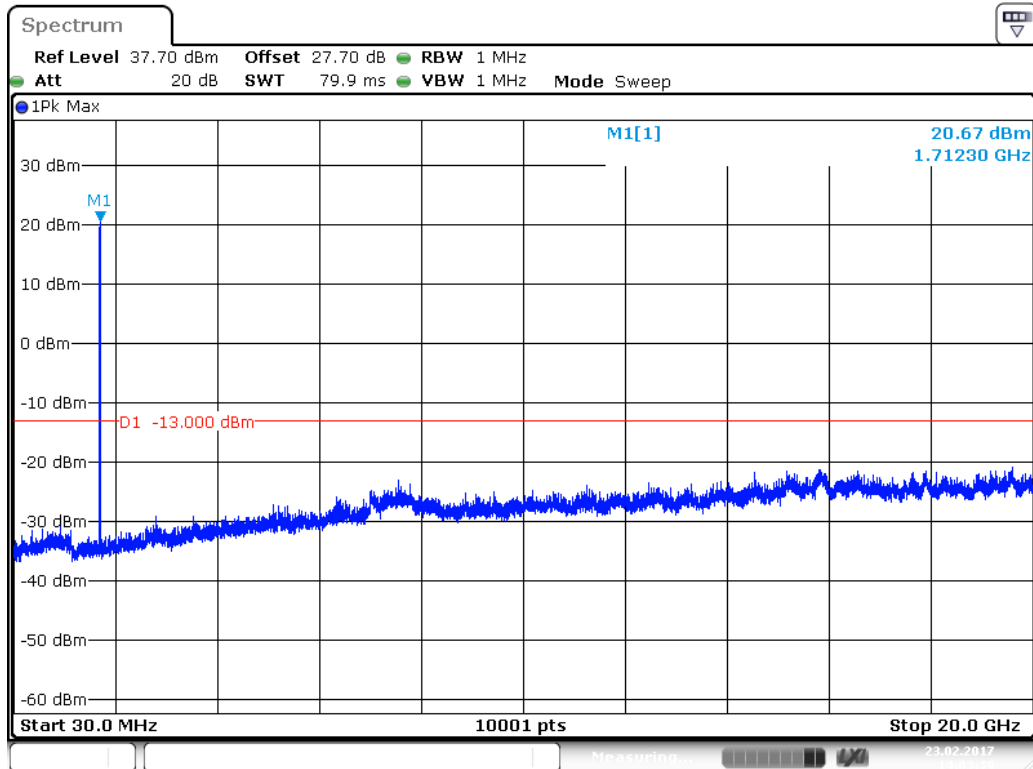

Date: 23.FEB.2017 14:03:19

1732.6 MHz

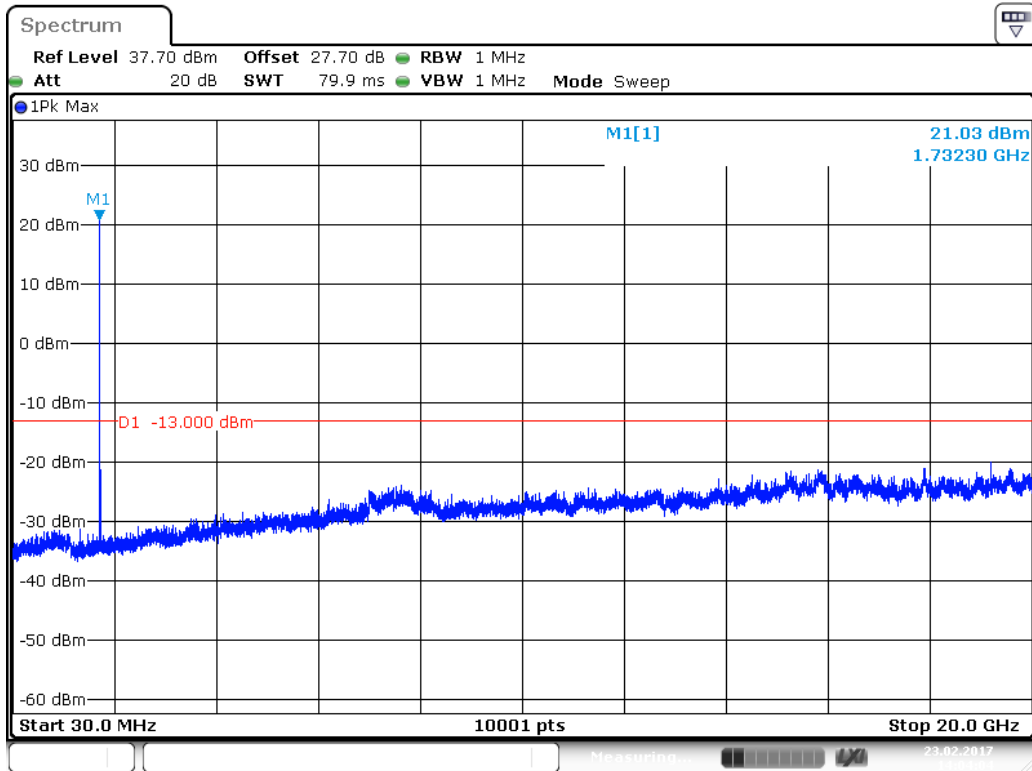

Date: 23.FEB.2017 14:04:05

1752.6 MHz

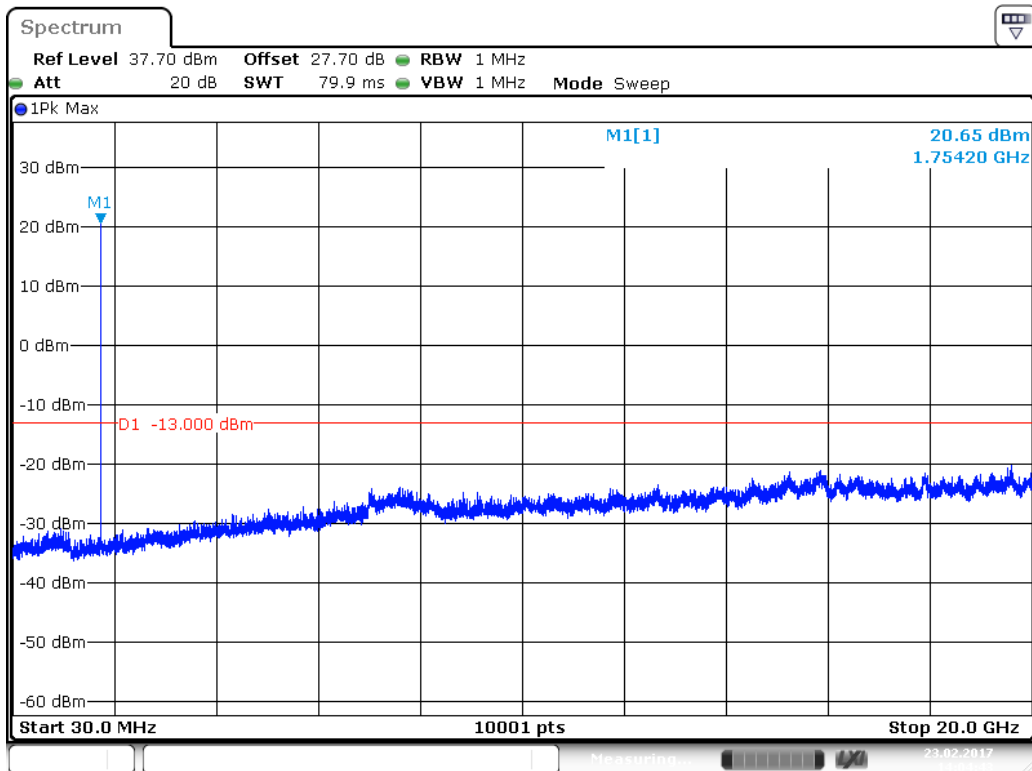

Date: 23.FEB.2017 14:04:43

Product	LE910C1-NA		
Test Item	Conducted Spurious Emission		
Test Mode	Mode 4: WCDMA Band 4_HSDPA Mode		
Date of Test	2017/02/23	Test Site	SR10-H

1712.4 MHz

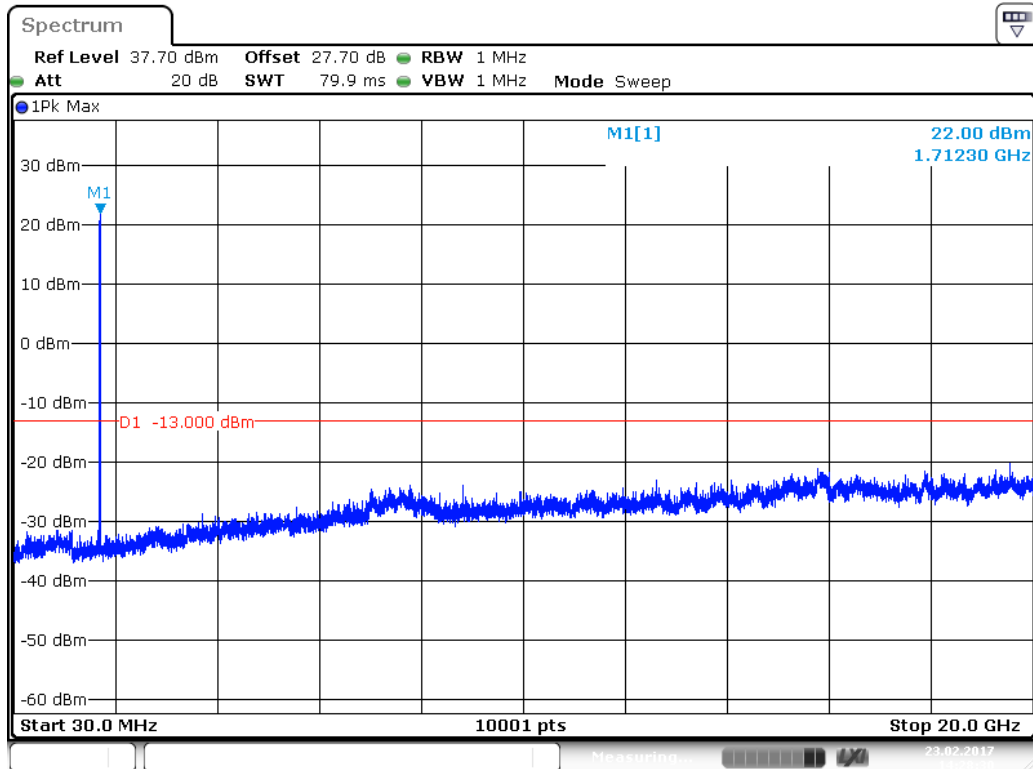

Date: 23.FEB.2017 14:28:30

1732.6 MHz

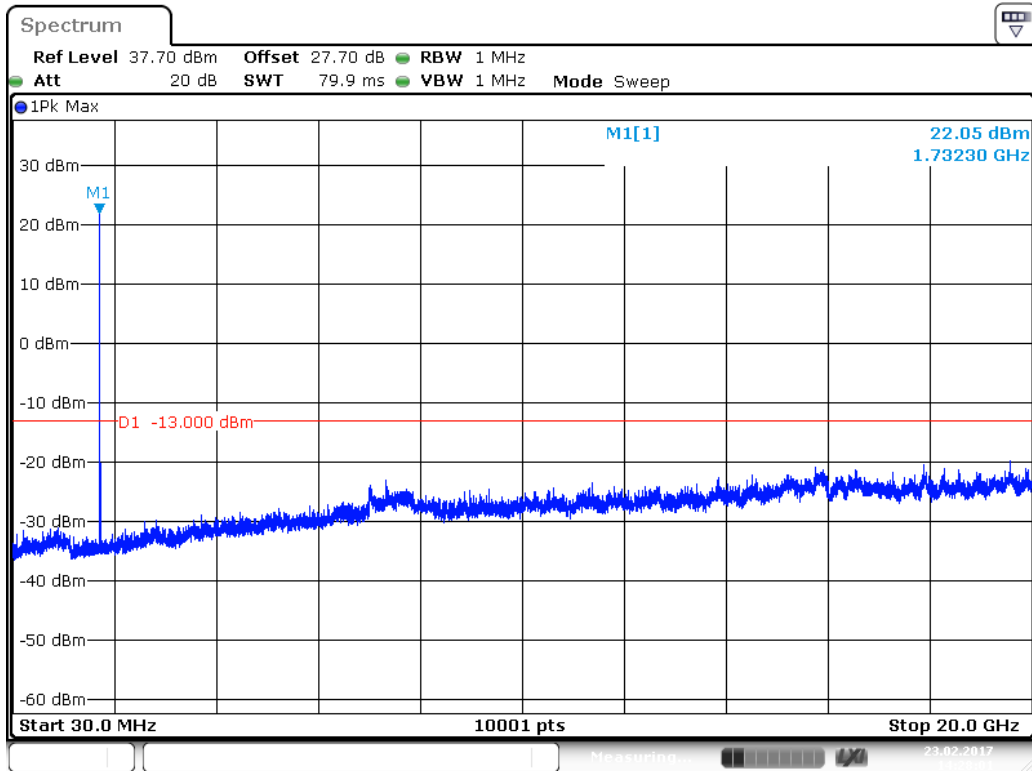

Date: 23.FEB.2017 14:28:01

1752.6 MHz

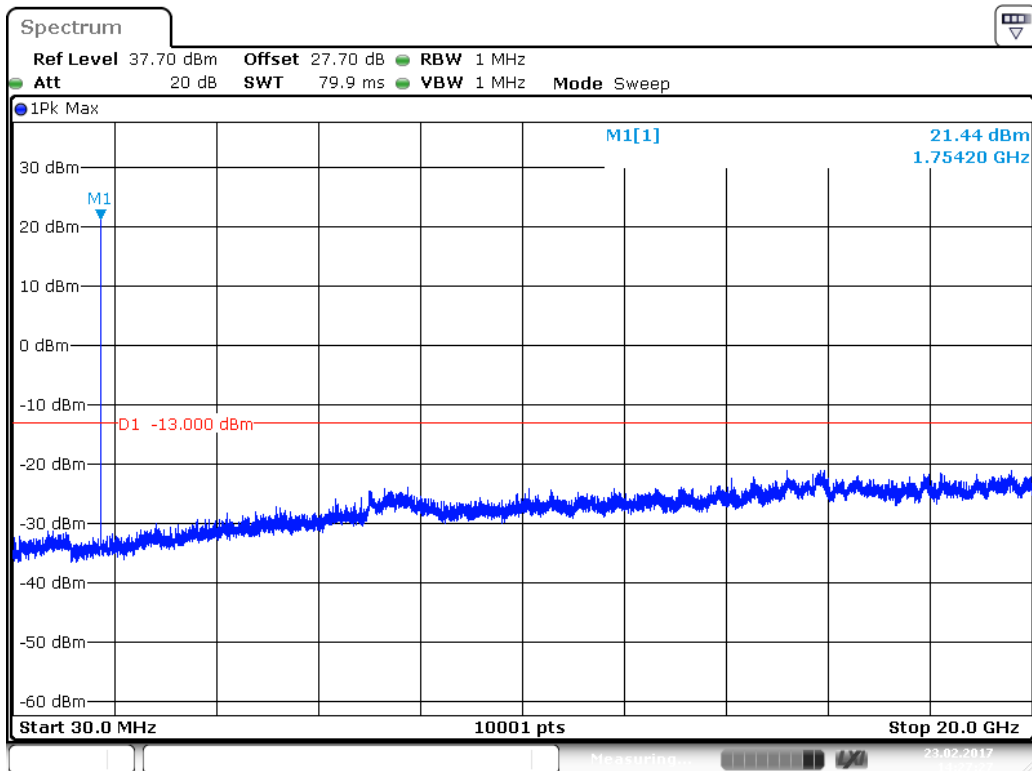

Date: 23.FEB.2017 14:27:27

7. Radiated Spurious Emission

7.1. Test Equipment

The following test equipments are used during the test:

Radiated Emission / CB4-H

Instrument	Manufacturer	Model No.	Serial No	Next Cal. Date
Test Receiver	R&S	ESCS 30	836858/022	2018/01/14
Multisystem UE Tester	Japan radio	NJZ-2000	ET00477	2017/09/19
Signal & Spectrum Analyzer	R&S	FSVA40	101455	2017/11/27
Pre-Amplifier	DEKRA	AP-025C	CHM-0706049	2017/12/18
Bilog Antenna	Schaffner	CBL6112B	2797	2017/08/14
Pre-Amplifier	EMCI	EMC0031835	980233	2018/02/02
Horn Antenna	Schwarzbeck	BBHA 9120	D639	2017/06/29

Note: All equipment that need to calibrate are with calibration period of 1 year.

7.2. Test Setup

Under 1GHz Test Setup:

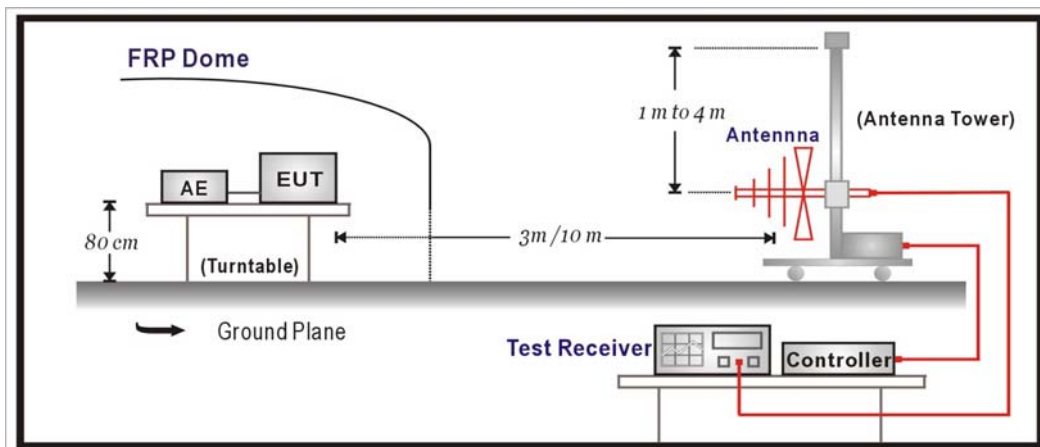

Above 1GHz Test Setup:

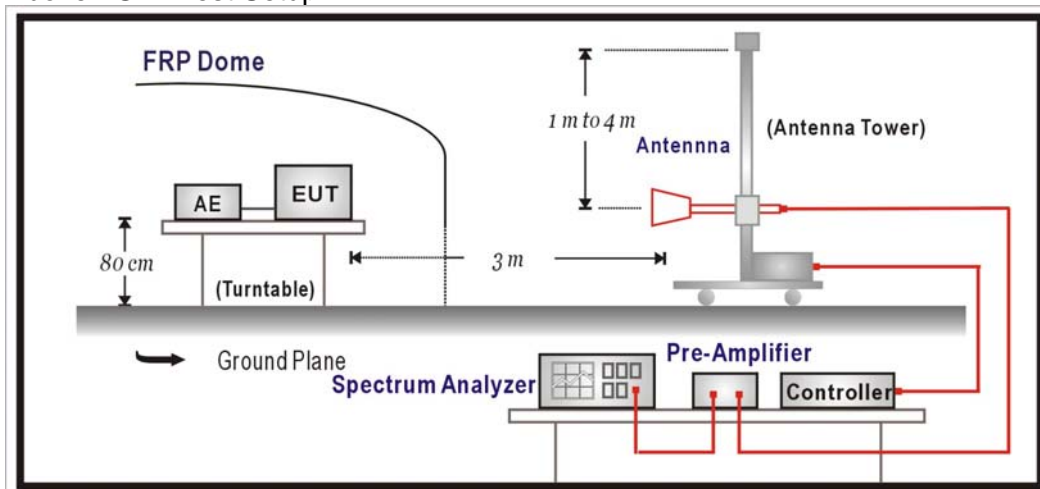

Substitution Measurement Setup:

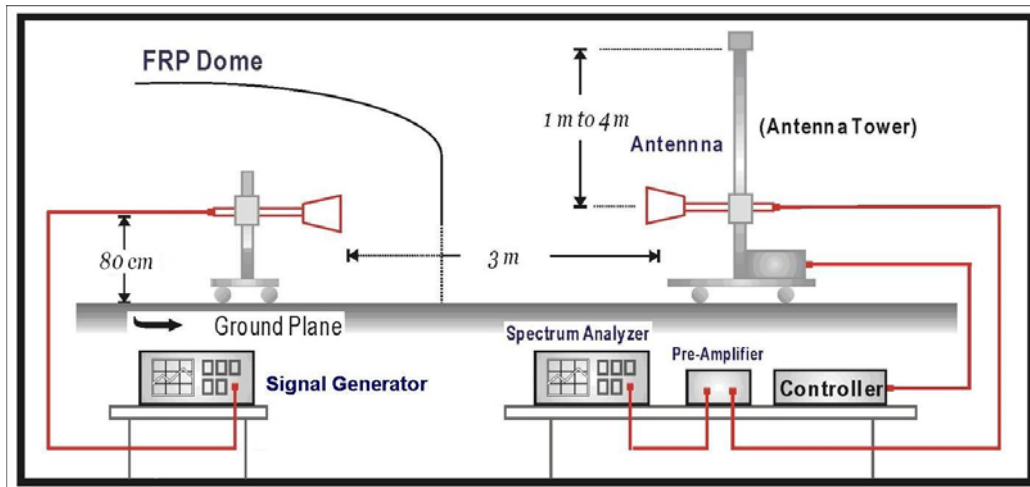

7.3. Limits

- (1) Fixed and Temporary Fixed Digital Stations: not less than $43 + \log(P)$ dB.
- (2) Mobile Digital Stations: not less than $43 + \log(P)$ dB at the channel edge and $55 + \log(P)$ dB at 5.5 MHz from the channel edges.

Sample Calculation:

Assume the EUT Output Power is $2\text{ W} = 33\text{ dBm}$

$43 + \log(P)$ dB

$43 + \log(2) = 46\text{ dB}$

$33\text{ dBm} - 46\text{ dB} = -13\text{ dBm}$

$55 + \log(2) = 58\text{ dB}$

$33\text{ dBm} - 58\text{ dB} = -25\text{ dBm}$

7.4. Test Procedure

For measuring E.I.R.P peak power, EUT was placed on the turn-table which was rotated around 360 degrees to search the maximum radiation power and receiver antenna was rotated vertical and horizontal polarization to find the maximum polarization radiated power.

The EUT is replaced by a horn antenna connected to a signal generator tuned to the frequency of emission and level of signal generator adjusted to same level of emission. Both horizontal and vertical polarization of the antenna are set on measurement.

On any frequency, the limits shown are based on measuring equipment employing a peak detector function. The resolution bandwidth of spectrum analyzer is 1MHz. and video bandwidth is 3MHz.

The radiated E.I.R.P power was calculated via the Correct factor, Reading Level, and Antenna gain as follows:

$$\text{E.I.R.P} = \text{Reading Level} + \text{Correct Factor} = \text{S.G.} - \text{Cable Loss} + \text{Antenna Gain}$$

7.5. Uncertainty

The measurement uncertainty

30MHz~1GHz as $\pm 3.19\text{dB}$

1GHz~27GHz as $\pm 3.9\text{dB}$

7.6. Test Result

30 MHz - 1 GHz Spurious:

Site : CB4-H	Time : 2017/02/20
Limit : FCC_Part27(outband)_00M_PK	Margin : 6
Probe : CB4-H_CE_Sub_30-1GHz_3M_0117 - HORIZONTAL	Power : DC 3.8V
EUT : LE910C1-NA	Note : Mode 1: WCDMA Band 4_Link mode_1732.6MHz

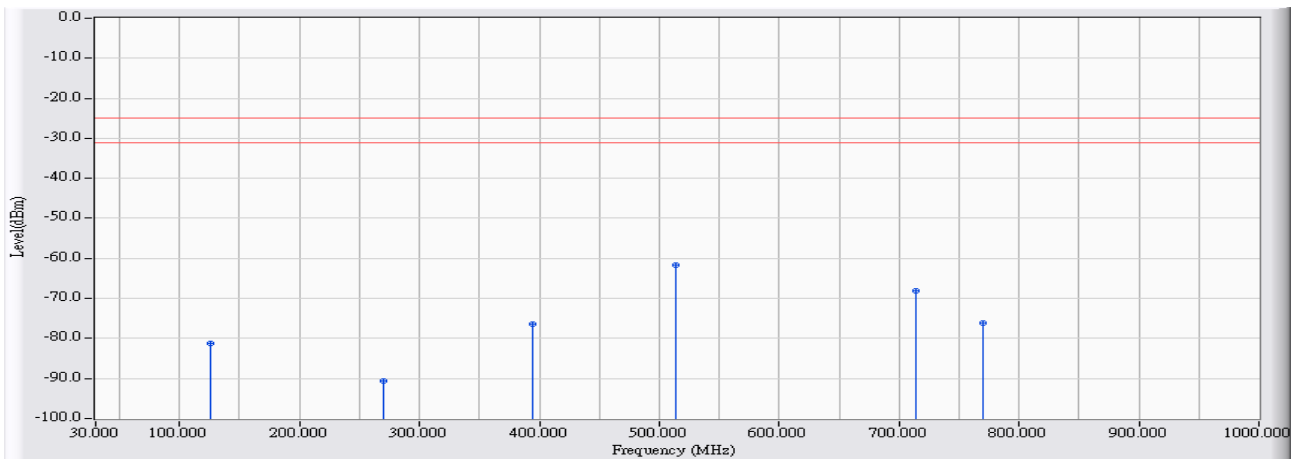

	Frequency (MHz)	Correct Factor (dB)	Reading Level (dBm)	Measure Level (dBm)	Margin (dB)	Limit (dBm)	Detector Type
1	125.632	-28.223	-52.992	-81.215	-56.215	-25.000	PEAK
2	270.245	-23.722	-66.858	-90.580	-65.580	-25.000	PEAK
3	394.975	-21.938	-54.589	-76.527	-51.527	-25.000	PEAK
4	* 513.982	-19.164	-42.469	-61.633	-36.633	-25.000	PEAK
5	713.491	-17.578	-50.518	-68.096	-43.096	-25.000	PEAK
6	770.133	-16.055	-59.970	-76.026	-51.026	-25.000	PEAK

Note:

1. All Reading Levels are Quasi-Peak value.
2. “ * ”, means this data is the worst emission level.
3. Measurement Level = Reading Level + Correct Factor.

Site : CB4-H	Time : 2017/02/20
Limit : FCC_Part27(outband)_00M_PK	Margin : 6
Probe : CB4-H_CE_Sub_30-1GHz_3M_0117 - VERTICAL	Power : DC 3.8V
EUT : LE910C1-NA	Note : Mode 1: WCDMA Band 4_Link mode_1732.6MHz

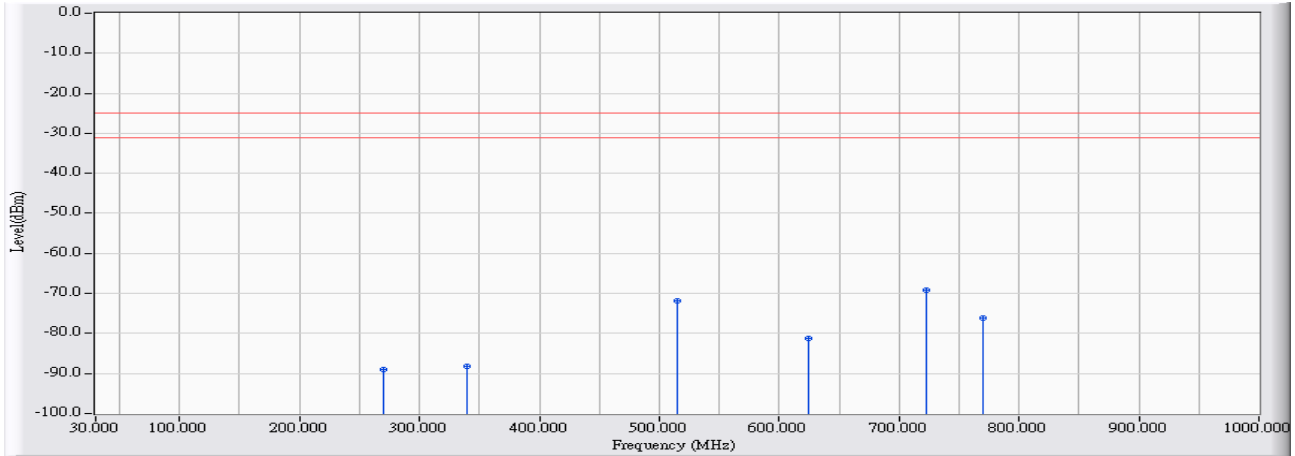

	Frequency (MHz)	Correct Factor (dB)	Reading Level (dBm)	Measure Level (dBm)	Margin (dB)	Limit (dBm)	Detector Type
1	270.245	-23.406	-65.546	-88.952	-63.952	-25.000	PEAK
2	340.078	-22.222	-66.076	-88.297	-63.297	-25.000	PEAK
3	514.952	-18.054	-53.725	-71.780	-46.780	-25.000	PEAK
4	623.969	-15.913	-65.289	-81.201	-56.201	-25.000	PEAK
5	* 722.414	-15.391	-53.695	-69.086	-44.086	-25.000	PEAK
6	770.230	-15.428	-60.836	-76.264	-51.264	-25.000	PEAK

Note:

1. All Reading Levels are Quasi-Peak value.
2. “ * ”, means this data is the worst emission level.
3. Measurement Level = Reading Level + Correct Factor.

Site : CB4-H	Time : 2017/02/20
Limit : FCC_Part27(outband)_00M_PK	Margin : 6
Probe : CB4-H_CE_Sub_30-1GHz_3M_0117 - HORIZONTAL	Power : DC 3.8V
EUT : LE910C1-NA	Note : Mode 2: WCDMA Band 4_Idle mode_1732.6MHz

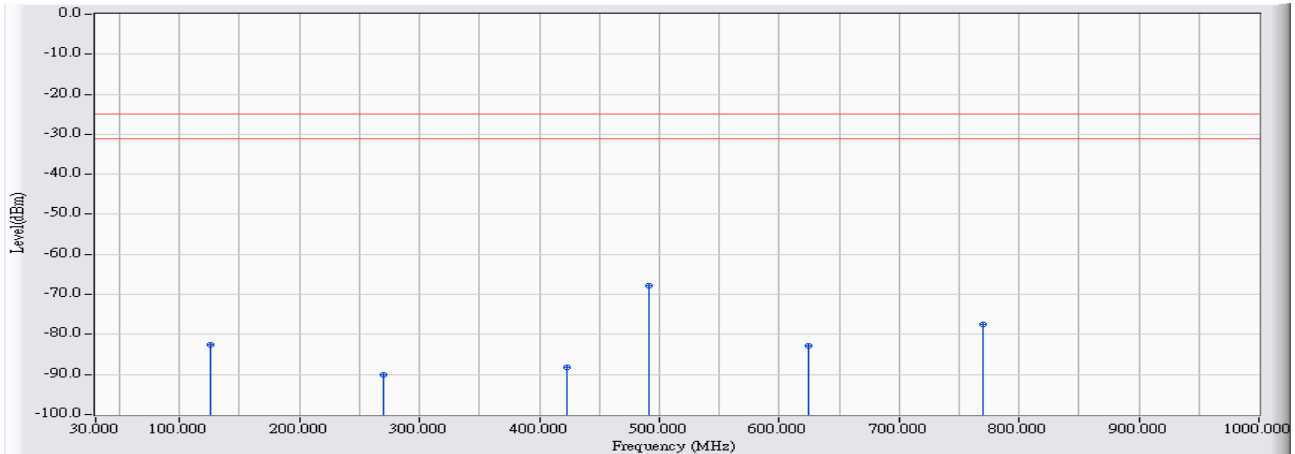

	Frequency (MHz)	Correct Factor (dB)	Reading Level (dBm)	Measure Level (dBm)	Margin (dB)	Limit (dBm)	Detector Type
1	125.632	-28.223	-54.369	-82.592	-57.592	-25.000	PEAK
2	270.342	-23.729	-66.412	-90.141	-65.141	-25.000	PEAK
3	422.520	-20.069	-68.164	-88.234	-63.234	-25.000	PEAK
4	* 491.965	-20.248	-47.547	-67.794	-42.794	-25.000	PEAK
5	623.969	-17.209	-65.665	-82.874	-57.874	-25.000	PEAK
6	769.648	-16.101	-61.460	-77.561	-52.561	-25.000	PEAK

Note:

1. All Reading Levels are Quasi-Peak value.
2. “ * ”, means this data is the worst emission level.
3. Measurement Level = Reading Level + Correct Factor.

Site : CB4-H	Time : 2017/02/20
Limit : FCC_Part27(outband)_00M_PK	Margin : 6
Probe : CB4-H_CE_Sub_30-1GHz_3M_0117 - VERTICAL	Power : DC 3.8V
EUT : LE910C1-NA	Note : Mode 2: WCDMA Band 4_Idle mode_1732.6MHz

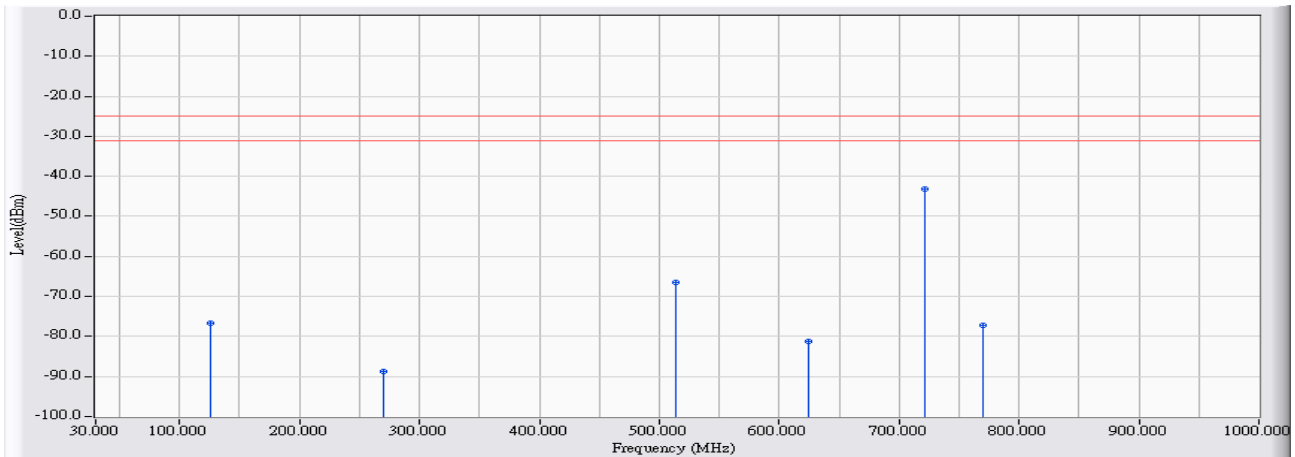

	Frequency (MHz)	Correct Factor (dB)	Reading Level (dBm)	Measure Level (dBm)	Margin (dB)	Limit (dBm)	Detector Type
1	125.632	-22.524	-54.047	-76.571	-51.571	-25.000	PEAK
2	270.245	-23.406	-65.253	-88.659	-63.659	-25.000	PEAK
3	513.788	-18.063	-48.450	-66.513	-41.513	-25.000	PEAK
4	623.969	-15.913	-65.364	-81.276	-56.276	-25.000	PEAK
5	* 721.638	-15.442	-27.829	-43.271	-18.271	-25.000	PEAK
6	769.551	-15.462	-61.768	-77.230	-52.230	-25.000	PEAK

Note:

1. All Reading Levels are Quasi-Peak value.
2. “ * ”, means this data is the worst emission level.
3. Measurement Level = Reading Level + Correct Factor.

Site : CB4-H	Time : 2017/02/23
Limit : FCC_Part22/24_00M_00M_PK	Margin : 6
Probe : CB4-H_CE_Sub_S2_30M-1GHz_1116 - HORIZONTAL	Power : DC 3.8V
EUT : LE910C1-NA	Note : Mode 3: WCDMA Band 4_HSUPA Mode_Link _1732.6

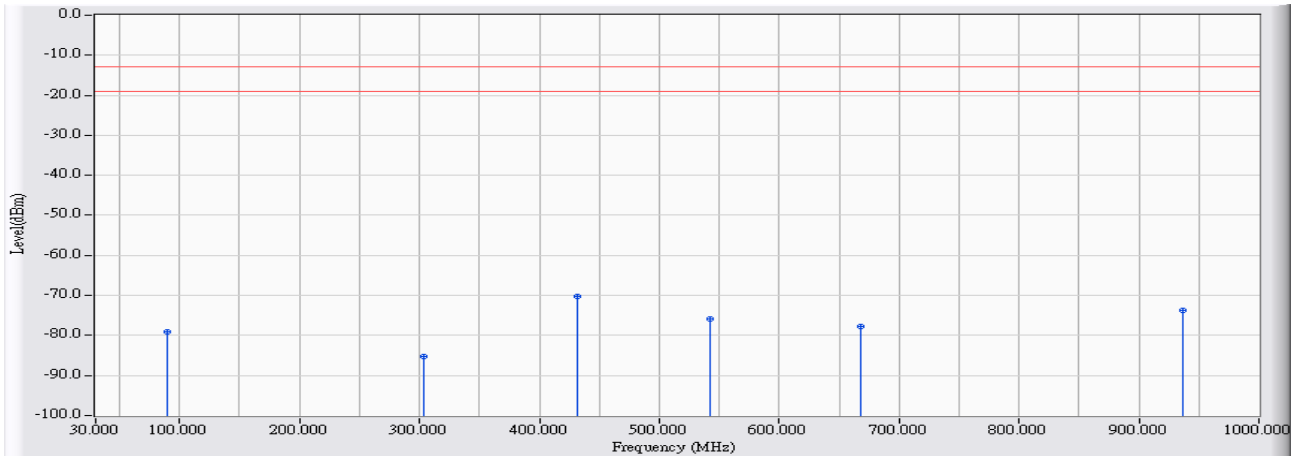

	Frequency (MHz)	Correct Factor (dB)	Reading Level (dBm)	Measure Level (dBm)	Margin (dB)	Limit (dBm)	Detector Type
1	90.140	-28.250	-50.761	-79.010	-66.010	-13.000	PEAK
2	304.025	-20.385	-64.760	-85.144	-72.144	-13.000	PEAK
3	* 431.580	-15.857	-54.350	-70.208	-57.208	-13.000	PEAK
4	542.645	-13.547	-62.358	-75.905	-62.905	-13.000	PEAK
5	668.260	-11.734	-65.958	-77.693	-64.693	-13.000	PEAK
6	936.950	-7.721	-66.039	-73.761	-60.761	-13.000	PEAK

Note:

1. All Reading Levels are Quasi-Peak value.
2. “ * ”, means this data is the worst emission level.
3. Measurement Level = Reading Level + Correct Factor.

Site : CB4-H	Time : 2017/02/23
Limit : FCC_Part22/24_00M_00M_PK	Margin : 6
Probe : CB4-H_CE_Sub_S2_30M-1GHz_1116 - VERTICAL	Power : DC 3.8V
EUT : LE910C1-NA	Note : Mode 3: WCDMA Band 4_HSUPA Mode_Link _1732.6

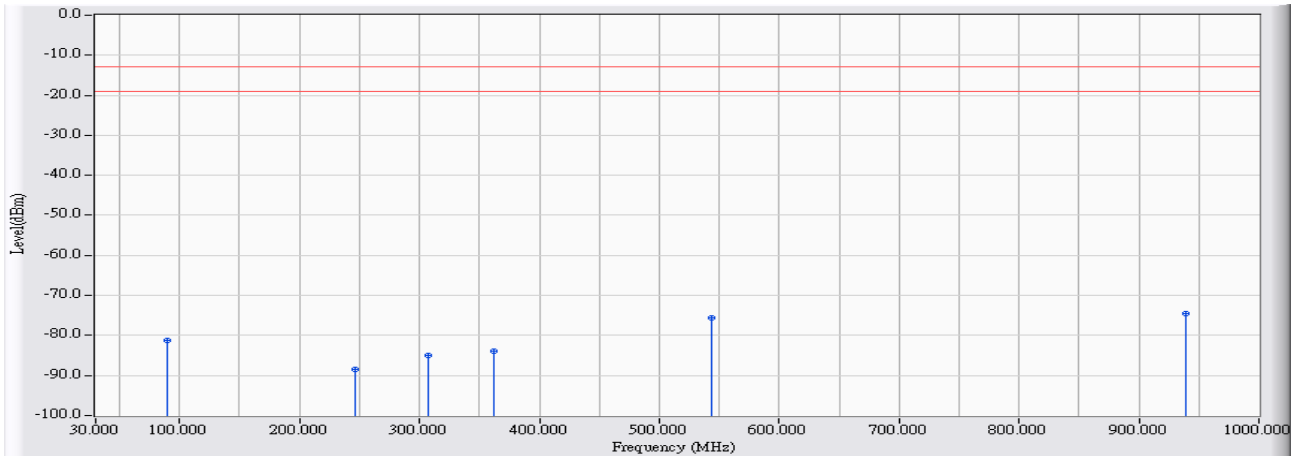

	Frequency (MHz)	Correct Factor (dB)	Reading Level (dBm)	Measure Level (dBm)	Margin (dB)	Limit (dBm)	Detector Type
1	90.140	-22.034	-59.078	-81.112	-68.112	-13.000	PEAK
2	245.825	-22.544	-65.976	-88.520	-75.520	-13.000	PEAK
3	307.905	-20.129	-64.961	-85.091	-72.091	-13.000	PEAK
4	362.225	-18.012	-66.014	-84.025	-71.025	-13.000	PEAK
5	543.615	-13.014	-62.479	-75.493	-62.493	-13.000	PEAK
6	* 939.375	-7.525	-66.905	-74.430	-61.430	-13.000	PEAK

Note:

1. All Reading Levels are Quasi-Peak value.
2. “ * ”, means this data is the worst emission level.
3. Measurement Level = Reading Level + Correct Factor.

Site : CB4-H	Time : 2017/02/23
Limit : FCC_Part22/24_00M_00M_PK	Margin : 6
Probe : CB4-H_CE_Sub_S2_30M-1GHz_1116 - HORIZONTAL	Power : DC 3.8V
EUT : LE910C1-NA	Note : Mode 3: WCDMA Band 4_HSUPA Mode_Idle _1732.6

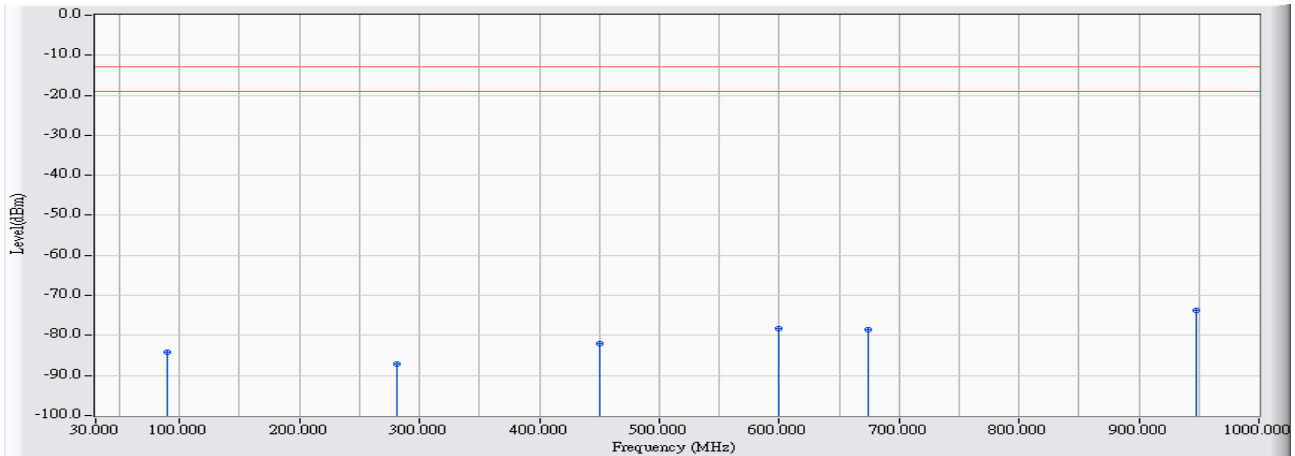

	Frequency (MHz)	Correct Factor (dB)	Reading Level (dBm)	Measure Level (dBm)	Margin (dB)	Limit (dBm)	Detector Type
1	89.170	-28.339	-55.965	-84.304	-71.304	-13.000	PEAK
2	281.230	-21.310	-65.909	-87.219	-74.219	-13.000	PEAK
3	450.495	-15.058	-66.944	-82.001	-69.001	-13.000	PEAK
4	599.390	-12.652	-65.754	-78.405	-65.405	-13.000	PEAK
5	674.565	-11.546	-67.109	-78.656	-65.656	-13.000	PEAK
6	* 947.620	-7.407	-66.351	-73.758	-60.758	-13.000	PEAK

Note:

1. All Reading Levels are Quasi-Peak value.
2. “ * ”, means this data is the worst emission level.
3. Measurement Level = Reading Level + Correct Factor.

Site : CB4-H	Time : 2017/02/23
Limit : FCC_Part22/24_00M_00M_PK	Margin : 6
Probe : CB4-H_CE_Sub_S2_30M-1GHz_1116 - VERTICAL	Power : DC 3.8V
EUT : LE910C1-NA	Note : Mode 3: WCDMA Band 4_HSUPA Mode_Idle _1732.6

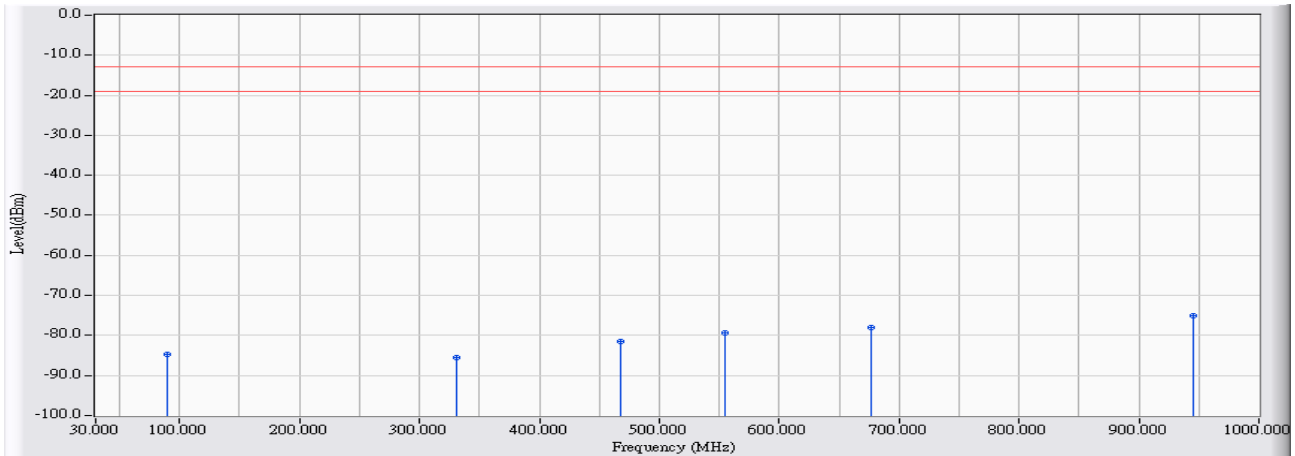

	Frequency (MHz)	Correct Factor (dB)	Reading Level (dBm)	Measure Level (dBm)	Margin (dB)	Limit (dBm)	Detector Type
1	90.140	-22.034	-62.716	-84.750	-71.750	-13.000	PEAK
2	330.700	-19.084	-66.485	-85.569	-72.569	-13.000	PEAK
3	467.470	-14.731	-66.881	-81.612	-68.612	-13.000	PEAK
4	554.285	-12.750	-66.584	-79.334	-66.334	-13.000	PEAK
5	676.505	-11.068	-67.035	-78.104	-65.104	-13.000	PEAK
6	* 945.195	-7.423	-67.624	-75.047	-62.047	-13.000	PEAK

Note:

1. All Reading Levels are Quasi-Peak value.
2. “ * ”, means this data is the worst emission level.
3. Measurement Level = Reading Level + Correct Factor.

Site : CB4-H	Time : 2017/02/23
Limit : FCC_Part22/24_00M_00M_PK	Margin : 6
Probe : CB4-H_CE_Sub_S2_30M-1GHz_1116 - HORIZONTAL	Power : DC 3.8V
EUT : LE910C1-NA	Note : Mode 4: WCDMA Band 4_HSDPA Mode_Link _1732.6

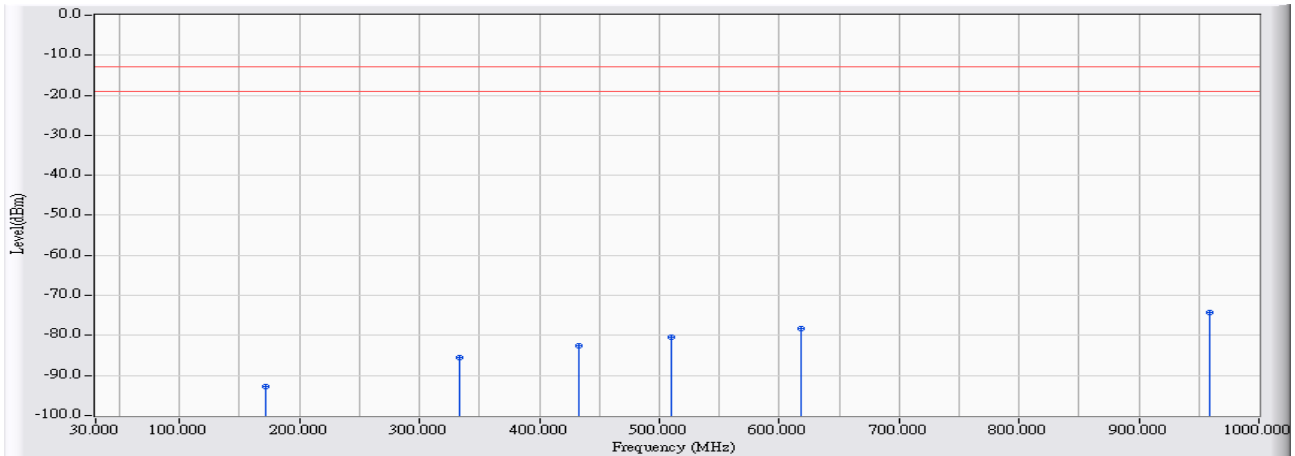

	Frequency (MHz)	Correct Factor (dB)	Reading Level (dBm)	Measure Level (dBm)	Margin (dB)	Limit (dBm)	Detector Type
1	172.105	-26.731	-65.914	-92.645	-79.645	-13.000	PEAK
2	333.610	-18.919	-66.679	-85.598	-72.598	-13.000	PEAK
3	433.035	-15.812	-66.866	-82.679	-69.679	-13.000	PEAK
4	509.665	-13.950	-66.569	-80.519	-67.519	-13.000	PEAK
5	617.820	-11.881	-66.370	-78.251	-65.251	-13.000	PEAK
6	* 958.775	-7.894	-66.249	-74.142	-61.142	-13.000	PEAK

Note:

1. All Reading Levels are Quasi-Peak value.
2. “ * ”, means this data is the worst emission level.
3. Measurement Level = Reading Level + Correct Factor.

Site : CB4-H	Time : 2017/02/23
Limit : FCC_Part22/24_00M_00M_PK	Margin : 6
Probe : CB4-H_CE_Sub_S2_30M-1GHz_1116 - VERTICAL	Power : DC 3.8V
EUT : LE910C1-NA	Note : Mode 4: WCDMA Band 4_HSDPA Mode_Link _1732.6

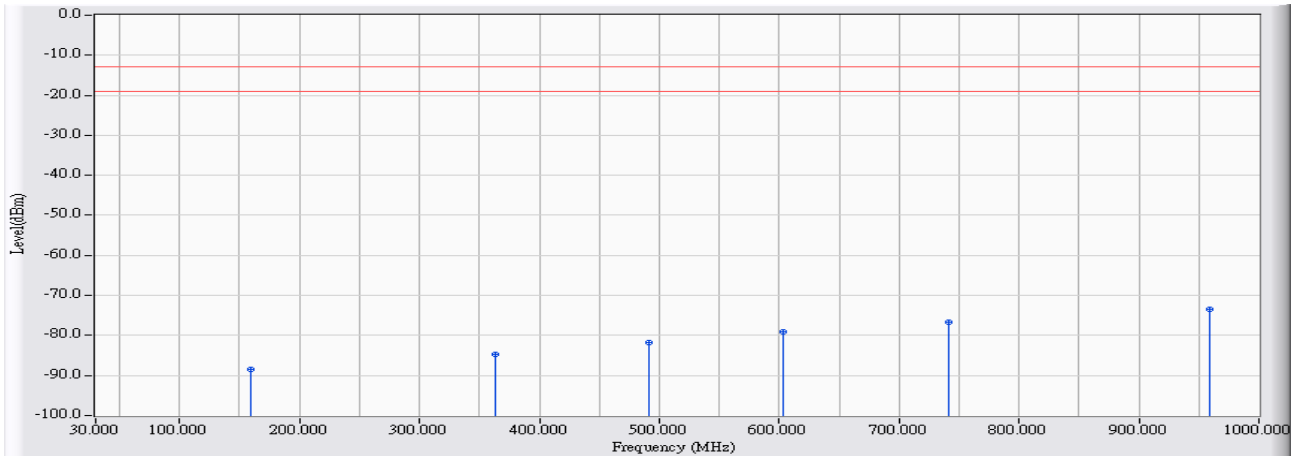

	Frequency (MHz)	Correct Factor (dB)	Reading Level (dBm)	Measure Level (dBm)	Margin (dB)	Limit (dBm)	Detector Type
1	159.495	-22.754	-65.664	-88.418	-75.418	-13.000	PEAK
2	362.710	-18.017	-66.644	-84.661	-71.661	-13.000	PEAK
3	490.750	-14.177	-67.525	-81.702	-68.702	-13.000	PEAK
4	603.755	-11.818	-67.398	-79.215	-66.215	-13.000	PEAK
5	741.010	-10.330	-66.351	-76.680	-63.680	-13.000	PEAK
6	* 958.775	-7.869	-65.702	-73.570	-60.570	-13.000	PEAK

Note:

1. All Reading Levels are Quasi-Peak value.
2. “ * ”, means this data is the worst emission level.
3. Measurement Level = Reading Level + Correct Factor.

Site : CB4-H	Time : 2017/02/23
Limit : FCC_Part22/24_00M_00M_PK	Margin : 6
Probe : CB4-H_CE_Sub_S2_30M-1GHz_1116 - HORIZONTAL	Power : DC 3.8V
EUT : LE910C1-NA	Note : Mode 4: WCDMA Band 4_HSDPA Mode_Ilde _1732.6

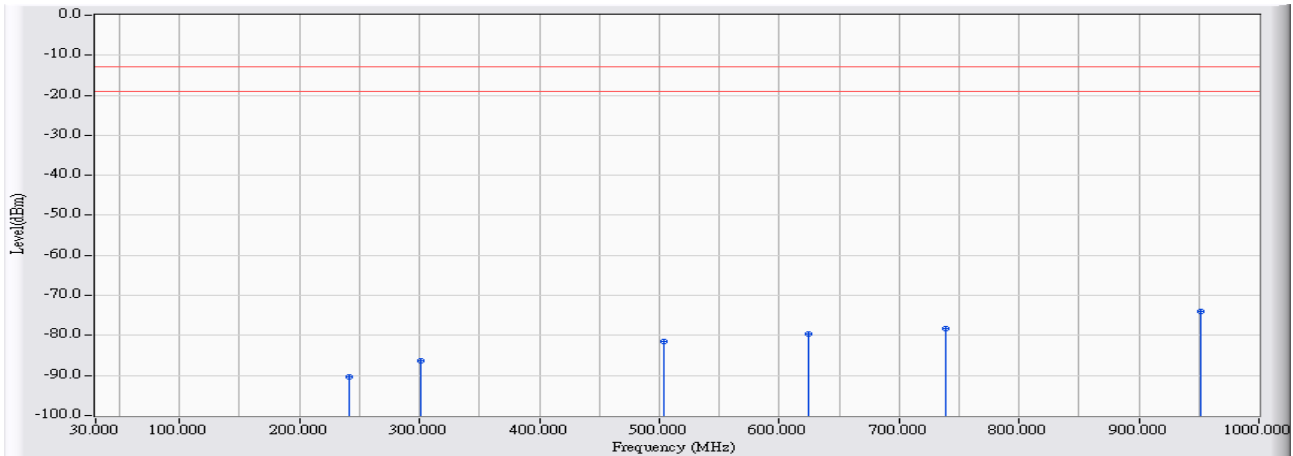

	Frequency (MHz)	Correct Factor (dB)	Reading Level (dBm)	Measure Level (dBm)	Margin (dB)	Limit (dBm)	Detector Type
1	241.460	-24.302	-66.004	-90.306	-77.306	-13.000	PEAK
2	301.115	-20.453	-65.942	-86.395	-73.395	-13.000	PEAK
3	503.360	-14.263	-67.185	-81.448	-68.448	-13.000	PEAK
4	624.610	-11.958	-67.754	-79.711	-66.711	-13.000	PEAK
5	739.070	-10.601	-67.592	-78.193	-65.193	-13.000	PEAK
6	* 951.015	-7.443	-66.626	-74.069	-61.069	-13.000	PEAK

Note:

1. All Reading Levels are Quasi-Peak value.
2. “ * ”, means this data is the worst emission level.
3. Measurement Level = Reading Level + Correct Factor.

Site : CB4-H	Time : 2017/02/23
Limit : FCC_Part22/24_00M_00M_PK	Margin : 6
Probe : CB4-H_CE_Sub_S2_30M-1GHz_1116 - VERTICAL	Power : DC 3.8V
EUT : LE910C1-NA	Note : Mode 4: WCDMA Band 4_HSDPA Mode_Ilde _1732.6

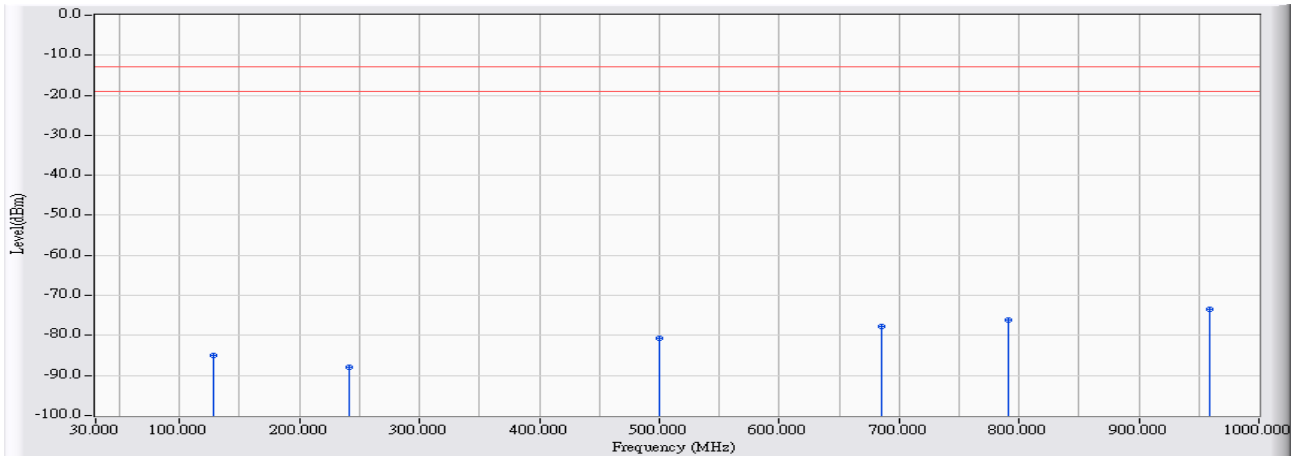

	Frequency (MHz)	Correct Factor (dB)	Reading Level (dBm)	Measure Level (dBm)	Margin (dB)	Limit (dBm)	Detector Type
1	128.455	-22.216	-62.808	-85.023	-72.023	-13.000	PEAK
2	241.460	-22.810	-65.182	-87.992	-74.992	-13.000	PEAK
3	500.450	-14.009	-66.668	-80.676	-67.676	-13.000	PEAK
4	684.750	-11.225	-66.455	-77.679	-64.679	-13.000	PEAK
5	790.480	-9.260	-66.833	-76.094	-63.094	-13.000	PEAK
6	* 958.775	-7.869	-65.649	-73.517	-60.517	-13.000	PEAK

Note:

1. All Reading Levels are Quasi-Peak value.
2. “ * ”, means this data is the worst emission level.
3. Measurement Level = Reading Level + Correct Factor.

Harmonic & Spurious:

Site : CB4-H	Time : 2017/02/20
Limit : FCC_Part27(outband)_00M_PK	Margin : 6
Probe : CB4-H_CE_Sub_B091_1-18GHz_3M_0117 - HORIZONTAL	Power : DC 3.8V
EUT : LE910C1-NA	Note : Mode 1: WCDMA Band 4_Link mode_1712.4MHz

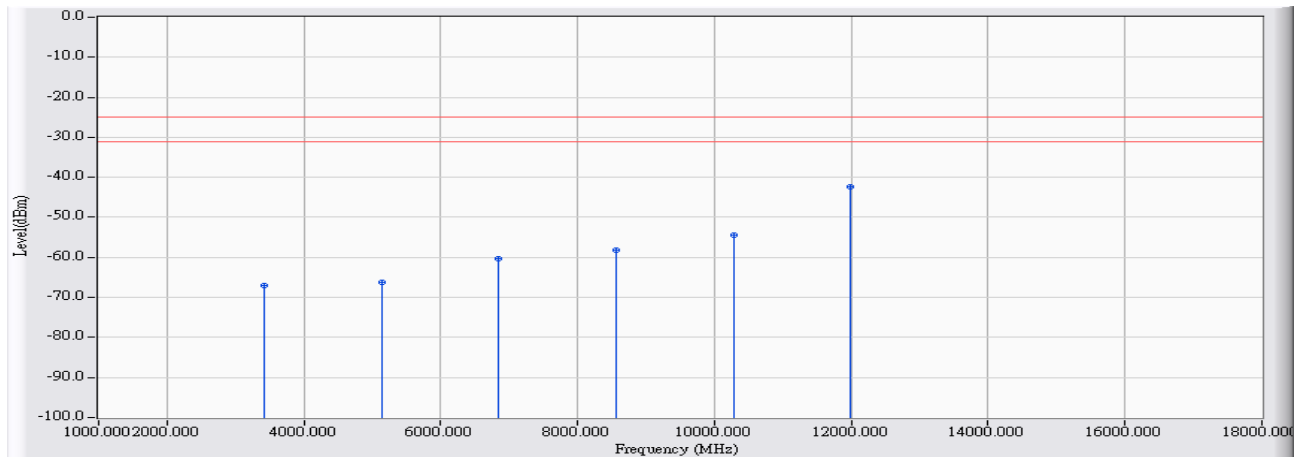

	Frequency (MHz)	Correct Factor (dB)	Reading Level (dBm)	Measure Level (dBm)	Margin (dB)	Limit (dBm)	Detector Type
1	3424.800	5.795	-72.730	-66.935	-41.935	-25.000	PEAK
2	5137.200	10.814	-76.960	-66.146	-41.146	-25.000	PEAK
3	6849.600	17.088	-77.540	-60.452	-35.452	-25.000	PEAK
4	8562.000	22.457	-80.760	-58.303	-33.303	-25.000	PEAK
5	10274.400	28.183	-82.620	-54.437	-29.437	-25.000	PEAK
6	* 11986.800	30.723	-73.180	-42.457	-17.457	-25.000	PEAK

Note:

1. All readings above 1GHz are performed with peak and/or average measurements as necessary.
2. Peak measurements: RBW = 1MHz, VBW = 1MHz, Sweep: Auto.
3. Average measurements: RBW = 1MHz, VBW = 10 Hz, Sweep: Auto.
4. “ * ”, means this data is the worst emission level.
5. Measurement Level = Reading Level + Correct Factor.
6. The average measurement was not performed when the peak measured data under the limit of average detection.
7. The Emission above 18GHz were not included is because their levels are too low.

Site : CB4-H	Time : 2017/02/20
Limit : FCC_Part27(outband)_00M_PK	Margin : 6
Probe : CB4-H_CE_Sub_B091_1-18GHz_3M_0117 - VERTICAL	Power : DC 3.8V
EUT : LE910C1-NA	Note : Mode 1: WCDMA Band 4_Link mode_1712.4MHz

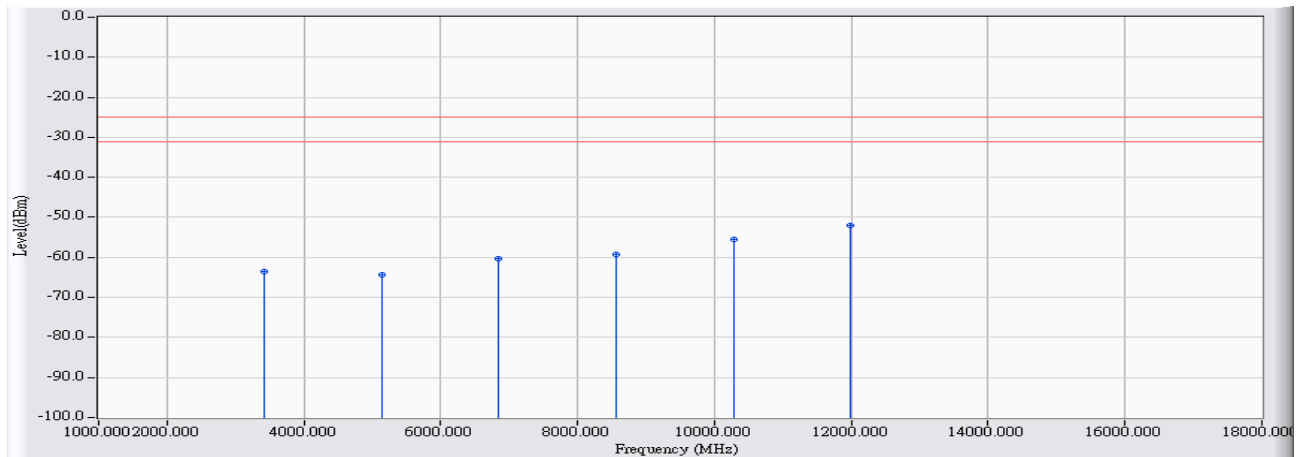

	Frequency (MHz)	Correct Factor (dB)	Reading Level (dBm)	Measure Level (dBm)	Margin (dB)	Limit (dBm)	Detector Type
1	3424.800	5.506	-69.020	-63.515	-38.515	-25.000	PEAK
2	5137.200	11.109	-75.330	-64.221	-39.221	-25.000	PEAK
3	6849.600	16.988	-77.330	-60.343	-35.343	-25.000	PEAK
4	8562.000	22.295	-81.440	-59.145	-34.145	-25.000	PEAK
5	10274.400	27.723	-83.240	-55.517	-30.517	-25.000	PEAK
6	* 11986.800	30.410	-82.420	-52.009	-27.009	-25.000	PEAK

Note:

1. All readings above 1GHz are performed with peak and/or average measurements as necessary.
2. Peak measurements: RBW = 1MHz, VBW = 1MHz, Sweep: Auto.
3. Average measurements: RBW = 1MHz, VBW = 10 Hz, Sweep: Auto.
4. “ * ”, means this data is the worst emission level.
5. Measurement Level = Reading Level + Correct Factor.
6. The average measurement was not performed when the peak measured data under the limit of average detection.
7. The Emission above 18GHz were not included is because their levels are too low.

Site : CB4-H	Time : 2017/02/20
Limit : FCC_Part27(outband)_00M_PK	Margin : 6
Probe : CB4-H_CE_Sub_B091_1-18GHz_3M_0117 - HORIZONTAL	Power : DC 3.8V
EUT : LE910C1-NA	Note : Mode 1: WCDMA Band 4_Link mode_1732.6MHz

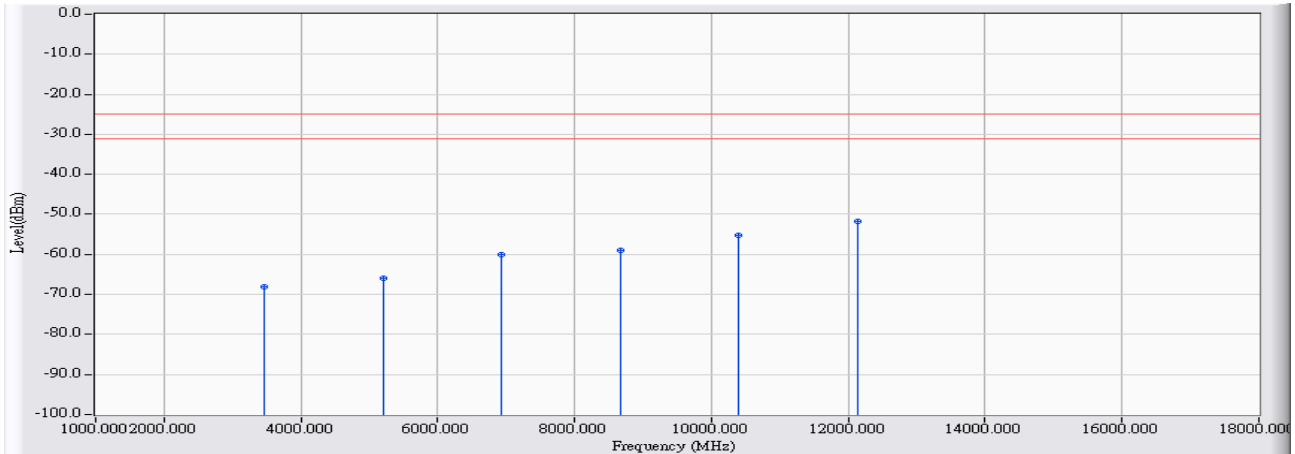

	Frequency (MHz)	Correct Factor (dB)	Reading Level (dBm)	Measure Level (dBm)	Margin (dB)	Limit (dBm)	Detector Type
1	3465.200	5.864	-74.020	-68.156	-43.156	-25.000	PEAK
2	5197.800	10.965	-76.810	-65.846	-40.846	-25.000	PEAK
3	6930.400	17.772	-77.910	-60.139	-35.139	-25.000	PEAK
4	8663.000	22.321	-81.250	-58.929	-33.929	-25.000	PEAK
5	10395.600	28.475	-83.650	-55.175	-30.175	-25.000	PEAK
6	* 12128.200	31.454	-83.190	-51.736	-26.736	-25.000	PEAK

Note:

1. All readings above 1GHz are performed with peak and/or average measurements as necessary.
2. Peak measurements: RBW = 1MHz, VBW = 1MHz, Sweep: Auto.
3. Average measurements: RBW = 1MHz, VBW = 10 Hz, Sweep: Auto.
4. “ * ”, means this data is the worst emission level.
5. Measurement Level = Reading Level + Correct Factor.
6. The average measurement was not performed when the peak measured data under the limit of average detection.
7. The Emission above 18GHz were not included is because their levels are too low.

Site : CB4-H	Time : 2017/02/20
Limit : FCC_Part27(outband)_00M_PK	Margin : 6
Probe : CB4-H_CE_Sub_B091_1-18GHz_3M_0117 - VERTICAL	Power : DC 3.8V
EUT : LE910C1-NA	Note : Mode 1: WCDMA Band 4_Link mode_1732.6MHz

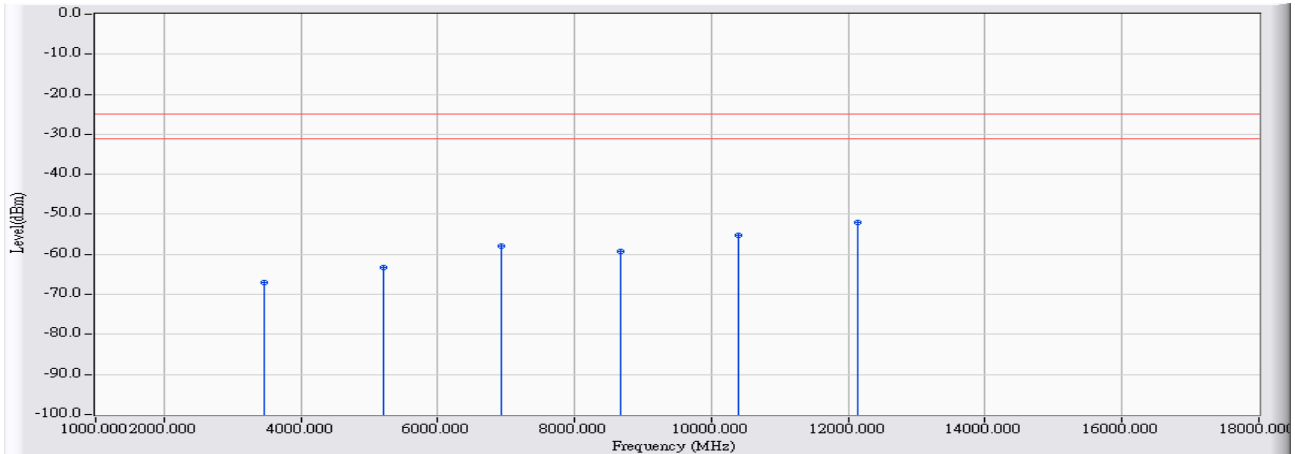

		Frequency (MHz)	Correct Factor (dB)	Reading Level (dBm)	Measure Level (dBm)	Margin (dB)	Limit (dBm)	Detector Type
1		3465.200	5.572	-72.650	-67.078	-42.078	-25.000	PEAK
2		5197.800	11.173	-74.350	-63.178	-38.178	-25.000	PEAK
3		6930.400	17.806	-75.790	-57.985	-32.985	-25.000	PEAK
4		8663.000	22.187	-81.490	-59.303	-34.303	-25.000	PEAK
5		10395.600	28.090	-83.190	-55.100	-30.100	-25.000	PEAK
6	*	12128.200	31.264	-83.240	-51.977	-26.977	-25.000	PEAK

Note:

1. All readings above 1GHz are performed with peak and/or average measurements as necessary.
2. Peak measurements: RBW = 1MHz, VBW = 1MHz, Sweep: Auto.
3. Average measurements: RBW = 1MHz, VBW = 10 Hz, Sweep: Auto.
4. “ * ”, means this data is the worst emission level.
5. Measurement Level = Reading Level + Correct Factor.
6. The average measurement was not performed when the peak measured data under the limit of average detection.
7. The Emission above 18GHz were not included is because their levels are too low.

Site : CB4-H	Time : 2017/02/20
Limit : FCC_Part27(outband)_00M_PK	Margin : 6
Probe : CB4-H_CE_Sub_B091_1-18GHz_3M_0117 - HORIZONTAL	Power : DC 3.8V
EUT : LE910C1-NA	Note : Mode 1: WCDMA Band 4_Link mode_1752.6MHz

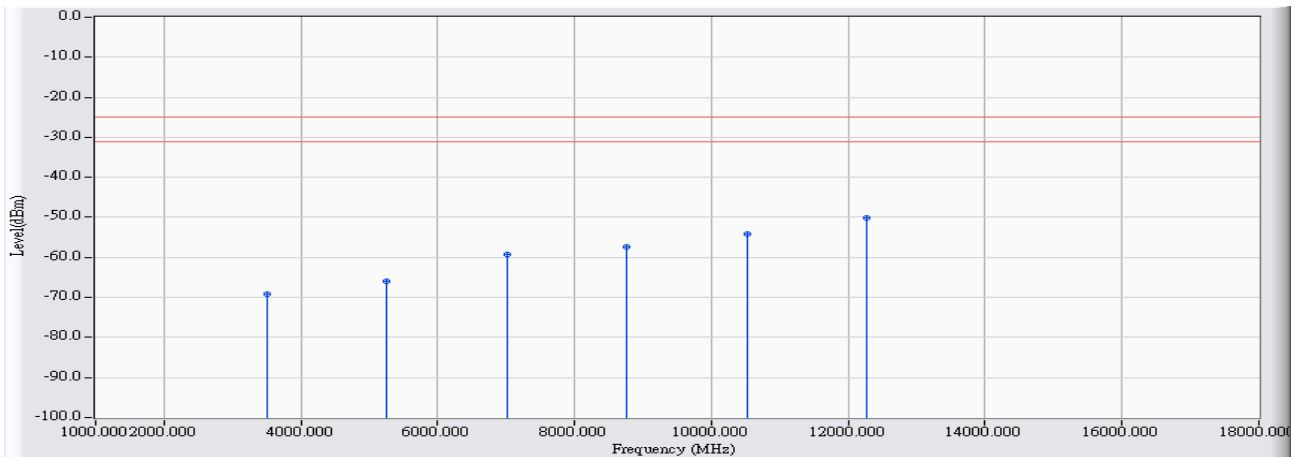

	Frequency (MHz)	Correct Factor (dB)	Reading Level (dBm)	Measure Level (dBm)	Margin (dB)	Limit (dBm)	Detector Type
1	3505.200	5.943	-74.980	-69.037	-44.037	-25.000	PEAK
2	5257.800	11.116	-76.940	-65.824	-40.824	-25.000	PEAK
3	7010.400	18.426	-77.580	-59.154	-34.154	-25.000	PEAK
4	8763.000	23.816	-81.270	-57.454	-32.454	-25.000	PEAK
5	10515.600	28.802	-82.880	-54.078	-29.078	-25.000	PEAK
6	* 12268.200	31.845	-82.070	-50.224	-25.224	-25.000	PEAK

Note:

1. All readings above 1GHz are performed with peak and/or average measurements as necessary.
2. Peak measurements: RBW = 1MHz, VBW = 1MHz, Sweep: Auto.
3. Average measurements: RBW = 1MHz, VBW = 10 Hz, Sweep: Auto.
4. “ * ”, means this data is the worst emission level.
5. Measurement Level = Reading Level + Correct Factor.
6. The average measurement was not performed when the peak measured data under the limit of average detection.
7. The Emission above 18GHz were not included is because their levels are too low.

Site : CB4-H	Time : 2017/02/20
Limit : FCC_Part27(outband)_00M_PK	Margin : 6
Probe : CB4-H_CE_Sub_B091_1-18GHz_3M_0117 - VERTICAL	Power : DC 3.8V
EUT : LE910C1-NA	Note : Mode 1: WCDMA Band 4_Link mode_1752.6MHz

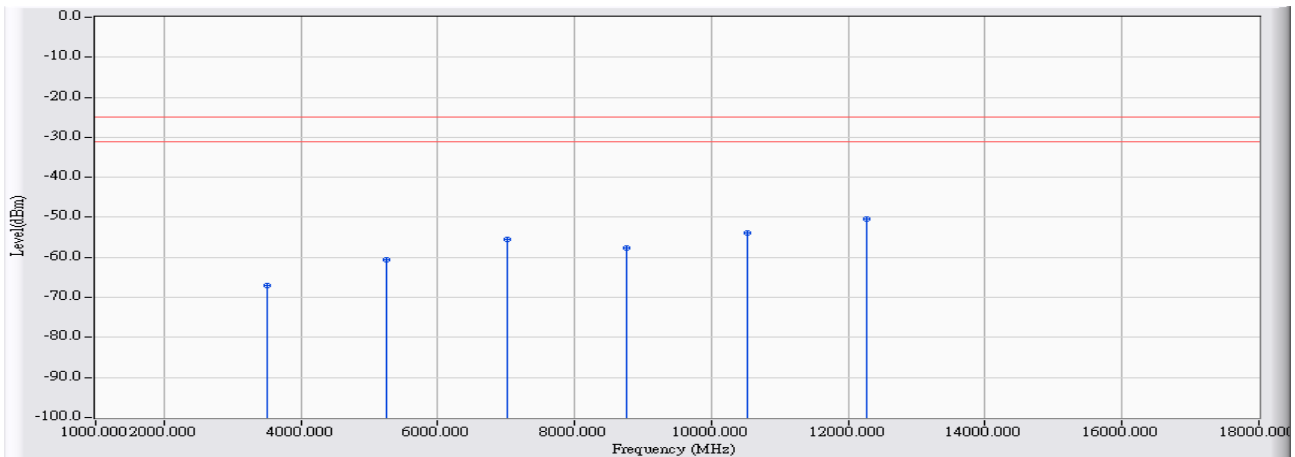

		Frequency (MHz)	Correct Factor (dB)	Reading Level (dBm)	Measure Level (dBm)	Margin (dB)	Limit (dBm)	Detector Type
1		3505.200	5.659	-72.740	-67.081	-42.081	-25.000	PEAK
2		5257.800	11.257	-71.760	-60.503	-35.503	-25.000	PEAK
3		7010.400	18.563	-73.930	-55.367	-30.367	-25.000	PEAK
4		8763.000	23.687	-81.200	-57.513	-32.513	-25.000	PEAK
5		10515.600	28.483	-82.270	-53.787	-28.787	-25.000	PEAK
6	*	12268.200	31.784	-82.270	-50.485	-25.485	-25.000	PEAK

Note:

1. All readings above 1GHz are performed with peak and/or average measurements as necessary.
2. Peak measurements: RBW = 1MHz, VBW = 1MHz, Sweep: Auto.
3. Average measurements: RBW = 1MHz, VBW = 10 Hz, Sweep: Auto.
4. “ * ”, means this data is the worst emission level.
5. Measurement Level = Reading Level + Correct Factor.
6. The average measurement was not performed when the peak measured data under the limit of average detection.
7. The Emission above 18GHz were not included is because their levels are too low.

Site : CB4-H	Time : 2017/02/20
Limit : FCC_Part27(outband)_00M_PK	Margin : 6
Probe : CB4-H_CE_Sub_B091_1-18GHz_3M_0117 - HORIZONTAL	Power : DC 3.8V
EUT : LE910C1-NA	Note : Mode 2: WCDMA Band 4_Idle mode_1712.4MHz

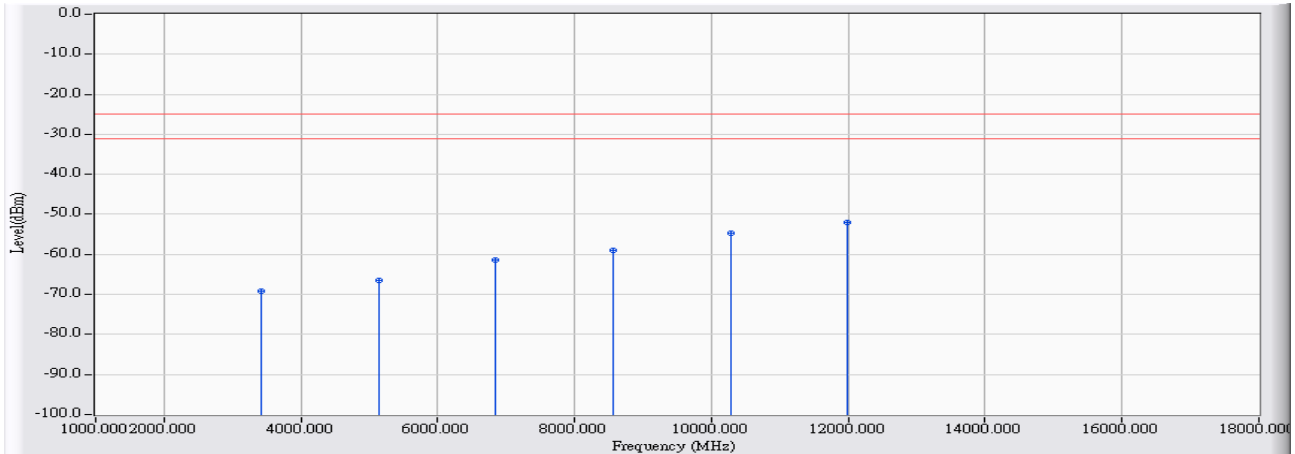

	Frequency (MHz)	Correct Factor (dB)	Reading Level (dBm)	Measure Level (dBm)	Margin (dB)	Limit (dBm)	Detector Type
1	3424.800	5.795	-75.060	-69.265	-44.265	-25.000	PEAK
2	5137.200	10.814	-77.340	-66.526	-41.526	-25.000	PEAK
3	6849.600	17.088	-78.450	-61.362	-36.362	-25.000	PEAK
4	8562.000	22.457	-81.400	-58.943	-33.943	-25.000	PEAK
5	10274.400	28.183	-82.910	-54.727	-29.727	-25.000	PEAK
6	* 11986.800	30.723	-82.620	-51.897	-26.897	-25.000	PEAK

Note:

1. All readings above 1GHz are performed with peak and/or average measurements as necessary.
2. Peak measurements: RBW = 1MHz, VBW = 1MHz, Sweep: Auto.
3. Average measurements: RBW = 1MHz, VBW = 10 Hz, Sweep: Auto.
4. “ * ”, means this data is the worst emission level.
5. Measurement Level = Reading Level + Correct Factor.
6. The average measurement was not performed when the peak measured data under the limit of average detection.
7. The Emission above 18GHz were not included is because their levels are too low.

Site : CB4-H	Time : 2017/02/20
Limit : FCC_Part27(outband)_00M_PK	Margin : 6
Probe : CB4-H_CE_Sub_B091_1-18GHz_3M_0117 - VERTICAL	Power : DC 3.8V
EUT : LE910C1-NA	Note : Mode 2: WCDMA Band 4_Idle mode_1712.4MHz

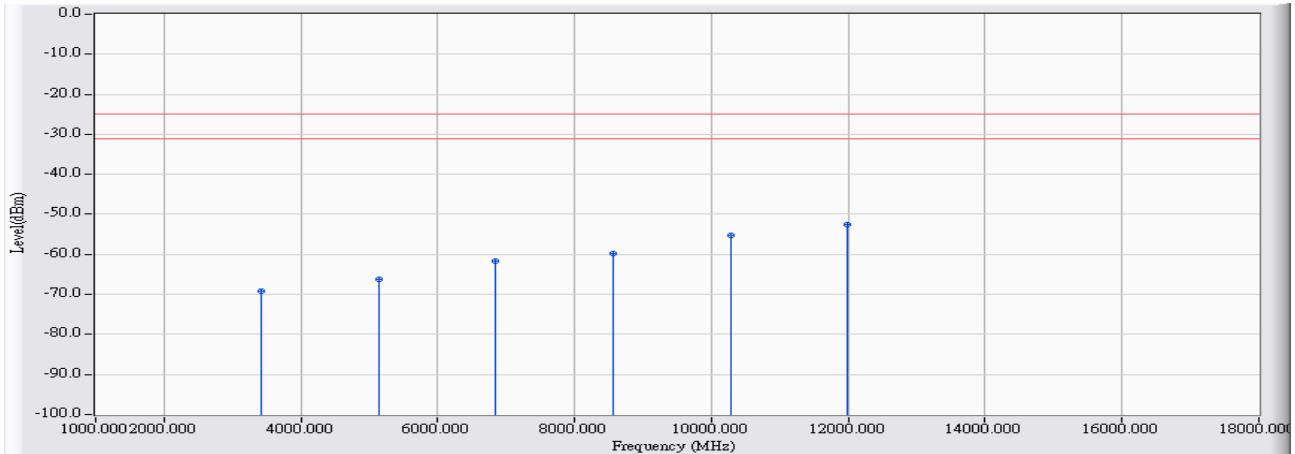

	Frequency (MHz)	Correct Factor (dB)	Reading Level (dBm)	Measure Level (dBm)	Margin (dB)	Limit (dBm)	Detector Type
1	3424.800	5.506	-74.590	-69.085	-44.085	-25.000	PEAK
2	5137.200	11.109	-77.350	-66.241	-41.241	-25.000	PEAK
3	6849.600	16.988	-78.780	-61.793	-36.793	-25.000	PEAK
4	8562.000	22.295	-81.960	-59.665	-34.665	-25.000	PEAK
5	10274.400	27.723	-82.940	-55.217	-30.217	-25.000	PEAK
6	* 11986.800	30.410	-82.840	-52.429	-27.429	-25.000	PEAK

Note:

1. All readings above 1GHz are performed with peak and/or average measurements as necessary.
2. Peak measurements: RBW = 1MHz, VBW = 1MHz, Sweep: Auto.
3. Average measurements: RBW = 1MHz, VBW = 10 Hz, Sweep: Auto.
4. “ * ”, means this data is the worst emission level.
5. Measurement Level = Reading Level + Correct Factor.
6. The average measurement was not performed when the peak measured data under the limit of average detection.
7. The Emission above 18GHz were not included is because their levels are too low.

Site : CB4-H	Time : 2017/02/20
Limit : FCC_Part27(outband)_00M_PK	Margin : 6
Probe : CB4-H_CE_Sub_B091_1-18GHz_3M_0117 - HORIZONTAL	Power : DC 3.8V
EUT : LE910C1-NA	Note : Mode 2: WCDMA Band 4_Idle mode_1732.6MHz

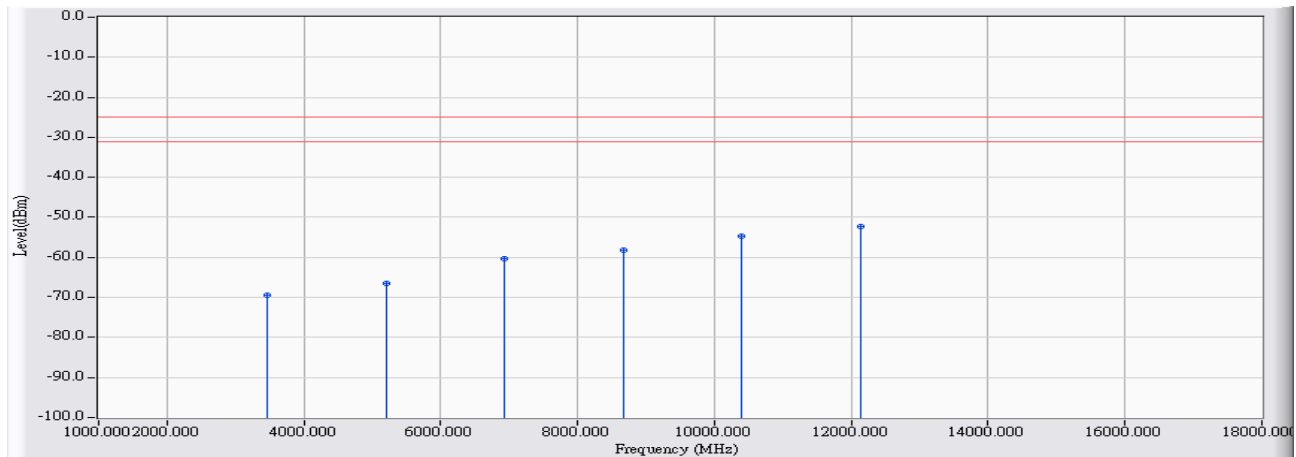

	Frequency (MHz)	Correct Factor (dB)	Reading Level (dBm)	Measure Level (dBm)	Margin (dB)	Limit (dBm)	Detector Type
1	3465.200	5.864	-75.260	-69.396	-44.396	-25.000	PEAK
2	5197.800	10.965	-77.360	-66.396	-41.396	-25.000	PEAK
3	6930.400	17.772	-78.030	-60.259	-35.259	-25.000	PEAK
4	8663.000	22.321	-80.530	-58.209	-33.209	-25.000	PEAK
5	10395.600	28.475	-83.130	-54.655	-29.655	-25.000	PEAK
6	* 12128.200	31.454	-83.750	-52.296	-27.296	-25.000	PEAK

Note:

1. All readings above 1GHz are performed with peak and/or average measurements as necessary.
2. Peak measurements: RBW = 1MHz, VBW = 1MHz, Sweep: Auto.
3. Average measurements: RBW = 1MHz, VBW = 10 Hz, Sweep: Auto.
4. “ * ”, means this data is the worst emission level.
5. Measurement Level = Reading Level + Correct Factor.
6. The average measurement was not performed when the peak measured data under the limit of average detection.
7. The Emission above 18GHz were not included is because their levels are too low.

Site : CB4-H	Time : 2017/02/20
Limit : FCC_Part27(outband)_00M_PK	Margin : 6
Probe : CB4-H_CE_Sub_B091_1-18GHz_3M_0117 - VERTICAL	Power : DC 3.8V
EUT : LE910C1-NA	Note : Mode 2: WCDMA Band 4_Idle mode_1732.6MHz

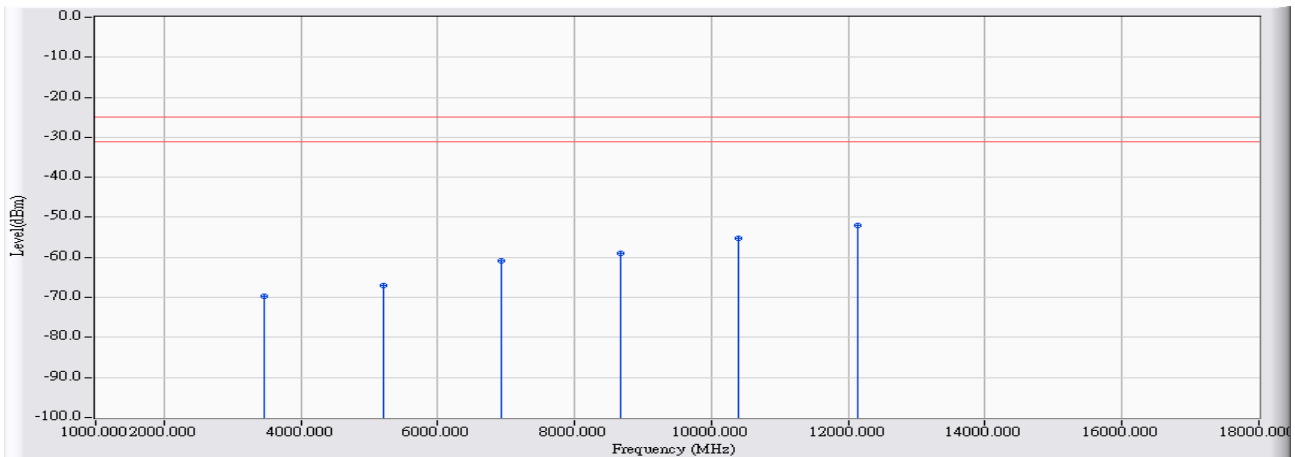

	Frequency (MHz)	Correct Factor (dB)	Reading Level (dBm)	Measure Level (dBm)	Margin (dB)	Limit (dBm)	Detector Type
1	3465.200	5.572	-75.350	-69.778	-44.778	-25.000	PEAK
2	5197.800	11.173	-78.140	-66.968	-41.968	-25.000	PEAK
3	6930.400	17.806	-78.790	-60.985	-35.985	-25.000	PEAK
4	8663.000	22.187	-81.180	-58.993	-33.993	-25.000	PEAK
5	10385.600	28.059	-83.380	-55.320	-30.320	-25.000	PEAK
6	* 12128.200	31.264	-83.370	-52.107	-27.107	-25.000	PEAK

Note:

1. All readings above 1GHz are performed with peak and/or average measurements as necessary.
2. Peak measurements: RBW = 1MHz, VBW = 1MHz, Sweep: Auto.
3. Average measurements: RBW = 1MHz, VBW = 10 Hz, Sweep: Auto.
4. “ * ”, means this data is the worst emission level.
5. Measurement Level = Reading Level + Correct Factor.
6. The average measurement was not performed when the peak measured data under the limit of average detection.
7. The Emission above 18GHz were not included is because their levels are too low.

Site : CB4-H	Time : 2017/02/20
Limit : FCC_Part27(outband)_00M_PK	Margin : 6
Probe : CB4-H_CE_Sub_B091_1-18GHz_3M_0117 - HORIZONTAL	Power : DC 3.8V
EUT : LE910C1-NA	Note : Mode 2: WCDMA Band 4_Idle mode_1752.6MHz

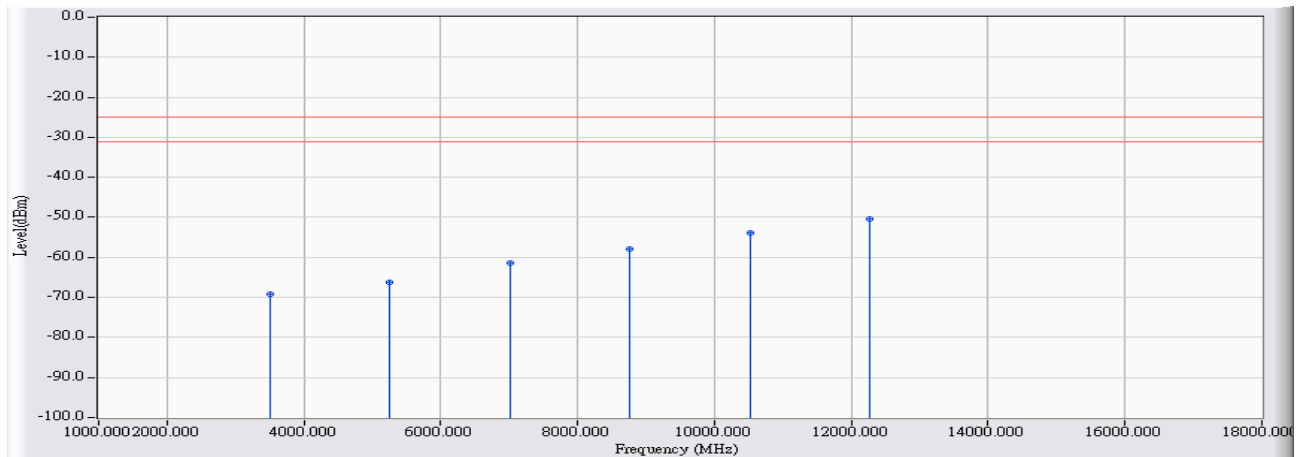

	Frequency (MHz)	Correct Factor (dB)	Reading Level (dBm)	Measure Level (dBm)	Margin (dB)	Limit (dBm)	Detector Type
1	3505.200	5.943	-74.980	-69.037	-44.037	-25.000	PEAK
2	5257.800	11.116	-77.410	-66.294	-41.294	-25.000	PEAK
3	7010.400	18.426	-79.860	-61.434	-36.434	-25.000	PEAK
4	8763.000	23.816	-81.610	-57.794	-32.794	-25.000	PEAK
5	10515.600	28.802	-82.810	-54.008	-29.008	-25.000	PEAK
6	* 12268.200	31.845	-82.310	-50.464	-25.464	-25.000	PEAK

Note:

1. All readings above 1GHz are performed with peak and/or average measurements as necessary.
2. Peak measurements: RBW = 1MHz, VBW = 1MHz, Sweep: Auto.
3. Average measurements: RBW = 1MHz, VBW = 10 Hz, Sweep: Auto.
4. “ * ”, means this data is the worst emission level.
5. Measurement Level = Reading Level + Correct Factor.
6. The average measurement was not performed when the peak measured data under the limit of average detection.
7. The Emission above 18GHz were not included is because their levels are too low.

Site : CB4-H	Time : 2017/02/20
Limit : FCC_Part27(outband)_00M_PK	Margin : 6
Probe : CB4-H_CE_Sub_B091_1-18GHz_3M_0117 - VERTICAL	Power : DC 3.8V
EUT : LE910C1-NA	Note : Mode 2: WCDMA Band 4_Idle mode_1752.6MHz

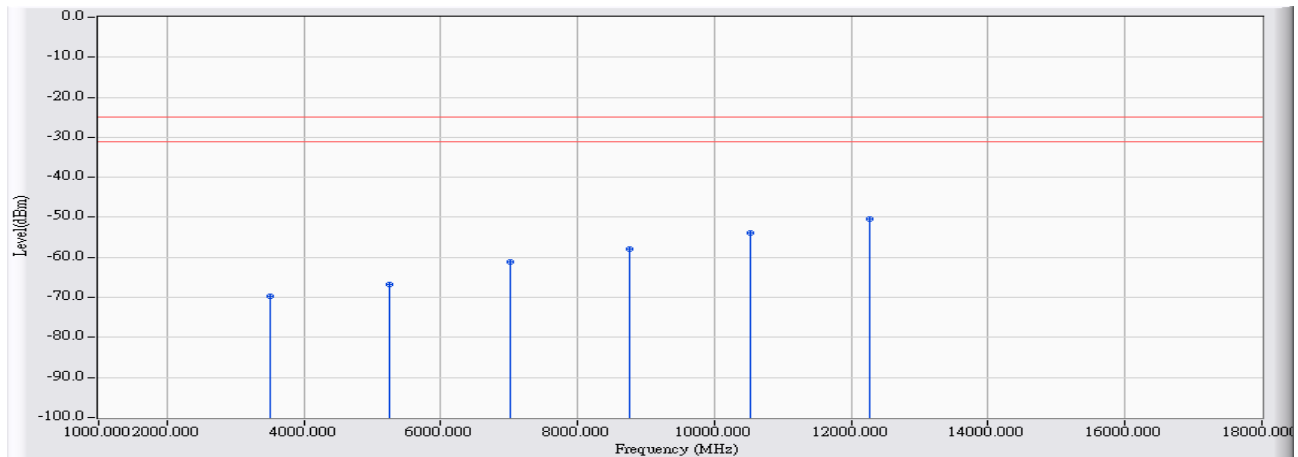

	Frequency (MHz)	Correct Factor (dB)	Reading Level (dBm)	Measure Level (dBm)	Margin (dB)	Limit (dBm)	Detector Type
1	3505.200	5.659	-75.280	-69.621	-44.621	-25.000	PEAK
2	5257.800	11.257	-78.000	-66.743	-41.743	-25.000	PEAK
3	7010.400	18.563	-79.630	-61.067	-36.067	-25.000	PEAK
4	8763.000	23.687	-81.500	-57.813	-32.813	-25.000	PEAK
5	10515.600	28.483	-82.390	-53.907	-28.907	-25.000	PEAK
6	* 12268.200	31.784	-82.140	-50.355	-25.355	-25.000	PEAK

Note:

1. All readings above 1GHz are performed with peak and/or average measurements as necessary.
2. Peak measurements: RBW = 1MHz, VBW = 1MHz, Sweep: Auto.
3. Average measurements: RBW = 1MHz, VBW = 10 Hz, Sweep: Auto.
4. “ * ”, means this data is the worst emission level.
5. Measurement Level = Reading Level + Correct Factor.
6. The average measurement was not performed when the peak measured data under the limit of average detection.
7. The Emission above 18GHz were not included is because their levels are too low.

Site : CB4-H	Time : 2017/02/23
Limit : FCC_Part27(outband)_00M_PK	Margin : 6
Probe : CB4-H_CE_Sub_B433_1-18GHz_3M_0217 - HORIZONTAL	Power : DC 3.8V
EUT : LE910C1-NA	Note : Mode 3: WCDMA Band 4_HSUPA Mode_Link_1712.4

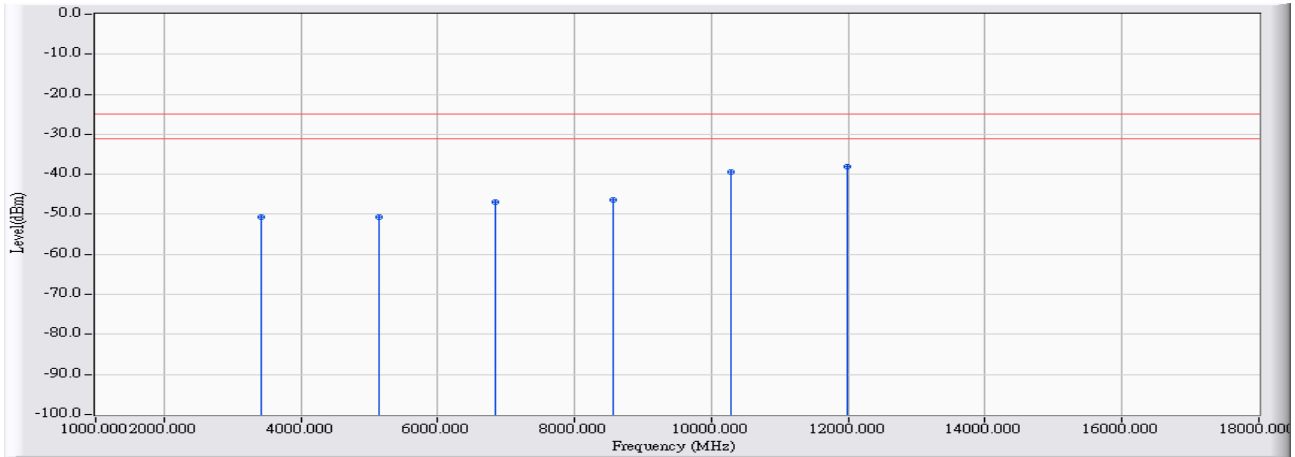

	Frequency (MHz)	Correct Factor (dB)	Reading Level (dBm)	Measure Level (dBm)	Margin (dB)	Limit (dBm)	Detector Type
1	3424.800	11.879	-62.680	-50.801	-25.801	-25.000	PEAK
2	5137.200	15.425	-66.060	-50.636	-25.636	-25.000	PEAK
3	6849.600	20.741	-67.760	-47.019	-22.019	-25.000	PEAK
4	8562.000	24.940	-71.350	-46.410	-21.410	-25.000	PEAK
5	10274.400	30.957	-70.380	-39.423	-14.423	-25.000	PEAK
6	* 11986.800	32.801	-70.920	-38.118	-13.118	-25.000	PEAK

Note:

1. All readings above 1GHz are performed with peak and/or average measurements as necessary.
2. Peak measurements: RBW = 1MHz, VBW = 1MHz, Sweep: Auto.
3. Average measurements: RBW = 1MHz, VBW = 10 Hz, Sweep: Auto.
4. “ * ”, means this data is the worst emission level.
5. Measurement Level = Reading Level + Correct Factor.
6. The average measurement was not performed when the peak measured data under the limit of average detection.
7. The Emission above 18GHz were not included is because their levels are too low.

Site : CB4-H	Time : 2017/02/23
Limit : FCC_Part27(outband)_00M_PK	Margin : 6
Probe : CB4-H_CE_Sub_B433_1-18GHz_3M_0217 - VERTICAL	Power : DC 3.8V
EUT : LE910C1-NA	Note : Mode 3: WCDMA Band 4_HSUPA Mode_Link _1712.4

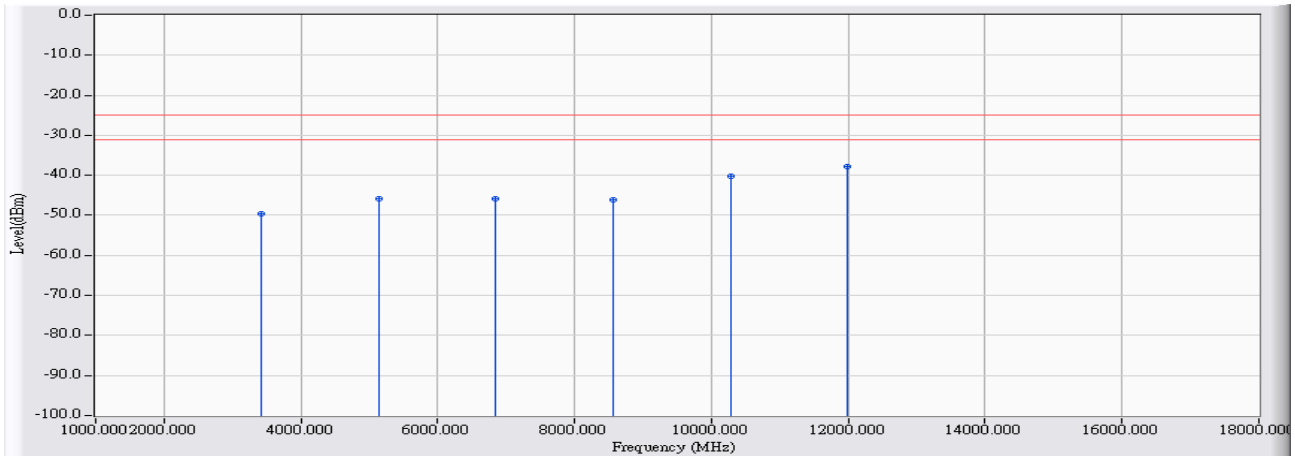

	Frequency (MHz)	Correct Factor (dB)	Reading Level (dBm)	Measure Level (dBm)	Margin (dB)	Limit (dBm)	Detector Type
1	3424.800	11.838	-61.530	-49.691	-24.691	-25.000	PEAK
2	5137.200	15.428	-61.210	-45.783	-20.783	-25.000	PEAK
3	6849.600	20.733	-66.550	-45.817	-20.817	-25.000	PEAK
4	8562.000	24.452	-70.590	-46.138	-21.138	-25.000	PEAK
5	10274.400	30.230	-70.530	-40.299	-15.299	-25.000	PEAK
6	* 11986.800	33.073	-70.910	-37.836	-12.836	-25.000	PEAK

Note:

1. All readings above 1GHz are performed with peak and/or average measurements as necessary.
2. Peak measurements: RBW = 1MHz, VBW = 1MHz, Sweep: Auto.
3. Average measurements: RBW = 1MHz, VBW = 10 Hz, Sweep: Auto.
4. “ * ”, means this data is the worst emission level.
5. Measurement Level = Reading Level + Correct Factor.
6. The average measurement was not performed when the peak measured data under the limit of average detection.
7. The Emission above 18GHz were not included is because their levels are too low.

Site : CB4-H	Time : 2017/02/23
Limit : FCC_Part27(outband)_00M_PK	Margin : 6
Probe : CB4-H_CE_Sub_B433_1-18GHz_3M_0217 - HORIZONTAL	Power : DC 3.8V
EUT : LE910C1-NA	Note : Mode 3: WCDMA Band 4_HSUPA Mode_Link _1732.6

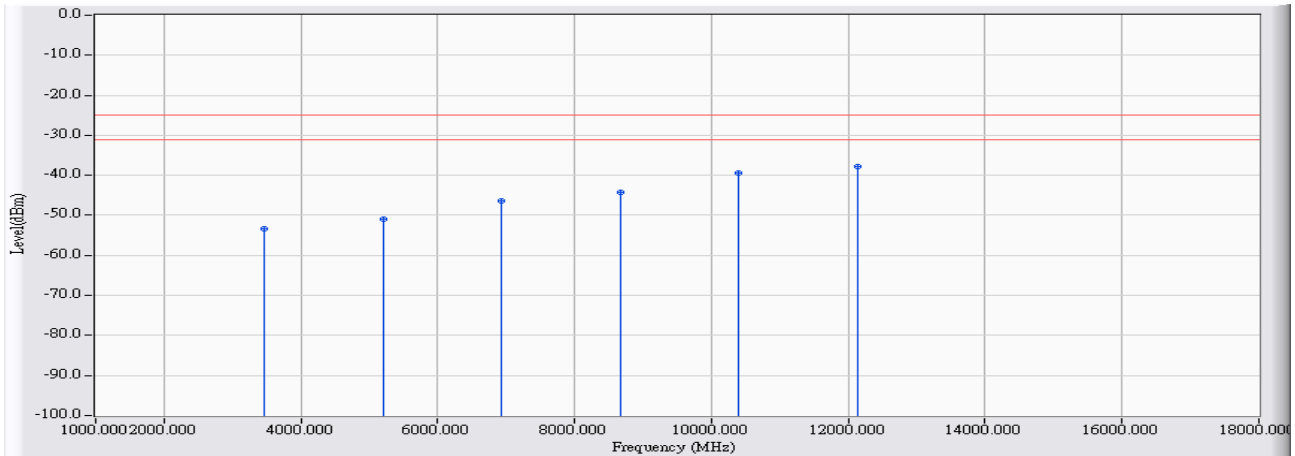

	Frequency (MHz)	Correct Factor (dB)	Reading Level (dBm)	Measure Level (dBm)	Margin (dB)	Limit (dBm)	Detector Type
1	3465.200	11.970	-65.210	-53.241	-28.241	-25.000	PEAK
2	5197.800	15.316	-66.240	-50.925	-25.925	-25.000	PEAK
3	6930.400	21.240	-67.610	-46.370	-21.370	-25.000	PEAK
4	8663.000	25.782	-70.130	-44.348	-19.348	-25.000	PEAK
5	10395.600	31.712	-71.080	-39.368	-14.368	-25.000	PEAK
6	* 12128.200	33.210	-70.940	-37.729	-12.729	-25.000	PEAK

Note:

1. All readings above 1GHz are performed with peak and/or average measurements as necessary.
2. Peak measurements: RBW = 1MHz, VBW = 1MHz, Sweep: Auto.
3. Average measurements: RBW = 1MHz, VBW = 10 Hz, Sweep: Auto.
4. “ * ”, means this data is the worst emission level.
5. Measurement Level = Reading Level + Correct Factor.
6. The average measurement was not performed when the peak measured data under the limit of average detection.
7. The Emission above 18GHz were not included is because their levels are too low.

Site : CB4-H	Time : 2017/02/23
Limit : FCC_Part27(outband)_00M_PK	Margin : 6
Probe : CB4-H_CE_Sub_B433_1-18GHz_3M_0217 - VERTICAL	Power : DC 3.8V
EUT : LE910C1-NA	Note : Mode 3: WCDMA Band 4_HSUPA Mode_Link _1732.6

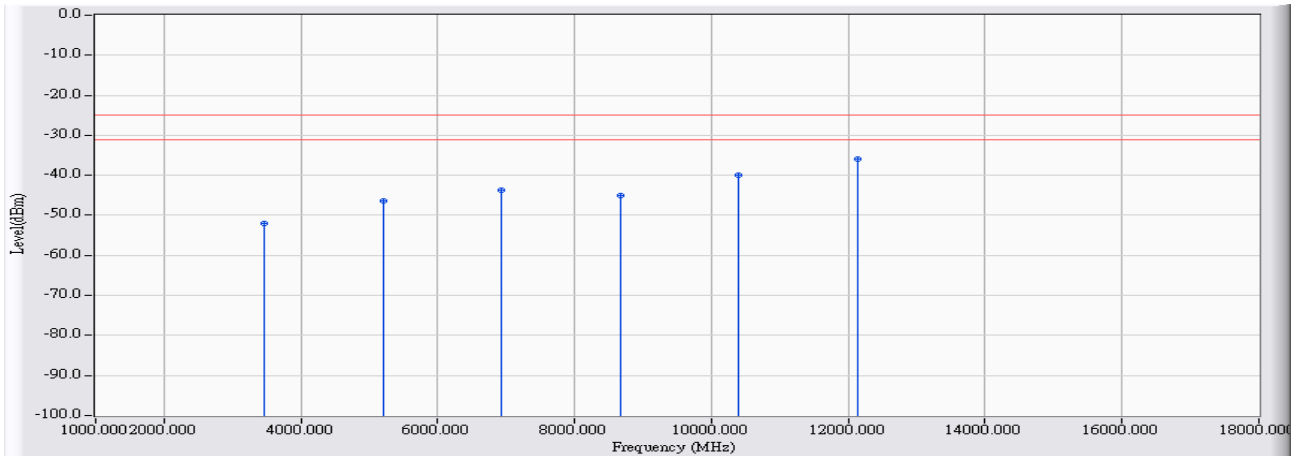

	Frequency (MHz)	Correct Factor (dB)	Reading Level (dBm)	Measure Level (dBm)	Margin (dB)	Limit (dBm)	Detector Type
1	3465.200	11.892	-63.850	-51.959	-26.959	-25.000	PEAK
2	5197.800	15.258	-61.710	-46.453	-21.453	-25.000	PEAK
3	6930.400	21.161	-64.850	-43.689	-18.689	-25.000	PEAK
4	8663.000	25.400	-70.320	-44.920	-19.920	-25.000	PEAK
5	10395.600	31.150	-71.030	-39.880	-14.880	-25.000	PEAK
6	* 12128.200	33.480	-69.530	-36.049	-11.049	-25.000	PEAK

Note:

1. All readings above 1GHz are performed with peak and/or average measurements as necessary.
2. Peak measurements: RBW = 1MHz, VBW = 1MHz, Sweep: Auto.
3. Average measurements: RBW = 1MHz, VBW = 10 Hz, Sweep: Auto.
4. “ * ”, means this data is the worst emission level.
5. Measurement Level = Reading Level + Correct Factor.
6. The average measurement was not performed when the peak measured data under the limit of average detection.
7. The Emission above 18GHz were not included is because their levels are too low.

Site : CB4-H	Time : 2017/02/23 - 14:34
Limit : FCC_Part27(outband)_00M_PK	Margin : 6
Probe : CB4-H_CE_Sub_B433_1-18GHz_3M_0217 - HORIZONTAL	Power : DC 3.8V
EUT : LE910C1-NA	Note : Mode 3: WCDMA Band 4_HSUPA Mode_Link_1752.6

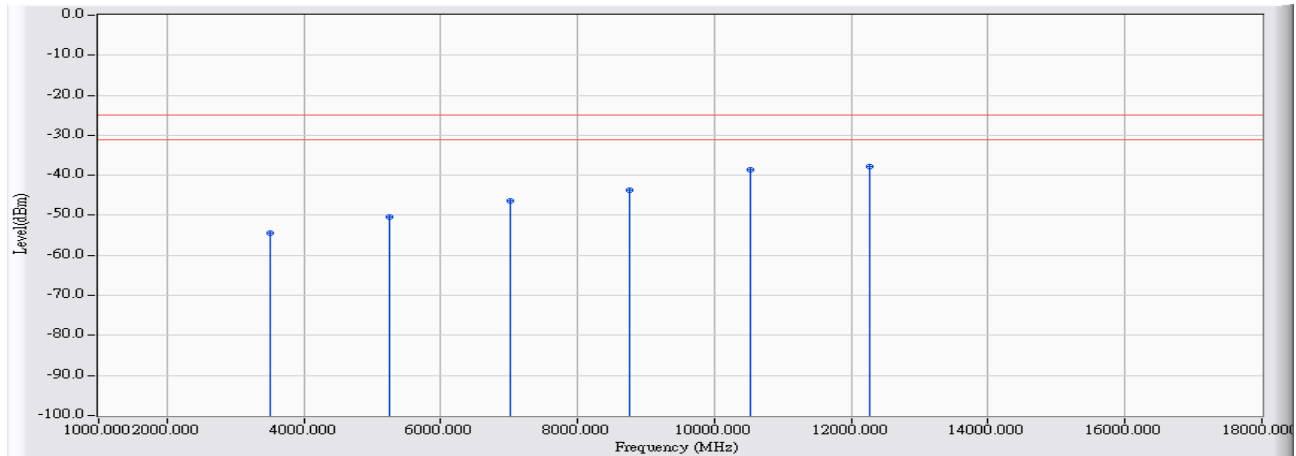

	Frequency (MHz)	Correct Factor (dB)	Reading Level (dBm)	Measure Level (dBm)	Margin (dB)	Limit (dBm)	Detector Type
1	3505.200	12.051	-66.420	-54.369	-29.369	-25.000	PEAK
2	5257.800	15.256	-65.780	-50.524	-25.524	-25.000	PEAK
3	7010.400	21.752	-68.110	-46.357	-21.357	-25.000	PEAK
4	8763.000	26.132	-69.840	-43.709	-18.709	-25.000	PEAK
5	10515.600	32.685	-71.340	-38.655	-13.655	-25.000	PEAK
6	* 12268.200	33.586	-71.310	-37.724	-12.724	-25.000	PEAK

Note:

1. All readings above 1GHz are performed with peak and/or average measurements as necessary.
2. Peak measurements: RBW = 1MHz, VBW = 1MHz, Sweep: Auto.
3. Average measurements: RBW = 1MHz, VBW = 10 Hz, Sweep: Auto.
4. “ * ”, means this data is the worst emission level.
5. Measurement Level = Reading Level + Correct Factor.
6. The average measurement was not performed when the peak measured data under the limit of average detection.
7. The Emission above 18GHz were not included is because their levels are too low.

Site : CB4-H	Time : 2017/02/23
Limit : FCC_Part27(outband)_00M_PK	Margin : 6
Probe : CB4-H_CE_Sub_B433_1-18GHz_3M_0217 - VERTICAL	Power : DC 3.8V
EUT : LE910C1-NA	Note : Mode 3: WCDMA Band 4_HSUPA Mode_Link _1752.6

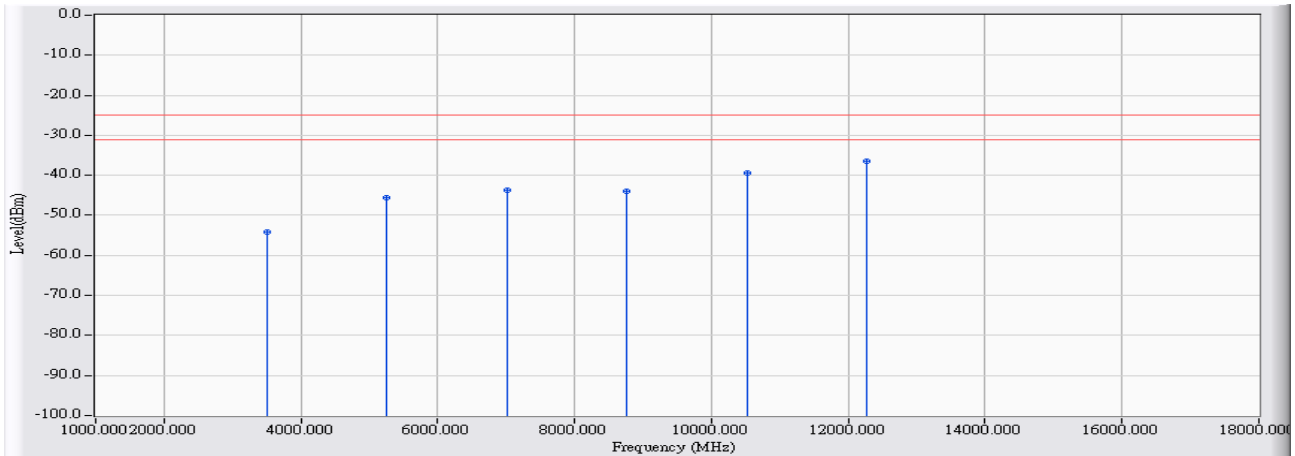

	Frequency (MHz)	Correct Factor (dB)	Reading Level (dBm)	Measure Level (dBm)	Margin (dB)	Limit (dBm)	Detector Type
1	3505.200	11.943	-66.110	-54.167	-29.167	-25.000	PEAK
2	5257.800	15.154	-60.860	-45.707	-20.707	-25.000	PEAK
3	7010.400	21.618	-65.360	-43.741	-18.741	-25.000	PEAK
4	8763.000	26.261	-70.160	-43.900	-18.900	-25.000	PEAK
5	10515.600	31.982	-71.410	-39.428	-14.428	-25.000	PEAK
6	* 12268.200	33.875	-70.430	-36.555	-11.555	-25.000	PEAK

Note:

1. All readings above 1GHz are performed with peak and/or average measurements as necessary.
2. Peak measurements: RBW = 1MHz, VBW = 1MHz, Sweep: Auto.
3. Average measurements: RBW = 1MHz, VBW = 10 Hz, Sweep: Auto.
4. “ * ”, means this data is the worst emission level.
5. Measurement Level = Reading Level + Correct Factor.
6. The average measurement was not performed when the peak measured data under the limit of average detection.
7. The Emission above 18GHz were not included is because their levels are too low.

Site : CB4-H	Time : 2017/02/23
Limit : FCC_Part27(outband)_00M_PK	Margin : 6
Probe : CB4-H_CE_Sub_B433_1-18GHz_3M_0217 - HORIZONTAL	Power : DC 3.8V
EUT : LE910C1-NA	Note : Mode 3: WCDMA Band 4_HSUPA Mode_Idle _1712.4

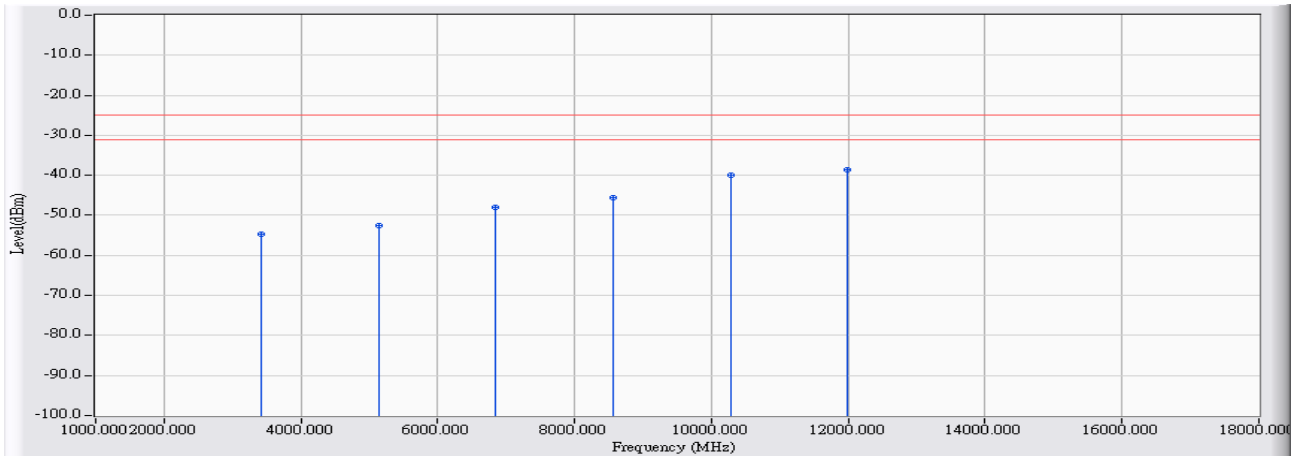

	Frequency (MHz)	Correct Factor (dB)	Reading Level (dBm)	Measure Level (dBm)	Margin (dB)	Limit (dBm)	Detector Type
1	3424.800	11.879	-66.700	-54.821	-29.821	-25.000	PEAK
2	5137.200	15.425	-67.850	-52.426	-27.426	-25.000	PEAK
3	6849.600	20.741	-68.610	-47.869	-22.869	-25.000	PEAK
4	8562.000	24.940	-70.650	-45.710	-20.710	-25.000	PEAK
5	10274.400	30.957	-70.770	-39.813	-14.813	-25.000	PEAK
6	* 11986.800	32.801	-71.290	-38.488	-13.488	-25.000	PEAK

Note:

1. All readings above 1GHz are performed with peak and/or average measurements as necessary.
2. Peak measurements: RBW = 1MHz, VBW = 1MHz, Sweep: Auto.
3. Average measurements: RBW = 1MHz, VBW = 10 Hz, Sweep: Auto.
4. “ * ”, means this data is the worst emission level.
5. Measurement Level = Reading Level + Correct Factor.
6. The average measurement was not performed when the peak measured data under the limit of average detection.
7. The Emission above 18GHz were not included is because their levels are too low.

Site : CB4-H	Time : 2017/02/23
Limit : FCC_Part27(outband)_00M_PK	Margin : 6
Probe : CB4-H_CE_Sub_B433_1-18GHz_3M_0217 - VERTICAL	Power : DC 3.8V
EUT : LE910C1-NA	Note : Mode 3: WCDMA Band 4_HSUPA Mode_Idle _1712.4

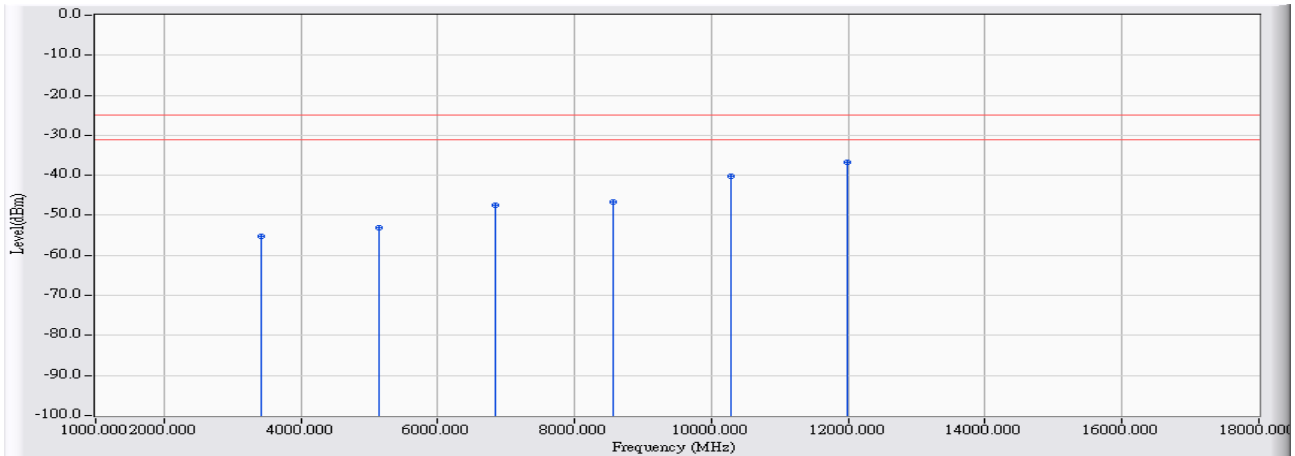

	Frequency (MHz)	Correct Factor (dB)	Reading Level (dBm)	Measure Level (dBm)	Margin (dB)	Limit (dBm)	Detector Type
1	3424.800	11.838	-67.140	-55.301	-30.301	-25.000	PEAK
2	5137.200	15.428	-68.420	-52.993	-27.993	-25.000	PEAK
3	6849.600	20.733	-68.160	-47.427	-22.427	-25.000	PEAK
4	8562.000	24.452	-71.030	-46.578	-21.578	-25.000	PEAK
5	10274.400	30.230	-70.540	-40.309	-15.309	-25.000	PEAK
6	* 11986.800	33.073	-69.920	-36.846	-11.846	-25.000	PEAK

Note:

1. All readings above 1GHz are performed with peak and/or average measurements as necessary.
2. Peak measurements: RBW = 1MHz, VBW = 1MHz, Sweep: Auto.
3. Average measurements: RBW = 1MHz, VBW = 10 Hz, Sweep: Auto.
4. “ * ”, means this data is the worst emission level.
5. Measurement Level = Reading Level + Correct Factor.
6. The average measurement was not performed when the peak measured data under the limit of average detection.
7. The Emission above 18GHz were not included is because their levels are too low.

Site : CB4-H	Time : 2017/02/23
Limit : FCC_Part27(outband)_00M_PK	Margin : 6
Probe : CB4-H_CE_Sub_B433_1-18GHz_3M_0217 - HORIZONTAL	Power : DC 3.8V
EUT : LE910C1-NA	Note : Mode 3: WCDMA Band 4_HSUPA Mode_Idle _1732.6

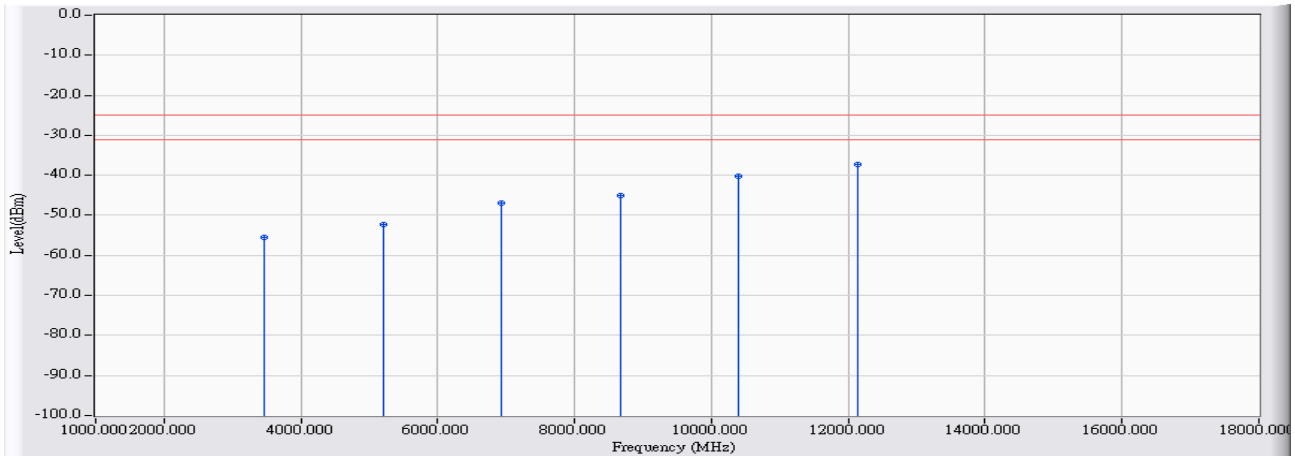

	Frequency (MHz)	Correct Factor (dB)	Reading Level (dBm)	Measure Level (dBm)	Margin (dB)	Limit (dBm)	Detector Type
1	3465.200	11.970	-67.460	-55.491	-30.491	-25.000	PEAK
2	5197.800	15.316	-67.660	-52.345	-27.345	-25.000	PEAK
3	6930.400	21.240	-68.290	-47.050	-22.050	-25.000	PEAK
4	8663.000	25.782	-70.870	-45.088	-20.088	-25.000	PEAK
5	10395.600	31.712	-71.960	-40.248	-15.248	-25.000	PEAK
6	* 12128.200	33.210	-70.520	-37.309	-12.309	-25.000	PEAK

Note:

1. All readings above 1GHz are performed with peak and/or average measurements as necessary.
2. Peak measurements: RBW = 1MHz, VBW = 1MHz, Sweep: Auto.
3. Average measurements: RBW = 1MHz, VBW = 10 Hz, Sweep: Auto.
4. “ * ”, means this data is the worst emission level.
5. Measurement Level = Reading Level + Correct Factor.
6. The average measurement was not performed when the peak measured data under the limit of average detection.
7. The Emission above 18GHz were not included is because their levels are too low.

Site : CB4-H	Time : 2017/02/23
Limit : FCC_Part27(outband)_00M_PK	Margin : 6
Probe : CB4-H_CE_Sub_B433_1-18GHz_3M_0217 - VERTICAL	Power : DC 3.8V
EUT : LE910C1-NA	Note : Mode 3: WCDMA Band 4_HSUPA Mode_Idle _1732.6

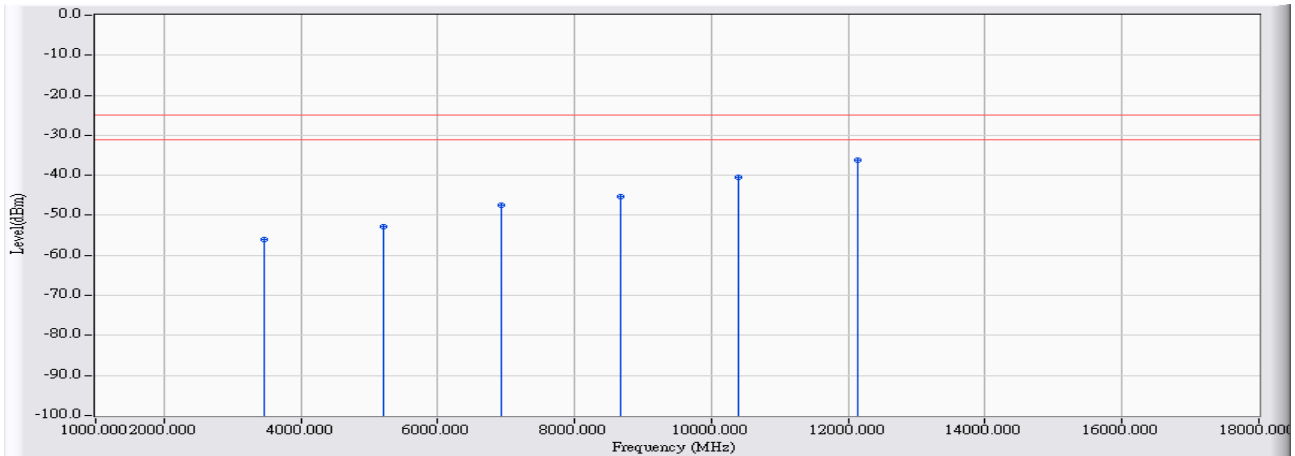

	Frequency (MHz)	Correct Factor (dB)	Reading Level (dBm)	Measure Level (dBm)	Margin (dB)	Limit (dBm)	Detector Type
1	3465.200	11.892	-67.910	-56.019	-31.019	-25.000	PEAK
2	5197.800	15.258	-68.170	-52.913	-27.913	-25.000	PEAK
3	6930.400	21.161	-68.610	-47.449	-22.449	-25.000	PEAK
4	8663.000	25.400	-70.770	-45.370	-20.370	-25.000	PEAK
5	10395.600	31.150	-71.720	-40.570	-15.570	-25.000	PEAK
6	* 12128.200	33.480	-69.760	-36.279	-11.279	-25.000	PEAK

Note:

1. All readings above 1GHz are performed with peak and/or average measurements as necessary.
2. Peak measurements: RBW = 1MHz, VBW = 1MHz, Sweep: Auto.
3. Average measurements: RBW = 1MHz, VBW = 10 Hz, Sweep: Auto.
4. “ * ”, means this data is the worst emission level.
5. Measurement Level = Reading Level + Correct Factor.
6. The average measurement was not performed when the peak measured data under the limit of average detection.
7. The Emission above 18GHz were not included is because their levels are too low.

Site : CB4-H	Time : 2017/02/23
Limit : FCC_Part27(outband)_00M_PK	Margin : 6
Probe : CB4-H_CE_Sub_B433_1-18GHz_3M_0217 - HORIZONTAL	Power : DC 3.8V
EUT : LE910C1-NA	Note : Mode 3: WCDMA Band 4_HSUPA Mode_Idle _1752.6

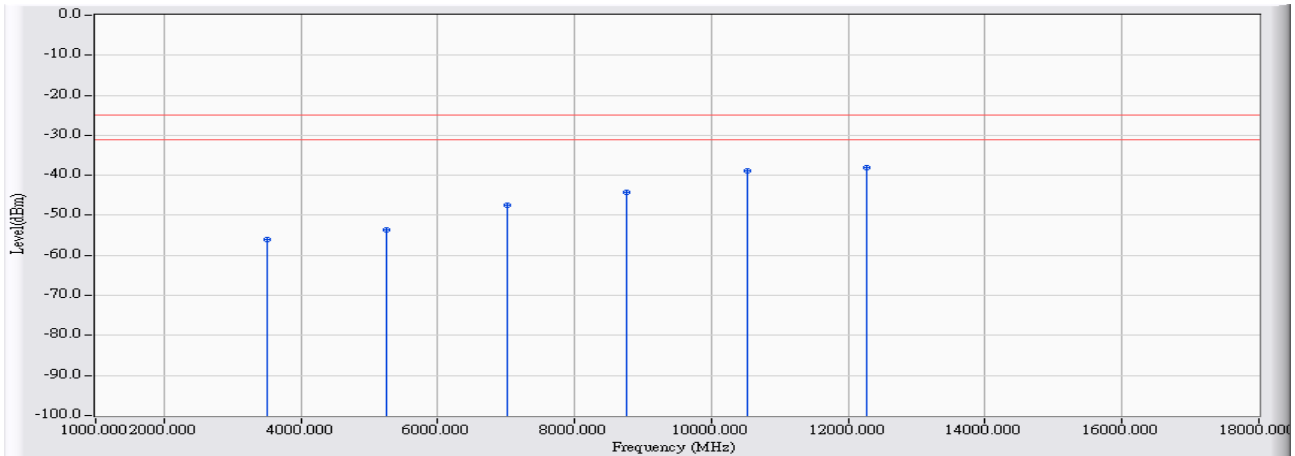

	Frequency (MHz)	Correct Factor (dB)	Reading Level (dBm)	Measure Level (dBm)	Margin (dB)	Limit (dBm)	Detector Type
1	3505.200	12.051	-68.120	-56.069	-31.069	-25.000	PEAK
2	5257.800	15.256	-68.800	-53.544	-28.544	-25.000	PEAK
3	7010.400	21.752	-69.220	-47.467	-22.467	-25.000	PEAK
4	8763.000	26.132	-70.370	-44.239	-19.239	-25.000	PEAK
5	10515.600	32.685	-71.530	-38.845	-13.845	-25.000	PEAK
6	* 12268.200	33.586	-71.620	-38.034	-13.034	-25.000	PEAK

Note:

1. All readings above 1GHz are performed with peak and/or average measurements as necessary.
2. Peak measurements: RBW = 1MHz, VBW = 1MHz, Sweep: Auto.
3. Average measurements: RBW = 1MHz, VBW = 10 Hz, Sweep: Auto.
4. “ * ”, means this data is the worst emission level.
5. Measurement Level = Reading Level + Correct Factor.
6. The average measurement was not performed when the peak measured data under the limit of average detection.
7. The Emission above 18GHz were not included is because their levels are too low.

Site : CB4-H	Time : 2017/02/23
Limit : FCC_Part27(outband)_00M_PK	Margin : 6
Probe : CB4-H_CE_Sub_B433_1-18GHz_3M_0217 - VERTICAL	Power : DC 3.8V
EUT : LE910C1-NA	Note : Mode 3: WCDMA Band 4_HSUPA Mode_Idle _1752.6

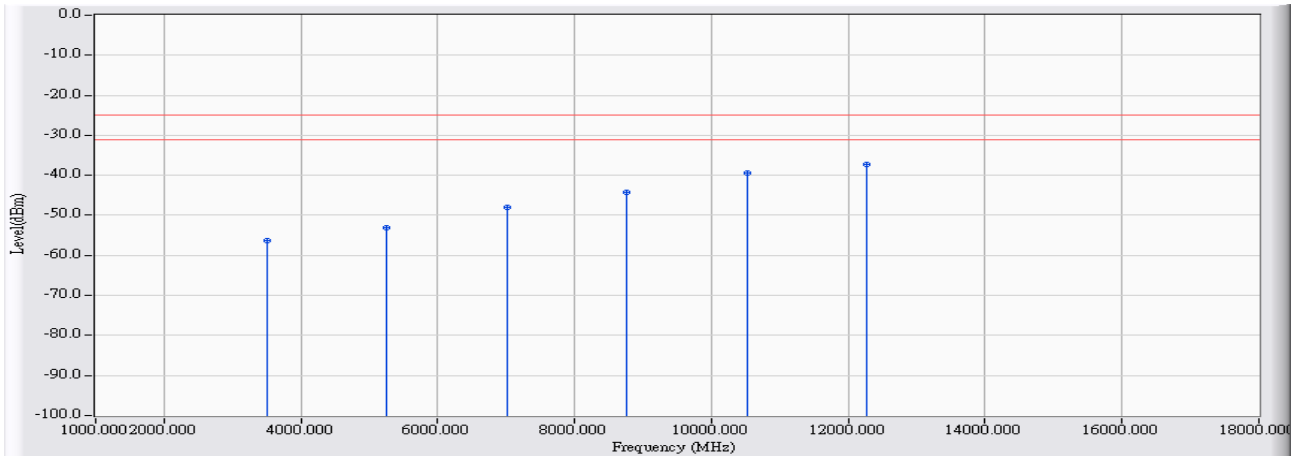

	Frequency (MHz)	Correct Factor (dB)	Reading Level (dBm)	Measure Level (dBm)	Margin (dB)	Limit (dBm)	Detector Type
1	3505.200	11.943	-68.360	-56.417	-31.417	-25.000	PEAK
2	5257.800	15.154	-68.160	-53.007	-28.007	-25.000	PEAK
3	7010.400	21.618	-69.640	-48.021	-23.021	-25.000	PEAK
4	8763.000	26.261	-70.500	-44.240	-19.240	-25.000	PEAK
5	10515.600	31.982	-71.330	-39.348	-14.348	-25.000	PEAK
6	* 12268.200	33.875	-71.210	-37.335	-12.335	-25.000	PEAK

Note:

1. All readings above 1GHz are performed with peak and/or average measurements as necessary.
2. Peak measurements: RBW = 1MHz, VBW = 1MHz, Sweep: Auto.
3. Average measurements: RBW = 1MHz, VBW = 10 Hz, Sweep: Auto.
4. “ * ”, means this data is the worst emission level.
5. Measurement Level = Reading Level + Correct Factor.
6. The average measurement was not performed when the peak measured data under the limit of average detection.
7. The Emission above 18GHz were not included is because their levels are too low.

Site : CB4-H	Time : 2017/02/23
Limit : FCC_Part27(outband)_00M_PK	Margin : 6
Probe : CB4-H_CE_Sub_B433_1-18GHz_3M_0217 - HORIZONTAL	Power : DC 3.8V
EUT : LE910C1-NA	Note : Mode 4: WCDMA Band 4_HSDPA Mode_Link_1712.4

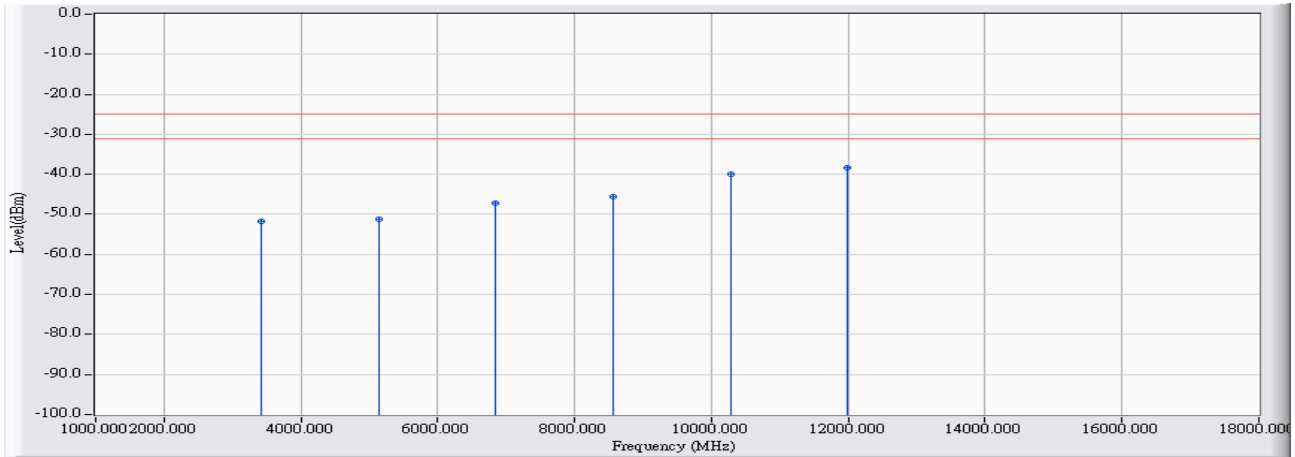

	Frequency (MHz)	Correct Factor (dB)	Reading Level (dBm)	Measure Level (dBm)	Margin (dB)	Limit (dBm)	Detector Type
1	3424.800	11.879	-63.490	-51.611	-26.611	-25.000	PEAK
2	5137.200	15.425	-66.590	-51.166	-26.166	-25.000	PEAK
3	6849.600	20.741	-67.810	-47.069	-22.069	-25.000	PEAK
4	8562.000	24.940	-70.540	-45.600	-20.600	-25.000	PEAK
5	10274.400	30.957	-70.950	-39.993	-14.993	-25.000	PEAK
6	* 11986.800	32.801	-71.160	-38.358	-13.358	-25.000	PEAK

Note:

1. All readings above 1GHz are performed with peak and/or average measurements as necessary.
2. Peak measurements: RBW = 1MHz, VBW = 1MHz, Sweep: Auto.
3. Average measurements: RBW = 1MHz, VBW = 10 Hz, Sweep: Auto.
4. “ * ”, means this data is the worst emission level.
5. Measurement Level = Reading Level + Correct Factor.
6. The average measurement was not performed when the peak measured data under the limit of average detection.
7. The Emission above 18GHz were not included is because their levels are too low.

Site : CB4-H	Time : 2017/02/23
Limit : FCC_Part27(outband)_00M_PK	Margin : 6
Probe : CB4-H_CE_Sub_B433_1-18GHz_3M_0217 - VERTICAL	Power : DC 3.8V
EUT : LE910C1-NA	Note : Mode 4: WCDMA Band 4_HSDPA Mode_Link _1712.4

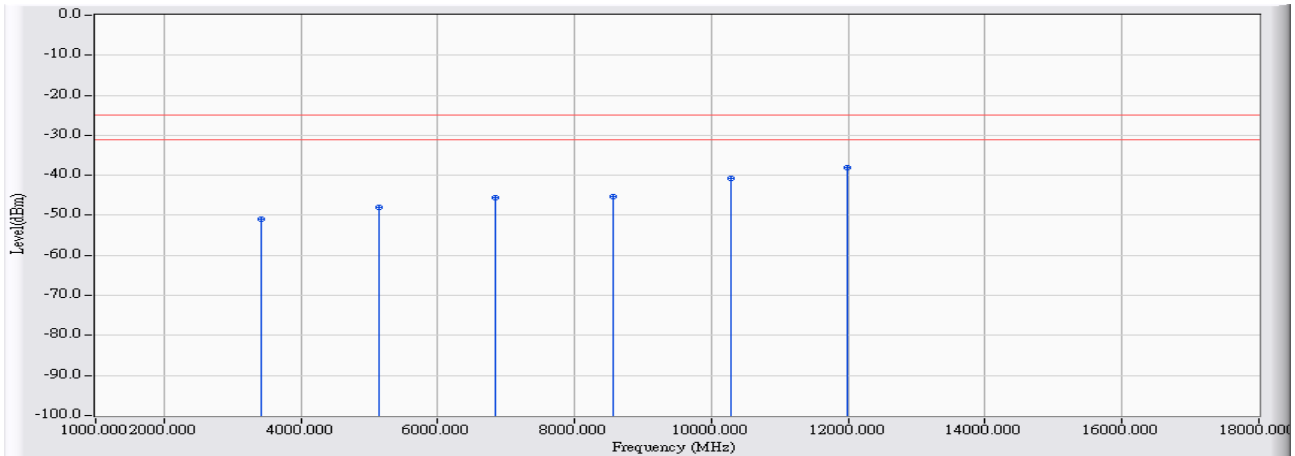

	Frequency (MHz)	Correct Factor (dB)	Reading Level (dBm)	Measure Level (dBm)	Margin (dB)	Limit (dBm)	Detector Type
1	3424.800	11.838	-62.840	-51.001	-26.001	-25.000	PEAK
2	5137.200	15.428	-63.290	-47.863	-22.863	-25.000	PEAK
3	6849.600	20.733	-66.420	-45.687	-20.687	-25.000	PEAK
4	8562.000	24.452	-69.810	-45.358	-20.358	-25.000	PEAK
5	10274.400	30.230	-71.020	-40.789	-15.789	-25.000	PEAK
6	* 11986.800	33.073	-71.230	-38.156	-13.156	-25.000	PEAK

Note:

1. All readings above 1GHz are performed with peak and/or average measurements as necessary.
2. Peak measurements: RBW = 1MHz, VBW = 1MHz, Sweep: Auto.
3. Average measurements: RBW = 1MHz, VBW = 10 Hz, Sweep: Auto.
4. “ * ”, means this data is the worst emission level.
5. Measurement Level = Reading Level + Correct Factor.
6. The average measurement was not performed when the peak measured data under the limit of average detection.
7. The Emission above 18GHz were not included is because their levels are too low.

Site : CB4-H	Time : 2017/02/23
Limit : FCC_Part27(outband)_00M_PK	Margin : 6
Probe : CB4-H_CE_Sub_B433_1-18GHz_3M_0217 - HORIZONTAL	Power : DC 3.8V
EUT : LE910C1-NA	Note : Mode 4: WCDMA Band 4_HSDPA Mode_Link _1732.6

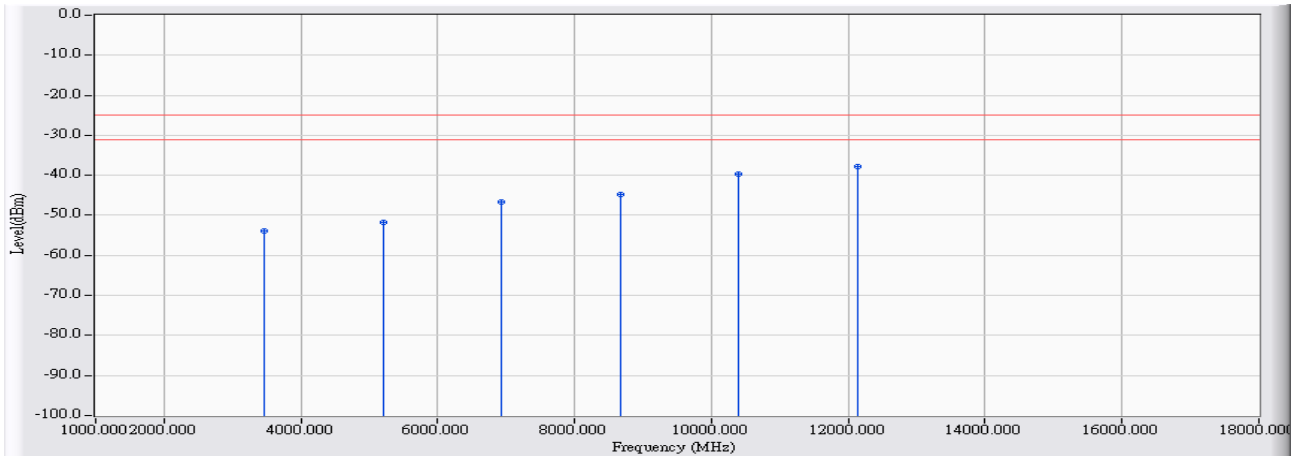

	Frequency (MHz)	Correct Factor (dB)	Reading Level (dBm)	Measure Level (dBm)	Margin (dB)	Limit (dBm)	Detector Type
1	3465.200	11.970	-65.800	-53.831	-28.831	-25.000	PEAK
2	5197.800	15.316	-67.140	-51.825	-26.825	-25.000	PEAK
3	6930.400	21.240	-67.900	-46.660	-21.660	-25.000	PEAK
4	8663.000	25.782	-70.620	-44.838	-19.838	-25.000	PEAK
5	10395.600	31.712	-71.510	-39.798	-14.798	-25.000	PEAK
6	* 12128.200	33.210	-70.950	-37.739	-12.739	-25.000	PEAK

Note:

1. All readings above 1GHz are performed with peak and/or average measurements as necessary.
2. Peak measurements: RBW = 1MHz, VBW = 1MHz, Sweep: Auto.
3. Average measurements: RBW = 1MHz, VBW = 10 Hz, Sweep: Auto.
4. “ * ”, means this data is the worst emission level.
5. Measurement Level = Reading Level + Correct Factor.
6. The average measurement was not performed when the peak measured data under the limit of average detection.
7. The Emission above 18GHz were not included is because their levels are too low.

Site : CB4-H	Time : 2017/02/23
Limit : FCC_Part27(outband)_00M_PK	Margin : 6
Probe : CB4-H_CE_Sub_B433_1-18GHz_3M_0217 - VERTICAL	Power : DC 3.8V
EUT : LE910C1-NA	Note : Mode 4: WCDMA Band 4_HSDPA Mode_Link _1732.6

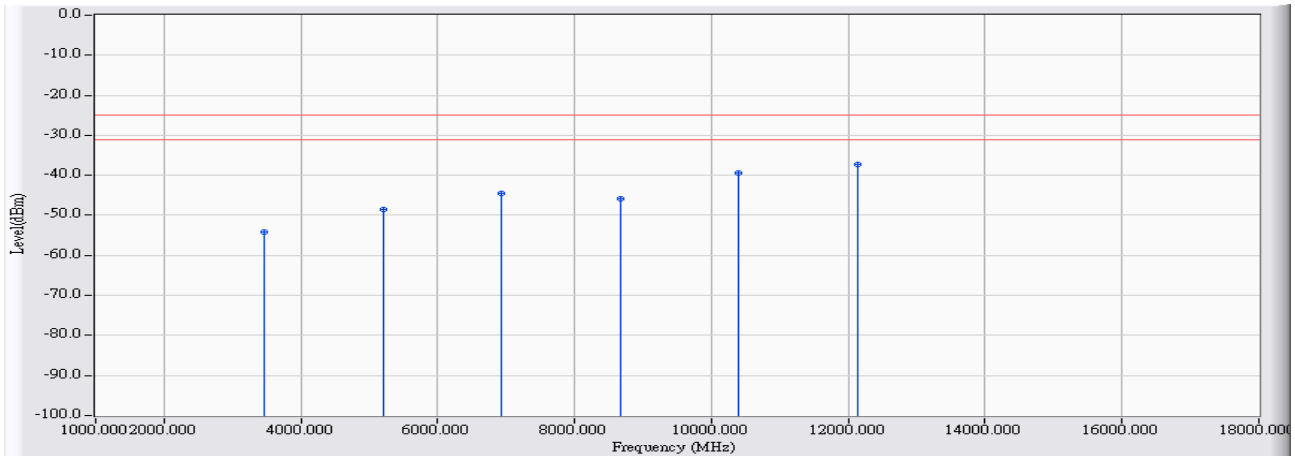

	Frequency (MHz)	Correct Factor (dB)	Reading Level (dBm)	Measure Level (dBm)	Margin (dB)	Limit (dBm)	Detector Type
1	3465.200	11.892	-66.060	-54.169	-29.169	-25.000	PEAK
2	5197.800	15.258	-63.650	-48.393	-23.393	-25.000	PEAK
3	6930.400	21.161	-65.640	-44.479	-19.479	-25.000	PEAK
4	8663.000	25.400	-71.280	-45.880	-20.880	-25.000	PEAK
5	10395.600	31.150	-70.540	-39.390	-14.390	-25.000	PEAK
6	* 12128.200	33.480	-70.650	-37.169	-12.169	-25.000	PEAK

Note:

1. All readings above 1GHz are performed with peak and/or average measurements as necessary.
2. Peak measurements: RBW = 1MHz, VBW = 1MHz, Sweep: Auto.
3. Average measurements: RBW = 1MHz, VBW = 10 Hz, Sweep: Auto.
4. “ * ”, means this data is the worst emission level.
5. Measurement Level = Reading Level + Correct Factor.
6. The average measurement was not performed when the peak measured data under the limit of average detection.
7. The Emission above 18GHz were not included is because their levels are too low.

Site : CB4-H	Time : 2017/02/23
Limit : FCC_Part27(outband)_00M_PK	Margin : 6
Probe : CB4-H_CE_Sub_B433_1-18GHz_3M_0217 - HORIZONTAL	Power : DC 3.8V
EUT : LE910C1-NA	Note : Mode 4: WCDMA Band 4_HSDPA Mode_Link_1752.6

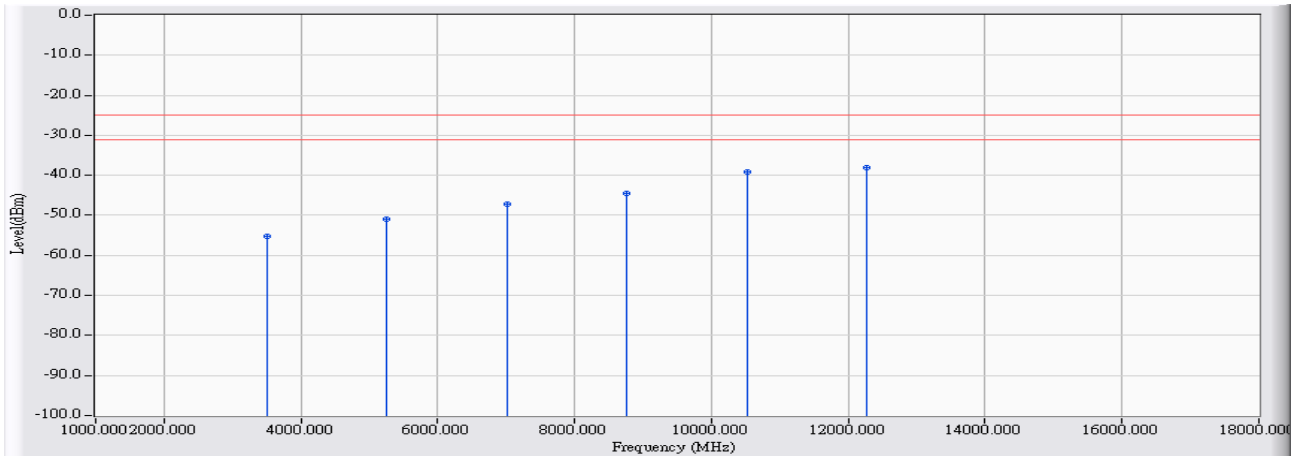

	Frequency (MHz)	Correct Factor (dB)	Reading Level (dBm)	Measure Level (dBm)	Margin (dB)	Limit (dBm)	Detector Type
1	3505.200	12.051	-67.180	-55.129	-30.129	-25.000	PEAK
2	5257.800	15.256	-66.120	-50.864	-25.864	-25.000	PEAK
3	7010.400	21.752	-69.020	-47.267	-22.267	-25.000	PEAK
4	8763.000	26.132	-70.670	-44.539	-19.539	-25.000	PEAK
5	10515.600	32.685	-71.820	-39.135	-14.135	-25.000	PEAK
6	* 12268.200	33.586	-71.530	-37.944	-12.944	-25.000	PEAK

Note:

1. All readings above 1GHz are performed with peak and/or average measurements as necessary.
2. Peak measurements: RBW = 1MHz, VBW = 1MHz, Sweep: Auto.
3. Average measurements: RBW = 1MHz, VBW = 10 Hz, Sweep: Auto.
4. “ * ”, means this data is the worst emission level.
5. Measurement Level = Reading Level + Correct Factor.
6. The average measurement was not performed when the peak measured data under the limit of average detection.
7. The Emission above 18GHz were not included is because their levels are too low.

Site : CB4-H	Time : 2017/02/23
Limit : FCC_Part27(outband)_00M_PK	Margin : 6
Probe : CB4-H_CE_Sub_B433_1-18GHz_3M_0217 - VERTICAL	Power : DC 3.8V
EUT : LE910C1-NA	Note : Mode 4: WCDMA Band 4_HSDPA Mode_Link _1752.6

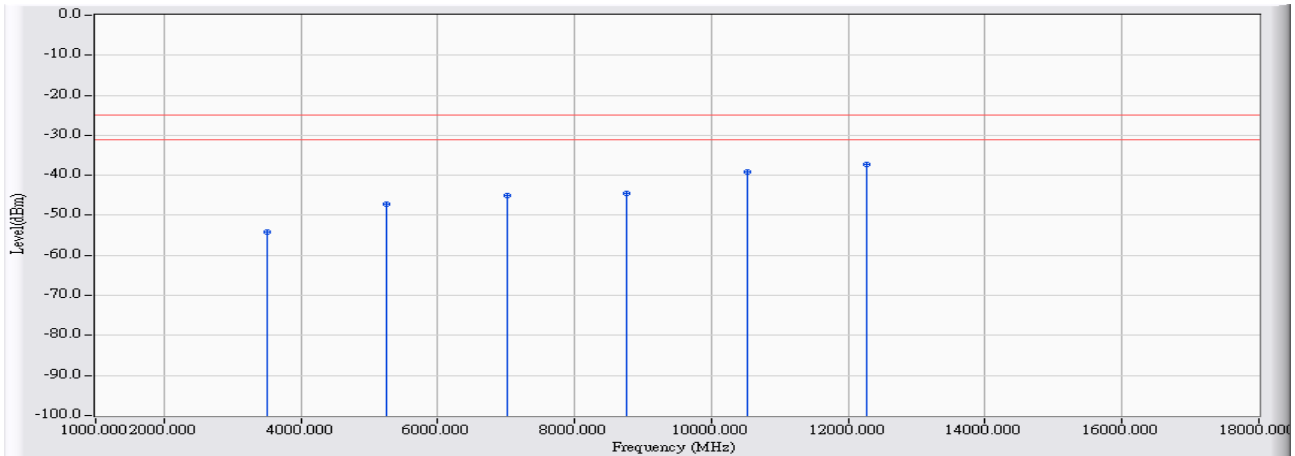

	Frequency (MHz)	Correct Factor (dB)	Reading Level (dBm)	Measure Level (dBm)	Margin (dB)	Limit (dBm)	Detector Type
1	3505.200	11.943	-66.110	-54.167	-29.167	-25.000	PEAK
2	5257.800	15.154	-62.340	-47.187	-22.187	-25.000	PEAK
3	7010.400	21.618	-66.710	-45.091	-20.091	-25.000	PEAK
4	8763.000	26.261	-70.680	-44.420	-19.420	-25.000	PEAK
5	10515.600	31.982	-71.130	-39.148	-14.148	-25.000	PEAK
6	* 12268.200	33.875	-71.240	-37.365	-12.365	-25.000	PEAK

Note:

1. All readings above 1GHz are performed with peak and/or average measurements as necessary.
2. Peak measurements: RBW = 1MHz, VBW = 1MHz, Sweep: Auto.
3. Average measurements: RBW = 1MHz, VBW = 10 Hz, Sweep: Auto.
4. “ * ”, means this data is the worst emission level.
5. Measurement Level = Reading Level + Correct Factor.
6. The average measurement was not performed when the peak measured data under the limit of average detection.
7. The Emission above 18GHz were not included is because their levels are too low.

Site : CB4-H	Time : 2017/02/23
Limit : FCC_Part27(outband)_00M_PK	Margin : 6
Probe : CB4-H_CE_Sub_B433_1-18GHz_3M_0217 - HORIZONTAL	Power : DC 3.8V
EUT : LE910C1-NA	Note : Mode 4: WCDMA Band 4_HSDPA Mode_Idle _1712.4

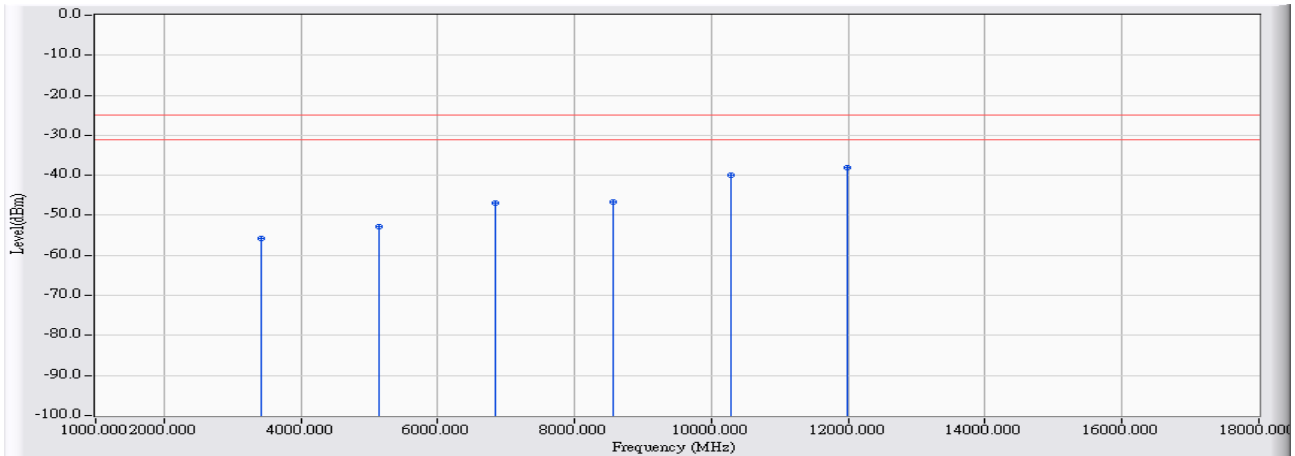

	Frequency (MHz)	Correct Factor (dB)	Reading Level (dBm)	Measure Level (dBm)	Margin (dB)	Limit (dBm)	Detector Type
1	3424.800	11.879	-67.510	-55.631	-30.631	-25.000	PEAK
2	5137.200	15.425	-68.290	-52.866	-27.866	-25.000	PEAK
3	6849.600	20.741	-67.720	-46.979	-21.979	-25.000	PEAK
4	8562.000	24.940	-71.630	-46.690	-21.690	-25.000	PEAK
5	10274.400	30.957	-70.860	-39.903	-14.903	-25.000	PEAK
6	* 11986.800	32.801	-70.840	-38.038	-13.038	-25.000	PEAK

Note:

1. All readings above 1GHz are performed with peak and/or average measurements as necessary.
2. Peak measurements: RBW = 1MHz, VBW = 1MHz, Sweep: Auto.
3. Average measurements: RBW = 1MHz, VBW = 10 Hz, Sweep: Auto.
4. “ * ”, means this data is the worst emission level.
5. Measurement Level = Reading Level + Correct Factor.
6. The average measurement was not performed when the peak measured data under the limit of average detection.
7. The Emission above 18GHz were not included is because their levels are too low.

Site : CB4-H	Time : 2017/02/23
Limit : FCC_Part27(outband)_00M_PK	Margin : 6
Probe : CB4-H_CE_Sub_B433_1-18GHz_3M_0217 - VERTICAL	Power : DC 3.8V
EUT : LE910C1-NA	Note : Mode 4: WCDMA Band 4_HSDPA Mode_Idle _1712.4

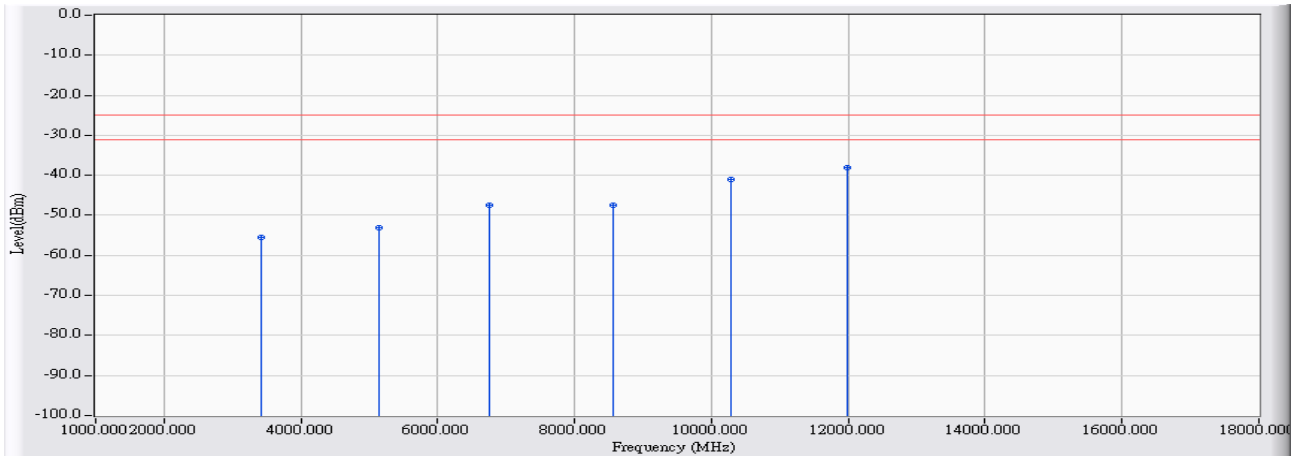

	Frequency (MHz)	Correct Factor (dB)	Reading Level (dBm)	Measure Level (dBm)	Margin (dB)	Limit (dBm)	Detector Type
1	3424.800	11.838	-67.450	-55.611	-30.611	-25.000	PEAK
2	5137.200	15.428	-68.480	-53.053	-28.053	-25.000	PEAK
3	6749.600	20.222	-67.800	-47.578	-22.578	-25.000	PEAK
4	8562.000	24.452	-72.030	-47.578	-22.578	-25.000	PEAK
5	10274.400	30.230	-71.260	-41.029	-16.029	-25.000	PEAK
6	* 11986.800	33.073	-71.210	-38.136	-13.136	-25.000	PEAK

Note:

1. All readings above 1GHz are performed with peak and/or average measurements as necessary.
2. Peak measurements: RBW = 1MHz, VBW = 1MHz, Sweep: Auto.
3. Average measurements: RBW = 1MHz, VBW = 10 Hz, Sweep: Auto.
4. “ * ”, means this data is the worst emission level.
5. Measurement Level = Reading Level + Correct Factor.
6. The average measurement was not performed when the peak measured data under the limit of average detection.
7. The Emission above 18GHz were not included is because their levels are too low.

Site : CB4-H	Time : 2017/02/23
Limit : FCC_Part27(outband)_00M_PK	Margin : 6
Probe : CB4-H_CE_Sub_B433_1-18GHz_3M_0217 - HORIZONTAL	Power : DC 3.8V
EUT : LE910C1-NA	Note : Mode 4: WCDMA Band 4_HSDPA Mode_Idle _1732.6

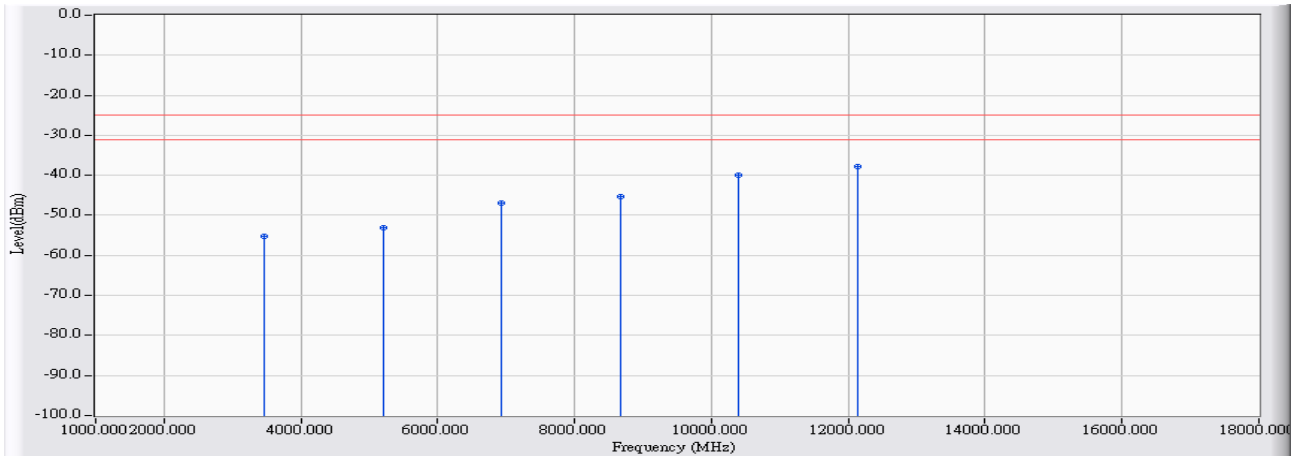

	Frequency (MHz)	Correct Factor (dB)	Reading Level (dBm)	Measure Level (dBm)	Margin (dB)	Limit (dBm)	Detector Type
1	3465.200	11.970	-67.230	-55.261	-30.261	-25.000	PEAK
2	5197.800	15.316	-68.520	-53.205	-28.205	-25.000	PEAK
3	6930.400	21.240	-68.210	-46.970	-21.970	-25.000	PEAK
4	8663.000	25.782	-71.050	-45.268	-20.268	-25.000	PEAK
5	10395.600	31.712	-71.540	-39.828	-14.828	-25.000	PEAK
6	* 12128.200	33.210	-70.990	-37.779	-12.779	-25.000	PEAK

Note:

1. All readings above 1GHz are performed with peak and/or average measurements as necessary.
2. Peak measurements: RBW = 1MHz, VBW = 1MHz, Sweep: Auto.
3. Average measurements: RBW = 1MHz, VBW = 10 Hz, Sweep: Auto.
4. “ * ”, means this data is the worst emission level.
5. Measurement Level = Reading Level + Correct Factor.
6. The average measurement was not performed when the peak measured data under the limit of average detection.
7. The Emission above 18GHz were not included is because their levels are too low.

Site : CB4-H	Time : 2017/02/23
Limit : FCC_Part27(outband)_00M_PK	Margin : 6
Probe : CB4-H_CE_Sub_B433_1-18GHz_3M_0217 - VERTICAL	Power : DC 3.8V
EUT : LE910C1-NA	Note : Mode 4: WCDMA Band 4_HSDPA Mode_Idle _1732.6

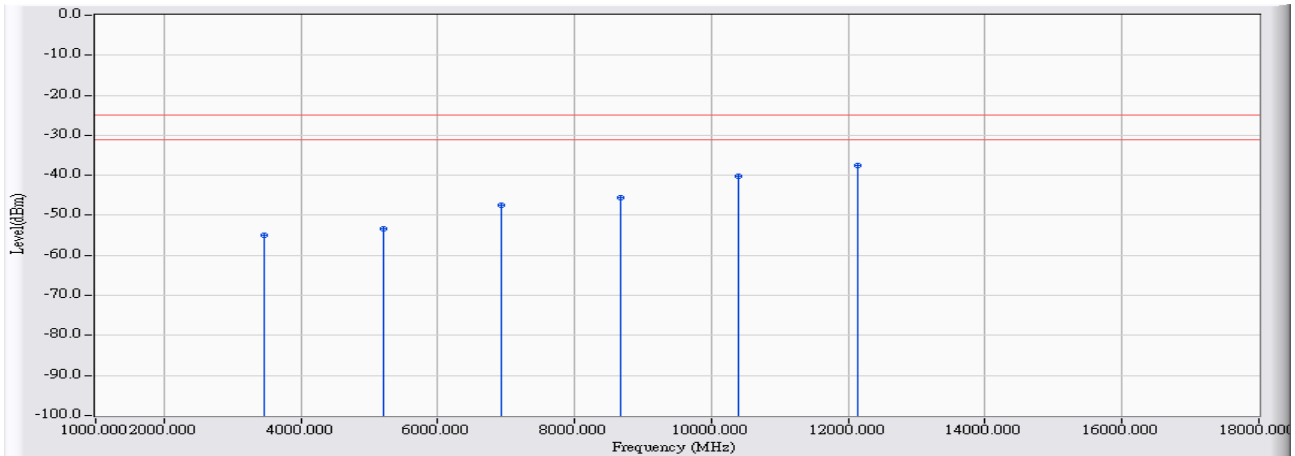

	Frequency (MHz)	Correct Factor (dB)	Reading Level (dBm)	Measure Level (dBm)	Margin (dB)	Limit (dBm)	Detector Type
1	3465.200	11.892	-66.800	-54.909	-29.909	-25.000	PEAK
2	5197.800	15.258	-68.560	-53.303	-28.303	-25.000	PEAK
3	6930.400	21.161	-68.520	-47.359	-22.359	-25.000	PEAK
4	8663.000	25.400	-70.860	-45.460	-20.460	-25.000	PEAK
5	10395.600	31.150	-71.400	-40.250	-15.250	-25.000	PEAK
6	* 12128.200	33.480	-70.990	-37.509	-12.509	-25.000	PEAK

Note:

1. All readings above 1GHz are performed with peak and/or average measurements as necessary.
2. Peak measurements: RBW = 1MHz, VBW = 1MHz, Sweep: Auto.
3. Average measurements: RBW = 1MHz, VBW = 10 Hz, Sweep: Auto.
4. “ * ”, means this data is the worst emission level.
5. Measurement Level = Reading Level + Correct Factor.
6. The average measurement was not performed when the peak measured data under the limit of average detection.
7. The Emission above 18GHz were not included is because their levels are too low.

Site : CB4-H	Time : 2017/02/23
Limit : FCC_Part27(outband)_00M_PK	Margin : 6
Probe : CB4-H_CE_Sub_B433_1-18GHz_3M_0217 - HORIZONTAL	Power : DC 3.8V
EUT : LE910C1-NA	Note : Mode 4: WCDMA Band 4_HSDPA Mode_Idle _1752.6

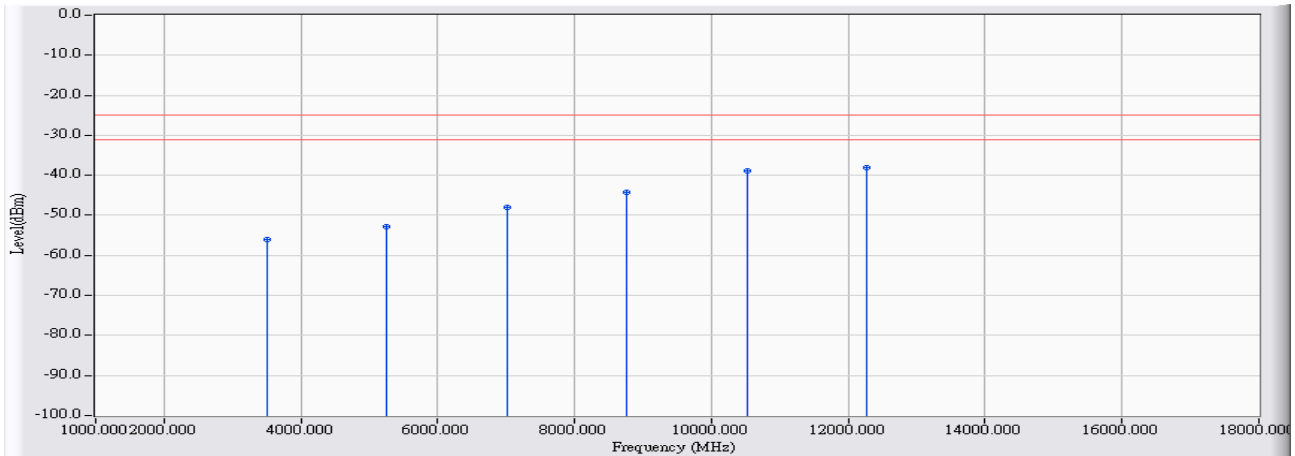

	Frequency (MHz)	Correct Factor (dB)	Reading Level (dBm)	Measure Level (dBm)	Margin (dB)	Limit (dBm)	Detector Type
1	3505.200	12.051	-67.950	-55.899	-30.899	-25.000	PEAK
2	5257.800	15.256	-67.940	-52.684	-27.684	-25.000	PEAK
3	7010.400	21.752	-69.780	-48.027	-23.027	-25.000	PEAK
4	8763.000	26.132	-70.340	-44.209	-19.209	-25.000	PEAK
5	10515.600	32.685	-71.550	-38.865	-13.865	-25.000	PEAK
6	* 12268.200	33.586	-71.630	-38.044	-13.044	-25.000	PEAK

Note:

1. All readings above 1GHz are performed with peak and/or average measurements as necessary.
2. Peak measurements: RBW = 1MHz, VBW = 1MHz, Sweep: Auto.
3. Average measurements: RBW = 1MHz, VBW = 10 Hz, Sweep: Auto.
4. “ * ”, means this data is the worst emission level.
5. Measurement Level = Reading Level + Correct Factor.
6. The average measurement was not performed when the peak measured data under the limit of average detection.
7. The Emission above 18GHz were not included is because their levels are too low.

Site : CB4-H	Time : 2017/02/23
Limit : FCC_Part27(outband)_00M_PK	Margin : 6
Probe : CB4-H_CE_Sub_B433_1-18GHz_3M_0217 - VERTICAL	Power : DC 3.8V
EUT : LE910C1-NA	Note : Mode 4: WCDMA Band 4_HSDPA Mode_Idle _1752.6

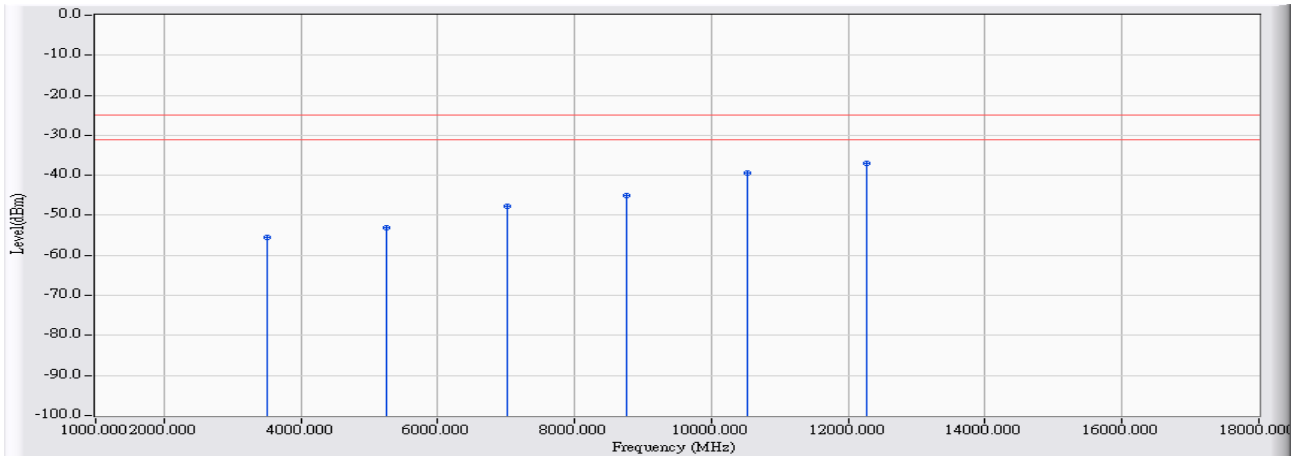

	Frequency (MHz)	Correct Factor (dB)	Reading Level (dBm)	Measure Level (dBm)	Margin (dB)	Limit (dBm)	Detector Type
1	3505.200	11.943	-67.440	-55.497	-30.497	-25.000	PEAK
2	5257.800	15.154	-68.280	-53.127	-28.127	-25.000	PEAK
3	7010.400	21.618	-69.420	-47.801	-22.801	-25.000	PEAK
4	8763.000	26.261	-71.280	-45.020	-20.020	-25.000	PEAK
5	10515.600	31.982	-71.330	-39.348	-14.348	-25.000	PEAK
6	* 12268.200	33.875	-70.740	-36.865	-11.865	-25.000	PEAK

Note:

1. All readings above 1GHz are performed with peak and/or average measurements as necessary.
2. Peak measurements: RBW = 1MHz, VBW = 1MHz, Sweep: Auto.
3. Average measurements: RBW = 1MHz, VBW = 10 Hz, Sweep: Auto.
4. “ * ”, means this data is the worst emission level.
5. Measurement Level = Reading Level + Correct Factor.
6. The average measurement was not performed when the peak measured data under the limit of average detection.
7. The Emission above 18GHz were not included is because their levels are too low.

8. Frequency Stability Over Temperatures Variation

8.1. Test Equipment

The following test equipments are used during the test:

Frequency Stability Over Temperatures Variation / SR10-H

Instrument	Manufacturer	Model No.	Serial No	Next Cal. Date
Signal & Spectrum Analyzer	R&S	FSV40	101049	2018/01/22
Temperature & Humidity Chamber	WIT	TH-1S-B	1082101	2018/01/18

Note: All equipments that need to calibrate are with calibration period of 1 year.

8.2. Test Setup

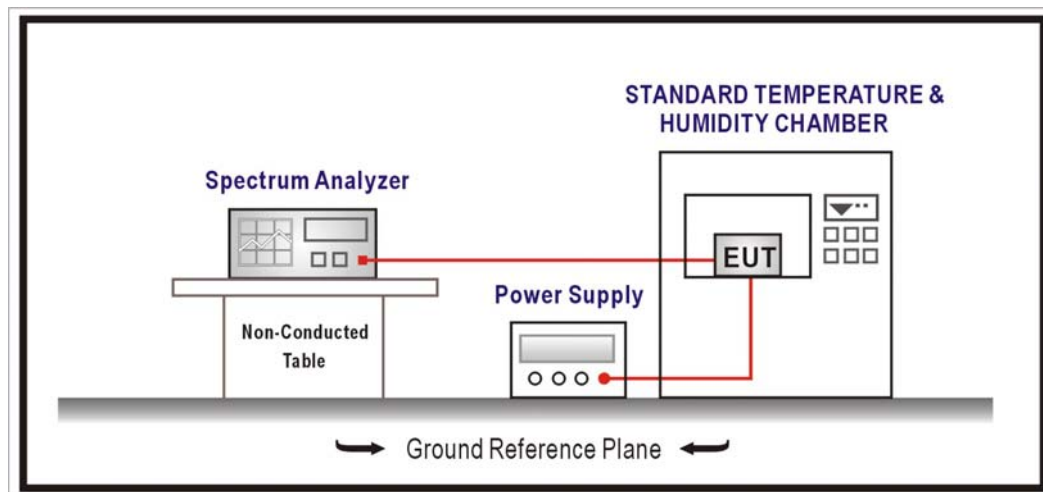

8.3. Limits

The frequency stability shall be measured with variation of ambient temperature as follows: From -30° to $+50^{\circ}$ centigrade for all equipment. Frequency measurements shall be made at the extremes of the specified temperature range and at intervals of not more than 10° centigrade through the range.

8.4. Test Procedure

Power must be turned off when changing from one temperature to another. Power warm up is at least 15 min and power applied should perform before recording frequency error. The temperature range step is 10 degrees in this test items. All temperature levels shall be holding the $\pm 0.5^{\circ}\text{C}$ during the measurement testing. The each temperature step shall be at least 0.5 hours, consider the EUT could be test under the stability condition.

8.5. Uncertainty

The measurement uncertainty is defined as $\pm 100\text{KHz}$

8.6. Test Result

Product	LE910C1-NA		
Test Item	Frequency Stability Over Temperatures Variation		
Test Mode	Mode 1: WCDMA Band 4_Link mode		
Date of Test	2017/02/07	Test Site	SR10-H

1712.4 MHz

Frequency Error Over Temperatures		
Temp. (°C)	Frequency (MHz)	Frequency Error (ppm)
-30	-25	0.0146
-20	-25	0.0144
-10	-26	0.0154
0	-19	0.0112
+10	-14	0.0083
+20	8	-0.0047
+30	7	-0.0043
+40	15	-0.0090
+50	17	-0.0101

1732.6 MHz

Frequency Error Over Temperatures		
Temp. (°C)	Frequency (MHz)	Frequency Error (ppm)
-30	6	-0.0032
-20	4	-0.0024
-10	5	-0.0027
0	-18	0.0104
+10	13	-0.0076
+20	4	-0.0023
+30	7	-0.0042
+40	-12	0.0069
+50	15	-0.0085

1752.6 MHz

Frequency Error Over Temperatures		
Temp. (°C)	Frequency (MHz)	Frequency Error (ppm)
-30	27	-0.0152
-20	27	-0.0154
-10	27	-0.0152
0	20	-0.0116
+10	18	-0.0100
+20	-5	0.0029
+30	-9	0.0053
+40	-12	0.0070
+50	-15	0.0087

9. Frequency Stability Over Voltage Variation

9.1. Test Equipment

The following test equipments are used during the test:

Frequency Stability Over Voltage Variation / SR10-H

Instrument	Manufacturer	Model No.	Serial No	Next Cal. Date
Signal & Spectrum Analyzer	R&S	FSV40	101049	2018/01/22
Temperature & Humidity Chamber	WIT	TH-1S-B	1082101	2018/01/18

Note: All equipments that need to calibrate are with calibration period of 1 year.

9.2. Test Setup

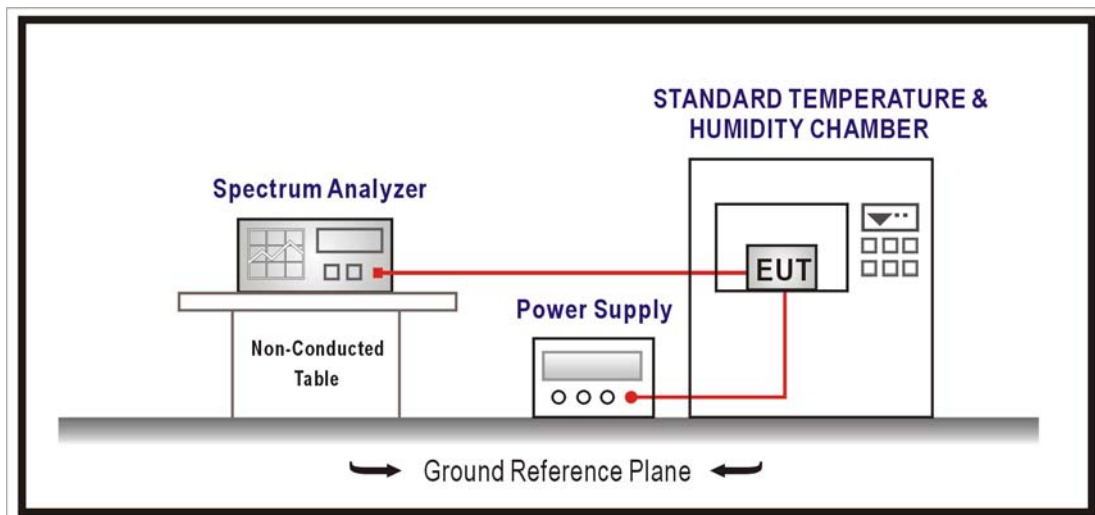

9.3. Limits

The frequency stability shall be measured with variation of primary supply voltage as follows:

- (1) Vary primary supply voltage from 85 to 115 percent of the nominal value for other than hand carried battery equipment.
- (2) For hand carried, battery powered equipment, reduce primary supply voltage to the battery operating end point which shall be specified by the manufacturer.
- (3) The supply voltage shall be measured at the input to the cable normally provided with the equipment, or at the power supply terminals if cables are not normally provided. Effects on frequency of transmitter keying (except for broadcast transmitters) and any heating element cycling at the nominal supply voltage and at each extreme also shall be shown.

9.4. Test Procedure

Power must be removed when changing from one voltage to another voltage. Power warm up is at least 15 min and power applied should perform before recording frequency error.

EUT is connected the external power supply to control the DC input power. The various Volts set from the minimum 4.5 Volts to 5.5 Volts. Each step shall be record the frequency error rate.

9.5. Uncertainty

The measurement uncertainty is defined as $\pm 100\text{KHz}$.

9.6. Test Result

Product	LE910C1-NA		
Test Item	Frequency Stability Over Voltage Variation		
Test Mode	Mode 1: WCDMA Band 4_Link mode		
Date of Test	2017/02/07	Test Site	SR10-H

1712.4 MHz

Frequency Error Over Voltage		
Voltage (Volts)	Frequency (MHz)	Frequency Error (ppm)
4.2	8	-0.0046
3.7	8	-0.0048
3.4	8	-0.0045

1732.6 MHz

Frequency Error Over Voltage		
Voltage (Volts)	Frequency (MHz)	Frequency Error (ppm)
4.2	-4	0.0022
3.7	4	-0.0025
3.4	-3	0.0020

1752.6 MHz

Frequency Error Over Voltage		
Voltage (Volts)	Frequency (MHz)	Frequency Error (ppm)
4.2	-6	0.0036
3.7	-5	0.0031
3.4	-5	0.0030