

FCC/IC Test Report

Product Name : LE910C1-NA
Trade Name : 
Model No. : LE910C1-NA
FCC ID. : RI7LE910C1NA
IC ID. : 5131A-LE910C1NA

Applicant : Telit Communications S.p.A.
Address : Viale Stazione di Prosecco, 5/B, 34010 Sgonico,
Trieste, Italy

Date of Receipt : Dec. 29, 2016
Issued Date : Feb. 24, 2017
Report No. : 1710065R-HPUSP49V00
Report Version : V1.0



The test results relate only to the samples tested.

The test report shall not be reproduced except in full without the written approval of DEKRA Testing and Certification Co., Ltd..

Test Report Certification

Issued Date: Feb. 24, 2017

Report No. : 1710065R-HPUSP49V00



Product Name : LE910C1-NA
 Applicant : Telit Communications S.p.A.
 Address : Viale Stazione di Prosecco, 5/B, 34010 Sgonico, Trieste, Italy
 Manufacturer : Telit Wireless Solutions Ltd.
 Model No. : LE910C1-NA
 FCC ID. : RI7LE910C1NA
 IC ID. : 5131A-LE910C1NA
 EUT Voltage : DC 3.8V
 Testing Voltage : DC 3.8V
 Trade Name : 
 Applicable Standard : FCC CFR Title 47 Part 2
 FCC CFR Title 47 Part 22 Subpart H
 FCC CFR Title 47 Part 24 Subpart E
 ANSI/TIA-603-D-2010
 RSS GEN Issue 4
 RSS 132 Issue 3
 RSS 133 Issue 6
 Test Lab : Hsin Chu Laboratory
 Test Result : Complied

The test results relate only to the samples tested.

The test report shall not be reproduced except in full without the written approval of DEKRA Testing and Certification Co., Ltd..

Documented By : 

 (Lyla Yang / Engineering Adm. Assistant)

Tested By : 

 (JuBo Shen / Senior Engineer)

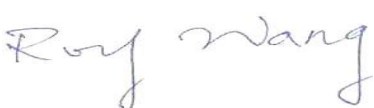
Approved By : 

 (Roy Wang / Director)

Laboratory Information

We, **DEKRA Testing and Certification Co., Ltd.**, are an independent RF consultancy that was established the whole facility in our laboratories. The test facility has been accredited/accepted (audited or listed) by the following related bodies in compliance with ISO 17025 specified testing scopes:

Taiwan R.O.C.	: TAF, Accreditation Number: 3024
USA	: FCC, Registration Number: 834100
Canada	: IC, Submission No: 181665 IC Registration Number: 22397-1 / 22397-2

The related certificate for our laboratories about the test site and management system can be downloaded from DEKRA Testing and Certification Co., Ltd. Web Site:

<http://www.dekra.com.tw/english/about/certificates.aspx?bval=5>

The address and introduction of DEKRA Testing and Certification Co., Ltd. laboratories can be founded in our Web site : http://www.dekra.com.tw/index_en.aspx

If you have any comments, Please don't hesitate to contact us. Our contact information is as below:

Hsin Chu Laboratory :

No. 75-2, 3rd Lin, WangYe Keng, Yonghxing Tsuen, Qionglin Shiang, Hsinchu County 307, Taiwan (R.O.C.)
TEL:+886-3-592-8858 / FAX:+886-3-592-8859 E-Mail : info.tw@dekra.com
No.372, Sec. 4, Zhongxing Rd., Zhudong Township, Hsinchu County 31061, Taiwan
No.372-2, Sec. 4, Zhongxing Rd., Zhudong Township, Hsinchu County 31061, Taiwan
TEL: +886-3-582-8001 / FAX: +886-3-582-8958 E-Mail : info.tw@dekra.com

Lin Kou Laboratory :

No. 5-22, Ruishukeng, Linkou Dist., New Taipei City 24451, Taiwan (R.O.C.)
TEL : +886-2-8601-3788 / FAX : +886-2-8601-3789 E-Mail : info.tw@dekra.com

TABLE OF CONTENTS

Description	Page
1. General Information.....	7
1.1. EUT Description	7
1.2. Mode of Operation.....	8
1.3. Tested System Details	9
1.4. Configuration of Tested System	10
1.5. EUT Exercise Software	10
2. Technical Test	11
2.1. Summary of Test Result.....	11
2.2. Test Environment	11
3. Peak Output Power	12
3.1. Test Equipment	12
3.2. Test Setup	12
3.3. Limit.....	13
3.4. Test Procedure	13
3.5. Uncertainty	13
3.6. Test Result	14
4. Occupied Bandwidth	34
4.1. Test Equipment	34
4.2. Test Setup	34
4.3. Limit.....	35
4.4. Test Procedure	35
4.5. Uncertainty	35
4.6. Test Result	36
5. Spurious Emission At Antenna Terminals (+/- 1MHz)	76
5.1. Test Equipment	76
5.2. Test Setup	76
5.3. Limit.....	77
5.4. Test Procedure	77
5.5. Uncertainty	77
5.6. Test Result	78
6. Spurious Emission.....	84
6.1. Test Equipment	84
6.2. Test Setup	84
6.3. Limit.....	85
6.4. Test Procedure	85
6.5. Uncertainty	86
6.6. Test Result	87

7.	Frequency Stability Under Temperature & Voltage Variations	267
7.1.	Test Equipment	267
7.2.	Test Setup	267
7.3.	Limit.....	267
7.4.	Test Procedure.....	268
7.5.	Uncertainty	268
7.6.	Test Result	269
Attachment 1	281
	Test Setup Photograph	281
Attachment 2	310
	EUT External Photograph	315
Attachment 3	316
	EUT Internal Photograph.....	316

1. General Information

1.1. EUT Description

Product Name	LE910C1-NA
Model No.	LE910C1-NA
Trade Name	
Tx Frequency Range/ Channel number	GSM 850: 824.2-848.8 MHz GSM 1900: 1850.2-1909.8 MHz WCDMA Band 2: 1852.4-1907.6 MHz WCDMA Band 5: 826.4-846.6 MHz
Rx Frequency Range/ Channel number	GSM 850: 869.2-893.8 MHz GSM 1900: 1930.2-1989.8 MHz WCDMA Band 2: 1932.4-1987.6 MHz WCDMA Band 5: 871.4-891.6 MHz
Type of Modulation	GSM: GMSK; EGSM: GMSK / 8PSK WCDMA: QPSK (Uplink); HSDPA: QPSK (Uplink)
HW Version	1.00
SW Version	25.00.211

Antenna Information	
Antenna Type	Dipole Antenna
Antenna Gain	0.99 dBi (698-960 MHz) 2.37 dBi (1710-2170 MHz) 2.81 dBi (2400-2700MHz)

Note:

This LE910C1-NA included GSM 850, DCS 1900, WCDMA Band 2, WCDMA Band 4 and WCDMA Band 5 transmitting and receiving function.

1.2. Mode of Operation

DEKRA has verified the construction and function in typical operation. All the test modes were carried out with the EUT in normal operation, which was shown in this test report and defined as:

Test Mode	
TX	Mode 1: GSM 850_Link Mode Mode 2: GSM 850_Idle Mode Mode 3: DCS 1900_Link Mode Mode 4: DCS 1900_Idle Mode Mode 5: GSM_EGPRS 850_Link Mode Mode 6: GSM_EGPRS 850_Idle Mode Mode 7: DCS_EGPRS 1900_Link Mode Mode 8: DCS_EGPRS 1900_Idle Mode Mode 9: WCDMA Band 5_Link Mode Mode 10: WCDMA Band 5_Idle Mode Mode 11: WCDMA Band 2_Link Mode Mode 12: WCDMA Band 2_Idle Mode Mode 13: WCDMA Band 5_HSUPA Mode Mode 14: WCDMA Band 5_HSDPA Mode Mode 15: WCDMA Band 2_HSUPA Mode Mode 16: WCDMA Band 2_HSDPA Mode

1.3. Tested System Details

The types for all equipments, plus descriptions of all cables used in the tested system (including inserted cards) are:

Product	Manufacturer	Model No.	Serial No.	FCC ID	Power Cord
1 Fixture	Telit	CS1742C	1742C180000037	DoC	--
2 Horn	ELECTRO METRICS	EM6961	103326	DoC	--
3 Base Station Simulator	JRC	NJZ-2000	ET00477	DoC	--

1.4. Configuration of Tested System

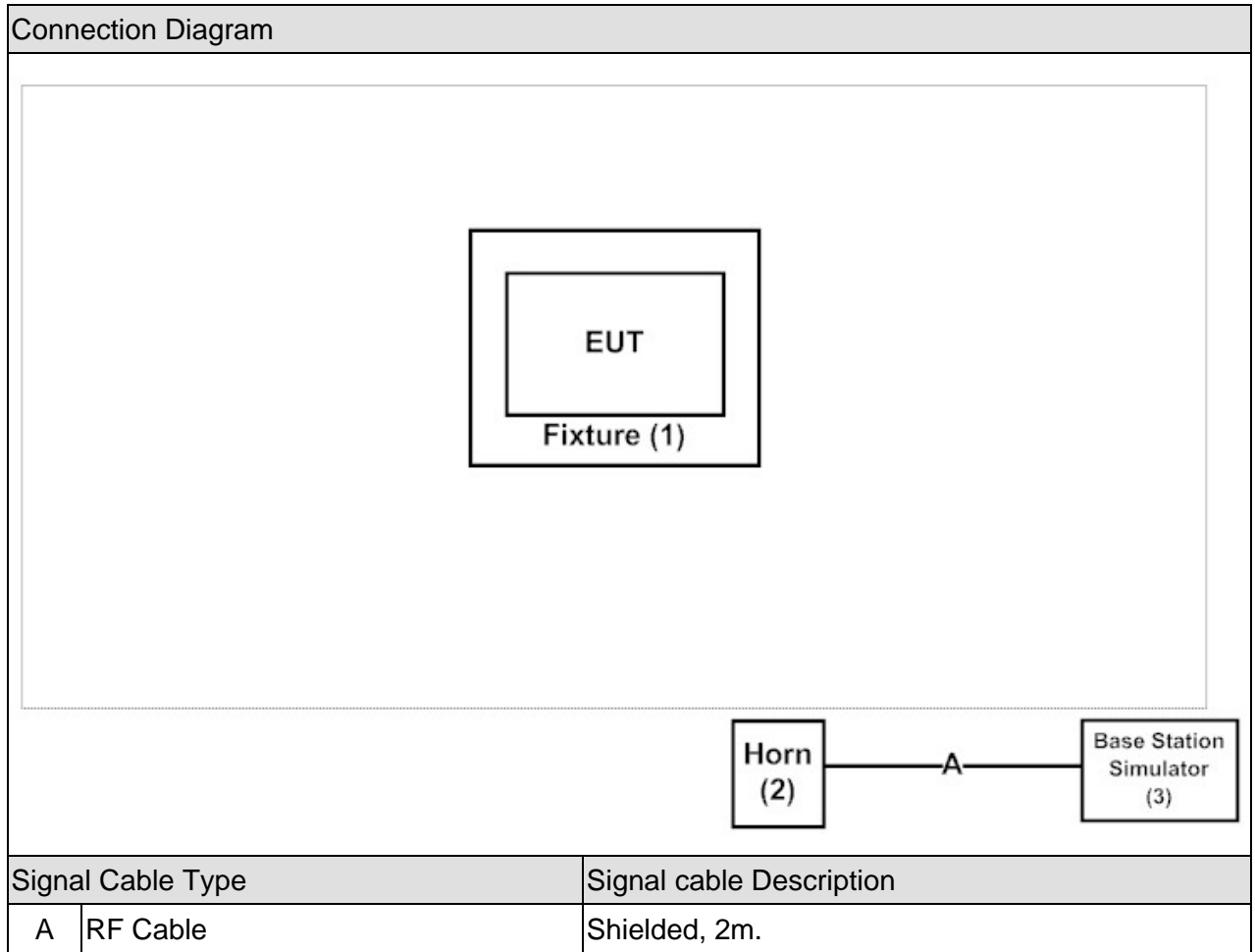

1.5. EUT Exercise Software

1	Setup the EUT as shown in Section 1.4.
2	Turn on the power of all equipment. Horn link with base station.
3	The EUT link with base station and it will continue receive the signal from GSM / WCDMA function.
4	Repeat the above procedure.

2. Technical Test

2.1. Summary of Test Result

Performed Item	FCC References	IC References	Result
Peak Output Power	FCC Part 22.913(a)(2) FCC Part 24.232(b) FCC Part 2.1046	RSS - 132 §5.4 RSS - 133 §6.4	Pass
Occupied Bandwidth	FCC Part 2.1049 FCC Part 24.238(b)	RSS - Gen §4.2	Pass
Spurious Emission At Antenna Terminals (+/- 1MHz)	FCC Part 22.917(a) FCC Part 24.238(a) FCC Part 2.1049	RSS - 132 §5.5 RSS - 133 §6.5	Pass
Spurious Emission	FCC Part 2.1051 FCC Part 2.1053	RSS - 132 §5.5 RSS - 133 §6.5	Pass
Frequency Stability Under Temperature & Voltage Variations	FCC Part 22.355 FCC Part 24.235 FCC Part 2.1055	RSS - 132 §5.3 RSS - 133 §6.3	Pass

2.2. Test Environment

Items	Required (IEC 68-1)	Actual
Temperature (°C)	15-35	23
Humidity (%RH)	25-75	52
Barometric pressure (mbar)	860-1060	950-1000

3. Peak Output Power

3.1. Test Equipment

The following test equipments are used during the RF power output tests:

Peak Output Power - Conducted Power Measurement /SR10-H

Instrument	Manufacturer	Model No.	Serial No	Next Cal. Date
High Speed Peak Power Meter Dual Input	Anritsu	ML2496A	1602004	2017/02/09
Multisystem UE Tester	Japan radio	NJZ-2000	ET00477	2017/09/19
Directional coupler	Agilent	778D	20402	2017/10/06

Peak Output Power - Radiated Power Measurement / CB4-H

Instrument	Manufacturer	Model No.	Serial No	Next Cal. Date
Bilog Antenna	Schaffner	CBL6112B	2891	2017/08/14
Horn Antenna	Schwarzbeck	BBHA 9120	D312	2017/10/25
Pre-Amplifier	EMCI	EMC0031835	980233	2018/02/02
Pre-Amplifier	Schwarzbeck	DBL-1840N506	013	2017/09/29
Pre-Amplifier	Miteq	JS41-001040000-58-5P	1573954	2017/10/04
Horn Antenna	Schwarzbeck	BBHA 9170	203	2017/08/28
Signal & Spectrum Analyzer	R&S	FSV40	101049	2018/01/05

- Note: 1. All of the equipment that need to be calibrated are with calibration period of 1 year.
 2. EIRP = Substitution Level + Substitution Antenna Gain - Cable Loss.

3.2. Test Setup

Conducted Power Measurement:

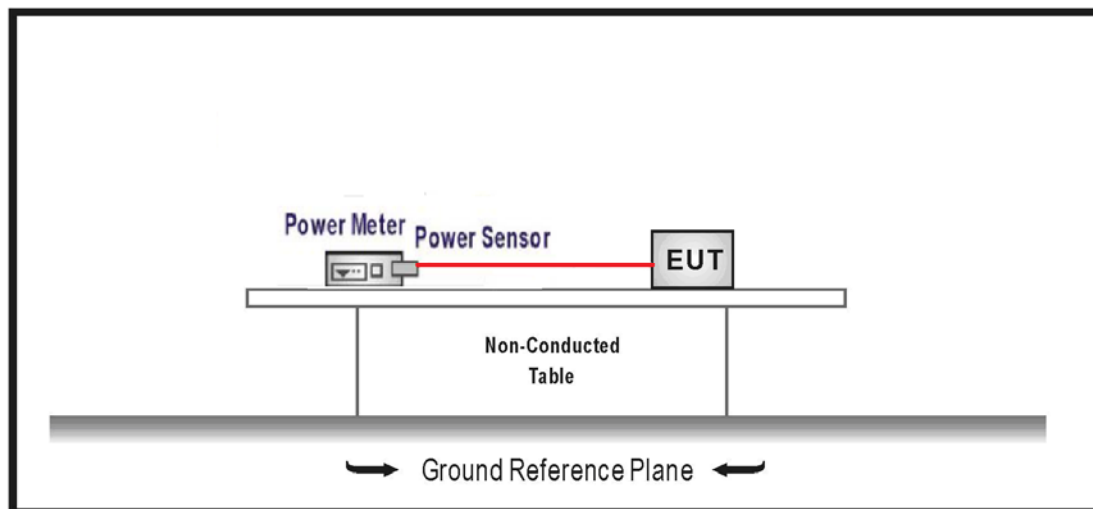

Radiated Power Measurement:

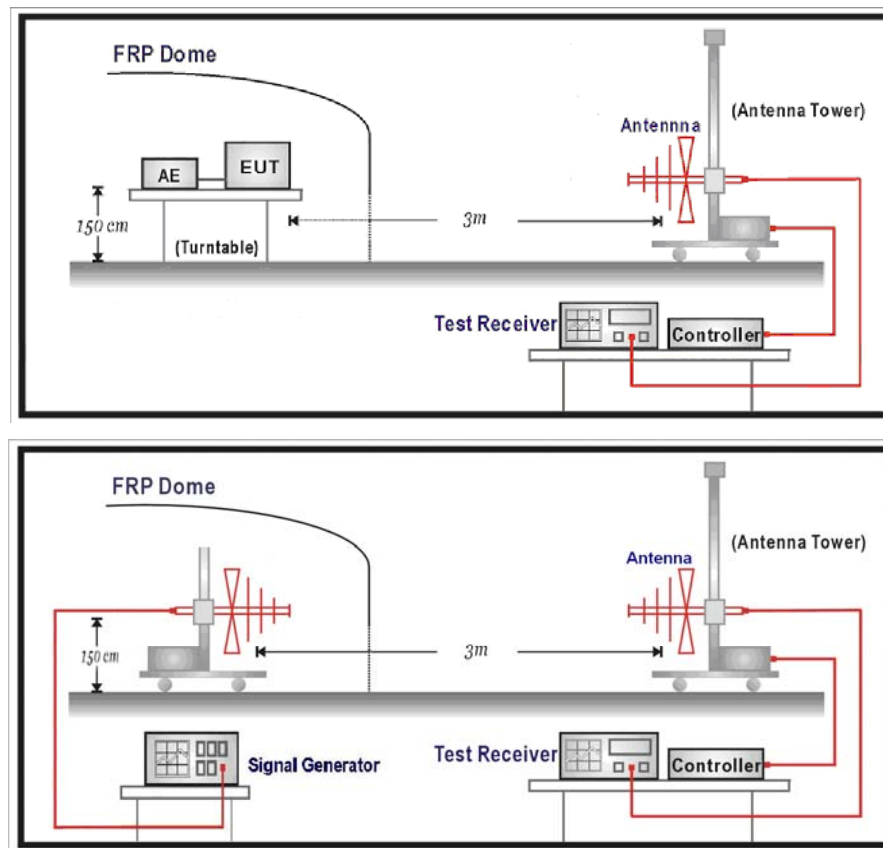

3.3. Limit

1) Part 22 H

The ERP of mobile transmitters and auxiliary test transmitters must not exceed 7 Watts.

2) Part 24 E

The EIRP of mobile transmitters and auxiliary test transmitters must not exceed 2 Watts.

3.4. Test Procedure

Conducted Power Measurement:

- Place the EUT on a bench and set it in transmitting mode.
- Connect a low loss RF cable from the antenna port to a spectrum analyzer and Base Station Simulator by a Directional Couple.
- EUT Communicate with Base Station Simulator then selects a channel for testing.
- Add a correction factor to the display of spectrum, and then test.

3.5. Uncertainty

The measurement uncertainty is defined as for Conducted Power Measurement ± 1.2 dB, for Radiated Power Measurement ± 3.2 dB.

3.6. Test Result

Product	LE910C1-NA		
Test Item	Peak Output Power		
Test Mode	Mode 1: GSM 850_Link Mode		
Date of Test	2017/01/06	Test Site	SR10-H

Frequency (MHz)	Peak Power		Average Power		Limit (dBm)
	Reading Level (dBm)	Measure Level (dBm)	Reading Level (dBm)	Measure Level (dBm)	
824.2	32.86	33.85	32.77	33.76	38
836.6	33.34	34.33	33.24	34.23	38
848.8	33.57	34.56	33.48	34.47	38

Note: Measure Level=Reading Level + Antenna Gain

Product	LE910C1-NA		
Test Item	Peak Output Power		
Test Mode	Mode 3: DCS 1900_Link Mode		
Date of Test	2017/01/06	Test Site	SR10-H

Frequency (MHz)	Peak Power		Average Power		Limit (dBm)
	Reading Level (dBm)	Measure Level (dBm)	Reading Level (dBm)	Measure Level (dBm)	
1850.2	29.93	32.74	29.88	32.69	33
1880.0	29.99	32.8	29.94	32.75	33
1909.8	29.68	32.49	29.61	32.42	33

Note: Measure Level=Reading Level + Antenna Gain

Product	LE910C1-NA		
Test Item	Peak Output Power		
Test Mode	Mode 5: GSM_EGPRS 850_Link Mode		
Date of Test	2017/01/06	Test Site	SR10-H

Frequency (MHz)	Peak Power		Average Power		Limit (dBm)
	Reading Level (dBm)	Measure Level (dBm)	Reading Level (dBm)	Measure Level (dBm)	
824.2	28.24	29.23	25.17	26.16	38
836.6	28.61	29.6	25.68	26.67	38
848.8	28.64	29.63	25.7	26.69	38

Note: Measure Level=Reading Level + Antenna Gain

Product	LE910C1-NA		
Test Item	Peak Output Power		
Test Mode	Mode 7: DCS_EGPRS 1900_Link Mode		
Date of Test	2017/01/06	Test Site	SR10-H

Frequency (MHz)	Peak Power		Average Power		Limit (dBm)
	Reading Level (dBm)	Measure Level (dBm)	Reading Level (dBm)	Measure Level (dBm)	
1850.2	27.37	30.18	24.29	27.1	33
1880.0	27.57	30.38	24.58	27.39	33
1909.8	27.41	30.22	24.34	27.15	33

Note: Measure Level=Reading Level + Antenna Gain

Product	LE910C1-NA		
Test Item	Peak Output Power		
Test Mode	Mode 9: WCDMA Band 5_Link Mode		
Date of Test	2017/01/06	Test Site	SR10-H

Frequency (MHz)	Peak Power		Average Power		Limit (dBm)
	Reading Level (dBm)	Measure Level (dBm)	Reading Level (dBm)	Measure Level (dBm)	
826.4	27.38	28.36	23.610	24.600	38
836.6	27.25	28.24	23.390	24.380	38
846.6	27.58	28.57	23.030	24.020	38

Note: Measure Level=Reading Level + Antenna Gain

Product	LE910C1-NA		
Test Item	Peak Output Power		
Test Mode	Mode 11: WCDMA Band 2_Link Mode		
Date of Test	2017/01/06	Test Site	SR10-H

Frequency (MHz)	Peak Power		Average Power		Limit (dBm)
	Reading Level (dBm)	Measure Level (dBm)	Reading Level (dBm)	Measure Level (dBm)	
1852.4	27.87	30.68	23.770	26.580	33
1880.0	27.71	30.52	23.360	26.170	33
1907.6	27.21	30.02	23.490	26.300	33

Note: Measure Level=Reading Level + Antenna Gain

Product	LE910C1-NA		
Test Item	Peak Output Power		
Test Mode	Mode 13: WCDMA Band 5_HSUPA Mode		
Date of Test	2017/02/13	Test Site	SR10-H

Frequency (MHz)	Peak Power		Average Power		Limit (dBm)
	Reading Level (dBm)	Measure Level (dBm)	Reading Level (dBm)	Measure Level (dBm)	
826.4	28.70	29.69	21.160	22.150	38
836.6	28.38	29.37	21.100	22.090	38
846.6	28.62	29.61	21.150	22.140	38

Note: Measure Level=Reading Level + Antenna Gain

Product	LE910C1-NA		
Test Item	Peak Output Power		
Test Mode	Mode 14: WCDMA Band 5_HSDPA Mode		
Date of Test	2017/02/13	Test Site	SR10-H

Frequency (MHz)	Peak Power		Average Power		Limit (dBm)
	Reading Level (dBm)	Measure Level (dBm)	Reading Level (dBm)	Measure Level (dBm)	
826.4	27.94	28.93	21.840	22.830	38
836.6	27.71	28.7	21.730	22.720	38
846.6	27.97	28.96	21.360	22.350	38

Note: Measure Level=Reading Level + Antenna Gain

Product	LE910C1-NA		
Test Item	Peak Output Power		
Test Mode	Mode 15: WCDMA Band 2_HSUPA Mode		
Date of Test	2017/02/13	Test Site	SR10-H

Frequency (MHz)	Peak Power		Average Power		Limit (dBm)
	Reading Level (dBm)	Measure Level (dBm)	Reading Level (dBm)	Measure Level (dBm)	
1852.4	27.66	30.47	21.340	24.150	33
1880.0	28.19	31.00	21.030	23.840	33
1907.6	27.63	30.44	21.110	23.920	33

Note: Measure Level=Reading Level + Antenna Gain

Product	LE910C1-NA		
Test Item	Peak Output Power		
Test Mode	Mode 16: WCDMA Band 2_HSDPA Mode		
Date of Test	2017/02/13	Test Site	SR10-H

Frequency (MHz)	Peak Power		Average Power		Limit (dBm)
	Reading Level (dBm)	Measure Level (dBm)	Reading Level (dBm)	Measure Level (dBm)	
1852.4	27.66	30.47	21.950	24.760	33
1880.0	27.74	30.55	21.590	24.400	33
1907.6	27.33	30.14	21.710	24.520	33

Note: Measure Level=Reading Level + Antenna Gain

Product	LE910C1-NA		
Test Item	Peak Output Power_ Radiated		
Test Mode	Mode 1: GSM 850_Link Mode		
Date of Test	2017/02/17	Test Site	CB4-H

Frequency (MHz)	Measure Level (dBm)	Limit (dBm)
824.2	28.60	38
836.6	28.59	38
848.8	28.66	38

Product	LE910C1-NA		
Test Item	Peak Output Power_Radiated		
Test Mode	Mode 3: DCS 1900_Link Mode		
Date of Test	2017/02/17	Test Site	CB4-H

Frequency (MHz)	Measure Level (dBm)	Limit (dBm)
1850.2	31.98	33
1880.0	31.76	33
1909.8	31.85	33

Product	LE910C1-NA		
Test Item	Peak Output Power_Radiated		
Test Mode	Mode 5: GSM_EGPRS 850_Link Mode		
Date of Test	2017/02/17	Test Site	CB4-H

Frequency (MHz)	Measure Level (dBm)	Limit (dBm)
824.2	25.18	38
836.6	25.90	38
848.8	26.08	38

Product	LE910C1-NA		
Test Item	Peak Output Power_Radiated		
Test Mode	Mode 7: DCS_EGPRS 1900_Link Mode		
Date of Test	2017/02/17	Test Site	CB4-H

Frequency (MHz)	Measure Level (dBm)	Limit (dBm)
1850.2	29.62	33
1880.0	29.85	33
1909.8	28.95	33

Product	LE910C1-NA		
Test Item	Peak Output Power_Radiated		
Test Mode	Mode 9: WCDMA Band 5_Link Mode		
Date of Test	2017/02/17	Test Site	CB4-H

Frequency (MHz)	Measure Level (dBm)	Limit (dBm)
826.4	27.54	38
836.6	27.17	38
846.6	27.15	38

Product	LE910C1-NA		
Test Item	Peak Output Power_Radiated		
Test Mode	Mode 11: WCDMA Band 2_Link Mode		
Date of Test	2017/02/17	Test Site	CB4-H

Frequency (MHz)	Measure Level (dBm)	Limit (dBm)
1852.4	26.56	33
1880.0	26.60	33
1907.6	26.38	33

Product	LE910C1-NA		
Test Item	Peak Output Power_Radiated		
Test Mode	Mode 13: WCDMA Band 5_HSUPA Mode		
Date of Test	2017/02/17	Test Site	CB4-H

Frequency (MHz)	Measure Level (dBm)	Limit (dBm)
826.4	28.30	38
836.6	38.31	38
846.6	26.97	38

Product	LE910C1-NA		
Test Item	Peak Output Power_Radiated		
Test Mode	Mode 14: WCDMA Band 5_HSDPA Mode		
Date of Test	2017/02/17	Test Site	CB4-H

Frequency (MHz)	Measure Level (dBm)	Limit (dBm)
826.4	28.12	38
836.6	27.31	38
846.6	27.55	38

Product	LE910C1-NA		
Test Item	Peak Output Power_Radiated		
Test Mode	Mode 15: WCDMA Band 2_HSUPA Mode		
Date of Test	2017/02/17	Test Site	CB4-H

Frequency (MHz)	Measure Level (dBm)	Limit (dBm)
1852.4	27.55	33
1880.0	27.52	33
1907.6	27.30	33

Product	LE910C1-NA		
Test Item	Peak Output Power_Radiated		
Test Mode	Mode 16: WCDMA Band 2_HSDPA Mode		
Date of Test	2017/02/17	Test Site	CB4-H

Frequency (MHz)	Measure Level (dBm)	Limit (dBm)
1852.4	26.13	33
1880.0	27.22	33
1907.6	26.97	33

4. Occupied Bandwidth

4.1. Test Equipment

The following test equipments are used during the RF power output tests:

Occupied Bandwidth/SR10-H

Instrument	Manufacturer	Model No.	Serial No	Next Cal. Date
Signal & Spectrum Analyzer	R&S	FSVA40	101455	2017/11/27
Multisystem UE Tester	Japan radio	NJZ-2000	ET00477	2017/09/19
Directional coupler	Agilent	778D	20402	2017/10/06

Note: All equipment upon which need to be calibrated are with calibration period of 1 year.

4.2. Test Setup

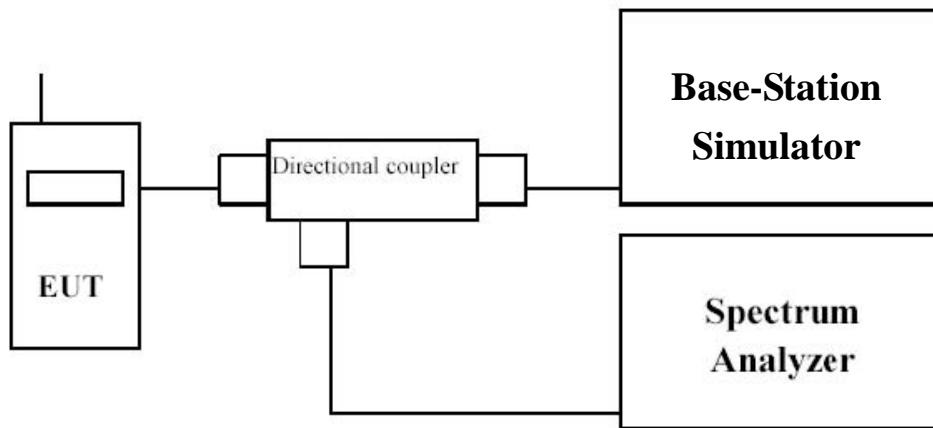

4.3. Limit

N/A

4.4. Test Procedure

Using a resolution bandwidth of 3 kHz and a video bandwidth of 10 kHz, the -26dBc points were established and the emission bandwidth determined. The plots below show the resultant display from the Spectrum Analyzer.

4.5. Uncertainty

The measurement uncertainty is defined as ± 10 Hz

4.6. Test Result

Product	LE910C1-NA		
Test Item	Occupied Bandwidth		
Test Mode	Mode 1: GSM 850_Link Mode		
Date of Test	2017/01/06	Test Site	SR10-H

Frequency (MHz)	-26dB BW Measure Level (MHz)	99% BW Measure Level (MHz)	Limit (MHz)
824.2	0.314	0.244	N/A
836.6	0.316	0.244	N/A
848.8	0.318	0.243	N/A

824.2 MHz (-26dB BW)

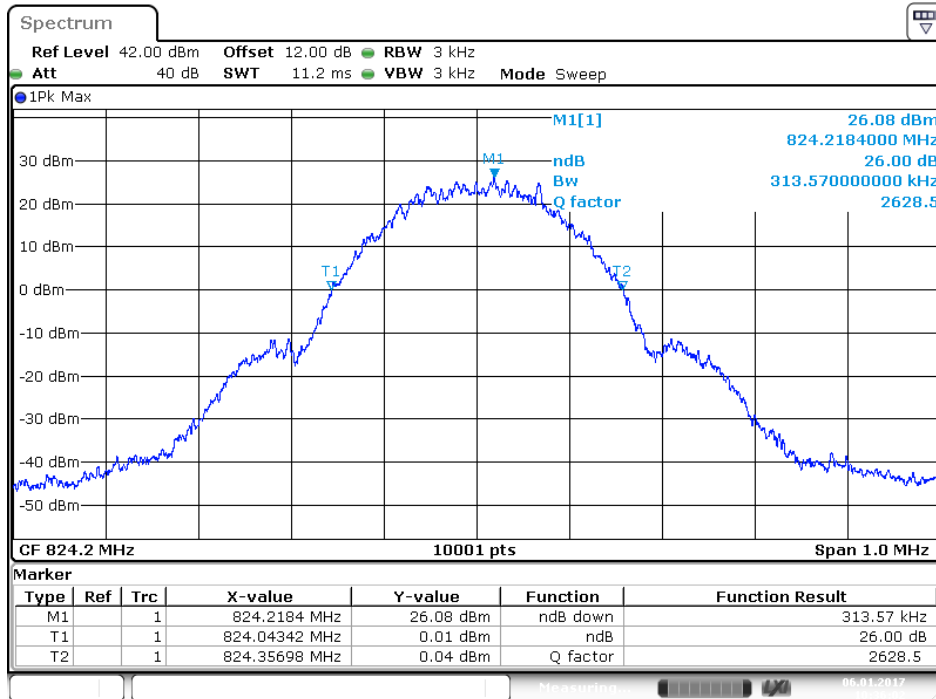

Date: 6 JAN 2017 10:36:02

824.2 MHz (99% BW)

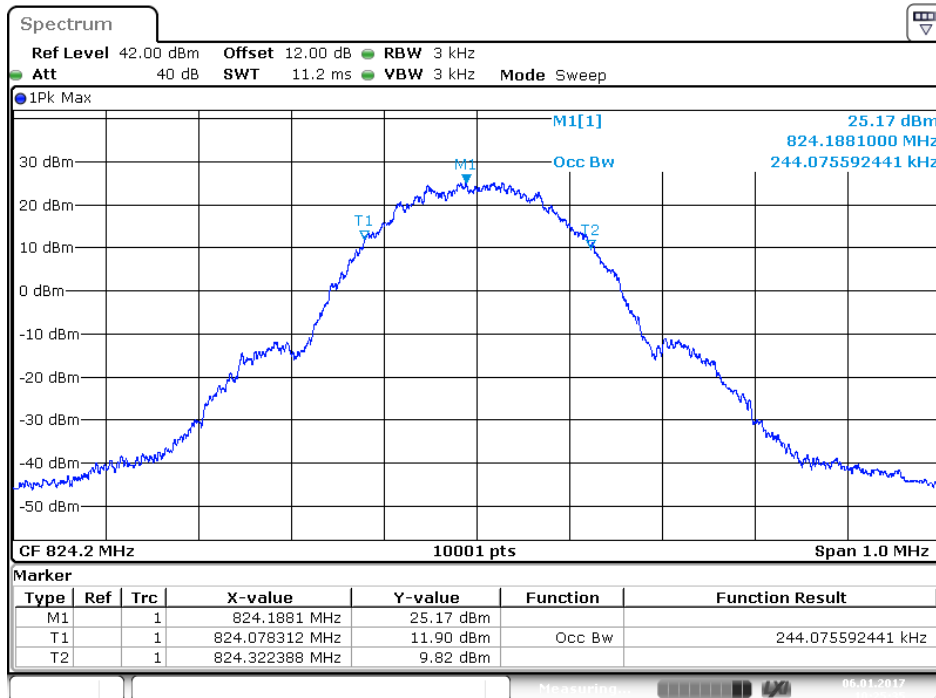

Date: 6 JAN 2017 10:25:36

836.6 MHz (-26dB BW)

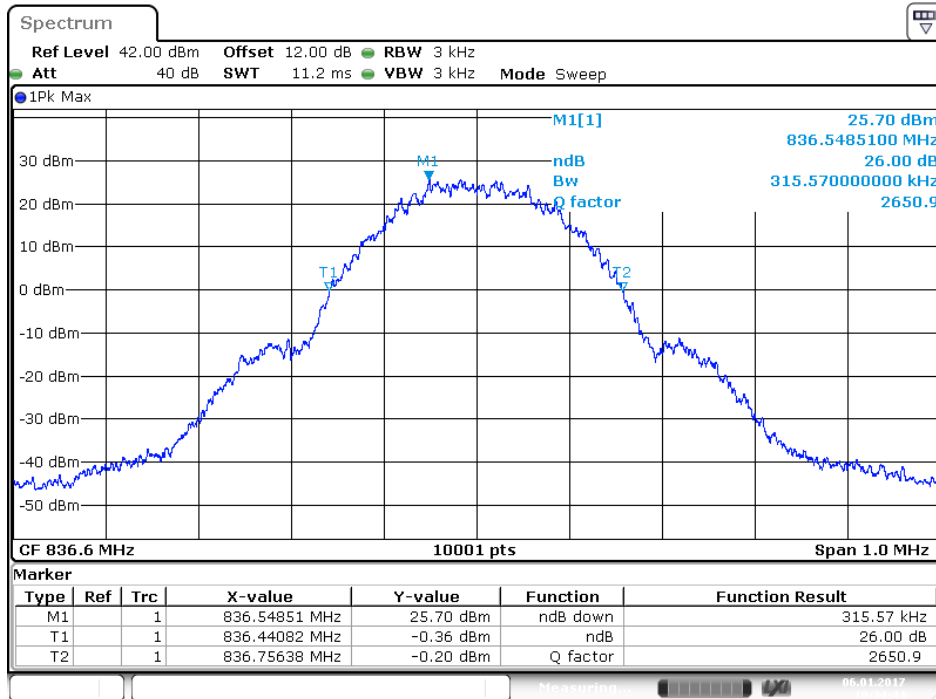

Date: 6 JAN. 2017 10:34:45

836.6 MHz (99% BW)

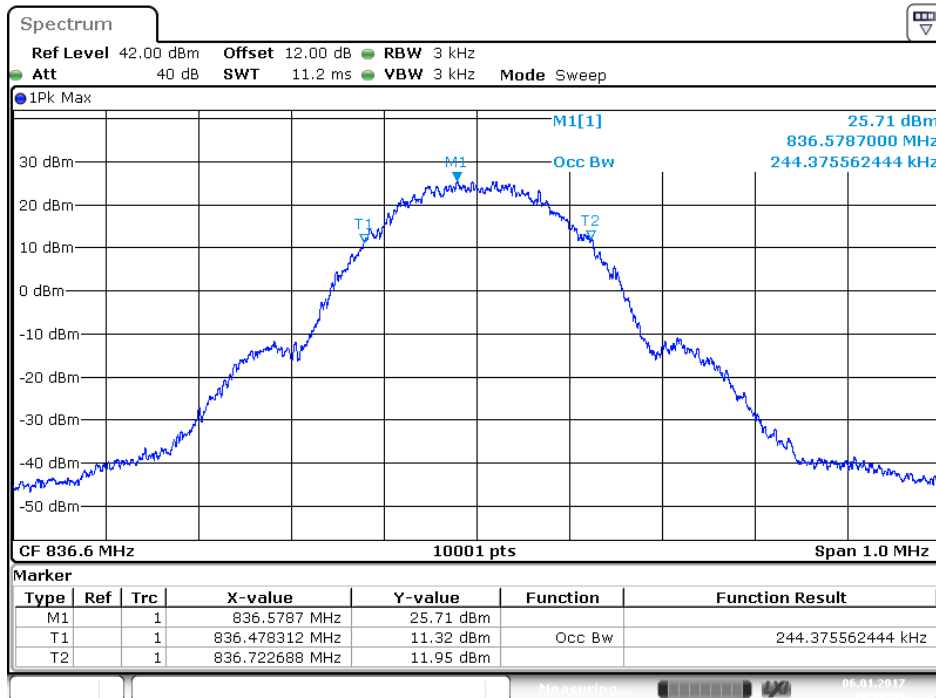

Date: 6 JAN. 2017 10:26:59

848.8 MHz (-26dB BW)

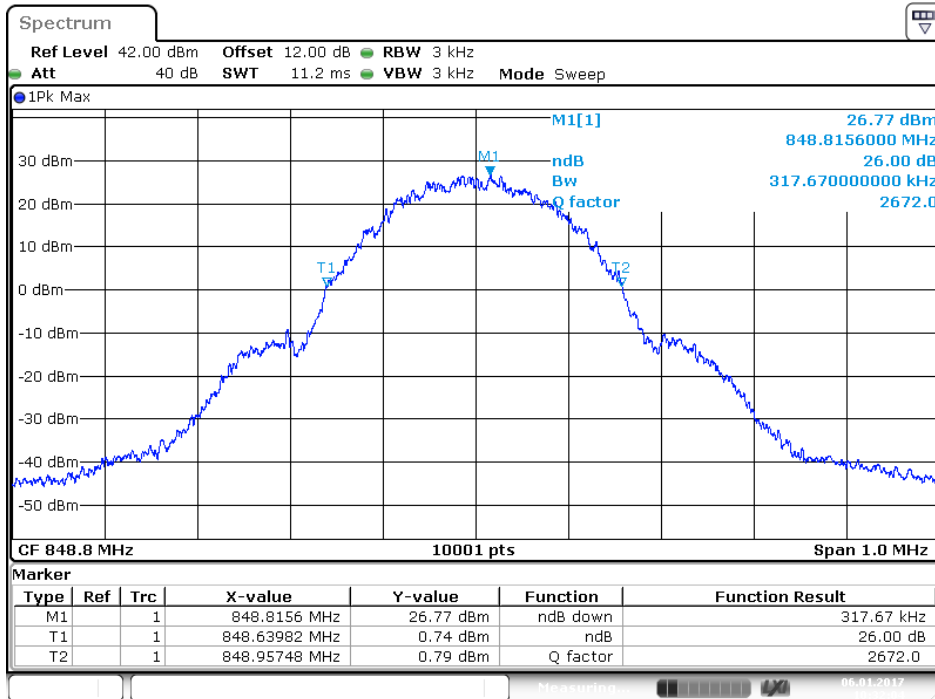

Date: 6 JAN 2017 10:32:04

848.8 MHz (99% BW)

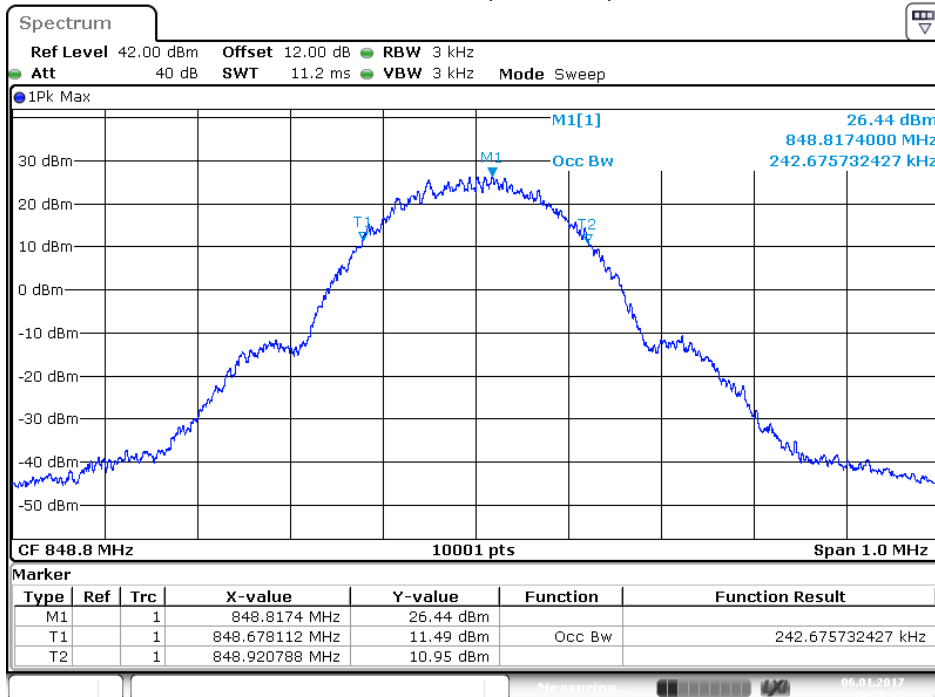

Date: 6 JAN 2017 10:28:23

Product	LE910C1-NA		
Test Item	Occupied Bandwidth		
Test Mode	Mode 3: DCS 1900_Link Mode		
Date of Test	2017/01/06	Test Site	SR10-H

Frequency (MHz)	-26dB BW Measure Level (MHz)	99% BW Measure Level (MHz)	Limit (MHz)
1850.2	0.316	0.244	N/A
1880.0	0.313	0.244	N/A
1909.8	0.315	0.248	N/A

1850.2 MHz (-26dB BW)

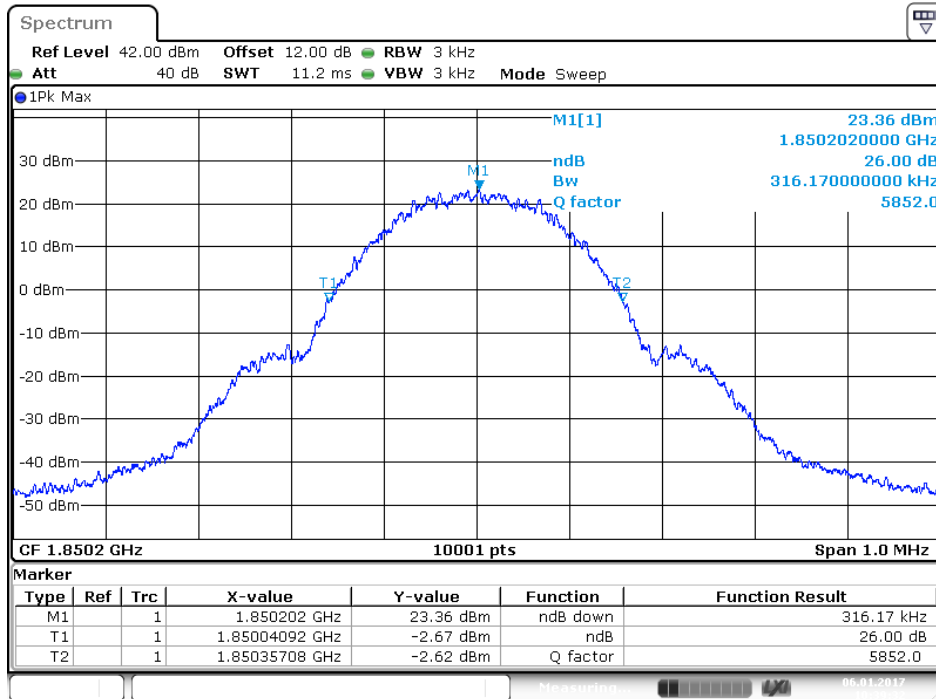

Date: 6 JAN 2017 10:39:33

1850.2 MHz (99% BW)

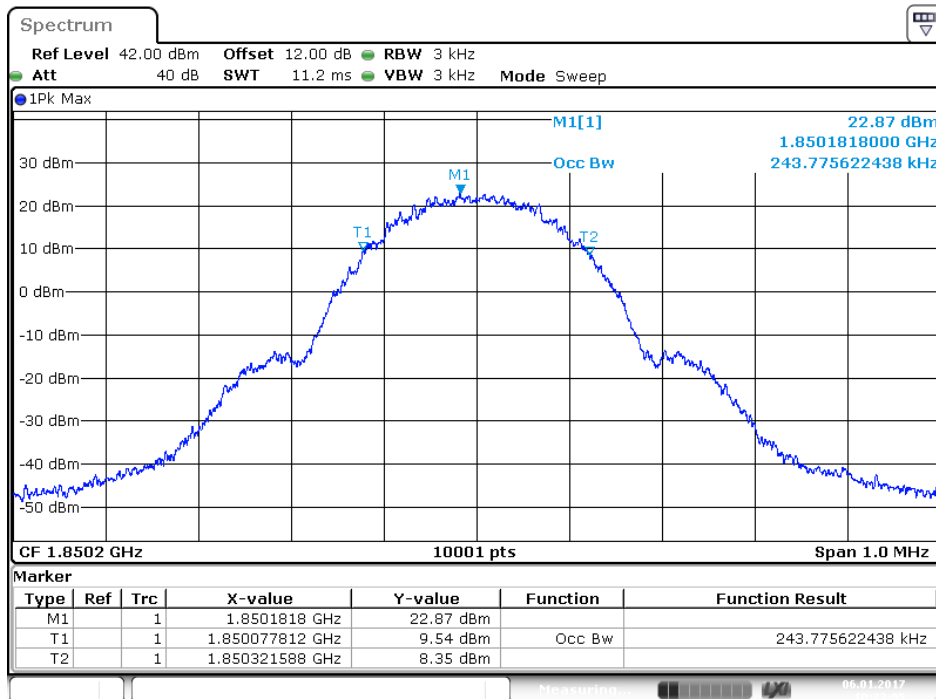

Date: 6 JAN 2017 10:23:06

1880.0 MHz (-26dB BW)

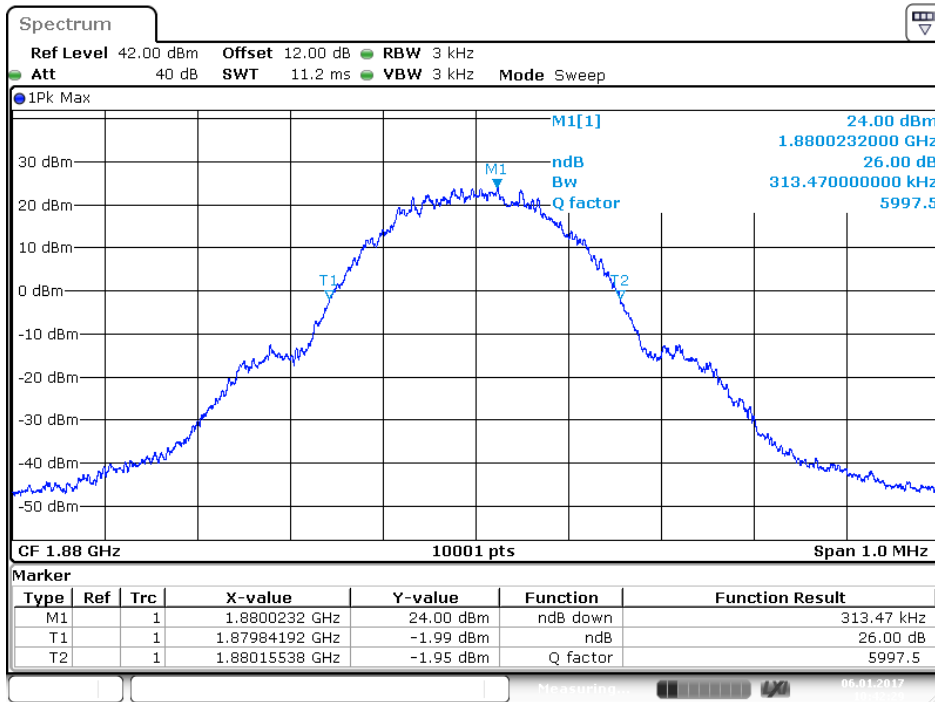

Date: 6 JAN 2017 10:42:30

1880.0 MHz (99% BW)

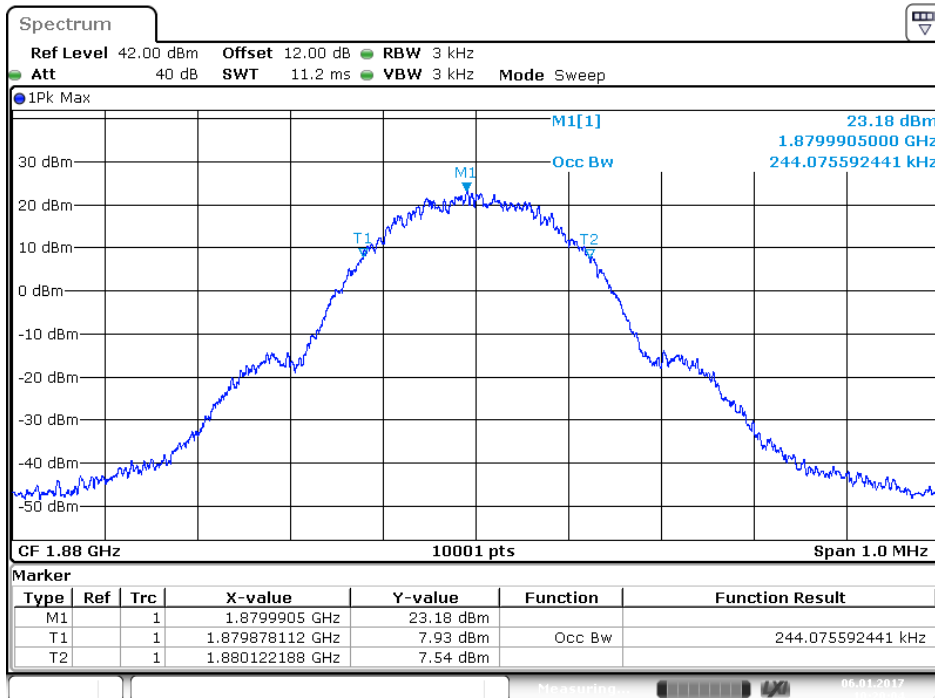

Date: 6 JAN 2017 10:20:04

1909.8 MHz (-26dB BW)

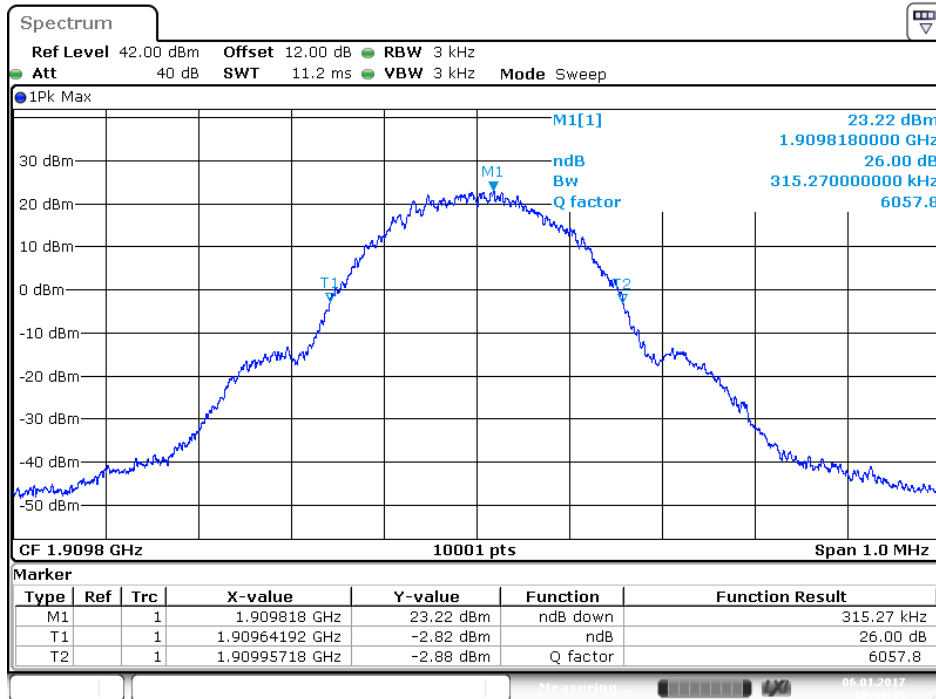

1909.8 MHz (99% BW)

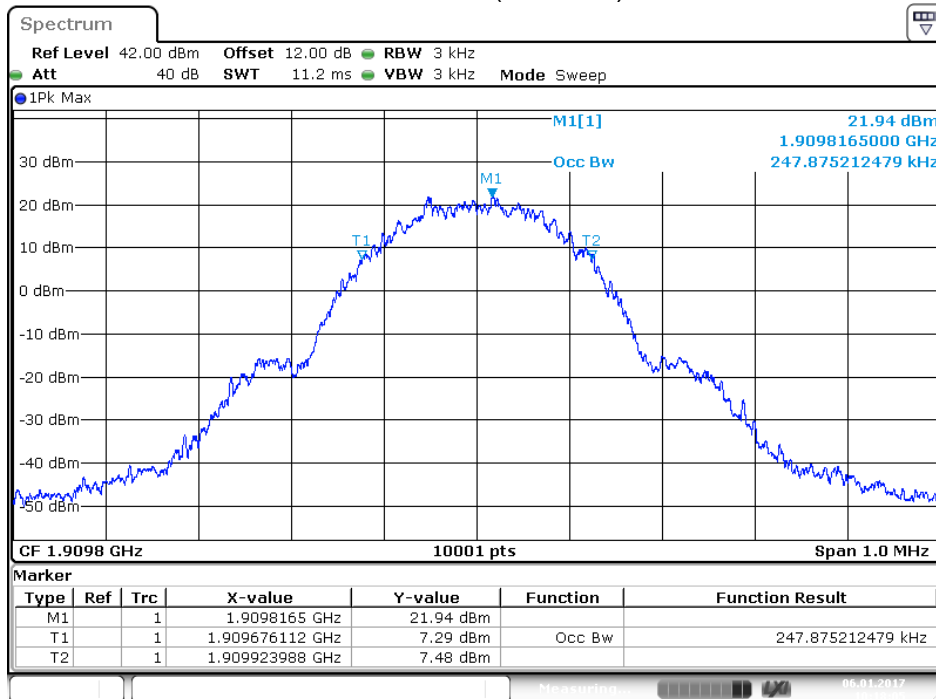

Product	LE910C1-NA		
Test Item	Occupied Bandwidth		
Test Mode	Mode 5: GSM_EGPRS 850_Link Mode		
Date of Test	2017/01/06	Test Site	SR10-H

Frequency (MHz)	-26dB BW Measure Level (MHz)	99% BW Measure Level (MHz)	Limit (MHz)
824.2	0.313	0.245	N/A
836.6	0.313	0.247	N/A
848.8	0.312	0.244	N/A

824.2 MHz (-26dB BW)

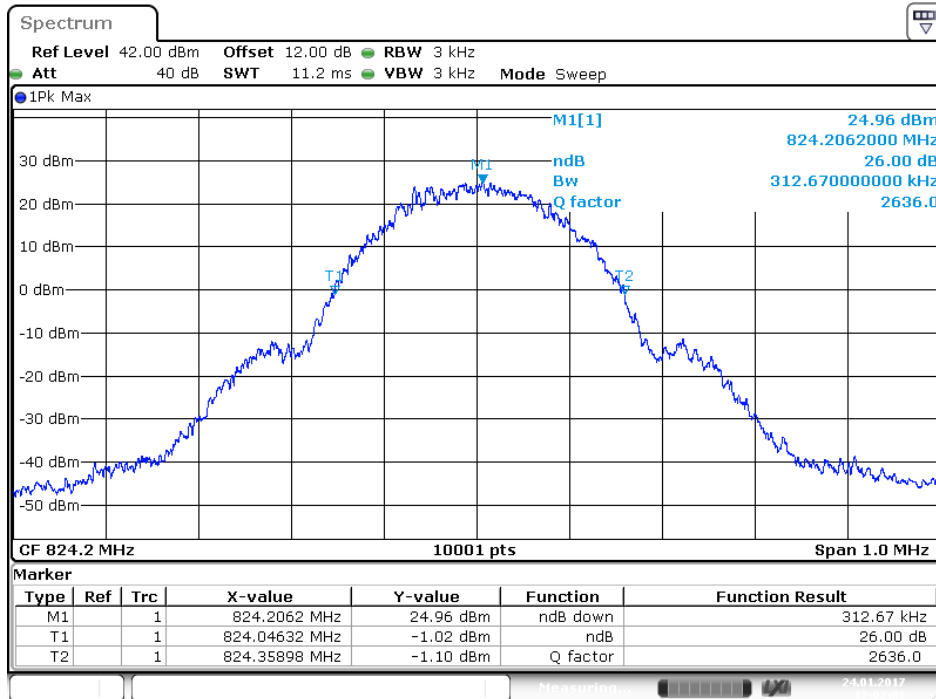

Date: 24.JAN.2017 12:02:08

824.2 MHz (99% BW)

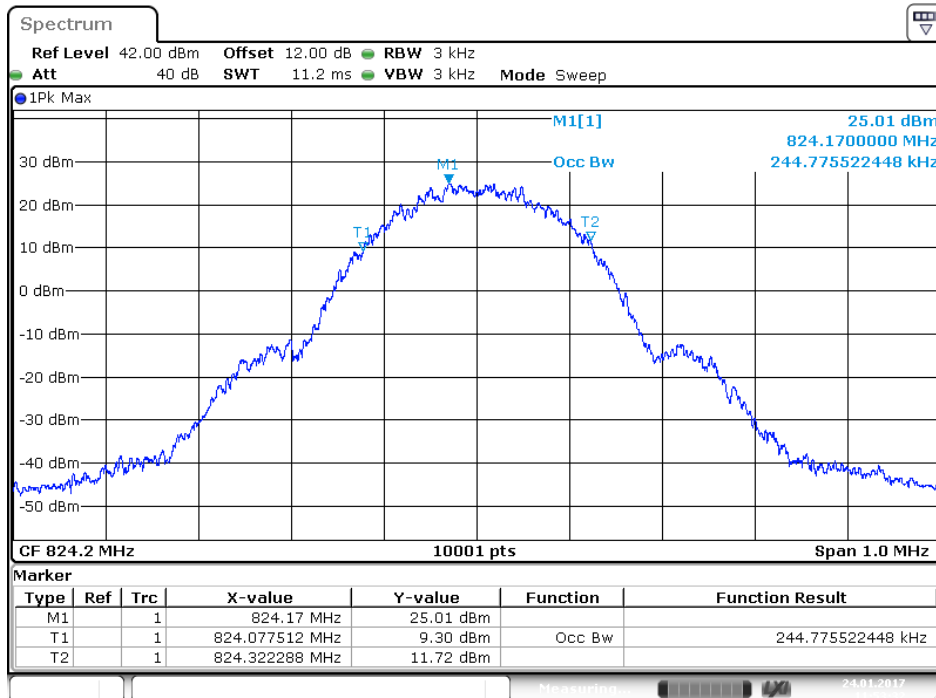

Date: 24.JAN.2017 11:53:32

836.6 MHz (-26dB BW)

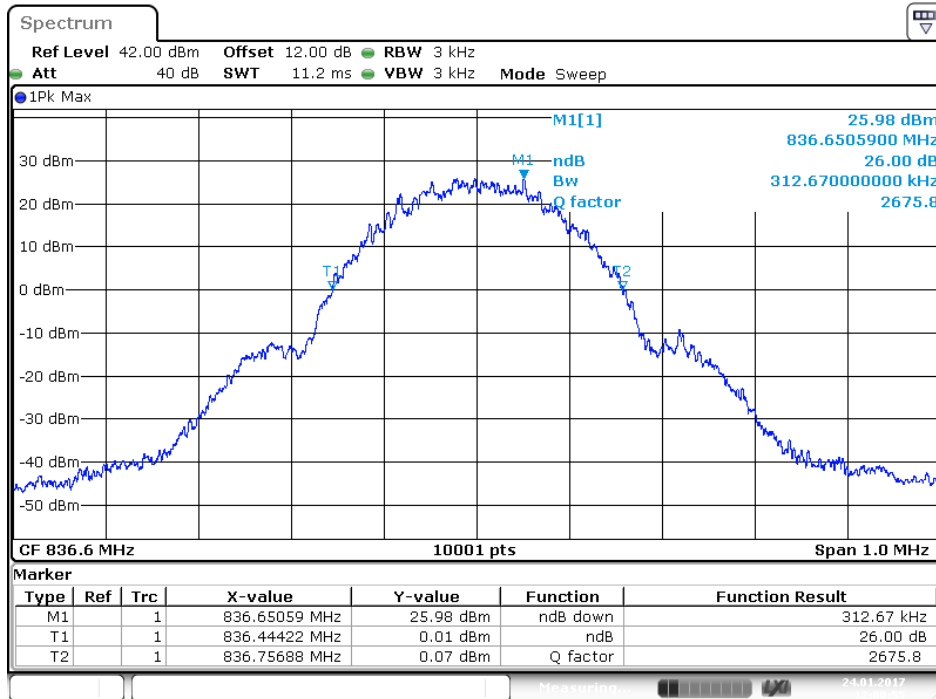

Date: 24 JAN 2017 12:00:55

836.6 MHz (99% BW)

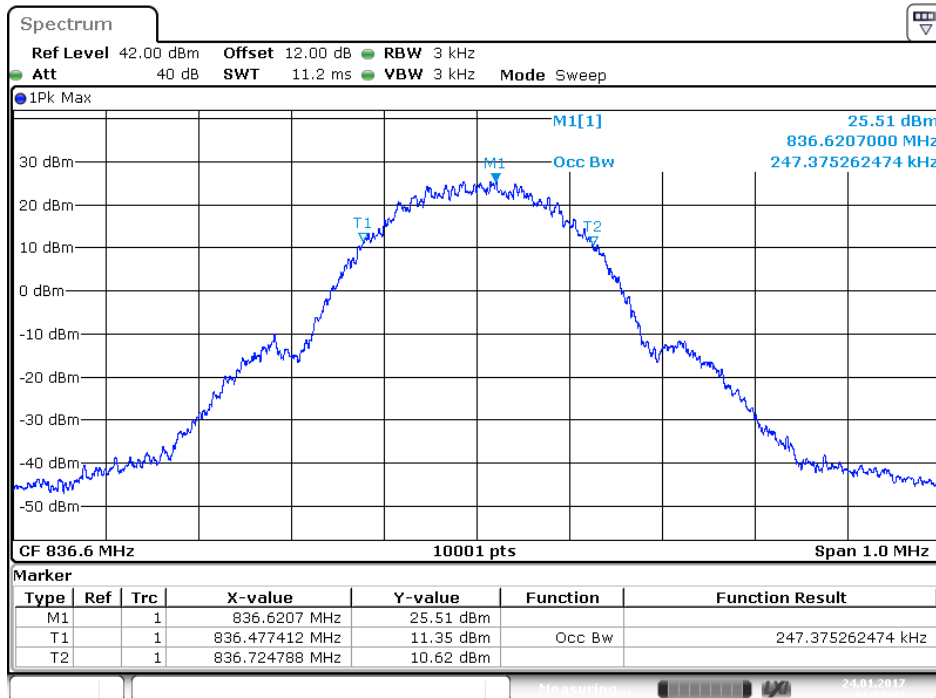

Date: 24 JAN 2017 11:52:23

848.8 MHz (-26dB BW)

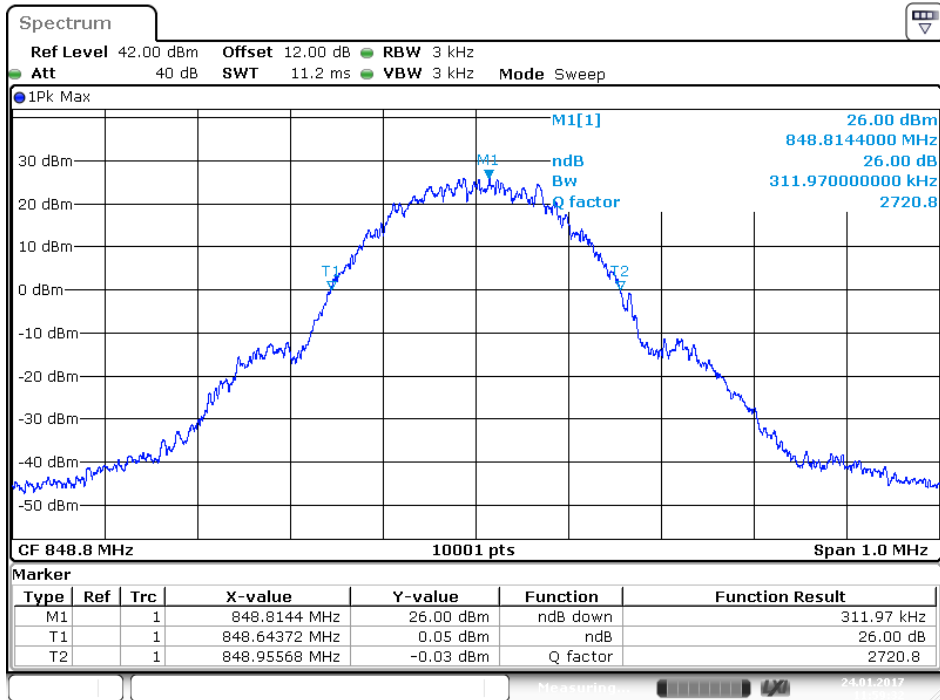

Date: 24.JAN.2017 11:59:31

848.8 MHz (99% BW)

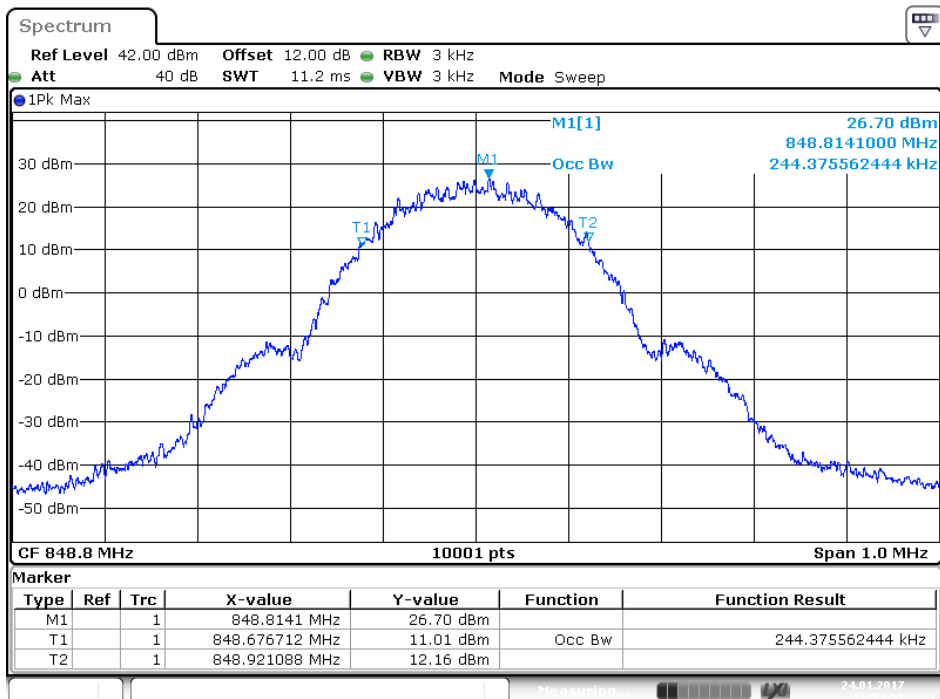

Date: 24.JAN.2017 11:54:52

Product	LE910C1-NA		
Test Item	Occupied Bandwidth		
Test Mode	Mode 7: DCS_EGPRS 1900_Link Mode		
Date of Test	2017/01/06	Test Site	SR10-H

Frequency (MHz)	-26dB BW Measure Level (MHz)	99% BW Measure Level (MHz)	Limit (MHz)
1850.2	0.316	0.245	N/A
1880.0	0.309	0.245	N/A
1909.8	0.317	0.246	N/A

1850.2 MHz (-26dB BW)

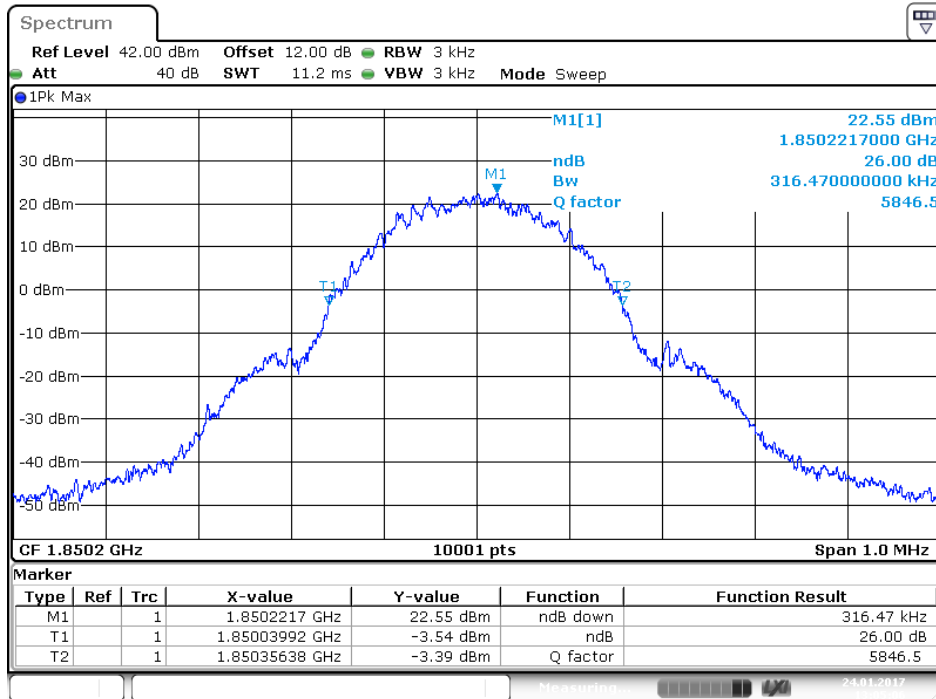

Date: 24 JAN 2017 13:05:06

1850.2 MHz (99% BW)

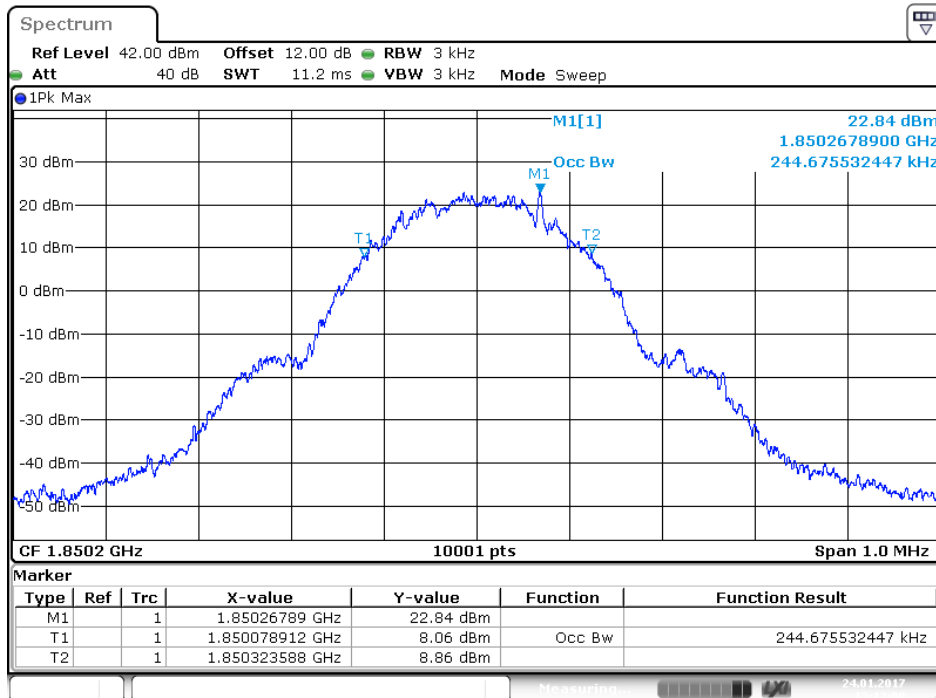

Date: 24 JAN 2017 13:12:00

1880.0 MHz (-26dB BW)

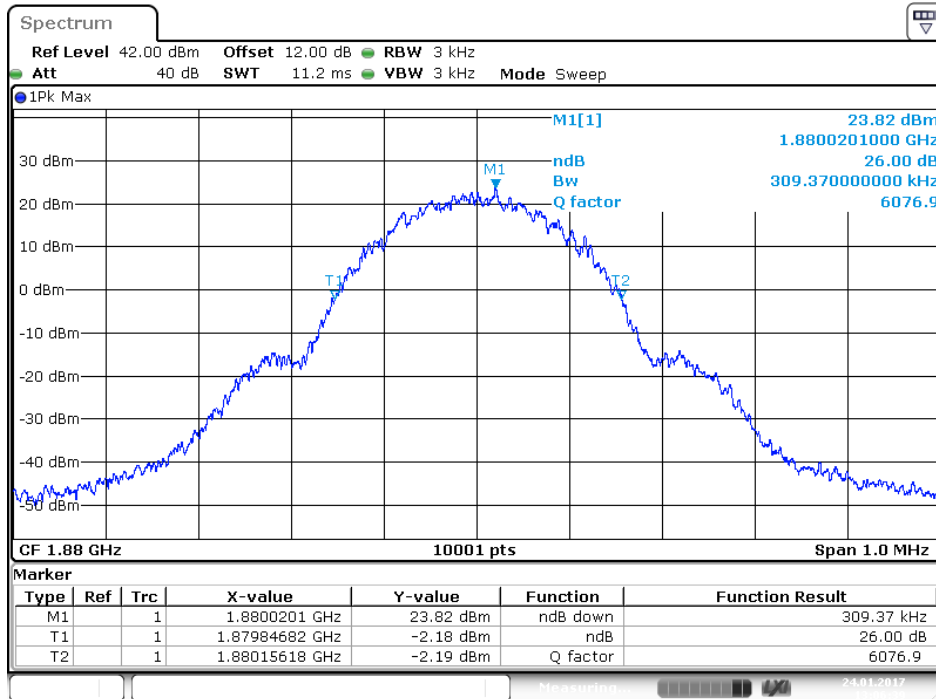

Date: 24 JAN 2017 13:06:39

1880.0 MHz (99% BW)

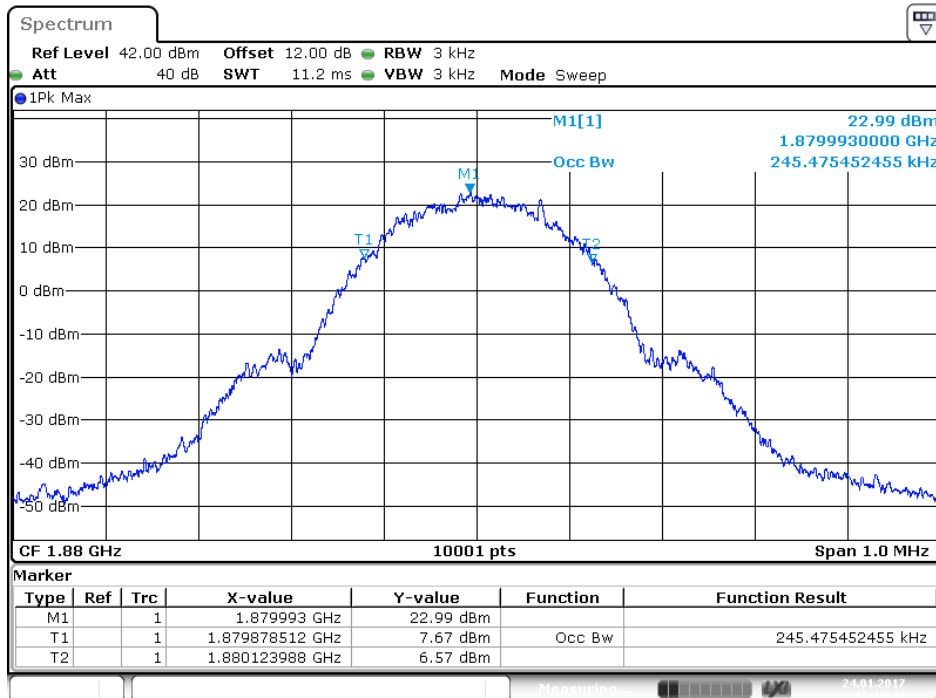

Date: 24 JAN 2017 13:10:48

1909.8 MHz (-26dB BW)

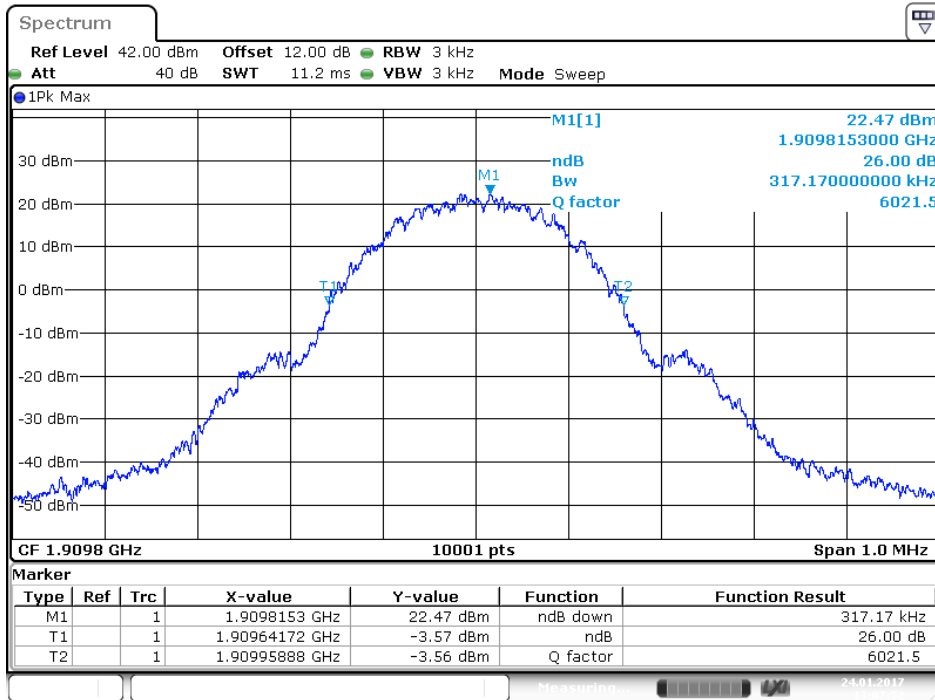

Date: 24.JAN.2017 13:07:52

1909.8 MHz (99% BW)

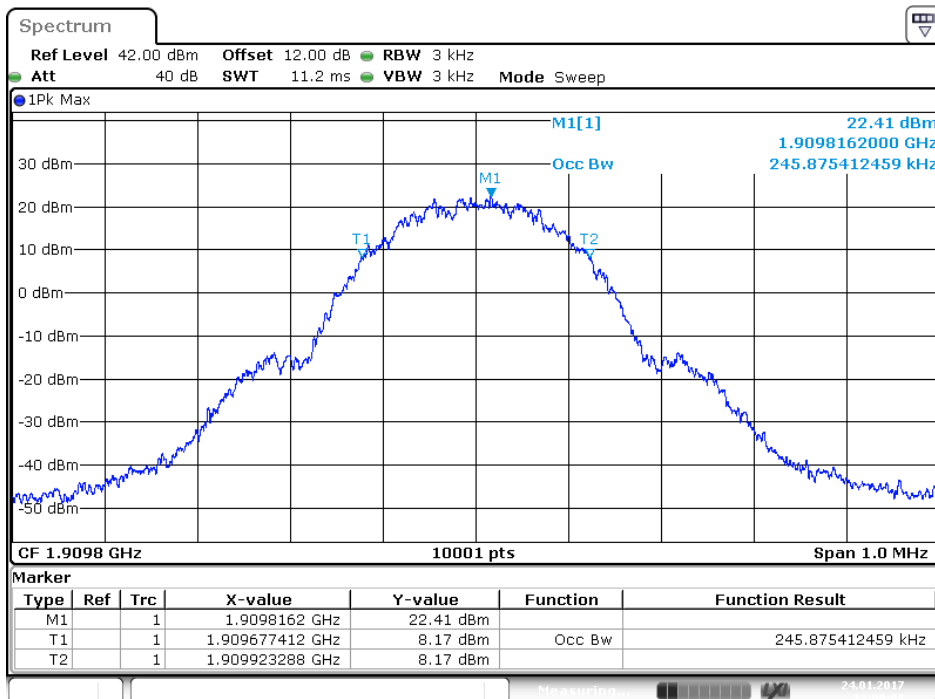

Date: 24.JAN.2017 13:09:09

Product	LE910C1-NA		
Test Item	Occupied Bandwidth		
Test Mode	Mode 9: WCDMA Band 5_Link Mode		
Date of Test	2017/01/06	Test Site	SR10-H

Frequency (MHz)	-26dB BW Measure Level (MHz)	99% BW Measure Level (MHz)	Limit (MHz)
826.4	4.694	4.148	N/A
836.6	4.681	4.144	N/A
846.6	4.703	4.149	N/A

826.4 MHz (-26dB BW)

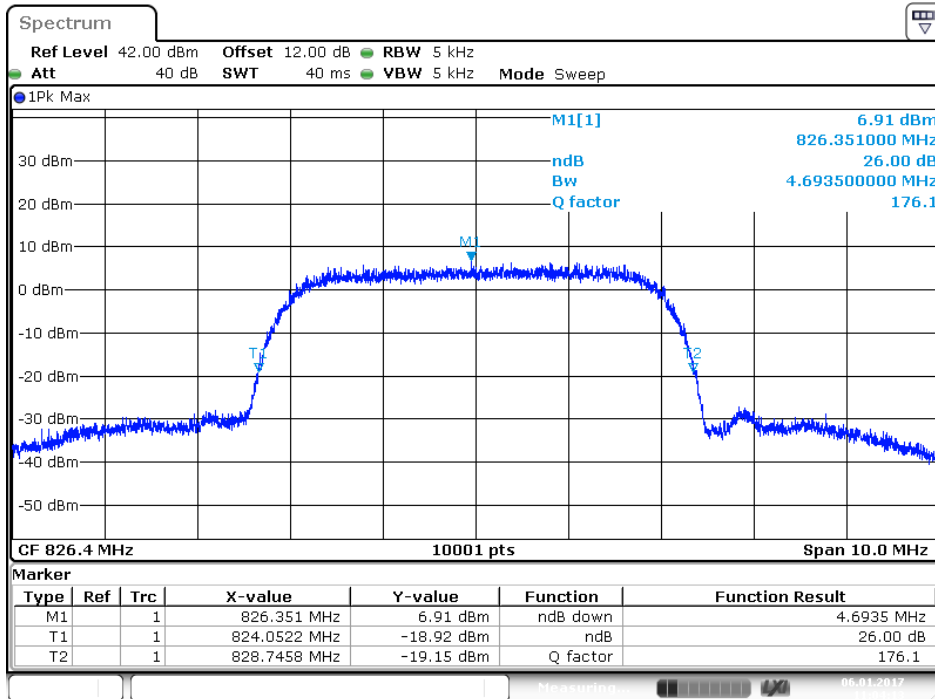

826.4 MHz (99% BW)

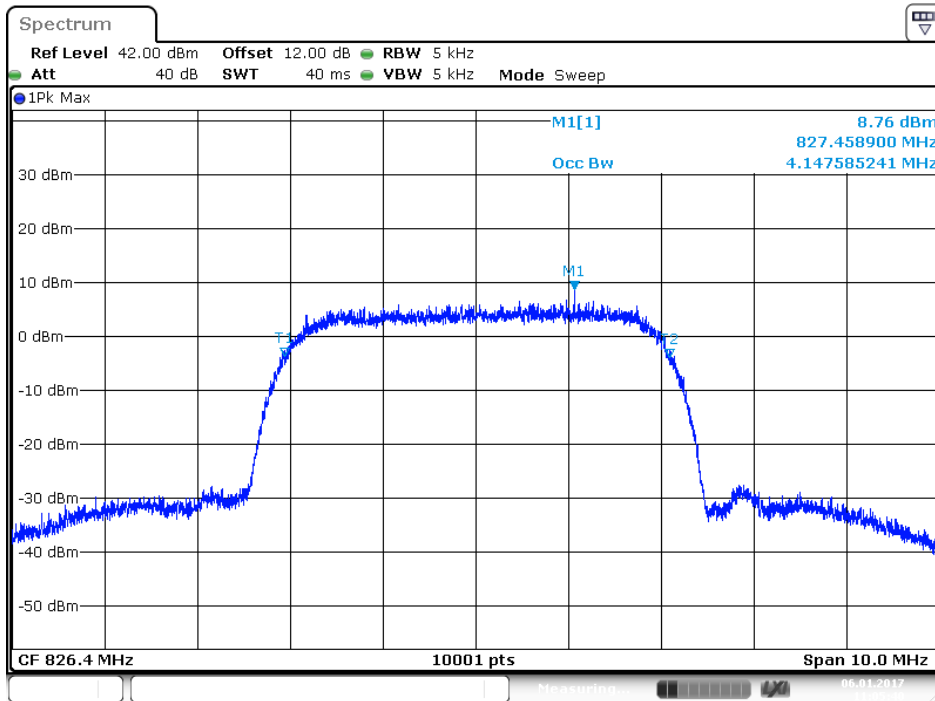

836.6 MHz (-26dB BW)

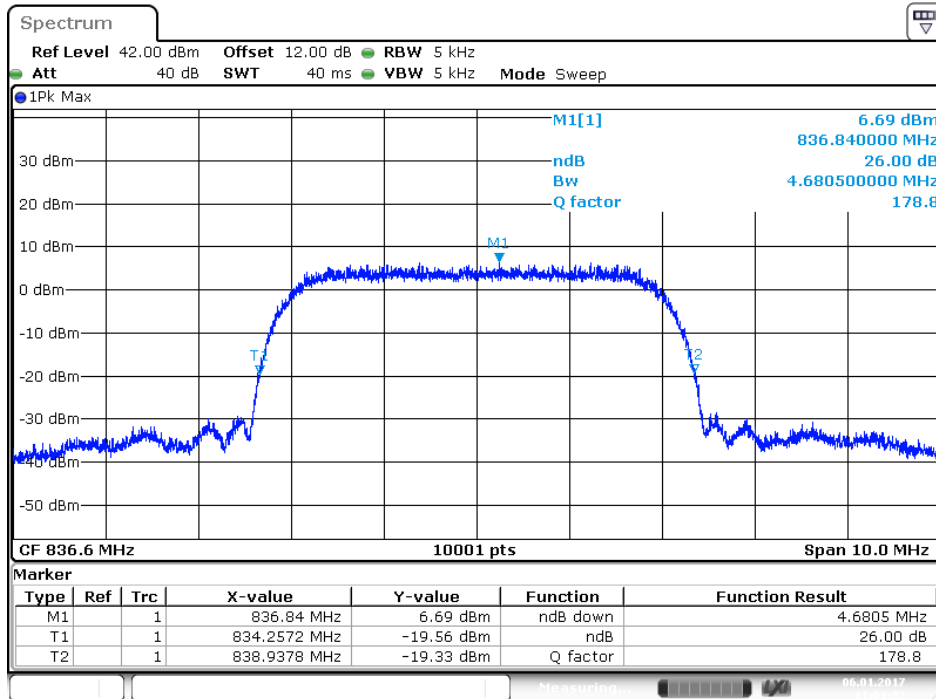

836.6 MHz (99% BW)

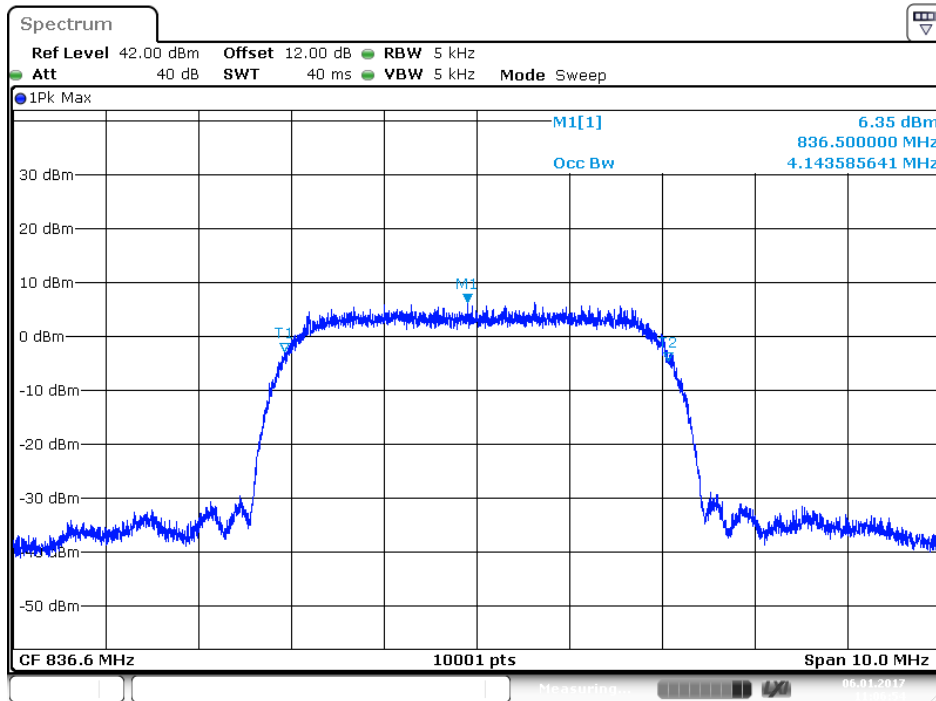

846.6 MHz (-26dB BW)

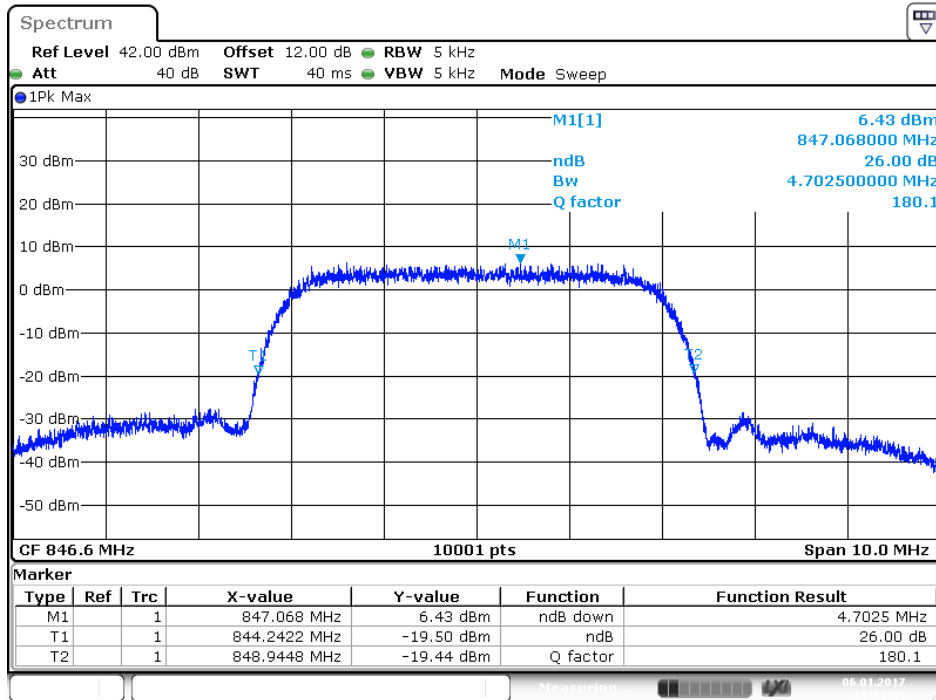

Date: 6 JAN 2017 11:01:52

846.6 MHz (99% BW)

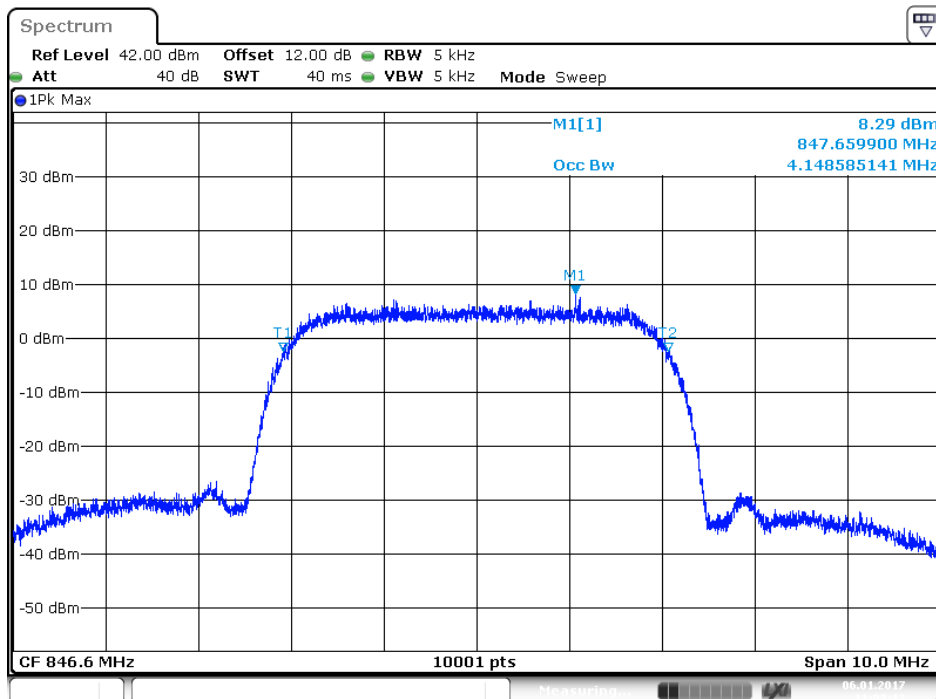

Date: 6 JAN 2017 11:08:12

Product	LE910C1-NA		
Test Item	Occupied Bandwidth		
Test Mode	Mode 11: WCDMA Band 2_Link Mode		
Date of Test	2017/01/06	Test Site	SR10-H

Frequency (MHz)	-26dB BW Measure Level (MHz)	99% BW Measure Level (MHz)	Limit (MHz)
1852.4	4.666	4.135	N/A
1880.0	4.660	4.136	N/A
1907.6	4.670	4.144	N/A

1852.4 MHz (-26dB BW)

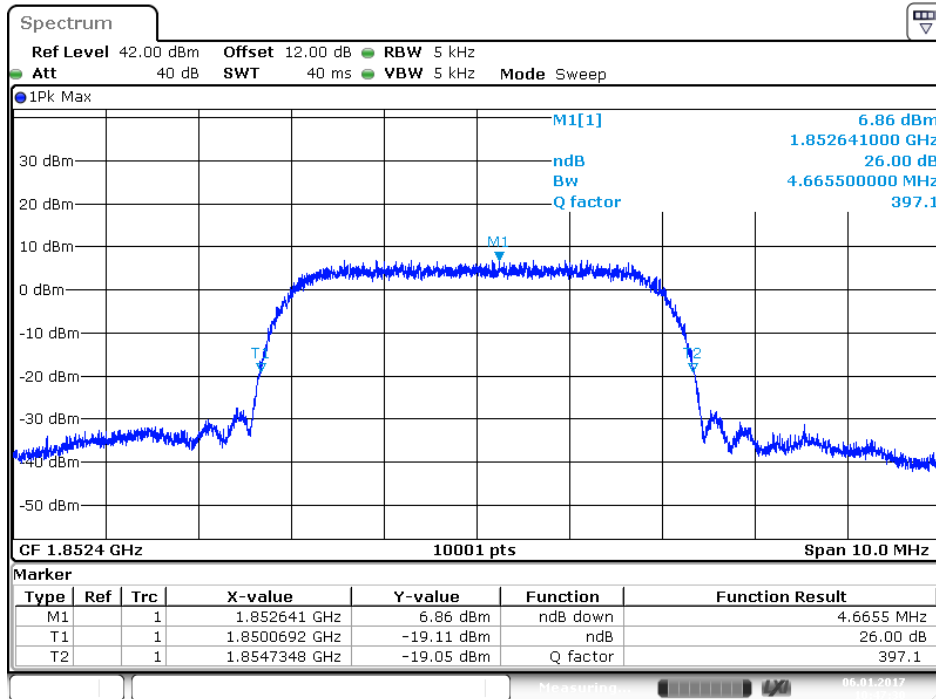

Date: 6 JAN. 2017 10:47:30

1852.4 MHz (99% BW)

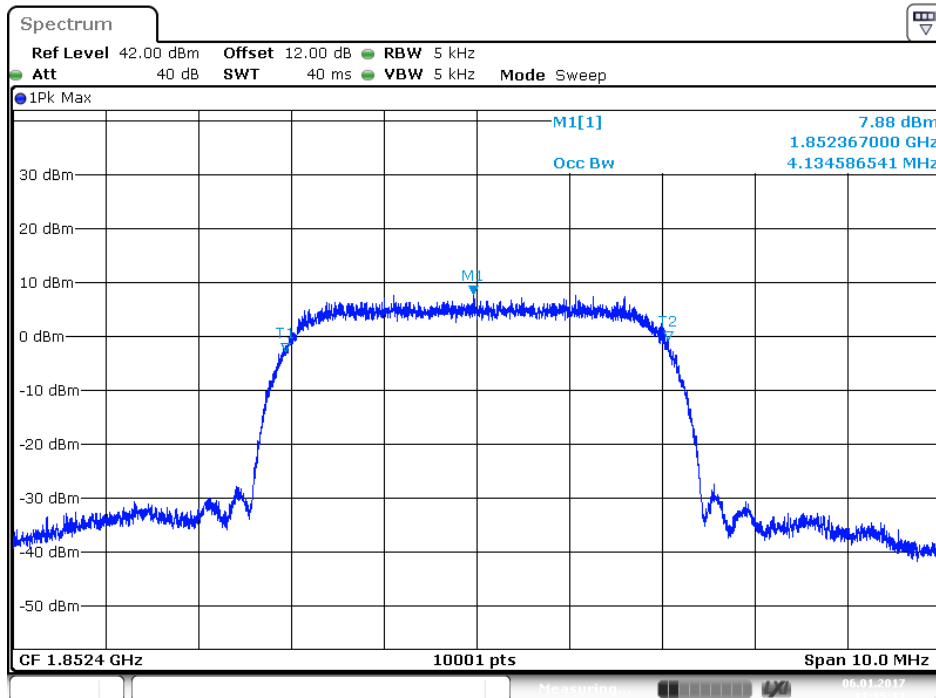

Date: 6 JAN. 2017 11:15:11

1880.0 MHz (-26dB BW)

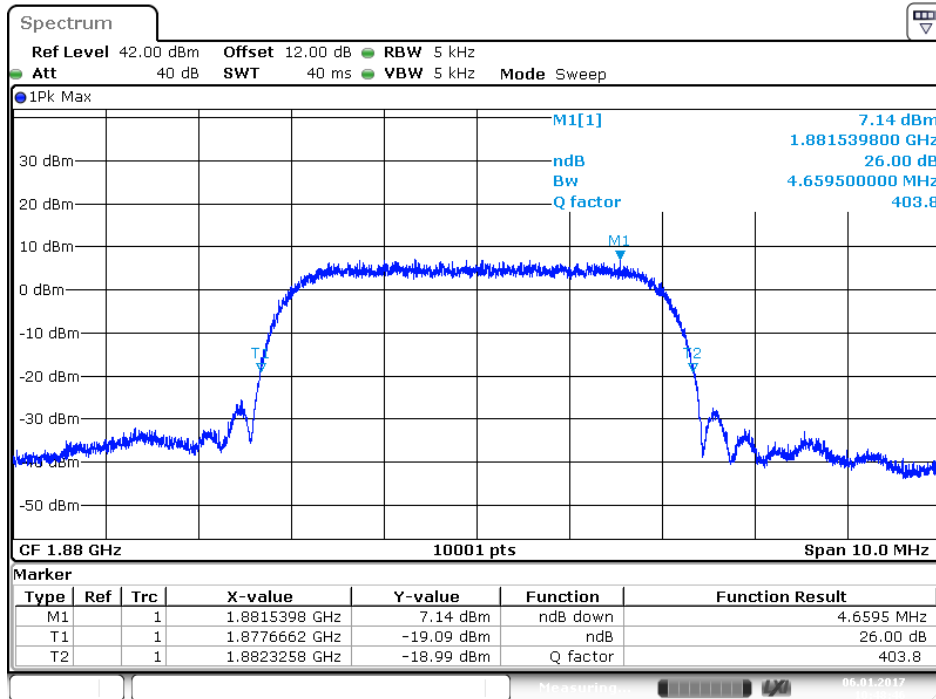

1880.0 MHz (99% BW)

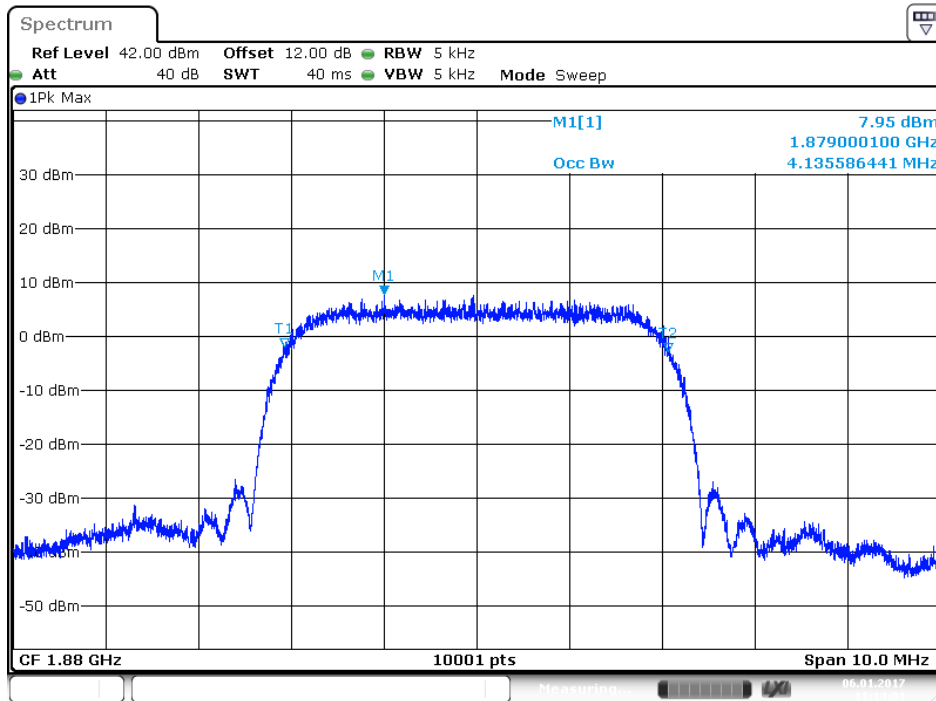

1907.6 MHz (-26dB BW)

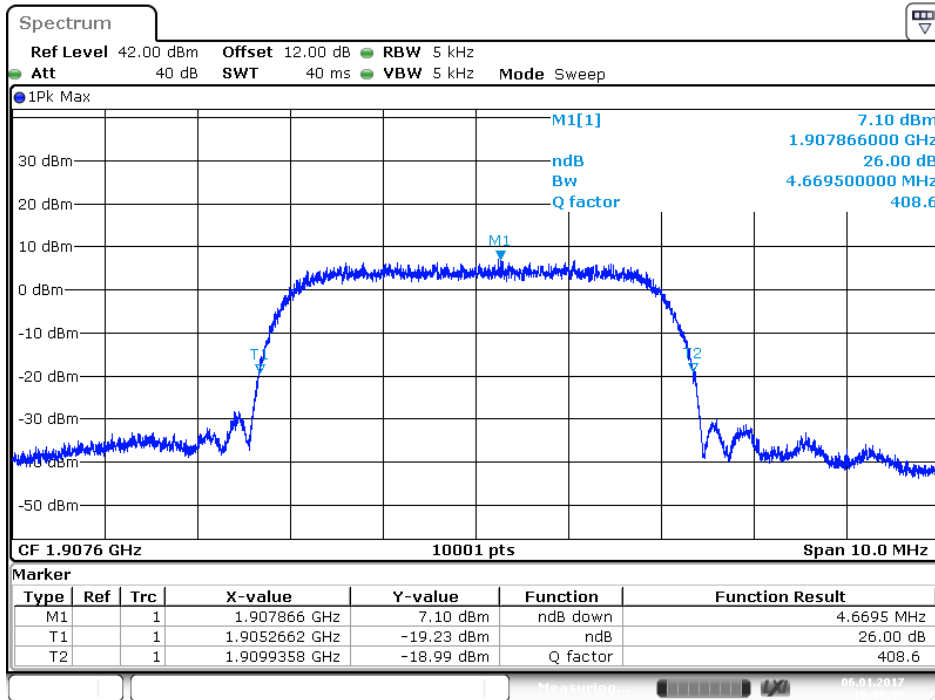

1907.6 MHz (99% BW)

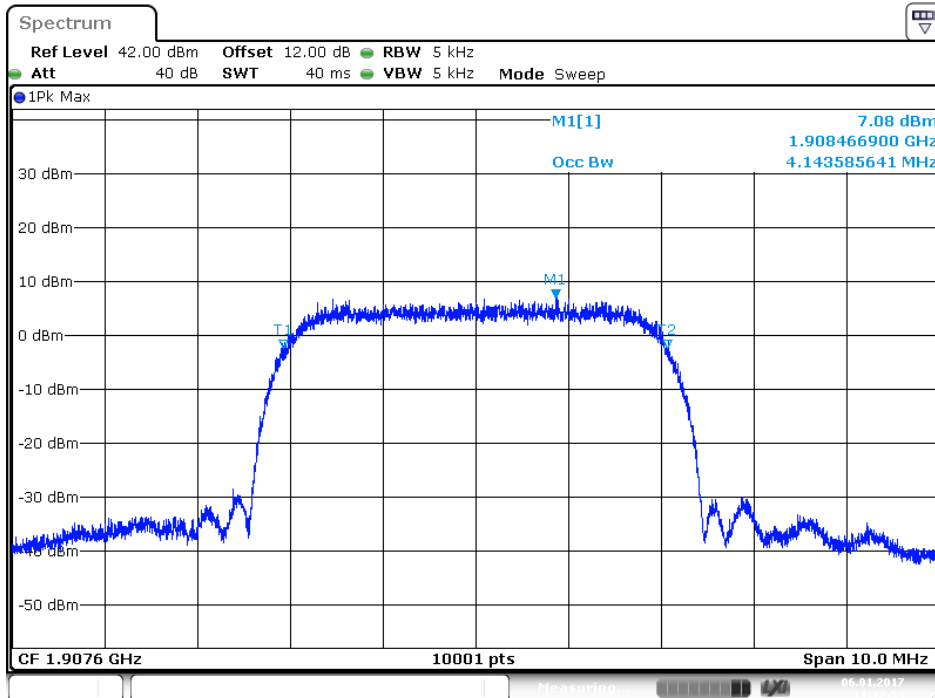

Product	LE910C1-NA		
Test Item	Occupied Bandwidth		
Test Mode	Mode 13: WCDMA Band 5_HSUPA Mode		
Date of Test	2017/02/23	Test Site	SR10-H

Frequency (MHz)	-26dB BW Measure Level (MHz)	99% BW Measure Level (MHz)	Limit (MHz)
826.4	4.665	4.123	N/A
836.6	4.674	4.143	N/A
846.6	4.659	4.125	N/A

826.4 MHz (-26dB BW)

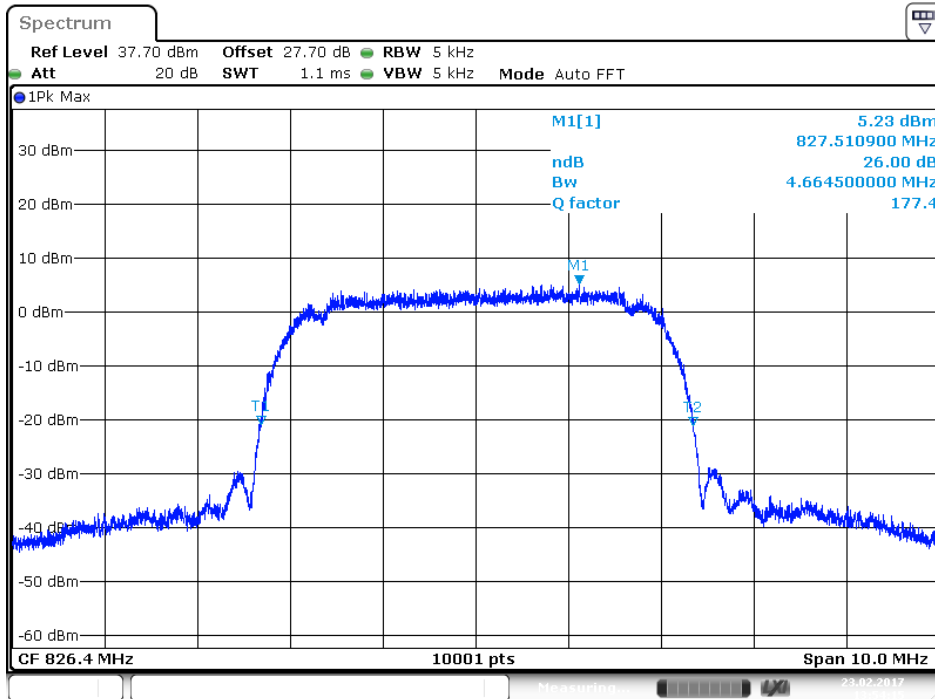

Date: 23.FEB.2017 13:54:15

826.4 MHz (99% BW)

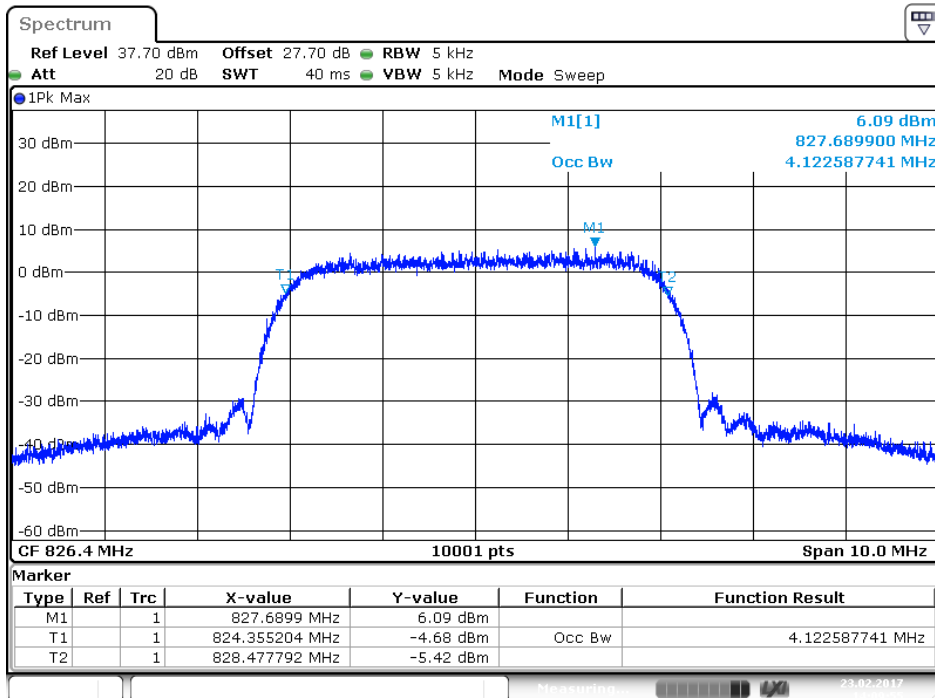

Date: 23.FEB.2017 14:09:56

836.6 MHz (-26dB BW)

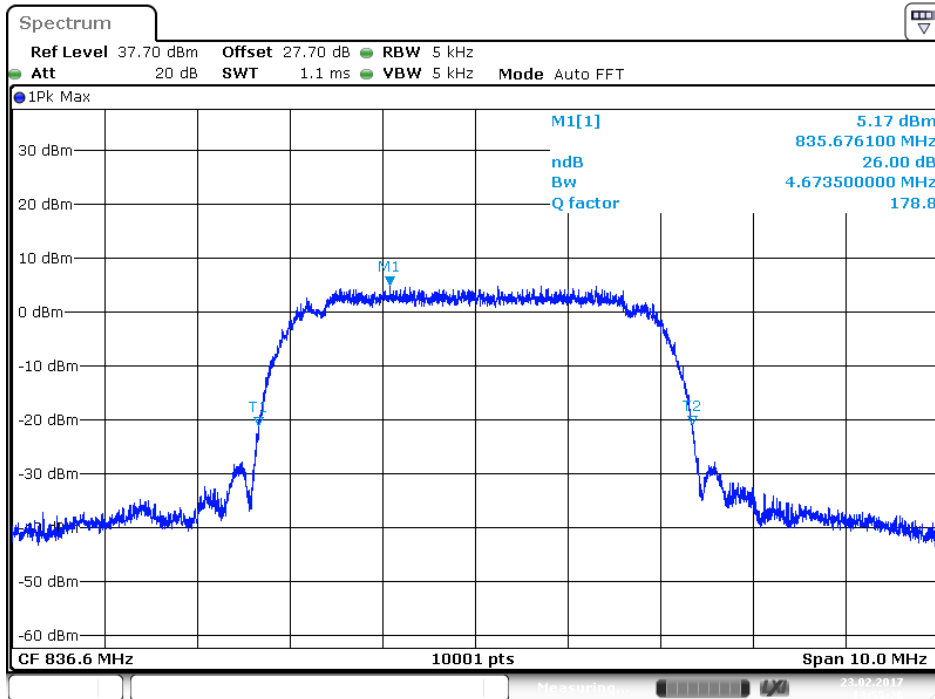

Date: 23.FEB.2017 13:55:27

836.6 MHz (99% BW)

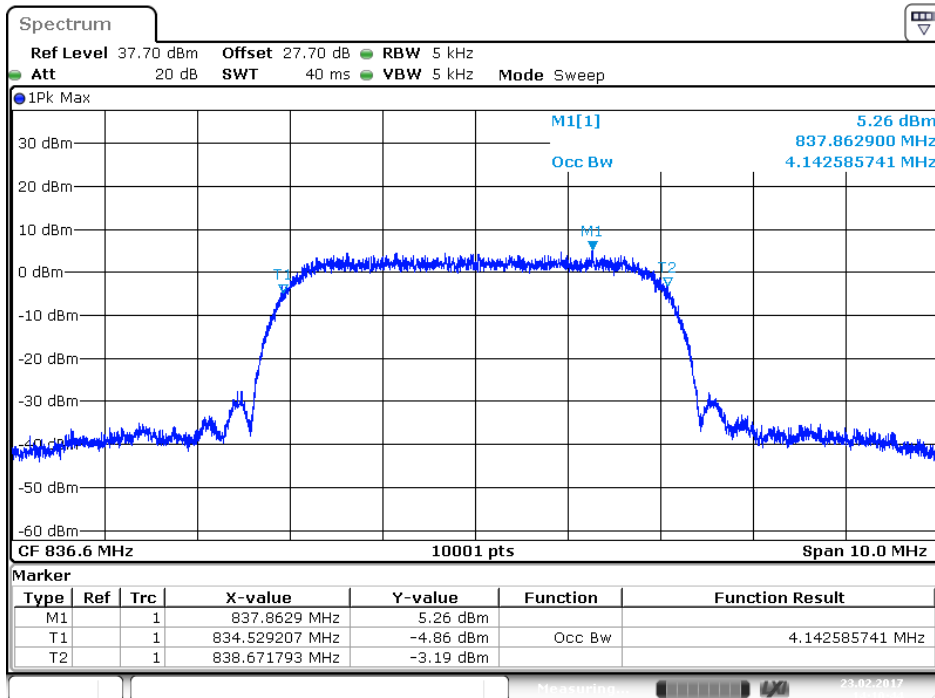

Date: 23.FEB.2017 14:10:44

846.6 MHz (-26dB BW)

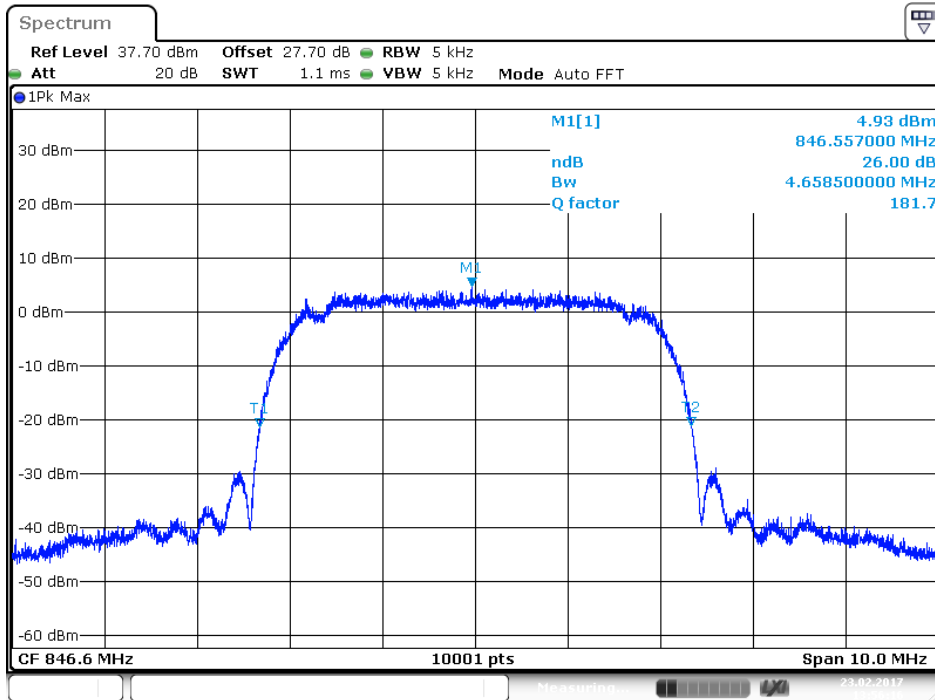

Date: 23.FEB.2017 13:56:16

846.6 MHz (99% BW)

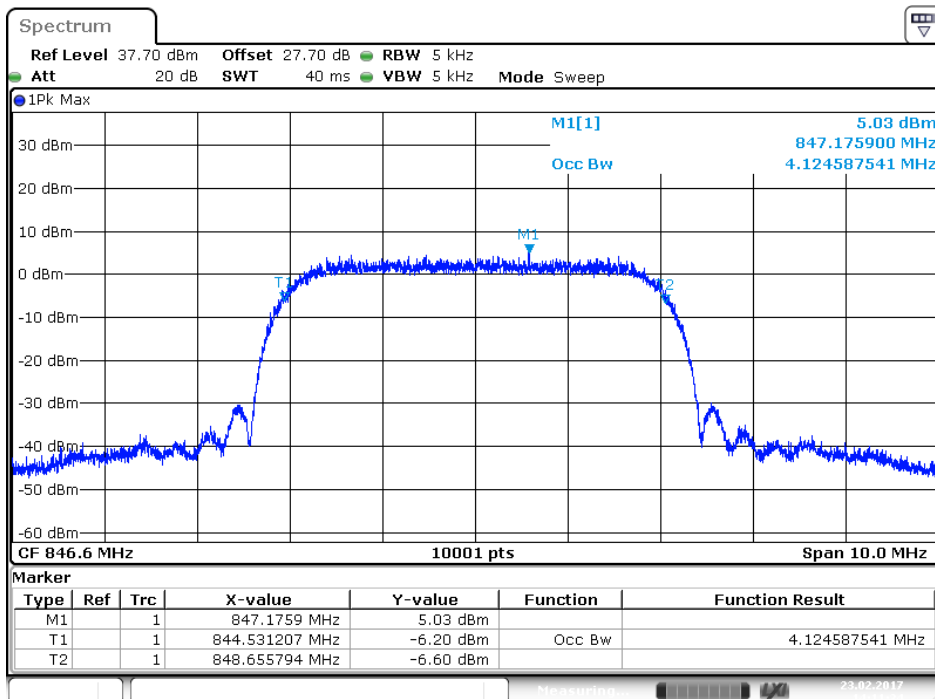

Date: 23.FEB.2017 14:11:33

Product	LE910C1-NA		
Test Item	Occupied Bandwidth		
Test Mode	Mode 14: WCDMA Band 5_HSDPA Mode		
Date of Test	2017/01/06	Test Site	SR10-H

Frequency (MHz)	-26dB BW Measure Level (MHz)	99% BW Measure Level (MHz)	Limit (MHz)
826.4	4.642	4.130	N/A
836.6	4.674	4.147	N/A
846.6	4.627	4.122	N/A

826.4 MHz (-26dB BW)

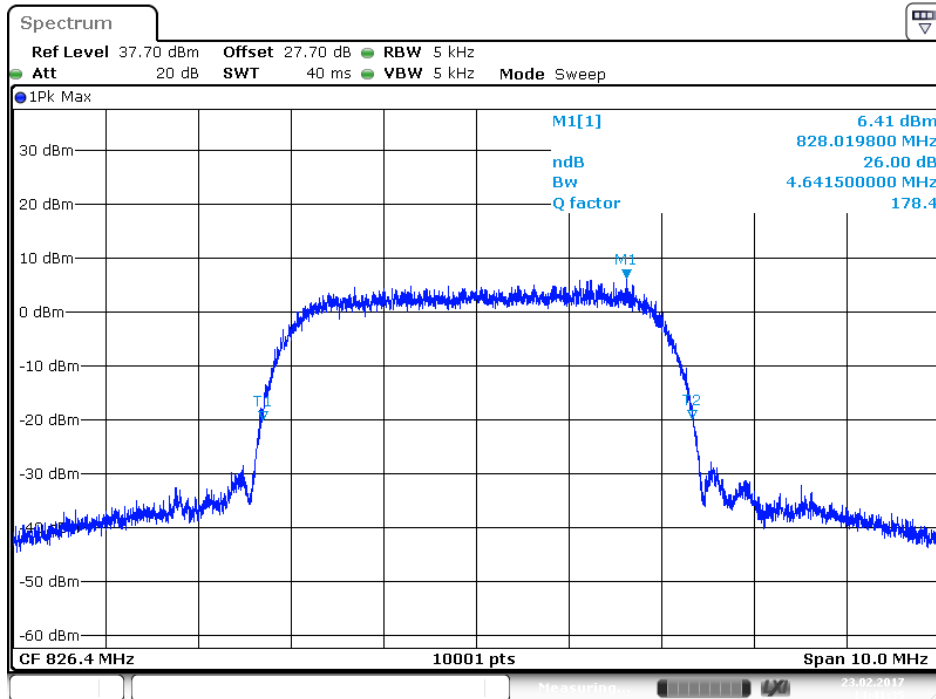

Date: 23.FEB.2017 14:41:34

826.4 MHz (99% BW)

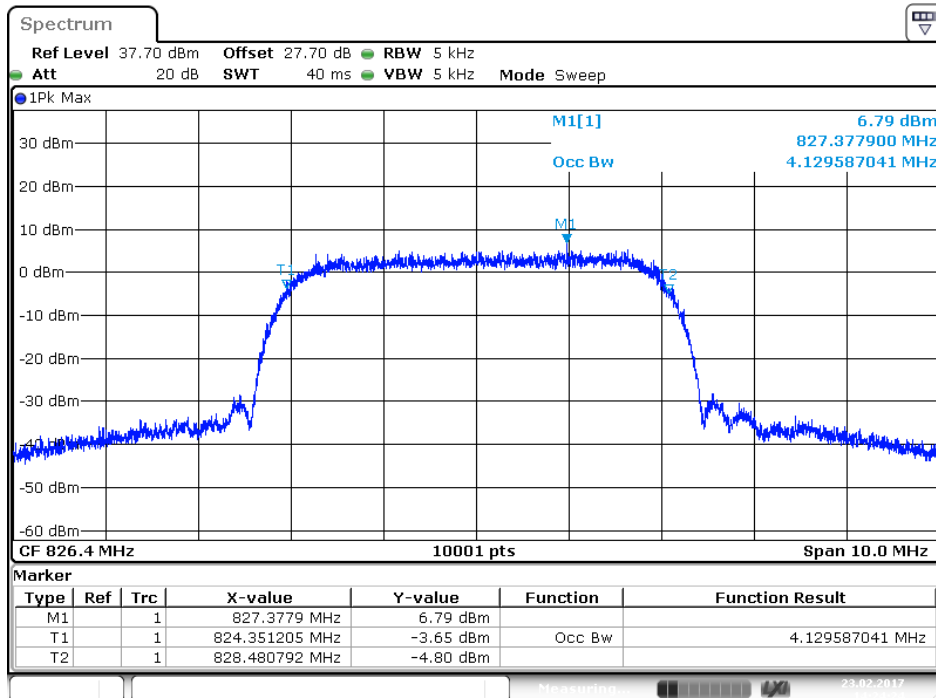

Date: 23.FEB.2017 14:24:24

836.6 MHz (-26dB BW)

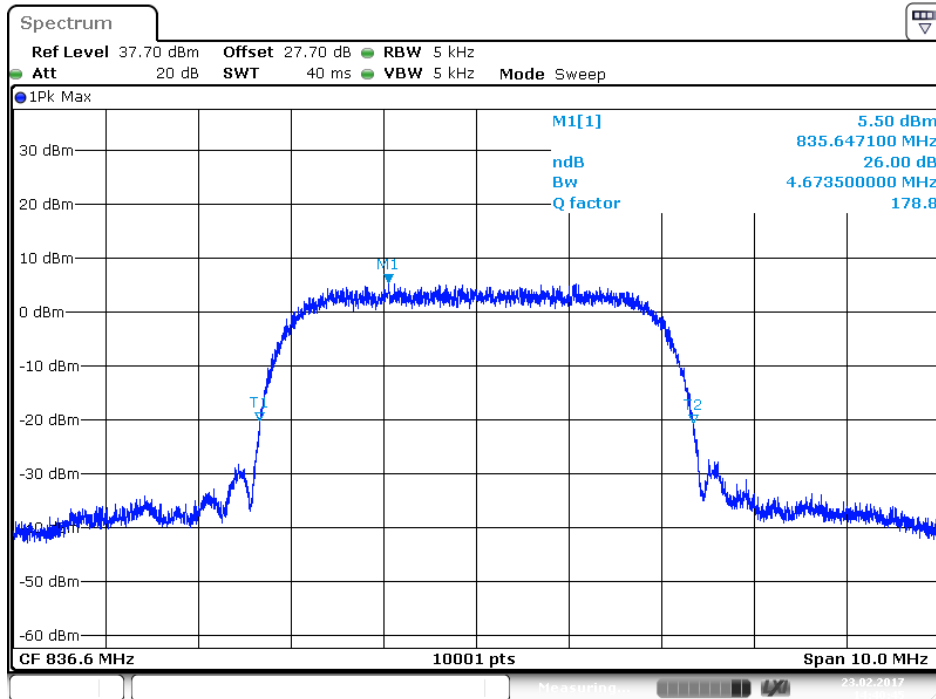

Date: 23.FEB.2017 14:40:45

836.6 MHz (99% BW)

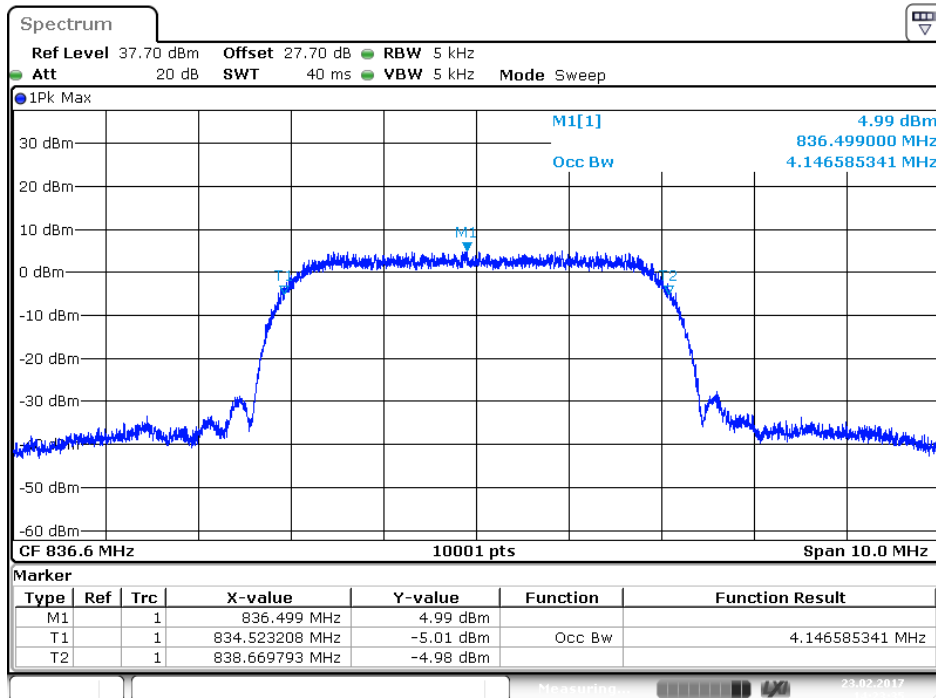

Date: 23.FEB.2017 14:23:34

846.6 MHz (-26dB BW)

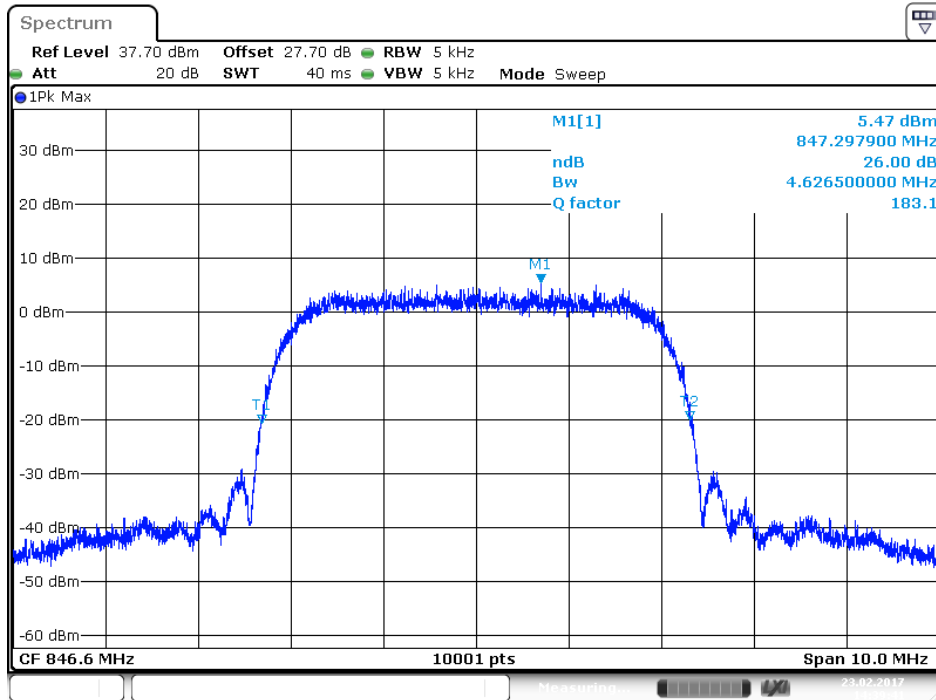

Date: 23.FEB.2017 14:39:41

846.6 MHz (99% BW)

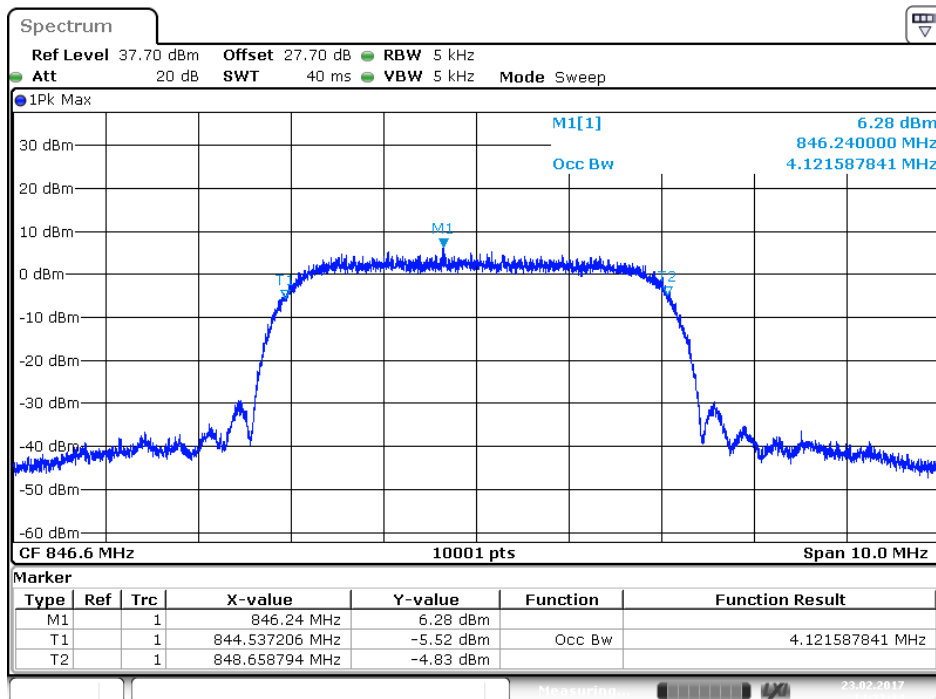

Date: 23.FEB.2017 14:22:34

Product	LE910C1-NA		
Test Item	Occupied Bandwidth		
Test Mode	Mode 15: WCDMA Band 2_HSUPA Mode		
Date of Test	2017/02/23	Test Site	SR10-H

Frequency (MHz)	-26dB BW Measure Level (MHz)	99% BW Measure Level (MHz)	Limit (MHz)
1852.4	4.662	4.127	N/A
1880.0	4.655	4.127	N/A
1907.6	4.648	4.135	N/A

1852.4 MHz (-26dB BW)

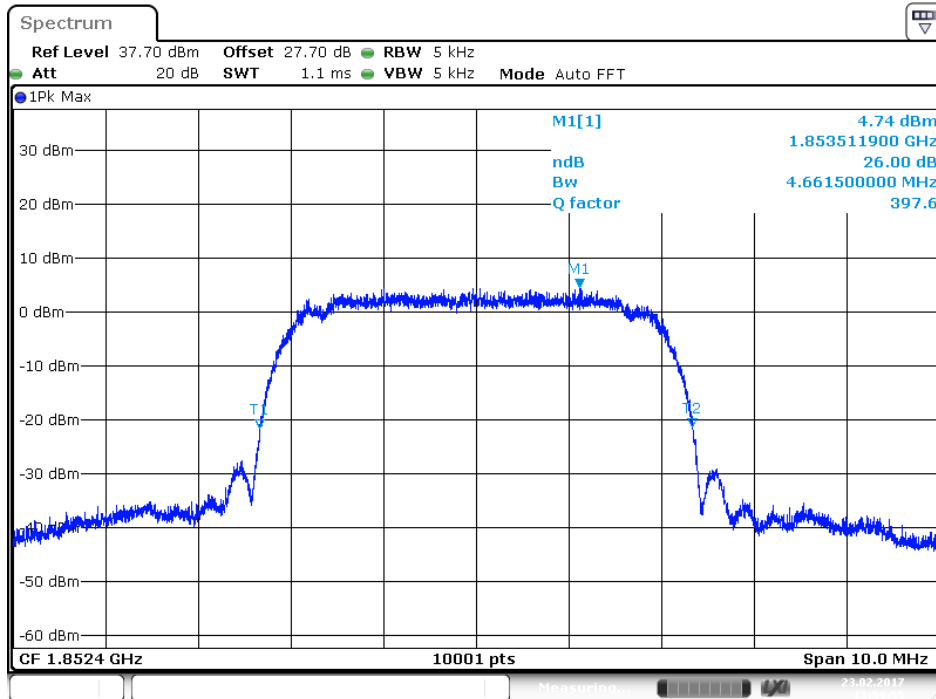

1852.4 MHz (99% BW)

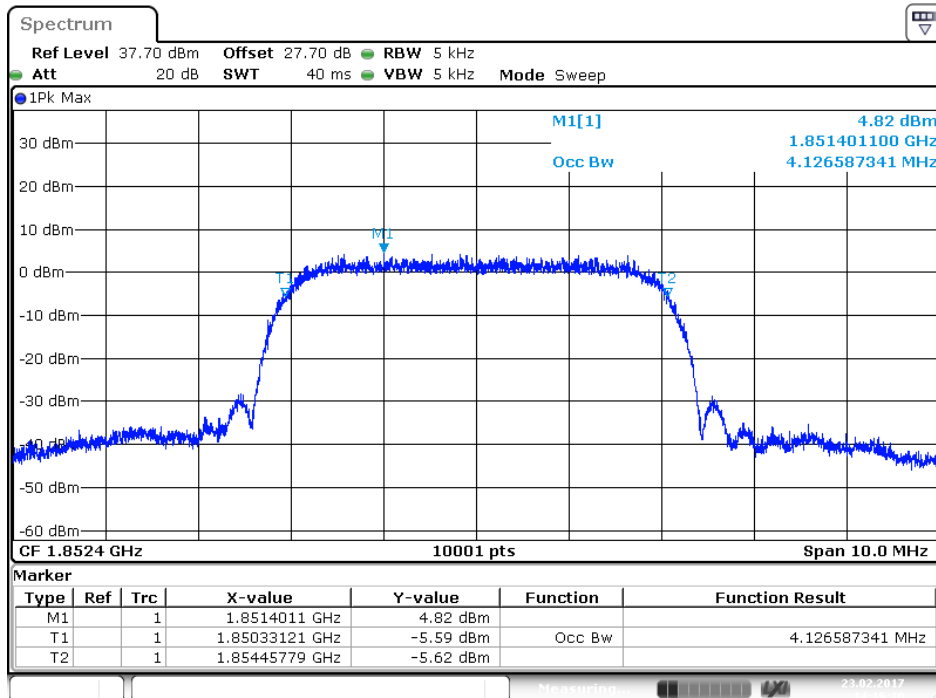

1880.0 MHz (-26dB BW)

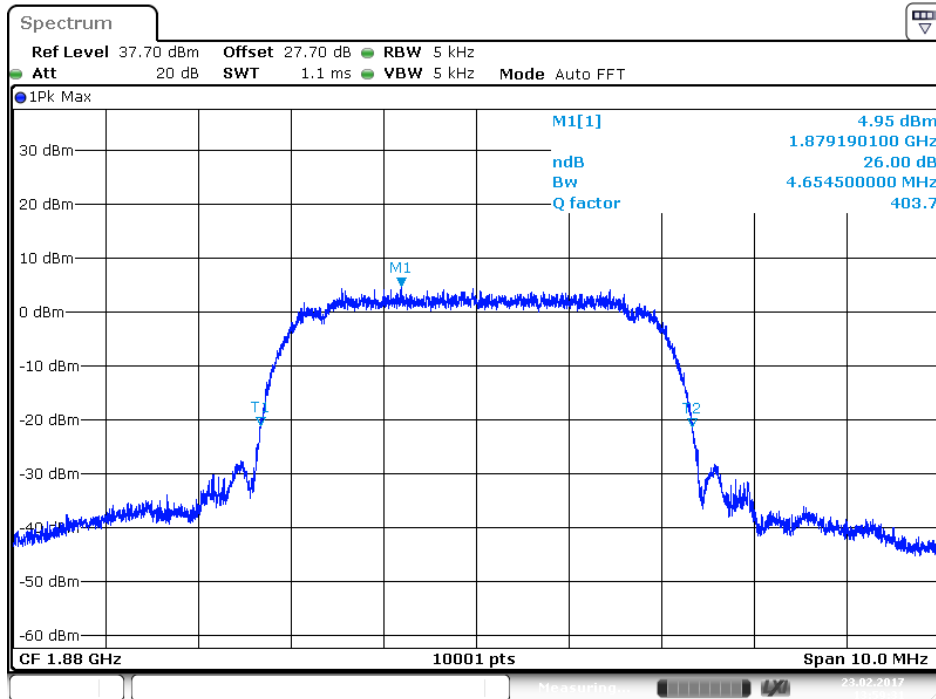

Date: 23.FEB.2017 13:59:31

1880.0 MHz (99% BW)

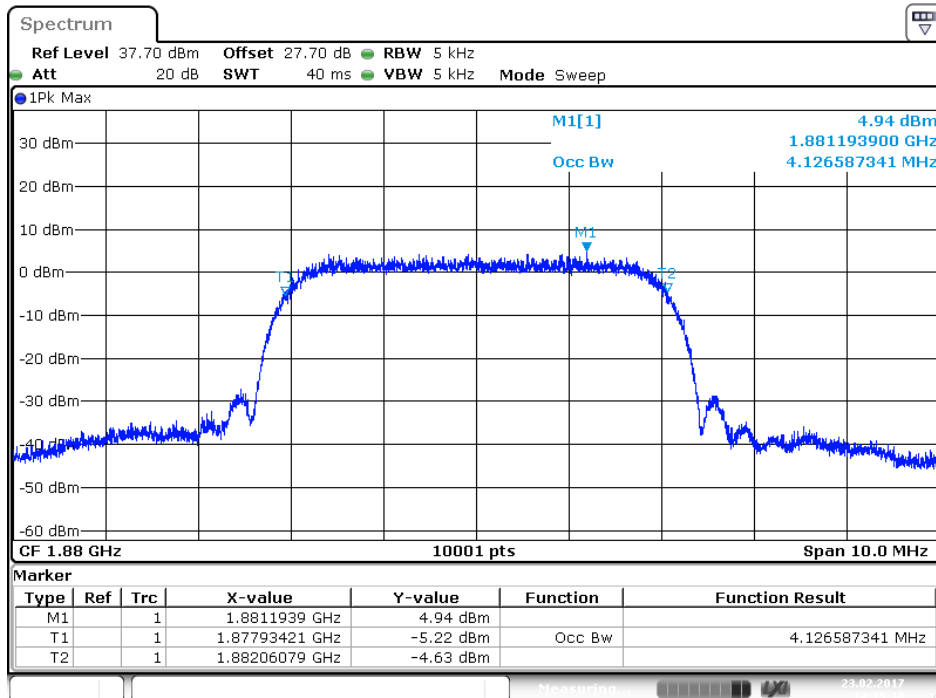

Date: 23.FEB.2017 14:15:10

1907.6 MHz (-26dB BW)

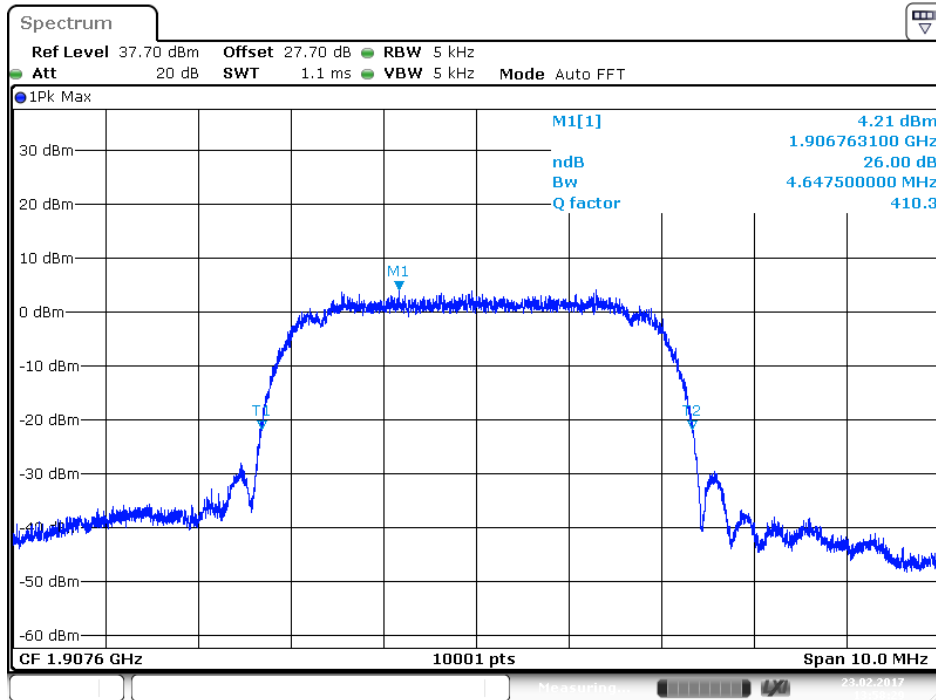

Date: 23.FEB.2017 13:58:29

1907.6 MHz (99% BW)

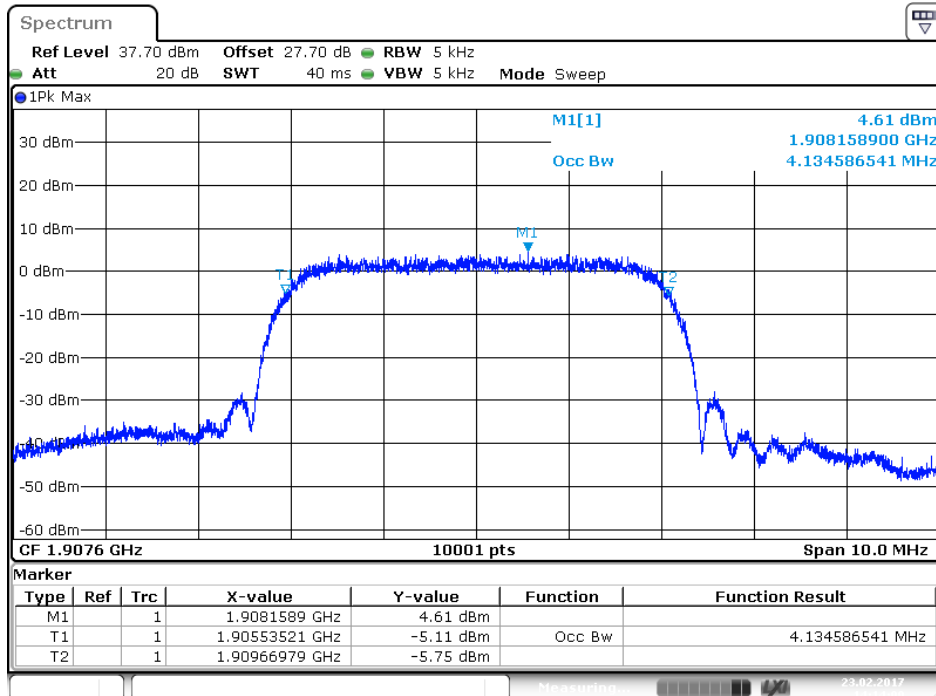

Date: 23.FEB.2017 14:14:09

Product	LE910C1-NA		
Test Item	Occupied Bandwidth		
Test Mode	Mode 16: WCDMA Band 2_HSDPA Mode		
Date of Test	2017/02/23	Test Site	SR10-H

Frequency (MHz)	-26dB BW Measure Level (MHz)	99% BW Measure Level (MHz)	Limit (MHz)
1852.4	4.646	4.128	N/A
1880.0	4.628	4.127	N/A
1907.6	4.645	4.127	N/A

1852.4 MHz (-26dB BW)

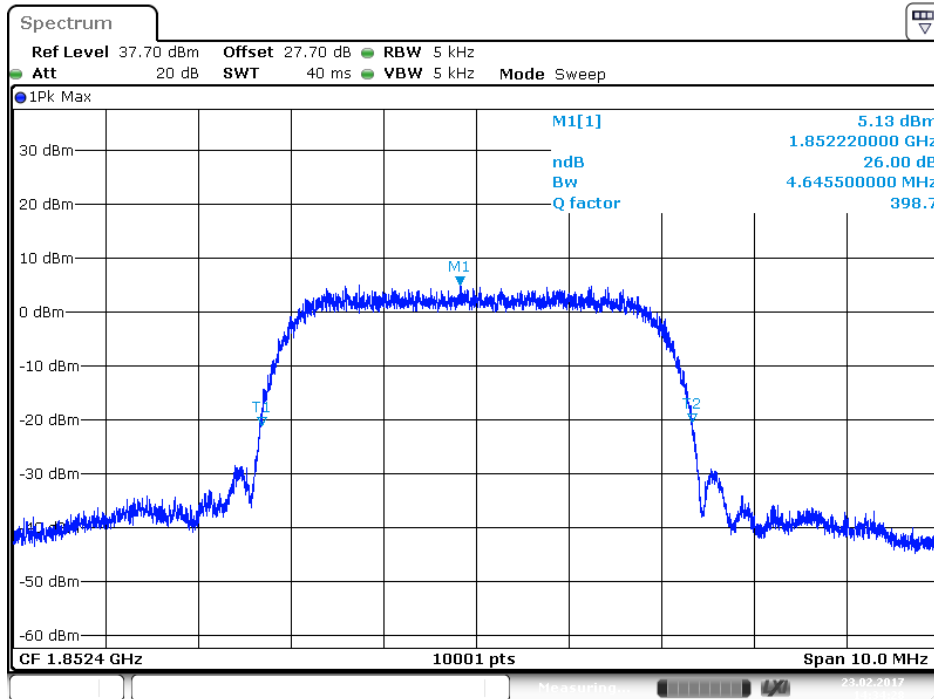

1852.4 MHz (99% BW)

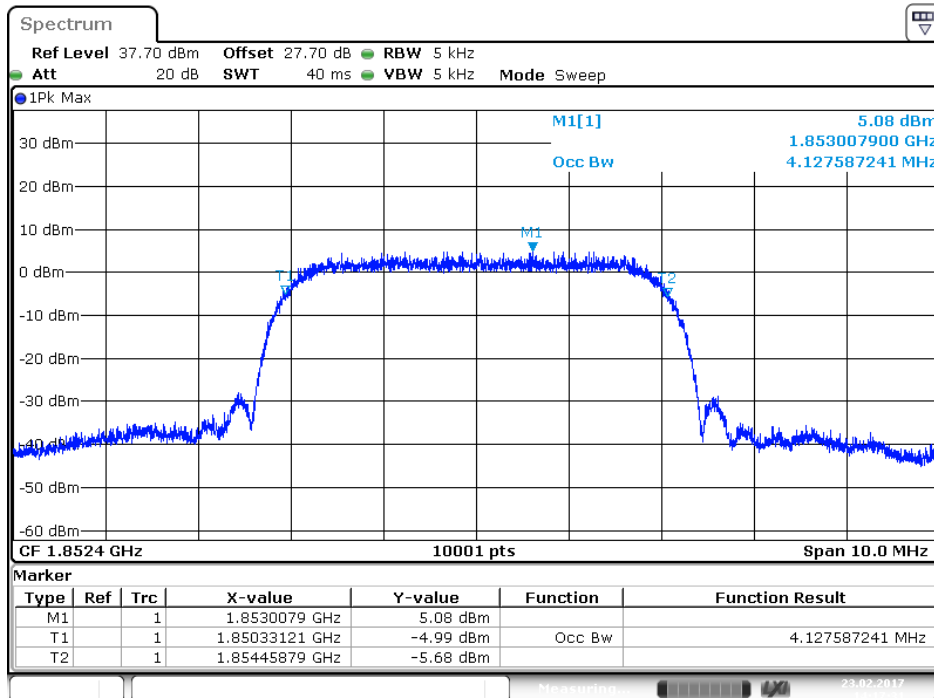

1880.0 MHz (-26dB BW)

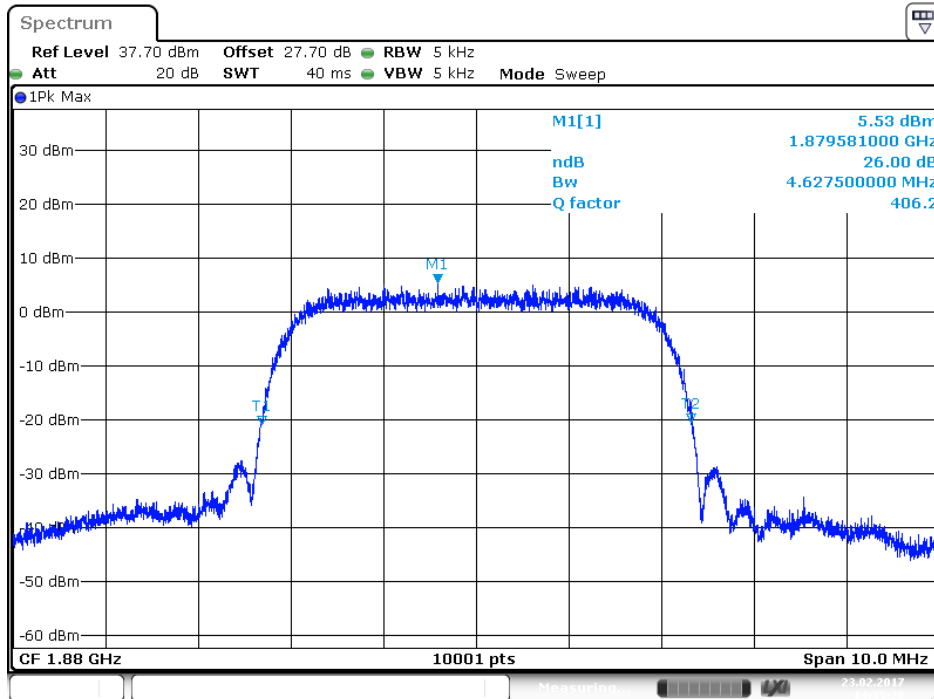

1880.0 MHz (99% BW)

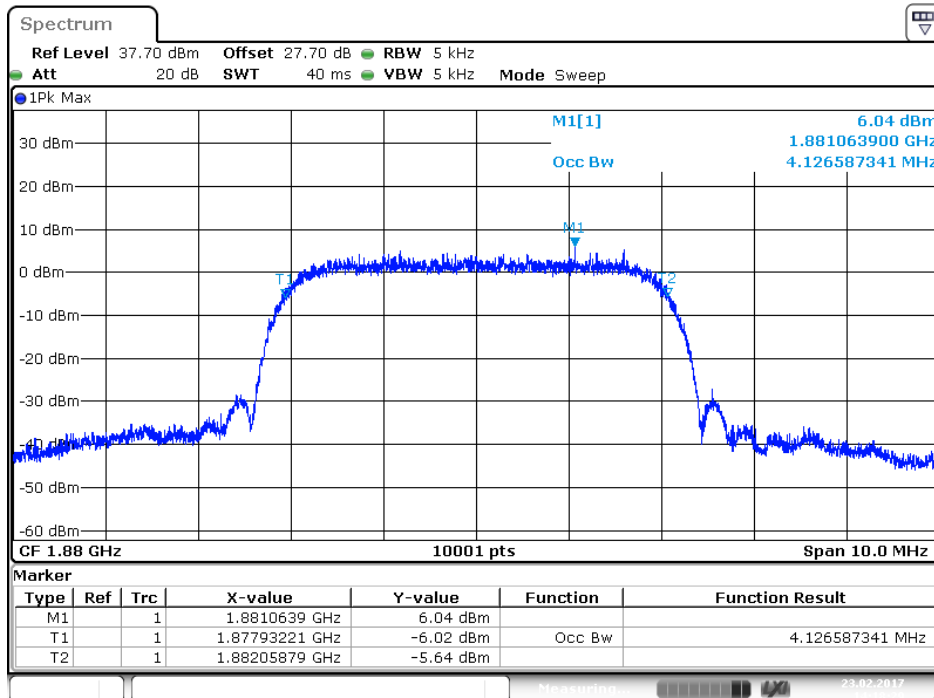

1907.6 MHz (-26dB BW)

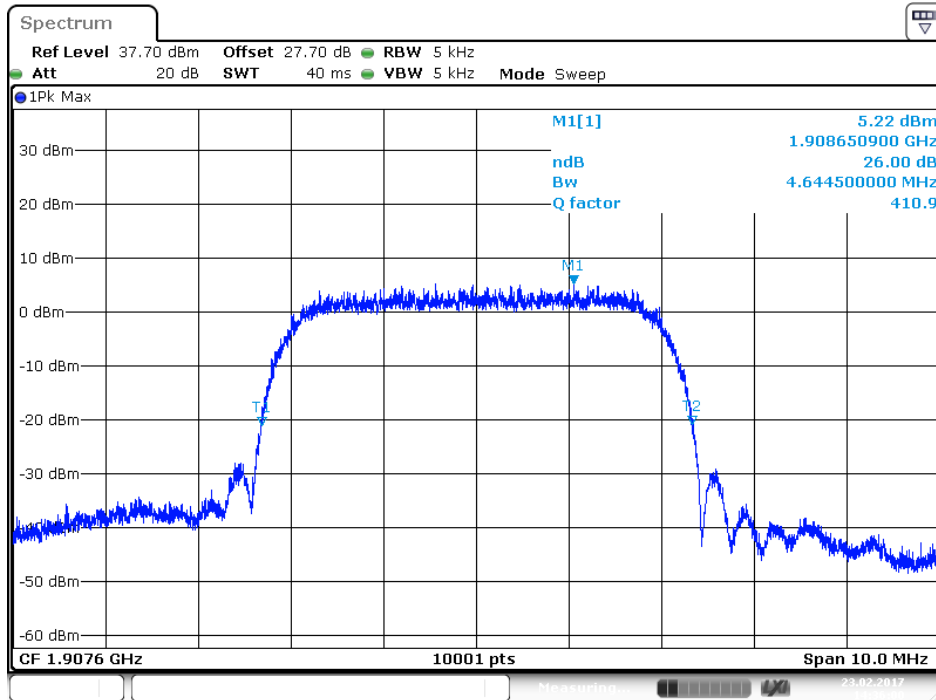

1907.6 MHz (99% BW)

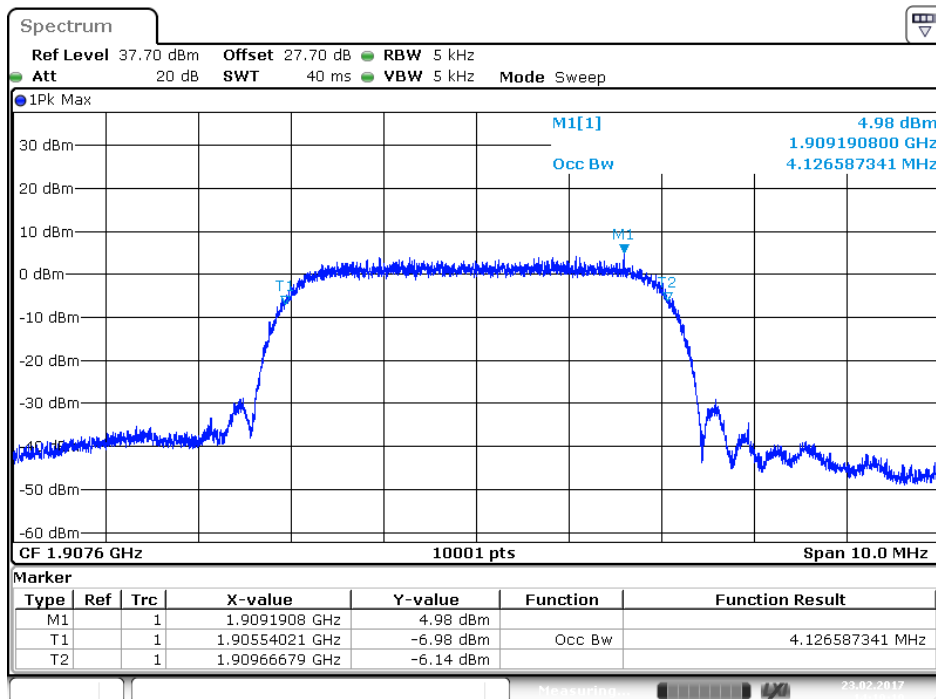

5. Spurious Emission At Antenna Terminals (+/- 1MHz)

5.1. Test Equipment

The following test equipments are used during the RF power output tests:

Spurious Emission At Antenna Terminals (+/- 1MHz)/ SR10-H

Instrument	Manufacturer	Model No.	Serial No	Next Cal. Date
Signal & Spectrum Analyzer	R&S	FSVA40	101455	2017/11/27
Multisystem UE Tester	Japan radio	NJZ-2000	ET00477	2017/09/19
Directional coupler	Agilent	778D	20402	2017/10/06

Note: All equipments upon which need to be calibrated are with calibration period of 1 year.

5.2. Test Setup

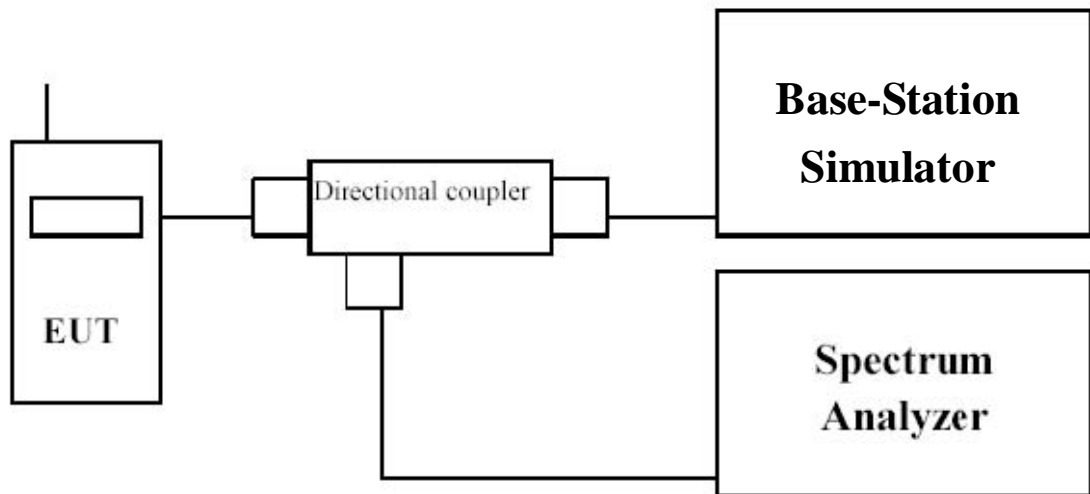

5.3. Limit

The power of any emission outside of the authorized operating frequency ranges must be attenuated below the transmitting power (P) by a factor of at least $43 + 10\log(P)$ dB.

5.4. Test Procedure

In the 1MHz bands immediately outside and adjacent to the frequency block a resolution bandwidth of at least one percent of the emission bandwidth of the fundamental emission of the transmitter may be employed to measure the out of band Emissions.

5.5. Uncertainty

The measurement uncertainty is defined as ± 1.2 dB.

5.6. Test Result

Product	LE910C1-NA		
Test Item	Spurious Emission At Antenna Terminals (+/- 1MHz)		
Test Mode	Mode 1: GSM 850_Link Mode		
Date of Test	2017/01/09	Test Site	SR10-H

824.2 MHz

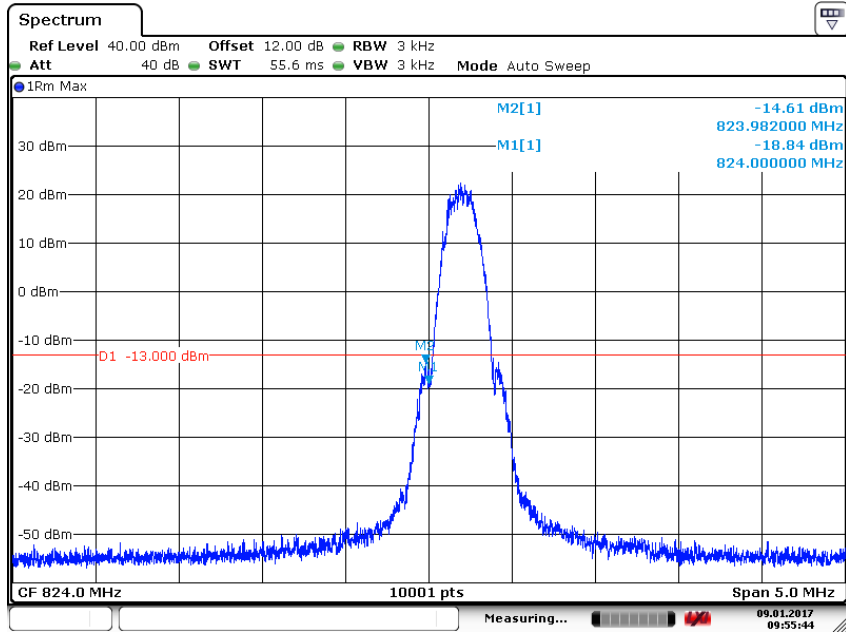

Date: 9 JAN 2017 09:55:44

848.8 MHz

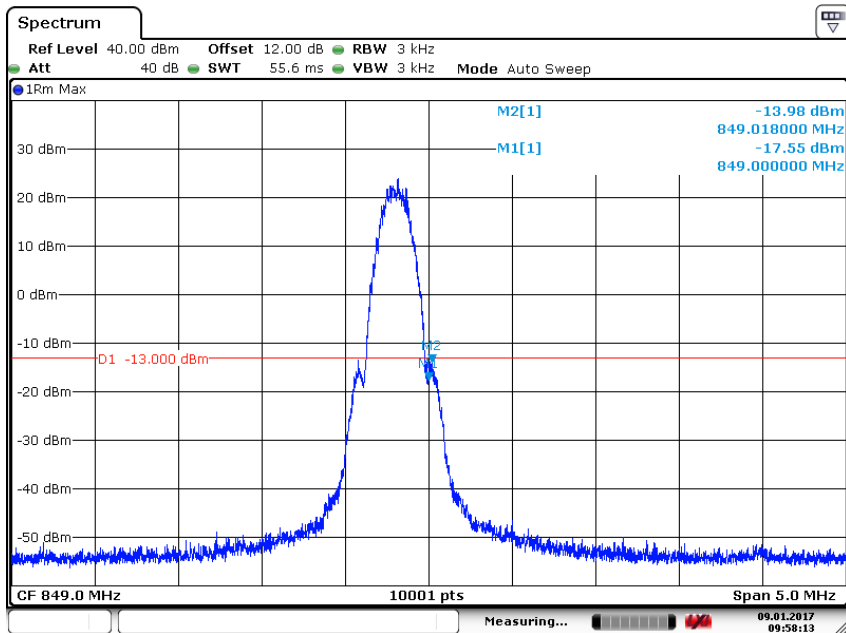

Date: 9 JAN 2017 09:58:13

Product	LE910C1-NA		
Test Item	Spurious Emission At Antenna Terminals (+/- 1MHz)		
Test Mode	Mode 3: DCS 1900_Link Mode		
Date of Test	2017/01/09	Test Site	SR10-H

1850.2 MHz

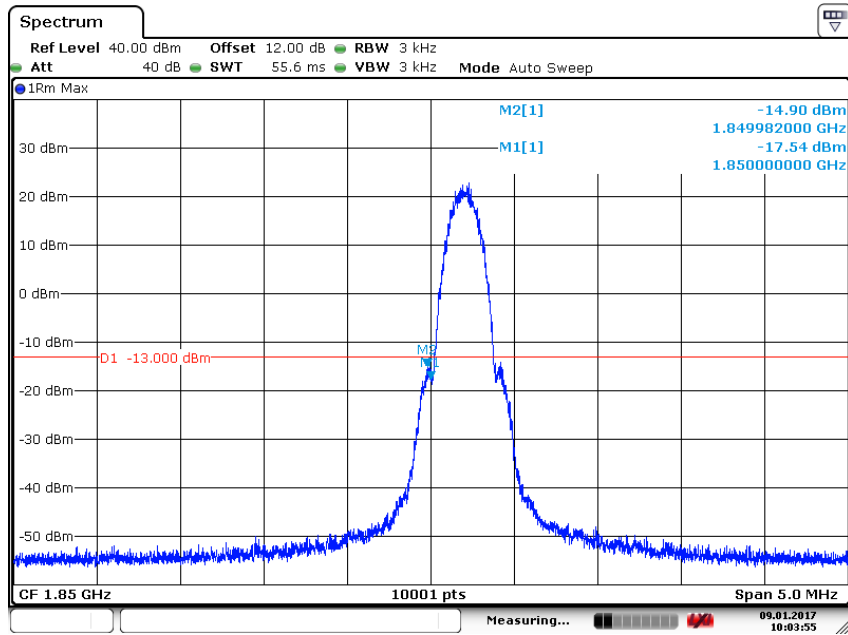

Date: 9 JAN 2017 10:03:56

1909.8 MHz

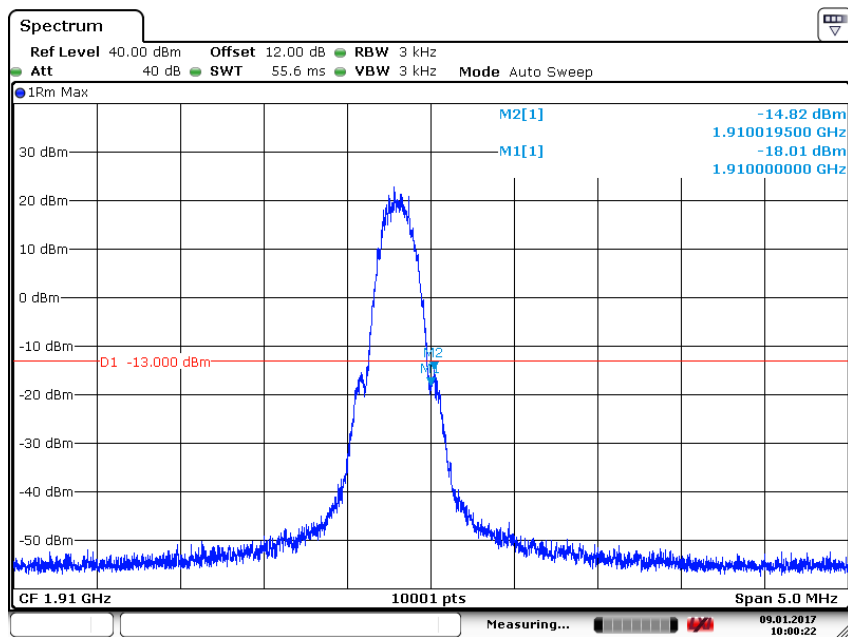

Date: 9 JAN 2017 10:00:23

Product	LE910C1-NA		
Test Item	Spurious Emission At Antenna Terminals (+/- 1MHz)		
Test Mode	Mode 5: GSM_EGPRS 850_Link Mode		
Date of Test	2017/01/24	Test Site	SR10-H

824.2 MHz

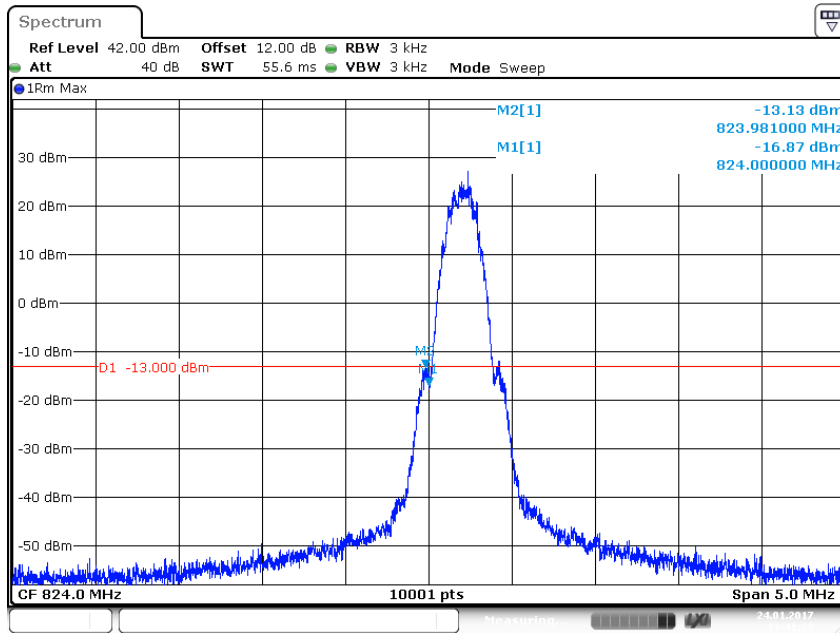

848.8 MHz

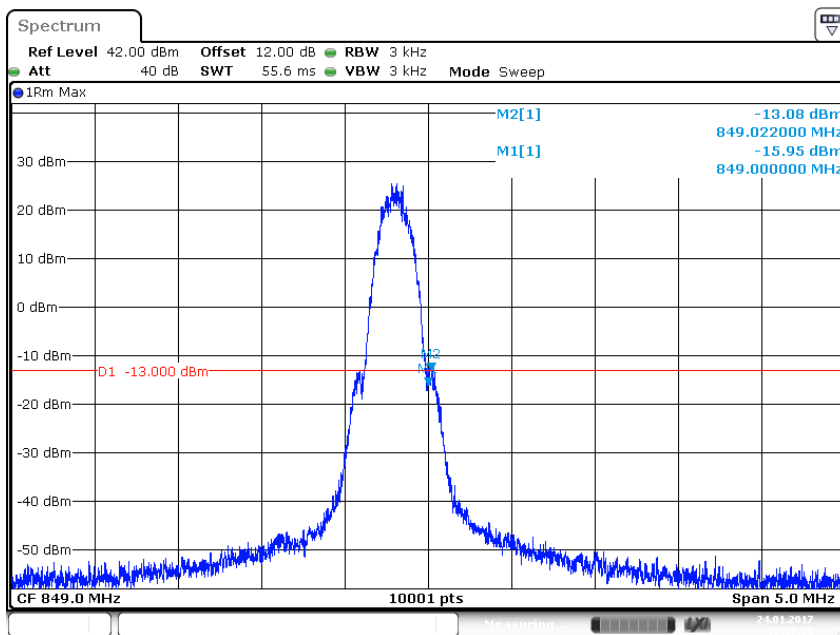

Product	LE910C1-NA		
Test Item	Spurious Emission At Antenna Terminals (+/- 1MHz)		
Test Mode	Mode 7: DCS_EGPRS 1900_Link Mode		
Date of Test	2017/01/24	Test Site	SR10-H

1850.2 MHz

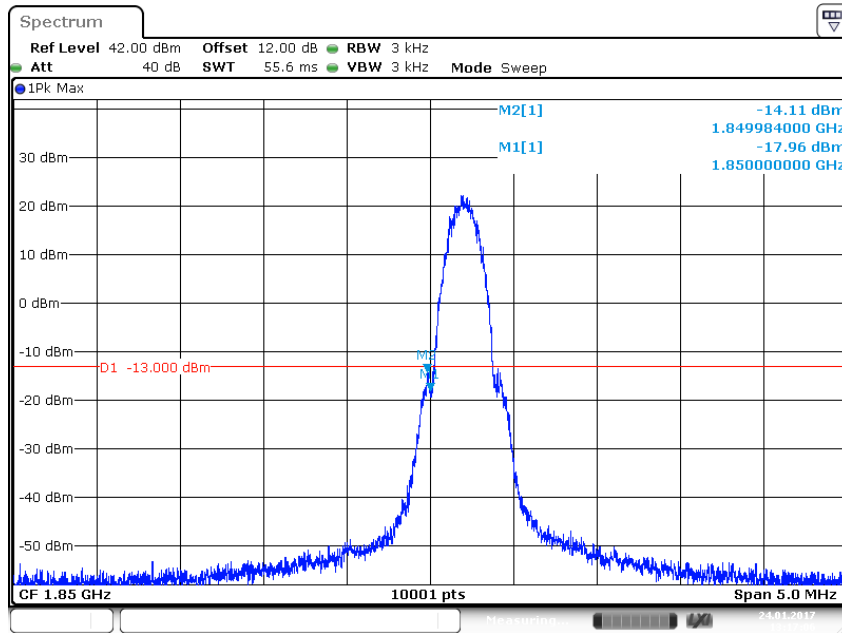

1909.8 MHz

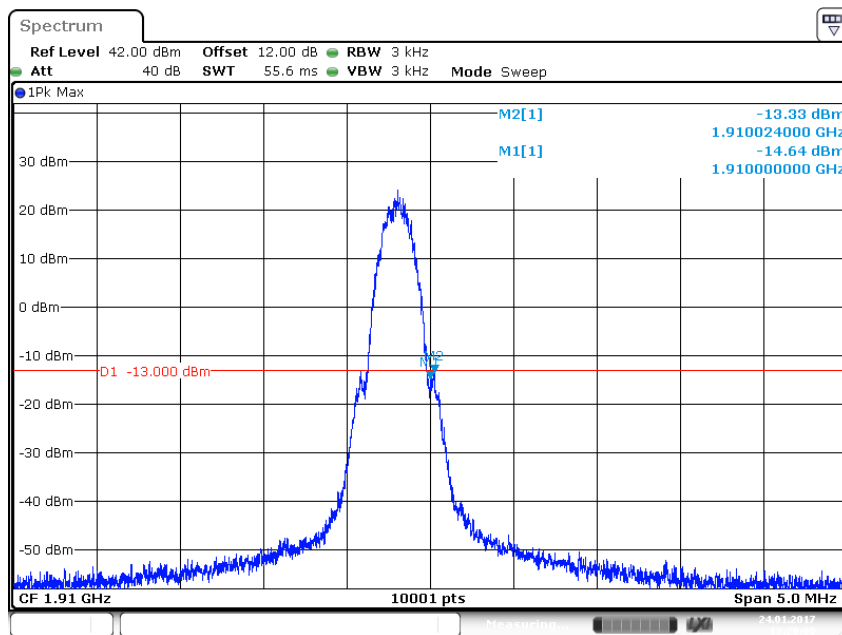

Product	LE910C1-NA		
Test Item	Spurious Emission At Antenna Terminals (+/- 1MHz)		
Test Mode	Mode 9: WCDMA Band 5_Link Mode		
Date of Test	2017/01/09	Test Site	SR10-H

826.4 MHz

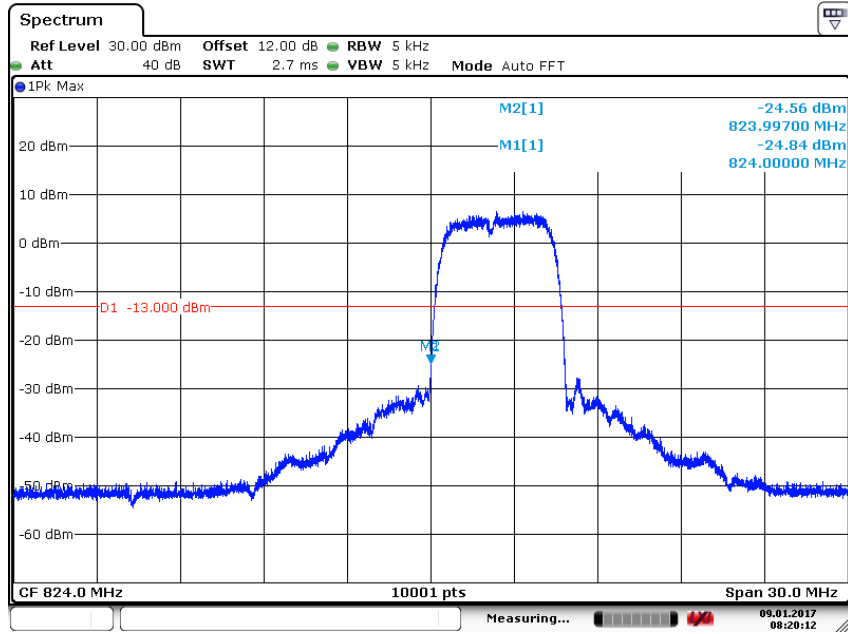

Date: 9 JAN 2017 08:20:12

846.6 MHz

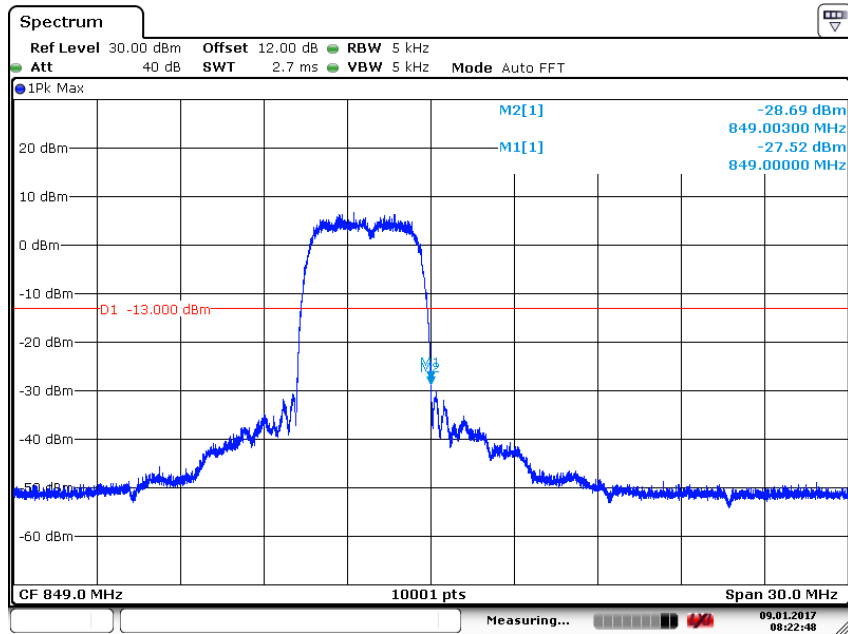

Date: 9 JAN 2017 08:22:47

Product	LE910C1-NA		
Test Item	Spurious Emission At Antenna Terminals (+/- 1MHz)		
Test Mode	Mode 11: WCDMA Band 2_Link Mode		
Date of Test	2017/01/09	Test Site	SR10-H

1852.4 MHz

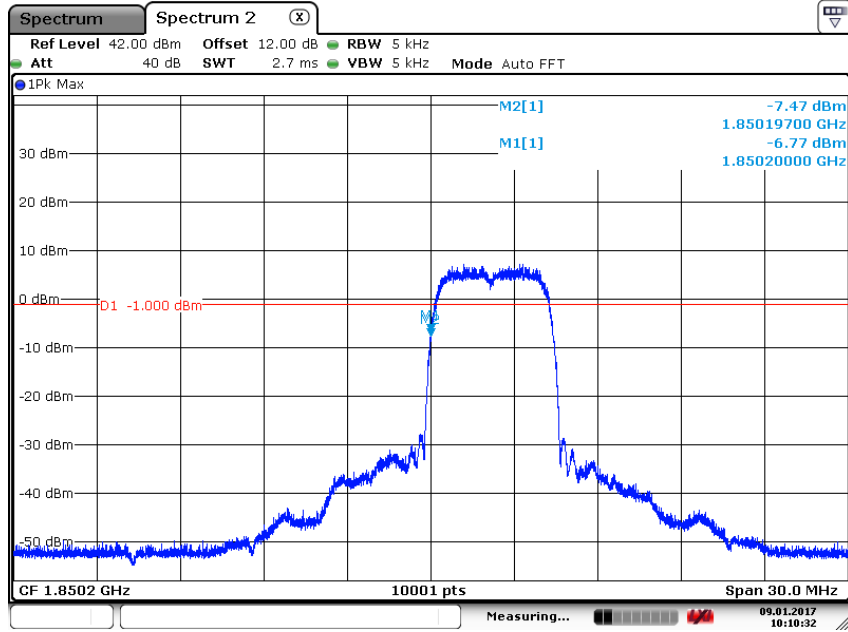

Date: 9 JAN 2017 10:10:32

1907.6 MHz

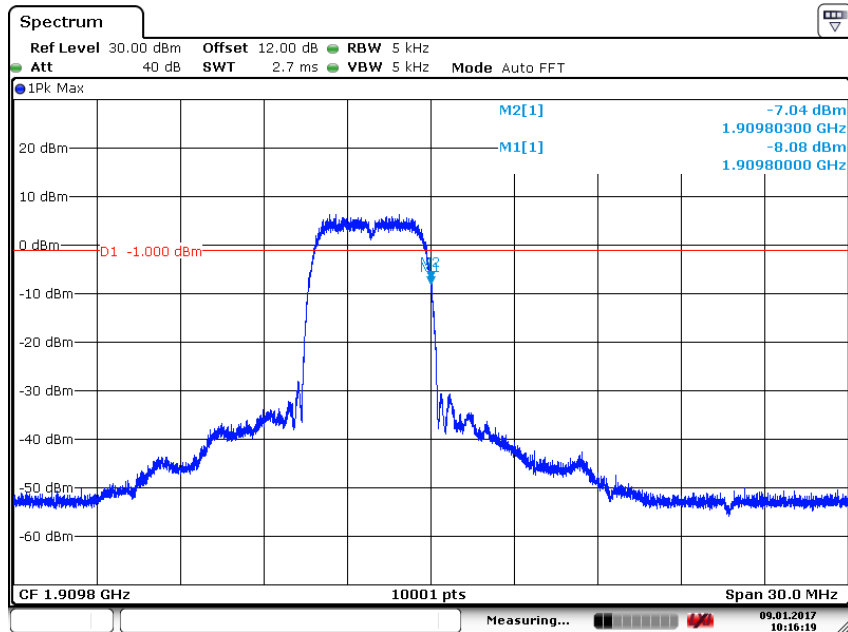

Date: 9 JAN 2017 10:16:19

6. Spurious Emission

6.1. Test Equipment

The following test equipments are used during the radiated emission test:

Conducted Spurious Emission /SR10-H

Instrument	Manufacturer	Model No.	Serial No	Next Cal. Date
Signal & Spectrum Analyzer	R&S	FSVA40	101455	2017/11/27
Multisystem UE Tester	Japan radio	NJZ-2000	ET00477	2017/09/19
Directional coupler	Agilent	778D	20402	2017/10/06

Radiated Spurious Emission /CB4-H

Instrument	Manufacturer	Model No.	Serial No	Next Cal. Date
Test Receiver	R&S	ESCS 30	836858/022	2018/01/14
Multisystem UE Tester	Japan radio	NJZ-2000	ET00477	2017/09/19
Signal & Spectrum Analyzer	R&S	FSVA40	101455	2017/11/27
Pre-Amplifier	DEKRA	AP-025C	CHM-0706049	2017/12/18
Bilog Antenna	Schaffner	CBL6112B	2797	2017/08/14
Pre-Amplifier	EMCI	EMC0031835	980233	2018/02/02
Horn Antenna	Schwarzbeck	BBHA 9120	D639	2017/06/29

Note: 1. All equipments that need to be calibrated are with calibration period of 1 year.

2. EIRP = Substitution Level + Substitution Antenna Gain - Cable Loss.

6.2. Test Setup

Conducted Spurious Measurement:

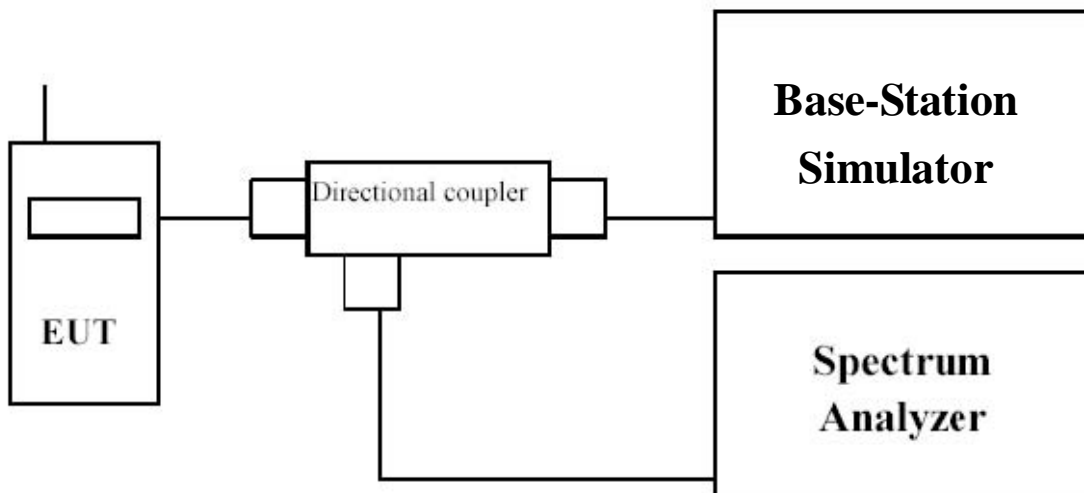

Radiated Spurious Measurement:

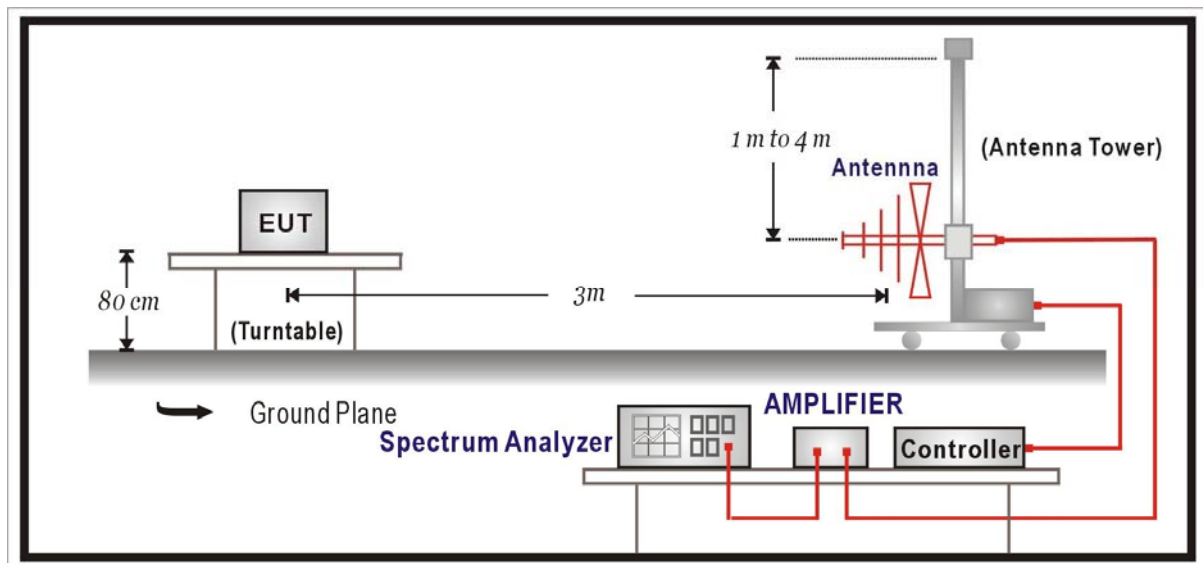

6.3. Limit

The power of any emission outside of the authorized operating frequency ranges must be attenuated below the transmitting power (P) by a factor of at least $43 + 10\log(P)$ dB.

6.4. Test Procedure

Conducted Spurious Measurement:

- Place the EUT on a bench and set it in transmitting mode.
- Connect a low loss RF cable from the antenna port to a spectrum analyzer and BASE STATION SIMULATOR by a Directional Couple.
- EUT Communicate with BASE STATION SIMULATOR then selects a channel for testing.
- Add a correction factor to the display of spectrum, and then test.
- The resolution bandwidth of the spectrum analyzer was set at 1 MHz, sufficient scans were taken to show the out of band Emission if any up to 10th harmonic.

Radiated Spurious Measurement:

- The measurement is divided into the Preliminary Measurement and the Final Measurement. The suspected frequencies are searched for in Preliminary Measurement with the measurement antenna kept pointed at the source of the emission both in azimuth and elevation, with the polarization of the antenna oriented for maximum response. The antenna is pointed at an angle towards the source of the emission, and the EUT is rotated in both height and polarization to maximize the measured emission. The emission is kept within the illumination area of the 3 dB bandwidth of the antenna. The worst radiated emission is measured on the Final Measurement.

- b) The EUT shall be placed at the specified height on a support, and in the position closest to normal use as declared by provider.
- c) The test antenna shall be oriented initially for vertical polarization and shall be chosen to correspond to the frequency of the transmitter
- d) The output of the test antenna shall be connected to the measuring receiver.
- e) The transmitter shall be switched on and the measuring receiver shall be tuned to the frequency of the transmitter under test.
- f) The test antenna shall be raised and lowered through the specified range of height until a maximum signal level is detected by the measuring receiver.
- g) The transmitter shall then be rotated through 360° in the horizontal plane, until the maximum signal level is detected by the measuring receiver.
- h) The test antenna shall be raised and lowered again through the specified range of height until a maximum signal level is detected by the measuring receiver.
- i) The maximum signal level detected by the measuring receiver shall be noted.
- j) The transmitter shall be replaced by a substitution antenna.
- k) The substitution antenna shall be orientated for vertical polarization and the length of the substitution antenna shall be adjusted to correspond to the frequency of the transmitter.
- l) The substitution antenna shall be connected to a calibrated signal generator.
- m) If necessary, the input attenuator setting of the measuring receiver shall be adjusted in order to increase the sensitivity of the measuring receiver.
- n) The test antenna shall be raised and lowered through the specified range of height to ensure that the maximum signal is received.
- o) The input signal to the substitution antenna shall be adjusted to the level that produces a level detected by the measuring receiver, that is equal to the level noted while the transmitter radiated power was measured, corrected for the change of input attenuator setting of the measuring receiver.
- p) The measurement shall be repeated with the test antenna and the substitution antenna orientated for horizontal polarization.
- q) The measure of the effective radiated power is the larger of the two levels recorded at the input to the substitution antenna, corrected for gain of the substitution antenna if necessary.
- r) The frequency range was checked up to 10th harmonic.

6.5. Uncertainty

The measurement uncertainty is defined as for Conducted Power Measurement ± 1.2 dB, for Radiated Power Measurement ± 3.2 dB

**6.6. Test Result
Conducted Test**

Product	LE910C1-NA		
Test Item	Spurious Emission		
Test Mode	Mode 1: GSM 850_Link Mode		
Date of Test	2017/01/09	Test Site	CB4-H

824.2 MHz

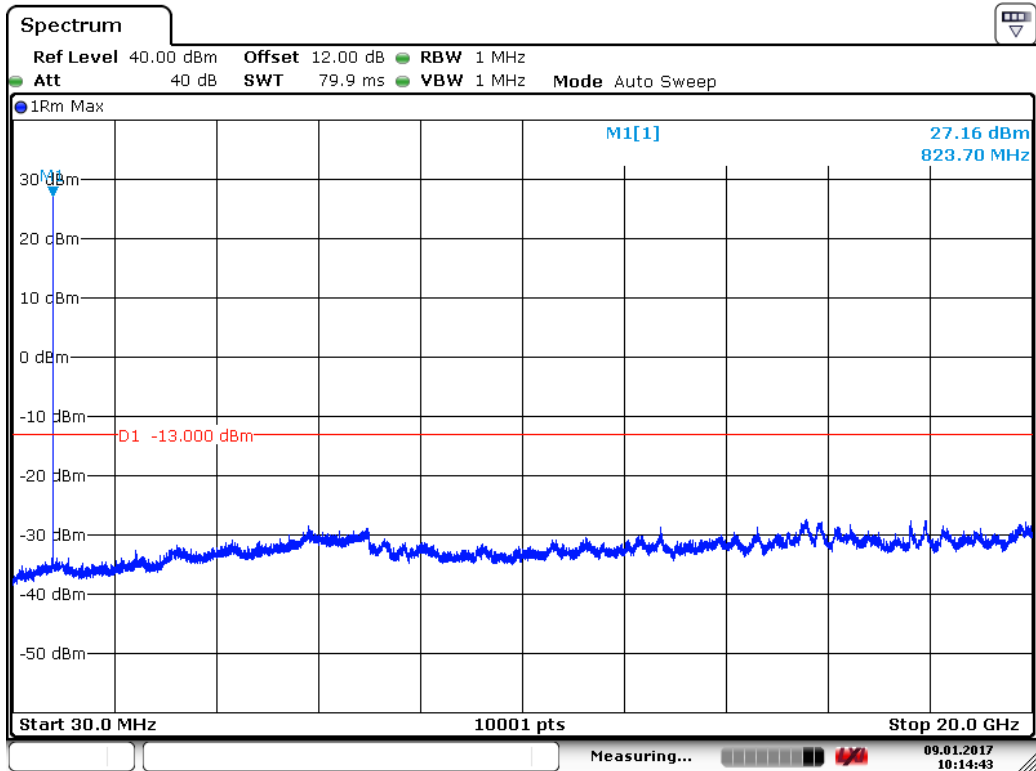

Date: 9 JAN 2017 10:14:44

836.6 MHz

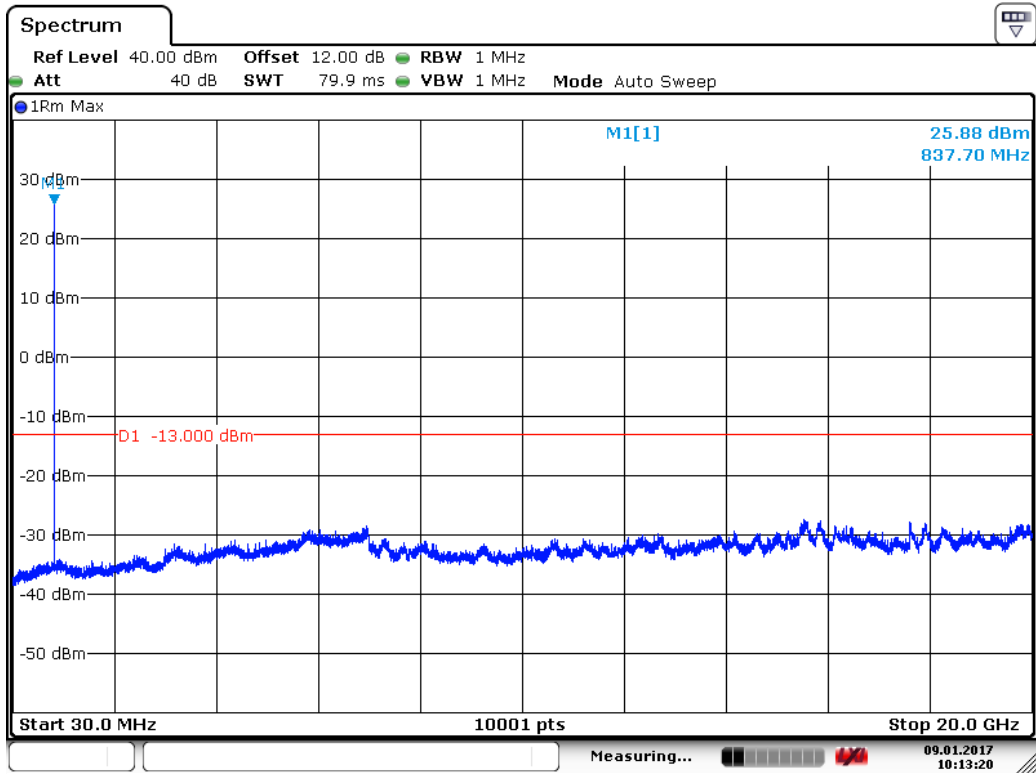

Date: 9 JAN 2017 10:13:20

848.8 MHz

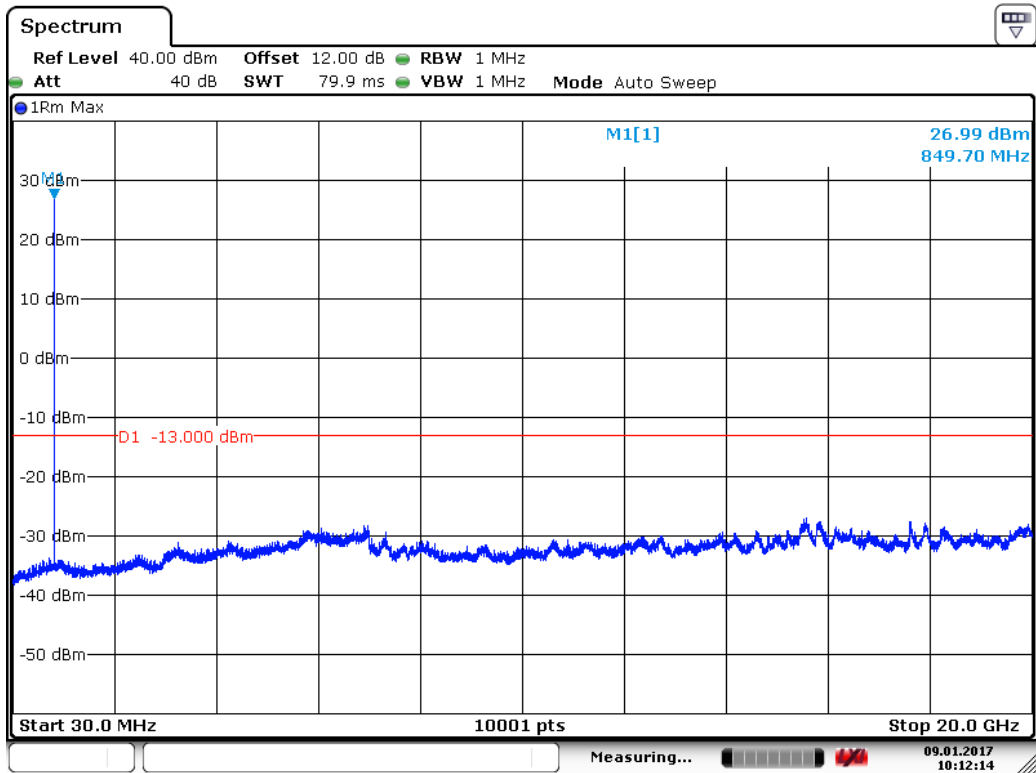

Date: 9 JAN 2017 10:12:15

Product	LE910C1-NA		
Test Item	Spurious Emission		
Test Mode	Mode 3: DCS 1900_Link Mode		
Date of Test	2017/01/09	Test Site	CB4-H

1850.2 MHz

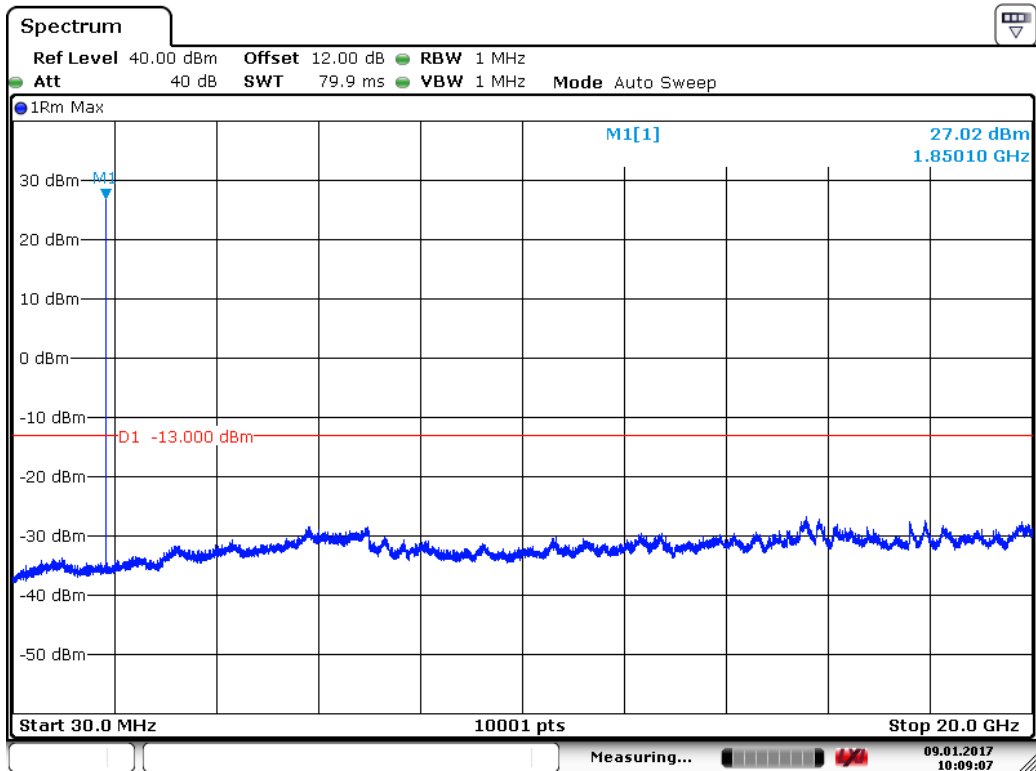

Date: 9 JAN 2017 10:09:07

1880.0 MHz

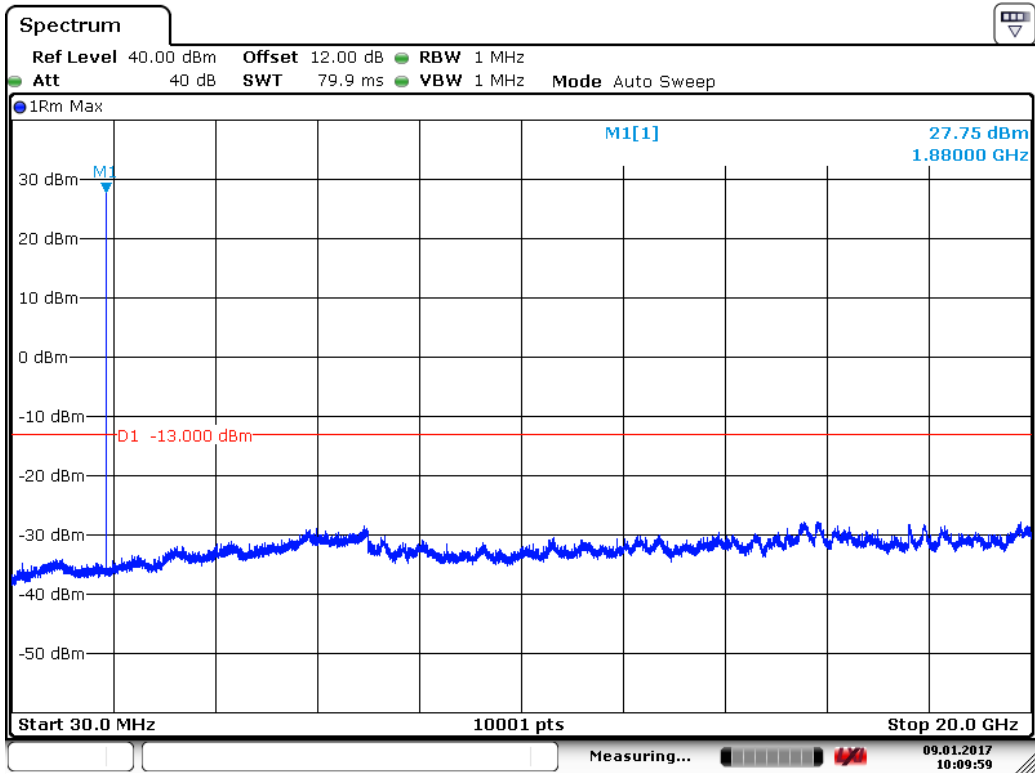

Date: 9 JAN 2017 10:10:00

1909.8 MHz

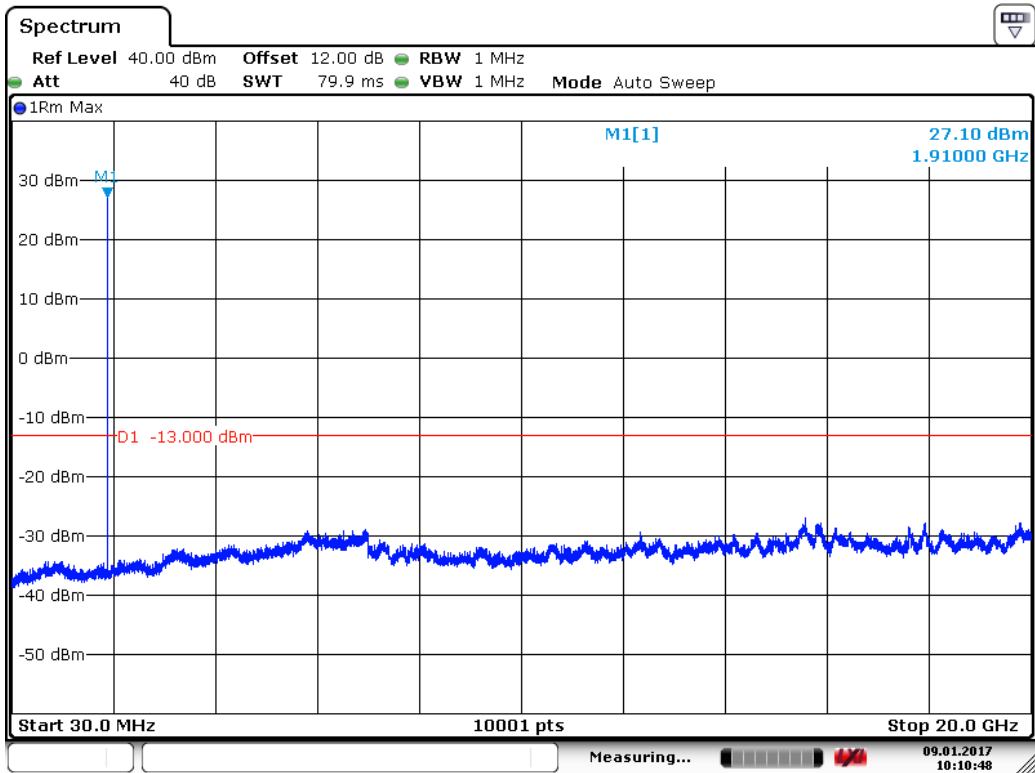

Date: 9 JAN 2017 10:10:48

Product	LE910C1-NA		
Test Item	Spurious Emission		
Test Mode	Mode 5: GSM_EGPRS 850_Link Mode		
Date of Test	2017/02/02	Test Site	CB4-H

824.2 MHz

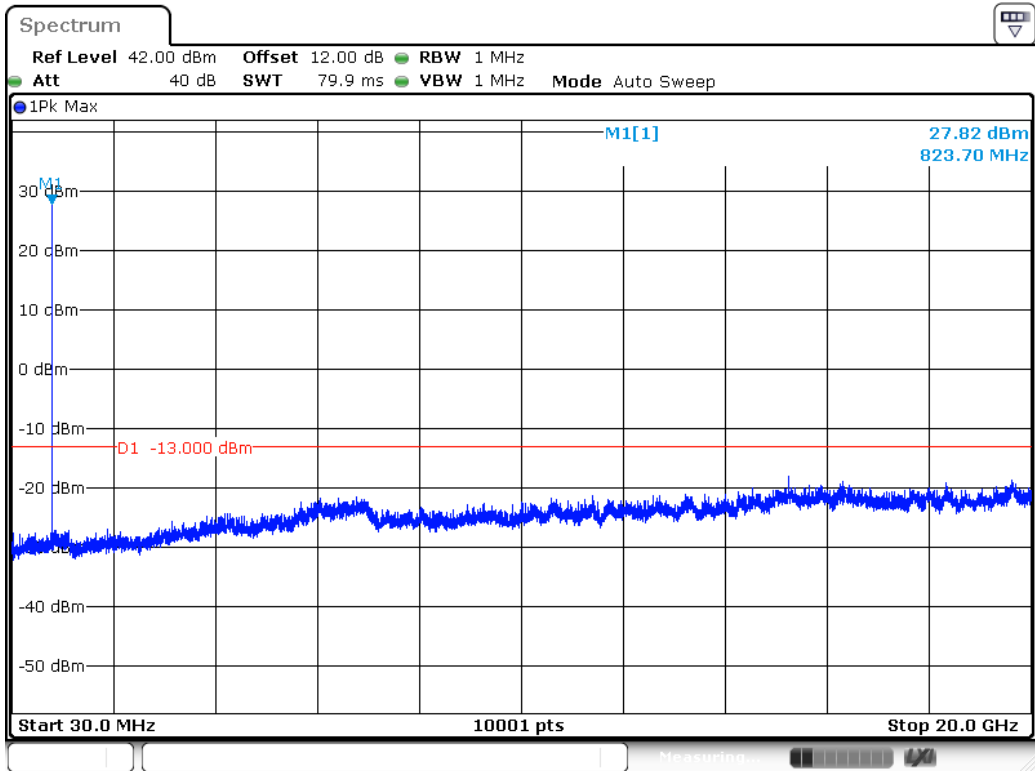

Date: 2.FEB.2017 13:26:46

836.6 MHz

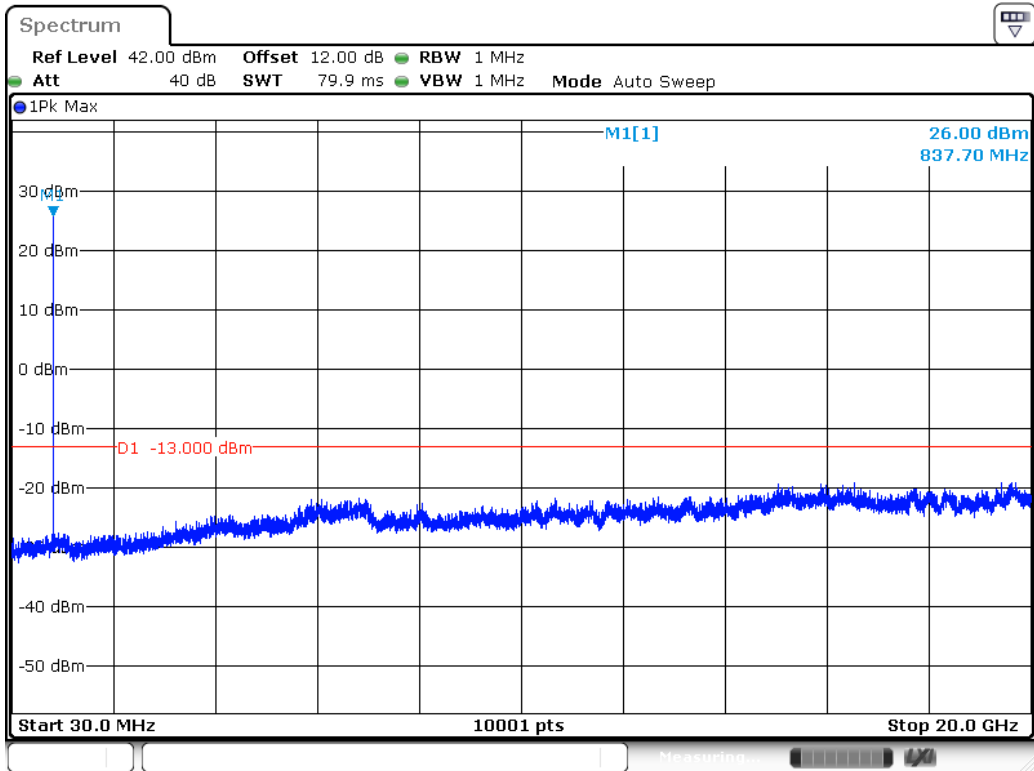

848.8 MHz

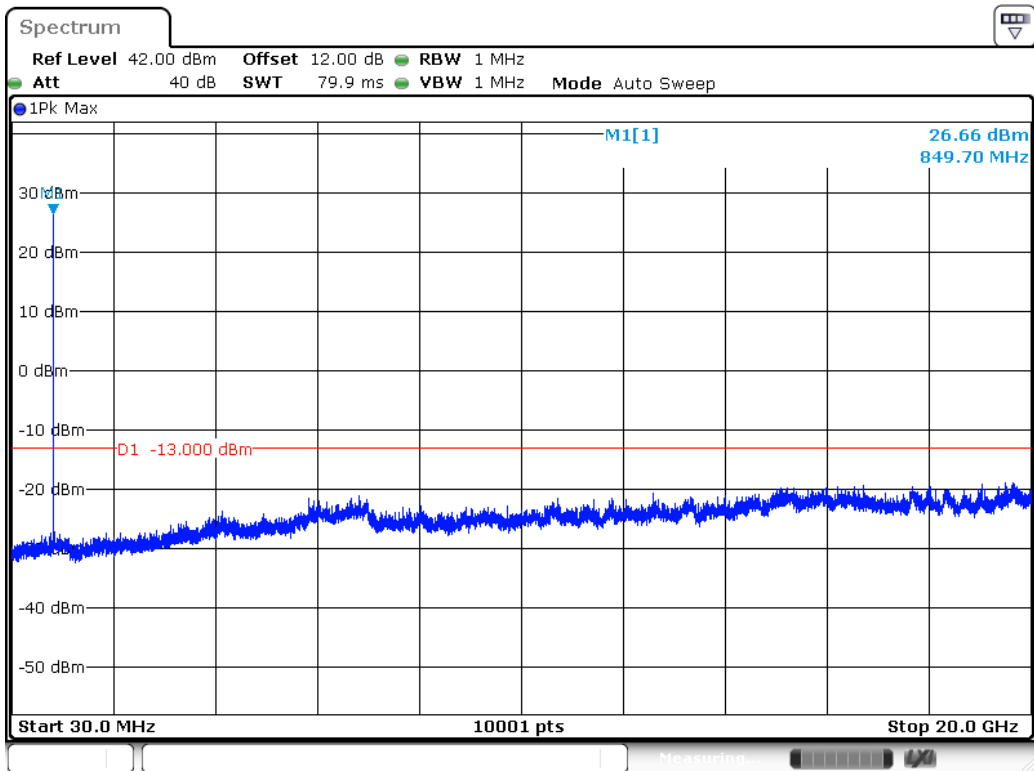

Product	LE910C1-NA		
Test Item	Spurious Emission		
Test Mode	Mode 7: DCS_EGPRS 1900_Link Mode		
Date of Test	2017/02/02	Test Site	CB4-H

1850.2 MHz

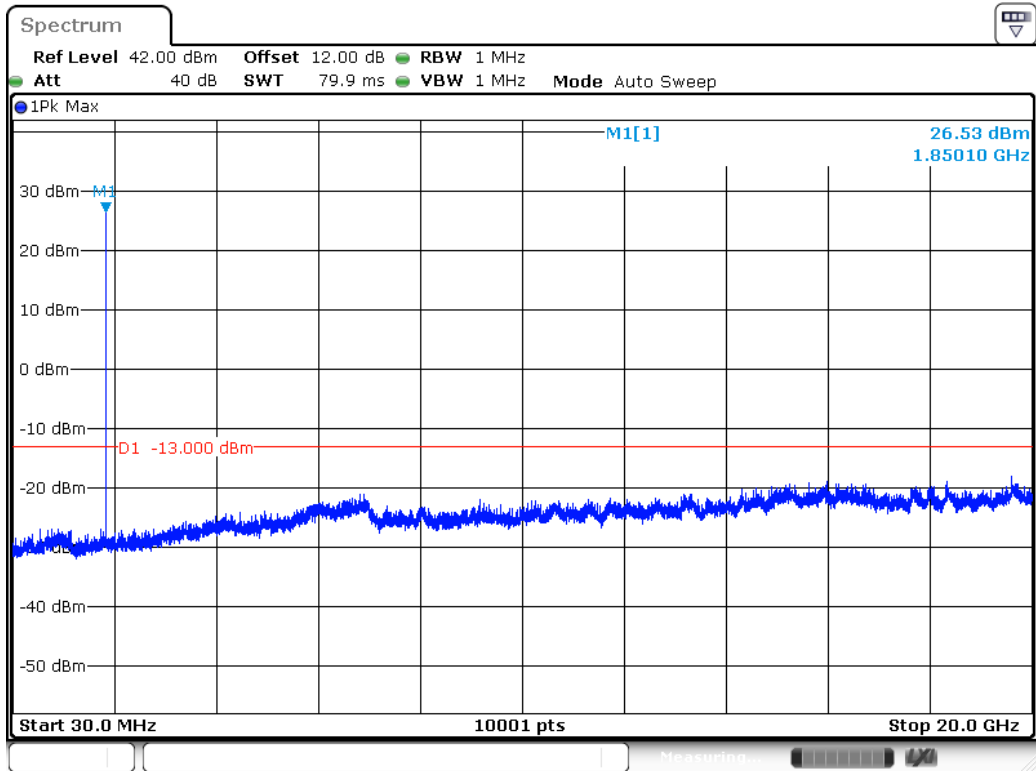

1880.0 MHz

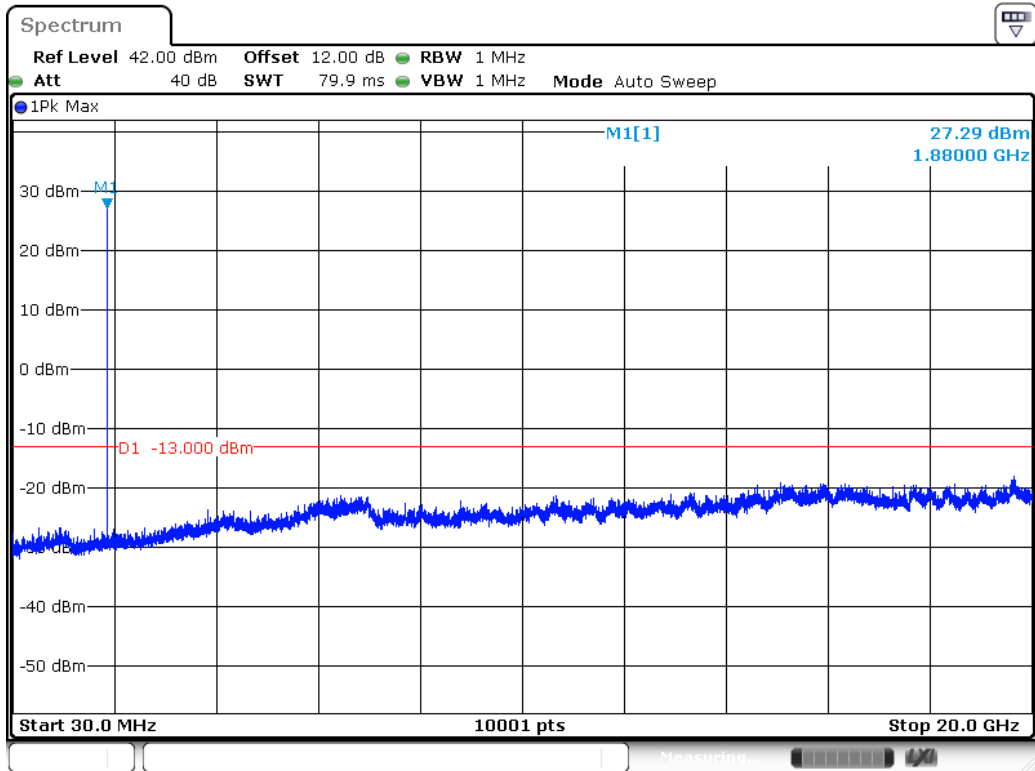

Date: 2.FEB.2017 13:22:09

1909.8 MHz

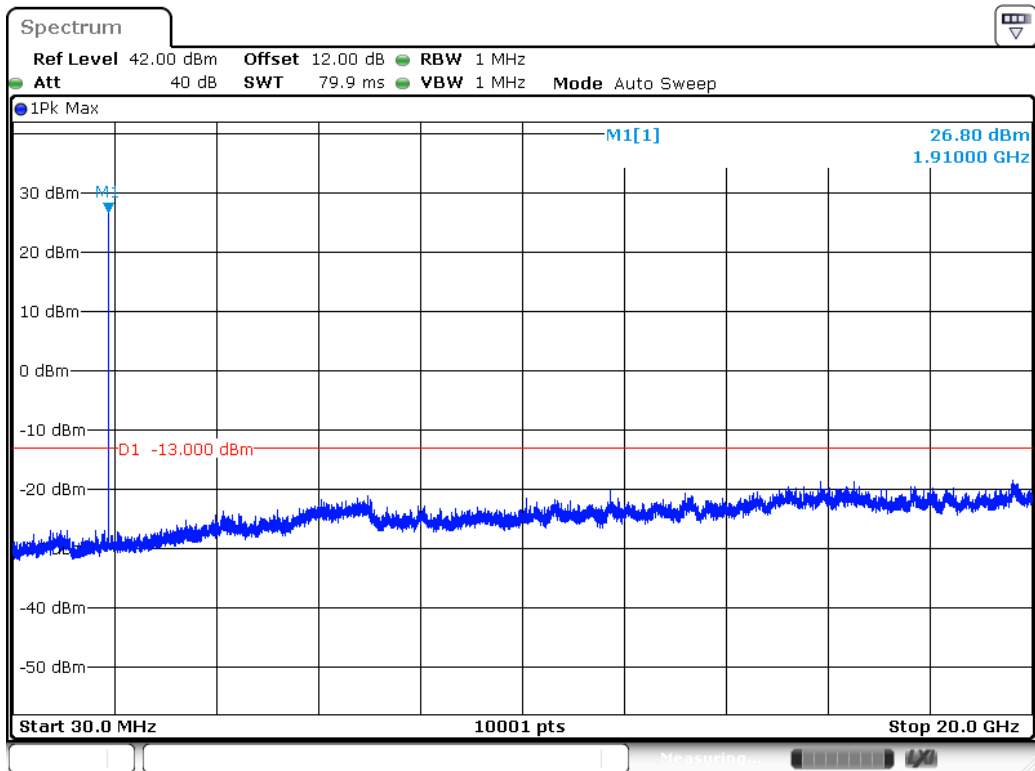

Date: 2.FEB.2017 13:20:51

Product	LE910C1-NA		
Test Item	Spurious Emission		
Test Mode	Mode 9: WCDMA Band 5_Link Mode		
Date of Test	2017/01/09	Test Site	CB4-H

826.4 MHz

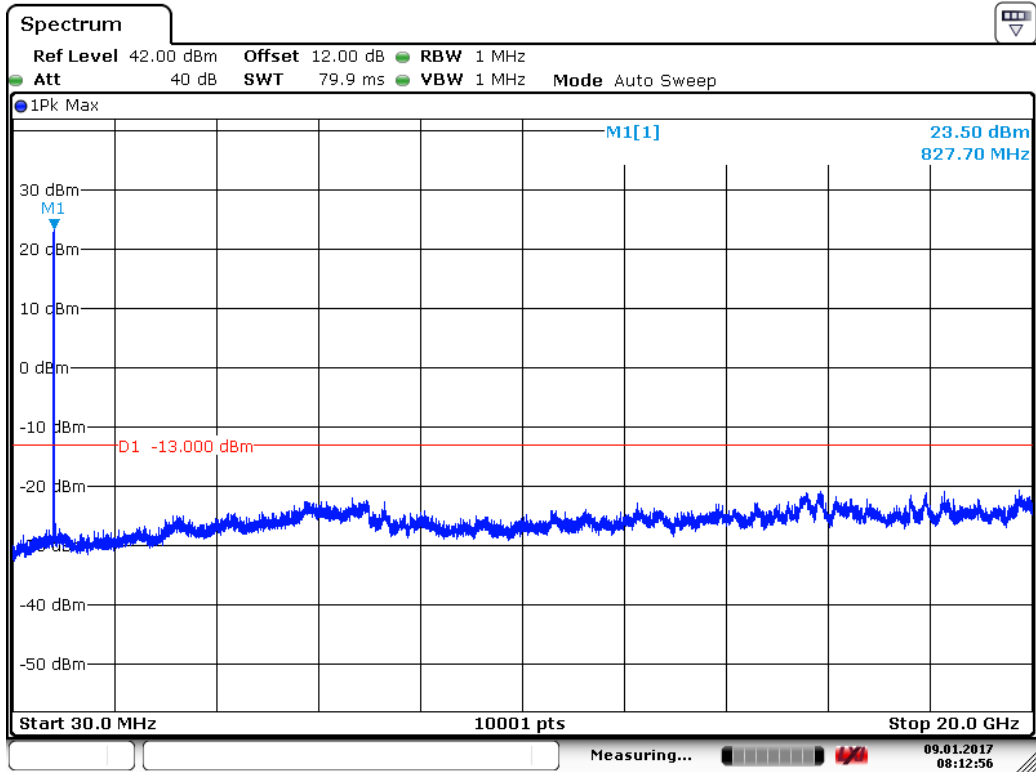

Date: 9 JAN 2017 08:12:57

836.6 MHz

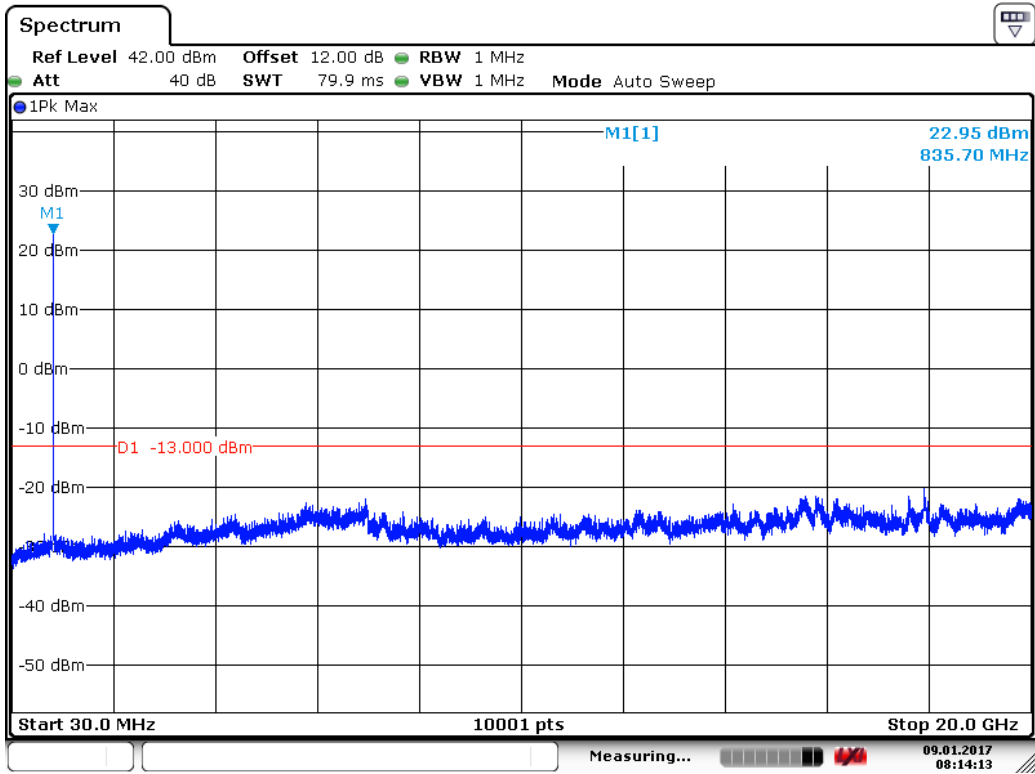

Date: 9 JAN 2017 08:14:14

846.6 MHz

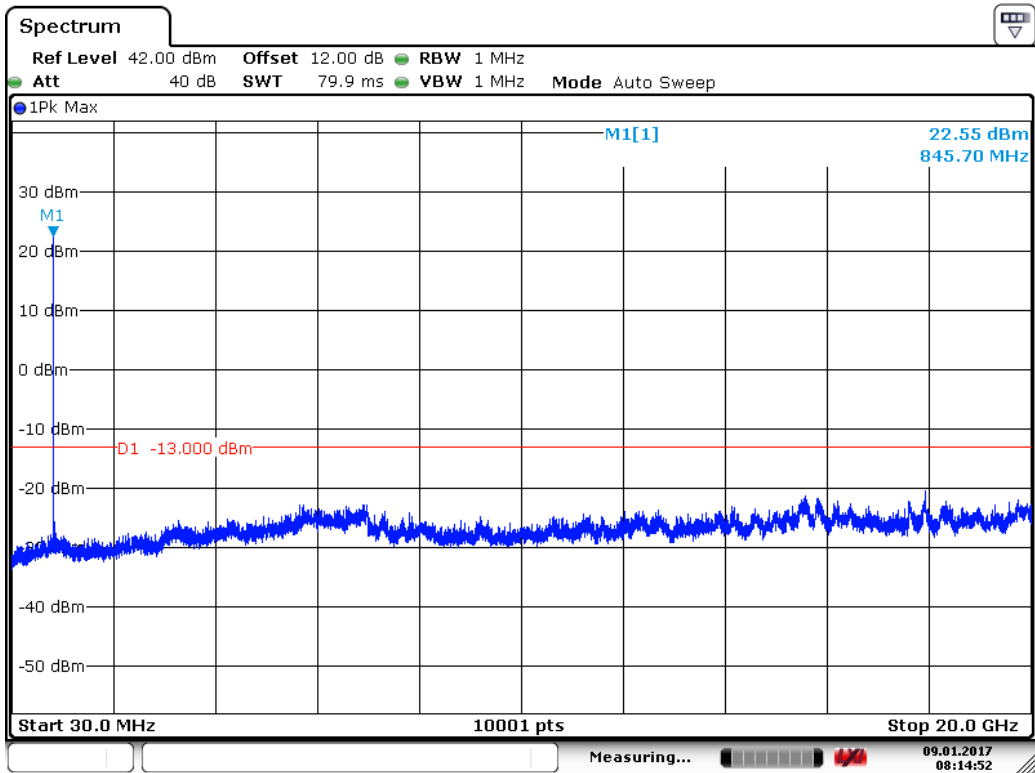

Date: 9 JAN 2017 08:14:52

Product	LE910C1-NA		
Test Item	Spurious Emission		
Test Mode	Mode 11: WCDMA Band 2_Link Mode		
Date of Test	2017/01/09	Test Site	CB4-H

1852.4 MHz

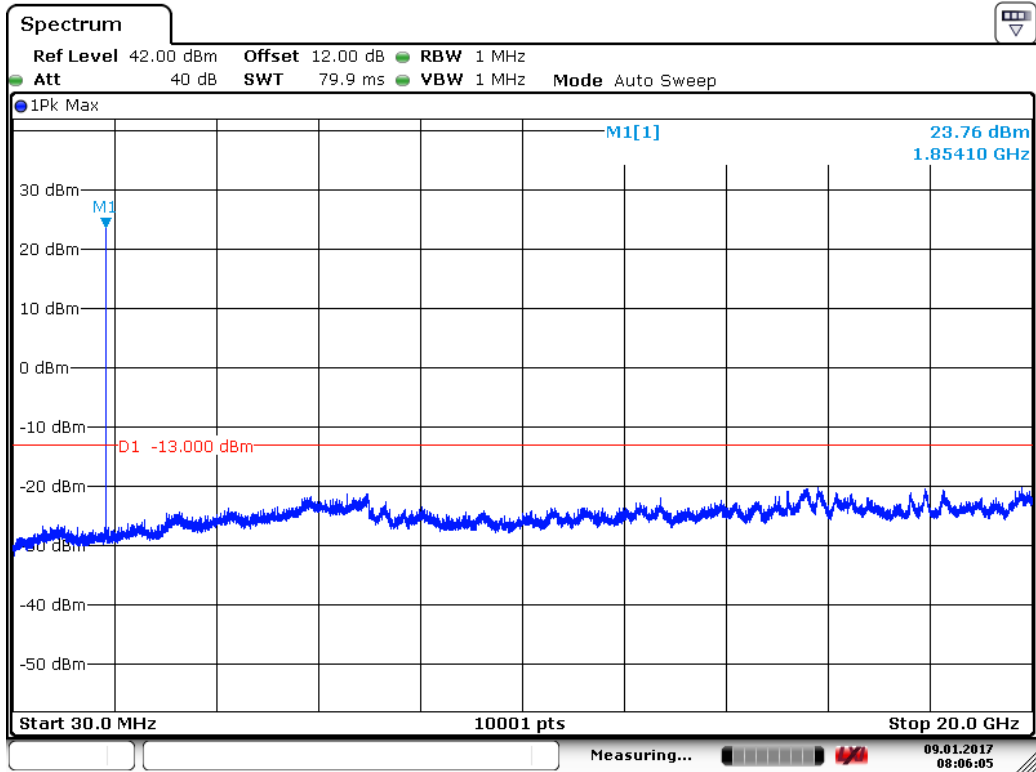

Date: 9 JAN 2017 08:06:05

1880.0 MHz

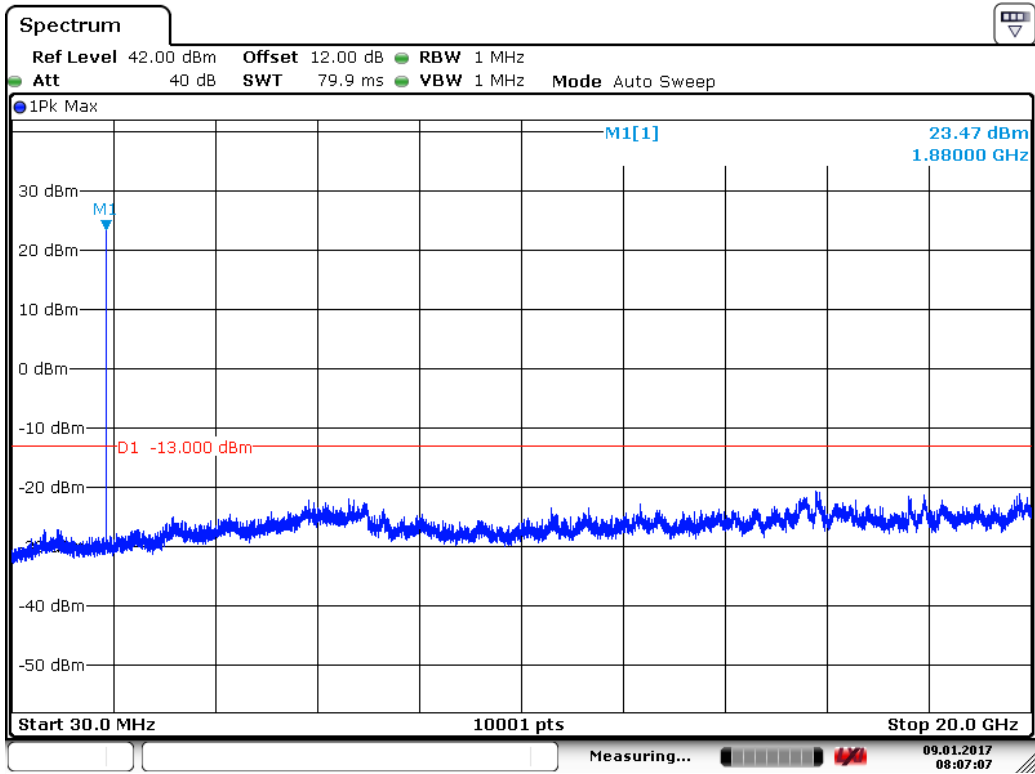

Date: 9 JAN 2017 08:07:07

1907.6 MHz

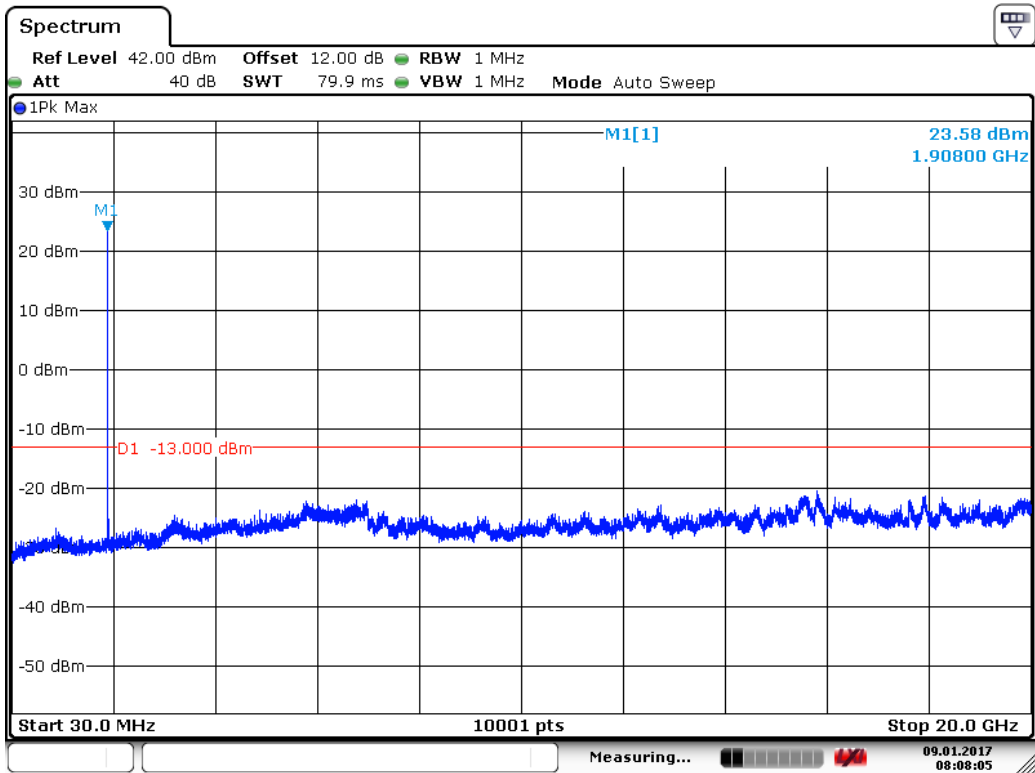

Date: 9 JAN 2017 08:08:06

Product	LE910C1-NA		
Test Item	Spurious Emission		
Test Mode	Mode 13: WCDMA Band 5_HSUPA Mode		
Date of Test	2017/02/23	Test Site	CB4-H

826.4 MHz

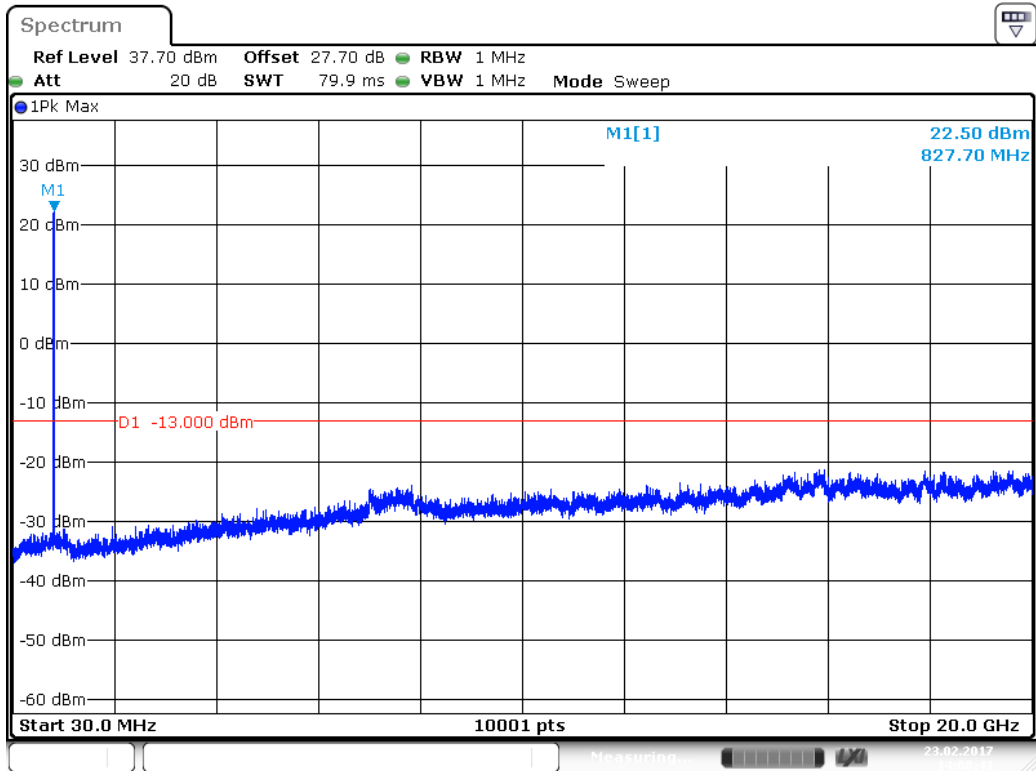

Date: 23.FEB.2017 14:08:41

836.6 MHz

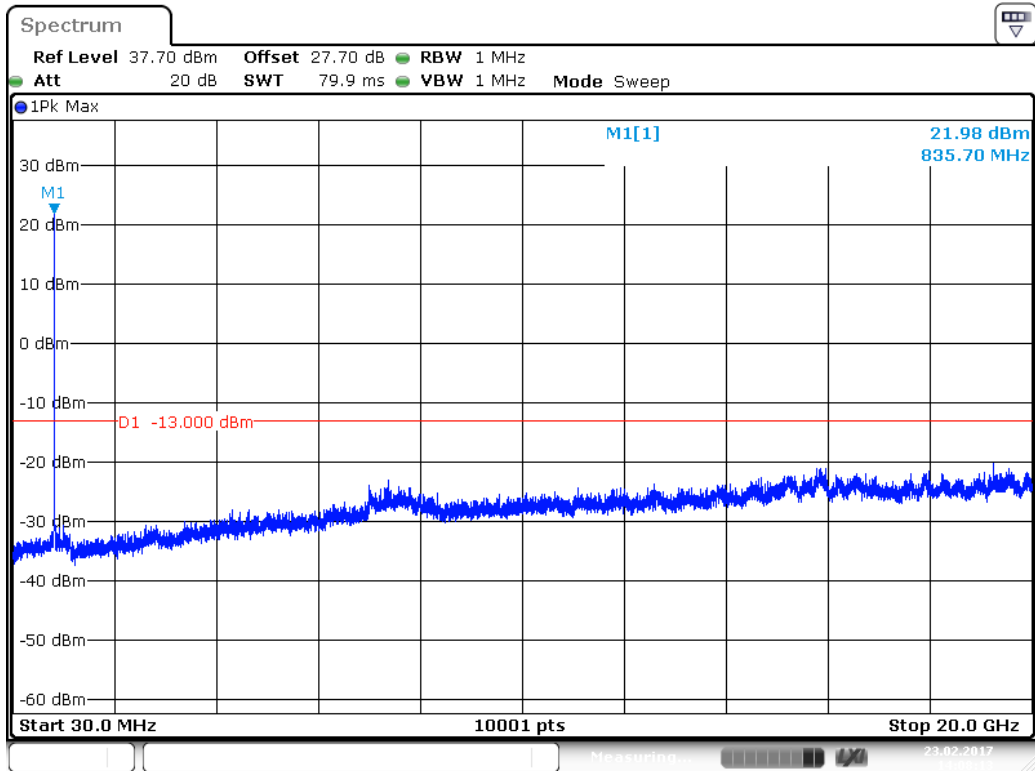

Date: 23.FEB.2017 14:08:13

846.6 MHz

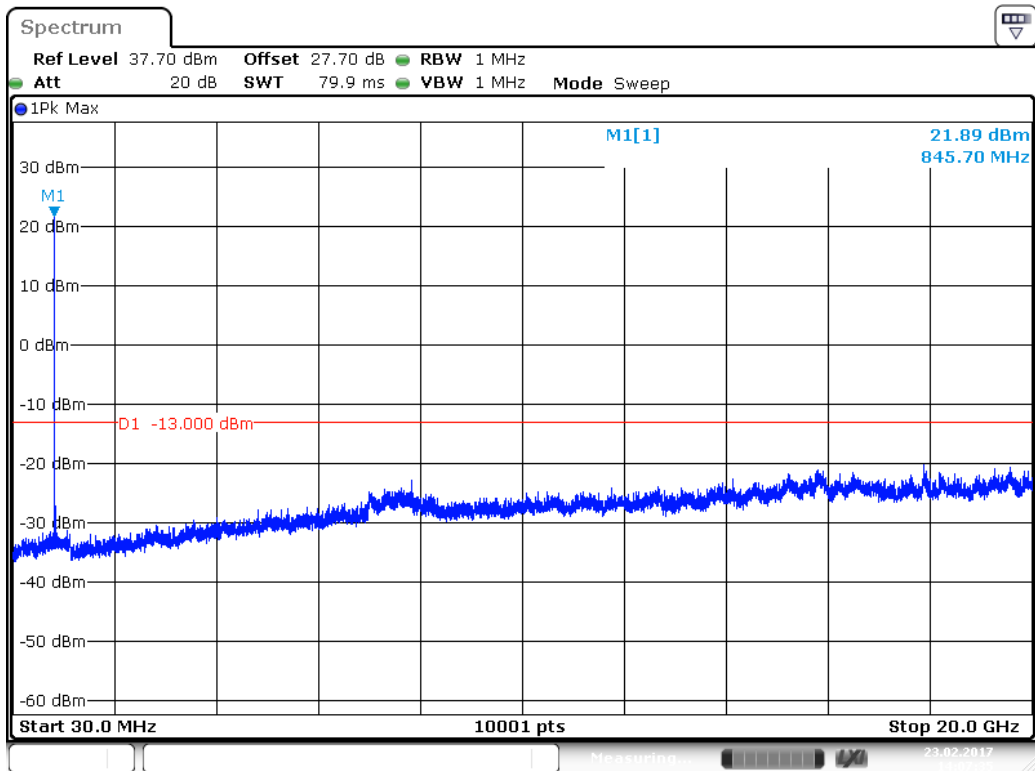

Date: 23.FEB.2017 14:07:35

Product	LE910C1-NA		
Test Item	Spurious Emission		
Test Mode	Mode 14: WCDMA Band 5_HSDPA Mode		
Date of Test	2017/02/23	Test Site	CB4-H

826.4 MHz

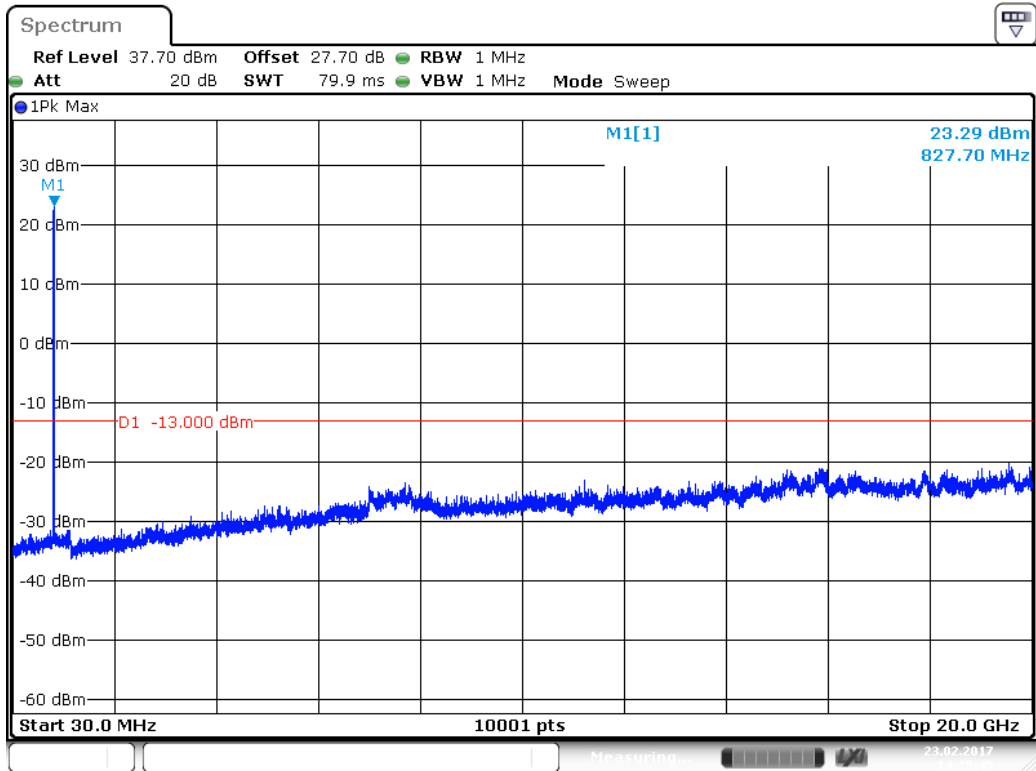

Date: 23.FEB.2017 14:25:46

836.6 MHz

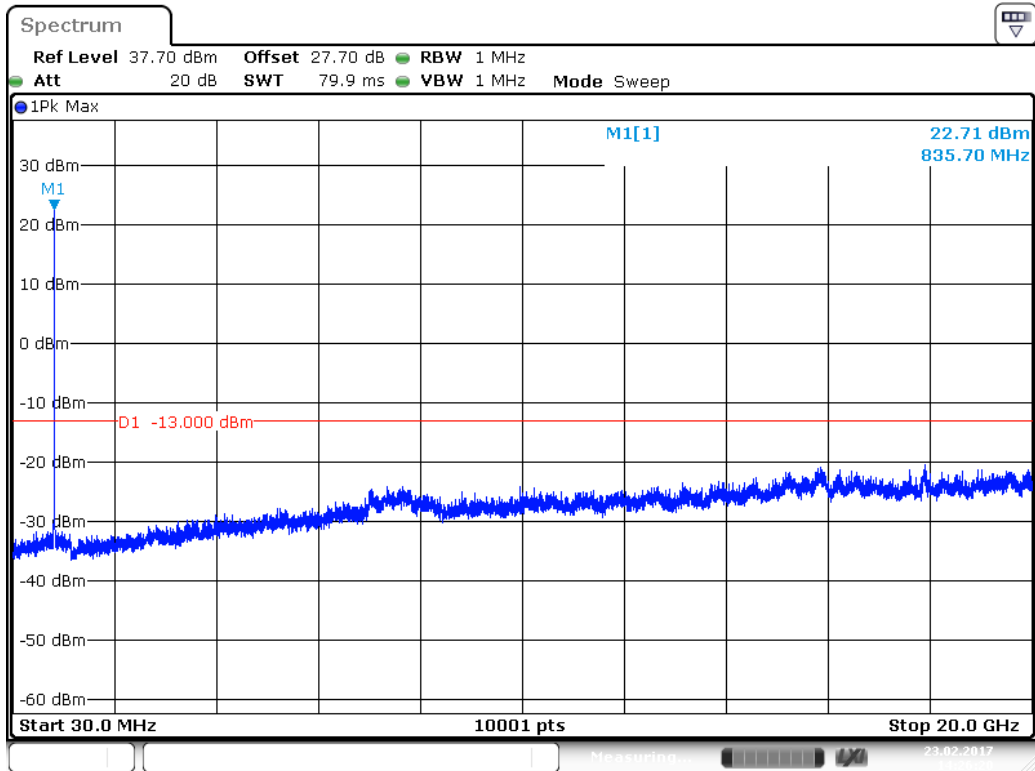

Date: 23.FEB.2017 14:26:20

846.6 MHz

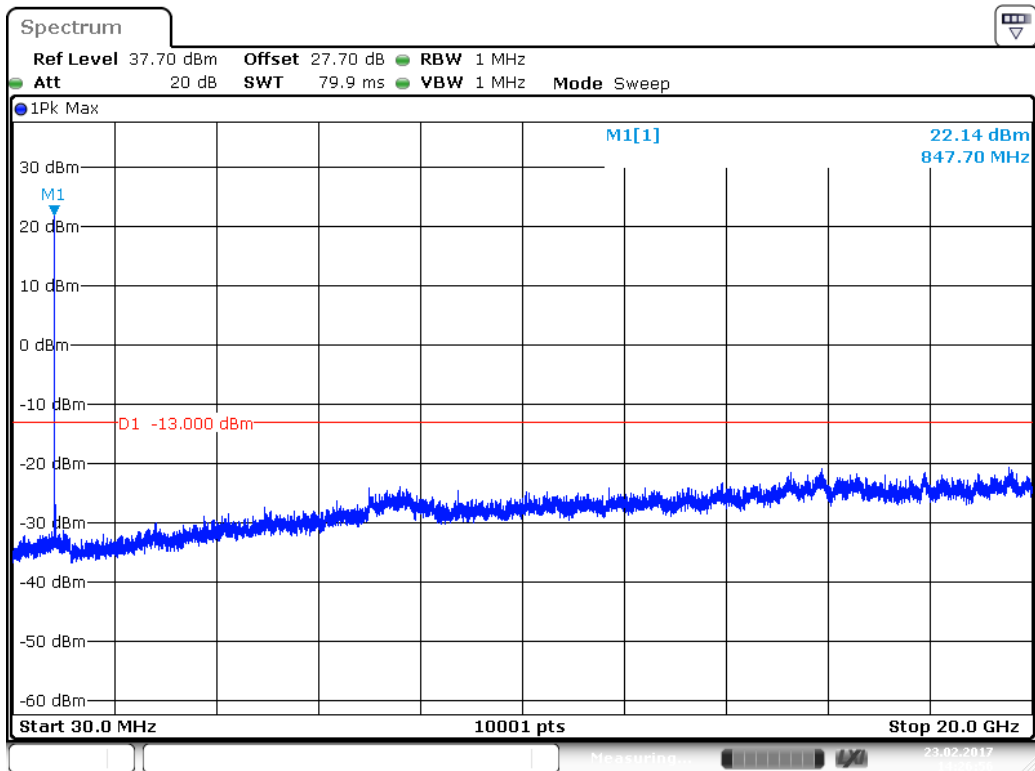

Date: 23.FEB.2017 14:26:56

Product	LE910C1-NA		
Test Item	Spurious Emission		
Test Mode	Mode 15: WCDMA Band 2_HSUPA Mode		
Date of Test	2017/02/23	Test Site	CB4-H

1852.4 MHz

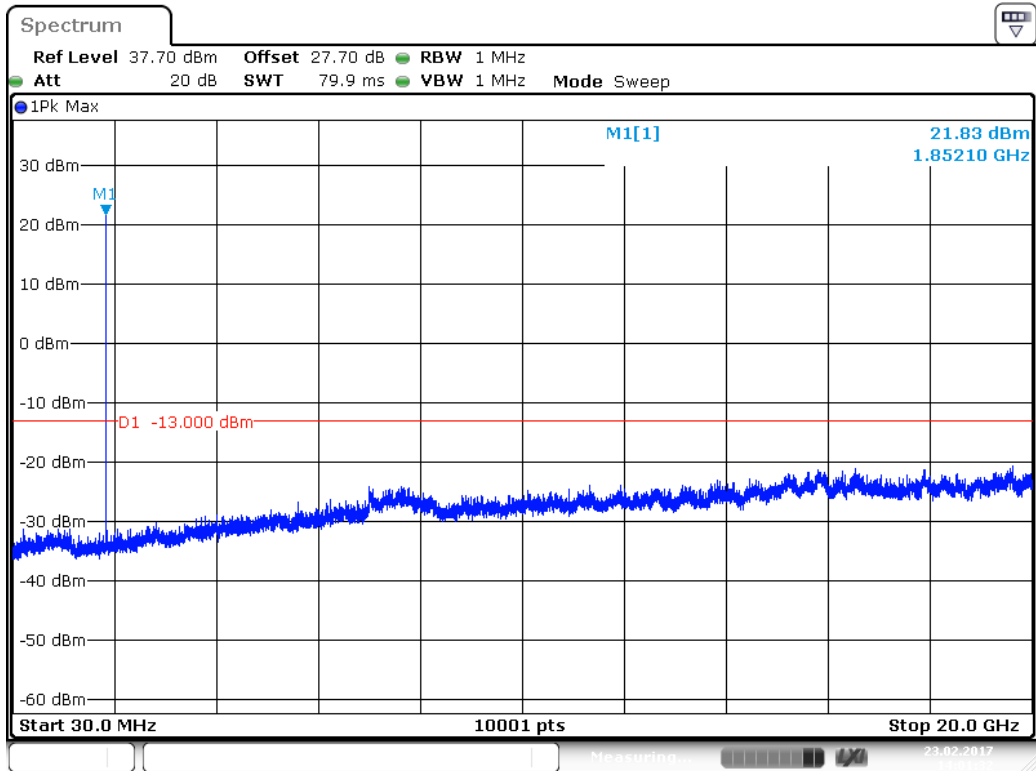

Date: 23.FEB.2017 14:01:33

1880.0 MHz

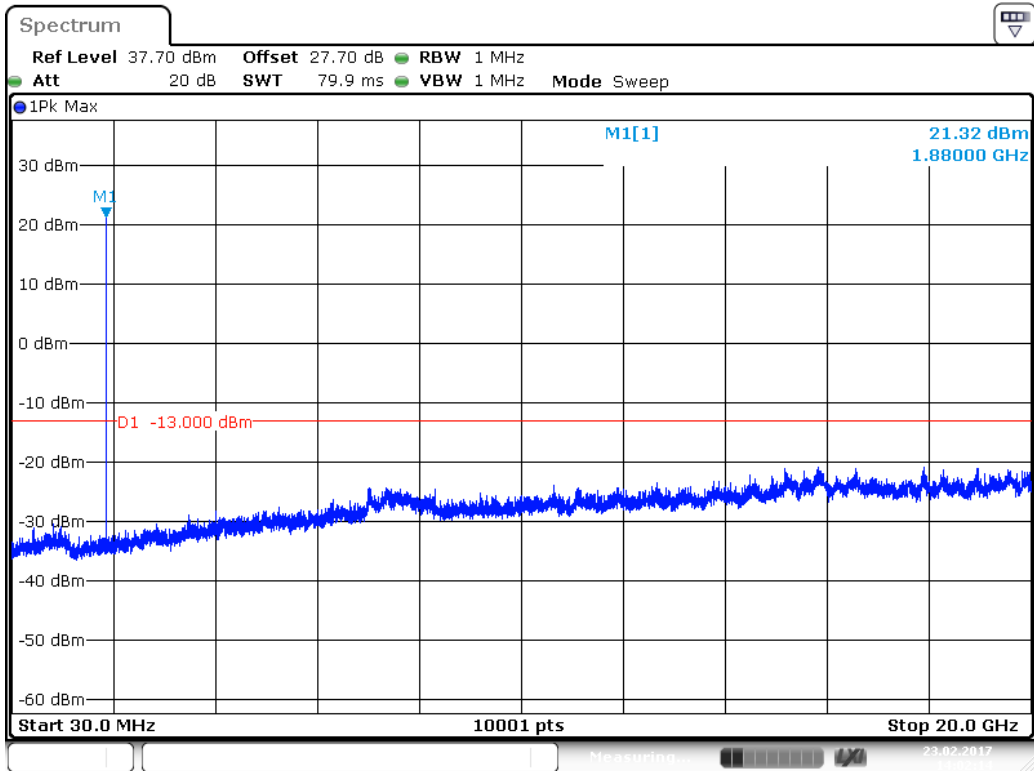

Date: 23.FEB.2017 14:02:15

1907.6 MHz

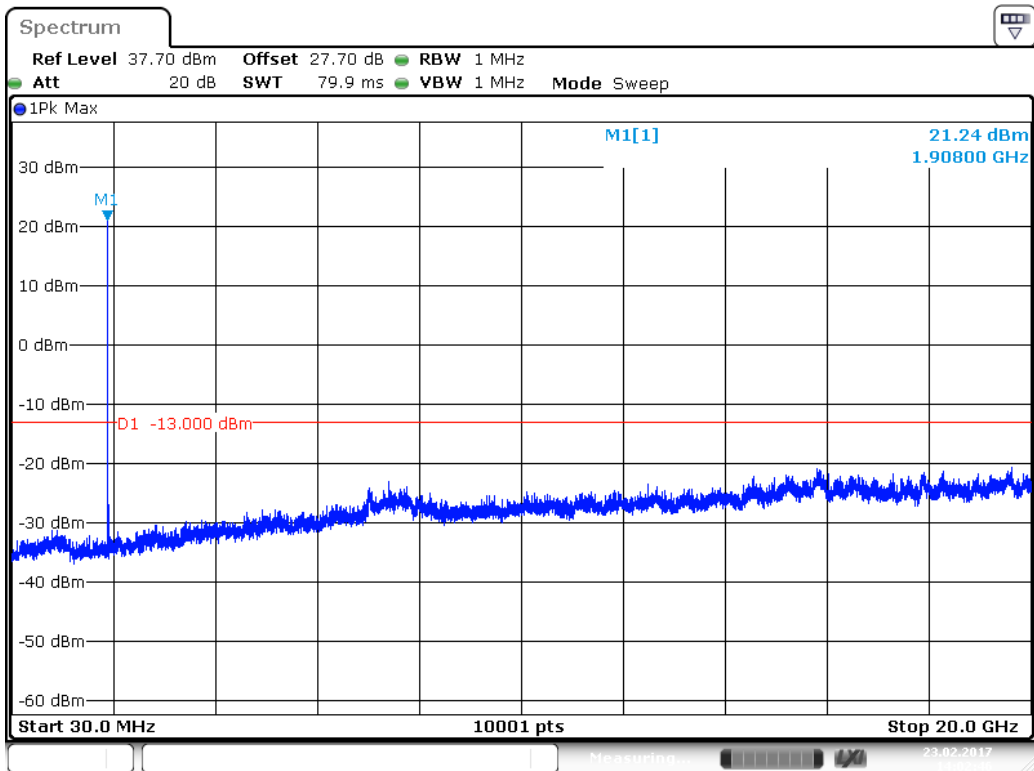

Date: 23.FEB.2017 14:02:46

Product	LE910C1-NA		
Test Item	Spurious Emission		
Test Mode	Mode 16: WCDMA Band 2_HSDPA Mode		
Date of Test	2017/02/23	Test Site	CB4-H

1852.4 MHz

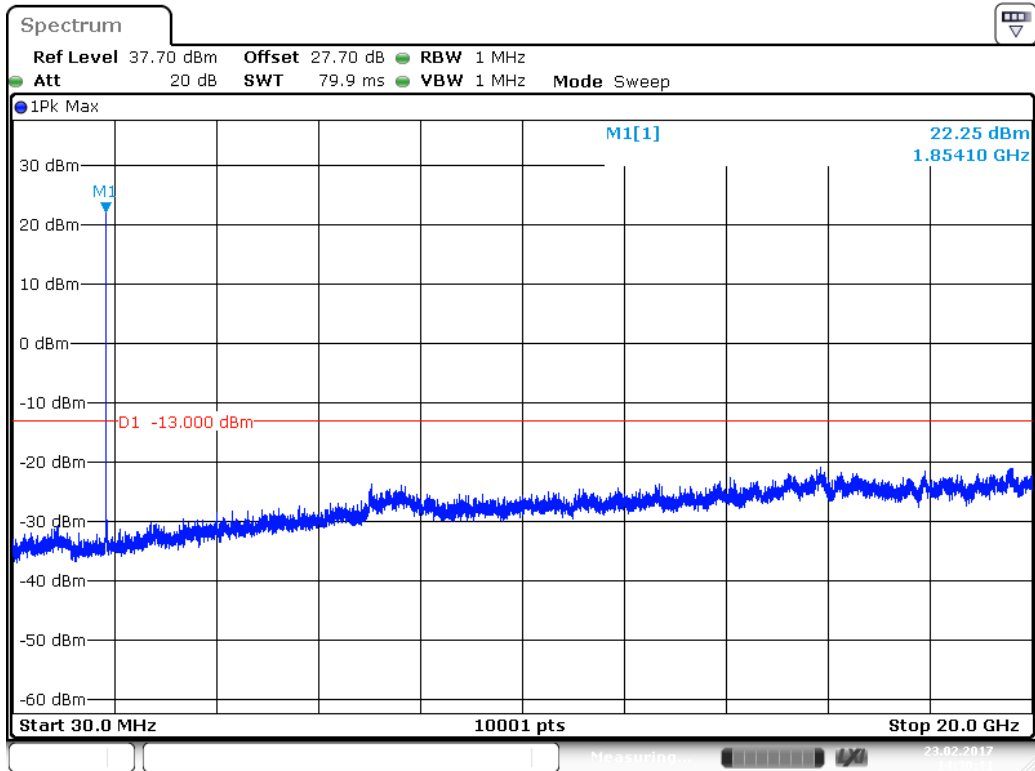

Date: 23.FEB.2017 14:30:11

1880.0 MHz

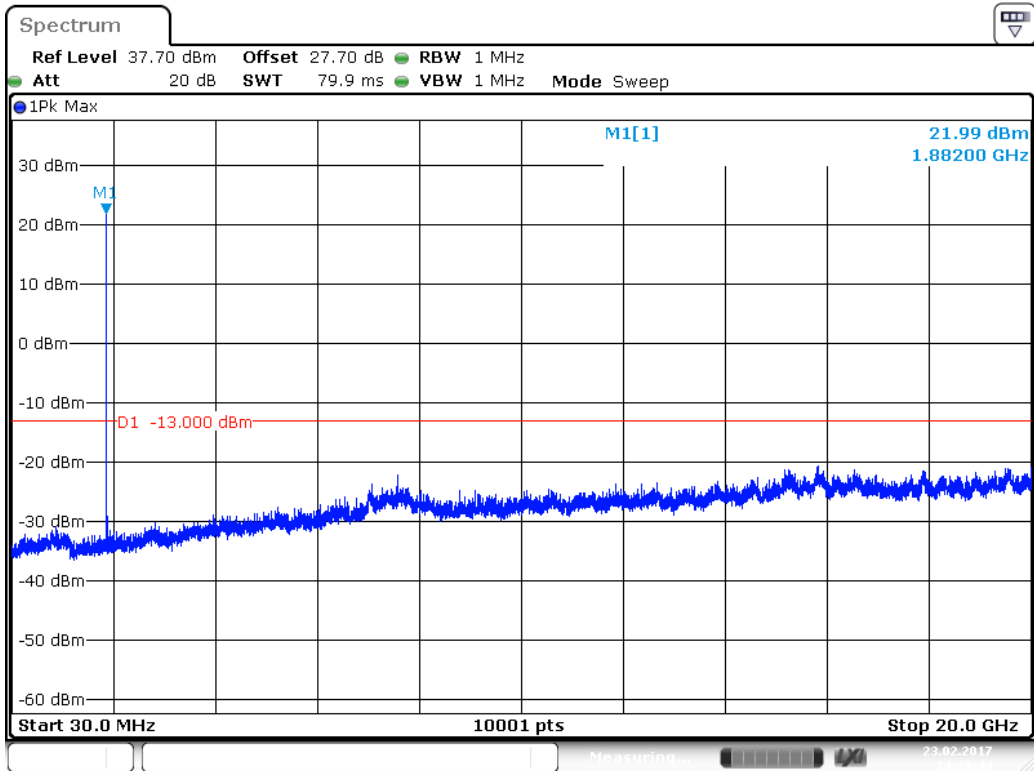

Date: 23.FEB.2017 14:29:44

1907.6 MHz

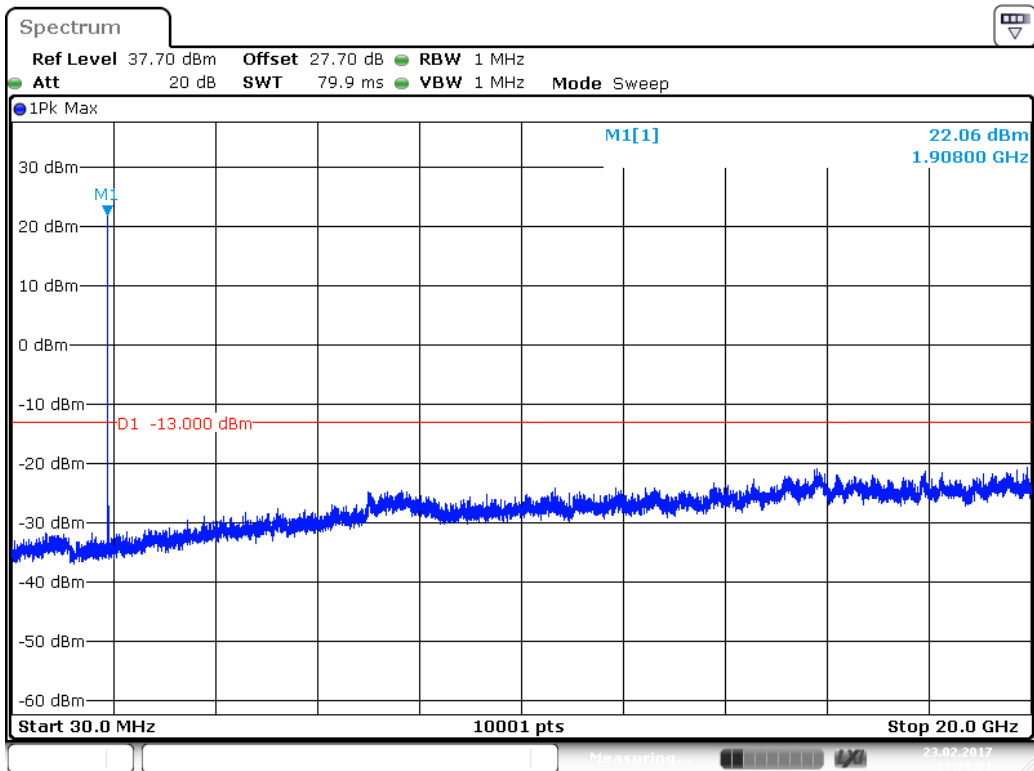

Date: 23.FEB.2017 14:29:01

Radiated Test
30MHz-1GHz Spurious

Site : CB4-H	Time : 2017/02/15
Limit : FCC_Part22/24_00M_00M_PK	Margin : 6
Probe : CB4-H_CE_Sub_S2_30M-1GHz_1116 - HORIZONTAL	Power : DC 3.8V
EUT : LE910C1-NA	Note : Mode 1: GSM 850_Link Mode_ 836.6MHz

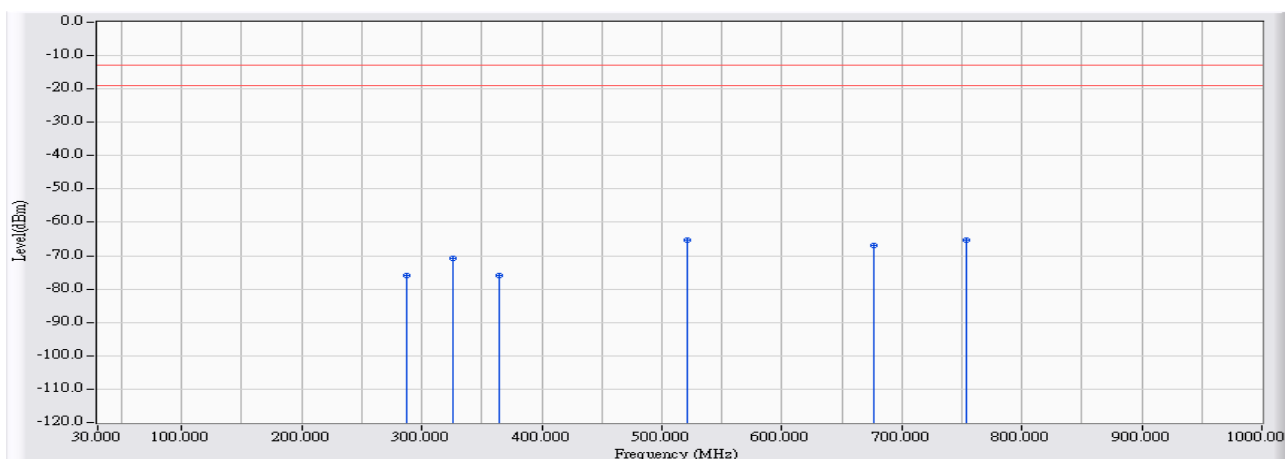

		Frequency (MHz)	Correct Factor (dB)	Reading Level (dBm)	Measure Level (dBm)	Margin (dB)	Limit (dBm)	Detector Type
1		288.020	-20.954	-54.831	-75.785	-62.785	-13.000	QUASIPeAK
2		326.335	-19.432	-51.493	-70.924	-57.924	-13.000	QUASIPeAK
3		364.650	-17.915	-57.877	-75.792	-62.792	-13.000	QUASIPeAK
4		521.305	-13.888	-51.512	-65.400	-52.400	-13.000	QUASIPeAK
5		676.505	-11.521	-55.455	-66.976	-53.976	-13.000	QUASIPeAK
6	*	754.105	-11.160	-54.043	-65.203	-52.203	-13.000	QUASIPeAK

Note:

1. All Reading Levels are Quasi-Peak value.
2. “ * ”, means this data is the worst emission level.
3. Measurement Level = Reading Level + Correct Factor.

Site : CB4-H	Time : 2017/02/15
Limit : FCC_Part22/24_00M_00M_PK	Margin : 6
Probe : CB4-H_CE_Sub_S2_30M-1GHz_1116 - VERTICAL	Power : DC 3.8V
EUT : LE910C1-NA	Note : Mode 1: GSM 850_Link Mode_ 836.6MHz

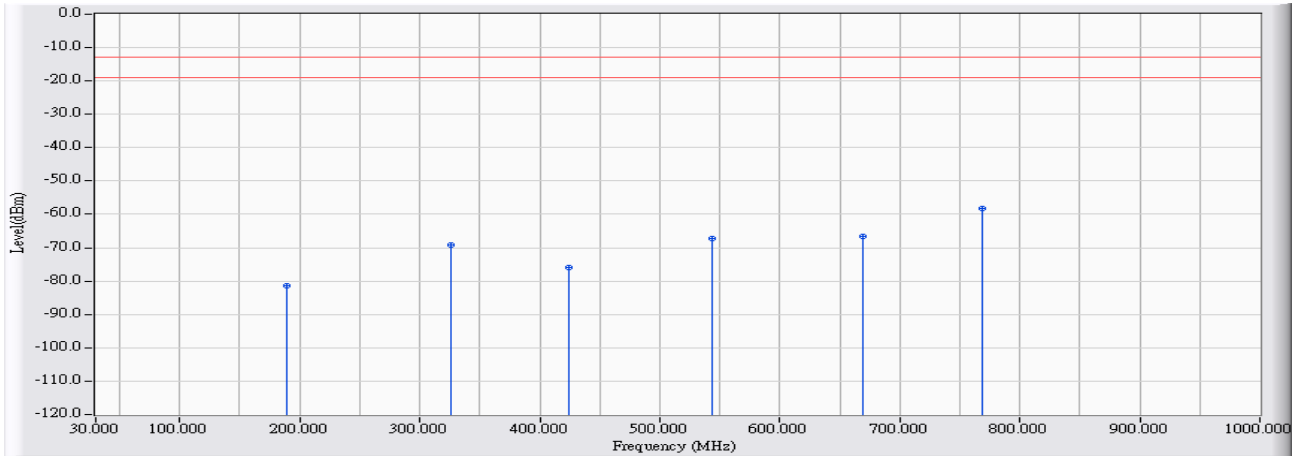

		Frequency (MHz)	Correct Factor (dB)	Reading Level (dBm)	Measure Level (dBm)	Margin (dB)	Limit (dBm)	Detector Type
1		189.080	-23.846	-57.635	-81.481	-68.481	-13.000	QUASPEAK
2		326.335	-19.363	-49.862	-69.224	-56.224	-13.000	QUASPEAK
3		424.790	-16.216	-59.606	-75.823	-62.823	-13.000	QUASPEAK
4		543.615	-13.014	-54.373	-67.387	-54.387	-13.000	QUASPEAK
5		669.230	-11.195	-55.380	-66.576	-53.576	-13.000	QUASPEAK
6	*	769.140	-9.991	-48.195	-58.186	-45.186	-13.000	QUASPEAK

Note:

1. All Reading Levels are Quasi-Peak value.
2. “ * ”, means this data is the worst emission level.
3. Measurement Level = Reading Level + Correct Factor.

Site : CB4-H	Time : 2017/02/15
Limit : FCC_Part22/24_00M_00M_PK	Margin : 6
Probe : CB4-H_CE_Sub_S2_30M-1GHz_1116 - HORIZONTAL	Power : DC 3.8V
EUT : LE910C1-NA	Note : Mode 2: GSM 850_Idle Mode_ 836.6MHz

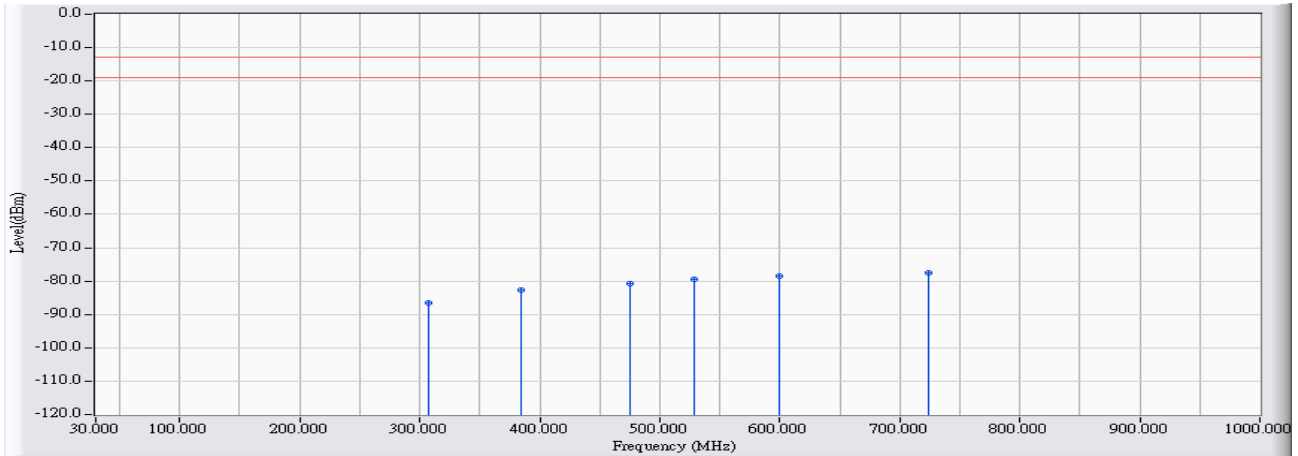

		Frequency (MHz)	Correct Factor (dB)	Reading Level (dBm)	Measure Level (dBm)	Margin (dB)	Limit (dBm)	Detector Type
1		306.935	-20.316	-66.349	-86.665	-73.665	-13.000	QUASIPeAK
2		384.050	-16.999	-65.823	-82.822	-69.822	-13.000	QUASIPeAK
3		475.230	-14.937	-65.734	-80.671	-67.671	-13.000	QUASIPeAK
4		528.095	-14.105	-65.264	-79.369	-66.369	-13.000	QUASIPeAK
5		599.875	-12.622	-65.989	-78.611	-65.611	-13.000	QUASIPeAK
6	*	724.520	-10.901	-66.547	-77.448	-64.448	-13.000	QUASIPeAK

Note:

1. All Reading Levels are Quasi-Peak value.
2. “ * ”, means this data is the worst emission level.
3. Measurement Level = Reading Level + Correct Factor.

Site : CB4-H	Time : 2017/02/15
Limit : FCC_Part22/24_00M_00M_PK	Margin : 6
Probe : CB4-H_CE_Sub_S2_30M-1GHz_1116 - VERTICAL	Power : DC 3.8V
EUT : LE910C1-NA	Note : Mode 2: GSM 850_Idle Mode_ 836.6MHz

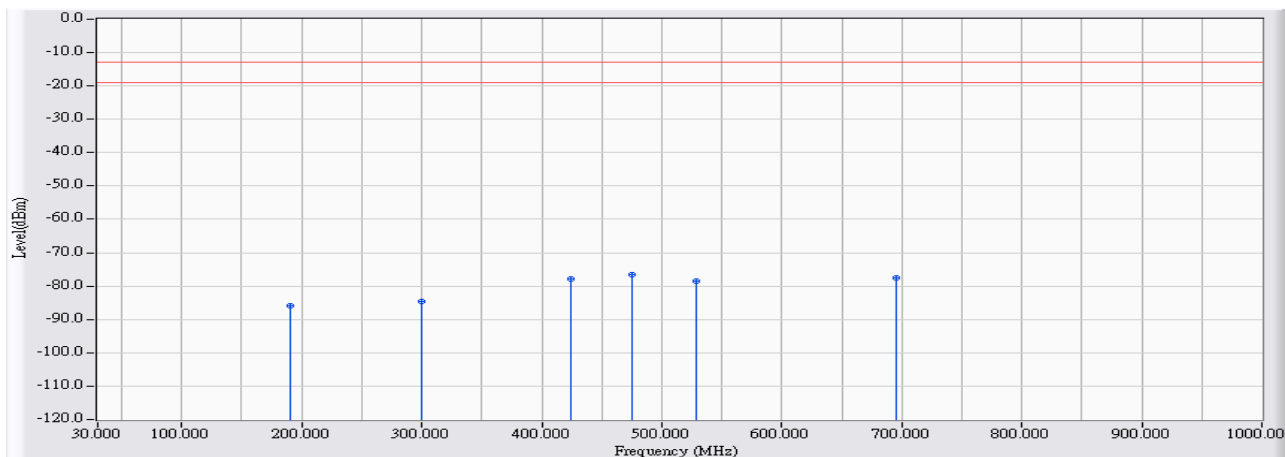

	Frequency (MHz)	Correct Factor (dB)	Reading Level (dBm)	Measure Level (dBm)	Margin (dB)	Limit (dBm)	Detector Type
1	190.535	-23.962	-62.032	-85.994	-72.994	-13.000	QUASIPeAK
2	300.145	-20.273	-64.356	-84.629	-71.629	-13.000	QUASIPeAK
3	424.790	-16.216	-61.537	-77.754	-64.754	-13.000	QUASIPeAK
4	* 475.230	-14.662	-61.968	-76.630	-63.630	-13.000	QUASIPeAK
5	528.095	-13.636	-64.906	-78.543	-65.543	-13.000	QUASIPeAK
6	695.905	-11.666	-66.002	-77.668	-64.668	-13.000	QUASIPeAK

Note:

1. All Reading Levels are Quasi-Peak value.
2. “ * ”, means this data is the worst emission level.
3. Measurement Level = Reading Level + Correct Factor.

Site : CB4-H	Time : 2017/02/15
Limit : FCC_Part22/24_00M_00M_PK	Margin : 6
Probe : CB4-H_CE_Sub_S2_30M-1GHz_1116 - HORIZONTAL	Power : DC 3.8V
EUT : LE910C1-NA	Note : Mode 3: DCS 1900_Link Mode_1880MHz

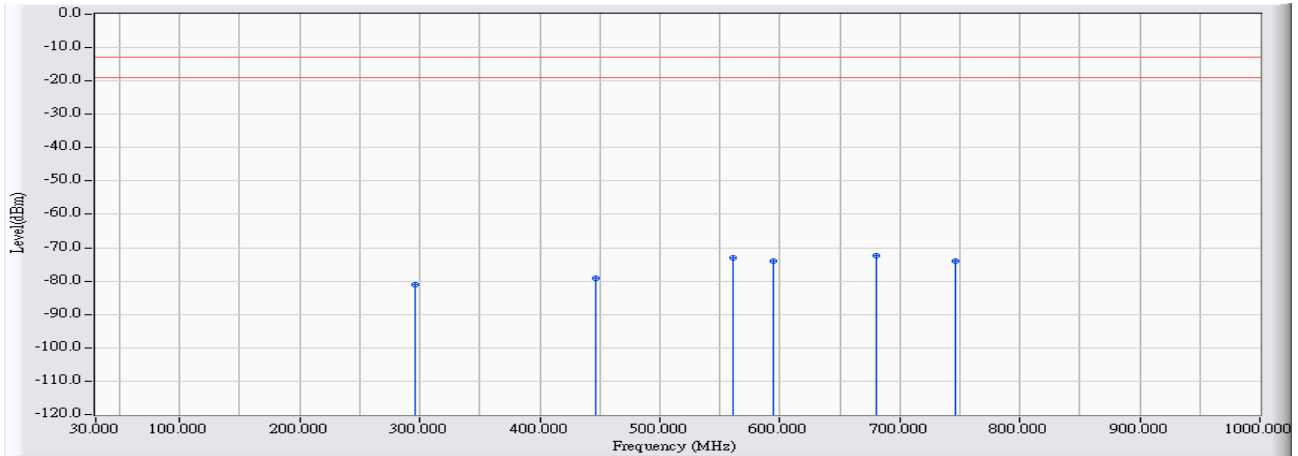

	Frequency (MHz)	Correct Factor (dB)	Reading Level (dBm)	Measure Level (dBm)	Margin (dB)	Limit (dBm)	Detector Type
1	295.780	-20.635	-60.445	-81.080	-68.080	-13.000	QUASIPeAK
2	447.100	-15.221	-63.951	-79.171	-66.171	-13.000	QUASIPeAK
3	561.560	-13.160	-59.841	-73.001	-60.001	-13.000	QUASIPeAK
4	595.025	-12.948	-60.902	-73.850	-60.850	-13.000	QUASIPeAK
5	* 679.900	-11.476	-60.959	-72.435	-59.435	-13.000	QUASIPeAK
6	746.345	-11.036	-63.065	-74.101	-61.101	-13.000	QUASIPeAK

Note:

1. All Reading Levels are Quasi-Peak value.
2. “ * ”, means this data is the worst emission level.
3. Measurement Level = Reading Level + Correct Factor.

Site : CB4-H	Time : 2017/02/15
Limit : FCC_Part22/24_00M_00M_PK	Margin : 6
Probe : CB4-H_CE_Sub_S2_30M-1GHz_1116 - VERTICAL	Power : DC 3.8V
EUT : LE910C1-NA	Note : Mode 3: DCS 1900_Link Mode_1880MHz

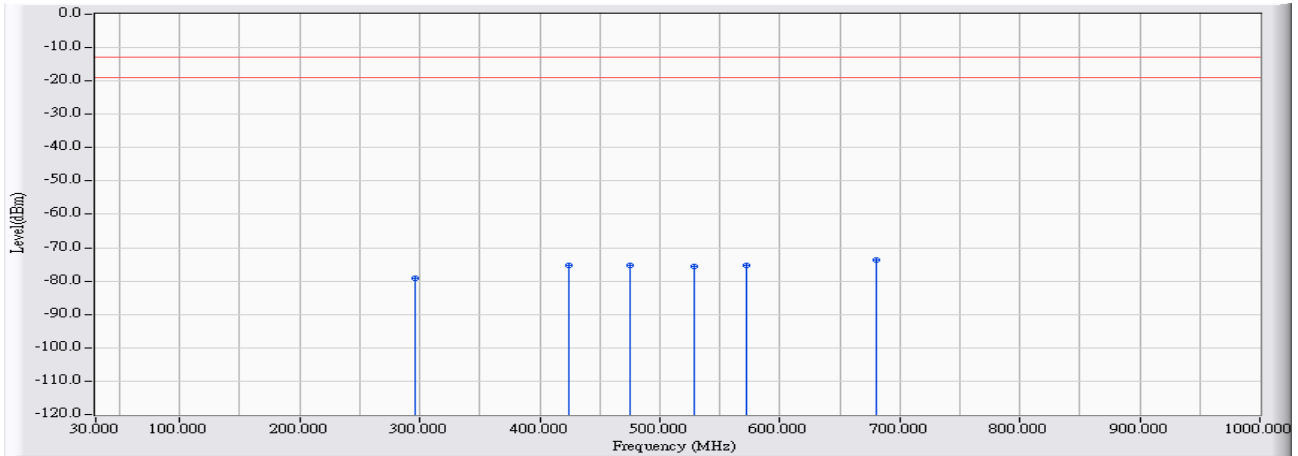

		Frequency (MHz)	Correct Factor (dB)	Reading Level (dBm)	Measure Level (dBm)	Margin (dB)	Limit (dBm)	Detector Type
1		295.780	-20.340	-58.738	-79.078	-66.078	-13.000	QUASIPeAK
2		424.790	-16.216	-59.223	-75.440	-62.440	-13.000	QUASIPeAK
3		475.230	-14.662	-60.578	-75.240	-62.240	-13.000	QUASIPeAK
4		528.095	-13.636	-62.057	-75.694	-62.694	-13.000	QUASIPeAK
5		572.715	-12.486	-62.652	-75.138	-62.138	-13.000	QUASIPeAK
6	*	679.900	-11.032	-62.524	-73.556	-60.556	-13.000	QUASIPeAK

Note:

1. All Reading Levels are Quasi-Peak value.
2. “ * ”, means this data is the worst emission level.
3. Measurement Level = Reading Level + Correct Factor.

Site : CB4-H	Time : 2017/02/15
Limit : FCC_Part22/24_00M_00M_PK	Margin : 6
Probe : CB4-H_CE_Sub_S2_30M-1GHz_1116 - HORIZONTAL	Power : DC 3.8V
EUT : LE910C1-NA	Note : Mode 4: DCS 1900_Idle Mode_1880MHz

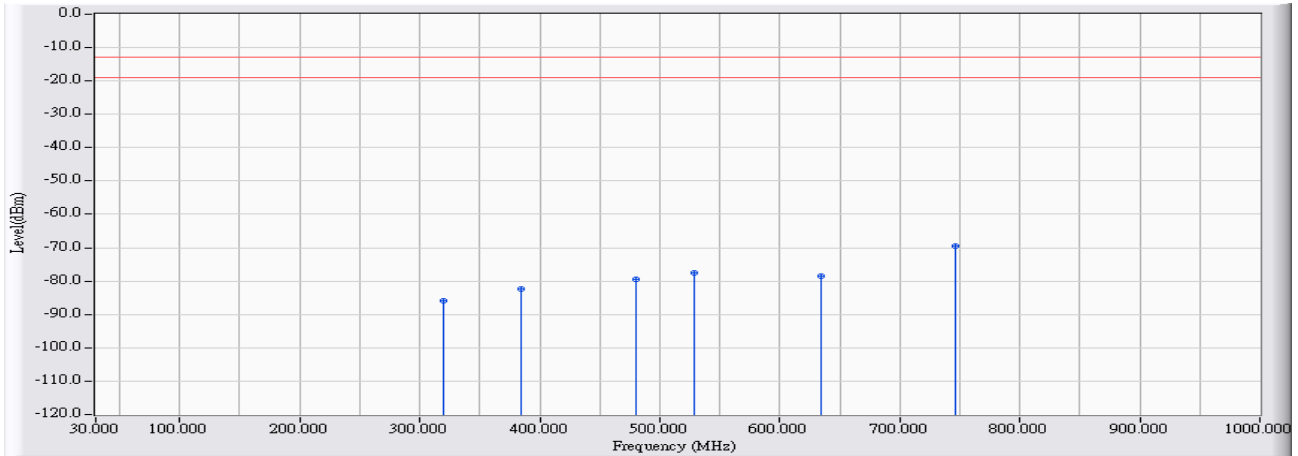

		Frequency (MHz)	Correct Factor (dB)	Reading Level (dBm)	Measure Level (dBm)	Margin (dB)	Limit (dBm)	Detector Type
1		320.030	-19.857	-66.173	-86.031	-73.031	-13.000	QUASPEAK
2		384.050	-16.999	-65.467	-82.466	-69.466	-13.000	QUASPEAK
3		480.080	-14.908	-64.677	-79.584	-66.584	-13.000	QUASPEAK
4		528.095	-14.105	-63.546	-77.651	-64.651	-13.000	QUASPEAK
5		634.310	-12.413	-66.082	-78.496	-65.496	-13.000	QUASPEAK
6	*	745.860	-11.003	-58.458	-69.461	-56.461	-13.000	QUASPEAK

Note:

1. All Reading Levels are Quasi-Peak value.
2. “ * ”, means this data is the worst emission level.
3. Measurement Level = Reading Level + Correct Factor.

Site : CB4-H	Time : 2017/02/15
Limit : FCC_Part22/24_00M_00M_PK	Margin : 6
Probe : CB4-H_CE_Sub_S2_30M-1GHz_1116 - VERTICAL	Power : DC 3.8V
EUT : LE910C1-NA	Note : Mode 4: DCS 1900_Idle Mode_1880MHz

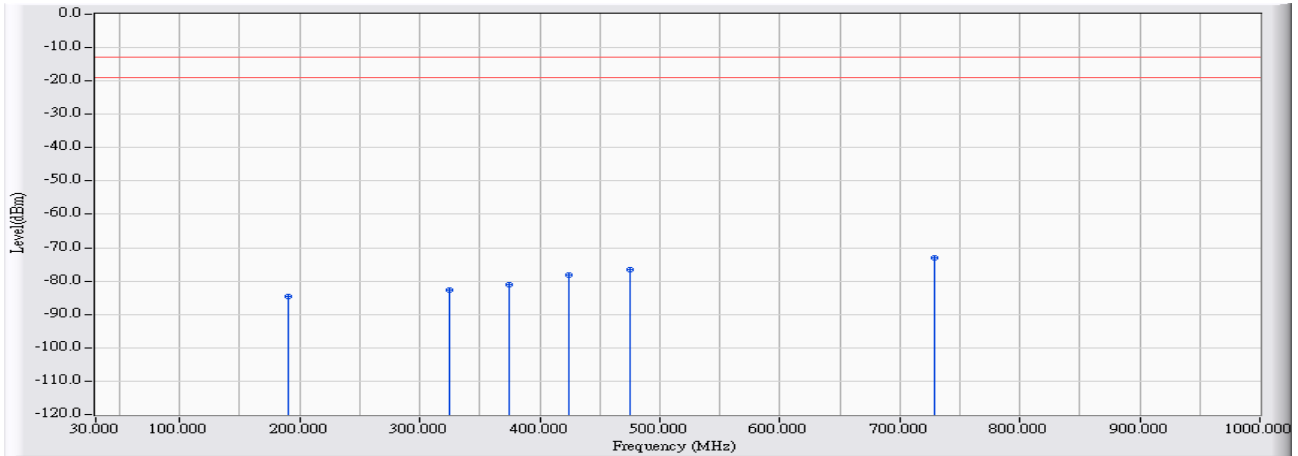

		Frequency (MHz)	Correct Factor (dB)	Reading Level (dBm)	Measure Level (dBm)	Margin (dB)	Limit (dBm)	Detector Type
1		191.020	-24.006	-60.707	-84.714	-71.714	-13.000	QUASIPeAK
2		324.880	-19.453	-63.259	-82.712	-69.712	-13.000	QUASIPeAK
3		374.835	-17.733	-63.468	-81.201	-68.201	-13.000	QUASIPeAK
4		424.790	-16.216	-61.866	-78.083	-65.083	-13.000	QUASIPeAK
5		474.745	-14.669	-61.977	-76.646	-63.646	-13.000	QUASIPeAK
6	*	729.370	-10.253	-62.922	-73.174	-60.174	-13.000	QUASIPeAK

Note:

1. All Reading Levels are Quasi-Peak value.
2. “ * ”, means this data is the worst emission level.
3. Measurement Level = Reading Level + Correct Factor.

Site : CB4-H	Time : 2017/02/15
Limit : FCC_Part22/24_00M_00M_PK	Margin : 6
Probe : CB4-H_CE_Sub_S2_30M-1GHz_1116 - HORIZONTAL	Power : DC 3.8V
EUT : LE910C1-NA	Note : Mode 5: GSM_EGPRS 850_Link Mode_ 836.6MHz

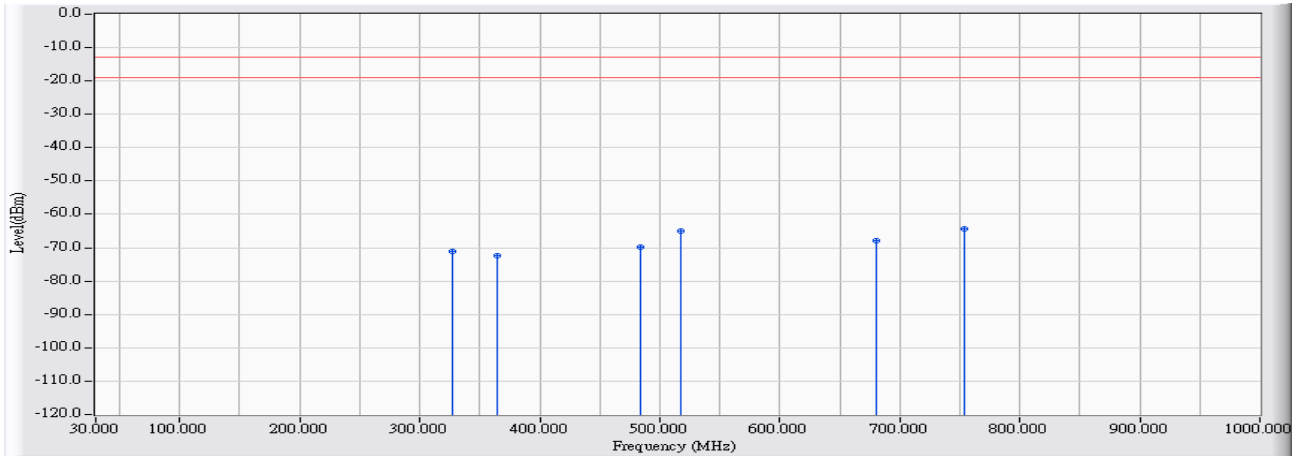

		Frequency (MHz)	Correct Factor (dB)	Reading Level (dBm)	Measure Level (dBm)	Margin (dB)	Limit (dBm)	Detector Type
1		326.820	-19.399	-51.680	-71.078	-58.078	-13.000	QUASPEAK
2		364.650	-17.915	-54.515	-72.430	-59.430	-13.000	QUASPEAK
3		483.960	-14.782	-55.098	-69.879	-56.879	-13.000	QUASPEAK
4		517.425	-13.870	-51.230	-65.100	-52.100	-13.000	QUASPEAK
5		680.385	-11.492	-56.313	-67.805	-54.805	-13.000	QUASPEAK
6	*	754.105	-11.160	-53.330	-64.490	-51.490	-13.000	QUASPEAK

Note:

1. All Reading Levels are Quasi-Peak value.
2. “ * ”, means this data is the worst emission level.
3. Measurement Level = Reading Level + Correct Factor.

Site : CB4-H	Time : 2017/02/15
Limit : FCC_Part22/24_00M_00M_PK	Margin : 6
Probe : CB4-H_CE_Sub_S2_30M-1GHz_1116 - VERTICAL	Power : DC 3.8V
EUT : LE910C1-NA	Note : Mode 5: GSM_EGPRS 850_Link Mode_ 836.6MHz

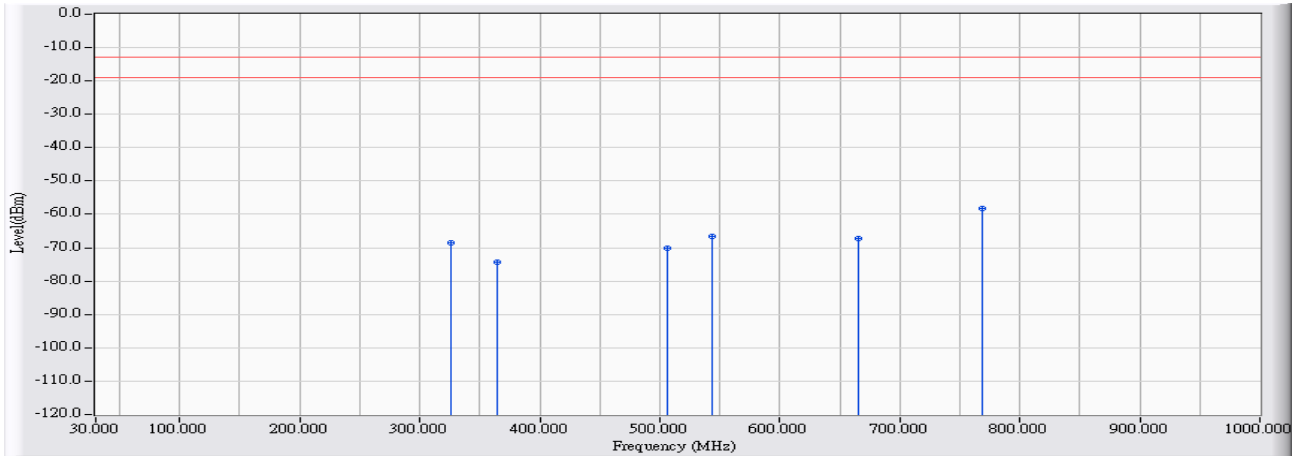

		Frequency (MHz)	Correct Factor (dB)	Reading Level (dBm)	Measure Level (dBm)	Margin (dB)	Limit (dBm)	Detector Type
1		326.335	-19.363	-49.299	-68.661	-55.661	-13.000	QUASPEAK
2		366.650	-18.041	-56.231	-74.271	-61.271	-13.000	QUASPEAK
3		506.755	-13.676	-56.377	-70.053	-57.053	-13.000	QUASPEAK
4		543.615	-13.014	-53.624	-66.638	-53.638	-13.000	QUASPEAK
5		665.835	-11.427	-55.735	-67.161	-54.161	-13.000	QUASPEAK
6	*	769.140	-9.991	-48.099	-58.090	-45.090	-13.000	QUASPEAK

Note:

1. All Reading Levels are Quasi-Peak value.
2. “ * ”, means this data is the worst emission level.
3. Measurement Level = Reading Level + Correct Factor.

Site : CB4-H	Time : 2017/02/15
Limit : FCC_Part22/24_00M_00M_PK	Margin : 6
Probe : CB4-H_CE_Sub_S2_30M-1GHz_1116 - HORIZONTAL	Power : DC 3.8V
EUT : LE910C1-NA	Note : Mode 6: GSM_EGPRS 850_Idle Mode_ 836.6MHz

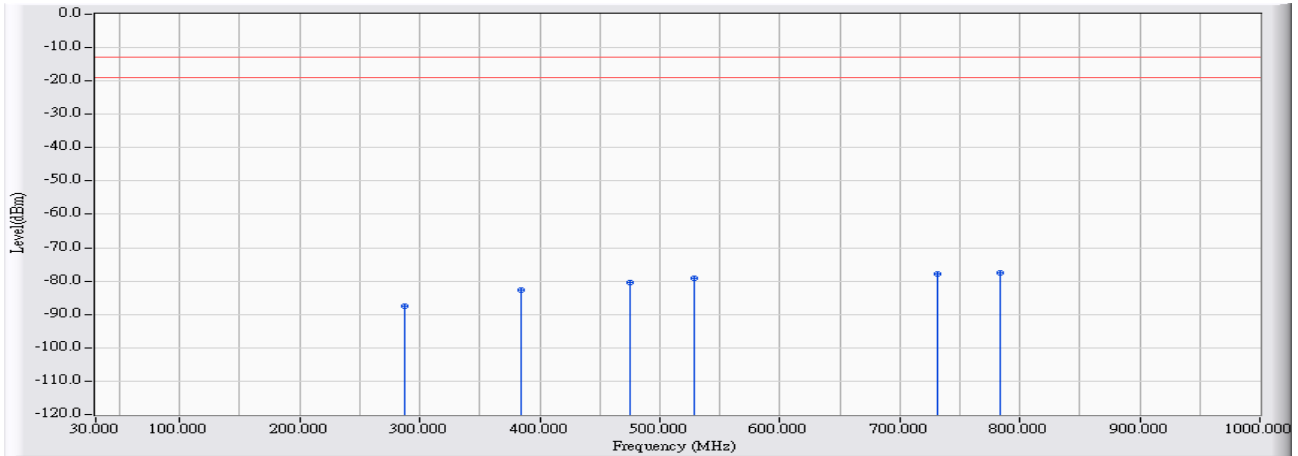

	Frequency (MHz)	Correct Factor (dB)	Reading Level (dBm)	Measure Level (dBm)	Margin (dB)	Limit (dBm)	Detector Type
1	288.020	-20.954	-66.705	-87.659	-74.659	-13.000	QUASIPeAK
2	384.050	-16.999	-65.567	-82.566	-69.566	-13.000	QUASIPeAK
3	474.745	-14.940	-65.626	-80.566	-67.566	-13.000	QUASIPeAK
4	528.095	-14.105	-65.037	-79.142	-66.142	-13.000	QUASIPeAK
5	731.795	-10.572	-67.441	-78.013	-65.013	-13.000	QUASIPeAK
6	* 783.205	-9.358	-68.160	-77.518	-64.518	-13.000	QUASIPeAK

Note:

1. All Reading Levels are Quasi-Peak value.
2. “ * ”, means this data is the worst emission level.
3. Measurement Level = Reading Level + Correct Factor.

Site : CB4-H	Time : 2017/02/15
Limit : FCC_Part22/24_00M_00M_PK	Margin : 6
Probe : CB4-H_CE_Sub_S2_30M-1GHz_1116 - VERTICAL	Power : DC 3.8V
EUT : LE910C1-NA	Note : Mode 6: GSM_EGPRS 850_Idle Mode_ 836.6MHz

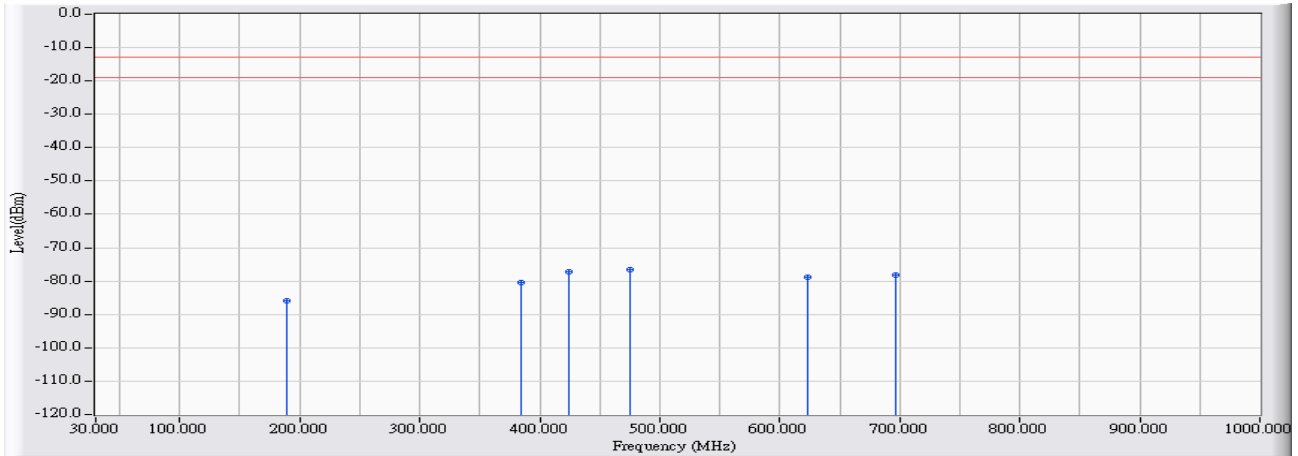

	Frequency (MHz)	Correct Factor (dB)	Reading Level (dBm)	Measure Level (dBm)	Margin (dB)	Limit (dBm)	Detector Type
1	189.080	-23.846	-62.115	-85.961	-72.961	-13.000	QUASIPeAK
2	384.050	-17.223	-63.297	-80.520	-67.520	-13.000	QUASIPeAK
3	424.790	-16.216	-61.078	-77.295	-64.295	-13.000	QUASIPeAK
4	* 475.230	-14.662	-61.843	-76.505	-63.505	-13.000	QUASIPeAK
5	623.640	-11.336	-67.398	-78.734	-65.734	-13.000	QUASIPeAK
6	696.390	-11.685	-66.430	-78.115	-65.115	-13.000	QUASIPeAK

Note:

1. All Reading Levels are Quasi-Peak value.
2. “ * ”, means this data is the worst emission level.
3. Measurement Level = Reading Level + Correct Factor.

Site : CB4-H	Time : 2017/02/15
Limit : FCC_Part22/24_00M_00M_PK	Margin : 6
Probe : CB4-H_CE_Sub_S2_30M-1GHz_1116 - HORIZONTAL	Power : DC 3.8V
EUT : LE910C1-NA	Note : Mode 7: DCS_EGPRS 1900_Link Mode_1880MHz

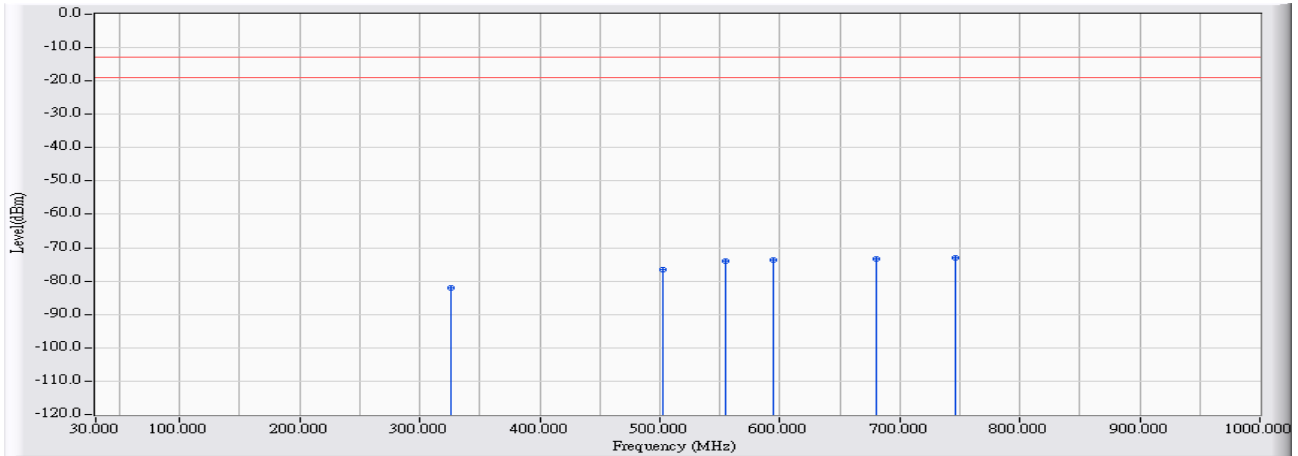

		Frequency (MHz)	Correct Factor (dB)	Reading Level (dBm)	Measure Level (dBm)	Margin (dB)	Limit (dBm)	Detector Type
1		325.365	-19.497	-62.409	-81.906	-68.906	-13.000	QUASIPeAK
2		502.390	-14.312	-62.249	-76.561	-63.561	-13.000	QUASIPeAK
3		554.285	-13.282	-60.698	-73.980	-60.980	-13.000	QUASIPeAK
4		594.540	-12.981	-60.558	-73.539	-60.539	-13.000	QUASIPeAK
5		679.900	-11.476	-61.795	-73.271	-60.271	-13.000	QUASIPeAK
6	*	746.830	-11.069	-61.977	-73.046	-60.046	-13.000	QUASIPeAK

Note:

1. All Reading Levels are Quasi-Peak value.
2. “ * ”, means this data is the worst emission level.
3. Measurement Level = Reading Level + Correct Factor.

Site : CB4-H	Time : 2017/02/15
Limit : FCC_Part22/24_00M_00M_PK	Margin : 6
Probe : CB4-H_CE_Sub_S2_30M-1GHz_1116 - VERTICAL	Power : DC 3.8V
EUT : LE910C1-NA	Note : Mode 7: DCS_EGPRS 1900_Link Mode_1880MHz

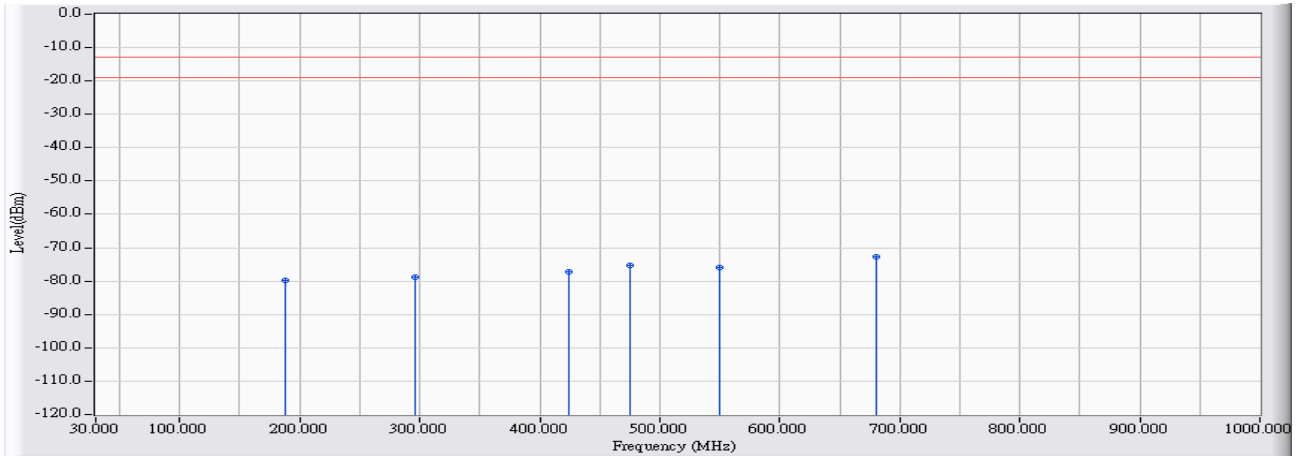

	Frequency (MHz)	Correct Factor (dB)	Reading Level (dBm)	Measure Level (dBm)	Margin (dB)	Limit (dBm)	Detector Type
1	188.110	-23.773	-55.935	-79.709	-66.709	-13.000	QUASPEAK
2	295.780	-20.340	-58.388	-78.728	-65.728	-13.000	QUASPEAK
3	424.790	-16.216	-60.899	-77.116	-64.116	-13.000	QUASPEAK
4	475.230	-14.662	-60.572	-75.234	-62.234	-13.000	QUASPEAK
5	550.405	-12.814	-63.262	-76.076	-63.076	-13.000	QUASPEAK
6	* 679.900	-11.032	-61.707	-72.739	-59.739	-13.000	QUASPEAK

Note:

1. All Reading Levels are Quasi-Peak value.
2. “ * ”, means this data is the worst emission level.
3. Measurement Level = Reading Level + Correct Factor.

Site : CB4-H	Time : 2017/02/15
Limit : FCC_Part22/24_00M_00M_PK	Margin : 6
Probe : CB4-H_CE_Sub_S2_30M-1GHz_1116 - HORIZONTAL	Power : DC 3.8V
EUT : LE910C1-NA	Note : Mode 8: DCS_EGPRS 1900_Idle Mode_1880MHz

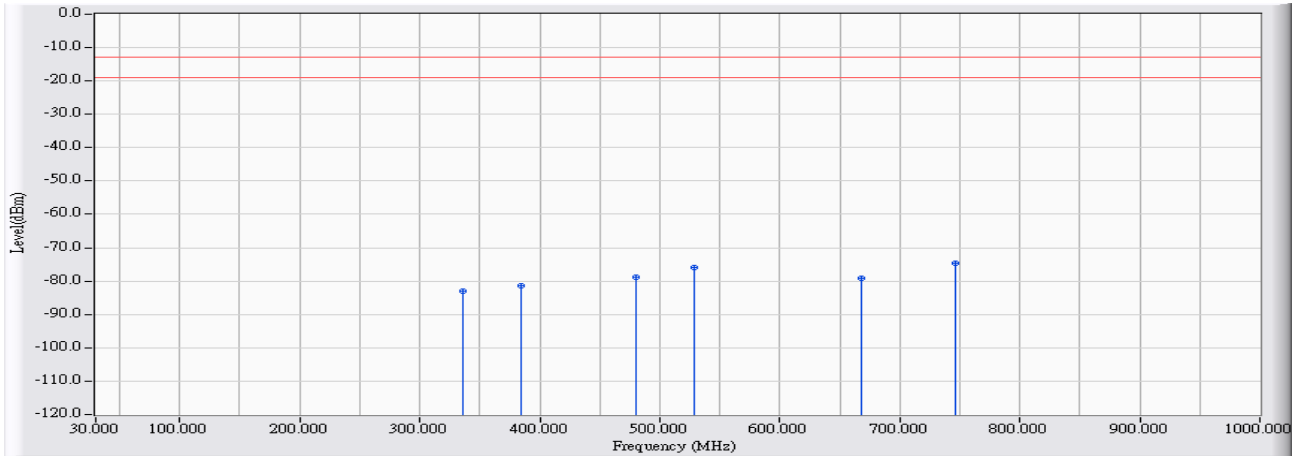

		Frequency (MHz)	Correct Factor (dB)	Reading Level (dBm)	Measure Level (dBm)	Margin (dB)	Limit (dBm)	Detector Type
1		336.035	-18.742	-64.376	-83.118	-70.118	-13.000	QUASIPeAK
2		384.050	-16.999	-64.496	-81.495	-68.495	-13.000	QUASIPeAK
3		480.080	-14.908	-63.780	-78.687	-65.687	-13.000	QUASIPeAK
4		528.095	-14.105	-61.767	-75.872	-62.872	-13.000	QUASIPeAK
5		667.775	-11.769	-67.336	-79.105	-66.105	-13.000	QUASIPeAK
6	*	746.830	-11.069	-63.505	-74.574	-61.574	-13.000	QUASIPeAK

Note:

1. All Reading Levels are Quasi-Peak value.
2. “ * ”, means this data is the worst emission level.
3. Measurement Level = Reading Level + Correct Factor.

Site : CB4-H	Time : 2017/02/15
Limit : FCC_Part22/24_00M_00M_PK	Margin : 6
Probe : CB4-H_CE_Sub_S2_30M-1GHz_1116 - VERTICAL	Power : DC 3.8V
EUT : LE910C1-NA	Note : Mode 8: DCS_EGPRS 1900_Idle Mode_1880MHz

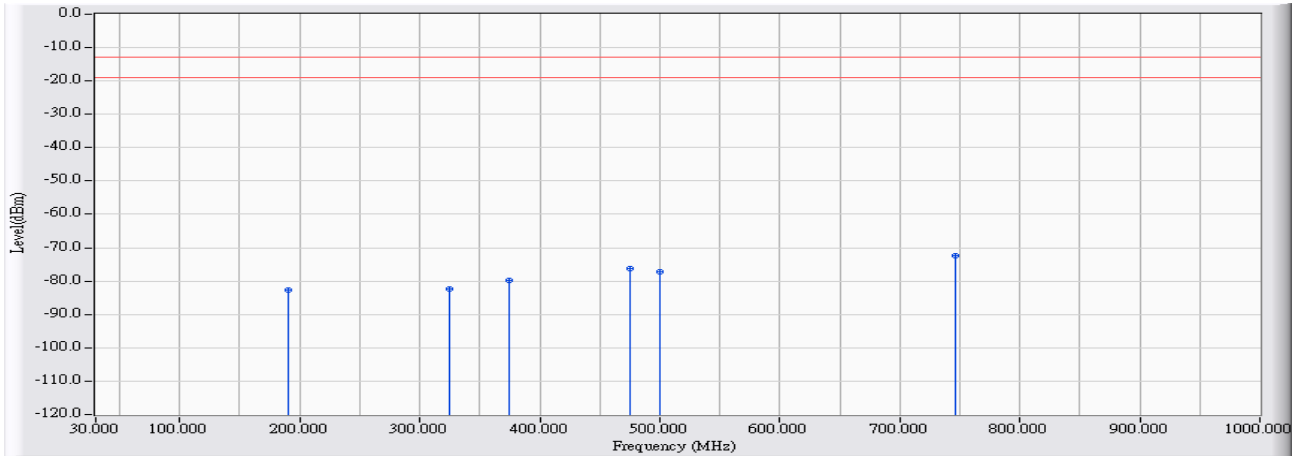

	Frequency (MHz)	Correct Factor (dB)	Reading Level (dBm)	Measure Level (dBm)	Margin (dB)	Limit (dBm)	Detector Type
1	190.535	-23.962	-58.589	-82.551	-69.551	-13.000	QUASIPeAK
2	324.880	-19.453	-63.042	-82.495	-69.495	-13.000	QUASIPeAK
3	374.835	-17.733	-62.183	-79.916	-66.916	-13.000	QUASIPeAK
4	474.745	-14.669	-61.570	-76.239	-63.239	-13.000	QUASIPeAK
5	499.965	-13.993	-63.147	-77.141	-64.141	-13.000	QUASIPeAK
6	* 746.830	-10.734	-61.791	-72.525	-59.525	-13.000	QUASIPeAK

Note:

1. All Reading Levels are Quasi-Peak value.
2. “ * ”, means this data is the worst emission level.
3. Measurement Level = Reading Level + Correct Factor.

Site : CB4-H	Time : 2017/02/20
Limit : Part_22/24_00M_PK	Margin : 6
Probe : CB4-H_CE_Sub_30-1GHz_3M_0117 - HORIZONTAL	Power : DC 3.8V
EUT : LE910C1-NA	Note : Mode 9: WCDMA Band 5_Link Mode_836.6MHz

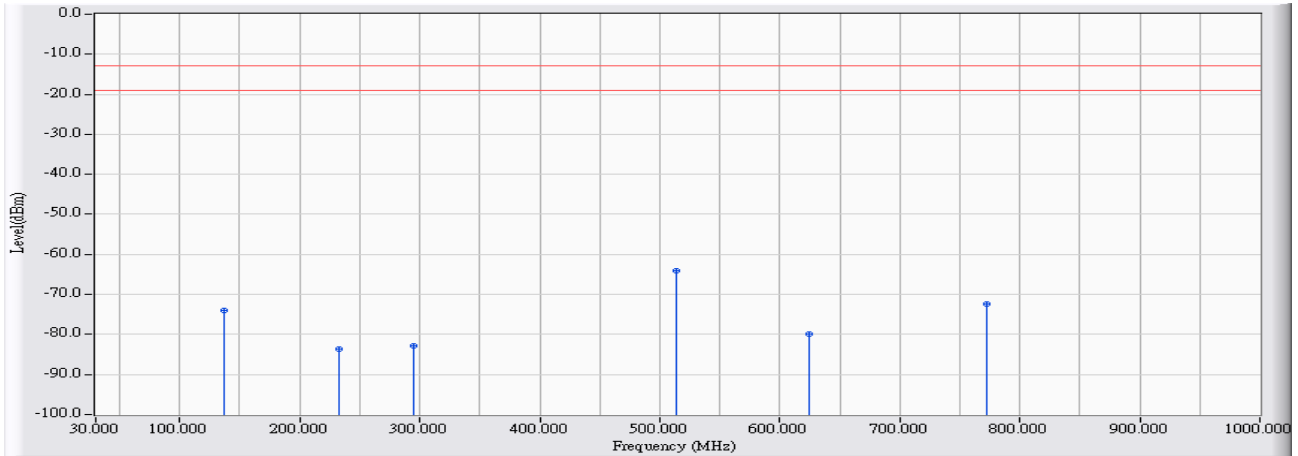

		Frequency (MHz)	Correct Factor (dB)	Reading Level (dBm)	Measure Level (dBm)	Margin (dB)	Limit (dBm)	Detector Type
1		136.883	-28.463	-45.462	-73.925	-60.925	-13.000	QUASPEAK
2		233.292	-26.857	-56.865	-83.721	-70.721	-13.000	QUASPEAK
3		294.881	-25.059	-57.820	-82.880	-69.880	-13.000	QUASPEAK
4	*	513.206	-19.147	-44.893	-64.041	-51.041	-13.000	QUASPEAK
5		623.969	-17.209	-62.691	-79.900	-66.900	-13.000	QUASPEAK
6		772.752	-16.012	-56.364	-72.376	-59.376	-13.000	QUASPEAK

Note:

1. All Reading Levels are Quasi-Peak value.
2. “ * ”, means this data is the worst emission level.
3. Measurement Level = Reading Level + Correct Factor.

Site : CB4-H	Time : 2017/02/20
Limit : Part_22/24_00M_PK	Margin : 6
Probe : CB4-H_CE_Sub_30-1GHz_3M_0117 - VERTICAL	Power : DC 3.8V
EUT : LE910C1-NA	Note : Mode 9: WCDMA Band 5_Link Mode_836.6MHz

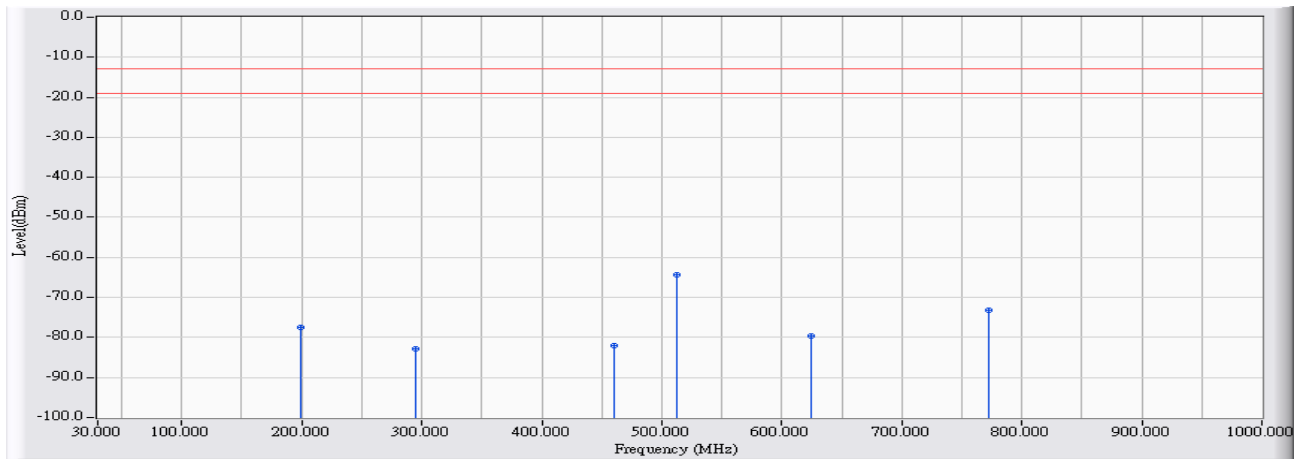

	Frequency (MHz)	Correct Factor (dB)	Reading Level (dBm)	Measure Level (dBm)	Margin (dB)	Limit (dBm)	Detector Type
1	198.957	-28.133	-49.337	-77.470	-64.470	-13.000	QUASPEAK
2	294.881	-24.006	-58.894	-82.900	-69.900	-13.000	QUASPEAK
3	460.831	-18.979	-63.042	-82.020	-69.020	-13.000	QUASPEAK
4	* 513.109	-18.068	-46.362	-64.430	-51.430	-13.000	QUASPEAK
5	623.969	-15.913	-63.775	-79.687	-66.687	-13.000	QUASPEAK
6	772.655	-15.303	-57.971	-73.274	-60.274	-13.000	QUASPEAK

Note:

1. All Reading Levels are Quasi-Peak value.
2. “ * ”, means this data is the worst emission level.
3. Measurement Level = Reading Level + Correct Factor.

Site : CB4-H	Time : 2017/02/20
Limit : Part_22/24_00M_PK	Margin : 6
Probe : CB4-H_CE_Sub_30-1GHz_3M_0117 - HORIZONTAL	Power : DC 3.8V
EUT : LE910C1-NA	Note : Mode 10: WCDMA Band 5_Idle Mode_836.6MHz

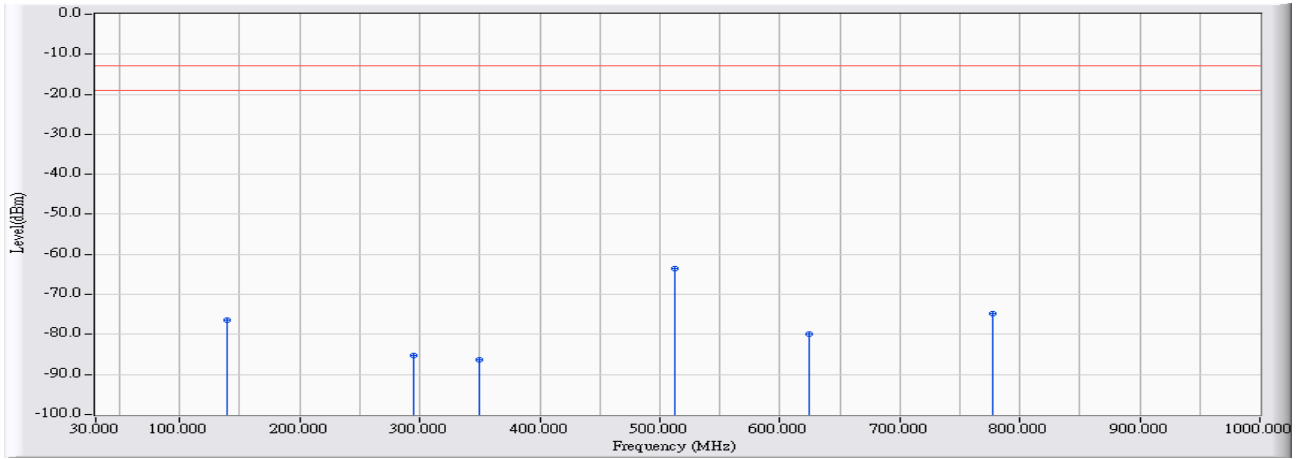

		Frequency (MHz)	Correct Factor (dB)	Reading Level (dBm)	Measure Level (dBm)	Margin (dB)	Limit (dBm)	Detector Type
1		138.823	-28.419	-48.019	-76.438	-63.438	-13.000	QUASIPeAK
2		294.881	-25.059	-60.095	-85.155	-72.155	-13.000	QUASIPeAK
3		350.165	-22.782	-63.535	-86.317	-73.317	-13.000	QUASIPeAK
4	*	513.109	-19.146	-44.280	-63.426	-50.426	-13.000	QUASIPeAK
5		623.969	-17.209	-62.614	-79.823	-66.823	-13.000	QUASIPeAK
6		777.407	-15.933	-58.816	-74.750	-61.750	-13.000	QUASIPeAK

Note:

1. All Reading Levels are Quasi-Peak value.
2. “ * ”, means this data is the worst emission level.
3. Measurement Level = Reading Level + Correct Factor.

Site : CB4-H	Time : 2017/02/20
Limit : Part_22/24_00M_PK	Margin : 6
Probe : CB4-H_CE_Sub_30-1GHz_3M_0117 - VERTICAL	Power : DC 3.8V
EUT : LE910C1-NA	Note : Mode 10: WCDMA Band 5_Idle Mode_836.6MHz

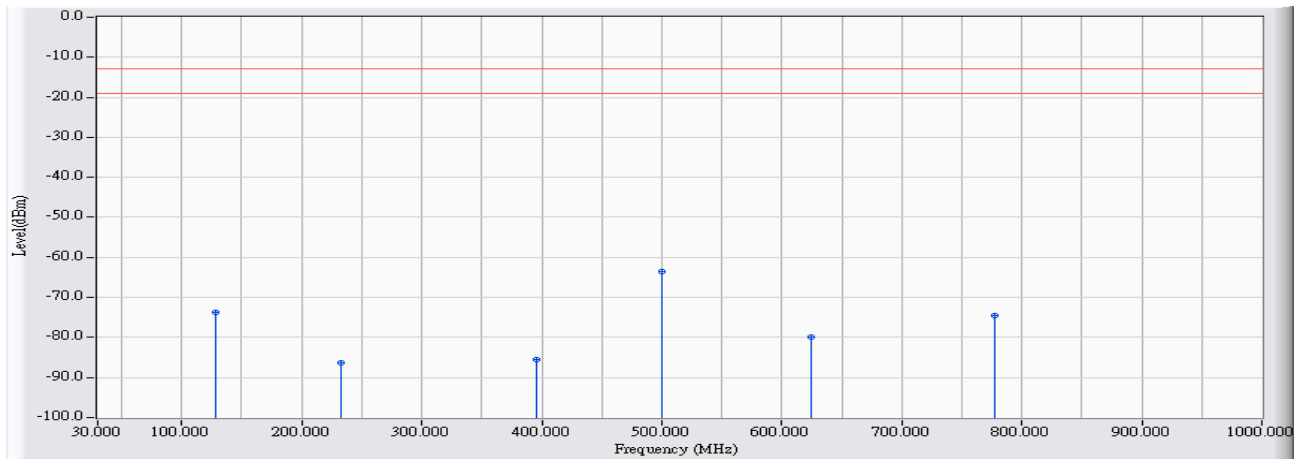

		Frequency (MHz)	Correct Factor (dB)	Reading Level (dBm)	Measure Level (dBm)	Margin (dB)	Limit (dBm)	Detector Type
1		128.154	-22.956	-50.821	-73.778	-60.778	-13.000	QUASIPeAK
2		233.292	-26.585	-59.694	-86.278	-73.278	-13.000	QUASIPeAK
3		396.235	-20.771	-64.796	-85.567	-72.567	-13.000	QUASIPeAK
4	*	499.821	-19.195	-44.457	-63.653	-50.653	-13.000	QUASIPeAK
5		623.969	-15.913	-64.109	-80.021	-67.021	-13.000	QUASIPeAK
6		777.116	-15.073	-59.586	-74.659	-61.659	-13.000	QUASIPeAK

Note:

1. All Reading Levels are Quasi-Peak value.
2. “ * ”, means this data is the worst emission level.
3. Measurement Level = Reading Level + Correct Factor.

Site : CB4-H	Time : 2017/02/20
Limit : Part_22/24_00M_PK	Margin : 6
Probe : CB4-H_CE_Sub_30-1GHz_3M_0117 - HORIZONTAL	Power : DC 3.8V
EUT : LE910C1-NA	Note : Mode 11: WCDMA Band 2_Link Mode_1880MHz

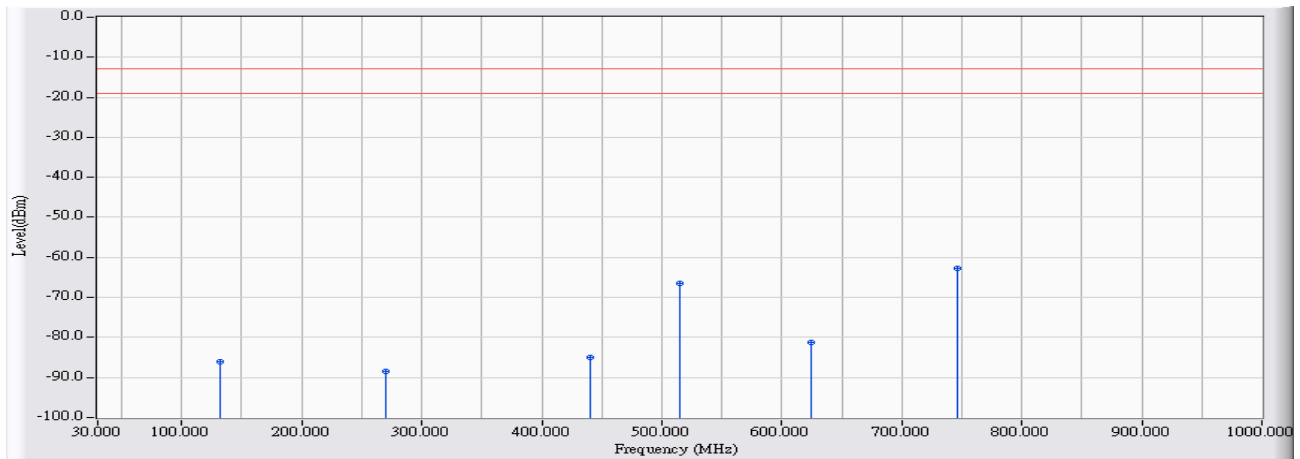

		Frequency (MHz)	Correct Factor (dB)	Reading Level (dBm)	Measure Level (dBm)	Margin (dB)	Limit (dBm)	Detector Type
1		131.743	-28.580	-57.441	-86.021	-73.021	-13.000	QUASIPeAK
2		270.342	-23.729	-64.725	-88.454	-75.454	-13.000	QUASIPeAK
3		440.851	-20.311	-64.733	-85.044	-72.044	-13.000	QUASIPeAK
4		514.467	-19.174	-47.358	-66.532	-53.532	-13.000	QUASIPeAK
5		623.969	-17.209	-64.144	-81.353	-68.353	-13.000	QUASIPeAK
6	*	746.273	-17.137	-45.512	-62.648	-49.648	-13.000	QUASIPeAK

Note:

1. All Reading Levels are Quasi-Peak value.
2. “ * ”, means this data is the worst emission level.
3. Measurement Level = Reading Level + Correct Factor.

Site : CB4-H	Time : 2017/02/20
Limit : Part_22/24_00M_PK	Margin : 6
Probe : CB4-H_CE_Sub_30-1GHz_3M_0117 - VERTICAL	Power : DC 3.8V
EUT : LE910C1-NA	Note : Mode 11: WCDMA Band 2_Link Mode_1880MHz

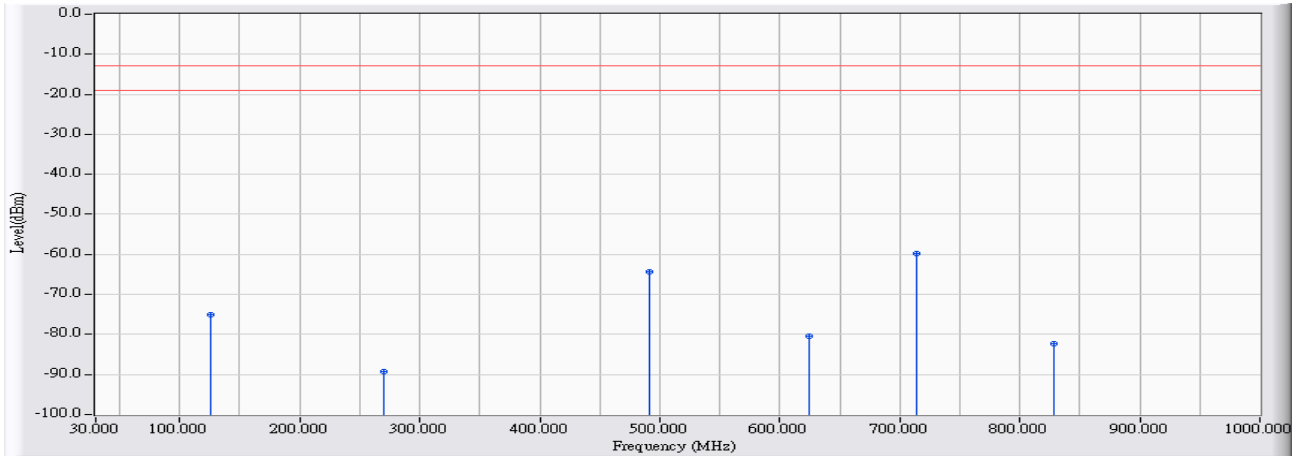

		Frequency (MHz)	Correct Factor (dB)	Reading Level (dBm)	Measure Level (dBm)	Margin (dB)	Limit (dBm)	Detector Type
1		125.147	-22.440	-52.723	-75.163	-62.163	-13.000	QUASIPeAK
2		270.245	-23.406	-65.835	-89.241	-76.241	-13.000	QUASIPeAK
3		491.383	-19.327	-44.889	-64.215	-51.215	-13.000	QUASIPeAK
4		623.969	-15.913	-64.454	-80.366	-67.366	-13.000	QUASIPeAK
5	*	713.491	-16.343	-43.433	-59.776	-46.776	-13.000	QUASIPeAK
6		828.618	-14.805	-67.420	-82.225	-69.225	-13.000	QUASIPeAK

Note:

1. All Reading Levels are Quasi-Peak value.
2. “ * ”, means this data is the worst emission level.
3. Measurement Level = Reading Level + Correct Factor.

Site : CB4-H	Time : 2017/02/20
Limit : Part_22/24_00M_PK	Margin : 6
Probe : CB4-H_CE_Sub_30-1GHz_3M_0117 - HORIZONTAL	Power : DC 3.8V
EUT : LE910C1-NA	Note : Mode 12: WCDMA Band 2_Idle Mode_1880MHz

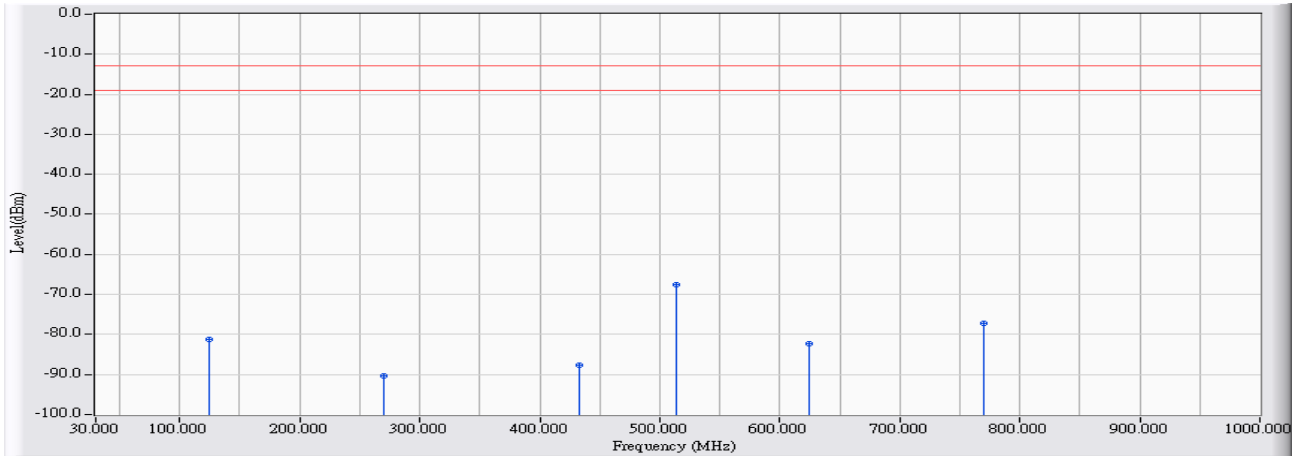

	Frequency (MHz)	Correct Factor (dB)	Reading Level (dBm)	Measure Level (dBm)	Margin (dB)	Limit (dBm)	Detector Type
1	125.050	-28.164	-53.170	-81.333	-68.333	-13.000	QUASIPeAK
2	270.245	-23.722	-66.689	-90.411	-77.411	-13.000	QUASIPeAK
3	432.801	-20.444	-67.129	-87.573	-74.573	-13.000	QUASIPeAK
4	* 513.206	-19.147	-48.495	-67.643	-54.643	-13.000	QUASIPeAK
5	623.969	-17.209	-65.203	-82.412	-69.412	-13.000	QUASIPeAK
6	770.133	-16.055	-61.043	-77.099	-64.099	-13.000	QUASIPeAK

Note:

1. All Reading Levels are Quasi-Peak value.
2. “ * ”, means this data is the worst emission level.
3. Measurement Level = Reading Level + Correct Factor.

Site : CB4-H	Time : 2017/02/20
Limit : Part_22/24_00M_PK	Margin : 6
Probe : CB4-H_CE_Sub_30-1GHz_3M_0117 - VERTICAL	Power : DC 3.8V
EUT : LE910C1-NA	Note : Mode 12: WCDMA Band 2_Idle Mode_1880MHz

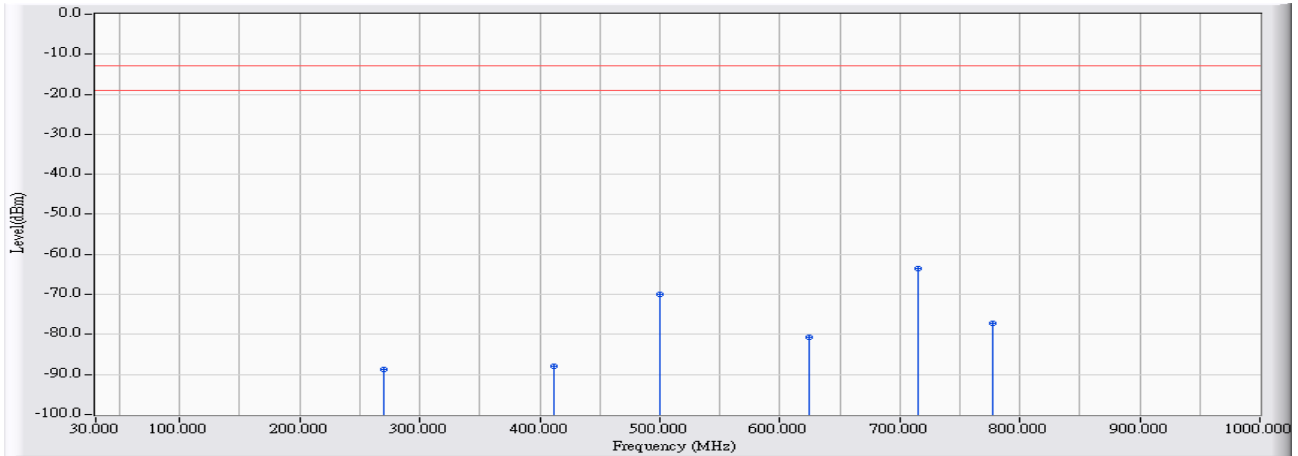

		Frequency (MHz)	Correct Factor (dB)	Reading Level (dBm)	Measure Level (dBm)	Margin (dB)	Limit (dBm)	Detector Type
1		270.245	-23.406	-65.335	-88.741	-75.741	-13.000	QUASPEAK
2		411.560	-20.259	-67.663	-87.922	-74.922	-13.000	QUASPEAK
3		499.821	-19.195	-50.772	-69.968	-56.968	-13.000	QUASPEAK
4		623.969	-15.913	-64.745	-80.657	-67.657	-13.000	QUASPEAK
5	*	715.333	-16.120	-47.407	-63.527	-50.527	-13.000	QUASPEAK
6		777.407	-15.058	-62.078	-77.136	-64.136	-13.000	QUASPEAK

Note:

1. All Reading Levels are Quasi-Peak value.
2. “ * ”, means this data is the worst emission level.
3. Measurement Level = Reading Level + Correct Factor.

Site : CB4-H	Time : 2017/02/23
Limit : FCC_Part22/24_00M_00M_PK	Margin : 6
Probe : CB4-H_CE_Sub_S2_30M-1GHz_1116 - HORIZONTAL	Power : DC 3.8V
EUT : LE910C1-NA	Note : Mode 13: WCDMA Band 5_HSUPA Mode_Link 836.6MHz

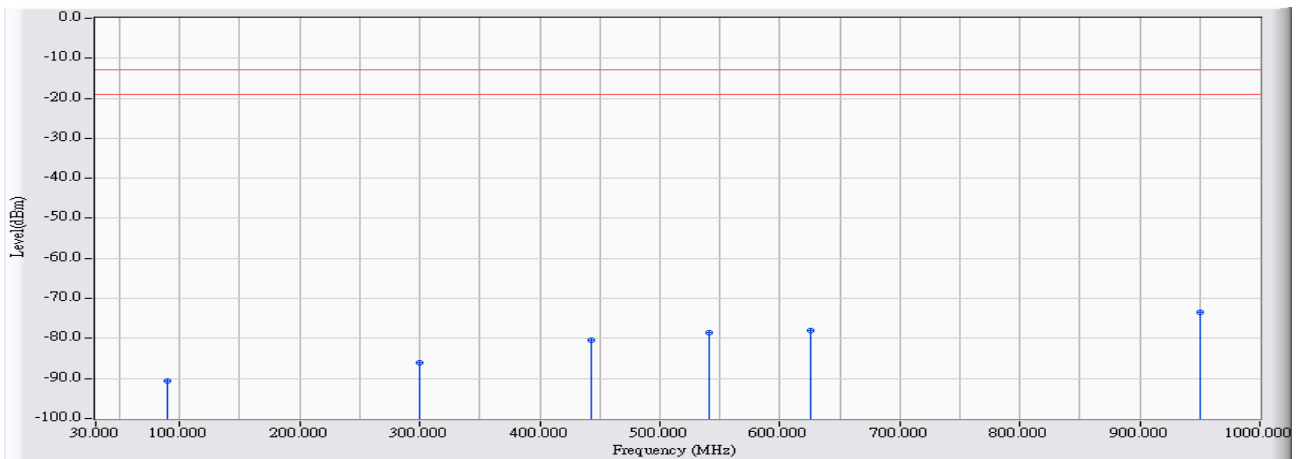

		Frequency (MHz)	Correct Factor (dB)	Reading Level (dBm)	Measure Level (dBm)	Margin (dB)	Limit (dBm)	Detector Type
1		90.140	-28.250	-62.476	-90.725	-77.725	-13.000	PEAK
2		299.660	-20.490	-65.518	-86.009	-73.009	-13.000	PEAK
3		442.735	-15.453	-64.845	-80.298	-67.298	-13.000	PEAK
4		540.705	-13.601	-65.025	-78.626	-65.626	-13.000	PEAK
5		625.095	-11.975	-66.093	-78.068	-65.068	-13.000	PEAK
6	*	950.045	-7.406	-65.992	-73.398	-60.398	-13.000	PEAK

Note:

1. All Reading Levels are Quasi-Peak value.
2. “ * ”, means this data is the worst emission level.
3. Measurement Level = Reading Level + Correct Factor.

Site : CB4-H	Time : 2017/02/23
Limit : FCC_Part22/24_00M_00M_PK	Margin : 6
Probe : CB4-H_CE_Sub_S2_30M-1GHz_1116 - VERTICAL	Power : DC 3.8V
EUT : LE910C1-NA	Note : Mode 13: WCDMA Band 5_HSUPA Mode_Link 836.6MHz

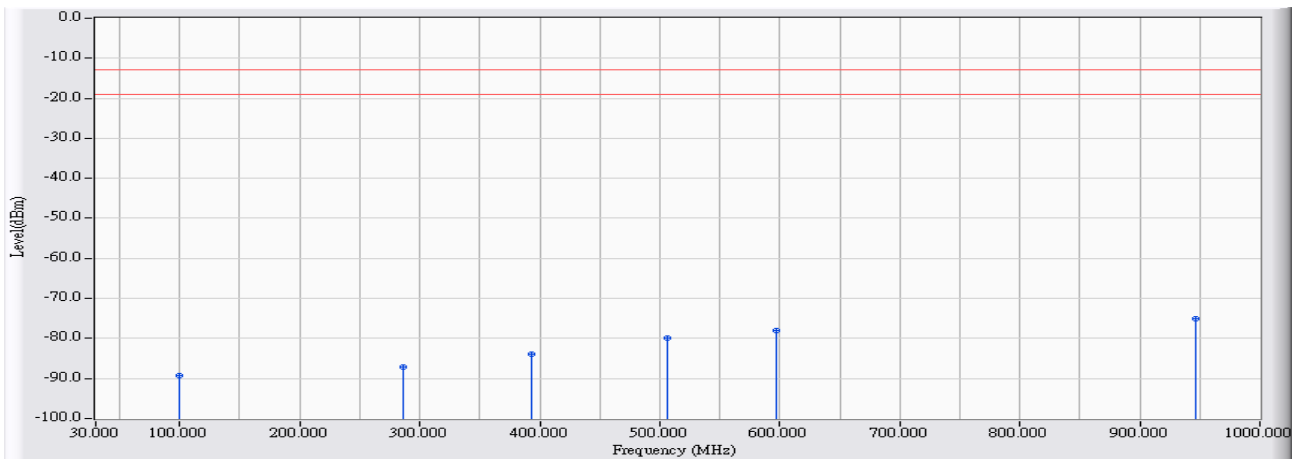

		Frequency (MHz)	Correct Factor (dB)	Reading Level (dBm)	Measure Level (dBm)	Margin (dB)	Limit (dBm)	Detector Type
1		99.840	-19.353	-69.898	-89.251	-76.251	-13.000	PEAK
2		285.595	-20.561	-66.666	-87.227	-74.227	-13.000	PEAK
3		393.265	-16.869	-66.974	-83.842	-70.842	-13.000	PEAK
4		506.755	-13.676	-66.312	-79.988	-66.988	-13.000	PEAK
5		596.480	-12.213	-65.894	-78.108	-65.108	-13.000	PEAK
6	*	947.135	-7.409	-67.780	-75.189	-62.189	-13.000	PEAK

Note:

1. All Reading Levels are Quasi-Peak value.
2. “ * ”, means this data is the worst emission level.
3. Measurement Level = Reading Level + Correct Factor.

Site : CB4-H	Time : 2017/02/23
Limit : FCC_Part22/24_00M_00M_PK	Margin : 6
Probe : CB4-H_CE_Sub_S2_30M-1GHz_1116 - HORIZONTAL	Power : DC 3.8V
EUT : LE910C1-NA	Note : Mode 13: WCDMA Band 5_HSUPA Mode_Idle 836.6MHz

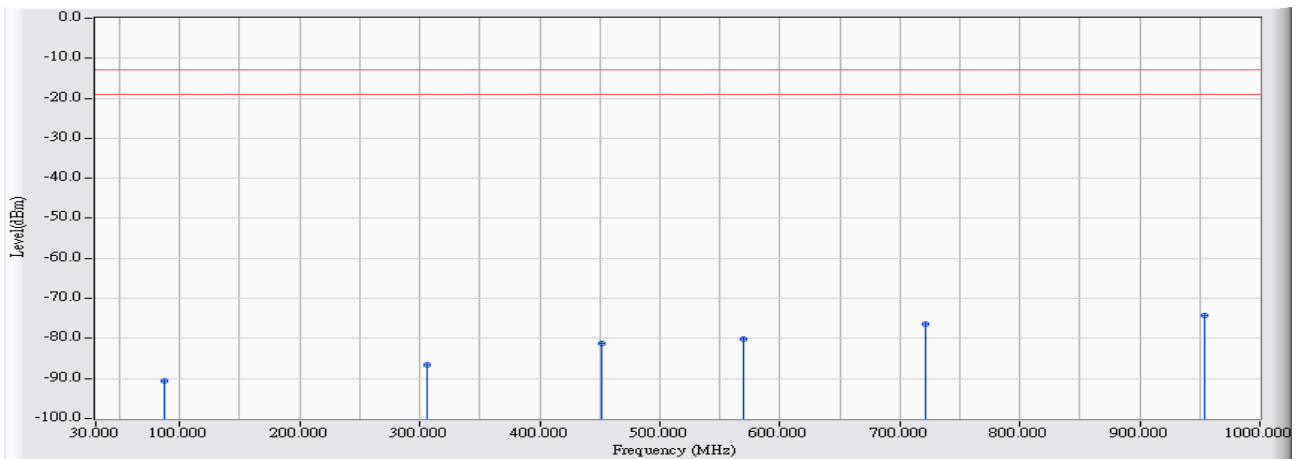

		Frequency (MHz)	Correct Factor (dB)	Reading Level (dBm)	Measure Level (dBm)	Margin (dB)	Limit (dBm)	Detector Type
1		86.745	-28.580	-62.015	-90.596	-77.596	-13.000	PEAK
2		306.450	-20.327	-66.218	-86.545	-73.545	-13.000	PEAK
3		451.465	-15.040	-66.297	-81.337	-68.337	-13.000	PEAK
4		569.805	-12.946	-67.344	-80.290	-67.290	-13.000	PEAK
5		721.610	-11.076	-65.435	-76.511	-63.511	-13.000	PEAK
6	*	954.410	-7.641	-66.543	-74.184	-61.184	-13.000	PEAK

Note:

1. All Reading Levels are Quasi-Peak value.
2. “ * ”, means this data is the worst emission level.
3. Measurement Level = Reading Level + Correct Factor.

Site : CB4-H	Time : 2017/02/23
Limit : FCC_Part22/24_00M_00M_PK	Margin : 6
Probe : CB4-H_CE_Sub_S2_30M-1GHz_1116 - VERTICAL	Power : DC 3.8V
EUT : LE910C1-NA	Note : Mode 13: WCDMA Band 5_HSUPA Mode_Idle 836.6MHz

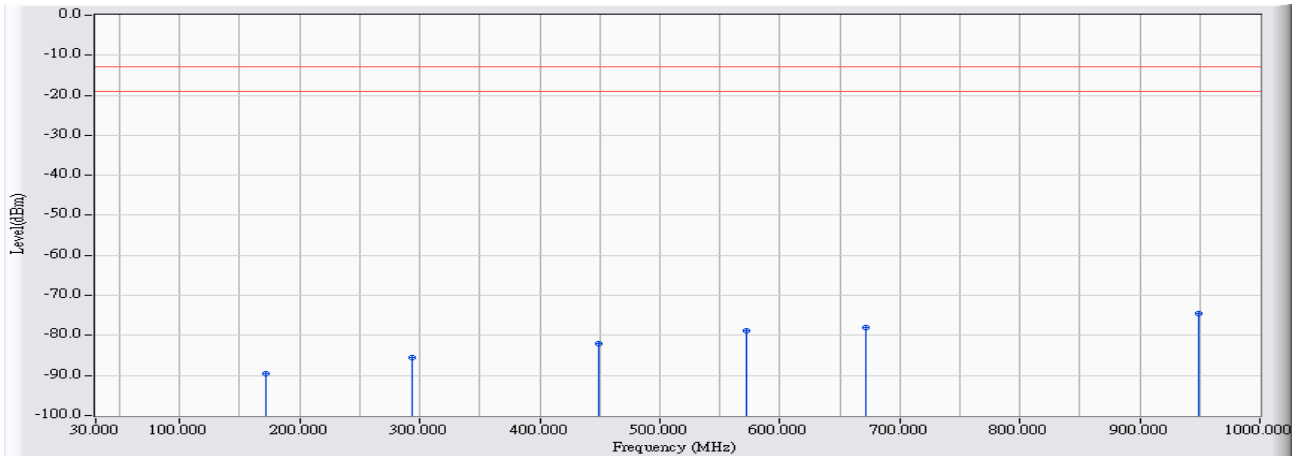

		Frequency (MHz)	Correct Factor (dB)	Reading Level (dBm)	Measure Level (dBm)	Margin (dB)	Limit (dBm)	Detector Type
1		172.105	-22.680	-66.966	-89.647	-76.647	-13.000	PEAK
2		293.840	-20.369	-65.281	-85.650	-72.650	-13.000	PEAK
3		448.555	-15.074	-67.078	-82.152	-69.152	-13.000	PEAK
4		572.715	-12.486	-66.309	-78.795	-65.795	-13.000	PEAK
5		671.170	-11.127	-66.840	-77.966	-64.966	-13.000	PEAK
6	*	949.075	-7.395	-67.165	-74.561	-61.561	-13.000	PEAK

Note:

1. All Reading Levels are Quasi-Peak value.
2. “ * ”, means this data is the worst emission level.
3. Measurement Level = Reading Level + Correct Factor.

Site : CB4-H	Time : 2017/02/23
Limit : FCC_Part22/24_00M_00M_PK	Margin : 6
Probe : CB4-H_CE_Sub_S2_30M-1GHz_1116 - HORIZONTAL	Power : DC 3.8V
EUT : LE910C1-NA	Note : Mode 14: WCDMA Band 5_HSDPA Mode_Link 836.6MHz

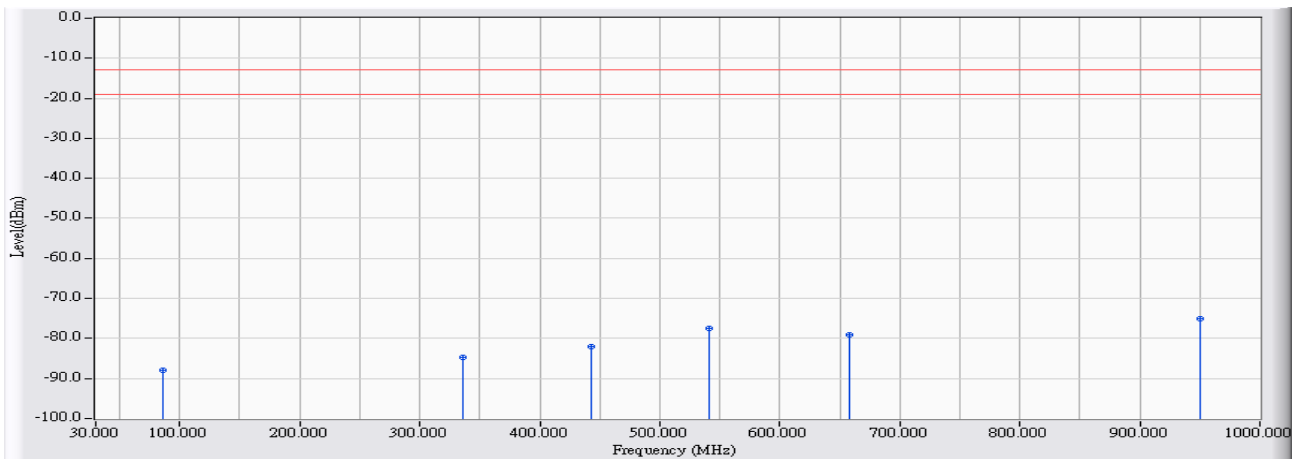

		Frequency (MHz)	Correct Factor (dB)	Reading Level (dBm)	Measure Level (dBm)	Margin (dB)	Limit (dBm)	Detector Type
1		85.775	-28.678	-59.375	-88.053	-75.053	-13.000	PEAK
2		335.550	-18.777	-65.852	-84.629	-71.629	-13.000	PEAK
3		442.735	-15.453	-66.712	-82.165	-69.165	-13.000	PEAK
4		541.675	-13.574	-63.952	-77.526	-64.526	-13.000	PEAK
5		658.560	-12.416	-66.555	-78.972	-65.972	-13.000	PEAK
6	*	950.045	-7.406	-67.660	-75.066	-62.066	-13.000	PEAK

Note:

1. All Reading Levels are Quasi-Peak value.
2. “ * ”, means this data is the worst emission level.
3. Measurement Level = Reading Level + Correct Factor.

Site : CB4-H	Time : 2017/02/23
Limit : FCC_Part22/24_00M_00M_PK	Margin : 6
Probe : CB4-H_CE_Sub_S2_30M-1GHz_1116 - VERTICAL	Power : DC 3.8V
EUT : LE910C1-NA	Note : Mode 14: WCDMA Band 5_HSDPA Mode_Link 836.6MHz

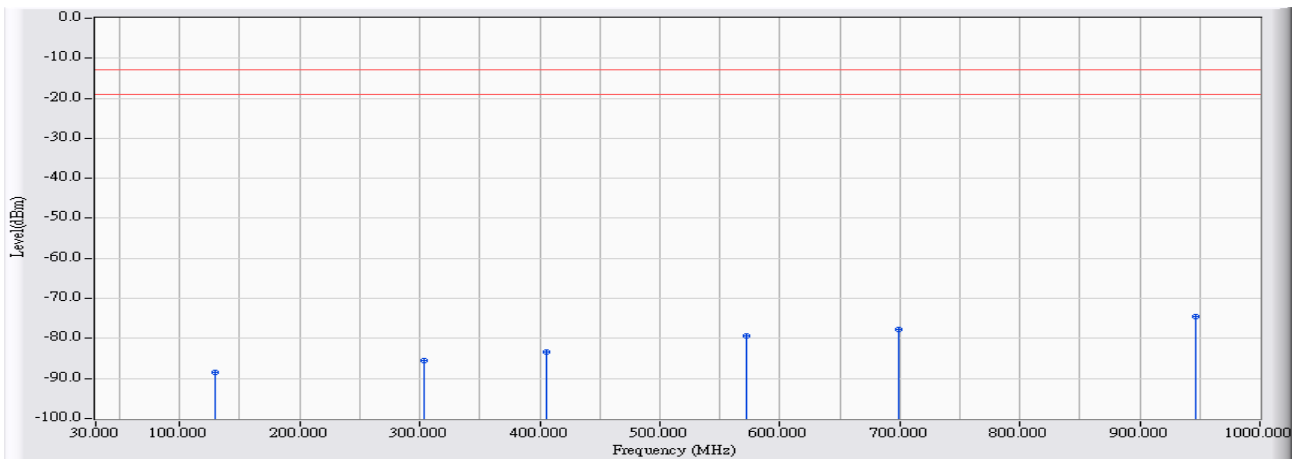

		Frequency (MHz)	Correct Factor (dB)	Reading Level (dBm)	Measure Level (dBm)	Margin (dB)	Limit (dBm)	Detector Type
1		129.910	-22.221	-66.232	-88.453	-75.453	-13.000	PEAK
2		303.540	-20.211	-65.342	-85.553	-72.553	-13.000	PEAK
3		405.875	-16.298	-67.147	-83.445	-70.445	-13.000	PEAK
4		572.715	-12.486	-66.867	-79.353	-66.353	-13.000	PEAK
5		699.300	-11.796	-65.958	-77.755	-64.755	-13.000	PEAK
6	*	946.165	-7.416	-67.158	-74.574	-61.574	-13.000	PEAK

Note:

1. All Reading Levels are Quasi-Peak value.
2. “ * ”, means this data is the worst emission level.
3. Measurement Level = Reading Level + Correct Factor.

Site : CB4-H	Time : 2017/02/23
Limit : FCC_Part22/24_00M_00M_PK	Margin : 6
Probe : CB4-H_CE_Sub_S2_30M-1GHz_1116 - HORIZONTAL	Power : DC 3.8V
EUT : LE910C1-NA	Note : Mode 14: WCDMA Band 5_HSDPA Mode_Idle 836.6MHz

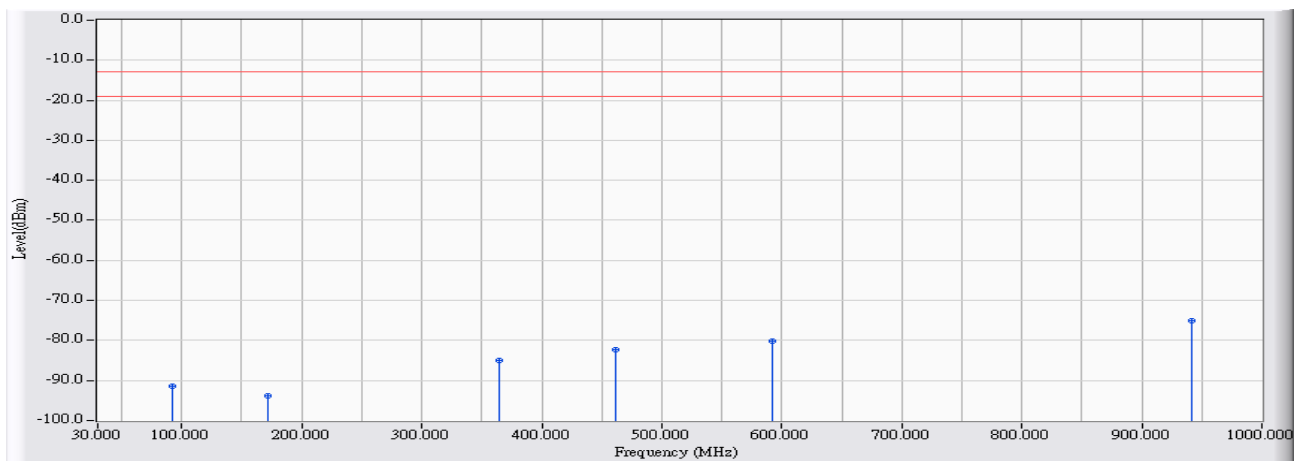

		Frequency (MHz)	Correct Factor (dB)	Reading Level (dBm)	Measure Level (dBm)	Margin (dB)	Limit (dBm)	Detector Type
1		92.080	-28.188	-63.211	-91.399	-78.399	-13.000	PEAK
2		172.105	-26.731	-66.999	-93.730	-80.730	-13.000	PEAK
3		365.135	-17.918	-67.122	-85.040	-72.040	-13.000	PEAK
4		461.650	-14.894	-67.291	-82.186	-69.186	-13.000	PEAK
5		591.630	-13.178	-66.975	-80.154	-67.154	-13.000	PEAK
6	*	941.800	-7.435	-67.590	-75.026	-62.026	-13.000	PEAK

Note:

1. All Reading Levels are Quasi-Peak value.
2. “ * ”, means this data is the worst emission level.
3. Measurement Level = Reading Level + Correct Factor.

Site : CB4-H	Time : 2017/02/23
Limit : FCC_Part22/24_00M_00M_PK	Margin : 6
Probe : CB4-H_CE_Sub_S2_30M-1GHz_1116 - VERTICAL	Power : DC 3.8V
EUT : LE910C1-NA	Note : Mode 14: WCDMA Band 5_HSDPA Mode_Idle 836.6MHz

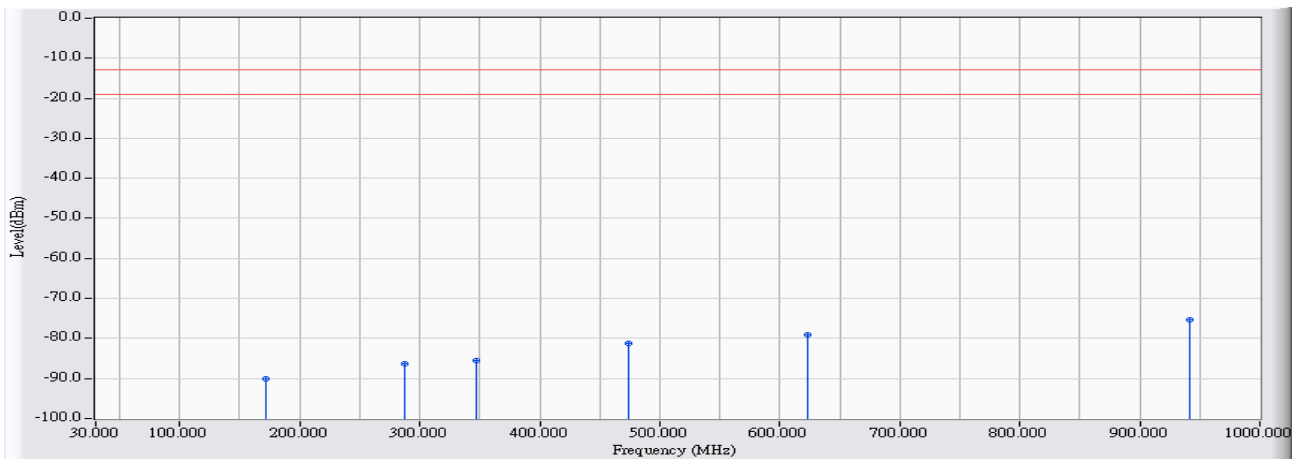

		Frequency (MHz)	Correct Factor (dB)	Reading Level (dBm)	Measure Level (dBm)	Margin (dB)	Limit (dBm)	Detector Type
1		172.105	-22.680	-67.412	-90.093	-77.093	-13.000	PEAK
2		288.020	-20.488	-65.949	-86.437	-73.437	-13.000	PEAK
3		346.705	-18.228	-67.273	-85.501	-72.501	-13.000	PEAK
4		474.260	-14.675	-66.585	-81.261	-68.261	-13.000	PEAK
5		623.155	-11.317	-67.638	-78.955	-65.955	-13.000	PEAK
6	*	941.315	-7.450	-67.989	-75.440	-62.440	-13.000	PEAK

Note:

1. All Reading Levels are Quasi-Peak value.
2. “ * ”, means this data is the worst emission level.
3. Measurement Level = Reading Level + Correct Factor.

Site : CB4-H	Time : 2017/02/23
Limit : FCC_Part22/24_00M_00M_PK	Margin : 6
Probe : CB4-H_CE_Sub_S2_30M-1GHz_1116 - HORIZONTAL	Power : DC 3.8V
EUT : LE910C1-NA	Note : Mode 15: WCDMA Band 2_HSUPA Mode_Link 1880MHz

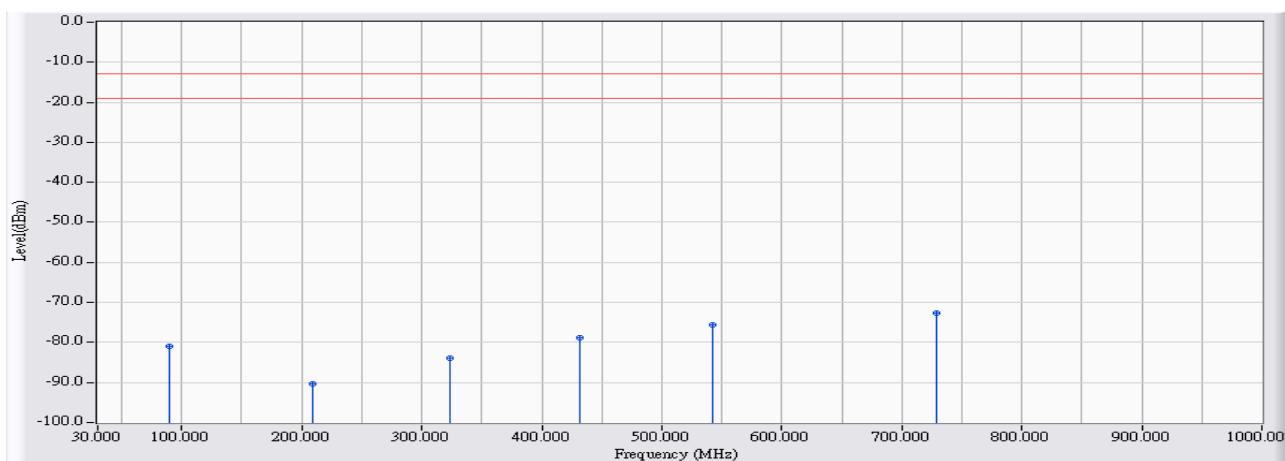

		Frequency (MHz)	Correct Factor (dB)	Reading Level (dBm)	Measure Level (dBm)	Margin (dB)	Limit (dBm)	Detector Type
1		90.140	-28.250	-52.732	-80.981	-67.981	-13.000	PEAK
2		208.965	-26.448	-63.828	-90.277	-77.277	-13.000	PEAK
3		323.910	-19.595	-64.273	-83.868	-70.868	-13.000	PEAK
4		431.580	-15.857	-62.928	-78.786	-65.786	-13.000	PEAK
5		542.645	-13.547	-62.108	-75.655	-62.655	-13.000	PEAK
6	*	728.885	-10.639	-62.056	-72.694	-59.694	-13.000	PEAK

Note:

1. All Reading Levels are Quasi-Peak value.
2. “ * ”, means this data is the worst emission level.
3. Measurement Level = Reading Level + Correct Factor.

Site : CB4-H	Time : 2017/02/23
Limit : FCC_Part22/24_00M_00M_PK	Margin : 6
Probe : CB4-H_CE_Sub_S2_30M-1GHz_1116 - VERTICAL	Power : DC 3.8V
EUT : LE910C1-NA	Note : Mode 15: WCDMA Band 2_HSUPA Mode_Link 1880MHz

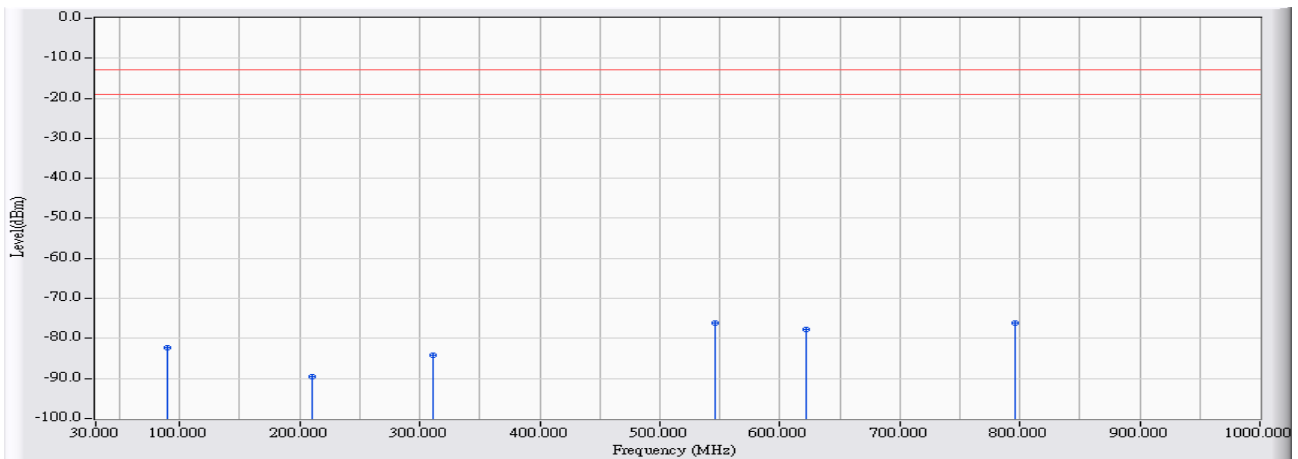

		Frequency (MHz)	Correct Factor (dB)	Reading Level (dBm)	Measure Level (dBm)	Margin (dB)	Limit (dBm)	Detector Type
1		90.140	-22.034	-60.170	-82.204	-69.204	-13.000	PEAK
2		210.420	-24.160	-65.294	-89.454	-76.454	-13.000	PEAK
3		310.815	-20.065	-64.207	-84.272	-71.272	-13.000	PEAK
4	*	546.040	-12.940	-63.116	-76.056	-63.056	-13.000	PEAK
5		621.700	-11.259	-66.593	-77.853	-64.853	-13.000	PEAK
6		796.300	-9.602	-66.646	-76.248	-63.248	-13.000	PEAK

Note:

1. All Reading Levels are Quasi-Peak value.
2. “ * ”, means this data is the worst emission level.
3. Measurement Level = Reading Level + Correct Factor.

Site : CB4-H	Time : 2017/02/23
Limit : FCC_Part22/24_00M_00M_PK	Margin : 6
Probe : CB4-H_CE_Sub_S2_30M-1GHz_1116 - HORIZONTAL	Power : DC 3.8V
EUT : LE910C1-NA	Note : Mode 15: WCDMA Band 2_HSUPA Mode_Idle 1880MHz

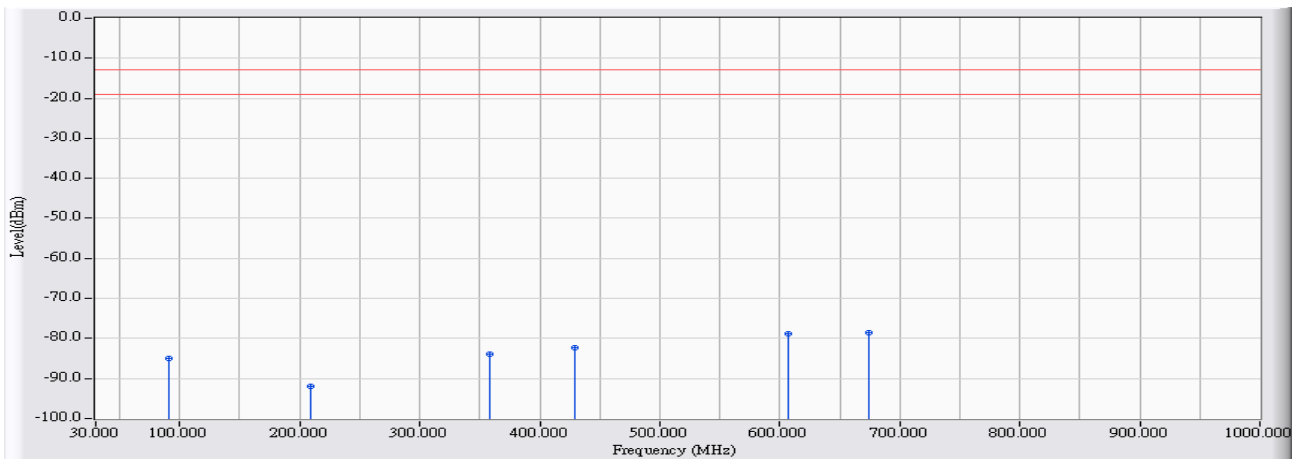

		Frequency (MHz)	Correct Factor (dB)	Reading Level (dBm)	Measure Level (dBm)	Margin (dB)	Limit (dBm)	Detector Type
1		91.110	-28.218	-56.669	-84.887	-71.887	-13.000	PEAK
2		208.965	-26.449	-65.478	-91.927	-78.927	-13.000	PEAK
3		357.860	-17.923	-66.058	-83.981	-70.981	-13.000	PEAK
4		429.640	-15.920	-66.411	-82.331	-69.331	-13.000	PEAK
5		607.635	-12.290	-66.659	-78.949	-65.949	-13.000	PEAK
6	*	674.565	-11.546	-66.976	-78.523	-65.523	-13.000	PEAK

Note:

1. All Reading Levels are Quasi-Peak value.
2. “ * ”, means this data is the worst emission level.
3. Measurement Level = Reading Level + Correct Factor.

Site : CB4-H	Time : 2017/02/23
Limit : FCC_Part22/24_00M_00M_PK	Margin : 6
Probe : CB4-H_CE_Sub_S2_30M-1GHz_1116 - VERTICAL	Power : DC 3.8V
EUT : LE910C1-NA	Note : Mode 15: WCDMA Band 2_HSUPA Mode_Idle 1880MHz

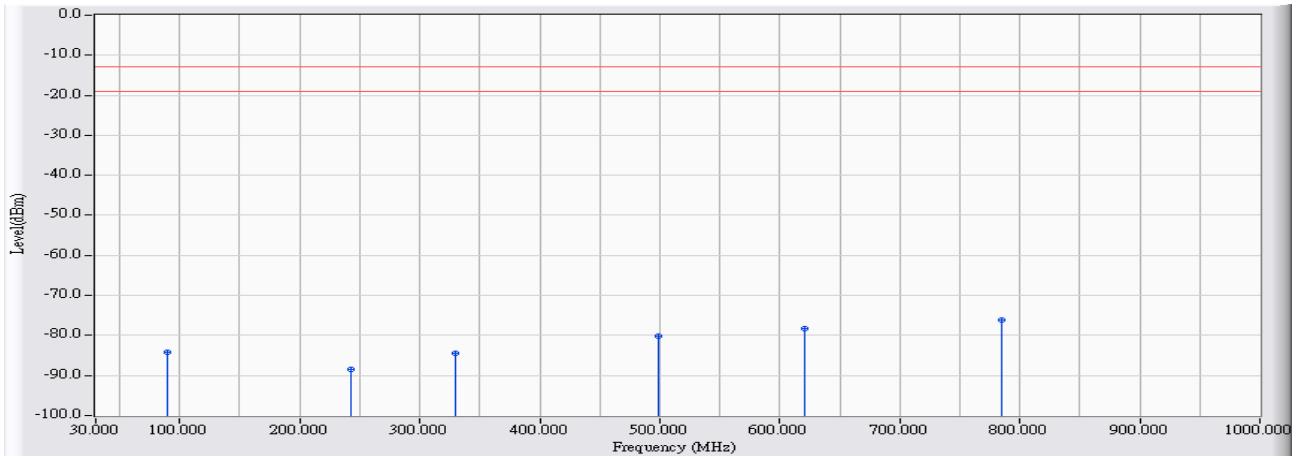

		Frequency (MHz)	Correct Factor (dB)	Reading Level (dBm)	Measure Level (dBm)	Margin (dB)	Limit (dBm)	Detector Type
1		90.140	-22.034	-62.137	-84.171	-71.171	-13.000	PEAK
2		242.915	-22.722	-65.741	-88.463	-75.463	-13.000	PEAK
3		330.215	-19.117	-65.395	-84.512	-71.512	-13.000	PEAK
4		498.510	-14.001	-66.275	-80.276	-67.276	-13.000	PEAK
5		620.730	-11.221	-67.159	-78.380	-65.380	-13.000	PEAK
6	*	785.145	-9.117	-66.898	-76.015	-63.015	-13.000	PEAK

Note:

1. All Reading Levels are Quasi-Peak value.
2. “ * ”, means this data is the worst emission level.
3. Measurement Level = Reading Level + Correct Factor.

Site : CB4-H	Time : 2017/02/23
Limit : FCC_Part22/24_00M_00M_PK	Margin : 6
Probe : CB4-H_CE_Sub_S2_30M-1GHz_1116 - HORIZONTAL	Power : DC 3.8V
EUT : LE910C1-NA	Note : Mode 16: WCDMA Band 2_HSDPA Mode_Link 1880MHz

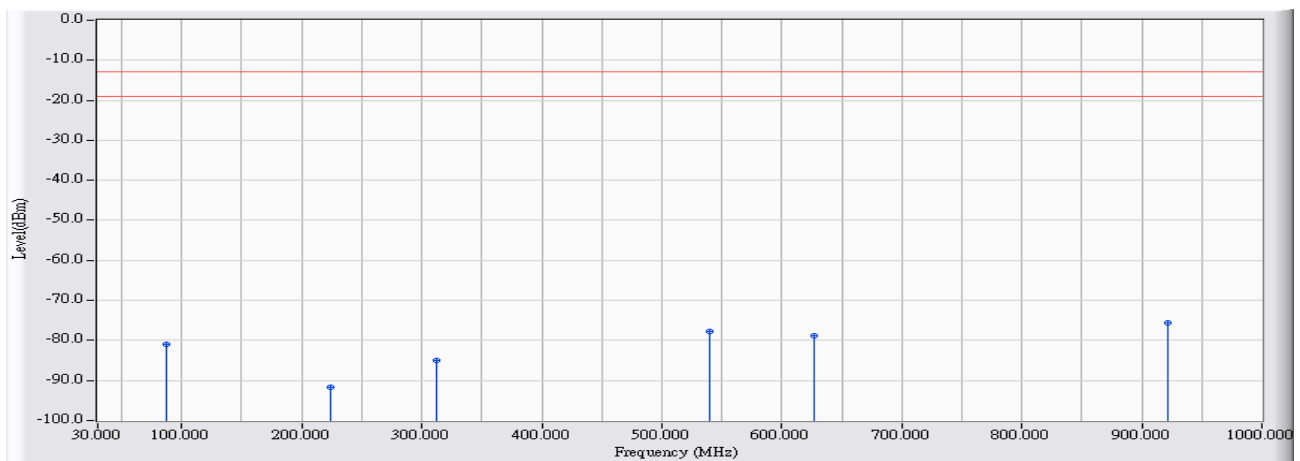

		Frequency (MHz)	Correct Factor (dB)	Reading Level (dBm)	Measure Level (dBm)	Margin (dB)	Limit (dBm)	Detector Type
1		86.745	-28.580	-52.423	-81.004	-68.004	-13.000	PEAK
2		223.515	-25.577	-66.075	-91.651	-78.651	-13.000	PEAK
3		311.785	-20.176	-64.943	-85.119	-72.119	-13.000	PEAK
4		539.735	-13.640	-64.097	-77.736	-64.736	-13.000	PEAK
5		626.550	-12.029	-66.904	-78.934	-65.934	-13.000	PEAK
6	*	921.915	-9.211	-66.438	-75.650	-62.650	-13.000	PEAK

Note:

1. All Reading Levels are Quasi-Peak value.
2. “ * ”, means this data is the worst emission level.
3. Measurement Level = Reading Level + Correct Factor.

Site : CB4-H	Time : 2017/02/23
Limit : FCC_Part22/24_00M_00M_PK	Margin : 6
Probe : CB4-H_CE_Sub_S2_30M-1GHz_1116 - VERTICAL	Power : DC 3.8V
EUT : LE910C1-NA	Note : Mode 16: WCDMA Band 2_HSDPA Mode_Link 1880MHz

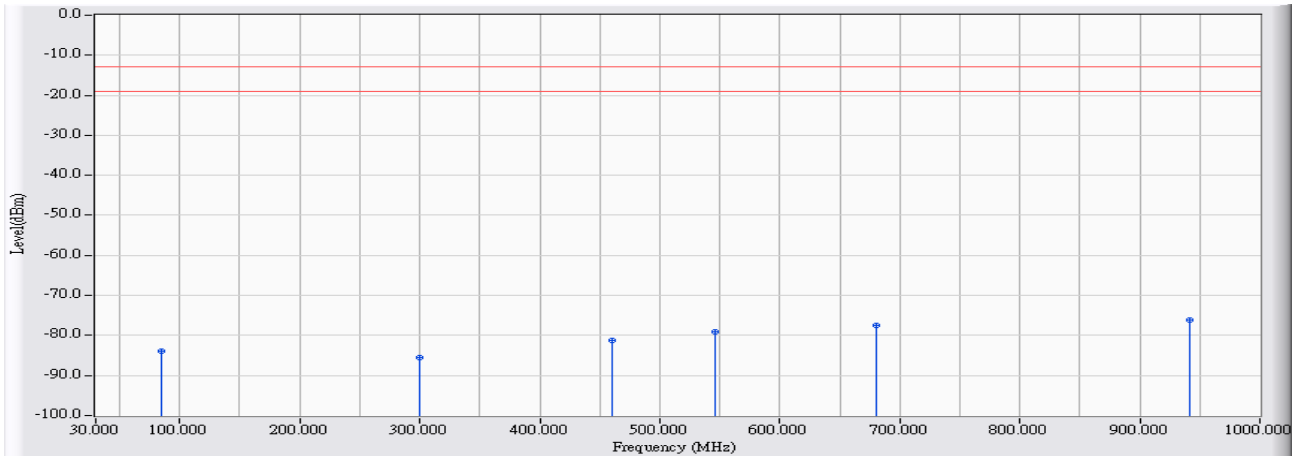

		Frequency (MHz)	Correct Factor (dB)	Reading Level (dBm)	Measure Level (dBm)	Margin (dB)	Limit (dBm)	Detector Type
1		84.320	-25.218	-58.663	-83.881	-70.881	-13.000	PEAK
2		300.145	-20.273	-65.171	-85.444	-72.444	-13.000	PEAK
3		459.710	-14.733	-66.532	-81.264	-68.264	-13.000	PEAK
4		546.525	-12.926	-66.254	-79.180	-66.180	-13.000	PEAK
5		679.900	-11.032	-66.377	-77.409	-64.409	-13.000	PEAK
6	*	941.800	-7.447	-68.559	-76.006	-63.006	-13.000	PEAK

Note:

1. All Reading Levels are Quasi-Peak value.
2. “ * ”, means this data is the worst emission level.
3. Measurement Level = Reading Level + Correct Factor.

Site : CB4-H	Time : 2017/02/23
Limit : FCC_Part22/24_00M_00M_PK	Margin : 6
Probe : CB4-H_CE_Sub_S2_30M-1GHz_1116 - HORIZONTAL	Power : DC 3.8V
EUT : LE910C1-NA	Note : Mode 16: WCDMA Band 2_HSDPA Mode_Idle 1880MHz

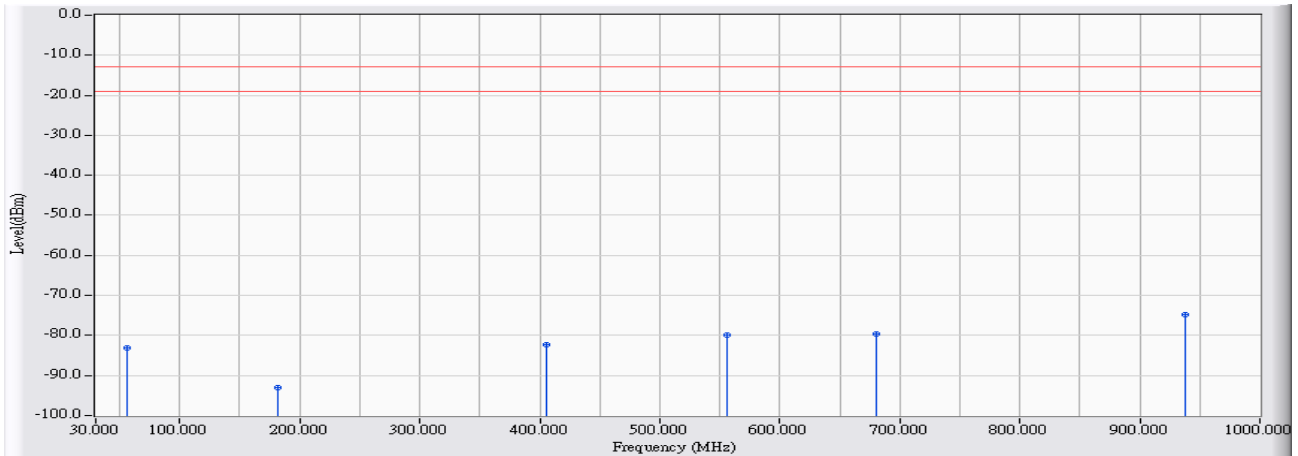

		Frequency (MHz)	Correct Factor (dB)	Reading Level (dBm)	Measure Level (dBm)	Margin (dB)	Limit (dBm)	Detector Type
1		55.705	-26.813	-56.307	-83.120	-70.120	-13.000	PEAK
2		182.290	-26.791	-66.121	-92.912	-79.912	-13.000	PEAK
3		405.390	-16.048	-66.142	-82.190	-69.190	-13.000	PEAK
4		555.740	-13.262	-66.732	-79.994	-66.994	-13.000	PEAK
5		679.900	-11.476	-68.211	-79.687	-66.687	-13.000	PEAK
6	*	937.435	-7.678	-67.067	-74.746	-61.746	-13.000	PEAK

Note:

1. All Reading Levels are Quasi-Peak value.
2. “ * ”, means this data is the worst emission level.
3. Measurement Level = Reading Level + Correct Factor.

Site : CB4-H	Time : 2017/02/23
Limit : FCC_Part22/24_00M_00M_PK	Margin : 6
Probe : CB4-H_CE_Sub_S2_30M-1GHz_1116 - VERTICAL	Power : DC 3.8V
EUT : LE910C1-NA	Note : Mode 16: WCDMA Band 2_HSDPA Mode_Idle 1880MHz

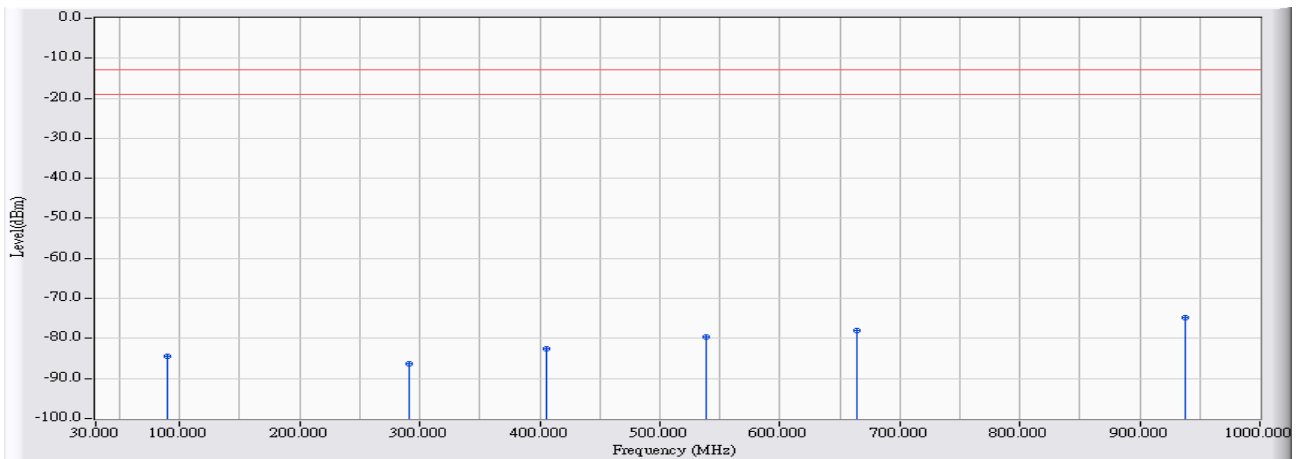

		Frequency (MHz)	Correct Factor (dB)	Reading Level (dBm)	Measure Level (dBm)	Margin (dB)	Limit (dBm)	Detector Type
1		90.140	-22.034	-62.358	-84.392	-71.392	-13.000	PEAK
2		290.930	-20.413	-65.822	-86.234	-73.234	-13.000	PEAK
3		405.390	-16.312	-66.142	-82.455	-69.455	-13.000	PEAK
4		538.765	-13.196	-66.389	-79.585	-66.585	-13.000	PEAK
5		663.895	-11.558	-66.346	-77.904	-64.904	-13.000	PEAK
6	*	937.435	-7.699	-67.045	-74.745	-61.745	-13.000	PEAK

Note:

1. All Reading Levels are Quasi-Peak value.
2. “ * ”, means this data is the worst emission level.
3. Measurement Level = Reading Level + Correct Factor.

Harmonic & Spurious:

Site : CB4-H	Time : 2017/02/17
Limit : FCC_Part22/24_00M_00M_PK	Margin : 6
Probe : CB4-H_CE_Sub_B432_1-18GHz_3M_1116 - HORIZONTAL	Power : DC 3.8V
EUT : LE910C1-NA	Note : Mode 1: GSM 850_Link Mode_824.2MHz

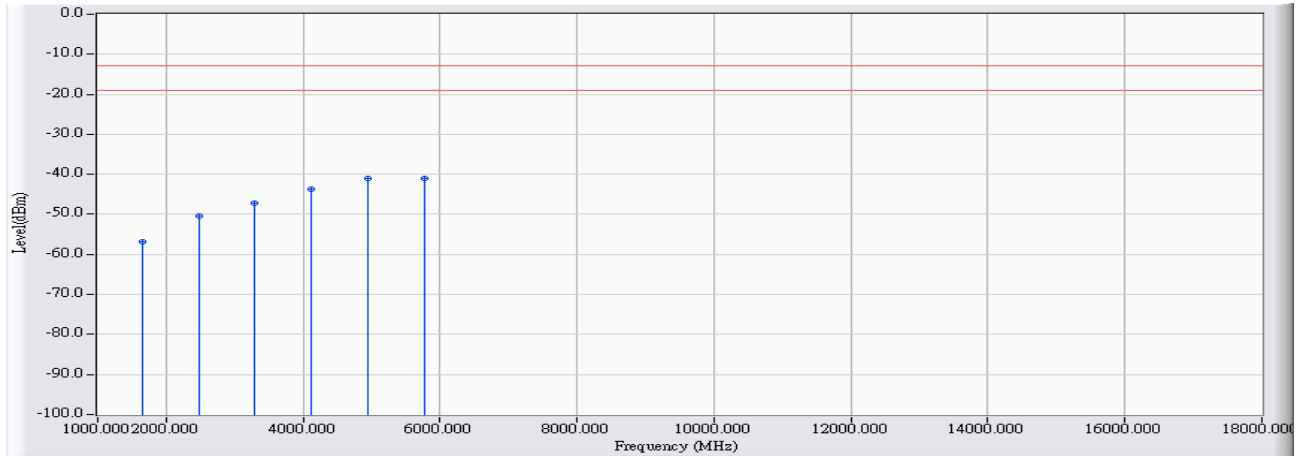

	Frequency (MHz)	Correct Factor (dB)	Reading Level (dBm)	Measure Level (dBm)	Margin (dB)	Limit (dBm)	Detector Type
1	1648.400	10.234	-67.040	-56.806	-43.806	-13.000	PEAK
2	2472.600	15.195	-65.470	-50.275	-37.275	-13.000	PEAK
3	3296.800	17.875	-64.950	-47.075	-34.075	-13.000	PEAK
4	4121.000	19.811	-63.570	-43.758	-30.758	-13.000	PEAK
5	* 4945.200	23.473	-64.420	-40.948	-27.948	-13.000	PEAK
6	5769.400	22.949	-63.950	-41.000	-28.000	-13.000	PEAK

Note:

1. All readings above 1GHz are performed with peak and/or average measurements as necessary.
2. Peak measurements: RBW = 1MHz, VBW = 1MHz, Sweep: Auto.
3. Average measurements: RBW = 1MHz, VBW = 10 Hz, Sweep: Auto.
4. “ * ”, means this data is the worst emission level.
5. Measurement Level = Reading Level + Correct Factor.
6. The average measurement was not performed when the peak measured data under the limit of average detection.
7. The Emission above 18GHz were not included is because their levels are too low.

Site : CB4-H	Time : 2017/02/17
Limit : FCC_Part22/24_00M_00M_PK	Margin : 6
Probe : CB4-H_CE_Sub_B432_1-18GHz_3M_1116 - VERTICAL	Power : DC 3.8V
EUT : LE910C1-NA	Note : Mode 1: GSM 850_Link Mode_824.2MHz

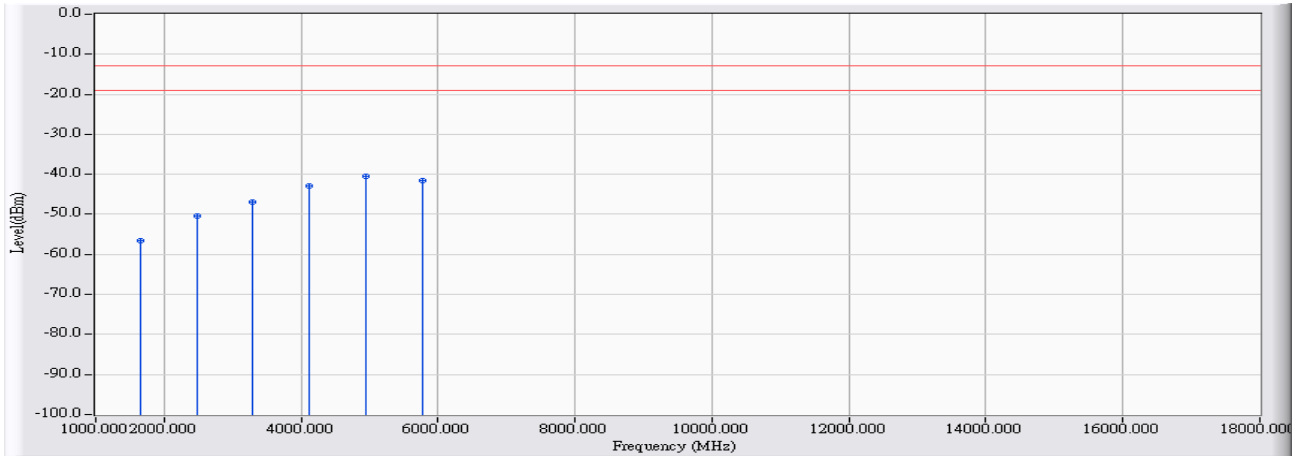

		Frequency (MHz)	Correct Factor (dB)	Reading Level (dBm)	Measure Level (dBm)	Margin (dB)	Limit (dBm)	Detector Type
1		1648.400	10.754	-67.320	-56.567	-43.567	-13.000	PEAK
2		2472.600	15.531	-65.800	-50.269	-37.269	-13.000	PEAK
3		3296.800	18.457	-65.250	-46.794	-33.794	-13.000	PEAK
4		4121.000	20.678	-63.500	-42.822	-29.822	-13.000	PEAK
5	*	4945.200	23.992	-64.560	-40.569	-27.569	-13.000	PEAK
6		5769.400	22.783	-64.400	-41.617	-28.617	-13.000	PEAK

Note:

1. All readings above 1GHz are performed with peak and/or average measurements as necessary.
2. Peak measurements: RBW = 1MHz, VBW = 1MHz, Sweep: Auto.
3. Average measurements: RBW = 1MHz, VBW = 10 Hz, Sweep: Auto.
4. “ * ”, means this data is the worst emission level.
5. Measurement Level = Reading Level + Correct Factor.
6. The average measurement was not performed when the peak measured data under the limit of average detection.
7. The Emission above 18GHz were not included is because their levels are too low.

Site : CB4-H	Time : 2017/02/17
Limit : FCC_Part22/24_00M_00M_PK	Margin : 6
Probe : CB4-H_CE_Sub_B432_1-18GHz_3M_1116 - HORIZONTAL	Power : DC 3.8V
EUT : LE910C1-NA	Note : Mode 1: GSM 850_Link Mode_836.6MHz

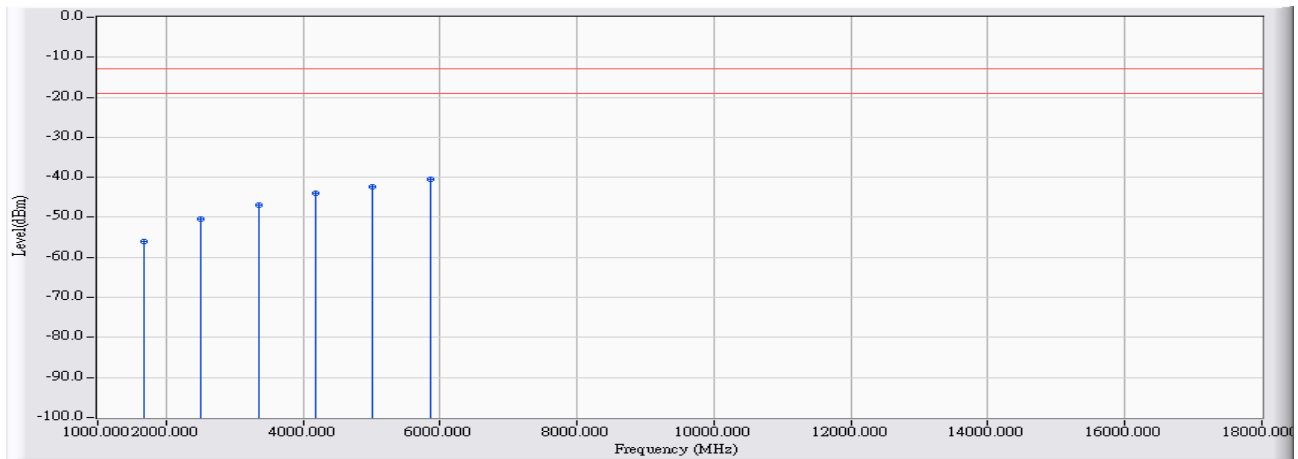

		Frequency (MHz)	Correct Factor (dB)	Reading Level (dBm)	Measure Level (dBm)	Margin (dB)	Limit (dBm)	Detector Type
1		1673.200	10.200	-66.150	-55.950	-42.950	-13.000	PEAK
2		2509.800	15.141	-65.440	-50.298	-37.298	-13.000	PEAK
3		3346.400	18.010	-65.050	-47.039	-34.039	-13.000	PEAK
4		4183.000	19.904	-63.740	-43.835	-30.835	-13.000	PEAK
5		5019.600	21.331	-63.770	-42.439	-29.439	-13.000	PEAK
6	*	5856.200	23.275	-63.700	-40.426	-27.426	-13.000	PEAK

Note:

1. All readings above 1GHz are performed with peak and/or average measurements as necessary.
2. Peak measurements: RBW = 1MHz, VBW = 1MHz, Sweep: Auto.
3. Average measurements: RBW = 1MHz, VBW = 10 Hz, Sweep: Auto.
4. “ * ”, means this data is the worst emission level.
5. Measurement Level = Reading Level + Correct Factor.
6. The average measurement was not performed when the peak measured data under the limit of average detection.
7. The Emission above 18GHz were not included is because their levels are too low.

Site : CB4-H	Time : 2017/02/17
Limit : FCC_Part22/24_00M_00M_PK	Margin : 6
Probe : CB4-H_CE_Sub_B432_1-18GHz_3M_1116 - VERTICAL	Power : DC 3.8V
EUT : LE910C1-NA	Note : Mode 1: GSM 850_Link Mode_836.6MHz

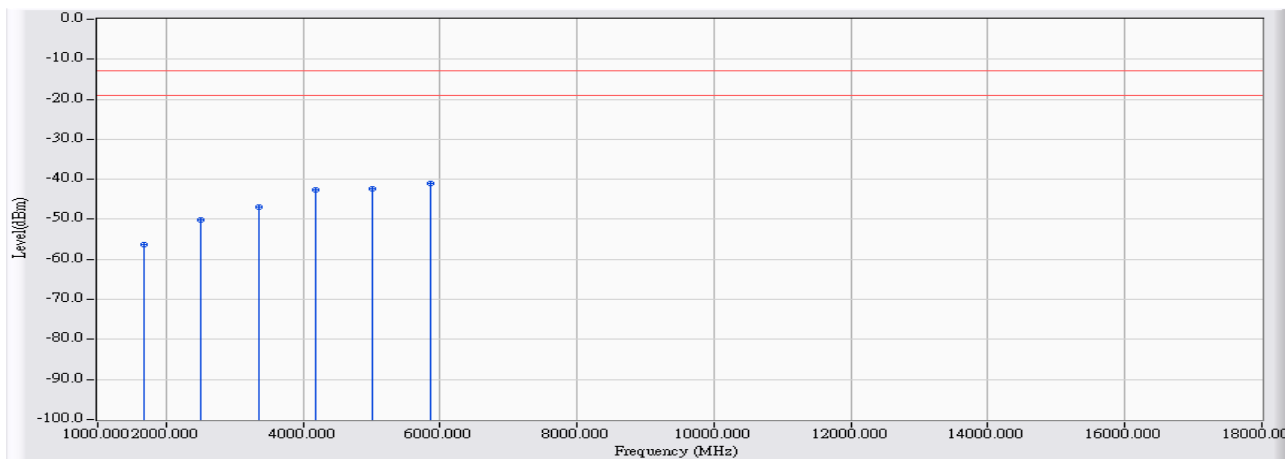

	Frequency (MHz)	Correct Factor (dB)	Reading Level (dBm)	Measure Level (dBm)	Margin (dB)	Limit (dBm)	Detector Type
1	1673.200	10.765	-67.150	-56.385	-43.385	-13.000	PEAK
2	2509.800	15.530	-65.550	-50.019	-37.019	-13.000	PEAK
3	3346.400	18.651	-65.520	-46.868	-33.868	-13.000	PEAK
4	4183.000	20.854	-63.570	-42.716	-29.716	-13.000	PEAK
5	5019.600	20.970	-63.240	-42.270	-29.270	-13.000	PEAK
6	* 5856.200	23.103	-64.110	-41.007	-28.007	-13.000	PEAK

Note:

1. All readings above 1GHz are performed with peak and/or average measurements as necessary.
2. Peak measurements: RBW = 1MHz, VBW = 1MHz, Sweep: Auto.
3. Average measurements: RBW = 1MHz, VBW = 10 Hz, Sweep: Auto.
4. “ * ”, means this data is the worst emission level.
5. Measurement Level = Reading Level + Correct Factor.
6. The average measurement was not performed when the peak measured data under the limit of average detection.
7. The Emission above 18GHz were not included is because their levels are too low.

Site : CB4-H	Time : 2017/02/17
Limit : FCC_Part22/24_00M_00M_PK	Margin : 6
Probe : CB4-H_CE_Sub_B432_1-18GHz_3M_1116 - HORIZONTAL	Power : DC 3.8V
EUT : LE910C1-NA	Note : Mode 1: GSM 850_Link Mode_848.8MHz

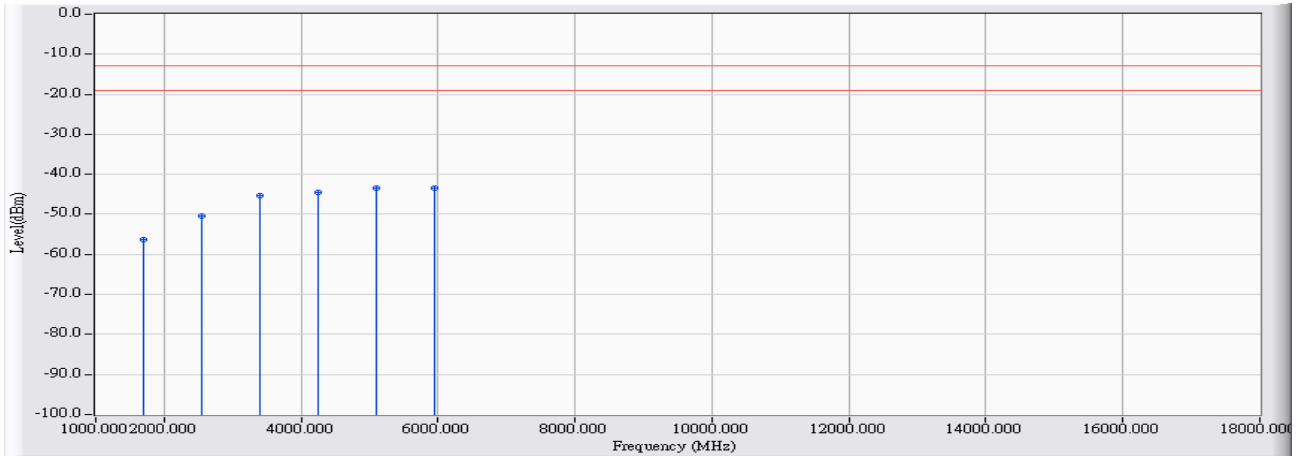

		Frequency (MHz)	Correct Factor (dB)	Reading Level (dBm)	Measure Level (dBm)	Margin (dB)	Limit (dBm)	Detector Type
1		1697.600	10.167	-66.490	-56.323	-43.323	-13.000	PEAK
2		2546.400	15.247	-65.690	-50.442	-37.442	-13.000	PEAK
3		3395.200	18.145	-63.480	-45.334	-32.334	-13.000	PEAK
4		4244.000	19.992	-64.540	-44.548	-31.548	-13.000	PEAK
5	*	5092.800	21.416	-64.790	-43.374	-30.374	-13.000	PEAK
6		5941.600	23.594	-67.070	-43.476	-30.476	-13.000	PEAK

Note:

1. All readings above 1GHz are performed with peak and/or average measurements as necessary.
2. Peak measurements: RBW = 1MHz, VBW = 1MHz, Sweep: Auto.
3. Average measurements: RBW = 1MHz, VBW = 10 Hz, Sweep: Auto.
4. “ * ”, means this data is the worst emission level.
5. Measurement Level = Reading Level + Correct Factor.
6. The average measurement was not performed when the peak measured data under the limit of average detection.
7. The Emission above 18GHz were not included is because their levels are too low.

Site : CB4-H	Time : 2017/02/17
Limit : FCC_Part22/24_00M_00M_PK	Margin : 6
Probe : CB4-H_CE_Sub_B432_1-18GHz_3M_1116 - VERTICAL	Power : DC 3.8V
EUT : LE910C1-NA	Note : Mode 1: GSM 850_Link Mode_848.8MHz

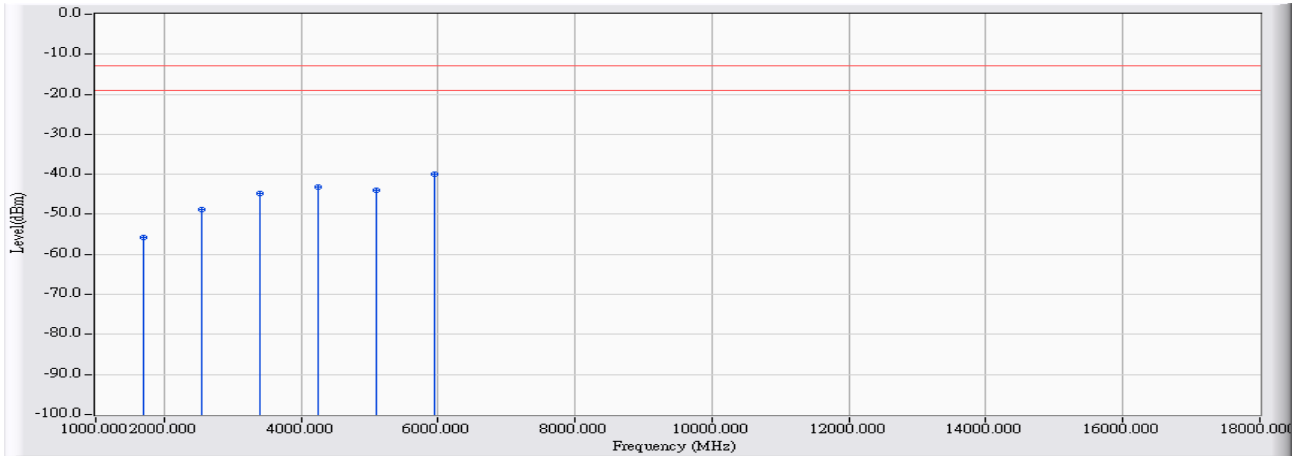

		Frequency (MHz)	Correct Factor (dB)	Reading Level (dBm)	Measure Level (dBm)	Margin (dB)	Limit (dBm)	Detector Type
1		1697.600	10.777	-66.590	-55.813	-42.813	-13.000	PEAK
2		2546.400	15.623	-64.520	-48.897	-35.897	-13.000	PEAK
3		3395.200	18.844	-63.750	-44.905	-31.905	-13.000	PEAK
4		4244.000	21.023	-64.270	-43.247	-30.247	-13.000	PEAK
5		5092.800	21.087	-64.990	-43.903	-30.903	-13.000	PEAK
6	*	5941.600	23.417	-63.480	-40.063	-27.063	-13.000	PEAK

Note:

1. All readings above 1GHz are performed with peak and/or average measurements as necessary.
2. Peak measurements: RBW = 1MHz, VBW = 1MHz, Sweep: Auto.
3. Average measurements: RBW = 1MHz, VBW = 10 Hz, Sweep: Auto.
4. “ * ”, means this data is the worst emission level.
5. Measurement Level = Reading Level + Correct Factor.
6. The average measurement was not performed when the peak measured data under the limit of average detection.
7. The Emission above 18GHz were not included is because their levels are too low.

Site : CB4-H	Time : 2017/02/17
Limit : FCC_Part22/24_00M_00M_PK	Margin : 6
Probe : CB4-H_CE_Sub_B432_1-18GHz_3M_1116 - HORIZONTAL	Power : DC 3.8V
EUT : LE910C1-NA	Note : Mode 2: GSM 850_Idle Mode_824.2MHz

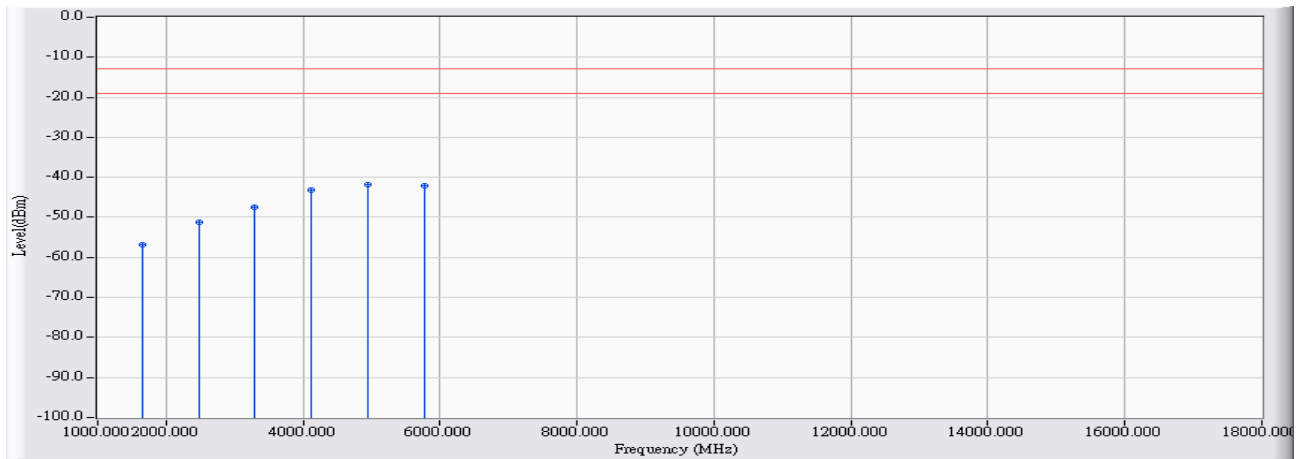

		Frequency (MHz)	Correct Factor (dB)	Reading Level (dBm)	Measure Level (dBm)	Margin (dB)	Limit (dBm)	Detector Type
1		1648.400	10.234	-67.190	-56.956	-43.956	-13.000	PEAK
2		2472.600	15.195	-66.400	-51.205	-38.205	-13.000	PEAK
3		3296.800	17.875	-65.350	-47.475	-34.475	-13.000	PEAK
4		4121.000	19.811	-63.000	-43.188	-30.188	-13.000	PEAK
5	*	4945.200	23.473	-65.390	-41.918	-28.918	-13.000	PEAK
6		5769.400	22.949	-65.150	-42.200	-29.200	-13.000	PEAK

Note:

1. All readings above 1GHz are performed with peak and/or average measurements as necessary.
2. Peak measurements: RBW = 1MHz, VBW = 1MHz, Sweep: Auto.
3. Average measurements: RBW = 1MHz, VBW = 10 Hz, Sweep: Auto.
4. “ * ”, means this data is the worst emission level.
5. Measurement Level = Reading Level + Correct Factor.
6. The average measurement was not performed when the peak measured data under the limit of average detection.
7. The Emission above 18GHz were not included is because their levels are too low.

Site : CB4-H	Time : 2017/02/17
Limit : FCC_Part22/24_00M_00M_PK	Margin : 6
Probe : CB4-H_CE_Sub_B432_1-18GHz_3M_1116 - VERTICAL	Power : DC 3.8V
EUT : LE910C1-NA	Note : Mode 2: GSM 850_Idle Mode_824.2MHz

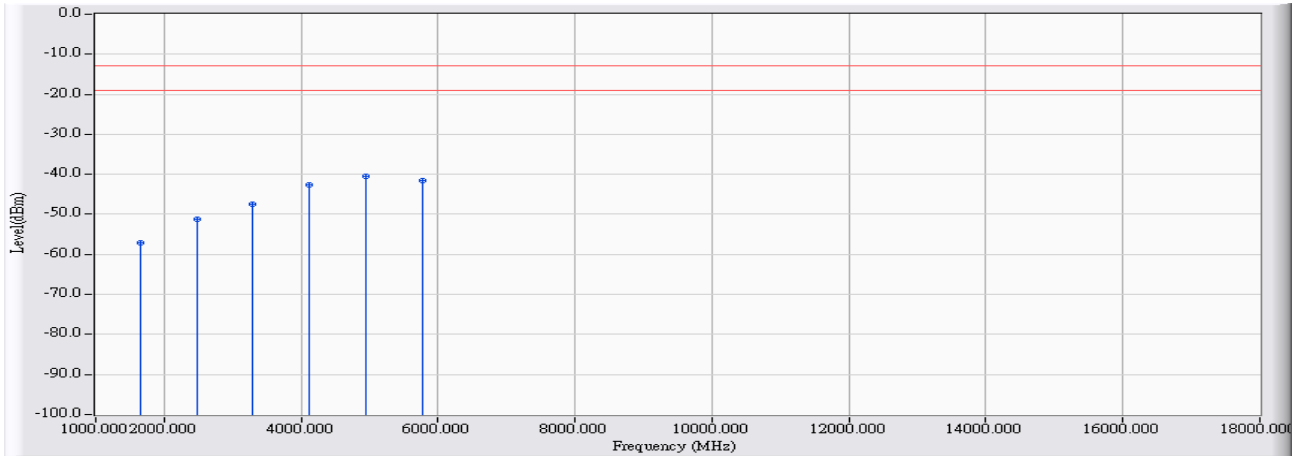

		Frequency (MHz)	Correct Factor (dB)	Reading Level (dBm)	Measure Level (dBm)	Margin (dB)	Limit (dBm)	Detector Type
1		1648.400	10.754	-67.960	-57.207	-44.207	-13.000	PEAK
2		2472.600	15.531	-66.800	-51.269	-38.269	-13.000	PEAK
3		3296.800	18.457	-65.860	-47.404	-34.404	-13.000	PEAK
4		4121.000	20.678	-63.410	-42.732	-29.732	-13.000	PEAK
5	*	4945.200	23.992	-64.550	-40.559	-27.559	-13.000	PEAK
6		5769.400	22.783	-64.290	-41.507	-28.507	-13.000	PEAK

Note:

1. All readings above 1GHz are performed with peak and/or average measurements as necessary.
2. Peak measurements: RBW = 1MHz, VBW = 1MHz, Sweep: Auto.
3. Average measurements: RBW = 1MHz, VBW = 10 Hz, Sweep: Auto.
4. “ * ”, means this data is the worst emission level.
5. Measurement Level = Reading Level + Correct Factor.
6. The average measurement was not performed when the peak measured data under the limit of average detection.
7. The Emission above 18GHz were not included is because their levels are too low.

Site : CB4-H	Time : 2017/02/17
Limit : FCC_Part22/24_00M_00M_PK	Margin : 6
Probe : CB4-H_CE_Sub_B432_1-18GHz_3M_1116 - HORIZONTAL	Power : DC 3.8V
EUT : LE910C1-NA	Note : Mode 2: GSM 850_Idle Mode_836.6MHz

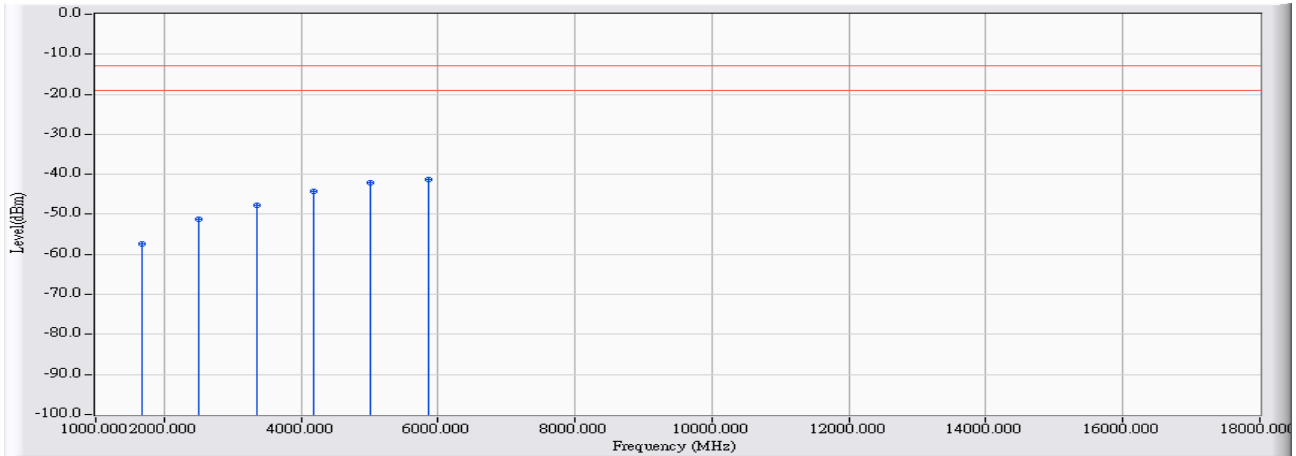

		Frequency (MHz)	Correct Factor (dB)	Reading Level (dBm)	Measure Level (dBm)	Margin (dB)	Limit (dBm)	Detector Type
1		1673.200	10.200	-67.550	-57.350	-44.350	-13.000	PEAK
2		2509.800	15.141	-66.290	-51.148	-38.148	-13.000	PEAK
3		3346.400	18.010	-65.840	-47.829	-34.829	-13.000	PEAK
4		4183.000	19.904	-64.070	-44.165	-31.165	-13.000	PEAK
5		5019.600	21.331	-63.300	-41.969	-28.969	-13.000	PEAK
6	*	5856.200	23.275	-64.690	-41.416	-28.416	-13.000	PEAK

Note:

1. All readings above 1GHz are performed with peak and/or average measurements as necessary.
2. Peak measurements: RBW = 1MHz, VBW = 1MHz, Sweep: Auto.
3. Average measurements: RBW = 1MHz, VBW = 10 Hz, Sweep: Auto.
4. “ * ”, means this data is the worst emission level.
5. Measurement Level = Reading Level + Correct Factor.
6. The average measurement was not performed when the peak measured data under the limit of average detection.
7. The Emission above 18GHz were not included is because their levels are too low.

Site : CB4-H	Time : 2017/02/17
Limit : FCC_Part22/24_00M_00M_PK	Margin : 6
Probe : CB4-H_CE_Sub_B432_1-18GHz_3M_1116 - VERTICAL	Power : DC 3.8V
EUT : LE910C1-NA	Note : Mode 2: GSM 850_Idle Mode_836.6MHz

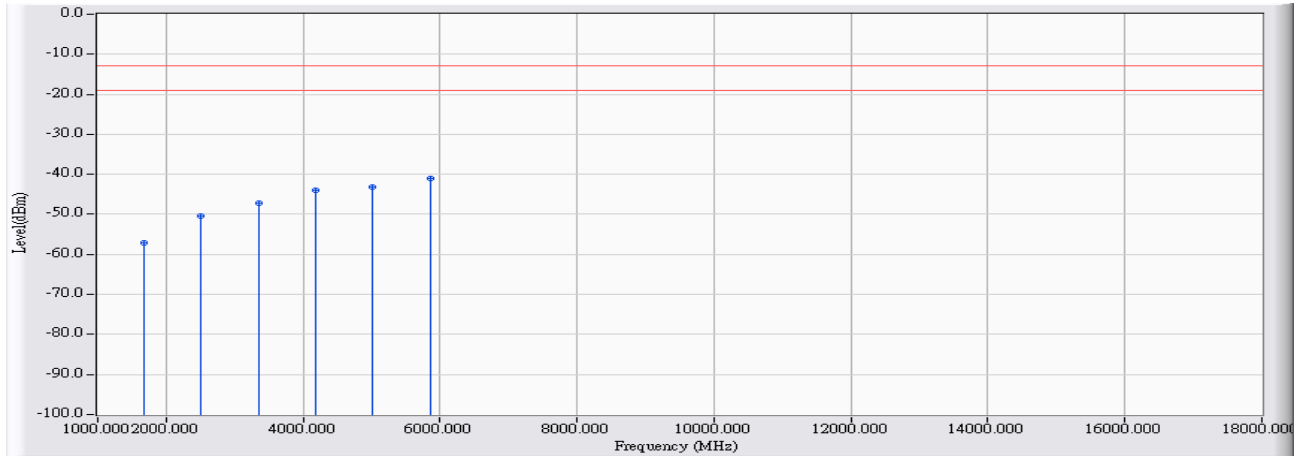

		Frequency (MHz)	Correct Factor (dB)	Reading Level (dBm)	Measure Level (dBm)	Margin (dB)	Limit (dBm)	Detector Type
1		1673.200	10.765	-67.810	-57.045	-44.045	-13.000	PEAK
2		2509.800	15.530	-65.820	-50.289	-37.289	-13.000	PEAK
3		3346.400	18.651	-65.920	-47.268	-34.268	-13.000	PEAK
4		4183.000	20.854	-64.780	-43.926	-30.926	-13.000	PEAK
5		5019.600	20.970	-64.090	-43.120	-30.120	-13.000	PEAK
6	*	5856.200	23.103	-64.170	-41.067	-28.067	-13.000	PEAK

Note:

1. All readings above 1GHz are performed with peak and/or average measurements as necessary.
2. Peak measurements: RBW = 1MHz, VBW = 1MHz, Sweep: Auto.
3. Average measurements: RBW = 1MHz, VBW = 10 Hz, Sweep: Auto.
4. “ * ”, means this data is the worst emission level.
5. Measurement Level = Reading Level + Correct Factor.
6. The average measurement was not performed when the peak measured data under the limit of average detection.
7. The Emission above 18GHz were not included is because their levels are too low.

Site : CB4-H	Time : 2017/02/17
Limit : FCC_Part22/24_00M_00M_PK	Margin : 6
Probe : CB4-H_CE_Sub_B432_1-18GHz_3M_1116 - HORIZONTAL	Power : DC 3.8V
EUT : LE910C1-NA	Note : Mode 2: GSM 850_Idle Mode_848.8MHz

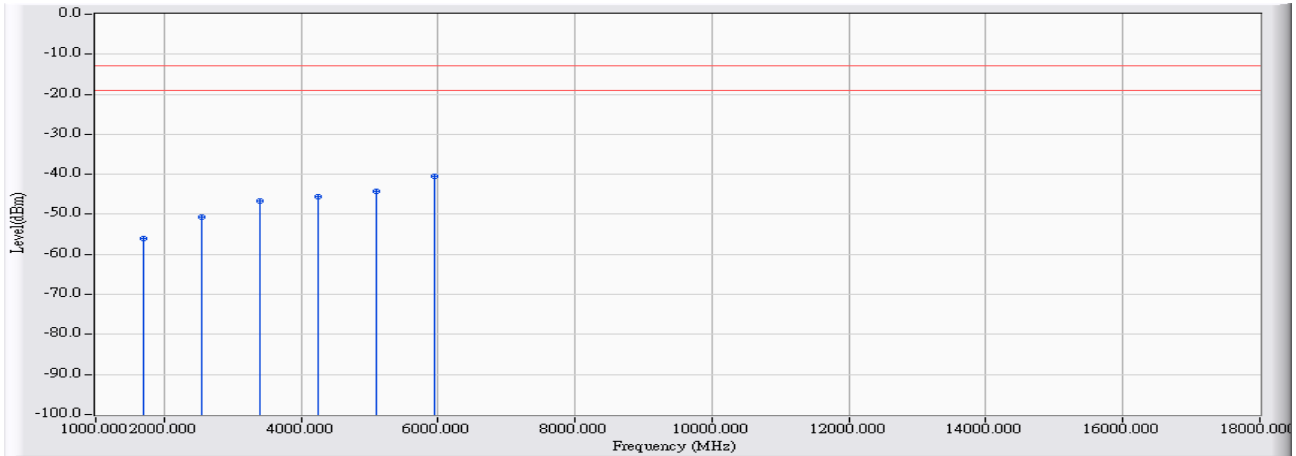

		Frequency (MHz)	Correct Factor (dB)	Reading Level (dBm)	Measure Level (dBm)	Margin (dB)	Limit (dBm)	Detector Type
1		1697.600	10.167	-66.090	-55.923	-42.923	-13.000	PEAK
2		2546.400	15.247	-65.870	-50.622	-37.622	-13.000	PEAK
3		3395.200	18.145	-64.720	-46.574	-33.574	-13.000	PEAK
4		4244.000	19.992	-65.530	-45.538	-32.538	-13.000	PEAK
5		5092.800	21.416	-65.730	-44.314	-31.314	-13.000	PEAK
6	*	5941.600	23.594	-64.030	-40.436	-27.436	-13.000	PEAK

Note:

1. All readings above 1GHz are performed with peak and/or average measurements as necessary.
2. Peak measurements: RBW = 1MHz, VBW = 1MHz, Sweep: Auto.
3. Average measurements: RBW = 1MHz, VBW = 10 Hz, Sweep: Auto.
4. “ * ”, means this data is the worst emission level.
5. Measurement Level = Reading Level + Correct Factor.
6. The average measurement was not performed when the peak measured data under the limit of average detection.
7. The Emission above 18GHz were not included is because their levels are too low.

Site : CB4-H	Time : 2017/02/17
Limit : FCC_Part22/24_00M_00M_PK	Margin : 6
Probe : CB4-H_CE_Sub_B432_1-18GHz_3M_1116 - VERTICAL	Power : DC 3.8V
EUT : LE910C1-NA	Note : Mode 2: GSM 850_Idle Mode_848.8MHz

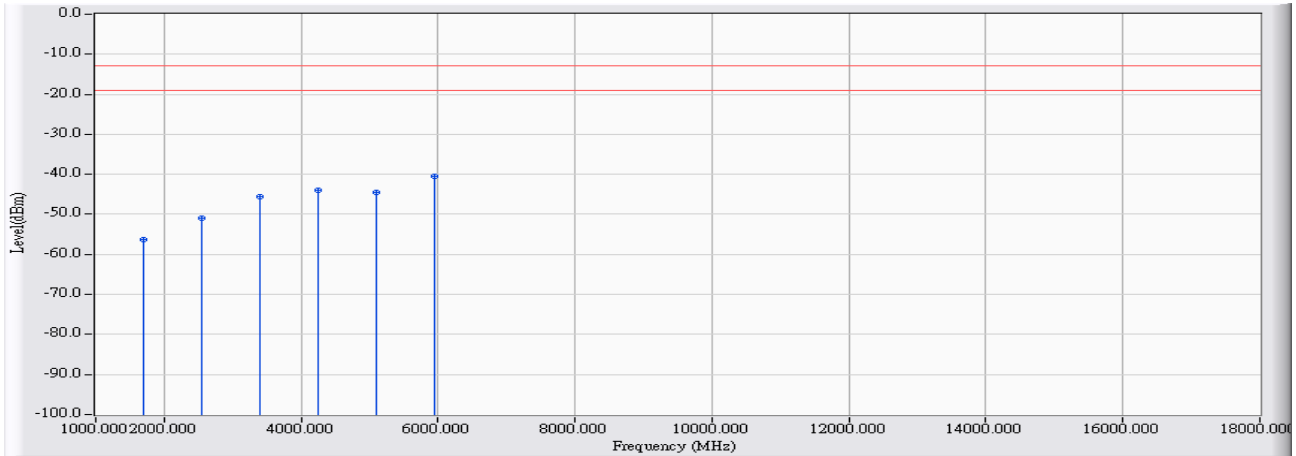

		Frequency (MHz)	Correct Factor (dB)	Reading Level (dBm)	Measure Level (dBm)	Margin (dB)	Limit (dBm)	Detector Type
1		1697.600	10.777	-67.000	-56.223	-43.223	-13.000	PEAK
2		2546.400	15.623	-66.530	-50.907	-37.907	-13.000	PEAK
3		3395.200	18.844	-64.550	-45.705	-32.705	-13.000	PEAK
4		4244.000	21.023	-65.050	-44.027	-31.027	-13.000	PEAK
5		5092.800	21.087	-65.620	-44.533	-31.533	-13.000	PEAK
6	*	5941.600	23.417	-63.940	-40.523	-27.523	-13.000	PEAK

Note:

1. All readings above 1GHz are performed with peak and/or average measurements as necessary.
2. Peak measurements: RBW = 1MHz, VBW = 1MHz, Sweep: Auto.
3. Average measurements: RBW = 1MHz, VBW = 10 Hz, Sweep: Auto.
4. “ * ”, means this data is the worst emission level.
5. Measurement Level = Reading Level + Correct Factor.
6. The average measurement was not performed when the peak measured data under the limit of average detection.
7. The Emission above 18GHz were not included is because their levels are too low.

Site : CB4-H	Time : 2017/02/17
Limit : FCC_Part22/24_00M_00M_PK	Margin : 6
Probe : CB4-H_CE_Sub_B432_1-18GHz_3M_1116 - HORIZONTAL	Power : DC 3.8V
EUT : LE910C1-NA	Note : Mode 3: DCS 1900_Link Mode_1850.2MHz

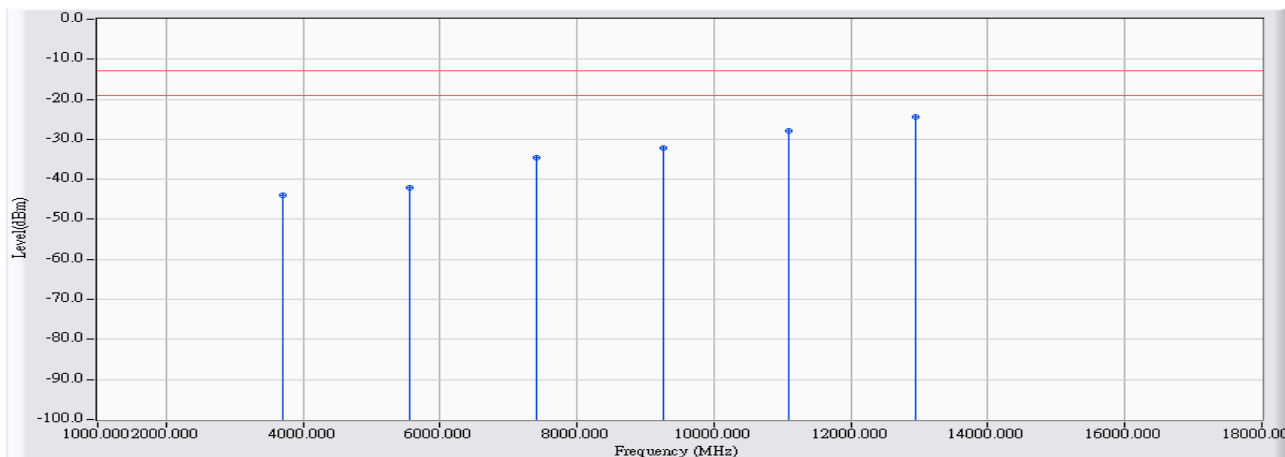

		Frequency (MHz)	Correct Factor (dB)	Reading Level (dBm)	Measure Level (dBm)	Margin (dB)	Limit (dBm)	Detector Type
1		3700.400	19.021	-62.970	-43.949	-30.949	-13.000	PEAK
2		5550.600	22.089	-64.240	-42.150	-29.150	-13.000	PEAK
3		7400.800	29.829	-64.350	-34.522	-21.522	-13.000	PEAK
4		9251.000	34.519	-66.630	-32.111	-19.111	-13.000	PEAK
5		11101.200	37.642	-65.430	-27.788	-14.788	-13.000	PEAK
6	*	12951.400	41.673	-66.170	-24.497	-11.497	-13.000	PEAK

Note:

1. All readings above 1GHz are performed with peak and/or average measurements as necessary.
2. Peak measurements: RBW = 1MHz, VBW = 1MHz, Sweep: Auto.
3. Average measurements: RBW = 1MHz, VBW = 10 Hz, Sweep: Auto.
4. “ * ”, means this data is the worst emission level.
5. Measurement Level = Reading Level + Correct Factor.
6. The average measurement was not performed when the peak measured data under the limit of average detection.
7. The Emission above 18GHz were not included is because their levels are too low.

Site : CB4-H	Time : 2017/02/17
Limit : FCC_Part22/24_00M_00M_PK	Margin : 6
Probe : CB4-H_CE_Sub_B432_1-18GHz_3M_1116 - VERTICAL	Power : DC 3.8V
EUT : LE910C1-NA	Note : Mode 3: DCS 1900_Link Mode_1850.2MHz

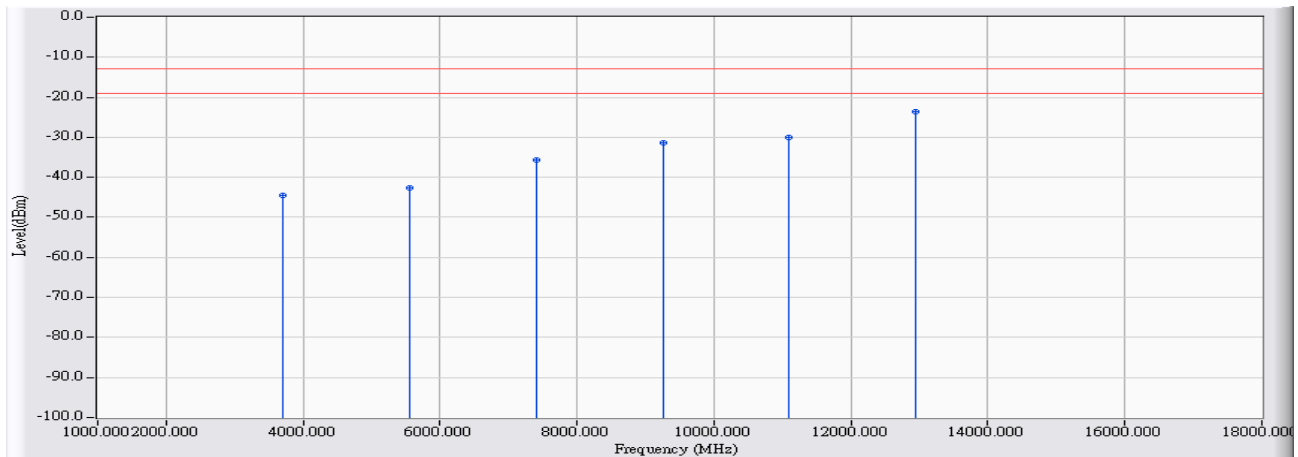

		Frequency (MHz)	Correct Factor (dB)	Reading Level (dBm)	Measure Level (dBm)	Margin (dB)	Limit (dBm)	Detector Type
1		3700.400	19.822	-64.330	-44.508	-31.508	-13.000	PEAK
2		5550.600	21.936	-64.510	-42.573	-29.573	-13.000	PEAK
3		7400.800	29.614	-65.280	-35.667	-22.667	-13.000	PEAK
4		9251.000	35.776	-67.020	-31.245	-18.245	-13.000	PEAK
5		11101.200	36.516	-66.450	-29.935	-16.935	-13.000	PEAK
6	*	12951.400	42.876	-66.420	-23.544	-10.544	-13.000	PEAK

Note:

1. All readings above 1GHz are performed with peak and/or average measurements as necessary.
2. Peak measurements: RBW = 1MHz, VBW = 1MHz, Sweep: Auto.
3. Average measurements: RBW = 1MHz, VBW = 10 Hz, Sweep: Auto.
4. “ * ”, means this data is the worst emission level.
5. Measurement Level = Reading Level + Correct Factor.
6. The average measurement was not performed when the peak measured data under the limit of average detection.
7. The Emission above 18GHz were not included is because their levels are too low.

Site : CB4-H	Time : 2017/02/17
Limit : FCC_Part22/24_00M_00M_PK	Margin : 6
Probe : CB4-H_CE_Sub_B432_1-18GHz_3M_1116 - HORIZONTAL	Power : DC 3.8V
EUT : LE910C1-NA	Note : Mode 3: DCS 1900_Link Mode_1880MHz

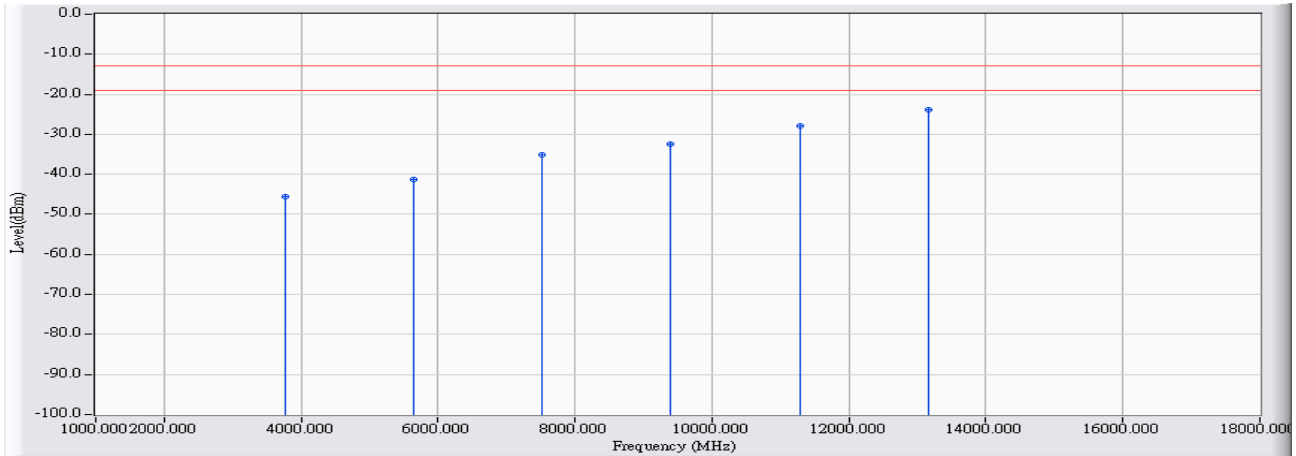

		Frequency (MHz)	Correct Factor (dB)	Reading Level (dBm)	Measure Level (dBm)	Margin (dB)	Limit (dBm)	Detector Type
1		3760.000	19.185	-64.880	-45.695	-32.695	-13.000	PEAK
2		5640.000	22.442	-63.610	-41.168	-28.168	-13.000	PEAK
3		7520.000	30.050	-65.070	-35.020	-22.020	-13.000	PEAK
4		9400.000	34.677	-67.230	-32.553	-19.553	-13.000	PEAK
5		11280.000	37.639	-65.560	-27.922	-14.922	-13.000	PEAK
6	*	13160.000	42.058	-66.010	-23.952	-10.952	-13.000	PEAK

Note:

1. All readings above 1GHz are performed with peak and/or average measurements as necessary.
2. Peak measurements: RBW = 1MHz, VBW = 1MHz, Sweep: Auto.
3. Average measurements: RBW = 1MHz, VBW = 10 Hz, Sweep: Auto.
4. “ * ”, means this data is the worst emission level.
5. Measurement Level = Reading Level + Correct Factor.
6. The average measurement was not performed when the peak measured data under the limit of average detection.
7. The Emission above 18GHz were not included is because their levels are too low.

Site : CB4-H	Time : 2017/02/17
Limit : FCC_Part22/24_00M_00M_PK	Margin : 6
Probe : CB4-H_CE_Sub_B432_1-18GHz_3M_1116 - VERTICAL	Power : DC 3.8V
EUT : LE910C1-NA	Note : Mode 3: DCS 1900_Link Mode_1880MHz

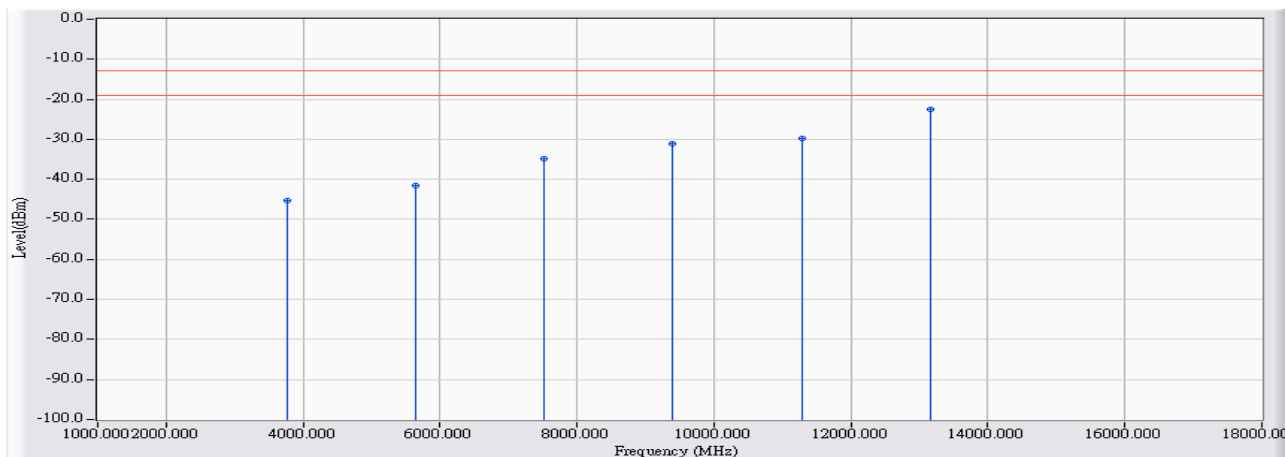

	Frequency (MHz)	Correct Factor (dB)	Reading Level (dBm)	Measure Level (dBm)	Margin (dB)	Limit (dBm)	Detector Type
1	3760.000	19.977	-65.200	-45.223	-32.223	-13.000	PEAK
2	5640.000	22.284	-63.860	-41.576	-28.576	-13.000	PEAK
3	7520.000	30.136	-64.900	-34.765	-21.765	-13.000	PEAK
4	9400.000	36.139	-67.340	-31.201	-18.201	-13.000	PEAK
5	11280.000	37.013	-66.640	-29.628	-16.628	-13.000	PEAK
6	* 13160.000	43.378	-65.780	-22.403	-9.403	-13.000	PEAK

Note:

1. All readings above 1GHz are performed with peak and/or average measurements as necessary.
2. Peak measurements: RBW = 1MHz, VBW = 1MHz, Sweep: Auto.
3. Average measurements: RBW = 1MHz, VBW = 10 Hz, Sweep: Auto.
4. “ * ”, means this data is the worst emission level.
5. Measurement Level = Reading Level + Correct Factor.
6. The average measurement was not performed when the peak measured data under the limit of average detection.
7. The Emission above 18GHz were not included is because their levels are too low.

Site : CB4-H	Time : 2017/02/17
Limit : FCC_Part22/24_00M_00M_PK	Margin : 6
Probe : CB4-H_CE_Sub_B432_1-18GHz_3M_1116 - HORIZONTAL	Power : DC 3.8V
EUT : LE910C1-NA	Note : Mode 3: DCS 1900_Link Mode_1909.8MHz

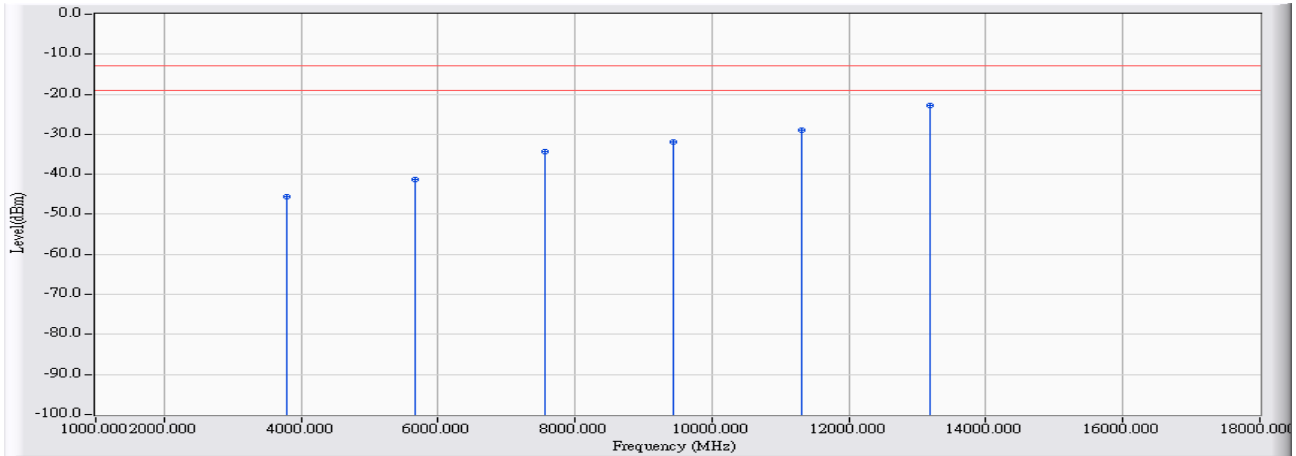

		Frequency (MHz)	Correct Factor (dB)	Reading Level (dBm)	Measure Level (dBm)	Margin (dB)	Limit (dBm)	Detector Type
1		3789.800	19.239	-64.950	-45.710	-32.710	-13.000	PEAK
2		5669.800	22.559	-63.960	-41.400	-28.400	-13.000	PEAK
3		7549.800	30.166	-64.580	-34.414	-21.414	-13.000	PEAK
4		9429.800	34.708	-66.630	-31.922	-18.922	-13.000	PEAK
5		11309.800	37.661	-66.500	-28.838	-15.838	-13.000	PEAK
6	*	13189.800	42.084	-64.960	-22.876	-9.876	-13.000	PEAK

Note:

1. All readings above 1GHz are performed with peak and/or average measurements as necessary.
2. Peak measurements: RBW = 1MHz, VBW = 1MHz, Sweep: Auto.
3. Average measurements: RBW = 1MHz, VBW = 10 Hz, Sweep: Auto.
4. “ * ”, means this data is the worst emission level.
5. Measurement Level = Reading Level + Correct Factor.
6. The average measurement was not performed when the peak measured data under the limit of average detection.
7. The Emission above 18GHz were not included is because their levels are too low.

Site : CB4-H	Time : 2017/02/17
Limit : FCC_Part22/24_00M_00M_PK	Margin : 6
Probe : CB4-H_CE_Sub_B432_1-18GHz_3M_1116 - VERTICAL	Power : DC 3.8V
EUT : LE910C1-NA	Note : Mode 3: DCS 1900_Link Mode_1909.8MHz

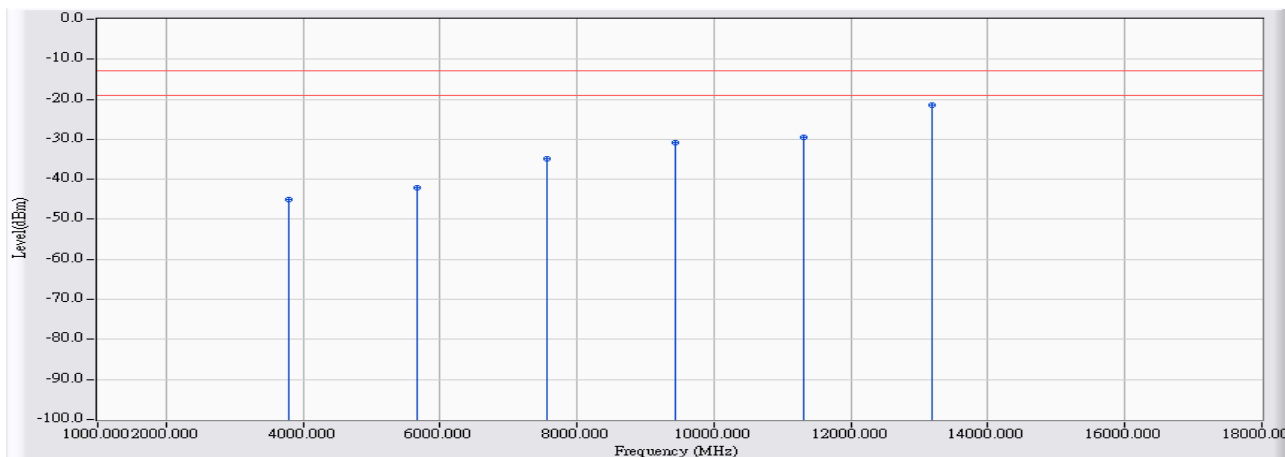

		Frequency (MHz)	Correct Factor (dB)	Reading Level (dBm)	Measure Level (dBm)	Margin (dB)	Limit (dBm)	Detector Type
1		3789.800	20.021	-65.100	-45.079	-32.079	-13.000	PEAK
2		5669.800	22.399	-64.520	-42.121	-29.121	-13.000	PEAK
3		7549.800	30.200	-64.980	-34.780	-21.780	-13.000	PEAK
4		9429.800	36.211	-67.050	-30.839	-17.839	-13.000	PEAK
5		11309.800	37.119	-66.530	-29.411	-16.411	-13.000	PEAK
6	*	13189.800	43.435	-64.920	-21.485	-8.485	-13.000	PEAK

Note:

1. All readings above 1GHz are performed with peak and/or average measurements as necessary.
2. Peak measurements: RBW = 1MHz, VBW = 1MHz, Sweep: Auto.
3. Average measurements: RBW = 1MHz, VBW = 10 Hz, Sweep: Auto.
4. “ * ”, means this data is the worst emission level.
5. Measurement Level = Reading Level + Correct Factor.
6. The average measurement was not performed when the peak measured data under the limit of average detection.
7. The Emission above 18GHz were not included is because their levels are too low.

Site : CB4-H	Time : 2017/02/17
Limit : FCC_Part22/24_00M_00M_PK	Margin : 6
Probe : CB4-H_CE_Sub_B432_1-18GHz_3M_1116 - HORIZONTAL	Power : DC 3.8V
EUT : LE910C1-NA	Note : Mode 4: DCS 1900_Idle Mode_1850.2MHz

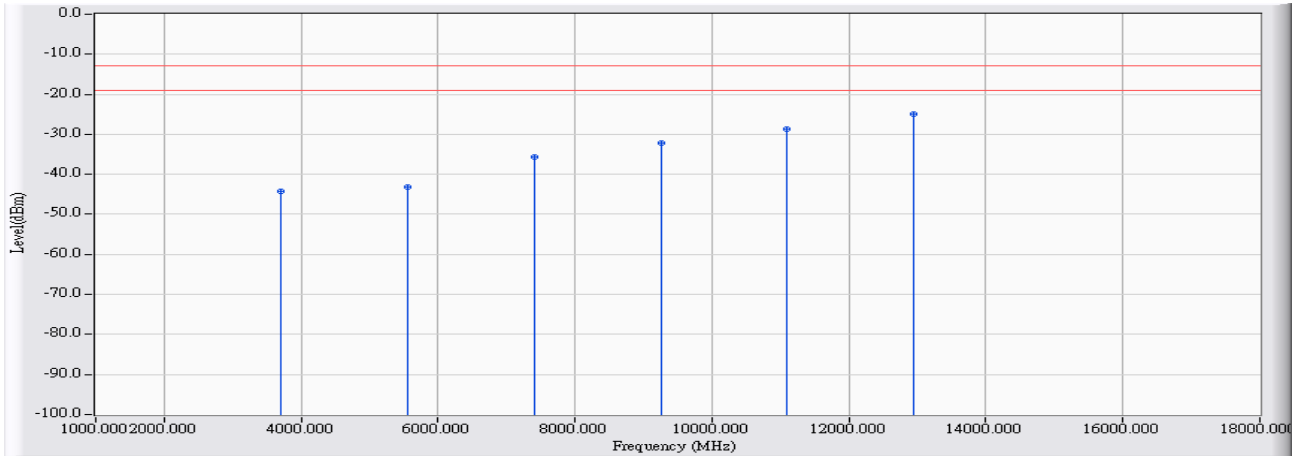

		Frequency (MHz)	Correct Factor (dB)	Reading Level (dBm)	Measure Level (dBm)	Margin (dB)	Limit (dBm)	Detector Type
1		3700.400	19.021	-63.360	-44.339	-31.339	-13.000	PEAK
2		5550.600	22.089	-65.250	-43.160	-30.160	-13.000	PEAK
3		7400.800	29.829	-65.560	-35.732	-22.732	-13.000	PEAK
4		9251.000	34.519	-66.740	-32.221	-19.221	-13.000	PEAK
5		11101.200	37.642	-66.230	-28.588	-15.588	-13.000	PEAK
6	*	12951.400	41.673	-66.710	-25.037	-12.037	-13.000	PEAK

Note:

1. All readings above 1GHz are performed with peak and/or average measurements as necessary.
2. Peak measurements: RBW = 1MHz, VBW = 1MHz, Sweep: Auto.
3. Average measurements: RBW = 1MHz, VBW = 10 Hz, Sweep: Auto.
4. “ * ”, means this data is the worst emission level.
5. Measurement Level = Reading Level + Correct Factor.
6. The average measurement was not performed when the peak measured data under the limit of average detection.
7. The Emission above 18GHz were not included is because their levels are too low.

Site : CB4-H	Time : 2017/02/17
Limit : FCC_Part22/24_00M_00M_PK	Margin : 6
Probe : CB4-H_CE_Sub_B432_1-18GHz_3M_1116 - VERTICAL	Power : DC 3.8V
EUT : LE910C1-NA	Note : Mode 4: DCS 1900_Idle Mode_1850.2MHz

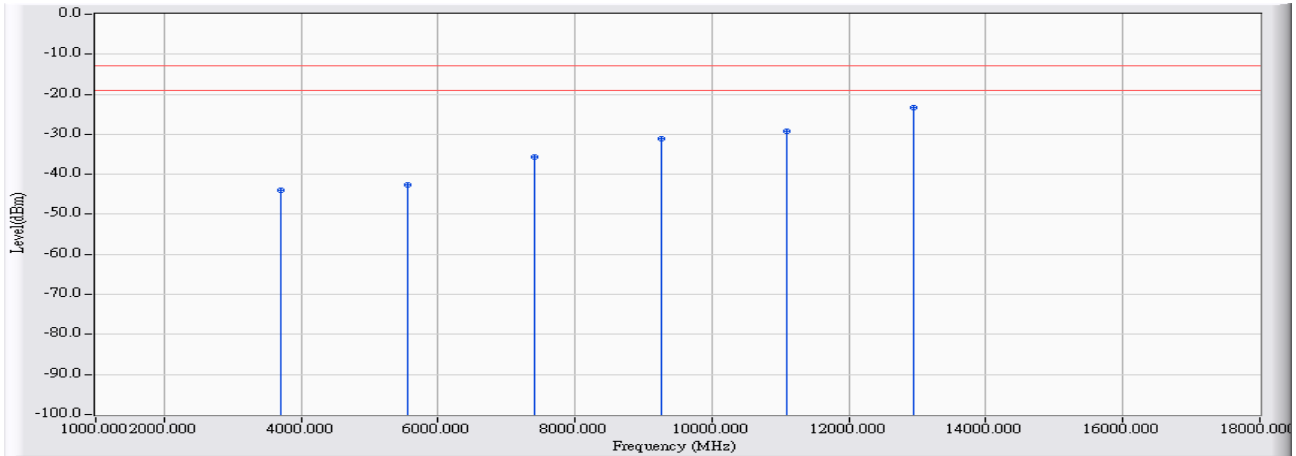

		Frequency (MHz)	Correct Factor (dB)	Reading Level (dBm)	Measure Level (dBm)	Margin (dB)	Limit (dBm)	Detector Type
1		3700.400	19.822	-63.850	-44.028	-31.028	-13.000	PEAK
2		5550.600	21.936	-64.610	-42.673	-29.673	-13.000	PEAK
3		7400.800	29.614	-65.360	-35.747	-22.747	-13.000	PEAK
4		9251.000	35.776	-66.760	-30.985	-17.985	-13.000	PEAK
5		11101.200	36.516	-65.810	-29.295	-16.295	-13.000	PEAK
6	*	12951.400	42.876	-66.110	-23.234	-10.234	-13.000	PEAK

Note:

1. All readings above 1GHz are performed with peak and/or average measurements as necessary.
2. Peak measurements: RBW = 1MHz, VBW = 1MHz, Sweep: Auto.
3. Average measurements: RBW = 1MHz, VBW = 10 Hz, Sweep: Auto.
4. “ * ”, means this data is the worst emission level.
5. Measurement Level = Reading Level + Correct Factor.
6. The average measurement was not performed when the peak measured data under the limit of average detection.
7. The Emission above 18GHz were not included is because their levels are too low.

Site : CB4-H	Time : 2017/02/17
Limit : FCC_Part22/24_00M_00M_PK	Margin : 6
Probe : CB4-H_CE_Sub_B432_1-18GHz_3M_1116 - HORIZONTAL	Power : DC 3.8V
EUT : LE910C1-NA	Note : Mode 4: DCS 1900_Idle Mode_1880MHz

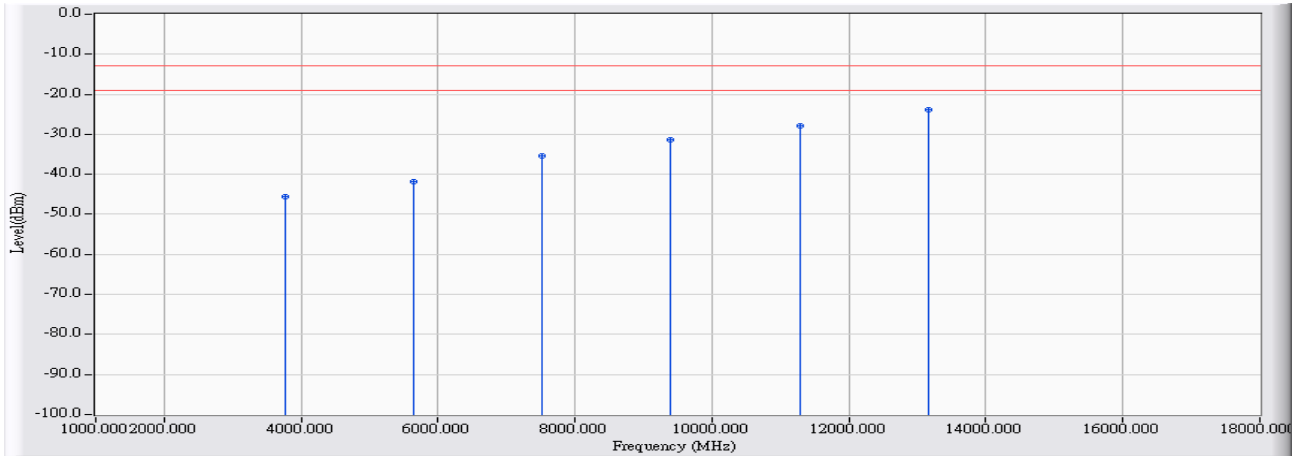

		Frequency (MHz)	Correct Factor (dB)	Reading Level (dBm)	Measure Level (dBm)	Margin (dB)	Limit (dBm)	Detector Type
1		3760.000	19.185	-64.790	-45.605	-32.605	-13.000	PEAK
2		5640.000	22.442	-64.280	-41.838	-28.838	-13.000	PEAK
3		7520.000	30.050	-65.510	-35.460	-22.460	-13.000	PEAK
4		9400.000	34.677	-66.130	-31.453	-18.453	-13.000	PEAK
5		11280.000	37.639	-65.510	-27.872	-14.872	-13.000	PEAK
6	*	13160.000	42.058	-66.050	-23.992	-10.992	-13.000	PEAK

Note:

1. All readings above 1GHz are performed with peak and/or average measurements as necessary.
2. Peak measurements: RBW = 1MHz, VBW = 1MHz, Sweep: Auto.
3. Average measurements: RBW = 1MHz, VBW = 10 Hz, Sweep: Auto.
4. “ * ”, means this data is the worst emission level.
5. Measurement Level = Reading Level + Correct Factor.
6. The average measurement was not performed when the peak measured data under the limit of average detection.
7. The Emission above 18GHz were not included is because their levels are too low.

Site : CB4-H	Time : 2017/02/17
Limit : FCC_Part22/24_00M_00M_PK	Margin : 6
Probe : CB4-H_CE_Sub_B432_1-18GHz_3M_1116 - VERTICAL	Power : DC 3.8V
EUT : LE910C1-NA	Note : Mode 4: DCS 1900_Idle Mode_1880MHz

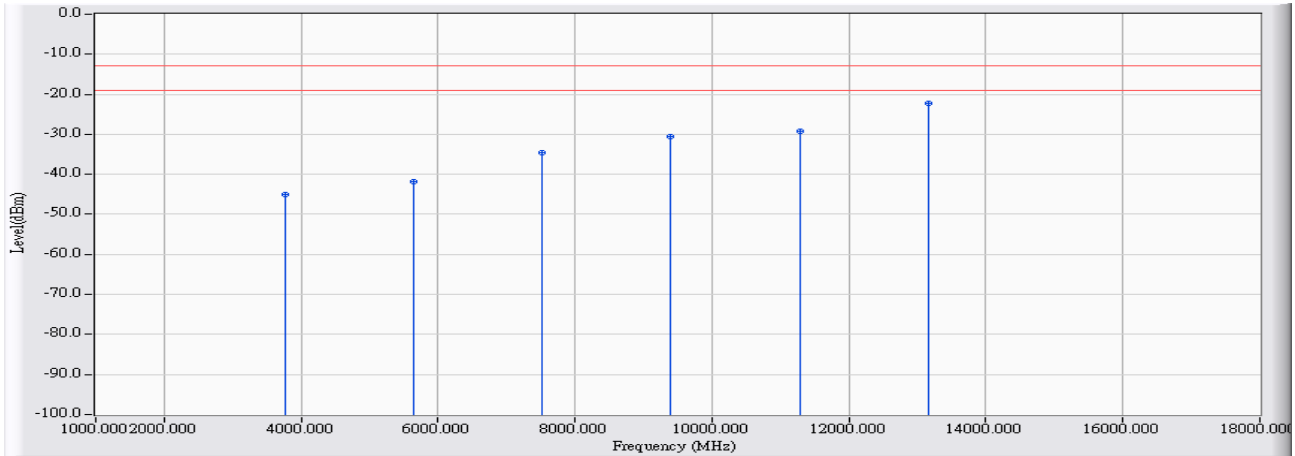

		Frequency (MHz)	Correct Factor (dB)	Reading Level (dBm)	Measure Level (dBm)	Margin (dB)	Limit (dBm)	Detector Type
1		3760.000	19.977	-65.010	-45.033	-32.033	-13.000	PEAK
2		5640.000	22.284	-64.060	-41.776	-28.776	-13.000	PEAK
3		7520.000	30.136	-64.600	-34.465	-21.465	-13.000	PEAK
4		9400.000	36.139	-66.570	-30.431	-17.431	-13.000	PEAK
5		11280.000	37.013	-66.250	-29.238	-16.238	-13.000	PEAK
6	*	13160.000	43.378	-65.630	-22.253	-9.253	-13.000	PEAK

Note:

1. All readings above 1GHz are performed with peak and/or average measurements as necessary.
2. Peak measurements: RBW = 1MHz, VBW = 1MHz, Sweep: Auto.
3. Average measurements: RBW = 1MHz, VBW = 10 Hz, Sweep: Auto.
4. “ * ”, means this data is the worst emission level.
5. Measurement Level = Reading Level + Correct Factor.
6. The average measurement was not performed when the peak measured data under the limit of average detection.
7. The Emission above 18GHz were not included is because their levels are too low.

Site : CB4-H	Time : 2017/02/17
Limit : FCC_Part22/24_00M_00M_PK	Margin : 6
Probe : CB4-H_CE_Sub_B432_1-18GHz_3M_1116 - HORIZONTAL	Power : DC 3.8V
EUT : LE910C1-NA	Note : Mode 4: DCS 1900_Idle Mode_1909.8MHz

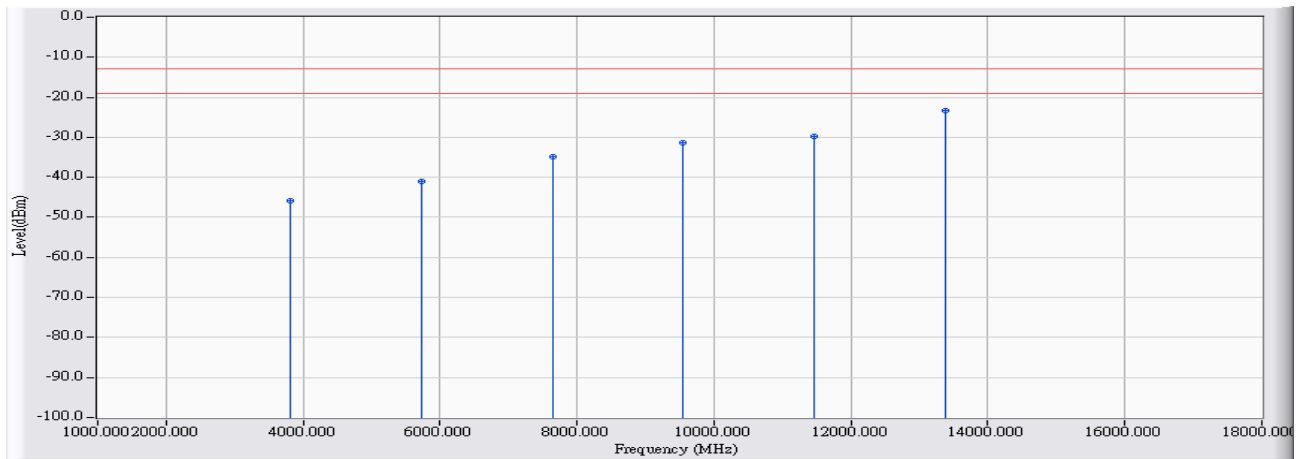

		Frequency (MHz)	Correct Factor (dB)	Reading Level (dBm)	Measure Level (dBm)	Margin (dB)	Limit (dBm)	Detector Type
1		3819.600	19.296	-65.060	-45.765	-32.765	-13.000	PEAK
2		5729.400	22.794	-63.900	-41.105	-28.105	-13.000	PEAK
3		7639.200	30.514	-65.390	-34.877	-21.877	-13.000	PEAK
4		9549.000	34.888	-66.240	-31.353	-18.353	-13.000	PEAK
5		11458.800	37.777	-67.450	-29.673	-16.673	-13.000	PEAK
6	*	13368.600	42.341	-65.740	-23.398	-10.398	-13.000	PEAK

Note:

1. All readings above 1GHz are performed with peak and/or average measurements as necessary.
2. Peak measurements: RBW = 1MHz, VBW = 1MHz, Sweep: Auto.
3. Average measurements: RBW = 1MHz, VBW = 10 Hz, Sweep: Auto.
4. “ * ”, means this data is the worst emission level.
5. Measurement Level = Reading Level + Correct Factor.
6. The average measurement was not performed when the peak measured data under the limit of average detection.
7. The Emission above 18GHz were not included is because their levels are too low.

Site : CB4-H	Time : 2017/02/17
Limit : FCC_Part22/24_00M_00M_PK	Margin : 6
Probe : CB4-H_CE_Sub_B432_1-18GHz_3M_1116 - VERTICAL	Power : DC 3.8V
EUT : LE910C1-NA	Note : Mode 4: DCS 1900_Idle Mode_1909.8MHz

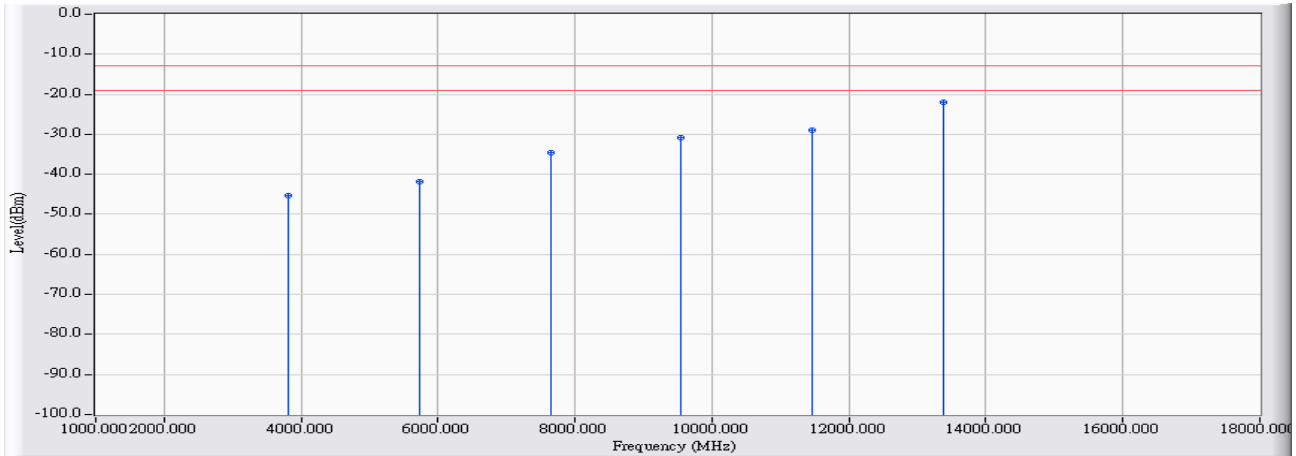

		Frequency (MHz)	Correct Factor (dB)	Reading Level (dBm)	Measure Level (dBm)	Margin (dB)	Limit (dBm)	Detector Type
1		3819.600	20.066	-65.320	-45.254	-32.254	-13.000	PEAK
2		5729.400	22.631	-64.580	-41.949	-28.949	-13.000	PEAK
3		7639.200	30.394	-64.870	-34.476	-21.476	-13.000	PEAK
4		9549.000	36.407	-67.210	-30.804	-17.804	-13.000	PEAK
5		11458.800	37.651	-66.650	-28.998	-15.998	-13.000	PEAK
6	*	13368.600	43.882	-65.800	-21.918	-8.918	-13.000	PEAK

Note:

1. All readings above 1GHz are performed with peak and/or average measurements as necessary.
2. Peak measurements: RBW = 1MHz, VBW = 1MHz, Sweep: Auto.
3. Average measurements: RBW = 1MHz, VBW = 10 Hz, Sweep: Auto.
4. “ * ”, means this data is the worst emission level.
5. Measurement Level = Reading Level + Correct Factor.
6. The average measurement was not performed when the peak measured data under the limit of average detection.
7. The Emission above 18GHz were not included is because their levels are too low.

Site : CB4-H	Time : 2017/02/17
Limit : FCC_Part22/24_00M_00M_PK	Margin : 6
Probe : CB4-H_CE_Sub_B432_1-18GHz_3M_1116 - HORIZONTAL	Power : DC 3.8V
EUT : LE910C1-NA	Note : Mode 5: GSM_EGPRS 850_Link Mode_824.2MHz

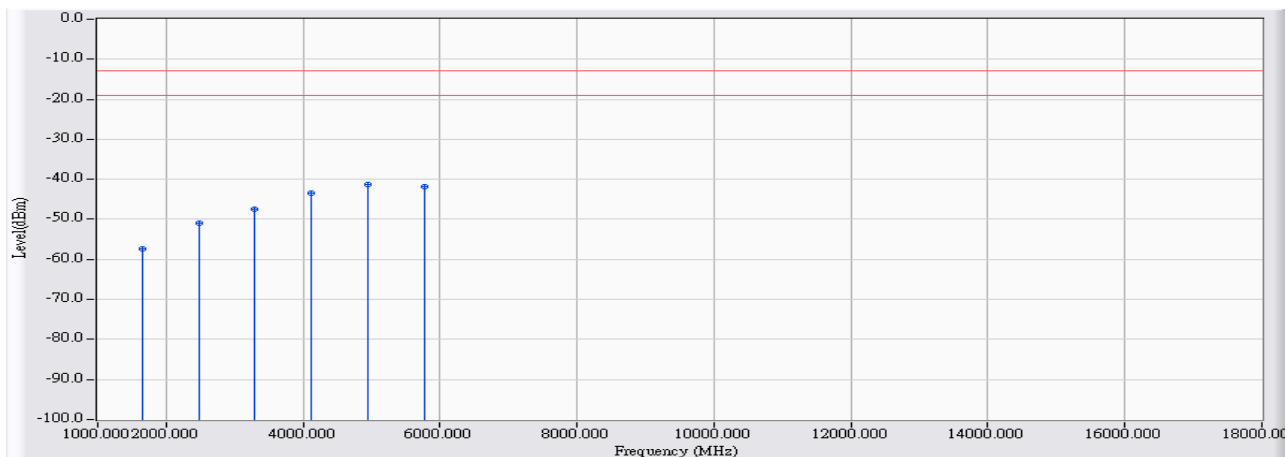

	Frequency (MHz)	Correct Factor (dB)	Reading Level (dBm)	Measure Level (dBm)	Margin (dB)	Limit (dBm)	Detector Type
1	1648.400	10.234	-67.670	-57.436	-44.436	-13.000	PEAK
2	2472.600	15.195	-66.030	-50.835	-37.835	-13.000	PEAK
3	3296.800	17.875	-65.330	-47.455	-34.455	-13.000	PEAK
4	4124.000	19.815	-63.320	-43.504	-30.504	-13.000	PEAK
5	* 4945.200	23.473	-64.880	-41.408	-28.408	-13.000	PEAK
6	5769.400	22.949	-64.640	-41.690	-28.690	-13.000	PEAK

Note:

1. All readings above 1GHz are performed with peak and/or average measurements as necessary.
2. Peak measurements: RBW = 1MHz, VBW = 1MHz, Sweep: Auto.
3. Average measurements: RBW = 1MHz, VBW = 10 Hz, Sweep: Auto.
4. “ * ”, means this data is the worst emission level.
5. Measurement Level = Reading Level + Correct Factor.
6. The average measurement was not performed when the peak measured data under the limit of average detection.
7. The Emission above 18GHz were not included is because their levels are too low.

Site : CB4-H	Time : 2017/02/17
Limit : FCC_Part22/24_00M_00M_PK	Margin : 6
Probe : CB4-H_CE_Sub_B432_1-18GHz_3M_1116 - VERTICAL	Power : DC 3.8V
EUT : LE910C1-NA	Note : Mode 5: GSM_EGPRS 850_Link Mode_824.2MHz

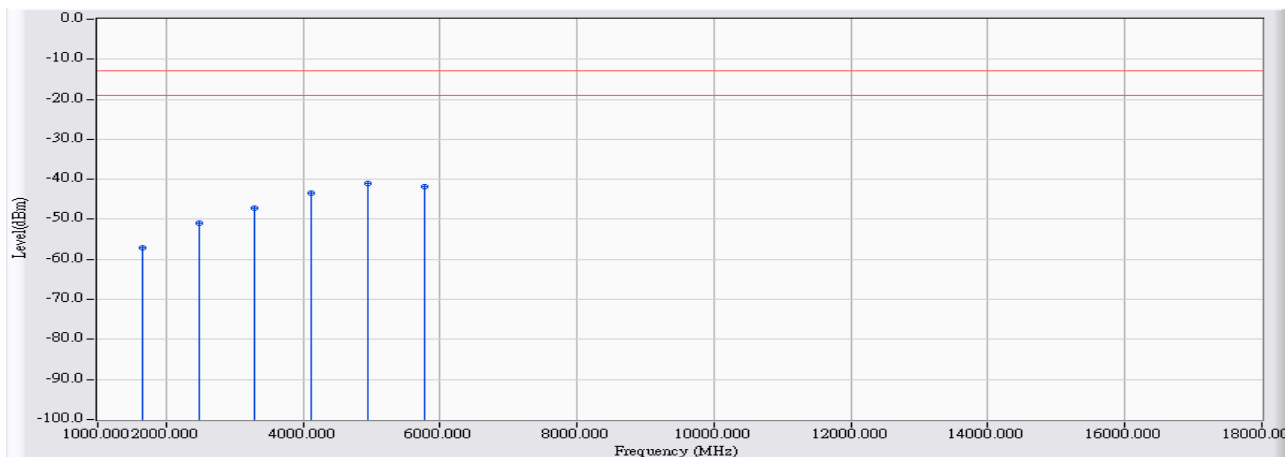

	Frequency (MHz)	Correct Factor (dB)	Reading Level (dBm)	Measure Level (dBm)	Margin (dB)	Limit (dBm)	Detector Type
1	1648.400	10.754	-67.770	-57.017	-44.017	-13.000	PEAK
2	2472.600	15.531	-66.390	-50.859	-37.859	-13.000	PEAK
3	3296.800	18.457	-65.560	-47.104	-34.104	-13.000	PEAK
4	4121.000	20.678	-64.040	-43.362	-30.362	-13.000	PEAK
5	* 4945.200	23.992	-64.900	-40.909	-27.909	-13.000	PEAK
6	5769.400	22.783	-64.610	-41.827	-28.827	-13.000	PEAK

Note:

1. All readings above 1GHz are performed with peak and/or average measurements as necessary.
2. Peak measurements: RBW = 1MHz, VBW = 1MHz, Sweep: Auto.
3. Average measurements: RBW = 1MHz, VBW = 10 Hz, Sweep: Auto.
4. “ * ”, means this data is the worst emission level.
5. Measurement Level = Reading Level + Correct Factor.
6. The average measurement was not performed when the peak measured data under the limit of average detection.
7. The Emission above 18GHz were not included is because their levels are too low.

Site : CB4-H	Time : 2017/02/17
Limit : FCC_Part22/24_00M_00M_PK	Margin : 6
Probe : CB4-H_CE_Sub_B432_1-18GHz_3M_1116 - HORIZONTAL	Power : DC 3.8V
EUT : LE910C1-NA	Note : Mode 5: GSM_EGPRS 850_Link Mode_836.6MHz

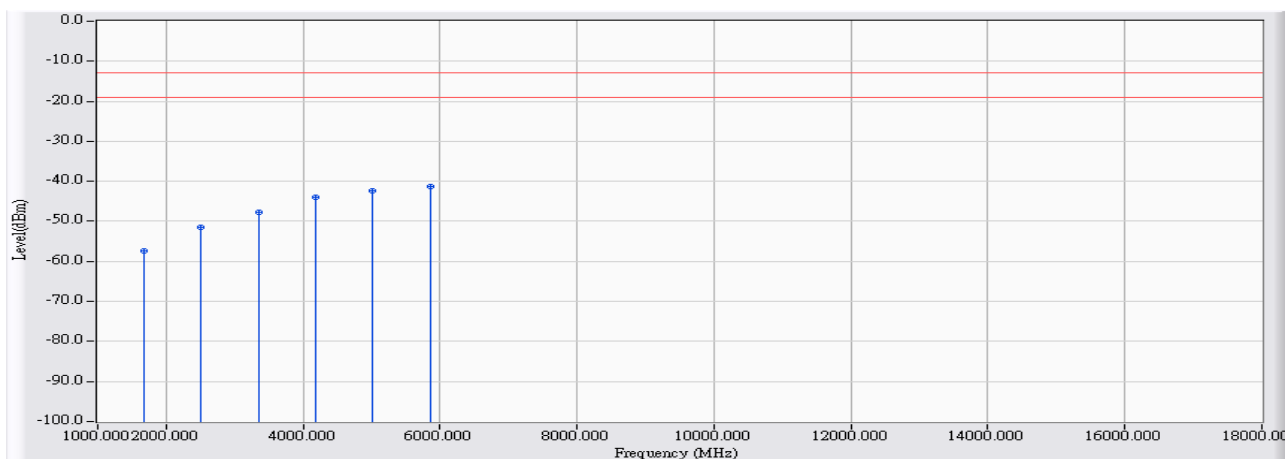

		Frequency (MHz)	Correct Factor (dB)	Reading Level (dBm)	Measure Level (dBm)	Margin (dB)	Limit (dBm)	Detector Type
1		1673.200	10.200	-67.580	-57.380	-44.380	-13.000	PEAK
2		2509.800	15.141	-66.500	-51.358	-38.358	-13.000	PEAK
3		3346.400	18.010	-65.810	-47.799	-34.799	-13.000	PEAK
4		4183.000	19.904	-63.840	-43.935	-30.935	-13.000	PEAK
5		5019.600	21.331	-63.750	-42.419	-29.419	-13.000	PEAK
6	*	5856.200	23.275	-64.640	-41.366	-28.366	-13.000	PEAK

Note:

1. All readings above 1GHz are performed with peak and/or average measurements as necessary.
2. Peak measurements: RBW = 1MHz, VBW = 1MHz, Sweep: Auto.
3. Average measurements: RBW = 1MHz, VBW = 10 Hz, Sweep: Auto.
4. “ * ”, means this data is the worst emission level.
5. Measurement Level = Reading Level + Correct Factor.
6. The average measurement was not performed when the peak measured data under the limit of average detection.
7. The Emission above 18GHz were not included is because their levels are too low.

Site : CB4-H	Time : 2017/02/17
Limit : FCC_Part22/24_00M_00M_PK	Margin : 6
Probe : CB4-H_CE_Sub_B432_1-18GHz_3M_1116 - VERTICAL	Power : DC 3.8V
EUT : LE910C1-NA	Note : Mode 5: GSM_EGPRS 850_Link Mode_836.6MHz

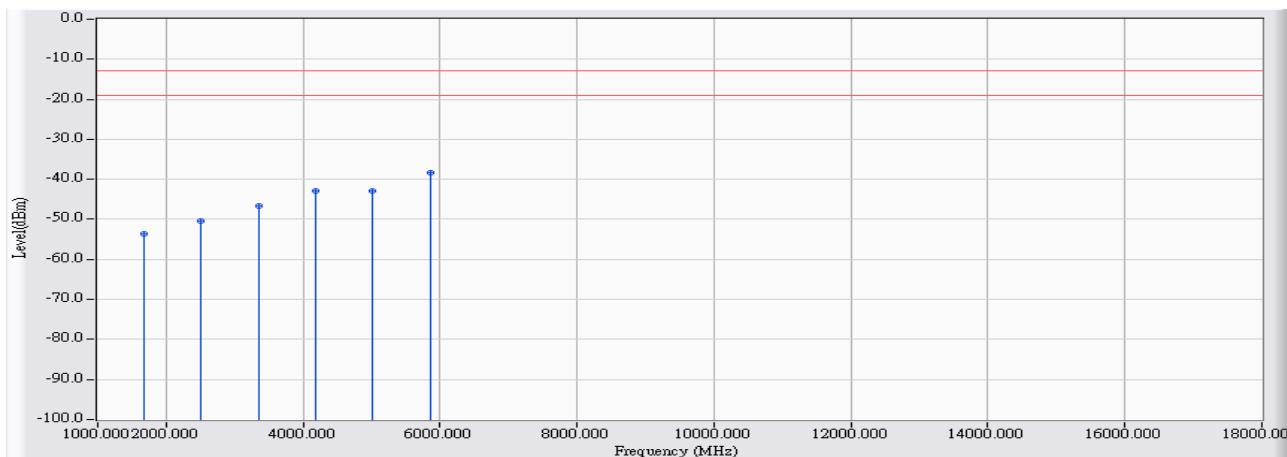

	Frequency (MHz)	Correct Factor (dB)	Reading Level (dBm)	Measure Level (dBm)	Margin (dB)	Limit (dBm)	Detector Type
1	1673.200	10.765	-64.350	-53.585	-40.585	-13.000	PEAK
2	2509.800	15.530	-66.020	-50.489	-37.489	-13.000	PEAK
3	3346.400	18.651	-65.210	-46.558	-33.558	-13.000	PEAK
4	4183.000	20.854	-63.810	-42.956	-29.956	-13.000	PEAK
5	5019.600	20.970	-63.900	-42.930	-29.930	-13.000	PEAK
6	* 5856.200	23.103	-61.380	-38.277	-25.277	-13.000	PEAK

Note:

1. All readings above 1GHz are performed with peak and/or average measurements as necessary.
2. Peak measurements: RBW = 1MHz, VBW = 1MHz, Sweep: Auto.
3. Average measurements: RBW = 1MHz, VBW = 10 Hz, Sweep: Auto.
4. “ * ”, means this data is the worst emission level.
5. Measurement Level = Reading Level + Correct Factor.
6. The average measurement was not performed when the peak measured data under the limit of average detection.
7. The Emission above 18GHz were not included is because their levels are too low.

Site : CB4-H	Time : 2017/02/17
Limit : FCC_Part22/24_00M_00M_PK	Margin : 6
Probe : CB4-H_CE_Sub_B432_1-18GHz_3M_1116 - HORIZONTAL	Power : DC 3.8V
EUT : LE910C1-NA	Note : Mode 5: GSM_EGPRS 850_Link Mode_ 848.8MHz

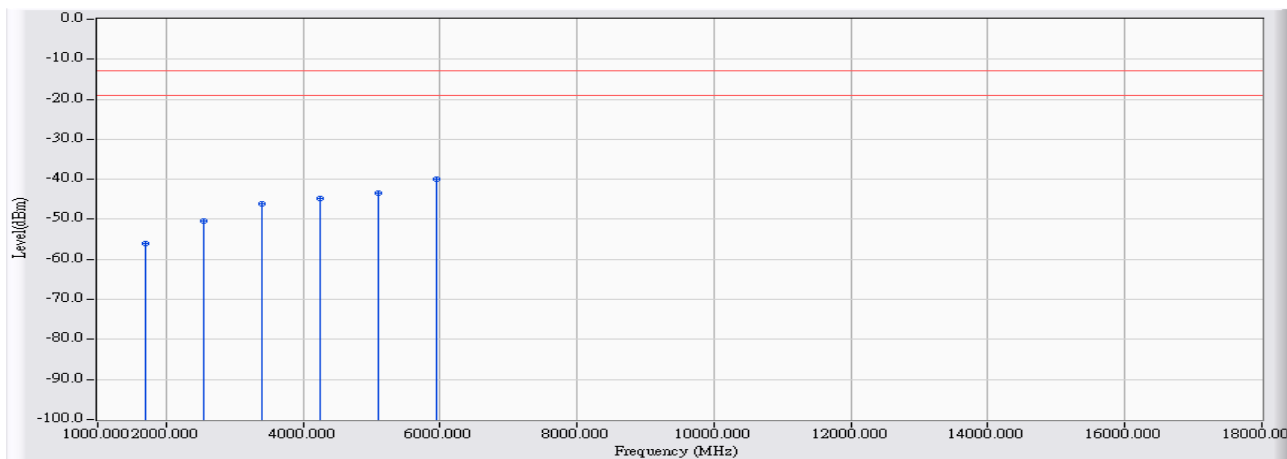

		Frequency (MHz)	Correct Factor (dB)	Reading Level (dBm)	Measure Level (dBm)	Margin (dB)	Limit (dBm)	Detector Type
1		1697.600	10.167	-66.240	-56.073	-43.073	-13.000	PEAK
2		2546.400	15.247	-65.720	-50.472	-37.472	-13.000	PEAK
3		3395.200	18.145	-64.350	-46.204	-33.204	-13.000	PEAK
4		4244.000	19.992	-64.770	-44.778	-31.778	-13.000	PEAK
5		5092.800	21.416	-64.760	-43.344	-30.344	-13.000	PEAK
6	*	5941.600	23.594	-63.530	-39.936	-26.936	-13.000	PEAK

Note:

1. All readings above 1GHz are performed with peak and/or average measurements as necessary.
2. Peak measurements: RBW = 1MHz, VBW = 1MHz, Sweep: Auto.
3. Average measurements: RBW = 1MHz, VBW = 10 Hz, Sweep: Auto.
4. “ * ”, means this data is the worst emission level.
5. Measurement Level = Reading Level + Correct Factor.
6. The average measurement was not performed when the peak measured data under the limit of average detection.
7. The Emission above 18GHz were not included is because their levels are too low.

Site : CB4-H	Time : 2017/02/17
Limit : FCC_Part22/24_00M_00M_PK	Margin : 6
Probe : CB4-H_CE_Sub_B432_1-18GHz_3M_1116 - VERTICAL	Power : DC 3.8V
EUT : LE910C1-NA	Note : Mode 5: GSM_EGPRS 850_Link Mode_ 848.8MHz

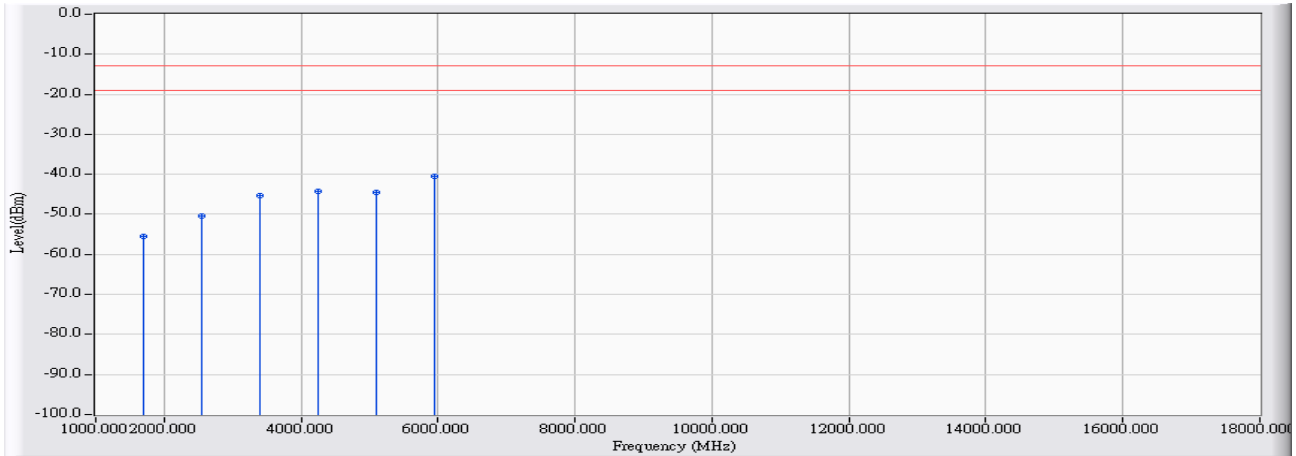

		Frequency (MHz)	Correct Factor (dB)	Reading Level (dBm)	Measure Level (dBm)	Margin (dB)	Limit (dBm)	Detector Type
1		1697.600	10.777	-66.240	-55.463	-42.463	-13.000	PEAK
2		2546.400	15.623	-66.090	-50.467	-37.467	-13.000	PEAK
3		3395.200	18.844	-64.260	-45.415	-32.415	-13.000	PEAK
4		4244.000	21.023	-65.140	-44.117	-31.117	-13.000	PEAK
5		5092.800	21.087	-65.520	-44.433	-31.433	-13.000	PEAK
6	*	5941.600	23.417	-64.010	-40.593	-27.593	-13.000	PEAK

Note:

1. All readings above 1GHz are performed with peak and/or average measurements as necessary.
2. Peak measurements: RBW = 1MHz, VBW = 1MHz, Sweep: Auto.
3. Average measurements: RBW = 1MHz, VBW = 10 Hz, Sweep: Auto.
4. “ * ”, means this data is the worst emission level.
5. Measurement Level = Reading Level + Correct Factor.
6. The average measurement was not performed when the peak measured data under the limit of average detection.
7. The Emission above 18GHz were not included is because their levels are too low.

Site : CB4-H	Time : 2017/02/17
Limit : FCC_Part22/24_00M_00M_PK	Margin : 6
Probe : CB4-H_CE_Sub_B432_1-18GHz_3M_1116 - HORIZONTAL	Power : DC 3.8V
EUT : LE910C1-NA	Note : Mode 6: GSM_EGPRS 850_Idle Mode_824.2MHz

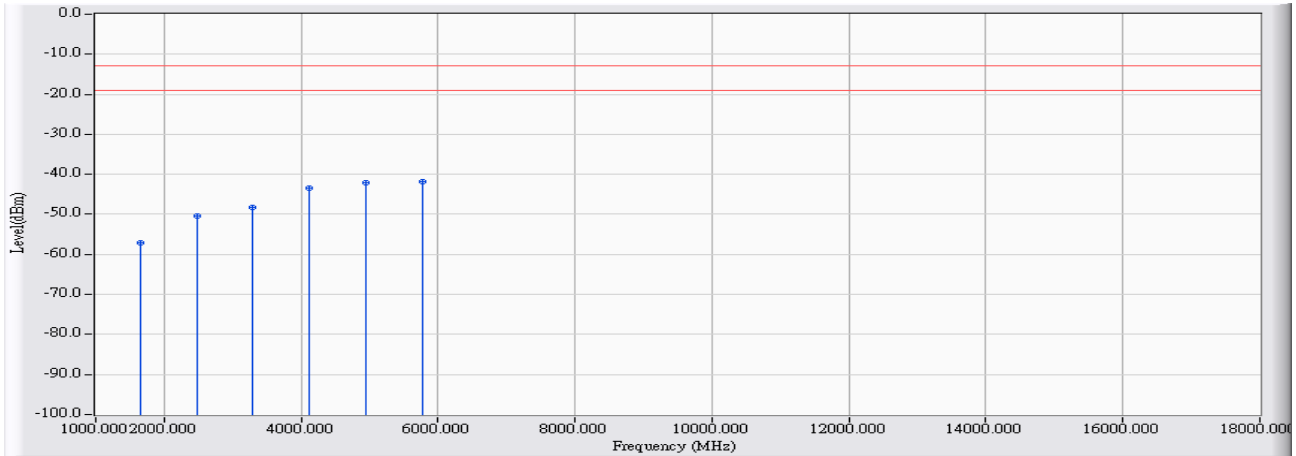

		Frequency (MHz)	Correct Factor (dB)	Reading Level (dBm)	Measure Level (dBm)	Margin (dB)	Limit (dBm)	Detector Type
1		1648.400	10.234	-67.470	-57.236	-44.236	-13.000	PEAK
2		2472.600	15.195	-65.730	-50.535	-37.535	-13.000	PEAK
3		3296.800	17.875	-66.110	-48.235	-35.235	-13.000	PEAK
4		4121.000	19.811	-63.190	-43.378	-30.378	-13.000	PEAK
5		4945.200	23.473	-65.630	-42.158	-29.158	-13.000	PEAK
6	*	5769.400	22.949	-64.760	-41.810	-28.810	-13.000	PEAK

Note:

1. All readings above 1GHz are performed with peak and/or average measurements as necessary.
2. Peak measurements: RBW = 1MHz, VBW = 1MHz, Sweep: Auto.
3. Average measurements: RBW = 1MHz, VBW = 10 Hz, Sweep: Auto.
4. “ * ”, means this data is the worst emission level.
5. Measurement Level = Reading Level + Correct Factor.
6. The average measurement was not performed when the peak measured data under the limit of average detection.
7. The Emission above 18GHz were not included is because their levels are too low.

Site : CB4-H	Time : 2017/02/17
Limit : FCC_Part22/24_00M_00M_PK	Margin : 6
Probe : CB4-H_CE_Sub_B432_1-18GHz_3M_1116 - VERTICAL	Power : DC 3.8V
EUT : LE910C1-NA	Note : Mode 6: GSM_EGPRS 850_Idle Mode_824.2MHz

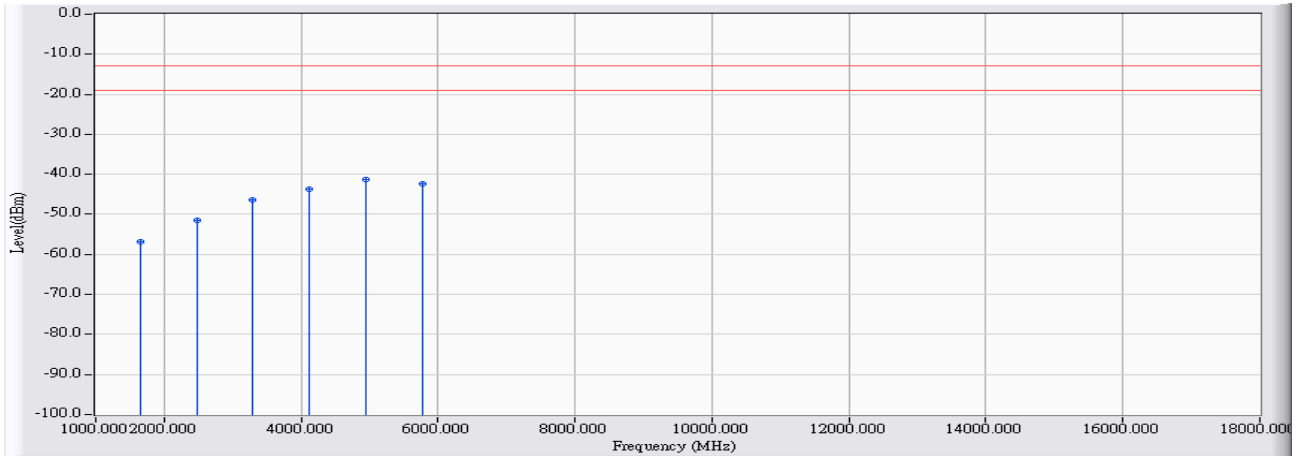

	Frequency (MHz)	Correct Factor (dB)	Reading Level (dBm)	Measure Level (dBm)	Margin (dB)	Limit (dBm)	Detector Type
1	1648.400	10.754	-67.540	-56.787	-43.787	-13.000	PEAK
2	2472.600	15.531	-66.950	-51.419	-38.419	-13.000	PEAK
3	3296.800	18.457	-64.840	-46.384	-33.384	-13.000	PEAK
4	4121.000	20.678	-64.430	-43.752	-30.752	-13.000	PEAK
5	* 4945.200	23.992	-65.240	-41.249	-28.249	-13.000	PEAK
6	5769.400	22.783	-65.130	-42.347	-29.347	-13.000	PEAK

Note:

1. All readings above 1GHz are performed with peak and/or average measurements as necessary.
2. Peak measurements: RBW = 1MHz, VBW = 1MHz, Sweep: Auto.
3. Average measurements: RBW = 1MHz, VBW = 10 Hz, Sweep: Auto.
4. “ * ”, means this data is the worst emission level.
5. Measurement Level = Reading Level + Correct Factor.
6. The average measurement was not performed when the peak measured data under the limit of average detection.
7. The Emission above 18GHz were not included is because their levels are too low.

Site : CB4-H	Time : 2017/02/17
Limit : FCC_Part22/24_00M_00M_PK	Margin : 6
Probe : CB4-H_CE_Sub_B432_1-18GHz_3M_1116 - HORIZONTAL	Power : DC 3.8V
EUT : LE910C1-NA	Note : Mode 6: GSM_EGPRS 850_Idle Mode_836.6MHz

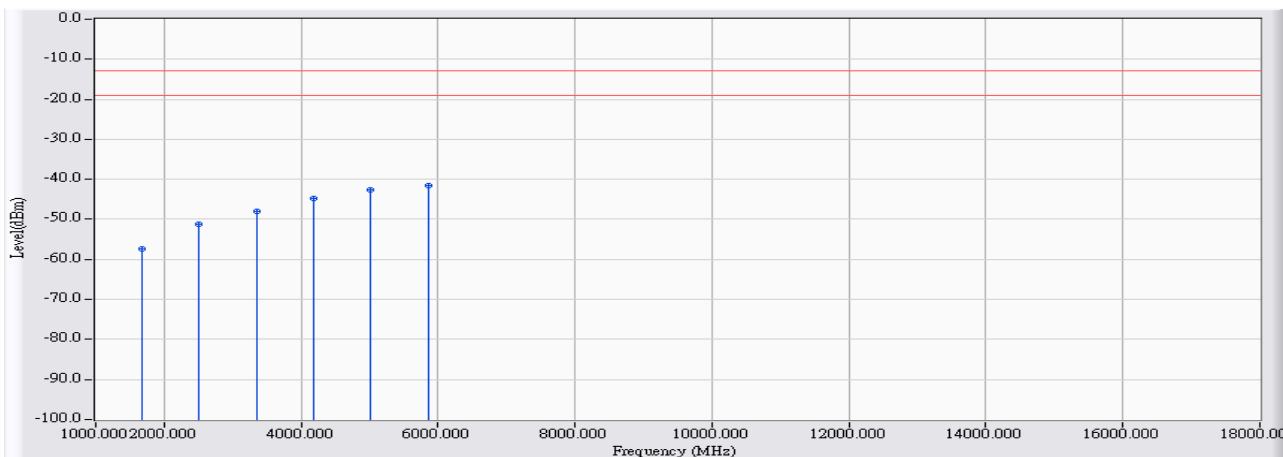

		Frequency (MHz)	Correct Factor (dB)	Reading Level (dBm)	Measure Level (dBm)	Margin (dB)	Limit (dBm)	Detector Type
1		1673.200	10.200	-67.690	-57.490	-44.490	-13.000	PEAK
2		2509.800	15.141	-66.420	-51.278	-38.278	-13.000	PEAK
3		3346.400	18.010	-66.070	-48.059	-35.059	-13.000	PEAK
4		4183.000	19.904	-64.560	-44.655	-31.655	-13.000	PEAK
5		5019.600	21.331	-64.080	-42.749	-29.749	-13.000	PEAK
6	*	5856.200	23.275	-64.800	-41.526	-28.526	-13.000	PEAK

Note:

1. All readings above 1GHz are performed with peak and/or average measurements as necessary.
2. Peak measurements: RBW = 1MHz, VBW = 1MHz, Sweep: Auto.
3. Average measurements: RBW = 1MHz, VBW = 10 Hz, Sweep: Auto.
4. “ * ”, means this data is the worst emission level.
5. Measurement Level = Reading Level + Correct Factor.
6. The average measurement was not performed when the peak measured data under the limit of average detection.
7. The Emission above 18GHz were not included is because their levels are too low.

Site : CB4-H	Time : 2017/02/17
Limit : FCC_Part22/24_00M_00M_PK	Margin : 6
Probe : CB4-H_CE_Sub_B432_1-18GHz_3M_1116 - VERTICAL	Power : DC 3.8V
EUT : LE910C1-NA	Note : Mode 6: GSM_EGPRS 850_Idle Mode_836.6MHz

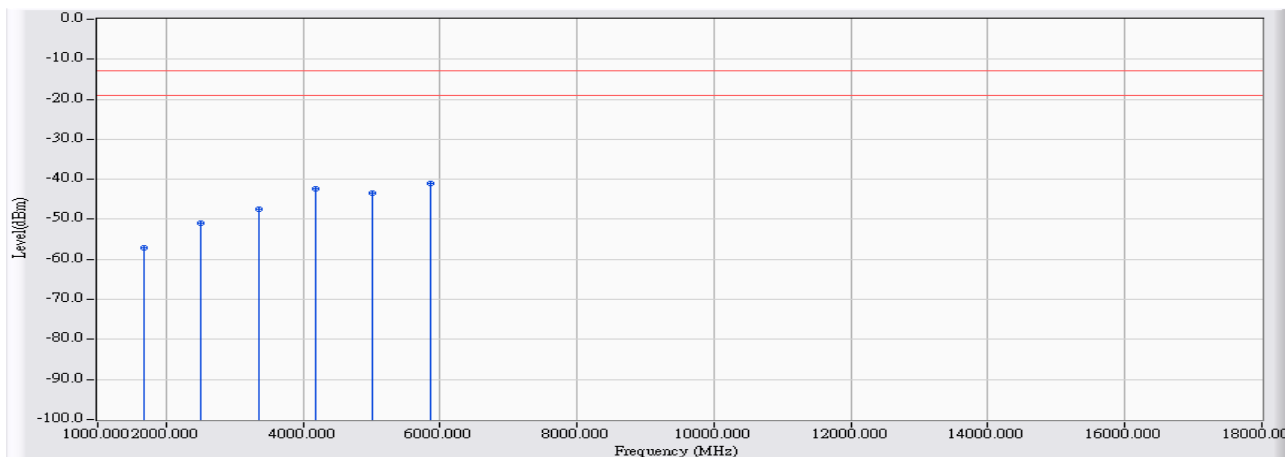

	Frequency (MHz)	Correct Factor (dB)	Reading Level (dBm)	Measure Level (dBm)	Margin (dB)	Limit (dBm)	Detector Type
1	1673.200	10.765	-67.740	-56.975	-43.975	-13.000	PEAK
2	2509.800	15.530	-66.370	-50.839	-37.839	-13.000	PEAK
3	3346.400	18.651	-66.110	-47.458	-34.458	-13.000	PEAK
4	4183.000	20.854	-63.320	-42.466	-29.466	-13.000	PEAK
5	5019.600	20.970	-64.380	-43.410	-30.410	-13.000	PEAK
6	* 5856.200	23.103	-64.140	-41.037	-28.037	-13.000	PEAK

Note:

1. All readings above 1GHz are performed with peak and/or average measurements as necessary.
2. Peak measurements: RBW = 1MHz, VBW = 1MHz, Sweep: Auto.
3. Average measurements: RBW = 1MHz, VBW = 10 Hz, Sweep: Auto.
4. “ * ”, means this data is the worst emission level.
5. Measurement Level = Reading Level + Correct Factor.
6. The average measurement was not performed when the peak measured data under the limit of average detection.
7. The Emission above 18GHz were not included is because their levels are too low.

Site : CB4-H	Time : 2017/02/17
Limit : FCC_Part22/24_00M_00M_PK	Margin : 6
Probe : CB4-H_CE_Sub_B432_1-18GHz_3M_1116 - HORIZONTAL	Power : DC 3.8V
EUT : LE910C1-NA	Note : Mode 6: GSM_EGPRS 850_Idle Mode_848.8MHz

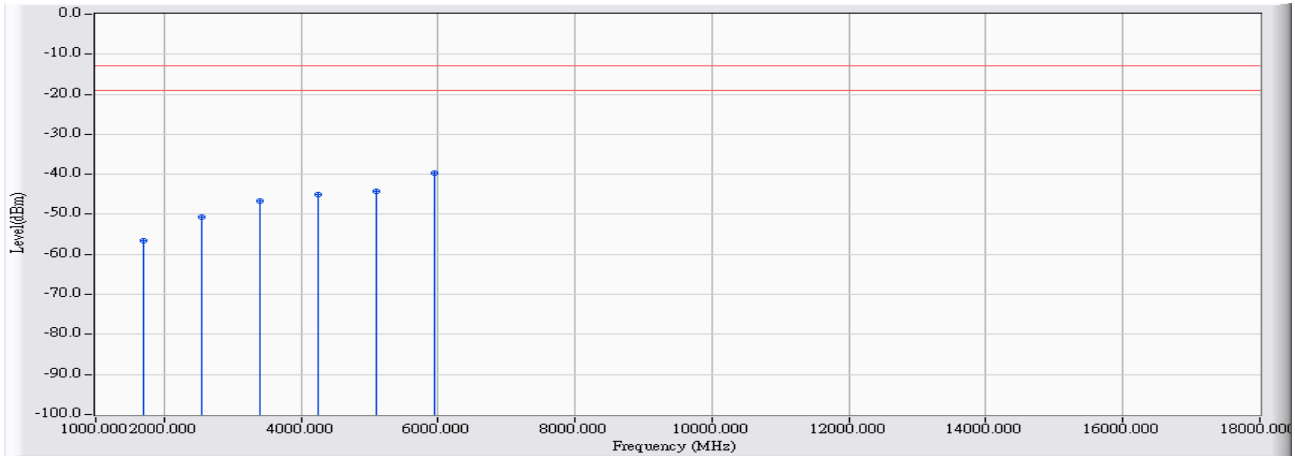

	Frequency (MHz)	Correct Factor (dB)	Reading Level (dBm)	Measure Level (dBm)	Margin (dB)	Limit (dBm)	Detector Type
1	1697.600	10.167	-66.670	-56.503	-43.503	-13.000	PEAK
2	2546.400	15.247	-66.010	-50.762	-37.762	-13.000	PEAK
3	3395.200	18.145	-64.760	-46.614	-33.614	-13.000	PEAK
4	4244.000	19.992	-64.950	-44.958	-31.958	-13.000	PEAK
5	5092.800	21.416	-65.650	-44.234	-31.234	-13.000	PEAK
6	* 5941.600	23.594	-63.290	-39.696	-26.696	-13.000	PEAK

Note:

1. All readings above 1GHz are performed with peak and/or average measurements as necessary.
2. Peak measurements: RBW = 1MHz, VBW = 1MHz, Sweep: Auto.
3. Average measurements: RBW = 1MHz, VBW = 10 Hz, Sweep: Auto.
4. “ * ”, means this data is the worst emission level.
5. Measurement Level = Reading Level + Correct Factor.
6. The average measurement was not performed when the peak measured data under the limit of average detection.
7. The Emission above 18GHz were not included is because their levels are too low.

Site : CB4-H	Time : 2017/02/17
Limit : FCC_Part22/24_00M_00M_PK	Margin : 6
Probe : CB4-H_CE_Sub_B432_1-18GHz_3M_1116 - VERTICAL	Power : DC 3.8V
EUT : LE910C1-NA	Note : Mode 6: GSM_EGPRS 850_Idle Mode_848.8MHz

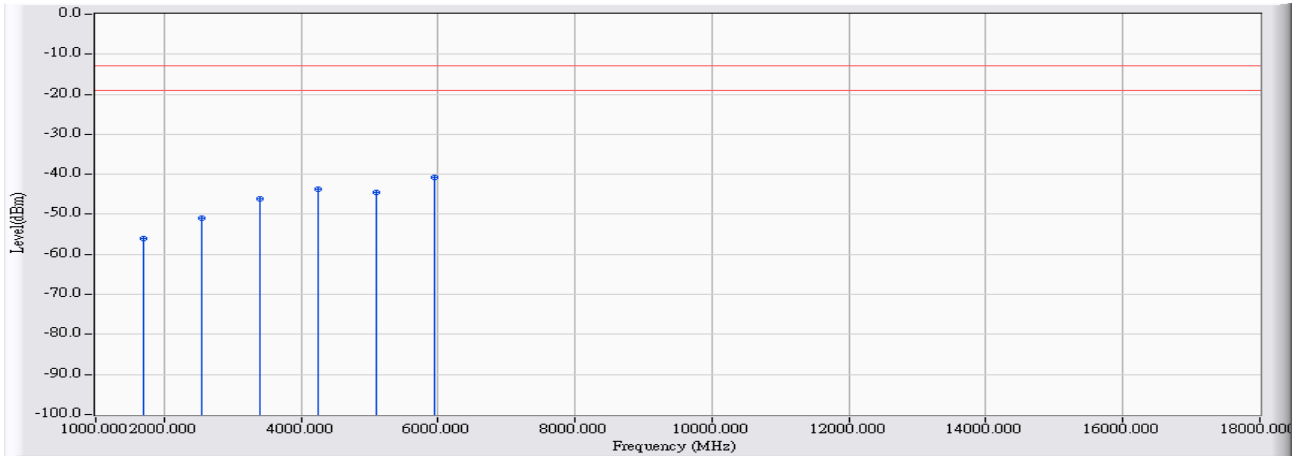

		Frequency (MHz)	Correct Factor (dB)	Reading Level (dBm)	Measure Level (dBm)	Margin (dB)	Limit (dBm)	Detector Type
1		1697.600	10.777	-66.680	-55.903	-42.903	-13.000	PEAK
2		2546.400	15.623	-66.480	-50.857	-37.857	-13.000	PEAK
3		3395.200	18.844	-64.970	-46.125	-33.125	-13.000	PEAK
4		4244.000	21.023	-64.690	-43.667	-30.667	-13.000	PEAK
5		5092.800	21.087	-65.630	-44.543	-31.543	-13.000	PEAK
6	*	5941.600	23.417	-64.130	-40.713	-27.713	-13.000	PEAK

Note:

1. All readings above 1GHz are performed with peak and/or average measurements as necessary.
2. Peak measurements: RBW = 1MHz, VBW = 1MHz, Sweep: Auto.
3. Average measurements: RBW = 1MHz, VBW = 10 Hz, Sweep: Auto.
4. “ * ”, means this data is the worst emission level.
5. Measurement Level = Reading Level + Correct Factor.
6. The average measurement was not performed when the peak measured data under the limit of average detection.
7. The Emission above 18GHz were not included is because their levels are too low.

Site : CB4-H	Time : 2017/02/17
Limit : FCC_Part22/24_00M_00M_PK	Margin : 6
Probe : CB4-H_CE_Sub_B432_1-18GHz_3M_1116 - HORIZONTAL	Power : DC 3.8V
EUT : LE910C1-NA	Note : Mode 7: DCS_EGPRS 1900_Link Mode_ 1850.2MHz

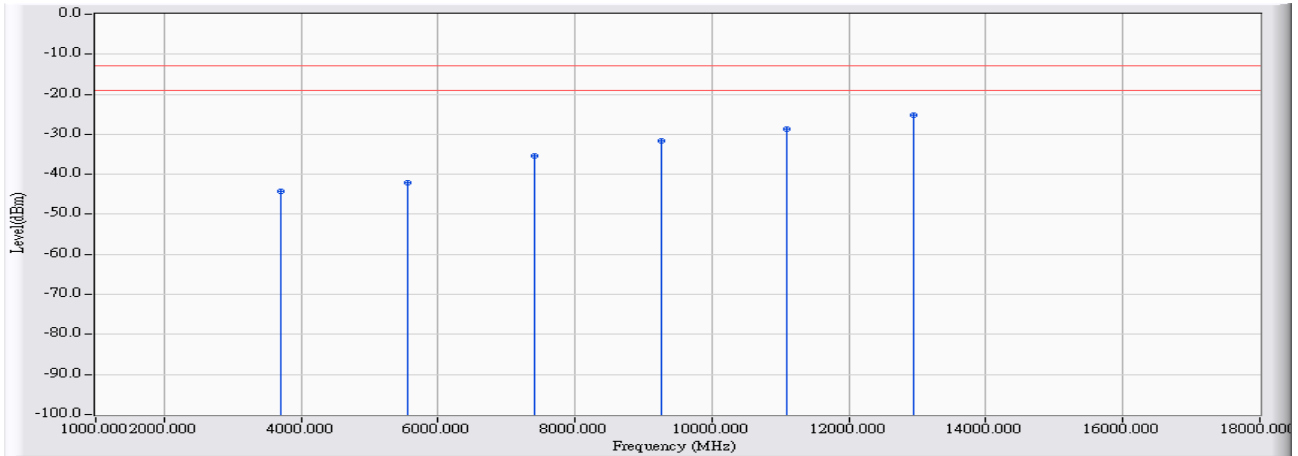

		Frequency (MHz)	Correct Factor (dB)	Reading Level (dBm)	Measure Level (dBm)	Margin (dB)	Limit (dBm)	Detector Type
1		3700.400	19.021	-63.380	-44.359	-31.359	-13.000	PEAK
2		5550.600	22.089	-64.230	-42.140	-29.140	-13.000	PEAK
3		7400.800	29.829	-65.330	-35.502	-22.502	-13.000	PEAK
4		9251.000	34.519	-66.240	-31.721	-18.721	-13.000	PEAK
5		11101.200	37.642	-66.260	-28.618	-15.618	-13.000	PEAK
6	*	12951.400	41.673	-66.760	-25.087	-12.087	-13.000	PEAK

Note:

1. All readings above 1GHz are performed with peak and/or average measurements as necessary.
2. Peak measurements: RBW = 1MHz, VBW = 1MHz, Sweep: Auto.
3. Average measurements: RBW = 1MHz, VBW = 10 Hz, Sweep: Auto.
4. “ * ”, means this data is the worst emission level.
5. Measurement Level = Reading Level + Correct Factor.
6. The average measurement was not performed when the peak measured data under the limit of average detection.
7. The Emission above 18GHz were not included is because their levels are too low.

Site : CB4-H	Time : 2017/02/17
Limit : FCC_Part22/24_00M_00M_PK	Margin : 6
Probe : CB4-H_CE_Sub_B432_1-18GHz_3M_1116 - VERTICAL	Power : DC 3.8V
EUT : LE910C1-NA	Note : Mode 7: DCS_EGPRS 1900_Link Mode_ 1850.2MHz

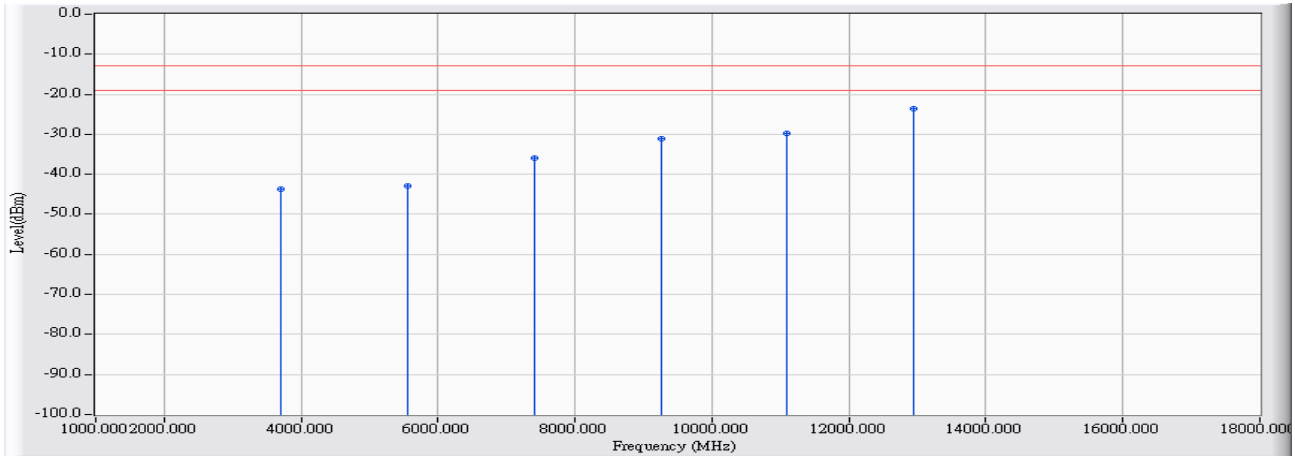

		Frequency (MHz)	Correct Factor (dB)	Reading Level (dBm)	Measure Level (dBm)	Margin (dB)	Limit (dBm)	Detector Type
1		3700.400	19.822	-63.540	-43.718	-30.718	-13.000	PEAK
2		5550.600	21.936	-64.940	-43.003	-30.003	-13.000	PEAK
3		7400.800	29.614	-65.670	-36.057	-23.057	-13.000	PEAK
4		9251.000	35.776	-66.880	-31.105	-18.105	-13.000	PEAK
5		11101.200	36.516	-66.170	-29.655	-16.655	-13.000	PEAK
6	*	12951.400	42.876	-66.400	-23.524	-10.524	-13.000	PEAK

Note:

1. All readings above 1GHz are performed with peak and/or average measurements as necessary.
2. Peak measurements: RBW = 1MHz, VBW = 1MHz, Sweep: Auto.
3. Average measurements: RBW = 1MHz, VBW = 10 Hz, Sweep: Auto.
4. “ * ”, means this data is the worst emission level.
5. Measurement Level = Reading Level + Correct Factor.
6. The average measurement was not performed when the peak measured data under the limit of average detection.
7. The Emission above 18GHz were not included is because their levels are too low.

Site : CB4-H	Time : 2017/02/17
Limit : FCC_Part22/24_00M_00M_PK	Margin : 6
Probe : CB4-H_CE_Sub_B432_1-18GHz_3M_1116 - HORIZONTAL	Power : DC 3.8V
EUT : LE910C1-NA	Note : Mode 7: DCS_EGPRS 1900_Link Mode_1880MHz

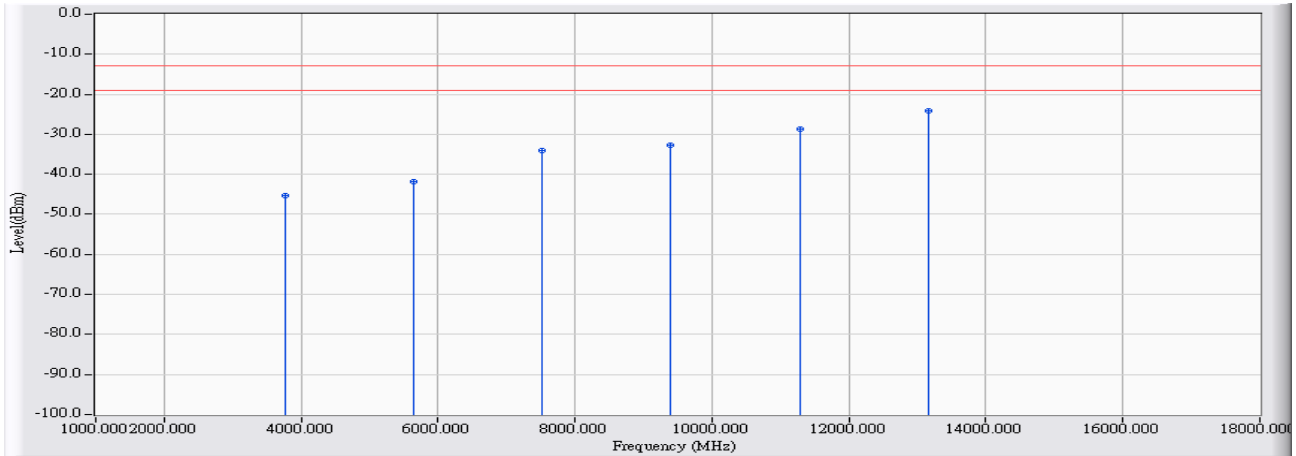

		Frequency (MHz)	Correct Factor (dB)	Reading Level (dBm)	Measure Level (dBm)	Margin (dB)	Limit (dBm)	Detector Type
1		3760.000	19.185	-64.620	-45.435	-32.435	-13.000	PEAK
2		5640.000	22.442	-64.270	-41.828	-28.828	-13.000	PEAK
3		7520.000	30.050	-64.010	-33.960	-20.960	-13.000	PEAK
4		9400.000	34.677	-67.330	-32.653	-19.653	-13.000	PEAK
5		11280.000	37.639	-66.390	-28.752	-15.752	-13.000	PEAK
6	*	13160.000	42.058	-66.070	-24.012	-11.012	-13.000	PEAK

Note:

1. All readings above 1GHz are performed with peak and/or average measurements as necessary.
2. Peak measurements: RBW = 1MHz, VBW = 1MHz, Sweep: Auto.
3. Average measurements: RBW = 1MHz, VBW = 10 Hz, Sweep: Auto.
4. “ * ”, means this data is the worst emission level.
5. Measurement Level = Reading Level + Correct Factor.
6. The average measurement was not performed when the peak measured data under the limit of average detection.
7. The Emission above 18GHz were not included is because their levels are too low.

Site : CB4-H	Time : 2017/02/17
Limit : FCC_Part22/24_00M_00M_PK	Margin : 6
Probe : CB4-H_CE_Sub_B432_1-18GHz_3M_1116 - VERTICAL	Power : DC 3.8V
EUT : LE910C1-NA	Note : Mode 7: DCS_EGPRS 1900_Link Mode_1880MHz

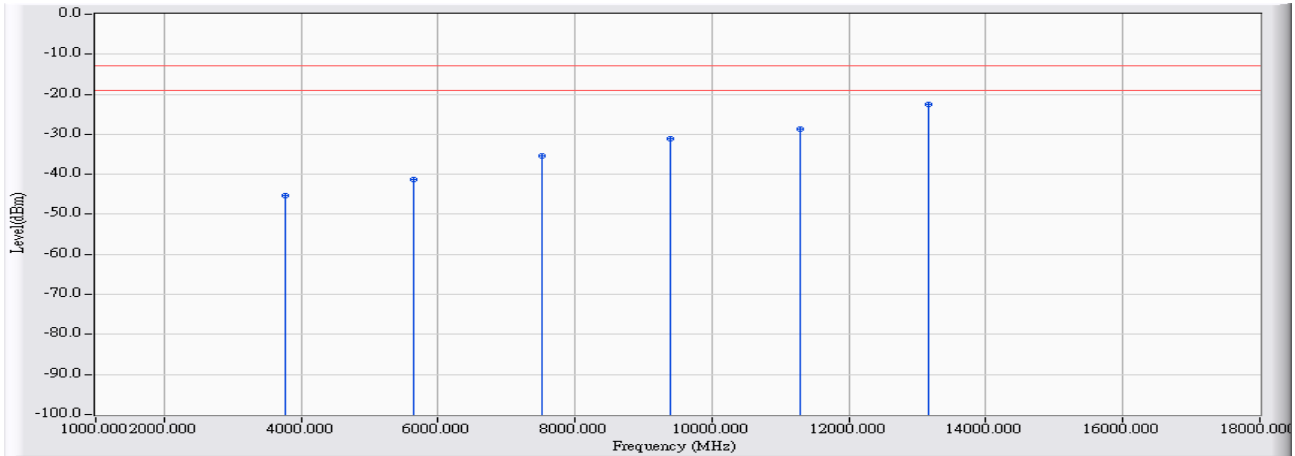

		Frequency (MHz)	Correct Factor (dB)	Reading Level (dBm)	Measure Level (dBm)	Margin (dB)	Limit (dBm)	Detector Type
1		3760.000	19.977	-65.170	-45.193	-32.193	-13.000	PEAK
2		5640.000	22.284	-63.510	-41.226	-28.226	-13.000	PEAK
3		7520.000	30.136	-65.570	-35.435	-22.435	-13.000	PEAK
4		9400.000	36.139	-67.290	-31.151	-18.151	-13.000	PEAK
5		11280.000	37.013	-65.830	-28.818	-15.818	-13.000	PEAK
6	*	13160.000	43.378	-65.850	-22.473	-9.473	-13.000	PEAK

Note:

1. All readings above 1GHz are performed with peak and/or average measurements as necessary.
2. Peak measurements: RBW = 1MHz, VBW = 1MHz, Sweep: Auto.
3. Average measurements: RBW = 1MHz, VBW = 10 Hz, Sweep: Auto.
4. “ * ”, means this data is the worst emission level.
5. Measurement Level = Reading Level + Correct Factor.
6. The average measurement was not performed when the peak measured data under the limit of average detection.
7. The Emission above 18GHz were not included is because their levels are too low.

Site : CB4-H	Time : 2017/02/17
Limit : FCC_Part22/24_00M_00M_PK	Margin : 6
Probe : CB4-H_CE_Sub_B432_1-18GHz_3M_1116 - HORIZONTAL	Power : DC 3.8V
EUT : LE910C1-NA	Note : Mode 7: DCS_EGPRS 1900_Link Mode_ 1909.8MHz

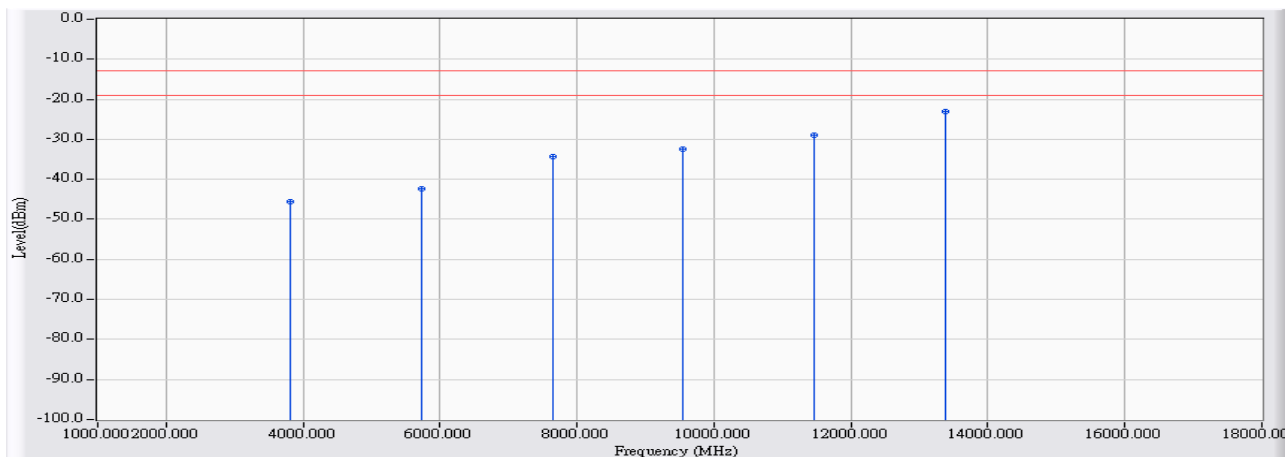

		Frequency (MHz)	Correct Factor (dB)	Reading Level (dBm)	Measure Level (dBm)	Margin (dB)	Limit (dBm)	Detector Type
1		3819.600	19.296	-64.860	-45.565	-32.565	-13.000	PEAK
2		5729.400	22.794	-65.030	-42.235	-29.235	-13.000	PEAK
3		7639.200	30.514	-64.880	-34.367	-21.367	-13.000	PEAK
4		9549.000	34.888	-67.370	-32.483	-19.483	-13.000	PEAK
5		11458.800	37.777	-66.810	-29.033	-16.033	-13.000	PEAK
6	*	13368.600	42.341	-65.530	-23.188	-10.188	-13.000	PEAK

Note:

1. All readings above 1GHz are performed with peak and/or average measurements as necessary.
2. Peak measurements: RBW = 1MHz, VBW = 1MHz, Sweep: Auto.
3. Average measurements: RBW = 1MHz, VBW = 10 Hz, Sweep: Auto.
4. “ * ”, means this data is the worst emission level.
5. Measurement Level = Reading Level + Correct Factor.
6. The average measurement was not performed when the peak measured data under the limit of average detection.
7. The Emission above 18GHz were not included is because their levels are too low.

Site : CB4-H	Time : 2017/02/17
Limit : FCC_Part22/24_00M_00M_PK	Margin : 6
Probe : CB4-H_CE_Sub_B432_1-18GHz_3M_1116 - VERTICAL	Power : DC 3.8V
EUT : LE910C1-NA	Note : Mode 7: DCS_EGPRS 1900_Link Mode_ 1909.8MHz

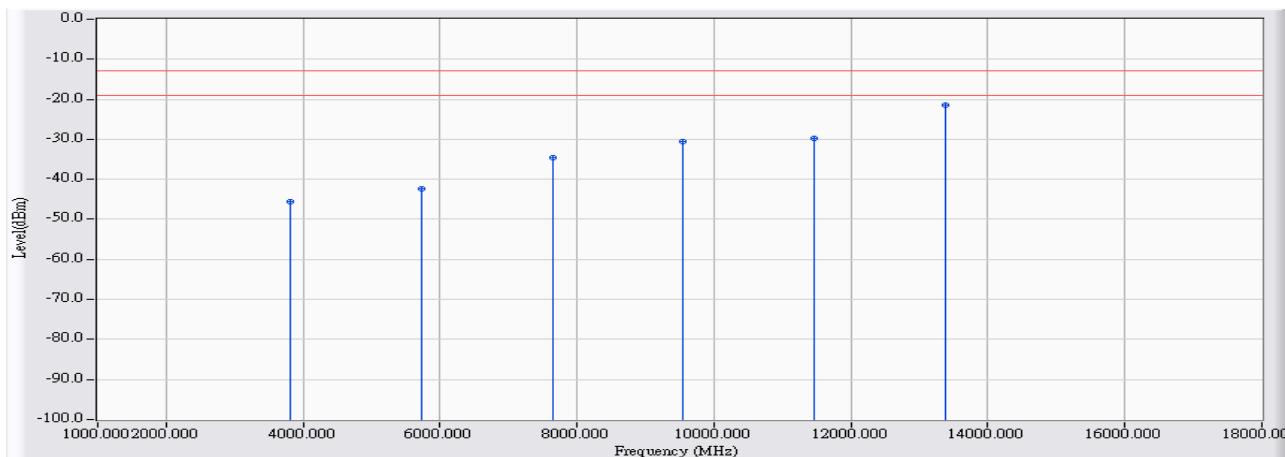

		Frequency (MHz)	Correct Factor (dB)	Reading Level (dBm)	Measure Level (dBm)	Margin (dB)	Limit (dBm)	Detector Type
1		3819.600	20.066	-65.560	-45.494	-32.494	-13.000	PEAK
2		5729.400	22.631	-65.100	-42.469	-29.469	-13.000	PEAK
3		7639.200	30.394	-64.910	-34.516	-21.516	-13.000	PEAK
4		9549.000	36.407	-67.070	-30.664	-17.664	-13.000	PEAK
5		11458.800	37.651	-67.500	-29.848	-16.848	-13.000	PEAK
6	*	13368.600	43.882	-65.440	-21.558	-8.558	-13.000	PEAK

Note:

1. All readings above 1GHz are performed with peak and/or average measurements as necessary.
2. Peak measurements: RBW = 1MHz, VBW = 1MHz, Sweep: Auto.
3. Average measurements: RBW = 1MHz, VBW = 10 Hz, Sweep: Auto.
4. “ * ”, means this data is the worst emission level.
5. Measurement Level = Reading Level + Correct Factor.
6. The average measurement was not performed when the peak measured data under the limit of average detection.
7. The Emission above 18GHz were not included is because their levels are too low.

Site : CB4-H	Time : 2017/02/17
Limit : FCC_Part22/24_00M_00M_PK	Margin : 6
Probe : CB4-H_CE_Sub_B432_1-18GHz_3M_1116 - HORIZONTAL	Power : DC 3.8V
EUT : LE910C1-NA	Note : Mode 8: DCS_EGPRS 1900_Idle Mode_1850.2MHz

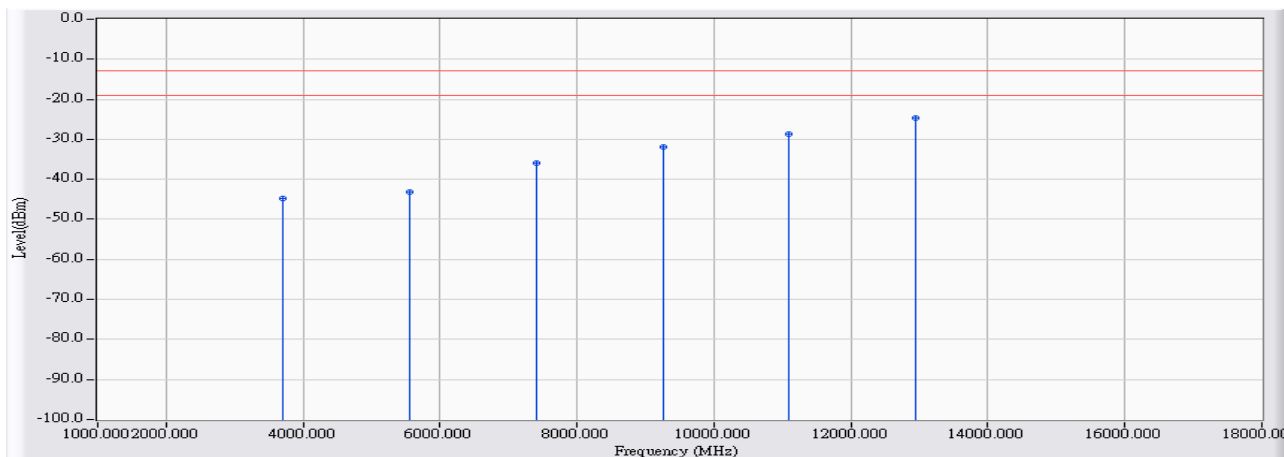

		Frequency (MHz)	Correct Factor (dB)	Reading Level (dBm)	Measure Level (dBm)	Margin (dB)	Limit (dBm)	Detector Type
1		3700.400	19.021	-63.750	-44.729	-31.729	-13.000	PEAK
2		5550.600	22.089	-65.290	-43.200	-30.200	-13.000	PEAK
3		7400.800	29.829	-65.700	-35.872	-22.872	-13.000	PEAK
4		9251.000	34.519	-66.350	-31.831	-18.831	-13.000	PEAK
5		11101.200	37.642	-66.460	-28.818	-15.818	-13.000	PEAK
6	*	12951.400	41.673	-66.210	-24.537	-11.537	-13.000	PEAK

Note:

1. All readings above 1GHz are performed with peak and/or average measurements as necessary.
2. Peak measurements: RBW = 1MHz, VBW = 1MHz, Sweep: Auto.
3. Average measurements: RBW = 1MHz, VBW = 10 Hz, Sweep: Auto.
4. “ * ”, means this data is the worst emission level.
5. Measurement Level = Reading Level + Correct Factor.
6. The average measurement was not performed when the peak measured data under the limit of average detection.
7. The Emission above 18GHz were not included is because their levels are too low.

Site : CB4-H	Time : 2017/02/17
Limit : FCC_Part22/24_00M_00M_PK	Margin : 6
Probe : CB4-H_CE_Sub_B432_1-18GHz_3M_1116 - VERTICAL	Power : DC 3.8V
EUT : LE910C1-NA	Note : Mode 8: DCS_EGPRS 1900_Idle Mode_1850.2MHz

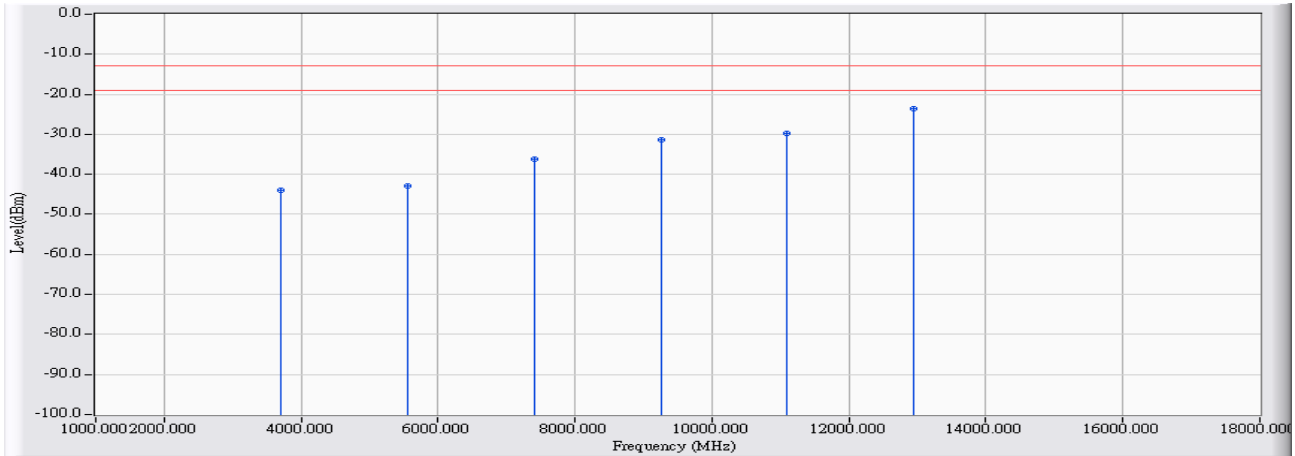

	Frequency (MHz)	Correct Factor (dB)	Reading Level (dBm)	Measure Level (dBm)	Margin (dB)	Limit (dBm)	Detector Type
1	3700.400	19.822	-63.800	-43.978	-30.978	-13.000	PEAK
2	5550.600	21.936	-64.850	-42.913	-29.913	-13.000	PEAK
3	7400.800	29.614	-65.760	-36.147	-23.147	-13.000	PEAK
4	9251.000	35.776	-67.070	-31.295	-18.295	-13.000	PEAK
5	11101.200	36.516	-66.210	-29.695	-16.695	-13.000	PEAK
6	* 12951.400	42.876	-66.460	-23.584	-10.584	-13.000	PEAK

Note:

1. All readings above 1GHz are performed with peak and/or average measurements as necessary.
2. Peak measurements: RBW = 1MHz, VBW = 1MHz, Sweep: Auto.
3. Average measurements: RBW = 1MHz, VBW = 10 Hz, Sweep: Auto.
4. “ * ”, means this data is the worst emission level.
5. Measurement Level = Reading Level + Correct Factor.
6. The average measurement was not performed when the peak measured data under the limit of average detection.
7. The Emission above 18GHz were not included is because their levels are too low.

Site : CB4-H	Time : 2017/02/17
Limit : FCC_Part22/24_00M_00M_PK	Margin : 6
Probe : CB4-H_CE_Sub_B432_1-18GHz_3M_1116 - HORIZONTAL	Power : DC 3.8V
EUT : LE910C1-NA	Note : Mode 8: DCS_EGPRS 1900_Idle Mode_1880MHz

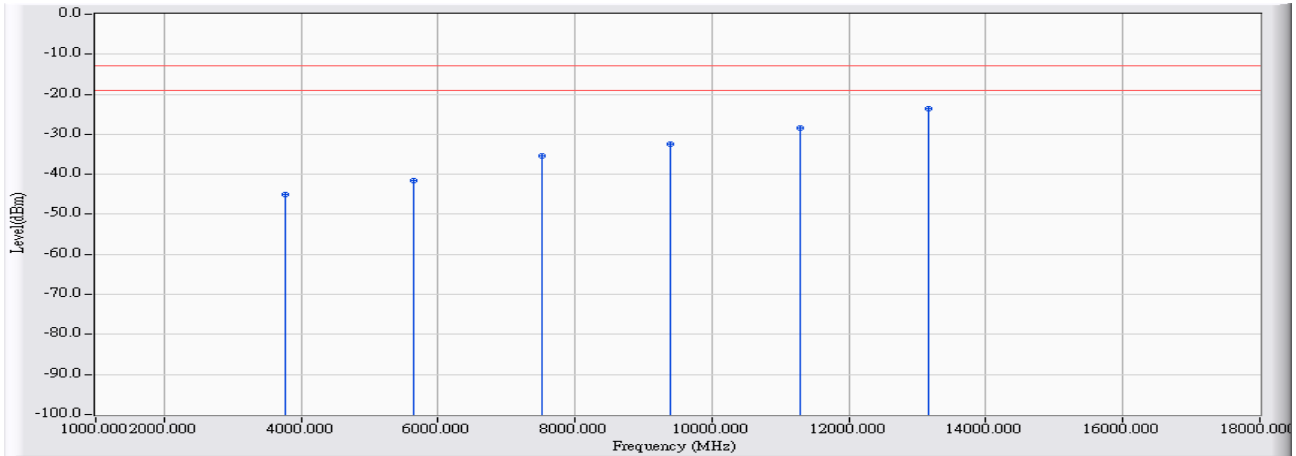

		Frequency (MHz)	Correct Factor (dB)	Reading Level (dBm)	Measure Level (dBm)	Margin (dB)	Limit (dBm)	Detector Type
1		3760.000	19.185	-64.190	-45.005	-32.005	-13.000	PEAK
2		5640.000	22.442	-63.950	-41.508	-28.508	-13.000	PEAK
3		7520.000	30.050	-65.430	-35.380	-22.380	-13.000	PEAK
4		9400.000	34.677	-67.220	-32.543	-19.543	-13.000	PEAK
5		11280.000	37.639	-66.140	-28.502	-15.502	-13.000	PEAK
6	*	13160.000	42.058	-65.570	-23.512	-10.512	-13.000	PEAK

Note:

1. All readings above 1GHz are performed with peak and/or average measurements as necessary.
2. Peak measurements: RBW = 1MHz, VBW = 1MHz, Sweep: Auto.
3. Average measurements: RBW = 1MHz, VBW = 10 Hz, Sweep: Auto.
4. “ * ”, means this data is the worst emission level.
5. Measurement Level = Reading Level + Correct Factor.
6. The average measurement was not performed when the peak measured data under the limit of average detection.
7. The Emission above 18GHz were not included is because their levels are too low.

Site : CB4-H	Time : 2017/02/17
Limit : FCC_Part22/24_00M_00M_PK	Margin : 6
Probe : CB4-H_CE_Sub_B432_1-18GHz_3M_1116 - VERTICAL	Power : DC 3.8V
EUT : LE910C1-NA	Note : Mode 8: DCS_EGPRS 1900_Idle Mode_1880MHz

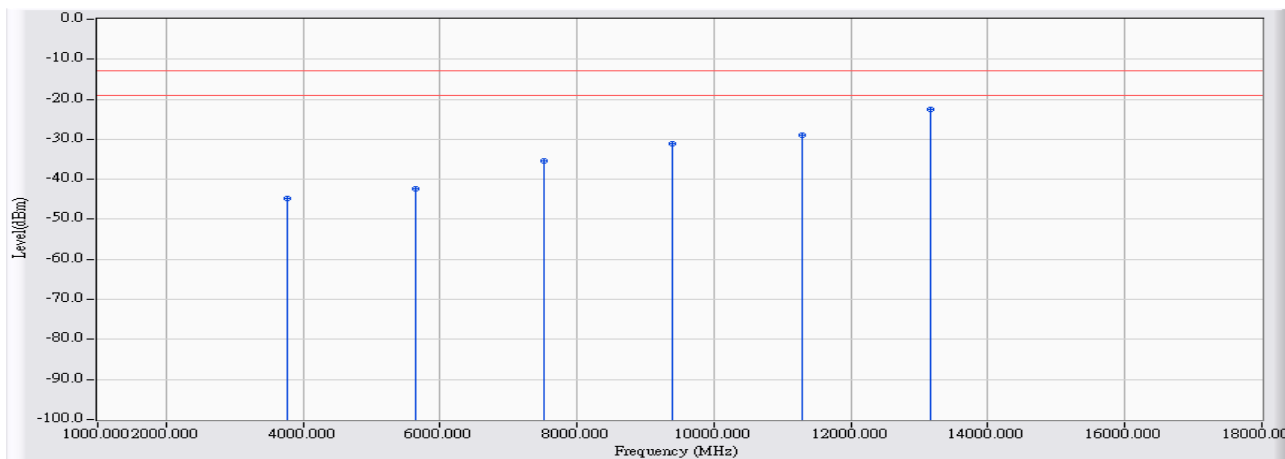

	Frequency (MHz)	Correct Factor (dB)	Reading Level (dBm)	Measure Level (dBm)	Margin (dB)	Limit (dBm)	Detector Type
1	3760.000	19.977	-64.700	-44.723	-31.723	-13.000	PEAK
2	5640.000	22.284	-64.610	-42.326	-29.326	-13.000	PEAK
3	7520.000	30.136	-65.450	-35.315	-22.315	-13.000	PEAK
4	9400.000	36.139	-67.190	-31.051	-18.051	-13.000	PEAK
5	11280.000	37.013	-65.880	-28.868	-15.868	-13.000	PEAK
6	* 13160.000	43.378	-65.770	-22.393	-9.393	-13.000	PEAK

Note:

1. All readings above 1GHz are performed with peak and/or average measurements as necessary.
2. Peak measurements: RBW = 1MHz, VBW = 1MHz, Sweep: Auto.
3. Average measurements: RBW = 1MHz, VBW = 10 Hz, Sweep: Auto.
4. “ * ”, means this data is the worst emission level.
5. Measurement Level = Reading Level + Correct Factor.
6. The average measurement was not performed when the peak measured data under the limit of average detection.
7. The Emission above 18GHz were not included is because their levels are too low.

Site : CB4-H	Time : 2017/02/17
Limit : FCC_Part22/24_00M_00M_PK	Margin : 6
Probe : CB4-H_CE_Sub_B432_1-18GHz_3M_1116 - HORIZONTAL	Power : DC 3.8V
EUT : LE910C1-NA	Note : Mode 8: DCS_EGPRS 1900_Idle Mode_1909.8MHz

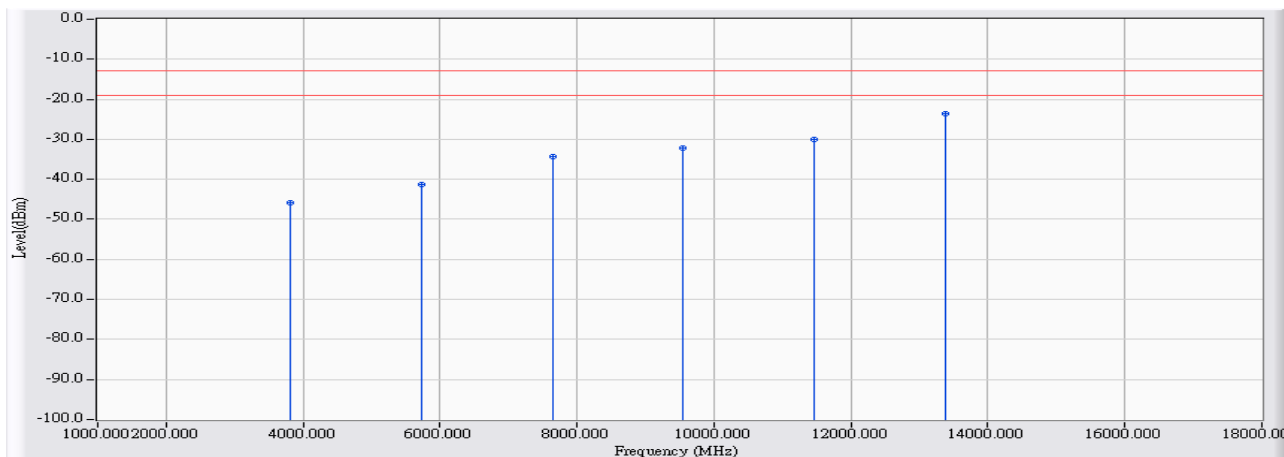

	Frequency (MHz)	Correct Factor (dB)	Reading Level (dBm)	Measure Level (dBm)	Margin (dB)	Limit (dBm)	Detector Type
1	3819.600	19.296	-65.010	-45.715	-32.715	-13.000	PEAK
2	5729.400	22.794	-64.090	-41.295	-28.295	-13.000	PEAK
3	7639.200	30.514	-64.940	-34.427	-21.427	-13.000	PEAK
4	9549.000	34.888	-67.060	-32.173	-19.173	-13.000	PEAK
5	11458.800	37.777	-67.670	-29.893	-16.893	-13.000	PEAK
6	* 13368.600	42.341	-65.990	-23.648	-10.648	-13.000	PEAK

Note:

1. All readings above 1GHz are performed with peak and/or average measurements as necessary.
2. Peak measurements: RBW = 1MHz, VBW = 1MHz, Sweep: Auto.
3. Average measurements: RBW = 1MHz, VBW = 10 Hz, Sweep: Auto.
4. “ * ”, means this data is the worst emission level.
5. Measurement Level = Reading Level + Correct Factor.
6. The average measurement was not performed when the peak measured data under the limit of average detection.
7. The Emission above 18GHz were not included is because their levels are too low.

Site : CB4-H	Time : 2017/02/17
Limit : FCC_Part22/24_00M_00M_PK	Margin : 6
Probe : CB4-H_CE_Sub_B432_1-18GHz_3M_1116 - VERTICAL	Power : DC 3.8V
EUT : LE910C1-NA	Note : Mode 8: DCS_EGPRS 1900_Idle Mode_1909.8MHz

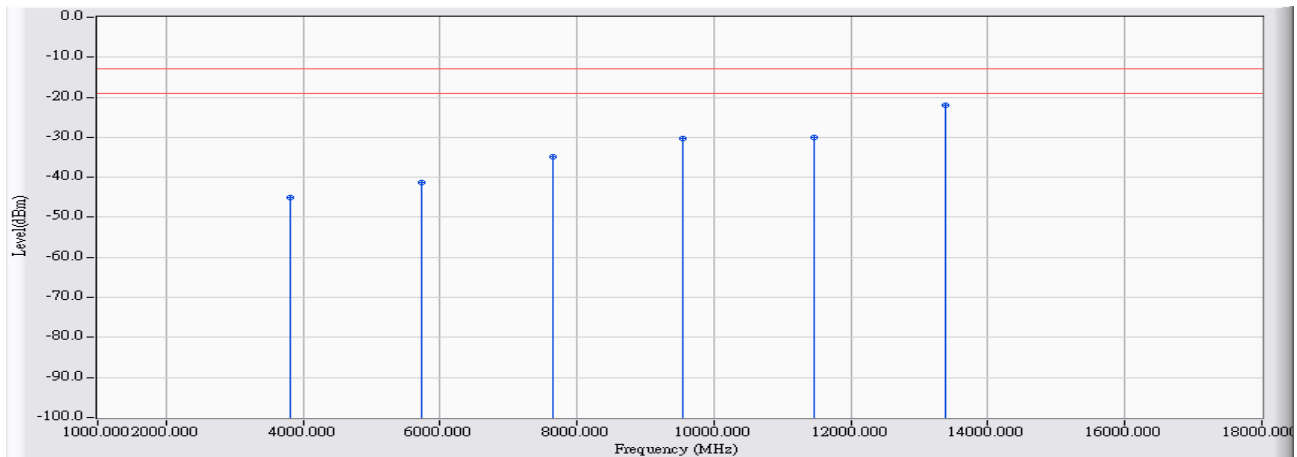

		Frequency (MHz)	Correct Factor (dB)	Reading Level (dBm)	Measure Level (dBm)	Margin (dB)	Limit (dBm)	Detector Type
1		3819.600	20.066	-65.170	-45.104	-32.104	-13.000	PEAK
2		5729.400	22.631	-63.860	-41.229	-28.229	-13.000	PEAK
3		7639.200	30.394	-65.300	-34.906	-21.906	-13.000	PEAK
4		9549.000	36.407	-66.720	-30.314	-17.314	-13.000	PEAK
5		11458.800	37.651	-67.710	-30.058	-17.058	-13.000	PEAK
6	*	13368.600	43.882	-65.970	-22.088	-9.088	-13.000	PEAK

Note:

1. All readings above 1GHz are performed with peak and/or average measurements as necessary.
2. Peak measurements: RBW = 1MHz, VBW = 1MHz, Sweep: Auto.
3. Average measurements: RBW = 1MHz, VBW = 10 Hz, Sweep: Auto.
4. “ * ”, means this data is the worst emission level.
5. Measurement Level = Reading Level + Correct Factor.
6. The average measurement was not performed when the peak measured data under the limit of average detection.
7. The Emission above 18GHz were not included is because their levels are too low.

Site : CB4-H	Time : 2017/02/20
Limit : Part_22/24_00M_PK	Margin : 6
Probe : CB4-H_CE_Sub_B091_1-18GHz_3M_0117 - HORIZONTAL	Power : DC 3.8V
EUT : LE910C1-NA	Note : Mode 9: WCDMA Band 5_Link Mode_826.4MHz

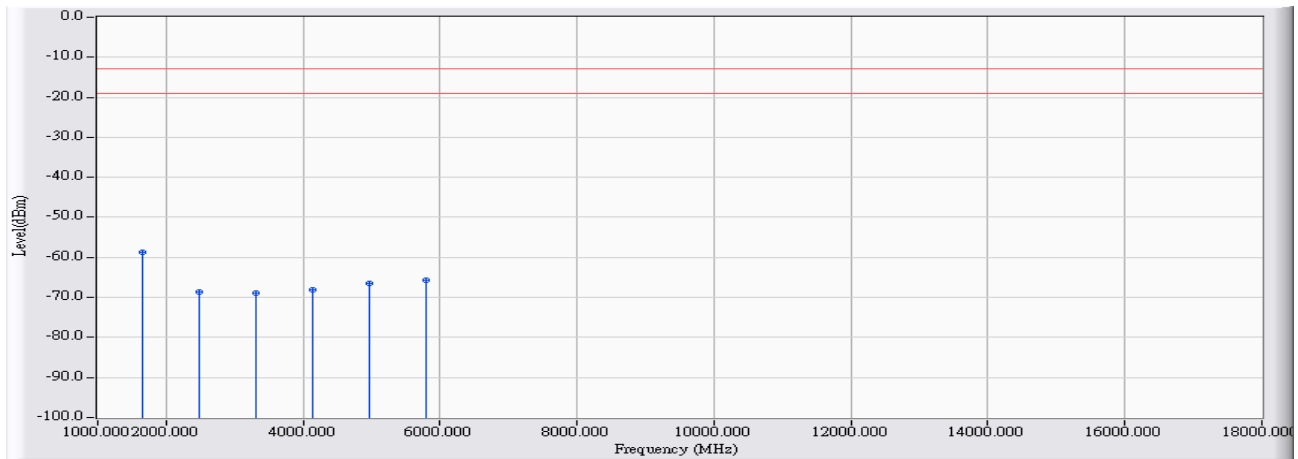

		Frequency (MHz)	Correct Factor (dB)	Reading Level (dBm)	Measure Level (dBm)	Margin (dB)	Limit (dBm)	Detector Type
1	*	1652.800	0.425	-59.110	-58.686	-45.686	-13.000	PEAK
2		2479.200	4.701	-73.250	-68.549	-55.549	-13.000	PEAK
3		3305.600	5.599	-74.610	-69.011	-56.011	-13.000	PEAK
4		4132.000	7.238	-75.460	-68.221	-55.221	-13.000	PEAK
5		4958.400	10.442	-77.050	-66.608	-53.608	-13.000	PEAK
6		5784.800	12.576	-78.230	-65.654	-52.654	-13.000	PEAK

Note:

1. All readings above 1GHz are performed with peak and/or average measurements as necessary.
2. Peak measurements: RBW = 1MHz, VBW = 1MHz, Sweep: Auto.
3. Average measurements: RBW = 1MHz, VBW = 10 Hz, Sweep: Auto.
4. “ * ”, means this data is the worst emission level.
5. Measurement Level = Reading Level + Correct Factor.
6. The average measurement was not performed when the peak measured data under the limit of average detection.
7. The Emission above 18GHz were not included is because their levels are too low.

Site : CB4-H	Time : 2017/02/20
Limit : Part_22/24_00M_PK	Margin : 6
Probe : CB4-H_CE_Sub_B091_1-18GHz_3M_0117 - VERTICAL	Power : DC 3.8V
EUT : LE910C1-NA	Note : Mode 9: WCDMA Band 5_Link Mode_826.4MHz

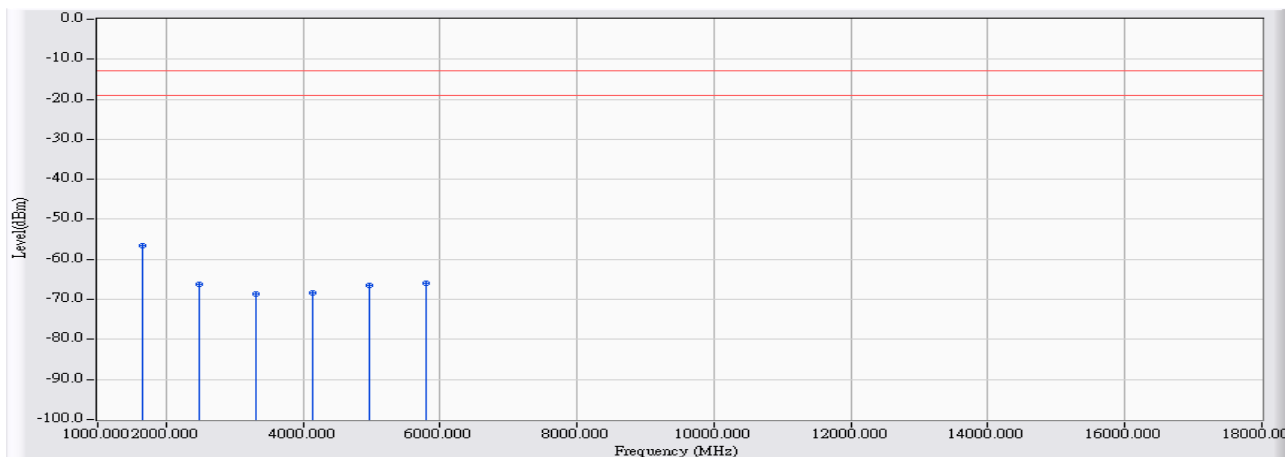

		Frequency (MHz)	Correct Factor (dB)	Reading Level (dBm)	Measure Level (dBm)	Margin (dB)	Limit (dBm)	Detector Type
1	*	1652.800	-0.758	-55.940	-56.698	-43.698	-13.000	PEAK
2		2479.200	3.909	-70.220	-66.310	-53.310	-13.000	PEAK
3		3305.600	5.319	-73.880	-68.561	-55.561	-13.000	PEAK
4		4132.000	7.412	-75.840	-68.428	-55.428	-13.000	PEAK
5		4958.400	10.913	-77.530	-66.617	-53.617	-13.000	PEAK
6		5784.800	12.559	-78.490	-65.931	-52.931	-13.000	PEAK

Note:

1. All readings above 1GHz are performed with peak and/or average measurements as necessary.
2. Peak measurements: RBW = 1MHz, VBW = 1MHz, Sweep: Auto.
3. Average measurements: RBW = 1MHz, VBW = 10 Hz, Sweep: Auto.
4. “ * ”, means this data is the worst emission level.
5. Measurement Level = Reading Level + Correct Factor.
6. The average measurement was not performed when the peak measured data under the limit of average detection.
7. The Emission above 18GHz were not included is because their levels are too low.

Site : CB4-H	Time : 2017/02/20
Limit : Part_22/24_00M_PK	Margin : 6
Probe : CB4-H_CE_Sub_B091_1-18GHz_3M_0117 - HORIZONTAL	Power : DC 3.8V
EUT : LE910C1-NA	Note : Mode 9: WCDMA Band 5_Link Mode_836.6MHz

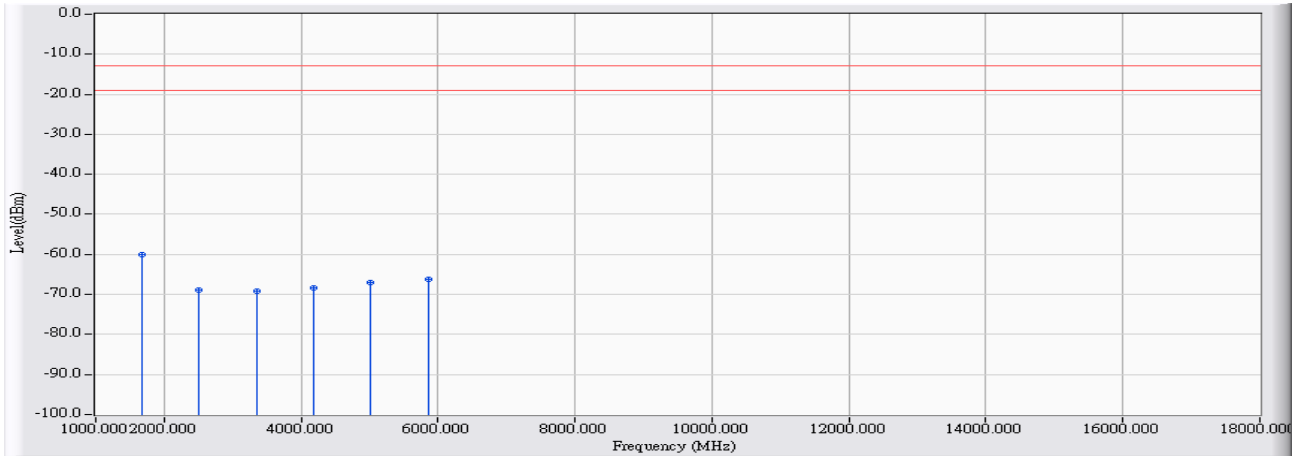

		Frequency (MHz)	Correct Factor (dB)	Reading Level (dBm)	Measure Level (dBm)	Margin (dB)	Limit (dBm)	Detector Type
1	*	1673.200	0.278	-60.290	-60.012	-47.012	-13.000	PEAK
2		2509.800	4.613	-73.570	-68.957	-55.957	-13.000	PEAK
3		3346.400	5.664	-74.760	-69.095	-56.095	-13.000	PEAK
4		4183.000	7.499	-75.810	-68.311	-55.311	-13.000	PEAK
5		5019.600	10.513	-77.540	-67.026	-54.026	-13.000	PEAK
6		5856.200	12.638	-78.850	-66.212	-53.212	-13.000	PEAK

Note:

1. All readings above 1GHz are performed with peak and/or average measurements as necessary.
2. Peak measurements: RBW = 1MHz, VBW = 1MHz, Sweep: Auto.
3. Average measurements: RBW = 1MHz, VBW = 10 Hz, Sweep: Auto.
4. “ * ”, means this data is the worst emission level.
5. Measurement Level = Reading Level + Correct Factor.
6. The average measurement was not performed when the peak measured data under the limit of average detection.
7. The Emission above 18GHz were not included is because their levels are too low.

Site : CB4-H	Time : 2017/02/20
Limit : Part_22/24_00M_PK	Margin : 6
Probe : CB4-H_CE_Sub_B091_1-18GHz_3M_0117 - VERTICAL	Power : DC 3.8V
EUT : LE910C1-NA	Note : Mode 9: WCDMA Band 5_Link Mode_836.6MHz

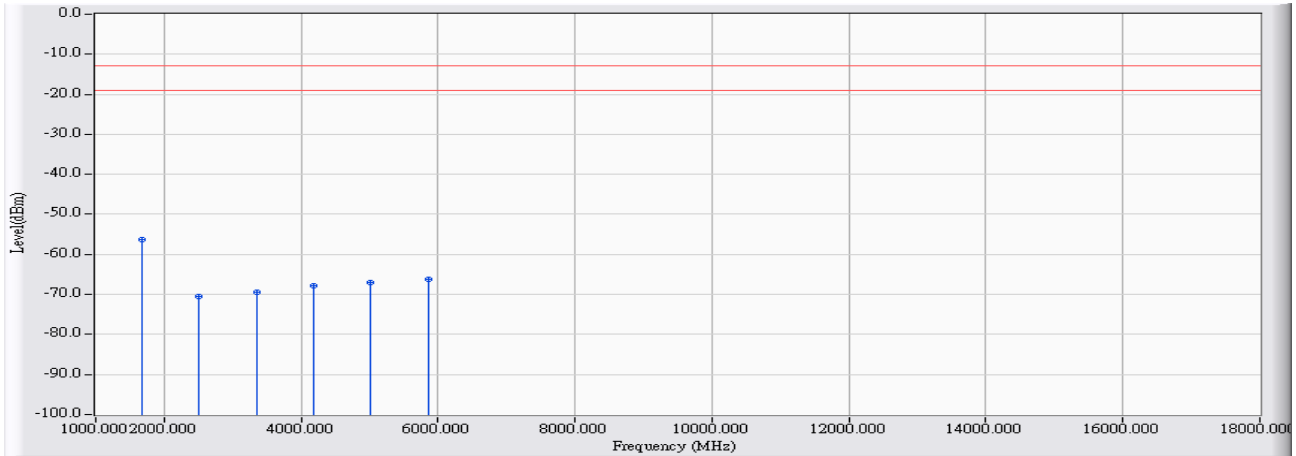

		Frequency (MHz)	Correct Factor (dB)	Reading Level (dBm)	Measure Level (dBm)	Margin (dB)	Limit (dBm)	Detector Type
1	*	1673.200	-0.850	-55.400	-56.250	-43.250	-13.000	PEAK
2		2509.800	3.885	-74.390	-70.505	-57.505	-13.000	PEAK
3		3346.400	5.381	-74.730	-69.348	-56.348	-13.000	PEAK
4		4183.000	7.671	-75.570	-67.899	-54.899	-13.000	PEAK
5		5019.600	10.979	-77.980	-67.001	-54.001	-13.000	PEAK
6		5856.200	12.690	-78.920	-66.230	-53.230	-13.000	PEAK

Note:

1. All readings above 1GHz are performed with peak and/or average measurements as necessary.
2. Peak measurements: RBW = 1MHz, VBW = 1MHz, Sweep: Auto.
3. Average measurements: RBW = 1MHz, VBW = 10 Hz, Sweep: Auto.
4. “ * ”, means this data is the worst emission level.
5. Measurement Level = Reading Level + Correct Factor.
6. The average measurement was not performed when the peak measured data under the limit of average detection.
7. The Emission above 18GHz were not included is because their levels are too low.

Site : CB4-H	Time : 2017/02/20
Limit : Part_22/24_00M_PK	Margin : 6
Probe : CB4-H_CE_Sub_B091_1-18GHz_3M_0117 - HORIZONTAL	Power : DC 3.8V
EUT : LE910C1-NA	Note : Mode 9: WCDMA Band 5_Link Mode_846.6MHz

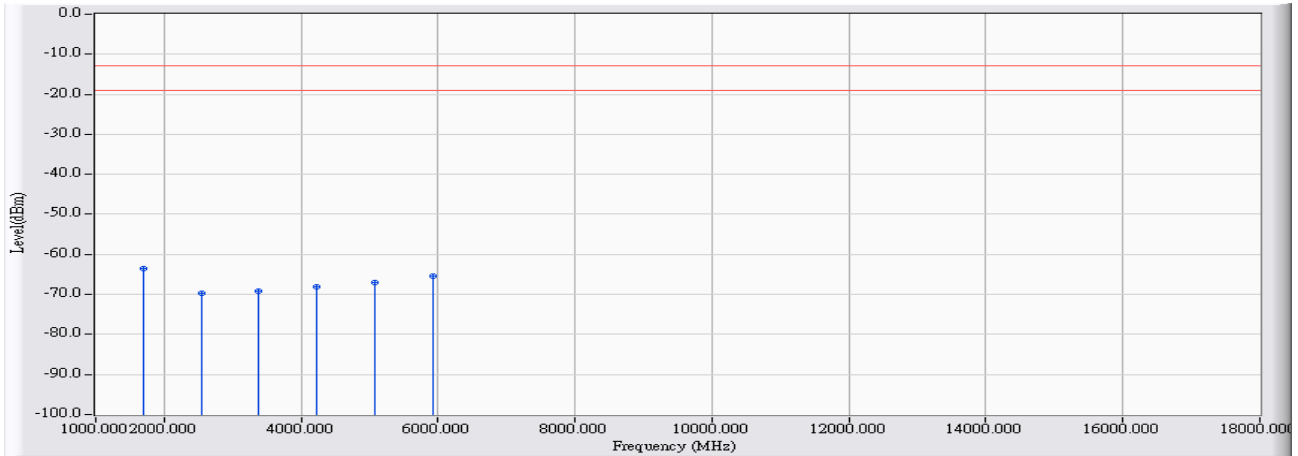

		Frequency (MHz)	Correct Factor (dB)	Reading Level (dBm)	Measure Level (dBm)	Margin (dB)	Limit (dBm)	Detector Type
1	*	1693.200	0.135	-63.770	-63.635	-50.635	-13.000	PEAK
2		2539.800	4.677	-74.430	-69.752	-56.752	-13.000	PEAK
3		3386.400	5.729	-74.860	-69.130	-56.130	-13.000	PEAK
4		4233.000	7.758	-75.910	-68.153	-55.153	-13.000	PEAK
5		5079.600	10.669	-77.650	-66.981	-53.981	-13.000	PEAK
6		5926.200	12.703	-78.180	-65.477	-52.477	-13.000	PEAK

Note:

1. All readings above 1GHz are performed with peak and/or average measurements as necessary.
2. Peak measurements: RBW = 1MHz, VBW = 1MHz, Sweep: Auto.
3. Average measurements: RBW = 1MHz, VBW = 10 Hz, Sweep: Auto.
4. “ * ”, means this data is the worst emission level.
5. Measurement Level = Reading Level + Correct Factor.
6. The average measurement was not performed when the peak measured data under the limit of average detection.
7. The Emission above 18GHz were not included is because their levels are too low.

Site : CB4-H	Time : 2017/02/20
Limit : Part_22/24_00M_PK	Margin : 6
Probe : CB4-H_CE_Sub_B091_1-18GHz_3M_0117 - VERTICAL	Power : DC 3.8V
EUT : LE910C1-NA	Note : Mode 9: WCDMA Band 5_Link Mode_846.6MHz

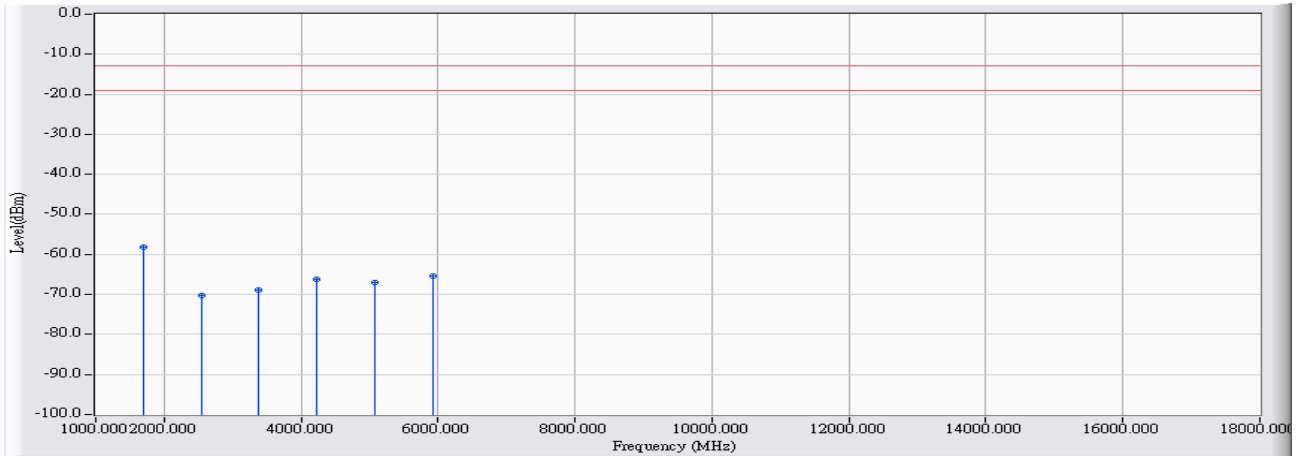

		Frequency (MHz)	Correct Factor (dB)	Reading Level (dBm)	Measure Level (dBm)	Margin (dB)	Limit (dBm)	Detector Type
1	*	1693.200	-0.940	-57.340	-58.281	-45.281	-13.000	PEAK
2		2539.800	4.008	-74.240	-70.231	-57.231	-13.000	PEAK
3		3386.400	5.443	-74.440	-68.996	-55.996	-13.000	PEAK
4		4233.000	7.928	-74.040	-66.113	-53.113	-13.000	PEAK
5		5079.600	11.048	-78.010	-66.962	-53.962	-13.000	PEAK
6		5926.200	12.823	-78.280	-65.458	-52.458	-13.000	PEAK

Note:

1. All readings above 1GHz are performed with peak and/or average measurements as necessary.
2. Peak measurements: RBW = 1MHz, VBW = 1MHz, Sweep: Auto.
3. Average measurements: RBW = 1MHz, VBW = 10 Hz, Sweep: Auto.
4. “ * ”, means this data is the worst emission level.
5. Measurement Level = Reading Level + Correct Factor.
6. The average measurement was not performed when the peak measured data under the limit of average detection.
7. The Emission above 18GHz were not included is because their levels are too low.

Site : CB4-H	Time : 2017/02/20
Limit : Part_22/24_00M_PK	Margin : 6
Probe : CB4-H_CE_Sub_B091_1-18GHz_3M_0117 - HORIZONTAL	Power : DC 3.8V
EUT : LE910C1-NA	Note : Mode 10: WCDMA Band 5_Idle Mode_826.4MHz

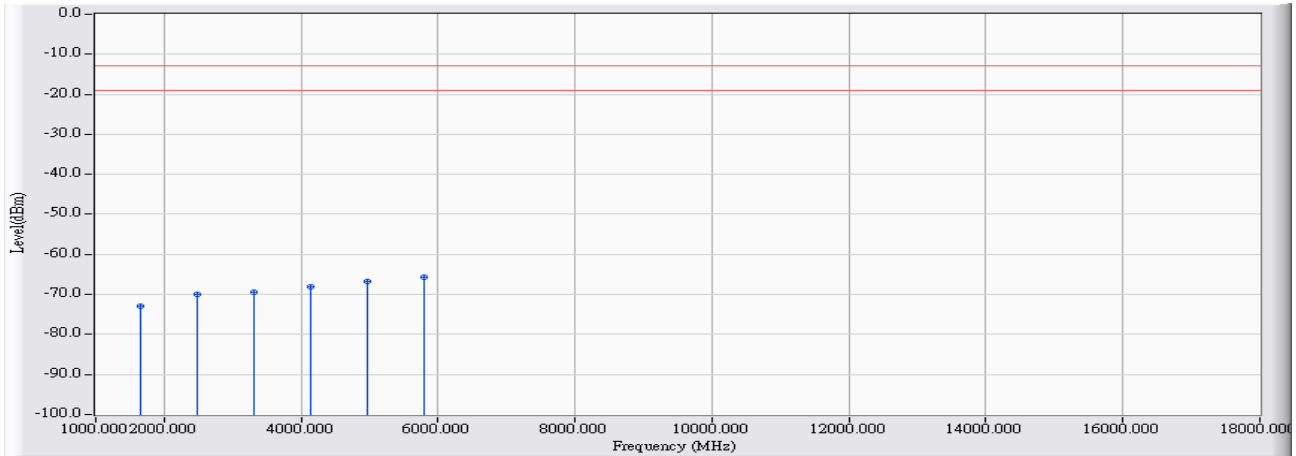

		Frequency (MHz)	Correct Factor (dB)	Reading Level (dBm)	Measure Level (dBm)	Margin (dB)	Limit (dBm)	Detector Type
1		1652.800	0.425	-73.300	-72.876	-59.876	-13.000	PEAK
2		2479.200	4.701	-74.610	-69.909	-56.909	-13.000	PEAK
3		3305.600	5.599	-75.030	-69.431	-56.431	-13.000	PEAK
4		4132.000	7.238	-75.400	-68.161	-55.161	-13.000	PEAK
5		4958.400	10.442	-77.150	-66.708	-53.708	-13.000	PEAK
6	*	5784.800	12.576	-78.330	-65.754	-52.754	-13.000	PEAK

Note:

1. All readings above 1GHz are performed with peak and/or average measurements as necessary.
2. Peak measurements: RBW = 1MHz, VBW = 1MHz, Sweep: Auto.
3. Average measurements: RBW = 1MHz, VBW = 10 Hz, Sweep: Auto.
4. “ * ”, means this data is the worst emission level.
5. Measurement Level = Reading Level + Correct Factor.
6. The average measurement was not performed when the peak measured data under the limit of average detection.
7. The Emission above 18GHz were not included is because their levels are too low.

Site : CB4-H	Time : 2017/02/20
Limit : Part_22/24_00M_PK	Margin : 6
Probe : CB4-H_CE_Sub_B091_1-18GHz_3M_0117 - VERTICAL	Power : DC 3.8V
EUT : LE910C1-NA	Note : Mode 10: WCDMA Band 5_Idle Mode_826.4MHz

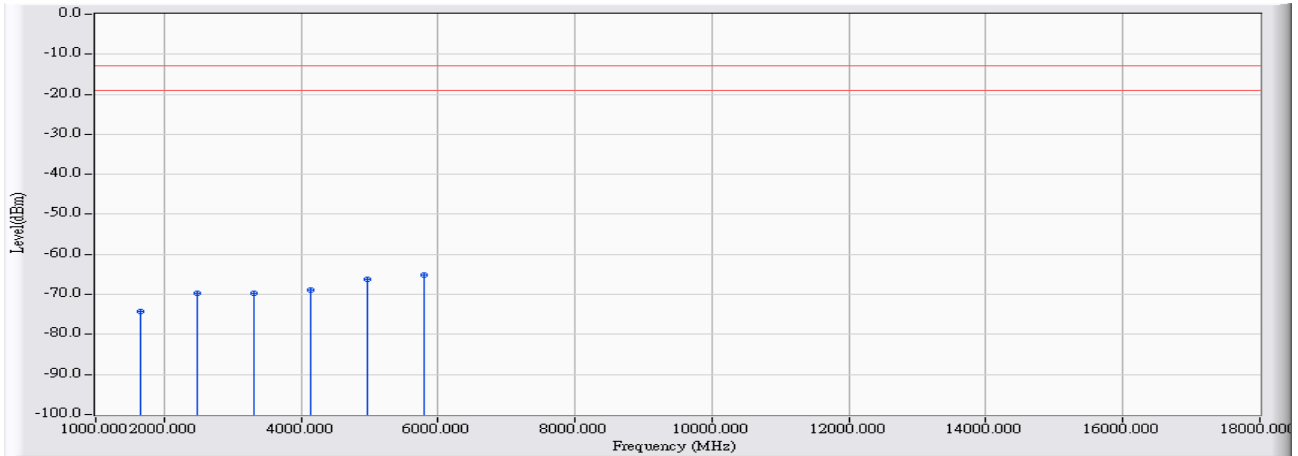

		Frequency (MHz)	Correct Factor (dB)	Reading Level (dBm)	Measure Level (dBm)	Margin (dB)	Limit (dBm)	Detector Type
1		1652.800	-0.758	-73.440	-74.198	-61.198	-13.000	PEAK
2		2479.200	3.909	-73.500	-69.590	-56.590	-13.000	PEAK
3		3305.600	5.319	-74.900	-69.581	-56.581	-13.000	PEAK
4		4132.000	7.412	-76.270	-68.858	-55.858	-13.000	PEAK
5		4958.400	10.913	-77.220	-66.307	-53.307	-13.000	PEAK
6	*	5784.800	12.559	-77.750	-65.191	-52.191	-13.000	PEAK

Note:

1. All readings above 1GHz are performed with peak and/or average measurements as necessary.
2. Peak measurements: RBW = 1MHz, VBW = 1MHz, Sweep: Auto.
3. Average measurements: RBW = 1MHz, VBW = 10 Hz, Sweep: Auto.
4. “ * ”, means this data is the worst emission level.
5. Measurement Level = Reading Level + Correct Factor.
6. The average measurement was not performed when the peak measured data under the limit of average detection.
7. The Emission above 18GHz were not included is because their levels are too low.

Site : CB4-H	Time : 2017/02/20
Limit : Part_22/24_00M_PK	Margin : 6
Probe : CB4-H_CE_Sub_B091_1-18GHz_3M_0117 - HORIZONTAL	Power : DC 3.8V
EUT : LE910C1-NA	Note : Mode 10: WCDMA Band 5_Idle Mode_836.6MHz

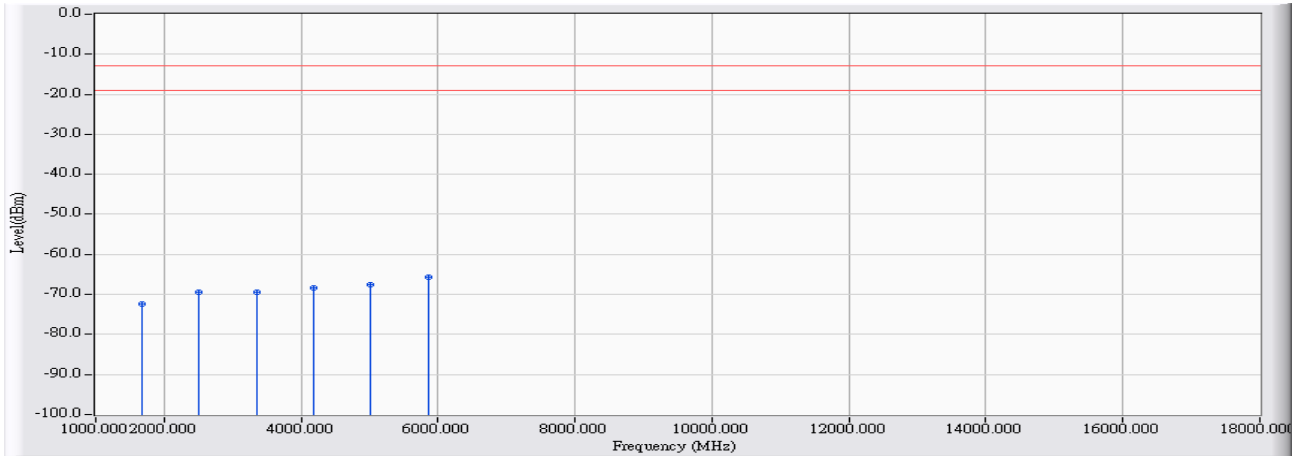

		Frequency (MHz)	Correct Factor (dB)	Reading Level (dBm)	Measure Level (dBm)	Margin (dB)	Limit (dBm)	Detector Type
1		1673.200	0.278	-72.770	-72.492	-59.492	-13.000	PEAK
2		2509.800	4.613	-73.940	-69.327	-56.327	-13.000	PEAK
3		3346.800	5.665	-75.100	-69.434	-56.434	-13.000	PEAK
4		4183.000	7.499	-75.760	-68.261	-55.261	-13.000	PEAK
5		5019.600	10.513	-77.990	-67.476	-54.476	-13.000	PEAK
6	*	5856.200	12.638	-78.200	-65.562	-52.562	-13.000	PEAK

Note:

1. All readings above 1GHz are performed with peak and/or average measurements as necessary.
2. Peak measurements: RBW = 1MHz, VBW = 1MHz, Sweep: Auto.
3. Average measurements: RBW = 1MHz, VBW = 10 Hz, Sweep: Auto.
4. “ * ”, means this data is the worst emission level.
5. Measurement Level = Reading Level + Correct Factor.
6. The average measurement was not performed when the peak measured data under the limit of average detection.
7. The Emission above 18GHz were not included is because their levels are too low.

Site : CB4-H	Time : 2017/02/20
Limit : Part_22/24_00M_PK	Margin : 6
Probe : CB4-H_CE_Sub_B091_1-18GHz_3M_0117 - VERTICAL	Power : DC 3.8V
EUT : LE910C1-NA	Note : Mode 10: WCDMA Band 5_Idle Mode_836.6MHz

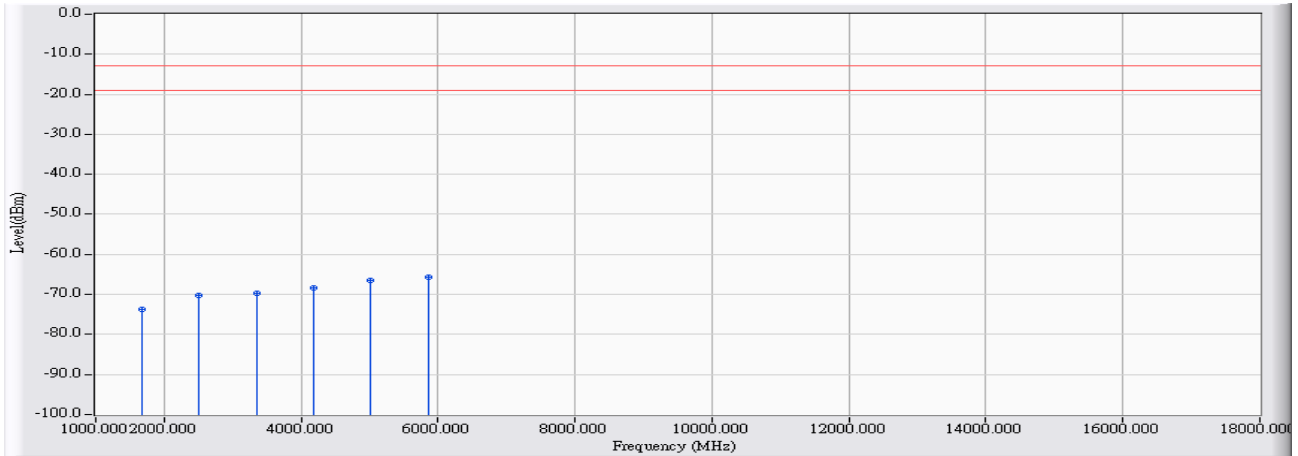

	Frequency (MHz)	Correct Factor (dB)	Reading Level (dBm)	Measure Level (dBm)	Margin (dB)	Limit (dBm)	Detector Type
1	1673.200	-0.850	-72.940	-73.790	-60.790	-13.000	PEAK
2	2509.800	3.885	-74.060	-70.175	-57.175	-13.000	PEAK
3	3346.400	5.381	-75.150	-69.768	-56.768	-13.000	PEAK
4	4183.000	7.671	-75.980	-68.309	-55.309	-13.000	PEAK
5	5019.600	10.979	-77.540	-66.561	-53.561	-13.000	PEAK
6	* 5856.200	12.690	-78.280	-65.590	-52.590	-13.000	PEAK

Note:

1. All readings above 1GHz are performed with peak and/or average measurements as necessary.
2. Peak measurements: RBW = 1MHz, VBW = 1MHz, Sweep: Auto.
3. Average measurements: RBW = 1MHz, VBW = 10 Hz, Sweep: Auto.
4. “ * ”, means this data is the worst emission level.
5. Measurement Level = Reading Level + Correct Factor.
6. The average measurement was not performed when the peak measured data under the limit of average detection.
7. The Emission above 18GHz were not included is because their levels are too low.

Site : CB4-H	Time : 2017/02/20
Limit : Part_22/24_00M_PK	Margin : 6
Probe : CB4-H_CE_Sub_B091_1-18GHz_3M_0117 - HORIZONTAL	Power : DC 3.8V
EUT : LE910C1-NA	Note : Mode 10: WCDMA Band 5_Idle Mode_846.6MHz

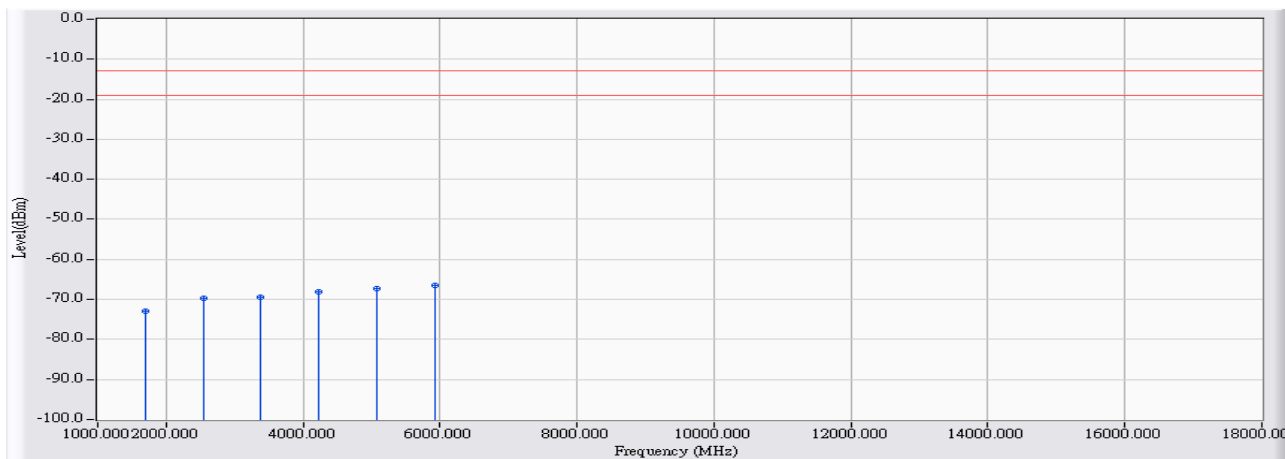

	Frequency (MHz)	Correct Factor (dB)	Reading Level (dBm)	Measure Level (dBm)	Margin (dB)	Limit (dBm)	Detector Type
1	1693.200	0.135	-73.100	-72.965	-59.965	-13.000	PEAK
2	2539.800	4.677	-74.470	-69.792	-56.792	-13.000	PEAK
3	3386.400	5.729	-75.170	-69.440	-56.440	-13.000	PEAK
4	4233.000	7.758	-75.890	-68.133	-55.133	-13.000	PEAK
5	5079.600	10.669	-77.900	-67.231	-54.231	-13.000	PEAK
6	* 5926.200	12.703	-79.180	-66.477	-53.477	-13.000	PEAK

Note:

1. All readings above 1GHz are performed with peak and/or average measurements as necessary.
2. Peak measurements: RBW = 1MHz, VBW = 1MHz, Sweep: Auto.
3. Average measurements: RBW = 1MHz, VBW = 10 Hz, Sweep: Auto.
4. “ * ”, means this data is the worst emission level.
5. Measurement Level = Reading Level + Correct Factor.
6. The average measurement was not performed when the peak measured data under the limit of average detection.
7. The Emission above 18GHz were not included is because their levels are too low.

Site : CB4-H	Time : 2017/02/20
Limit : Part_22/24_00M_PK	Margin : 6
Probe : CB4-H_CE_Sub_B091_1-18GHz_3M_0117 - VERTICAL	Power : DC 3.8V
EUT : LE910C1-NA	Note : Mode 10: WCDMA Band 5_Idle Mode_846.6MHz

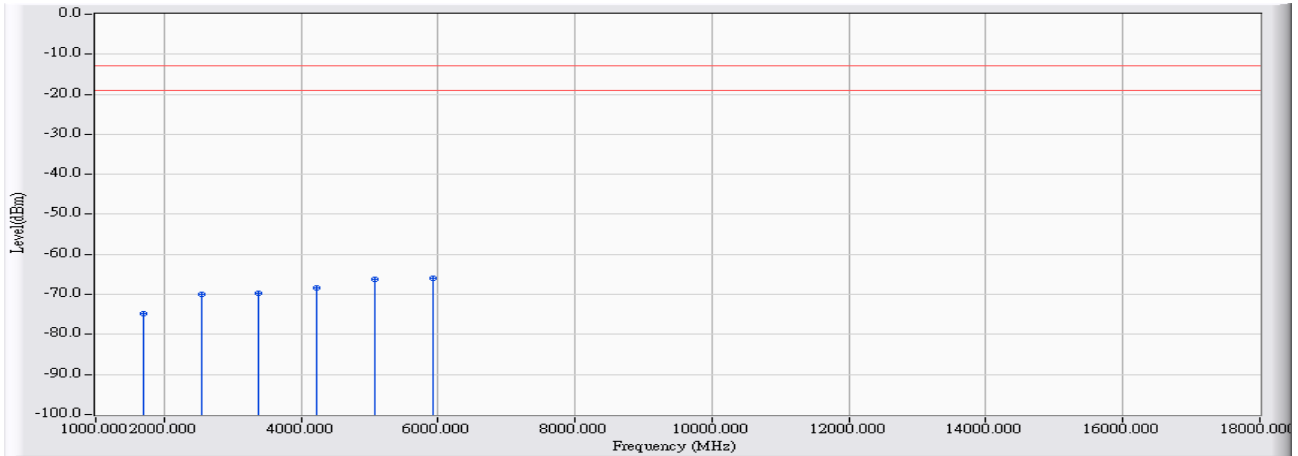

	Frequency (MHz)	Correct Factor (dB)	Reading Level (dBm)	Measure Level (dBm)	Margin (dB)	Limit (dBm)	Detector Type
1	1693.200	-0.940	-73.790	-74.731	-61.731	-13.000	PEAK
2	2539.800	4.008	-74.100	-70.091	-57.091	-13.000	PEAK
3	3386.400	5.443	-75.220	-69.776	-56.776	-13.000	PEAK
4	4233.000	7.928	-76.290	-68.363	-55.363	-13.000	PEAK
5	5079.600	11.048	-77.230	-66.182	-53.182	-13.000	PEAK
6	* 5926.200	12.823	-78.800	-65.978	-52.978	-13.000	PEAK

Note:

1. All readings above 1GHz are performed with peak and/or average measurements as necessary.
2. Peak measurements: RBW = 1MHz, VBW = 1MHz, Sweep: Auto.
3. Average measurements: RBW = 1MHz, VBW = 10 Hz, Sweep: Auto.
4. “ * ”, means this data is the worst emission level.
5. Measurement Level = Reading Level + Correct Factor.
6. The average measurement was not performed when the peak measured data under the limit of average detection.
7. The Emission above 18GHz were not included is because their levels are too low.

Site : CB4-H	Time : 2017/02/20
Limit : Part_22/24_00M_PK	Margin : 6
Probe : CB4-H_CE_Sub_B091_1-18GHz_3M_0117 - HORIZONTAL	Power : DC 3.8V
EUT : LE910C1-NA	Note : Mode 11: WCDMA Band 2_Link Mode_1852.4MHz

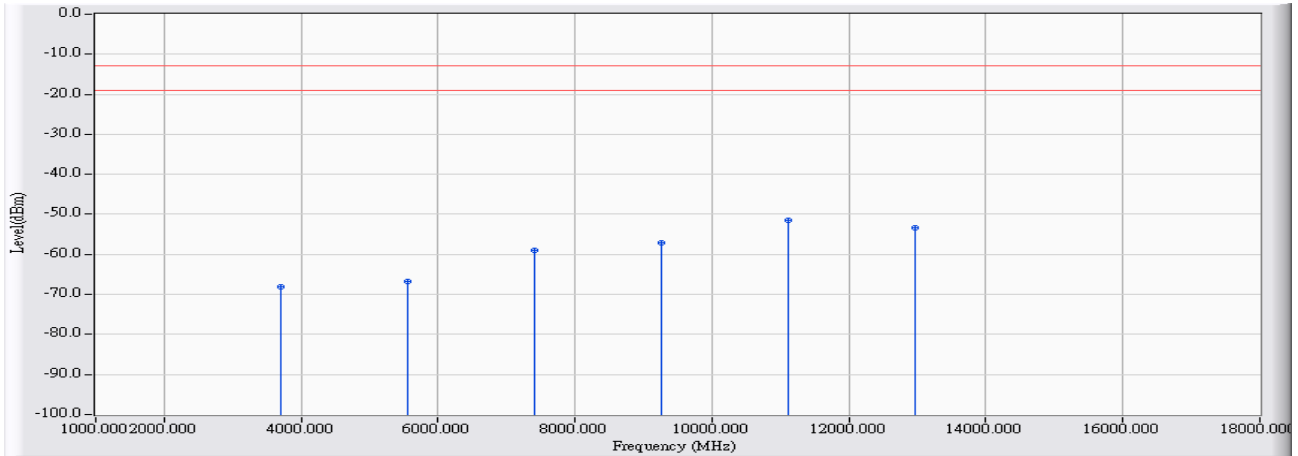

		Frequency (MHz)	Correct Factor (dB)	Reading Level (dBm)	Measure Level (dBm)	Margin (dB)	Limit (dBm)	Detector Type
1		3704.800	6.602	-74.830	-68.228	-55.228	-13.000	PEAK
2		5557.200	12.106	-78.910	-66.804	-53.804	-13.000	PEAK
3		7409.600	20.762	-79.710	-58.948	-45.948	-13.000	PEAK
4		9262.000	24.262	-81.490	-57.229	-44.229	-13.000	PEAK
5	*	11114.400	31.352	-82.720	-51.368	-38.368	-13.000	PEAK
6		12966.800	30.112	-83.450	-53.337	-40.337	-13.000	PEAK

Note:

1. All readings above 1GHz are performed with peak and/or average measurements as necessary.
2. Peak measurements: RBW = 1MHz, VBW = 1MHz, Sweep: Auto.
3. Average measurements: RBW = 1MHz, VBW = 10 Hz, Sweep: Auto.
4. “ * ”, means this data is the worst emission level.
5. Measurement Level = Reading Level + Correct Factor.
6. The average measurement was not performed when the peak measured data under the limit of average detection.
7. The Emission above 18GHz were not included is because their levels are too low.

Site : CB4-H	Time : 2017/02/20
Limit : Part_22/24_00M_PK	Margin : 6
Probe : CB4-H_CE_Sub_B091_1-18GHz_3M_0117 - VERTICAL	Power : DC 3.8V
EUT : LE910C1-NA	Note : Mode 11: WCDMA Band 2_Link Mode_1852.4MHz

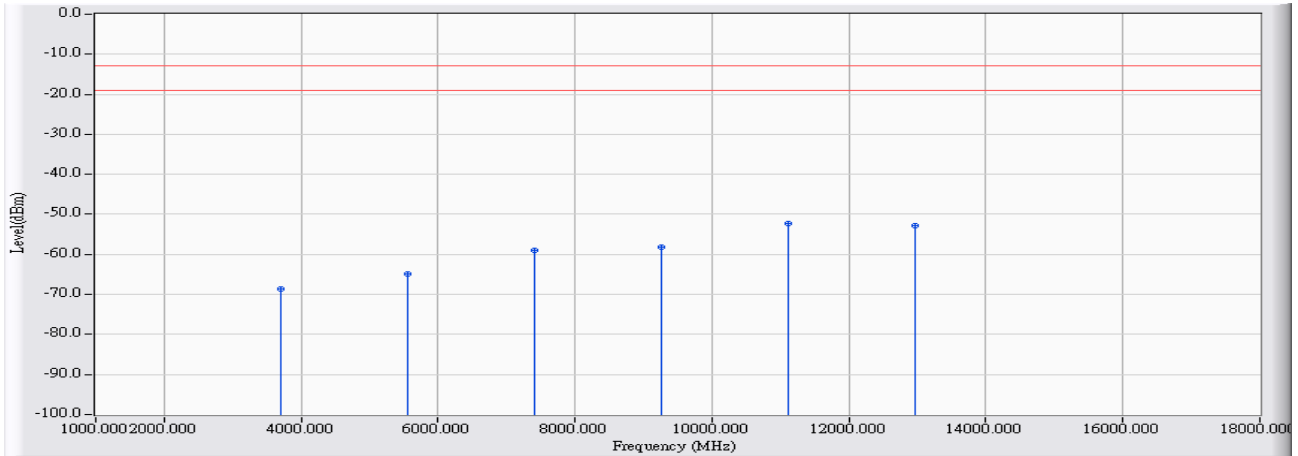

		Frequency (MHz)	Correct Factor (dB)	Reading Level (dBm)	Measure Level (dBm)	Margin (dB)	Limit (dBm)	Detector Type
1		3704.800	6.713	-75.270	-68.557	-55.557	-13.000	PEAK
2		5557.200	12.422	-77.380	-64.958	-51.958	-13.000	PEAK
3		7409.600	20.904	-79.830	-58.926	-45.926	-13.000	PEAK
4		9262.000	23.809	-81.950	-58.141	-45.141	-13.000	PEAK
5	*	11114.400	30.639	-82.970	-52.331	-39.331	-13.000	PEAK
6		12966.800	30.631	-83.550	-52.918	-39.918	-13.000	PEAK

Note:

1. All readings above 1GHz are performed with peak and/or average measurements as necessary.
2. Peak measurements: RBW = 1MHz, VBW = 1MHz, Sweep: Auto.
3. Average measurements: RBW = 1MHz, VBW = 10 Hz, Sweep: Auto.
4. “ * ”, means this data is the worst emission level.
5. Measurement Level = Reading Level + Correct Factor.
6. The average measurement was not performed when the peak measured data under the limit of average detection.
7. The Emission above 18GHz were not included is because their levels are too low.

Site : CB4-H	Time : 2017/02/20
Limit : Part_22/24_00M_PK	Margin : 6
Probe : CB4-H_CE_Sub_B091_1-18GHz_3M_0117 - HORIZONTAL	Power : DC 3.8V
EUT : LE910C1-NA	Note : Mode 11: WCDMA Band 2_Link Mode_1880MHz

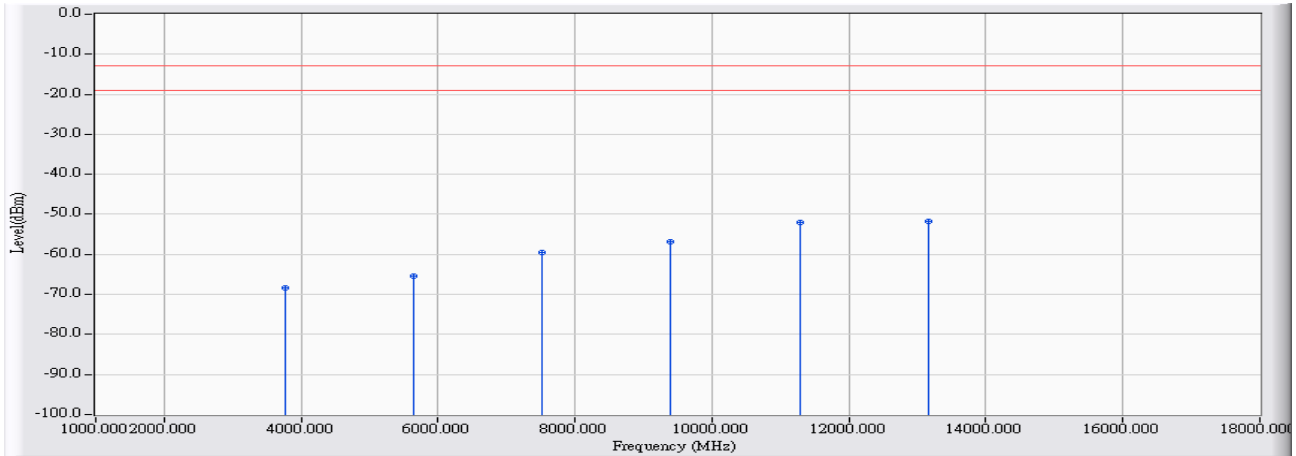

		Frequency (MHz)	Correct Factor (dB)	Reading Level (dBm)	Measure Level (dBm)	Margin (dB)	Limit (dBm)	Detector Type
1		3760.000	6.745	-75.130	-68.384	-55.384	-13.000	PEAK
2		5640.000	12.297	-77.660	-65.362	-52.362	-13.000	PEAK
3		7520.000	21.336	-80.840	-59.504	-46.504	-13.000	PEAK
4		9400.000	26.316	-83.130	-56.814	-43.814	-13.000	PEAK
5		11280.000	31.218	-83.210	-51.992	-38.992	-13.000	PEAK
6	*	13160.000	31.577	-83.240	-51.664	-38.664	-13.000	PEAK

Note:

1. All readings above 1GHz are performed with peak and/or average measurements as necessary.
2. Peak measurements: RBW = 1MHz, VBW = 1MHz, Sweep: Auto.
3. Average measurements: RBW = 1MHz, VBW = 10 Hz, Sweep: Auto.
4. “ * ”, means this data is the worst emission level.
5. Measurement Level = Reading Level + Correct Factor.
6. The average measurement was not performed when the peak measured data under the limit of average detection.
7. The Emission above 18GHz were not included is because their levels are too low.

Site : CB4-H	Time : 2017/02/20
Limit : Part_22/24_00M_PK	Margin : 6
Probe : CB4-H_CE_Sub_B091_1-18GHz_3M_0117 - VERTICAL	Power : DC 3.8V
EUT : LE910C1-NA	Note : Mode 11: WCDMA Band 2_Link Mode_1880MHz

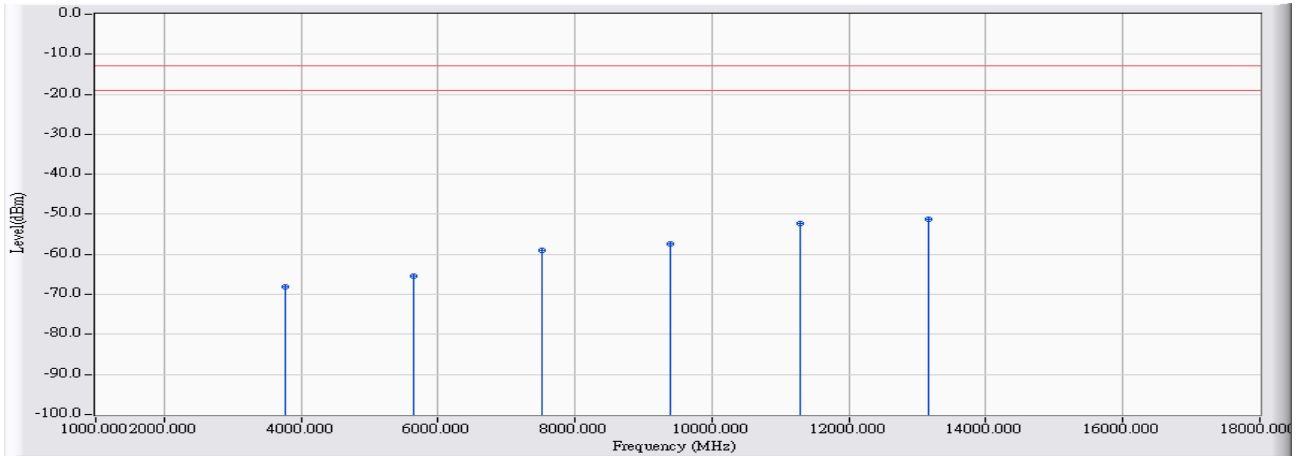

		Frequency (MHz)	Correct Factor (dB)	Reading Level (dBm)	Measure Level (dBm)	Margin (dB)	Limit (dBm)	Detector Type
1		3760.000	6.944	-74.960	-68.015	-55.015	-13.000	PEAK
2		5640.000	12.456	-77.830	-65.374	-52.374	-13.000	PEAK
3		7520.000	21.624	-80.480	-58.856	-45.856	-13.000	PEAK
4		9400.000	26.101	-83.450	-57.349	-44.349	-13.000	PEAK
5		11280.000	30.731	-82.930	-52.199	-39.199	-13.000	PEAK
6	*	13160.000	31.880	-82.970	-51.090	-38.090	-13.000	PEAK

Note:

1. All readings above 1GHz are performed with peak and/or average measurements as necessary.
2. Peak measurements: RBW = 1MHz, VBW = 1MHz, Sweep: Auto.
3. Average measurements: RBW = 1MHz, VBW = 10 Hz, Sweep: Auto.
4. “ * ”, means this data is the worst emission level.
5. Measurement Level = Reading Level + Correct Factor.
6. The average measurement was not performed when the peak measured data under the limit of average detection.
7. The Emission above 18GHz were not included is because their levels are too low.

Site : CB4-H	Time : 2017/02/20
Limit : Part_22/24_00M_PK	Margin : 6
Probe : CB4-H_CE_Sub_B091_1-18GHz_3M_0117 - HORIZONTAL	Power : DC 3.8V
EUT : LE910C1-NA	Note : Mode 11: WCDMA Band 2_Link Mode_1907.6MHz

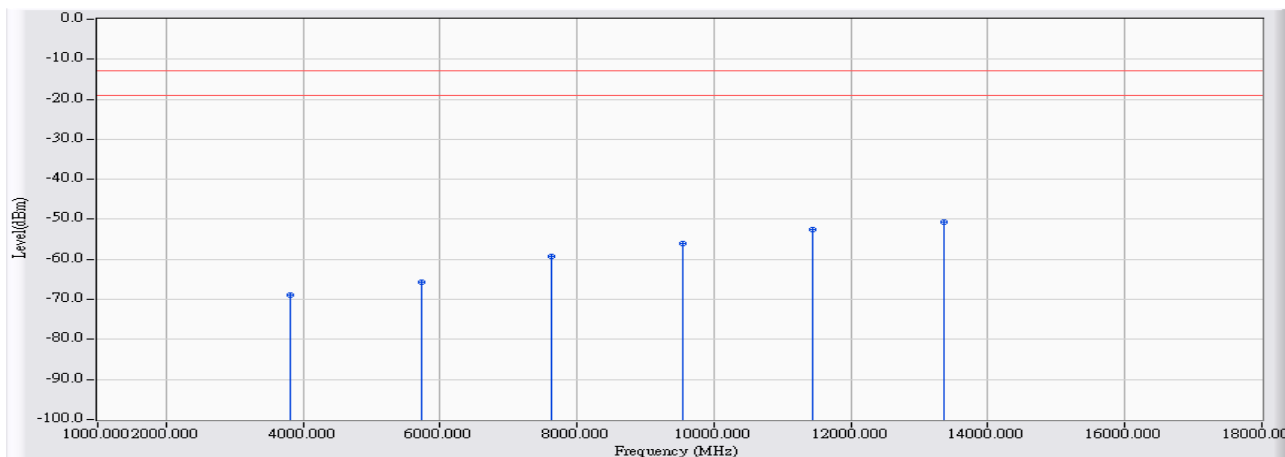

		Frequency (MHz)	Correct Factor (dB)	Reading Level (dBm)	Measure Level (dBm)	Margin (dB)	Limit (dBm)	Detector Type
1		3815.200	6.704	-75.620	-68.916	-55.916	-13.000	PEAK
2		5722.800	12.489	-78.060	-65.571	-52.571	-13.000	PEAK
3		7630.400	21.775	-80.950	-59.175	-46.175	-13.000	PEAK
4		9538.000	27.398	-83.500	-56.103	-43.103	-13.000	PEAK
5		11445.600	31.545	-84.170	-52.625	-39.625	-13.000	PEAK
6	*	13353.200	32.107	-82.780	-50.673	-37.673	-13.000	PEAK

Note:

1. All readings above 1GHz are performed with peak and/or average measurements as necessary.
2. Peak measurements: RBW = 1MHz, VBW = 1MHz, Sweep: Auto.
3. Average measurements: RBW = 1MHz, VBW = 10 Hz, Sweep: Auto.
4. “ * ”, means this data is the worst emission level.
5. Measurement Level = Reading Level + Correct Factor.
6. The average measurement was not performed when the peak measured data under the limit of average detection.
7. The Emission above 18GHz were not included is because their levels are too low.

Site : CB4-H	Time : 2017/02/20
Limit : Part_22/24_00M_PK	Margin : 6
Probe : CB4-H_CE_Sub_B091_1-18GHz_3M_0117 - VERTICAL	Power : DC 3.8V
EUT : LE910C1-NA	Note : Mode 11: WCDMA Band 2_Link Mode_1907.6MHz

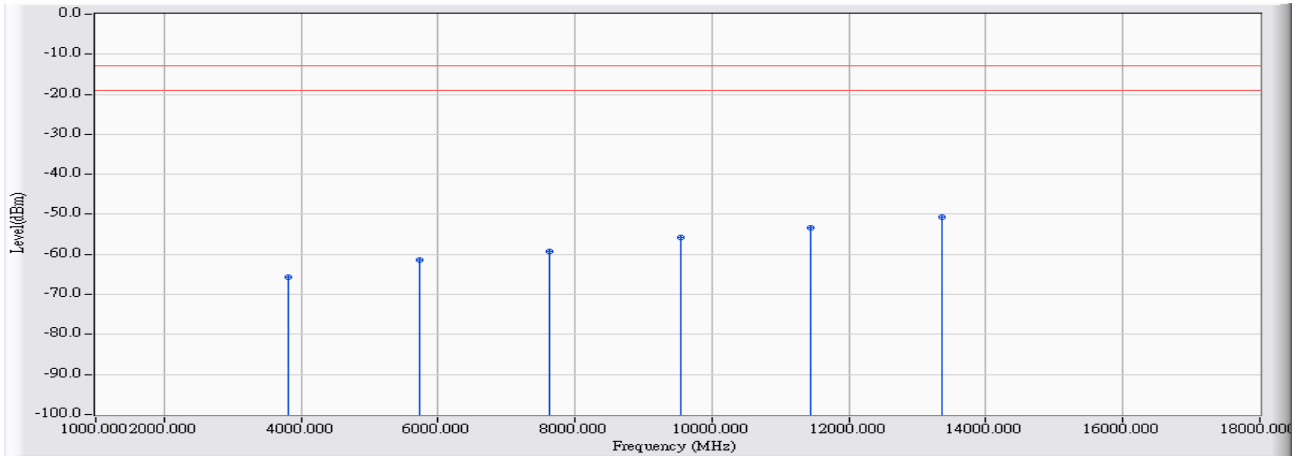

		Frequency (MHz)	Correct Factor (dB)	Reading Level (dBm)	Measure Level (dBm)	Margin (dB)	Limit (dBm)	Detector Type
1		3815.200	6.898	-72.550	-65.652	-52.652	-13.000	PEAK
2		5722.800	12.490	-74.000	-61.510	-48.510	-13.000	PEAK
3		7630.400	21.877	-81.040	-59.163	-46.163	-13.000	PEAK
4		9538.000	27.266	-82.910	-55.644	-42.644	-13.000	PEAK
5		11445.600	30.899	-84.250	-53.351	-40.351	-13.000	PEAK
6	*	13353.200	32.242	-83.020	-50.778	-37.778	-13.000	PEAK

Note:

1. All readings above 1GHz are performed with peak and/or average measurements as necessary.
2. Peak measurements: RBW = 1MHz, VBW = 1MHz, Sweep: Auto.
3. Average measurements: RBW = 1MHz, VBW = 10 Hz, Sweep: Auto.
4. “ * ”, means this data is the worst emission level.
5. Measurement Level = Reading Level + Correct Factor.
6. The average measurement was not performed when the peak measured data under the limit of average detection.
7. The Emission above 18GHz were not included is because their levels are too low.

Site : CB4-H	Time : 2017/02/20
Limit : Part_22/24_00M_PK	Margin : 6
Probe : CB4-H_CE_Sub_B091_1-18GHz_3M_0117 - HORIZONTAL	Power : DC 3.8V
EUT : LE910C1-NA	Note : Mode 12: WCDMA Band 2_Idle Mode_1852.4MHz

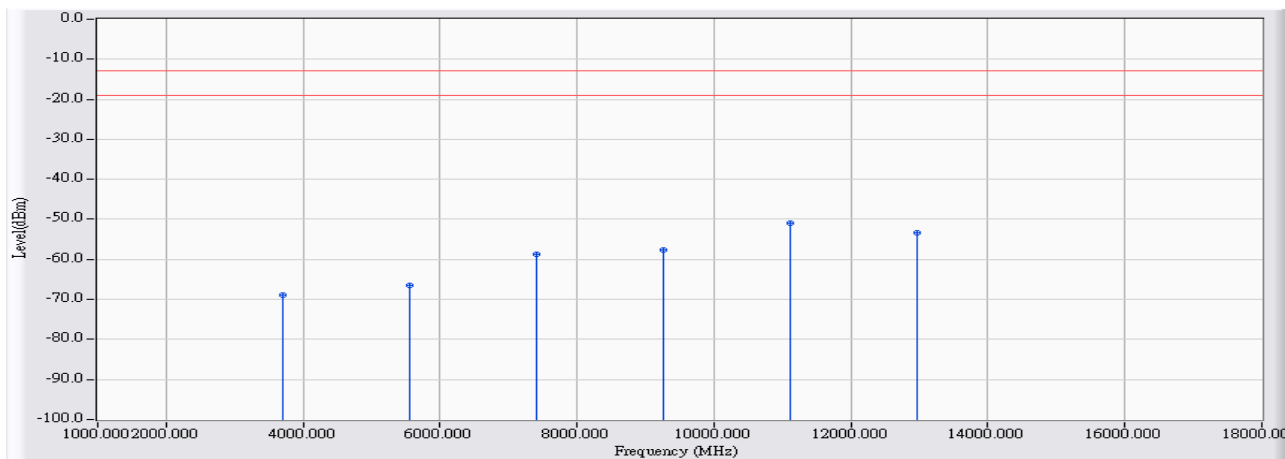

		Frequency (MHz)	Correct Factor (dB)	Reading Level (dBm)	Measure Level (dBm)	Margin (dB)	Limit (dBm)	Detector Type
1		3704.800	6.602	-75.470	-68.868	-55.868	-13.000	PEAK
2		5557.200	12.106	-78.550	-66.444	-53.444	-13.000	PEAK
3		7409.600	20.762	-79.450	-58.688	-45.688	-13.000	PEAK
4		9262.000	24.262	-81.830	-57.569	-44.569	-13.000	PEAK
5	*	11114.400	31.352	-82.290	-50.938	-37.938	-13.000	PEAK
6		12966.800	30.112	-83.380	-53.267	-40.267	-13.000	PEAK

Note:

1. All readings above 1GHz are performed with peak and/or average measurements as necessary.
2. Peak measurements: RBW = 1MHz, VBW = 1MHz, Sweep: Auto.
3. Average measurements: RBW = 1MHz, VBW = 10 Hz, Sweep: Auto.
4. “ * ”, means this data is the worst emission level.
5. Measurement Level = Reading Level + Correct Factor.
6. The average measurement was not performed when the peak measured data under the limit of average detection.
7. The Emission above 18GHz were not included is because their levels are too low.

Site : CB4-H	Time : 2017/02/20
Limit : Part_22/24_00M_PK	Margin : 6
Probe : CB4-H_CE_Sub_B091_1-18GHz_3M_0117 - VERTICAL	Power : DC 3.8V
EUT : LE910C1-NA	Note : Mode 12: WCDMA Band 2_Idle Mode_1852.4MHz

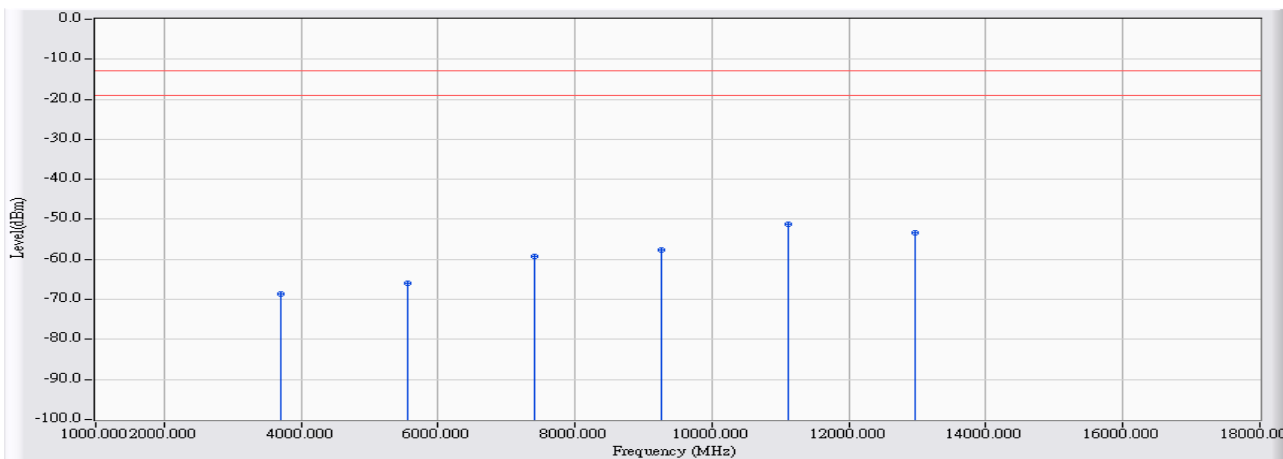

		Frequency (MHz)	Correct Factor (dB)	Reading Level (dBm)	Measure Level (dBm)	Margin (dB)	Limit (dBm)	Detector Type
1		3704.800	6.713	-75.360	-68.647	-55.647	-13.000	PEAK
2		5557.200	12.422	-78.480	-66.058	-53.058	-13.000	PEAK
3		7409.600	20.904	-80.090	-59.186	-46.186	-13.000	PEAK
4		9262.000	23.809	-81.350	-57.541	-44.541	-13.000	PEAK
5	*	11114.400	30.639	-81.950	-51.311	-38.311	-13.000	PEAK
6		12966.800	30.631	-83.900	-53.268	-40.268	-13.000	PEAK

Note:

1. All readings above 1GHz are performed with peak and/or average measurements as necessary.
2. Peak measurements: RBW = 1MHz, VBW = 1MHz, Sweep: Auto.
3. Average measurements: RBW = 1MHz, VBW = 10 Hz, Sweep: Auto.
4. “ * ”, means this data is the worst emission level.
5. Measurement Level = Reading Level + Correct Factor.
6. The average measurement was not performed when the peak measured data under the limit of average detection.
7. The Emission above 18GHz were not included is because their levels are too low.

Site : CB4-H	Time : 2017/02/20
Limit : Part_22/24_00M_PK	Margin : 6
Probe : CB4-H_CE_Sub_B091_1-18GHz_3M_0117 - HORIZONTAL	Power : DC 3.8V
EUT : LE910C1-NA	Note : Mode 12: WCDMA Band 2_Idle Mode_1880MHz

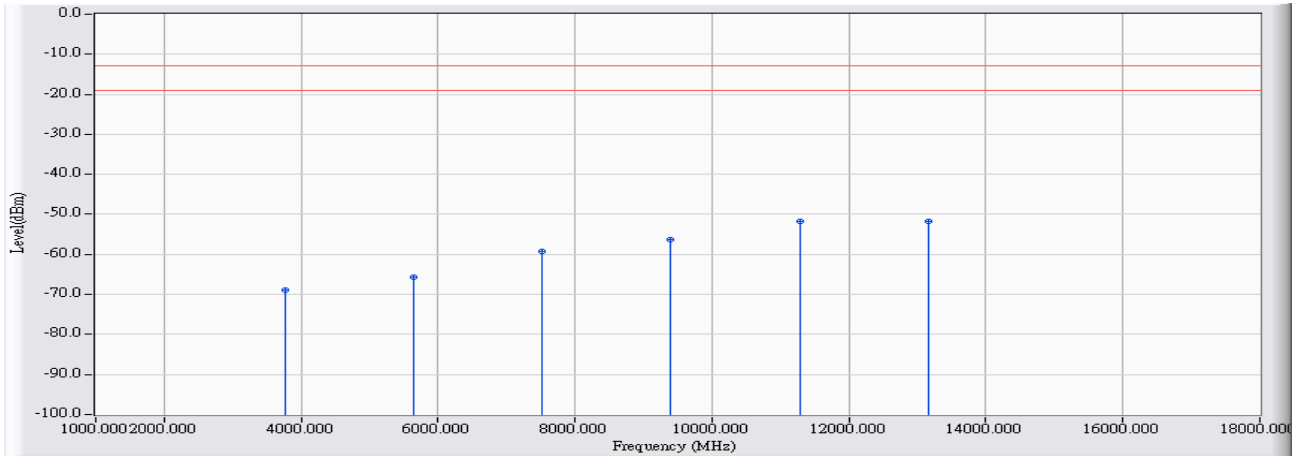

		Frequency (MHz)	Correct Factor (dB)	Reading Level (dBm)	Measure Level (dBm)	Margin (dB)	Limit (dBm)	Detector Type
1		3760.000	6.745	-75.590	-68.844	-55.844	-13.000	PEAK
2		5640.000	12.297	-78.080	-65.782	-52.782	-13.000	PEAK
3		7520.000	21.336	-80.640	-59.304	-46.304	-13.000	PEAK
4		9400.000	26.316	-82.600	-56.284	-43.284	-13.000	PEAK
5		11280.000	31.218	-83.070	-51.852	-38.852	-13.000	PEAK
6	*	13160.000	31.577	-83.370	-51.794	-38.794	-13.000	PEAK

Note:

1. All readings above 1GHz are performed with peak and/or average measurements as necessary.
2. Peak measurements: RBW = 1MHz, VBW = 1MHz, Sweep: Auto.
3. Average measurements: RBW = 1MHz, VBW = 10 Hz, Sweep: Auto.
4. “ * ”, means this data is the worst emission level.
5. Measurement Level = Reading Level + Correct Factor.
6. The average measurement was not performed when the peak measured data under the limit of average detection.
7. The Emission above 18GHz were not included is because their levels are too low.

Site : CB4-H	Time : 2017/02/20
Limit : Part_22/24_00M_PK	Margin : 6
Probe : CB4-H_CE_Sub_B091_1-18GHz_3M_0117 - VERTICAL	Power : DC 3.8V
EUT : LE910C1-NA	Note : Mode 12: WCDMA Band 2_Idle Mode_1880MHz

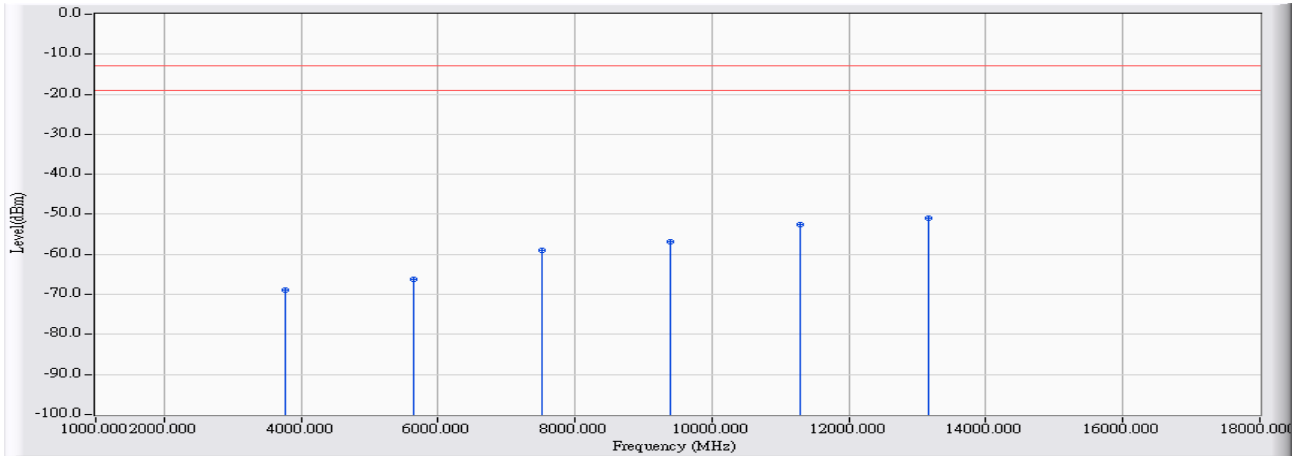

		Frequency (MHz)	Correct Factor (dB)	Reading Level (dBm)	Measure Level (dBm)	Margin (dB)	Limit (dBm)	Detector Type
1		3760.000	6.944	-75.900	-68.955	-55.955	-13.000	PEAK
2		5640.000	12.456	-78.680	-66.224	-53.224	-13.000	PEAK
3		7520.000	21.624	-80.640	-59.016	-46.016	-13.000	PEAK
4		9400.000	26.101	-83.060	-56.959	-43.959	-13.000	PEAK
5		11280.000	30.731	-83.330	-52.599	-39.599	-13.000	PEAK
6	*	13160.000	31.880	-82.800	-50.920	-37.920	-13.000	PEAK

Note:

1. All readings above 1GHz are performed with peak and/or average measurements as necessary.
2. Peak measurements: RBW = 1MHz, VBW = 1MHz, Sweep: Auto.
3. Average measurements: RBW = 1MHz, VBW = 10 Hz, Sweep: Auto.
4. “ * ”, means this data is the worst emission level.
5. Measurement Level = Reading Level + Correct Factor.
6. The average measurement was not performed when the peak measured data under the limit of average detection.
7. The Emission above 18GHz were not included is because their levels are too low.

Site : CB4-H	Time : 2017/02/20
Limit : Part_22/24_00M_PK	Margin : 6
Probe : CB4-H_CE_Sub_B091_1-18GHz_3M_0117 - HORIZONTAL	Power : DC 3.8V
EUT : LE910C1-NA	Note : Mode 12: WCDMA Band 2_Idle Mode_1907.6MHz

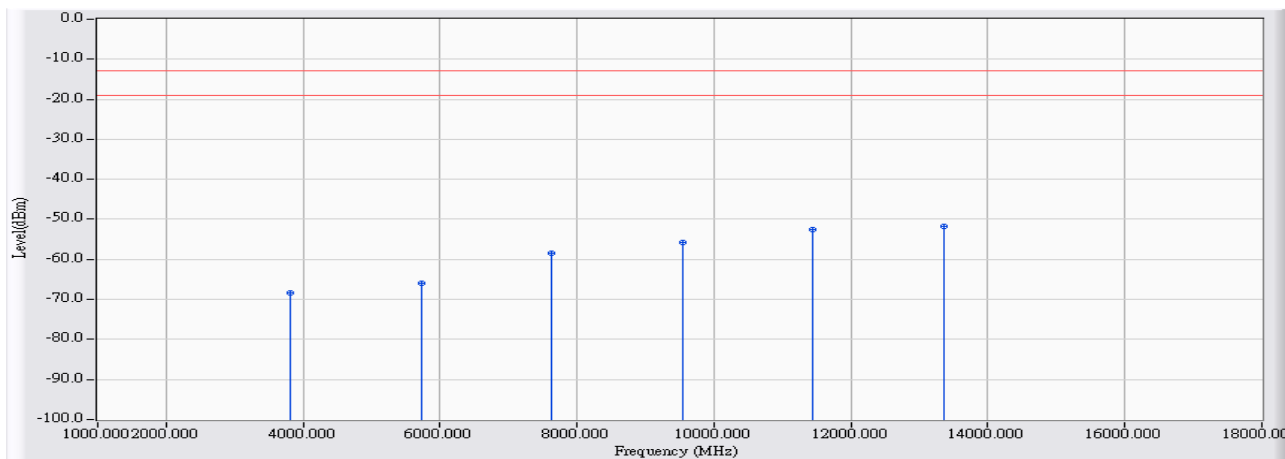

		Frequency (MHz)	Correct Factor (dB)	Reading Level (dBm)	Measure Level (dBm)	Margin (dB)	Limit (dBm)	Detector Type
1		3815.200	6.704	-75.120	-68.416	-55.416	-13.000	PEAK
2		5722.800	12.489	-78.340	-65.851	-52.851	-13.000	PEAK
3		7630.400	21.775	-80.290	-58.515	-45.515	-13.000	PEAK
4		9538.000	27.398	-83.130	-55.733	-42.733	-13.000	PEAK
5		11445.600	31.545	-83.960	-52.415	-39.415	-13.000	PEAK
6	*	13353.200	32.107	-83.850	-51.743	-38.743	-13.000	PEAK

Note:

1. All readings above 1GHz are performed with peak and/or average measurements as necessary.
2. Peak measurements: RBW = 1MHz, VBW = 1MHz, Sweep: Auto.
3. Average measurements: RBW = 1MHz, VBW = 10 Hz, Sweep: Auto.
4. “ * ”, means this data is the worst emission level.
5. Measurement Level = Reading Level + Correct Factor.
6. The average measurement was not performed when the peak measured data under the limit of average detection.
7. The Emission above 18GHz were not included is because their levels are too low.

Site : CB4-H	Time : 2017/02/20
Limit : Part_22/24_00M_PK	Margin : 6
Probe : CB4-H_CE_Sub_B091_1-18GHz_3M_0117 - VERTICAL	Power : DC 3.8V
EUT : LE910C1-NA	Note : Mode 12: WCDMA Band 2_Idle Mode_1907.6MHz

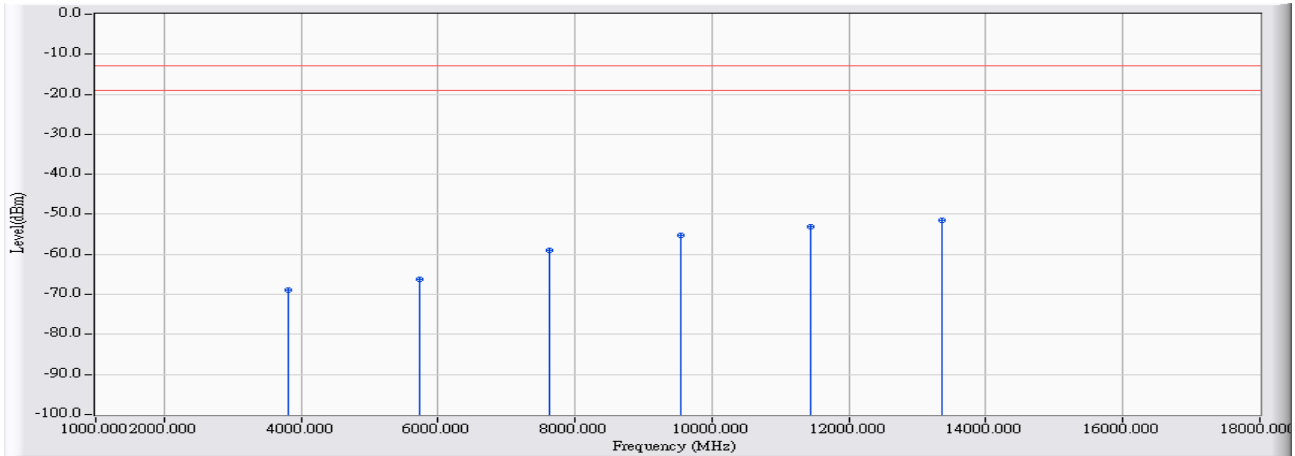

		Frequency (MHz)	Correct Factor (dB)	Reading Level (dBm)	Measure Level (dBm)	Margin (dB)	Limit (dBm)	Detector Type
1		3815.200	6.898	-75.700	-68.802	-55.802	-13.000	PEAK
2		5722.800	12.490	-78.710	-66.220	-53.220	-13.000	PEAK
3		7630.400	21.877	-80.980	-59.103	-46.103	-13.000	PEAK
4		9538.000	27.266	-82.400	-55.134	-42.134	-13.000	PEAK
5		11445.600	30.899	-83.850	-52.951	-39.951	-13.000	PEAK
6	*	13353.200	32.242	-83.660	-51.418	-38.418	-13.000	PEAK

Note:

1. All readings above 1GHz are performed with peak and/or average measurements as necessary.
2. Peak measurements: RBW = 1MHz, VBW = 1MHz, Sweep: Auto.
3. Average measurements: RBW = 1MHz, VBW = 10 Hz, Sweep: Auto.
4. “ * ”, means this data is the worst emission level.
5. Measurement Level = Reading Level + Correct Factor.
6. The average measurement was not performed when the peak measured data under the limit of average detection.
7. The Emission above 18GHz were not included is because their levels are too low.

Site : CB4-H	Time : 2017/02/23
Limit : Part_22/24_00M_PK	Margin : 6
Probe : CB4-H_CE_Sub_B433_1-18GHz_3M_0217 - HORIZONTAL	Power : DC 3.8V
EUT : LE910C1-NA	Note : Mode 13: WCDMA Band 5_HSUPA Mode_Link 826.4MHz

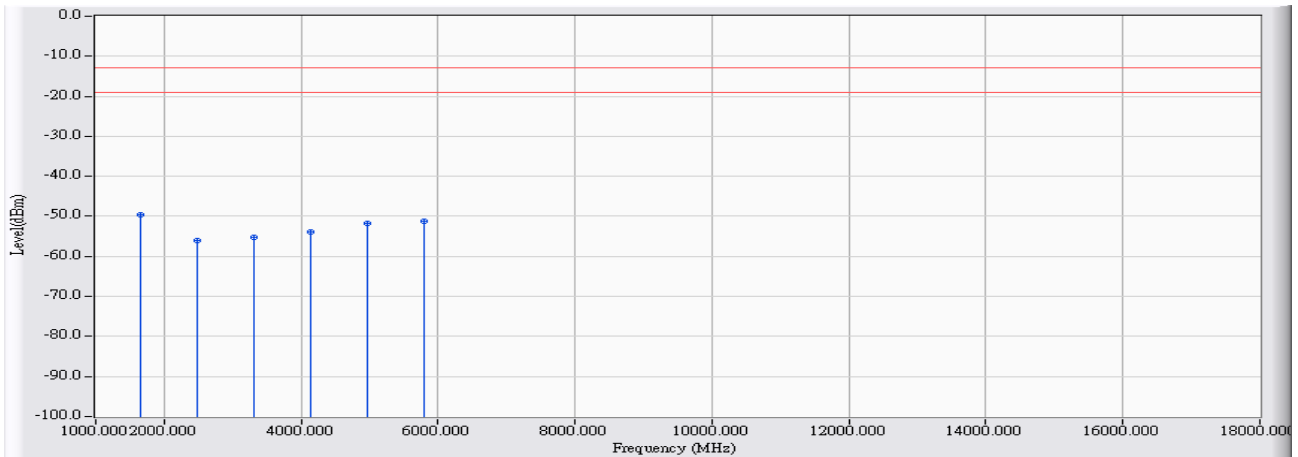

		Frequency (MHz)	Correct Factor (dB)	Reading Level (dBm)	Measure Level (dBm)	Margin (dB)	Limit (dBm)	Detector Type
1	*	1652.800	5.710	-55.290	-49.579	-36.579	-13.000	PEAK
2		2479.200	9.560	-65.500	-55.941	-42.941	-13.000	PEAK
3		3305.600	11.615	-66.830	-55.215	-42.215	-13.000	PEAK
4		4132.000	12.852	-66.850	-53.999	-40.999	-13.000	PEAK
5		4958.400	15.578	-67.450	-51.871	-38.871	-13.000	PEAK
6		5784.800	17.145	-68.400	-51.255	-38.255	-13.000	PEAK

Note:

1. All readings above 1GHz are performed with peak and/or average measurements as necessary.
2. Peak measurements: RBW = 1MHz, VBW = 1MHz, Sweep: Auto.
3. Average measurements: RBW = 1MHz, VBW = 10 Hz, Sweep: Auto.
4. “ * ”, means this data is the worst emission level.
5. Measurement Level = Reading Level + Correct Factor.
6. The average measurement was not performed when the peak measured data under the limit of average detection.
7. The Emission above 18GHz were not included is because their levels are too low.

Site : CB4-H	Time : 2017/02/23
Limit : Part_22/24_00M_PK	Margin : 6
Probe : CB4-H_CE_Sub_B433_1-18GHz_3M_0217 - VERTICAL	Power : DC 3.8V
EUT : LE910C1-NA	Note : Mode 13: WCDMA Band 5_HSUPA Mode_Link 826.4MHz

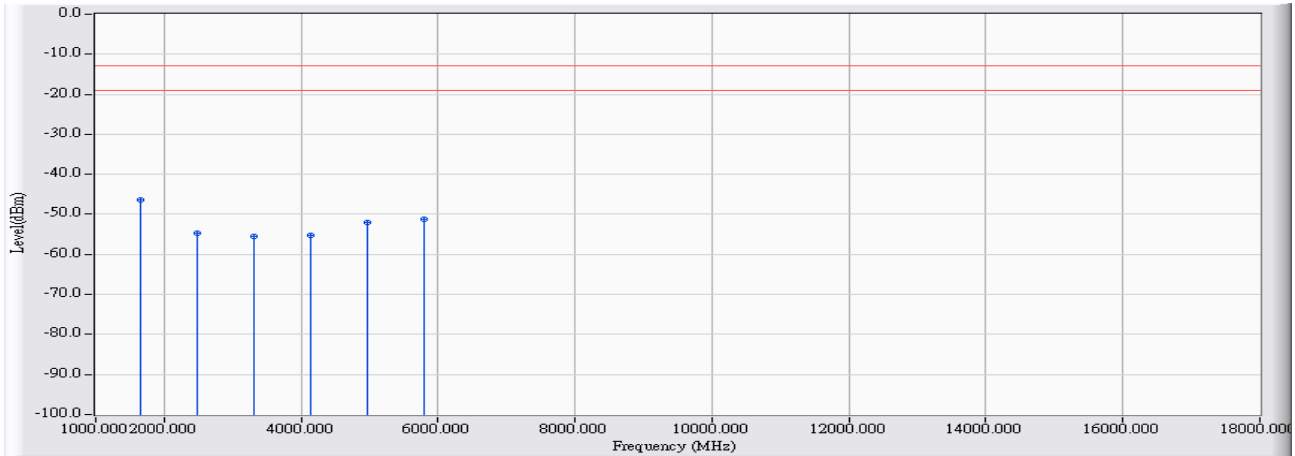

		Frequency (MHz)	Correct Factor (dB)	Reading Level (dBm)	Measure Level (dBm)	Margin (dB)	Limit (dBm)	Detector Type
1	*	1652.800	5.423	-51.700	-46.276	-33.276	-13.000	PEAK
2		2479.200	9.610	-64.320	-54.711	-41.711	-13.000	PEAK
3		3305.600	11.684	-67.160	-55.476	-42.476	-13.000	PEAK
4		4132.000	12.415	-67.680	-55.265	-42.265	-13.000	PEAK
5		4958.400	15.723	-67.840	-52.116	-39.116	-13.000	PEAK
6		5784.800	17.149	-68.330	-51.181	-38.181	-13.000	PEAK

Note:

1. All readings above 1GHz are performed with peak and/or average measurements as necessary.
2. Peak measurements: RBW = 1MHz, VBW = 1MHz, Sweep: Auto.
3. Average measurements: RBW = 1MHz, VBW = 10 Hz, Sweep: Auto.
4. “ * ”, means this data is the worst emission level.
5. Measurement Level = Reading Level + Correct Factor.
6. The average measurement was not performed when the peak measured data under the limit of average detection.
7. The Emission above 18GHz were not included is because their levels are too low.

Site : CB4-H	Time : 2017/02/23
Limit : Part_22/24_00M_PK	Margin : 6
Probe : CB4-H_CE_Sub_B433_1-18GHz_3M_0217 - HORIZONTAL	Power : DC 3.8V
EUT : LE910C1-NA	Note : Mode 13: WCDMA Band 5_HSUPA Mode_Link 836.6MHz

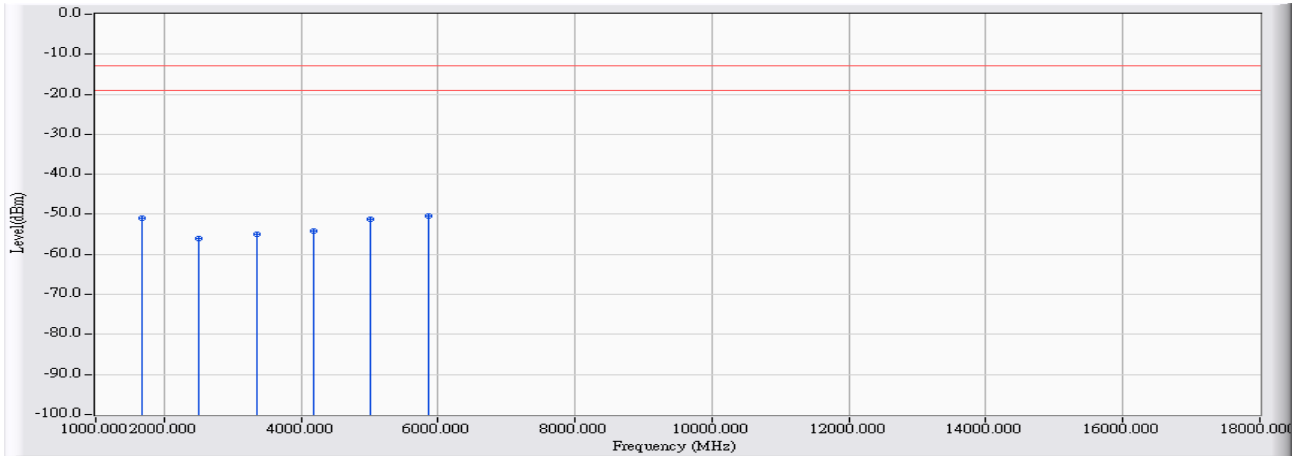

		Frequency (MHz)	Correct Factor (dB)	Reading Level (dBm)	Measure Level (dBm)	Margin (dB)	Limit (dBm)	Detector Type
1		1673.200	5.688	-56.710	-51.022	-38.022	-13.000	PEAK
2		2509.800	9.513	-65.670	-56.157	-43.157	-13.000	PEAK
3		3346.400	11.706	-66.570	-54.864	-41.864	-13.000	PEAK
4		4183.000	12.869	-66.960	-54.091	-41.091	-13.000	PEAK
5		5019.600	15.636	-66.900	-51.264	-38.264	-13.000	PEAK
6	*	5856.200	17.595	-67.960	-50.365	-37.365	-13.000	PEAK

Note:

1. All readings above 1GHz are performed with peak and/or average measurements as necessary.
2. Peak measurements: RBW = 1MHz, VBW = 1MHz, Sweep: Auto.
3. Average measurements: RBW = 1MHz, VBW = 10 Hz, Sweep: Auto.
4. “ * ”, means this data is the worst emission level.
5. Measurement Level = Reading Level + Correct Factor.
6. The average measurement was not performed when the peak measured data under the limit of average detection.
7. The Emission above 18GHz were not included is because their levels are too low.

Site : CB4-H	Time : 2017/02/23
Limit : Part_22/24_00M_PK	Margin : 6
Probe : CB4-H_CE_Sub_B433_1-18GHz_3M_0217 - VERTICAL	Power : DC 3.8V
EUT : LE910C1-NA	Note : Mode 13: WCDMA Band 5_HSUPA Mode_Link 836.6MHz

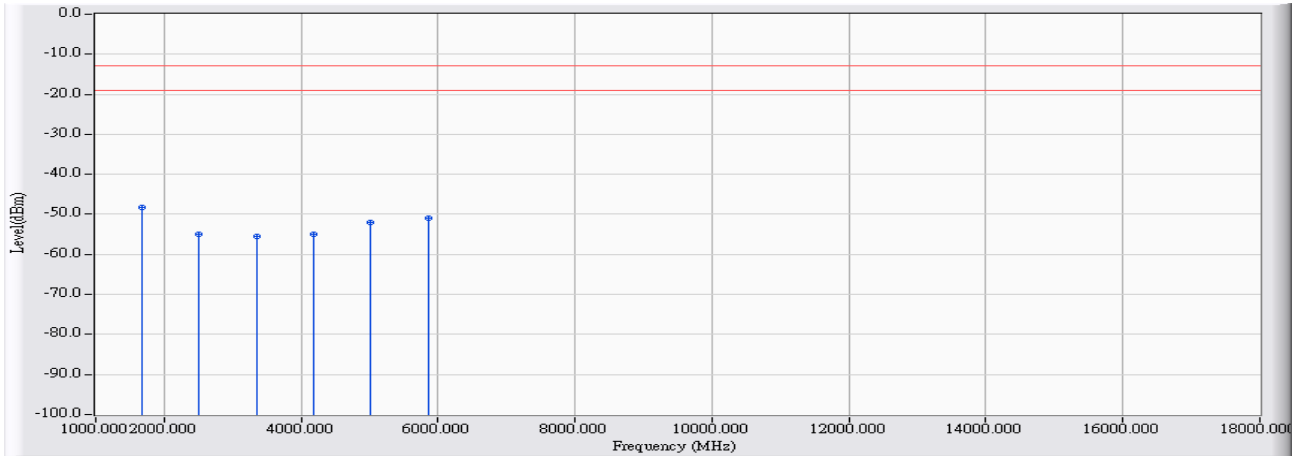

		Frequency (MHz)	Correct Factor (dB)	Reading Level (dBm)	Measure Level (dBm)	Margin (dB)	Limit (dBm)	Detector Type
1	*	1673.200	5.421	-53.660	-48.239	-35.239	-13.000	PEAK
2		2509.800	9.510	-64.520	-55.010	-42.010	-13.000	PEAK
3		3346.400	11.738	-67.240	-55.503	-42.503	-13.000	PEAK
4		4183.000	12.712	-67.680	-54.968	-41.968	-13.000	PEAK
5		5019.600	15.757	-67.760	-52.003	-39.003	-13.000	PEAK
6		5856.200	17.711	-68.660	-50.949	-37.949	-13.000	PEAK

Note:

1. All readings above 1GHz are performed with peak and/or average measurements as necessary.
2. Peak measurements: RBW = 1MHz, VBW = 1MHz, Sweep: Auto.
3. Average measurements: RBW = 1MHz, VBW = 10 Hz, Sweep: Auto.
4. “ * ”, means this data is the worst emission level.
5. Measurement Level = Reading Level + Correct Factor.
6. The average measurement was not performed when the peak measured data under the limit of average detection.
7. The Emission above 18GHz were not included is because their levels are too low.

Site : CB4-H	Time : 2017/02/23
Limit : Part_22/24_00M_PK	Margin : 6
Probe : CB4-H_CE_Sub_B433_1-18GHz_3M_0217 - HORIZONTAL	Power : DC 3.8V
EUT : LE910C1-NA	Note : Mode 13: WCDMA Band 5_HSUPA Mode_Link 846.6MHz

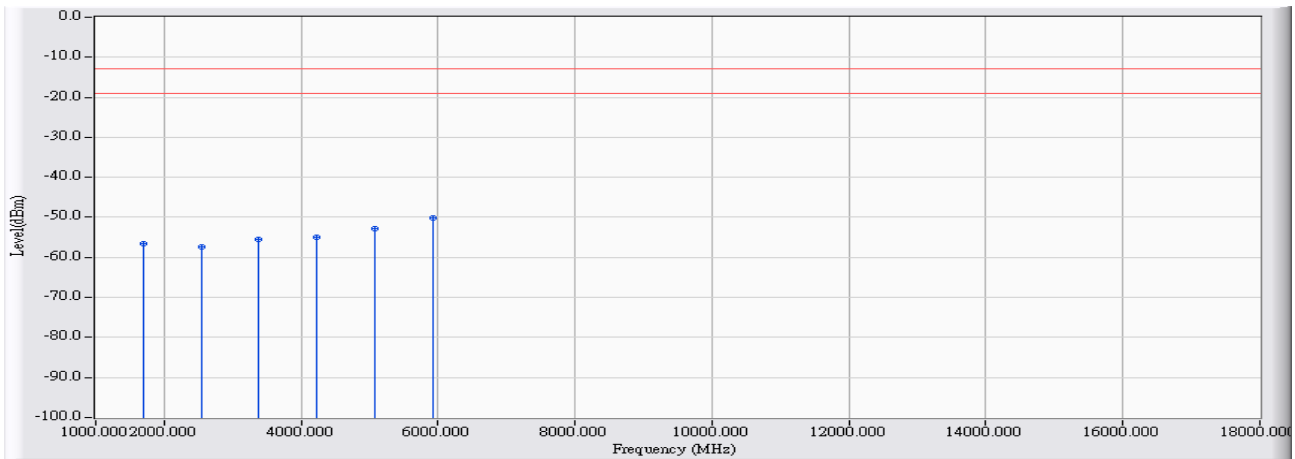

		Frequency (MHz)	Correct Factor (dB)	Reading Level (dBm)	Measure Level (dBm)	Margin (dB)	Limit (dBm)	Detector Type
1		1693.200	5.666	-62.240	-56.574	-43.574	-13.000	PEAK
2		2539.800	9.603	-66.900	-57.297	-44.297	-13.000	PEAK
3		3386.400	11.795	-67.320	-55.526	-42.526	-13.000	PEAK
4		4233.000	12.886	-67.950	-55.064	-42.064	-13.000	PEAK
5		5079.600	15.528	-68.230	-52.702	-39.702	-13.000	PEAK
6	*	5926.200	18.036	-68.150	-50.114	-37.114	-13.000	PEAK

Note:

1. All readings above 1GHz are performed with peak and/or average measurements as necessary.
2. Peak measurements: RBW = 1MHz, VBW = 1MHz, Sweep: Auto.
3. Average measurements: RBW = 1MHz, VBW = 10 Hz, Sweep: Auto.
4. “ * ”, means this data is the worst emission level.
5. Measurement Level = Reading Level + Correct Factor.
6. The average measurement was not performed when the peak measured data under the limit of average detection.
7. The Emission above 18GHz were not included is because their levels are too low.

Site : CB4-H	Time : 2017/02/23
Limit : Part_22/24_00M_PK	Margin : 6
Probe : CB4-H_CE_Sub_B433_1-18GHz_3M_0217 - VERTICAL	Power : DC 3.8V
EUT : LE910C1-NA	Note : Mode 13: WCDMA Band 5_HSUPA Mode_Link 846.6MHz

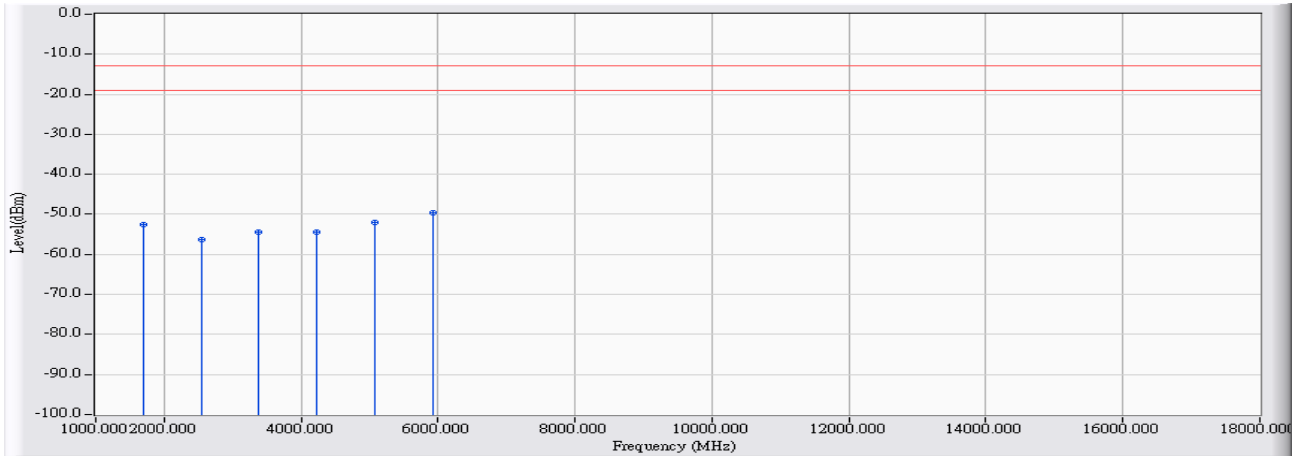

		Frequency (MHz)	Correct Factor (dB)	Reading Level (dBm)	Measure Level (dBm)	Margin (dB)	Limit (dBm)	Detector Type
1		1693.200	5.419	-57.930	-52.511	-39.511	-13.000	PEAK
2		2539.800	9.559	-65.950	-56.391	-43.391	-13.000	PEAK
3		3386.400	11.790	-66.150	-54.361	-41.361	-13.000	PEAK
4		4233.000	13.002	-67.310	-54.307	-41.307	-13.000	PEAK
5		5079.600	15.588	-67.570	-51.982	-38.982	-13.000	PEAK
6	*	5926.200	18.260	-67.880	-49.619	-36.619	-13.000	PEAK

Note:

1. All readings above 1GHz are performed with peak and/or average measurements as necessary.
2. Peak measurements: RBW = 1MHz, VBW = 1MHz, Sweep: Auto.
3. Average measurements: RBW = 1MHz, VBW = 10 Hz, Sweep: Auto.
4. “ * ”, means this data is the worst emission level.
5. Measurement Level = Reading Level + Correct Factor.
6. The average measurement was not performed when the peak measured data under the limit of average detection.
7. The Emission above 18GHz were not included is because their levels are too low.

Site : CB4-H	Time : 2017/02/23
Limit : Part_22/24_00M_PK	Margin : 6
Probe : CB4-H_CE_Sub_B433_1-18GHz_3M_0217 - HORIZONTAL	Power : DC 3.8V
EUT : LE910C1-NA	Note : Mode 13: WCDMA Band 5_HSUPA Mode_Idle 826.4MHz

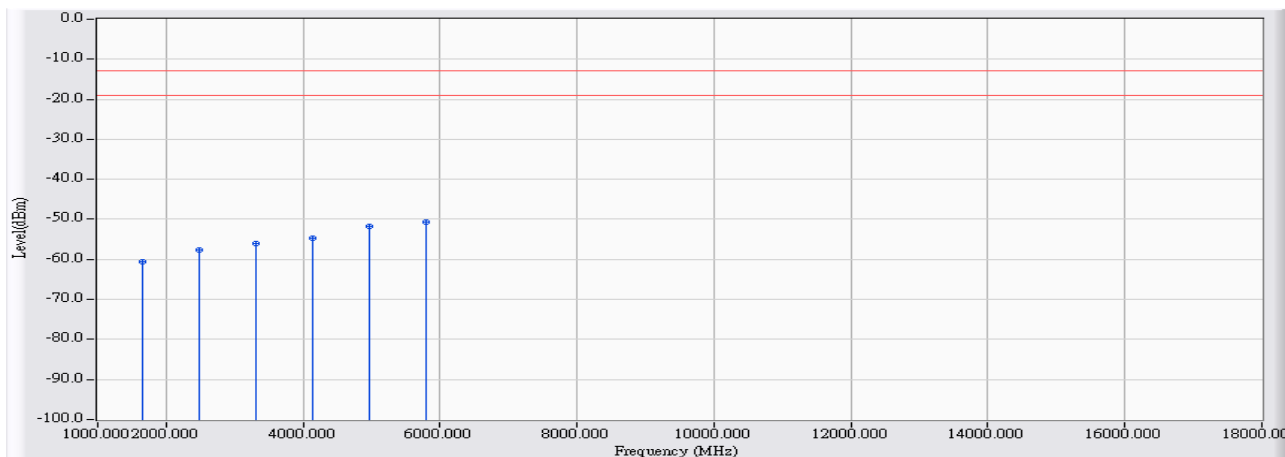

		Frequency (MHz)	Correct Factor (dB)	Reading Level (dBm)	Measure Level (dBm)	Margin (dB)	Limit (dBm)	Detector Type
1		1652.800	5.710	-66.430	-60.719	-47.719	-13.000	PEAK
2		2479.200	9.560	-67.310	-57.751	-44.751	-13.000	PEAK
3		3305.600	11.615	-67.540	-55.925	-42.925	-13.000	PEAK
4		4132.000	12.852	-67.600	-54.749	-41.749	-13.000	PEAK
5		4958.400	15.578	-67.370	-51.791	-38.791	-13.000	PEAK
6	*	5784.800	17.145	-67.910	-50.765	-37.765	-13.000	PEAK

Note:

1. All readings above 1GHz are performed with peak and/or average measurements as necessary.
2. Peak measurements: RBW = 1MHz, VBW = 1MHz, Sweep: Auto.
3. Average measurements: RBW = 1MHz, VBW = 10 Hz, Sweep: Auto.
4. “ * ”, means this data is the worst emission level.
5. Measurement Level = Reading Level + Correct Factor.
6. The average measurement was not performed when the peak measured data under the limit of average detection.
7. The Emission above 18GHz were not included is because their levels are too low.

Site : CB4-H	Time : 2017/02/23
Limit : Part_22/24_00M_PK	Margin : 6
Probe : CB4-H_CE_Sub_B433_1-18GHz_3M_0217 - VERTICAL	Power : DC 3.8V
EUT : LE910C1-NA	Note : Mode 13: WCDMA Band 5_HSUPA Mode_Idle 826.4MHz

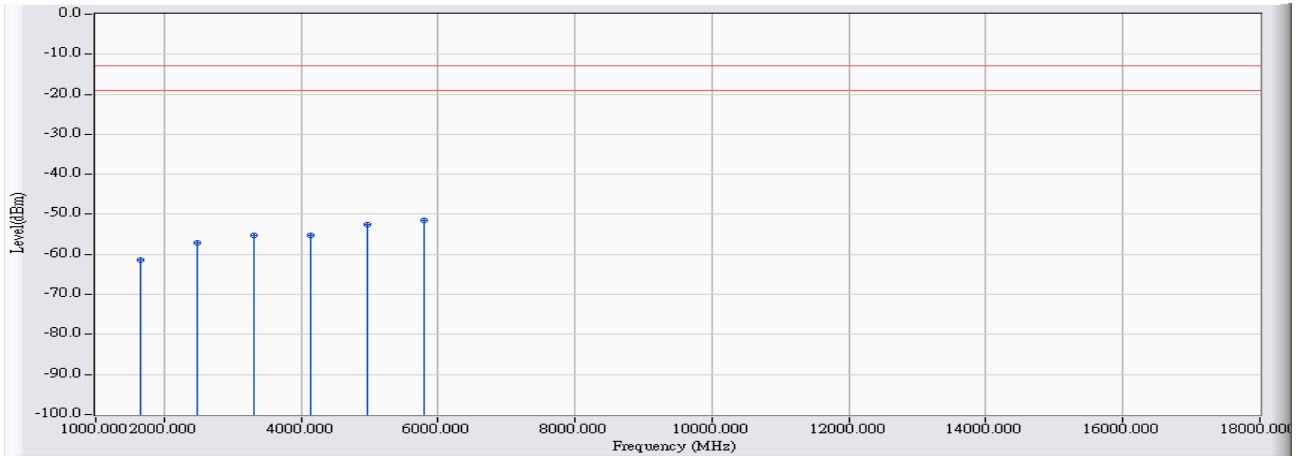

		Frequency (MHz)	Correct Factor (dB)	Reading Level (dBm)	Measure Level (dBm)	Margin (dB)	Limit (dBm)	Detector Type
1		1652.800	5.423	-66.740	-61.316	-48.316	-13.000	PEAK
2		2479.200	9.610	-66.790	-57.181	-44.181	-13.000	PEAK
3		3305.600	11.684	-66.950	-55.266	-42.266	-13.000	PEAK
4		4132.000	12.415	-67.550	-55.135	-42.135	-13.000	PEAK
5		4958.400	15.723	-68.220	-52.496	-39.496	-13.000	PEAK
6	*	5784.800	17.149	-68.660	-51.511	-38.511	-13.000	PEAK

Note:

1. All readings above 1GHz are performed with peak and/or average measurements as necessary.
2. Peak measurements: RBW = 1MHz, VBW = 1MHz, Sweep: Auto.
3. Average measurements: RBW = 1MHz, VBW = 10 Hz, Sweep: Auto.
4. “ * ”, means this data is the worst emission level.
5. Measurement Level = Reading Level + Correct Factor.
6. The average measurement was not performed when the peak measured data under the limit of average detection.
7. The Emission above 18GHz were not included is because their levels are too low.

Site : CB4-H	Time : 2017/02/23
Limit : Part_22/24_00M_PK	Margin : 6
Probe : CB4-H_CE_Sub_B433_1-18GHz_3M_0217 - HORIZONTAL	Power : DC 3.8V
EUT : LE910C1-NA	Note : Mode 13: WCDMA Band 5_HSUPA Mode_Idle 836.6MHz

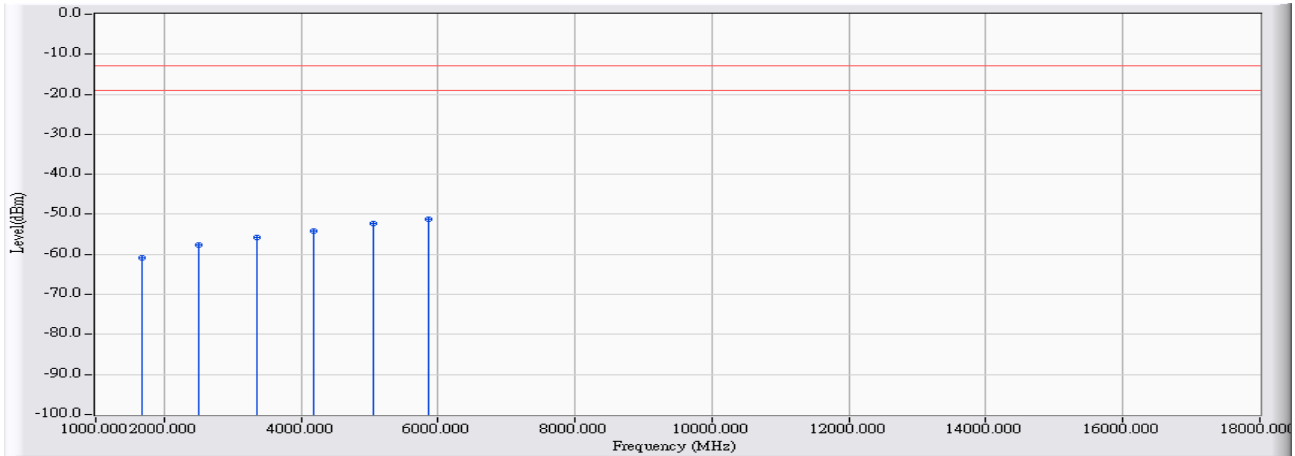

		Frequency (MHz)	Correct Factor (dB)	Reading Level (dBm)	Measure Level (dBm)	Margin (dB)	Limit (dBm)	Detector Type
1		1673.200	5.688	-66.600	-60.912	-47.912	-13.000	PEAK
2		2509.800	9.513	-67.060	-57.547	-44.547	-13.000	PEAK
3		3346.400	11.706	-67.560	-55.854	-42.854	-13.000	PEAK
4		4183.000	12.869	-67.080	-54.211	-41.211	-13.000	PEAK
5		5049.600	15.582	-67.930	-52.348	-39.348	-13.000	PEAK
6	*	5856.200	17.595	-68.710	-51.115	-38.115	-13.000	PEAK

Note:

1. All readings above 1GHz are performed with peak and/or average measurements as necessary.
2. Peak measurements: RBW = 1MHz, VBW = 1MHz, Sweep: Auto.
3. Average measurements: RBW = 1MHz, VBW = 10 Hz, Sweep: Auto.
4. “ * ”, means this data is the worst emission level.
5. Measurement Level = Reading Level + Correct Factor.
6. The average measurement was not performed when the peak measured data under the limit of average detection.
7. The Emission above 18GHz were not included is because their levels are too low.

Site : CB4-H	Time : 2017/02/23
Limit : Part_22/24_00M_PK	Margin : 6
Probe : CB4-H_CE_Sub_B433_1-18GHz_3M_0217 - VERTICAL	Power : DC 3.8V
EUT : LE910C1-NA	Note : Mode 13: WCDMA Band 5_HSUPA Mode_Idle 836.6MHz

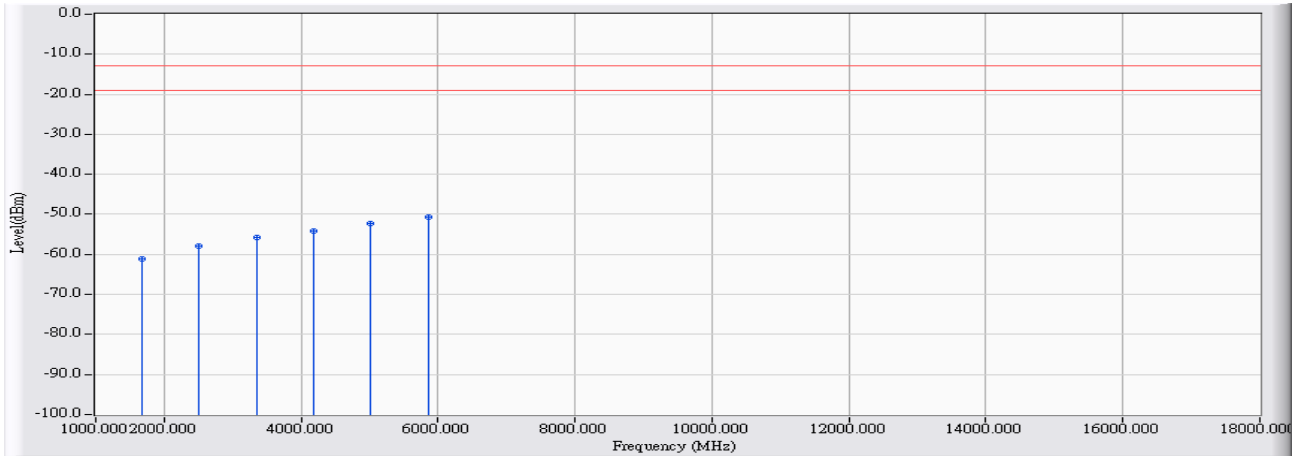

		Frequency (MHz)	Correct Factor (dB)	Reading Level (dBm)	Measure Level (dBm)	Margin (dB)	Limit (dBm)	Detector Type
1		1673.200	5.421	-66.470	-61.049	-48.049	-13.000	PEAK
2		2509.800	9.510	-67.500	-57.990	-44.990	-13.000	PEAK
3		3346.400	11.738	-67.450	-55.713	-42.713	-13.000	PEAK
4		4183.000	12.712	-66.820	-54.108	-41.108	-13.000	PEAK
5		5019.600	15.757	-68.090	-52.333	-39.333	-13.000	PEAK
6	*	5856.200	17.711	-68.450	-50.739	-37.739	-13.000	PEAK

Note:

1. All readings above 1GHz are performed with peak and/or average measurements as necessary.
2. Peak measurements: RBW = 1MHz, VBW = 1MHz, Sweep: Auto.
3. Average measurements: RBW = 1MHz, VBW = 10 Hz, Sweep: Auto.
4. “ * ”, means this data is the worst emission level.
5. Measurement Level = Reading Level + Correct Factor.
6. The average measurement was not performed when the peak measured data under the limit of average detection.
7. The Emission above 18GHz were not included is because their levels are too low.

Site : CB4-H	Time : 2017/02/23
Limit : Part_22/24_00M_PK	Margin : 6
Probe : CB4-H_CE_Sub_B433_1-18GHz_3M_0217 - HORIZONTAL	Power : DC 3.8V
EUT : LE910C1-NA	Note : Mode 13: WCDMA Band 5_HSUPA Mode_Idle 846.6MHz

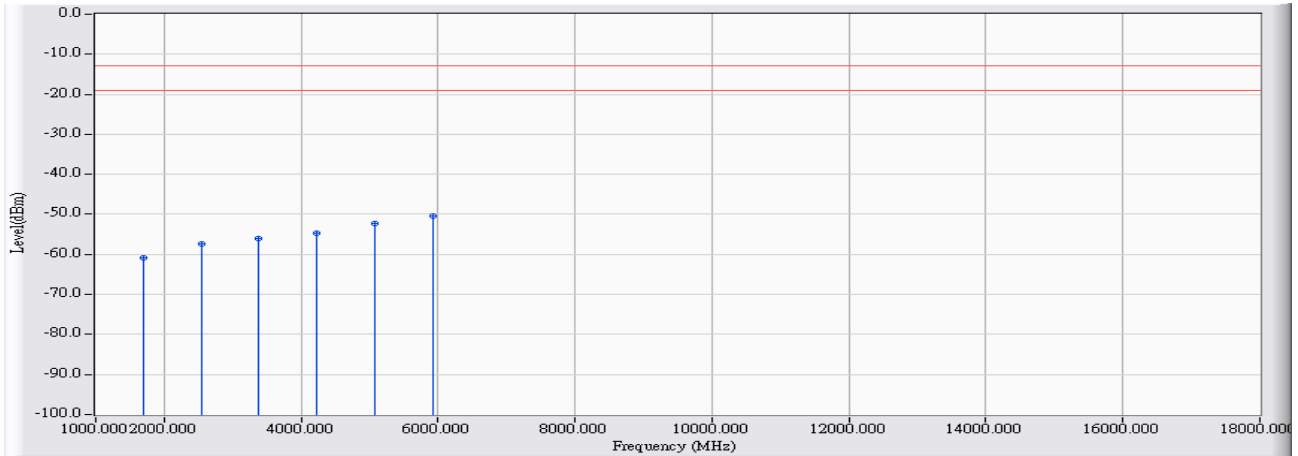

		Frequency (MHz)	Correct Factor (dB)	Reading Level (dBm)	Measure Level (dBm)	Margin (dB)	Limit (dBm)	Detector Type
1		1693.200	5.666	-66.630	-60.964	-47.964	-13.000	PEAK
2		2539.800	9.603	-66.860	-57.257	-44.257	-13.000	PEAK
3		3386.400	11.795	-67.710	-55.916	-42.916	-13.000	PEAK
4		4233.000	12.886	-67.680	-54.794	-41.794	-13.000	PEAK
5		5079.600	15.528	-67.940	-52.412	-39.412	-13.000	PEAK
6	*	5926.200	18.036	-68.360	-50.324	-37.324	-13.000	PEAK

Note:

1. All readings above 1GHz are performed with peak and/or average measurements as necessary.
2. Peak measurements: RBW = 1MHz, VBW = 1MHz, Sweep: Auto.
3. Average measurements: RBW = 1MHz, VBW = 10 Hz, Sweep: Auto.
4. “ * ”, means this data is the worst emission level.
5. Measurement Level = Reading Level + Correct Factor.
6. The average measurement was not performed when the peak measured data under the limit of average detection.
7. The Emission above 18GHz were not included is because their levels are too low.

Site : CB4-H	Time : 2017/02/23
Limit : Part_22/24_00M_PK	Margin : 6
Probe : CB4-H_CE_Sub_B433_1-18GHz_3M_0217 - VERTICAL	Power : DC 3.8V
EUT : LE910C1-NA	Note : Mode 13: WCDMA Band 5_HSUPA Mode_Idle 846.6MHz

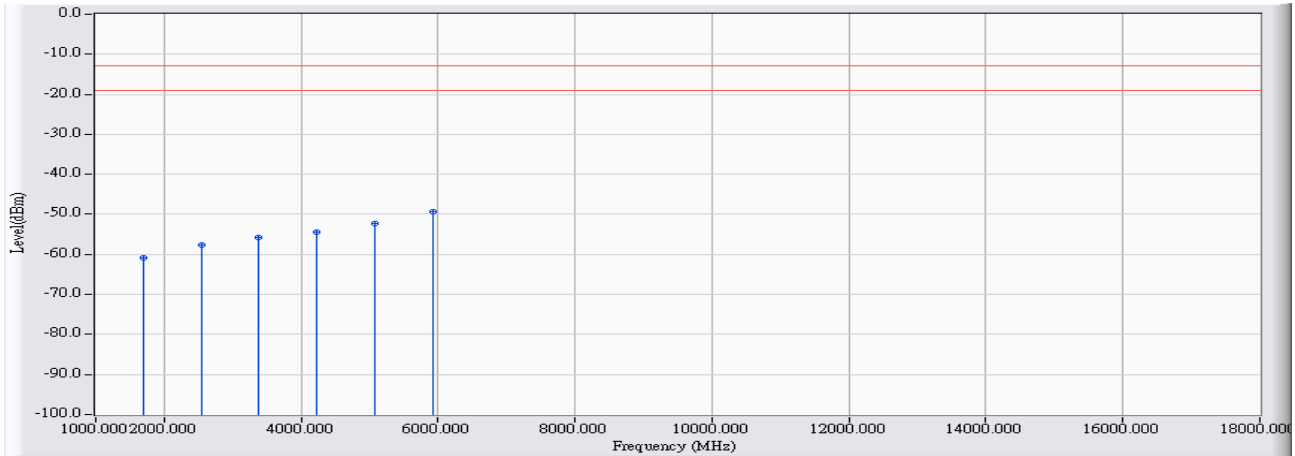

		Frequency (MHz)	Correct Factor (dB)	Reading Level (dBm)	Measure Level (dBm)	Margin (dB)	Limit (dBm)	Detector Type
1		1693.200	5.419	-66.400	-60.981	-47.981	-13.000	PEAK
2		2539.800	9.559	-67.270	-57.711	-44.711	-13.000	PEAK
3		3386.400	11.790	-67.570	-55.781	-42.781	-13.000	PEAK
4		4233.000	13.002	-67.330	-54.327	-41.327	-13.000	PEAK
5		5079.600	15.588	-67.830	-52.242	-39.242	-13.000	PEAK
6	*	5926.200	18.260	-67.580	-49.319	-36.319	-13.000	PEAK

Note:

1. All readings above 1GHz are performed with peak and/or average measurements as necessary.
2. Peak measurements: RBW = 1MHz, VBW = 1MHz, Sweep: Auto.
3. Average measurements: RBW = 1MHz, VBW = 10 Hz, Sweep: Auto.
4. “ * ”, means this data is the worst emission level.
5. Measurement Level = Reading Level + Correct Factor.
6. The average measurement was not performed when the peak measured data under the limit of average detection.
7. The Emission above 18GHz were not included is because their levels are too low.

Site : CB4-H	Time : 2017/02/23
Limit : Part_22/24_00M_PK	Margin : 6
Probe : CB4-H_CE_Sub_B433_1-18GHz_3M_0217 - HORIZONTAL	Power : DC 3.8V
EUT : LE910C1-NA	Note : Mode 14: WCDMA Band 5_HSDPA Mode_Link 826.4MHz

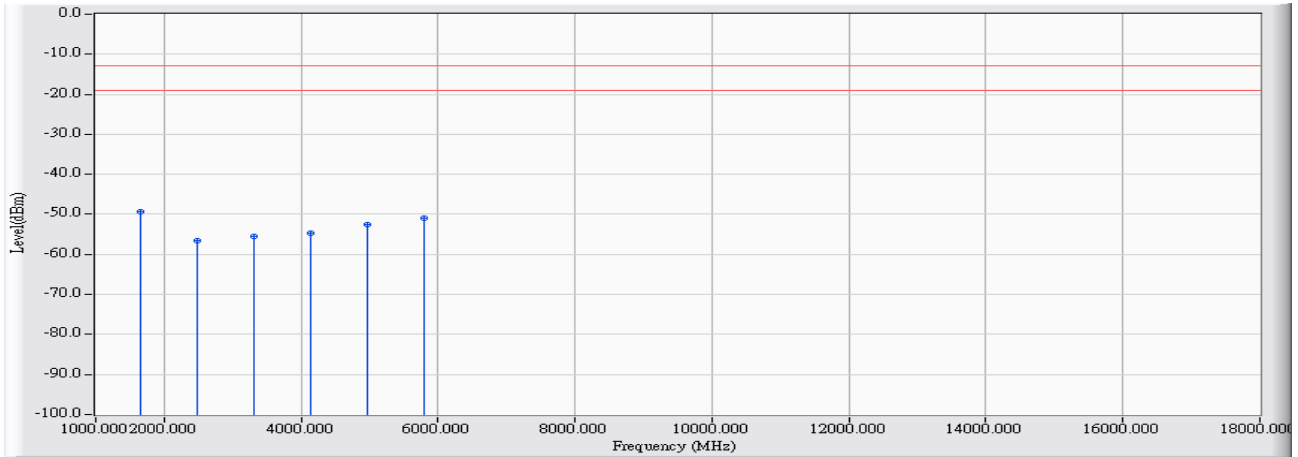

		Frequency (MHz)	Correct Factor (dB)	Reading Level (dBm)	Measure Level (dBm)	Margin (dB)	Limit (dBm)	Detector Type
1	*	1652.800	5.710	-54.930	-49.219	-36.219	-13.000	PEAK
2		2479.200	9.560	-66.050	-56.491	-43.491	-13.000	PEAK
3		3305.600	11.615	-67.130	-55.515	-42.515	-13.000	PEAK
4		4132.000	12.852	-67.590	-54.739	-41.739	-13.000	PEAK
5		4958.400	15.578	-68.250	-52.671	-39.671	-13.000	PEAK
6		5784.800	17.145	-68.060	-50.915	-37.915	-13.000	PEAK

Note:

1. All readings above 1GHz are performed with peak and/or average measurements as necessary.
2. Peak measurements: RBW = 1MHz, VBW = 1MHz, Sweep: Auto.
3. Average measurements: RBW = 1MHz, VBW = 10 Hz, Sweep: Auto.
4. “ * ”, means this data is the worst emission level.
5. Measurement Level = Reading Level + Correct Factor.
6. The average measurement was not performed when the peak measured data under the limit of average detection.
7. The Emission above 18GHz were not included is because their levels are too low.

Site : CB4-H	Time : 2017/02/23
Limit : Part_22/24_00M_PK	Margin : 6
Probe : CB4-H_CE_Sub_B433_1-18GHz_3M_0217 - VERTICAL	Power : DC 3.8V
EUT : LE910C1-NA	Note : Mode 14: WCDMA Band 5_HSDPA Mode_Link 826.4MHz

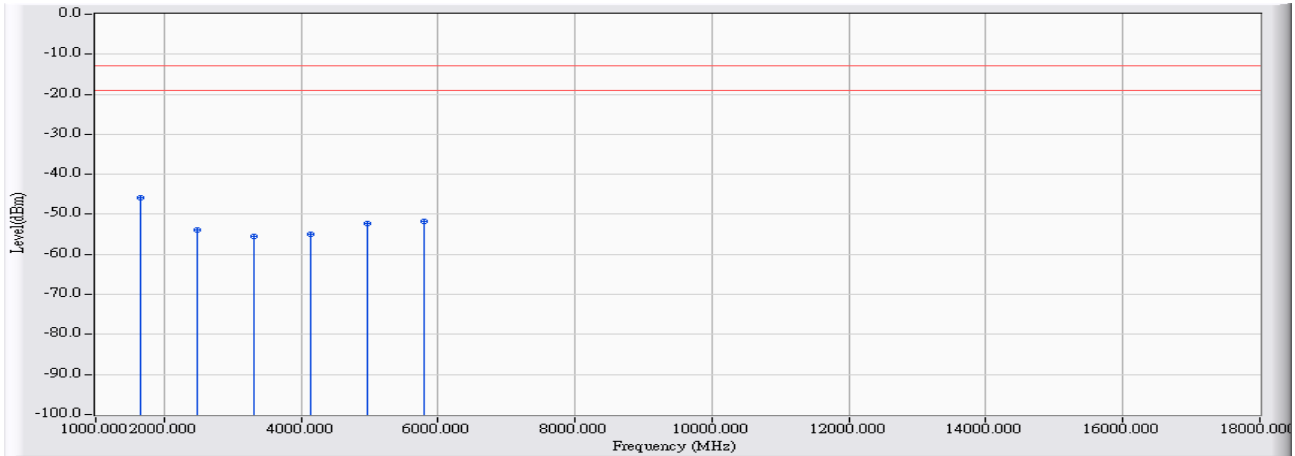

		Frequency (MHz)	Correct Factor (dB)	Reading Level (dBm)	Measure Level (dBm)	Margin (dB)	Limit (dBm)	Detector Type
1	*	1652.800	5.423	-51.250	-45.826	-32.826	-13.000	PEAK
2		2479.200	9.610	-63.510	-53.901	-40.901	-13.000	PEAK
3		3305.600	11.684	-67.240	-55.556	-42.556	-13.000	PEAK
4		4132.000	12.415	-67.280	-54.865	-41.865	-13.000	PEAK
5		4958.400	15.723	-68.000	-52.276	-39.276	-13.000	PEAK
6		5784.800	17.149	-68.810	-51.661	-38.661	-13.000	PEAK

Note:

1. All readings above 1GHz are performed with peak and/or average measurements as necessary.
2. Peak measurements: RBW = 1MHz, VBW = 1MHz, Sweep: Auto.
3. Average measurements: RBW = 1MHz, VBW = 10 Hz, Sweep: Auto.
4. “ * ”, means this data is the worst emission level.
5. Measurement Level = Reading Level + Correct Factor.
6. The average measurement was not performed when the peak measured data under the limit of average detection.
7. The Emission above 18GHz were not included is because their levels are too low.

Site : CB4-H	Time : 2017/02/23
Limit : Part_22/24_00M_PK	Margin : 6
Probe : CB4-H_CE_Sub_B433_1-18GHz_3M_0217 - HORIZONTAL	Power : DC 3.8V
EUT : LE910C1-NA	Note : Mode 14: WCDMA Band 5_HSDPA Mode_Link 836.6MHz

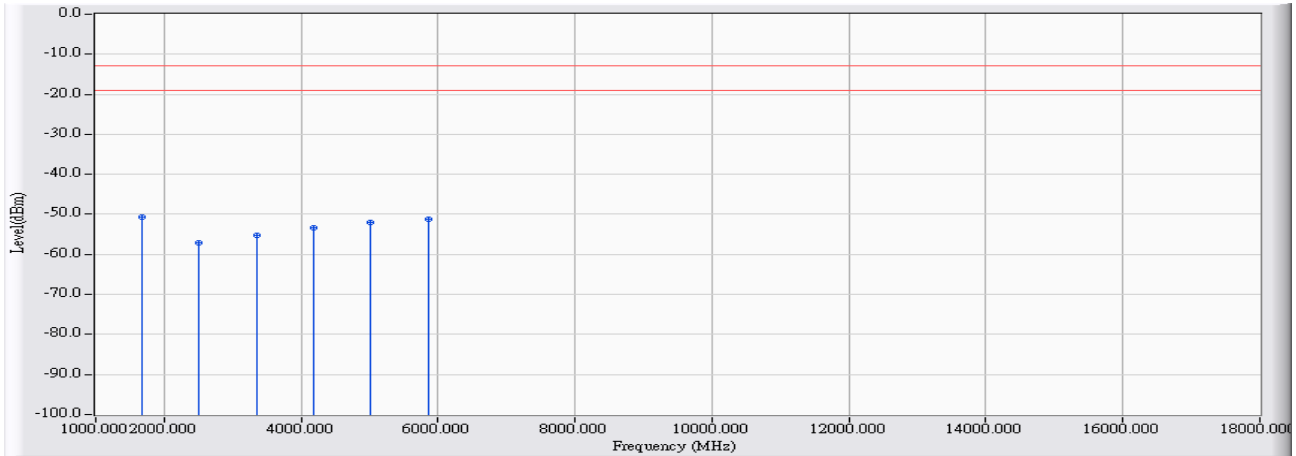

		Frequency (MHz)	Correct Factor (dB)	Reading Level (dBm)	Measure Level (dBm)	Margin (dB)	Limit (dBm)	Detector Type
1	*	1673.200	5.688	-56.280	-50.592	-37.592	-13.000	PEAK
2		2509.800	9.513	-66.530	-57.017	-44.017	-13.000	PEAK
3		3346.400	11.706	-66.970	-55.264	-42.264	-13.000	PEAK
4		4183.000	12.869	-66.320	-53.451	-40.451	-13.000	PEAK
5		5019.600	15.636	-67.540	-51.904	-38.904	-13.000	PEAK
6		5856.200	17.595	-68.790	-51.195	-38.195	-13.000	PEAK

Note:

1. All readings above 1GHz are performed with peak and/or average measurements as necessary.
2. Peak measurements: RBW = 1MHz, VBW = 1MHz, Sweep: Auto.
3. Average measurements: RBW = 1MHz, VBW = 10 Hz, Sweep: Auto.
4. “ * ”, means this data is the worst emission level.
5. Measurement Level = Reading Level + Correct Factor.
6. The average measurement was not performed when the peak measured data under the limit of average detection.
7. The Emission above 18GHz were not included is because their levels are too low.

Site : CB4-H	Time : 2017/02/23
Limit : Part_22/24_00M_PK	Margin : 6
Probe : CB4-H_CE_Sub_B433_1-18GHz_3M_0217 - VERTICAL	Power : DC 3.8V
EUT : LE910C1-NA	Note : Mode 14: WCDMA Band 5_HSDPA Mode_Link 836.6MHz

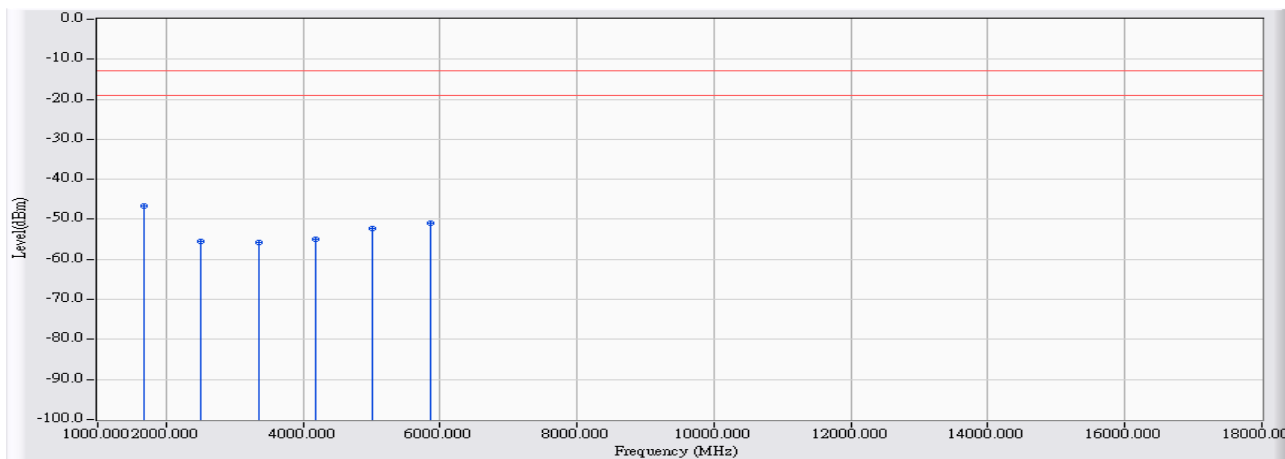

		Frequency (MHz)	Correct Factor (dB)	Reading Level (dBm)	Measure Level (dBm)	Margin (dB)	Limit (dBm)	Detector Type
1	*	1673.200	5.421	-52.110	-46.689	-33.689	-13.000	PEAK
2		2509.800	9.510	-64.900	-55.390	-42.390	-13.000	PEAK
3		3346.400	11.738	-67.610	-55.873	-42.873	-13.000	PEAK
4		4183.000	12.712	-67.540	-54.828	-41.828	-13.000	PEAK
5		5019.600	15.757	-68.040	-52.283	-39.283	-13.000	PEAK
6		5856.200	17.711	-68.600	-50.889	-37.889	-13.000	PEAK

Note:

1. All readings above 1GHz are performed with peak and/or average measurements as necessary.
2. Peak measurements: RBW = 1MHz, VBW = 1MHz, Sweep: Auto.
3. Average measurements: RBW = 1MHz, VBW = 10 Hz, Sweep: Auto.
4. “ * ”, means this data is the worst emission level.
5. Measurement Level = Reading Level + Correct Factor.
6. The average measurement was not performed when the peak measured data under the limit of average detection.
7. The Emission above 18GHz were not included is because their levels are too low.

Site : CB4-H	Time : 2017/02/23
Limit : Part_22/24_00M_PK	Margin : 6
Probe : CB4-H_CE_Sub_B433_1-18GHz_3M_0217 - HORIZONTAL	Power : DC 3.8V
EUT : LE910C1-NA	Note : Mode 14: WCDMA Band 5_HSDPA Mode_Link 846.6MHz

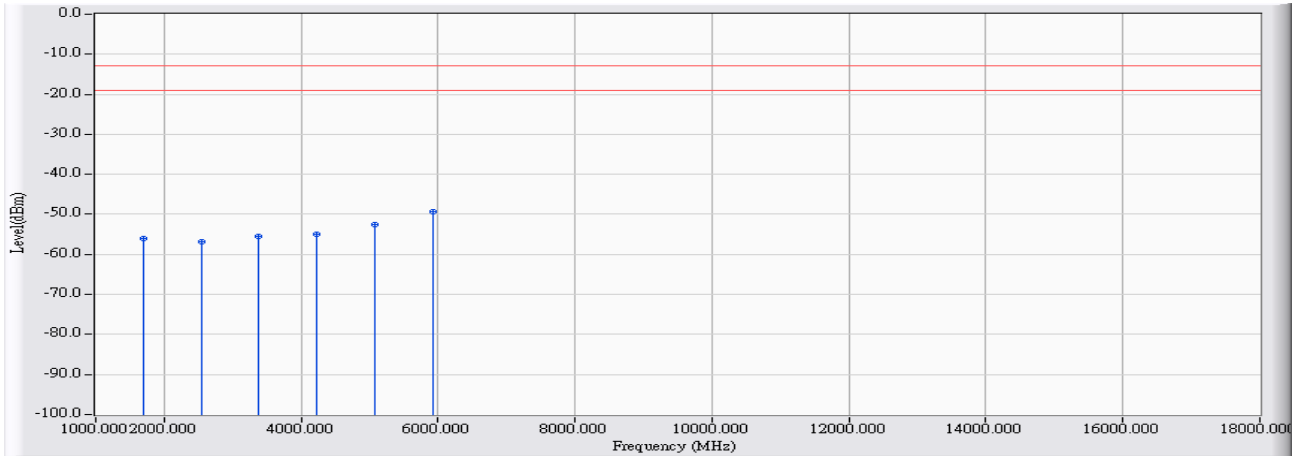

		Frequency (MHz)	Correct Factor (dB)	Reading Level (dBm)	Measure Level (dBm)	Margin (dB)	Limit (dBm)	Detector Type
1		1693.200	5.666	-61.570	-55.904	-42.904	-13.000	PEAK
2		2539.800	9.603	-66.460	-56.857	-43.857	-13.000	PEAK
3		3386.400	11.795	-67.320	-55.526	-42.526	-13.000	PEAK
4		4233.000	12.886	-67.910	-55.024	-42.024	-13.000	PEAK
5		5079.600	15.528	-68.070	-52.542	-39.542	-13.000	PEAK
6	*	5926.200	18.036	-67.320	-49.284	-36.284	-13.000	PEAK

Note:

1. All readings above 1GHz are performed with peak and/or average measurements as necessary.
2. Peak measurements: RBW = 1MHz, VBW = 1MHz, Sweep: Auto.
3. Average measurements: RBW = 1MHz, VBW = 10 Hz, Sweep: Auto.
4. “ * ”, means this data is the worst emission level.
5. Measurement Level = Reading Level + Correct Factor.
6. The average measurement was not performed when the peak measured data under the limit of average detection.
7. The Emission above 18GHz were not included is because their levels are too low.

Site : CB4-H	Time : 2017/02/23
Limit : Part_22/24_00M_PK	Margin : 6
Probe : CB4-H_CE_Sub_B433_1-18GHz_3M_0217 - VERTICAL	Power : DC 3.8V
EUT : LE910C1-NA	Note : Mode 14: WCDMA Band 5_HSDPA Mode_Link 846.6MHz

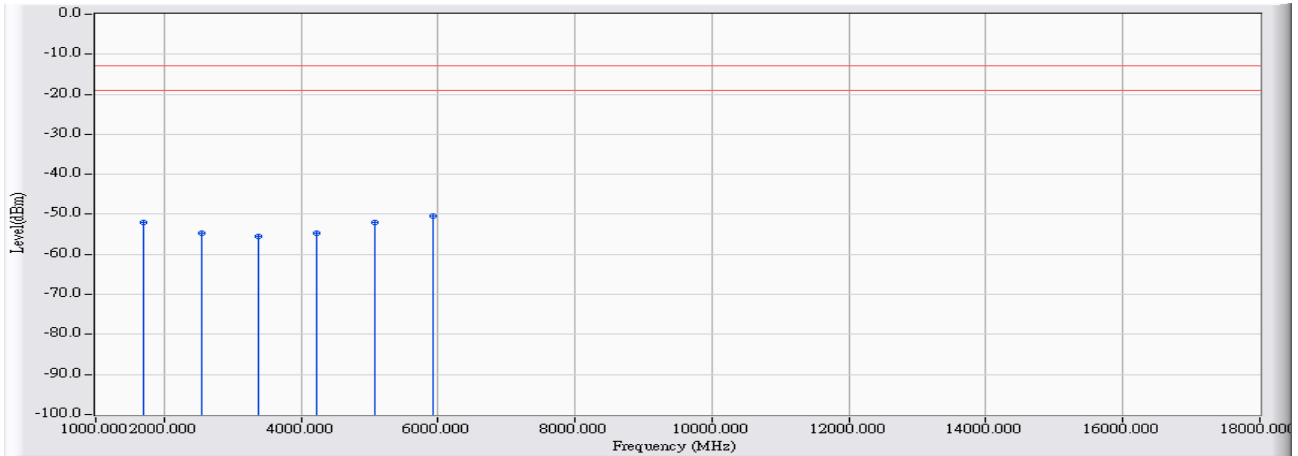

		Frequency (MHz)	Correct Factor (dB)	Reading Level (dBm)	Measure Level (dBm)	Margin (dB)	Limit (dBm)	Detector Type
1		1693.200	5.419	-57.380	-51.961	-38.961	-13.000	PEAK
2		2539.800	9.559	-64.280	-54.721	-41.721	-13.000	PEAK
3		3386.400	11.790	-67.330	-55.541	-42.541	-13.000	PEAK
4		4233.000	13.002	-67.570	-54.567	-41.567	-13.000	PEAK
5		5079.600	15.588	-67.570	-51.982	-38.982	-13.000	PEAK
6	*	5926.200	18.260	-68.680	-50.419	-37.419	-13.000	PEAK

Note:

1. All readings above 1GHz are performed with peak and/or average measurements as necessary.
2. Peak measurements: RBW = 1MHz, VBW = 1MHz, Sweep: Auto.
3. Average measurements: RBW = 1MHz, VBW = 10 Hz, Sweep: Auto.
4. “ * ”, means this data is the worst emission level.
5. Measurement Level = Reading Level + Correct Factor.
6. The average measurement was not performed when the peak measured data under the limit of average detection.
7. The Emission above 18GHz were not included is because their levels are too low.

Site : CB4-H	Time : 2017/02/23
Limit : Part_22/24_00M_PK	Margin : 6
Probe : CB4-H_CE_Sub_B433_1-18GHz_3M_0217 - HORIZONTAL	Power : DC 3.8V
EUT : LE910C1-NA	Note : Mode 14: WCDMA Band 5_HSDPA Mode_Idle 826.4MHz

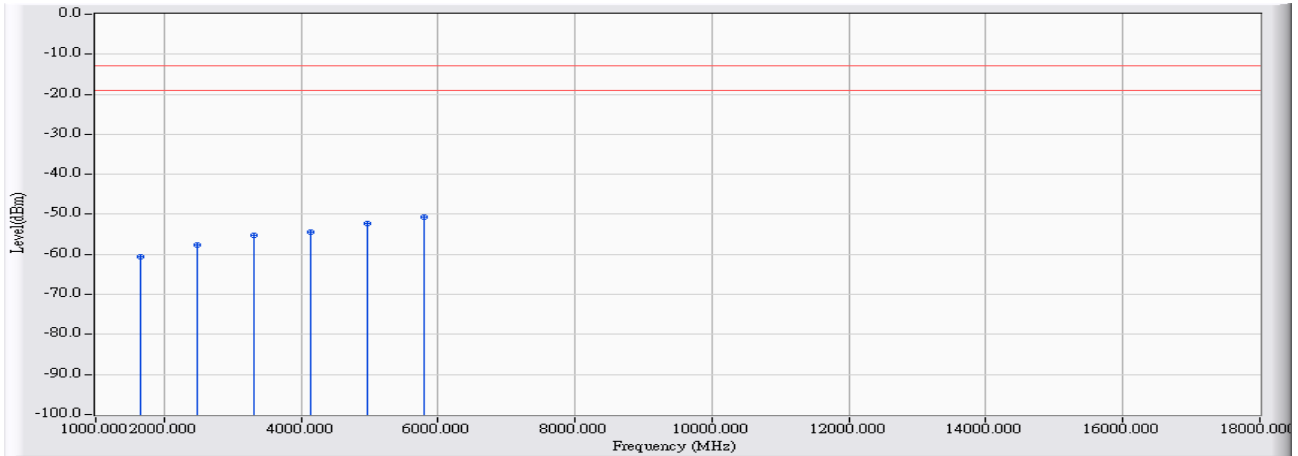

		Frequency (MHz)	Correct Factor (dB)	Reading Level (dBm)	Measure Level (dBm)	Margin (dB)	Limit (dBm)	Detector Type
1		1652.800	5.710	-66.360	-60.649	-47.649	-13.000	PEAK
2		2479.200	9.560	-67.150	-57.591	-44.591	-13.000	PEAK
3		3305.600	11.615	-66.820	-55.205	-42.205	-13.000	PEAK
4		4132.000	12.852	-67.170	-54.319	-41.319	-13.000	PEAK
5		4958.400	15.578	-67.850	-52.271	-39.271	-13.000	PEAK
6	*	5784.800	17.145	-67.700	-50.555	-37.555	-13.000	PEAK

Note:

1. All readings above 1GHz are performed with peak and/or average measurements as necessary.
2. Peak measurements: RBW = 1MHz, VBW = 1MHz, Sweep: Auto.
3. Average measurements: RBW = 1MHz, VBW = 10 Hz, Sweep: Auto.
4. “ * ”, means this data is the worst emission level.
5. Measurement Level = Reading Level + Correct Factor.
6. The average measurement was not performed when the peak measured data under the limit of average detection.
7. The Emission above 18GHz were not included is because their levels are too low.

Site : CB4-H	Time : 2017/02/23
Limit : Part_22/24_00M_PK	Margin : 6
Probe : CB4-H_CE_Sub_B433_1-18GHz_3M_0217 - VERTICAL	Power : DC 3.8V
EUT : LE910C1-NA	Note : Mode 14: WCDMA Band 5_HSDPA Mode_Idle 826.4MHz

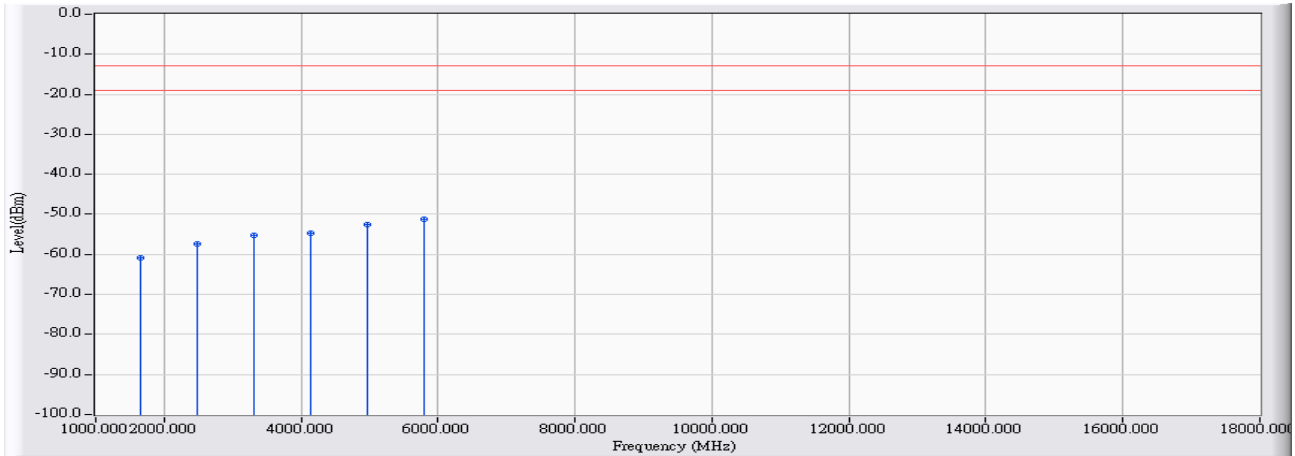

		Frequency (MHz)	Correct Factor (dB)	Reading Level (dBm)	Measure Level (dBm)	Margin (dB)	Limit (dBm)	Detector Type
1		1652.800	5.423	-66.280	-60.856	-47.856	-13.000	PEAK
2		2479.200	9.610	-67.110	-57.501	-44.501	-13.000	PEAK
3		3305.600	11.684	-66.910	-55.226	-42.226	-13.000	PEAK
4		4132.000	12.415	-67.080	-54.665	-41.665	-13.000	PEAK
5		4958.400	15.723	-68.290	-52.566	-39.566	-13.000	PEAK
6	*	5784.800	17.149	-68.350	-51.201	-38.201	-13.000	PEAK

Note:

1. All readings above 1GHz are performed with peak and/or average measurements as necessary.
2. Peak measurements: RBW = 1MHz, VBW = 1MHz, Sweep: Auto.
3. Average measurements: RBW = 1MHz, VBW = 10 Hz, Sweep: Auto.
4. “ * ”, means this data is the worst emission level.
5. Measurement Level = Reading Level + Correct Factor.
6. The average measurement was not performed when the peak measured data under the limit of average detection.
7. The Emission above 18GHz were not included is because their levels are too low.

Site : CB4-H	Time : 2017/02/23
Limit : Part_22/24_00M_PK	Margin : 6
Probe : CB4-H_CE_Sub_B433_1-18GHz_3M_0217 - HORIZONTAL	Power : DC 3.8V
EUT : LE910C1-NA	Note : Mode 14: WCDMA Band 5_HSDPA Mode_Idle 836.6MHz

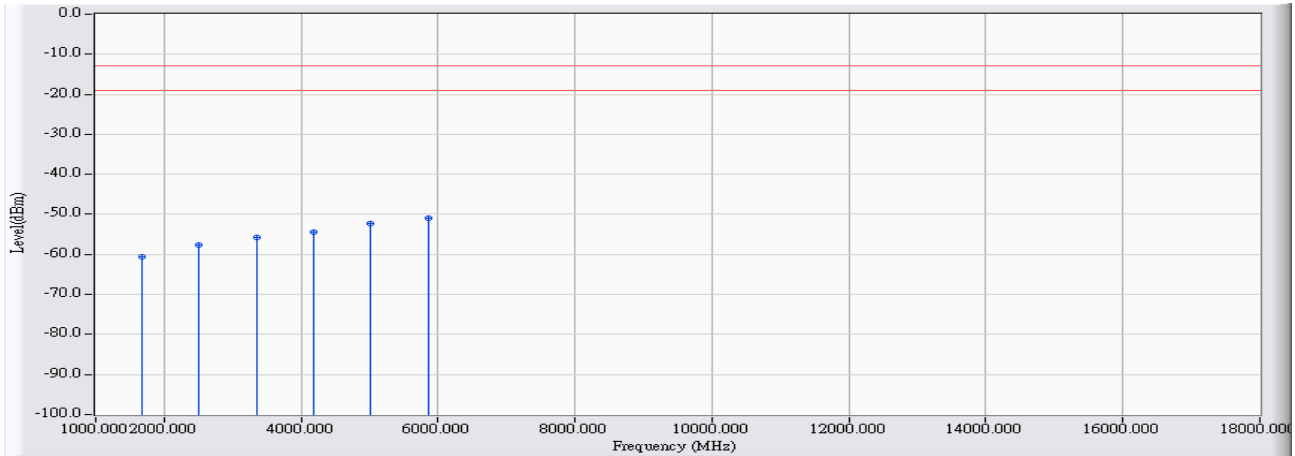

		Frequency (MHz)	Correct Factor (dB)	Reading Level (dBm)	Measure Level (dBm)	Margin (dB)	Limit (dBm)	Detector Type
1		1673.200	5.688	-66.300	-60.612	-47.612	-13.000	PEAK
2		2509.800	9.513	-67.150	-57.637	-44.637	-13.000	PEAK
3		3346.400	11.706	-67.480	-55.774	-42.774	-13.000	PEAK
4		4183.000	12.869	-67.300	-54.431	-41.431	-13.000	PEAK
5		5019.600	15.636	-67.850	-52.214	-39.214	-13.000	PEAK
6	*	5856.200	17.595	-68.640	-51.045	-38.045	-13.000	PEAK

Note:

1. All readings above 1GHz are performed with peak and/or average measurements as necessary.
2. Peak measurements: RBW = 1MHz, VBW = 1MHz, Sweep: Auto.
3. Average measurements: RBW = 1MHz, VBW = 10 Hz, Sweep: Auto.
4. “ * ”, means this data is the worst emission level.
5. Measurement Level = Reading Level + Correct Factor.
6. The average measurement was not performed when the peak measured data under the limit of average detection.
7. The Emission above 18GHz were not included is because their levels are too low.

Site : CB4-H	Time : 2017/02/23
Limit : Part_22/24_00M_PK	Margin : 6
Probe : CB4-H_CE_Sub_B433_1-18GHz_3M_0217 - VERTICAL	Power : DC 3.8V
EUT : LE910C1-NA	Note : Mode 14: WCDMA Band 5_HSDPA Mode_Idle 836.6MHz

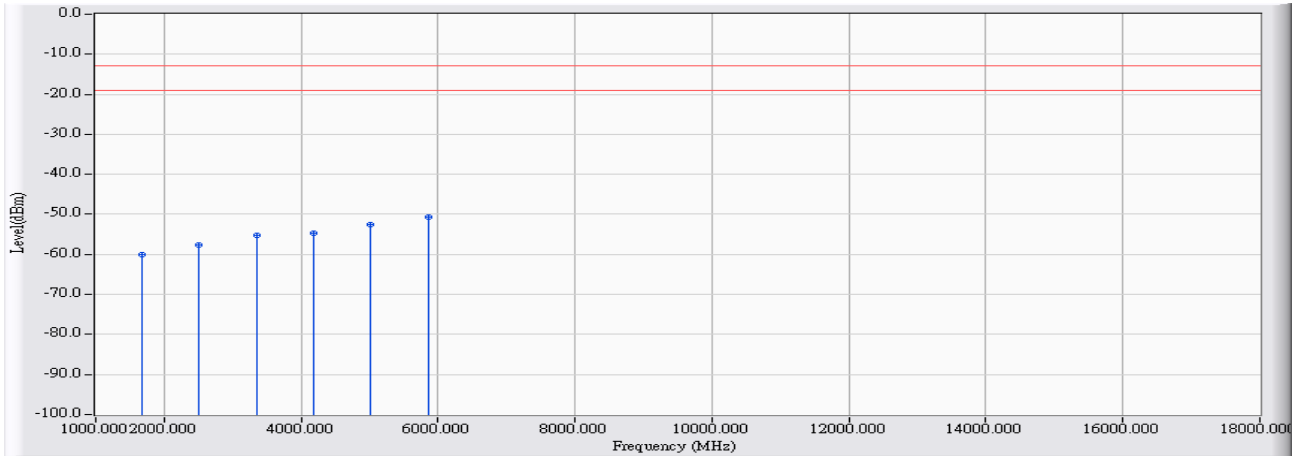

		Frequency (MHz)	Correct Factor (dB)	Reading Level (dBm)	Measure Level (dBm)	Margin (dB)	Limit (dBm)	Detector Type
1		1673.200	5.421	-65.470	-60.049	-47.049	-13.000	PEAK
2		2509.800	9.510	-67.030	-57.520	-44.520	-13.000	PEAK
3		3346.400	11.738	-66.880	-55.143	-42.143	-13.000	PEAK
4		4183.000	12.712	-67.380	-54.668	-41.668	-13.000	PEAK
5		5019.600	15.757	-68.310	-52.553	-39.553	-13.000	PEAK
6	*	5856.200	17.711	-68.320	-50.609	-37.609	-13.000	PEAK

Note:

1. All readings above 1GHz are performed with peak and/or average measurements as necessary.
2. Peak measurements: RBW = 1MHz, VBW = 1MHz, Sweep: Auto.
3. Average measurements: RBW = 1MHz, VBW = 10 Hz, Sweep: Auto.
4. “ * ”, means this data is the worst emission level.
5. Measurement Level = Reading Level + Correct Factor.
6. The average measurement was not performed when the peak measured data under the limit of average detection.
7. The Emission above 18GHz were not included is because their levels are too low.

Site : CB4-H	Time : 2017/02/23
Limit : Part_22/24_00M_PK	Margin : 6
Probe : CB4-H_CE_Sub_B433_1-18GHz_3M_0217 - HORIZONTAL	Power : DC 3.8V
EUT : LE910C1-NA	Note : Mode 14: WCDMA Band 5_HSDPA Mode_Idle 846.6MHz

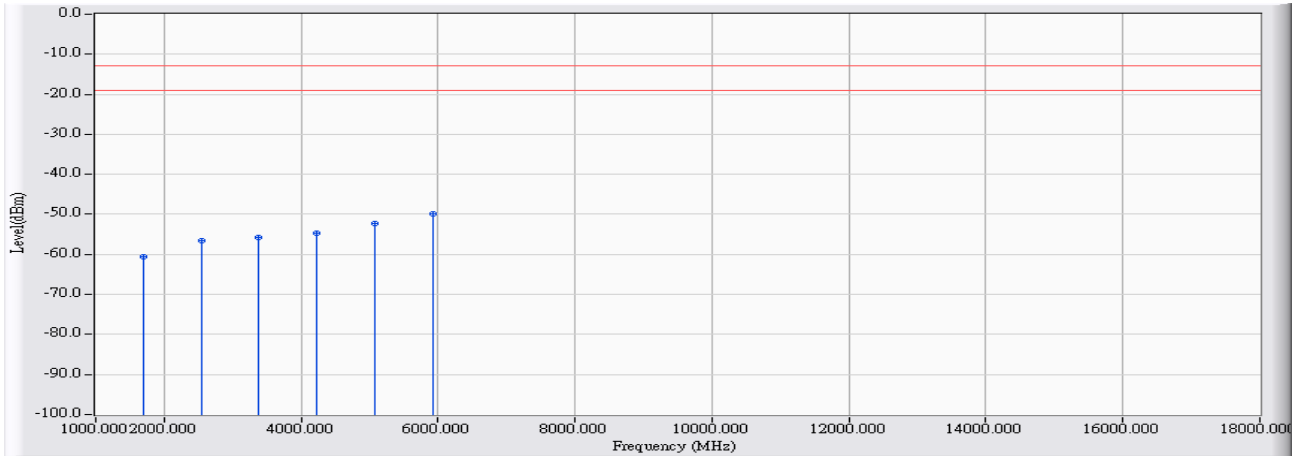

		Frequency (MHz)	Correct Factor (dB)	Reading Level (dBm)	Measure Level (dBm)	Margin (dB)	Limit (dBm)	Detector Type
1		1693.200	5.666	-66.130	-60.464	-47.464	-13.000	PEAK
2		2539.800	9.603	-66.240	-56.637	-43.637	-13.000	PEAK
3		3386.400	11.795	-67.650	-55.856	-42.856	-13.000	PEAK
4		4233.000	12.886	-67.670	-54.784	-41.784	-13.000	PEAK
5		5079.600	15.528	-67.900	-52.372	-39.372	-13.000	PEAK
6	*	5926.200	18.036	-68.020	-49.984	-36.984	-13.000	PEAK

Note:

1. All readings above 1GHz are performed with peak and/or average measurements as necessary.
2. Peak measurements: RBW = 1MHz, VBW = 1MHz, Sweep: Auto.
3. Average measurements: RBW = 1MHz, VBW = 10 Hz, Sweep: Auto.
4. “ * ”, means this data is the worst emission level.
5. Measurement Level = Reading Level + Correct Factor.
6. The average measurement was not performed when the peak measured data under the limit of average detection.
7. The Emission above 18GHz were not included is because their levels are too low.

Site : CB4-H	Time : 2017/02/23
Limit : Part_22/24_00M_PK	Margin : 6
Probe : CB4-H_CE_Sub_B433_1-18GHz_3M_0217 - VERTICAL	Power : DC 3.8V
EUT : LE910C1-NA	Note : Mode 14: WCDMA Band 5_HSDPA Mode_Idle 846.6MHz

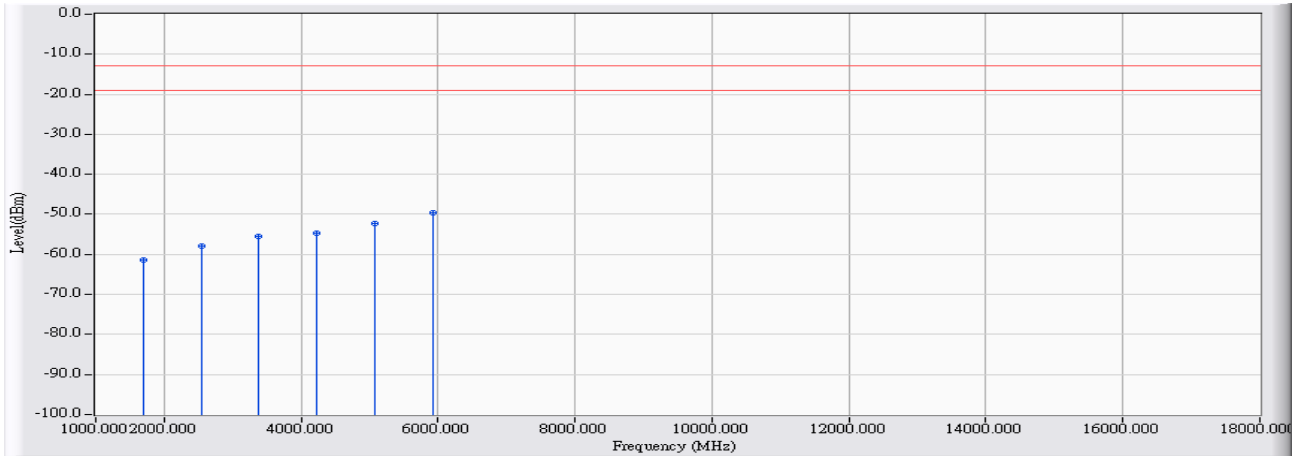

		Frequency (MHz)	Correct Factor (dB)	Reading Level (dBm)	Measure Level (dBm)	Margin (dB)	Limit (dBm)	Detector Type
1		1693.200	5.419	-66.720	-61.301	-48.301	-13.000	PEAK
2		2539.800	9.559	-67.390	-57.831	-44.831	-13.000	PEAK
3		3386.400	11.790	-67.200	-55.411	-42.411	-13.000	PEAK
4		4233.000	13.002	-67.690	-54.687	-41.687	-13.000	PEAK
5		5079.600	15.588	-67.950	-52.362	-39.362	-13.000	PEAK
6	*	5926.200	18.260	-67.730	-49.469	-36.469	-13.000	PEAK

Note:

1. All readings above 1GHz are performed with peak and/or average measurements as necessary.
2. Peak measurements: RBW = 1MHz, VBW = 1MHz, Sweep: Auto.
3. Average measurements: RBW = 1MHz, VBW = 10 Hz, Sweep: Auto.
4. “ * ”, means this data is the worst emission level.
5. Measurement Level = Reading Level + Correct Factor.
6. The average measurement was not performed when the peak measured data under the limit of average detection.
7. The Emission above 18GHz were not included is because their levels are too low.

Site : CB4-H	Time : 2017/02/23
Limit : Part_22/24_00M_PK	Margin : 6
Probe : CB4-H_CE_Sub_B433_1-18GHz_3M_0217 - HORIZONTAL	Power : DC 3.8V
EUT : LE910C1-NA	Note : Mode 15: WCDMA Band 2_HSUPA Mode_Link 1852.4MHz

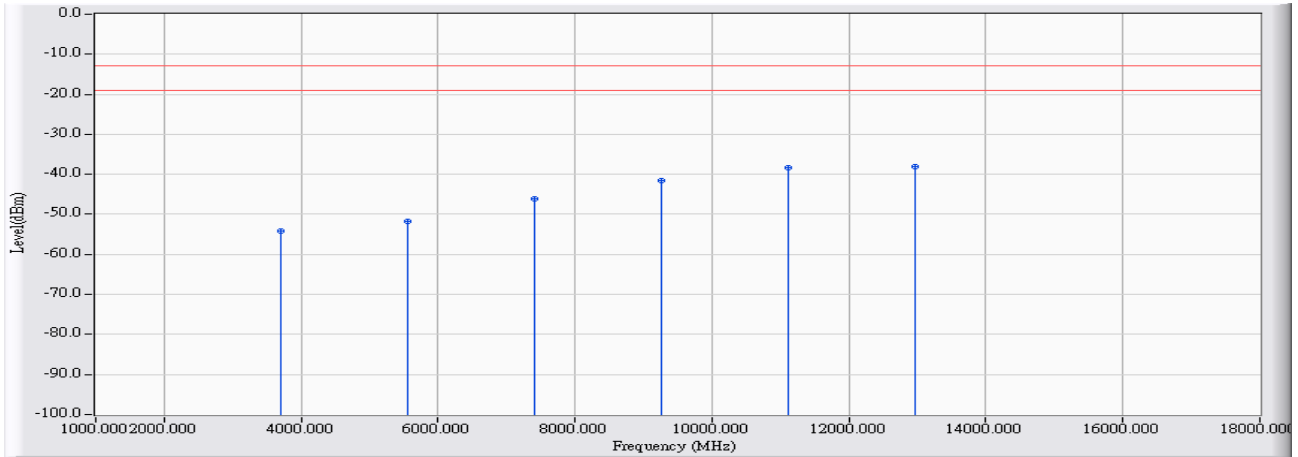

		Frequency (MHz)	Correct Factor (dB)	Reading Level (dBm)	Measure Level (dBm)	Margin (dB)	Limit (dBm)	Detector Type
1		3704.800	12.264	-66.550	-54.286	-41.286	-13.000	PEAK
2		5557.200	16.467	-68.090	-51.623	-38.623	-13.000	PEAK
3		7409.600	23.598	-69.720	-46.122	-33.122	-13.000	PEAK
4		9262.000	28.552	-70.080	-41.529	-28.529	-13.000	PEAK
5		11114.400	33.261	-71.540	-38.279	-25.279	-13.000	PEAK
6	*	12966.800	33.164	-71.270	-38.105	-25.105	-13.000	PEAK

Note:

1. All readings above 1GHz are performed with peak and/or average measurements as necessary.
2. Peak measurements: RBW = 1MHz, VBW = 1MHz, Sweep: Auto.
3. Average measurements: RBW = 1MHz, VBW = 10 Hz, Sweep: Auto.
4. “ * ”, means this data is the worst emission level.
5. Measurement Level = Reading Level + Correct Factor.
6. The average measurement was not performed when the peak measured data under the limit of average detection.
7. The Emission above 18GHz were not included is because their levels are too low.

Site : CB4-H	Time : 2017/02/23
Limit : Part_22/24_00M_PK	Margin : 6
Probe : CB4-H_CE_Sub_B433_1-18GHz_3M_0217 - VERTICAL	Power : DC 3.8V
EUT : LE910C1-NA	Note : Mode 15: WCDMA Band 2_HSUPA Mode_Link 1852.4MHz

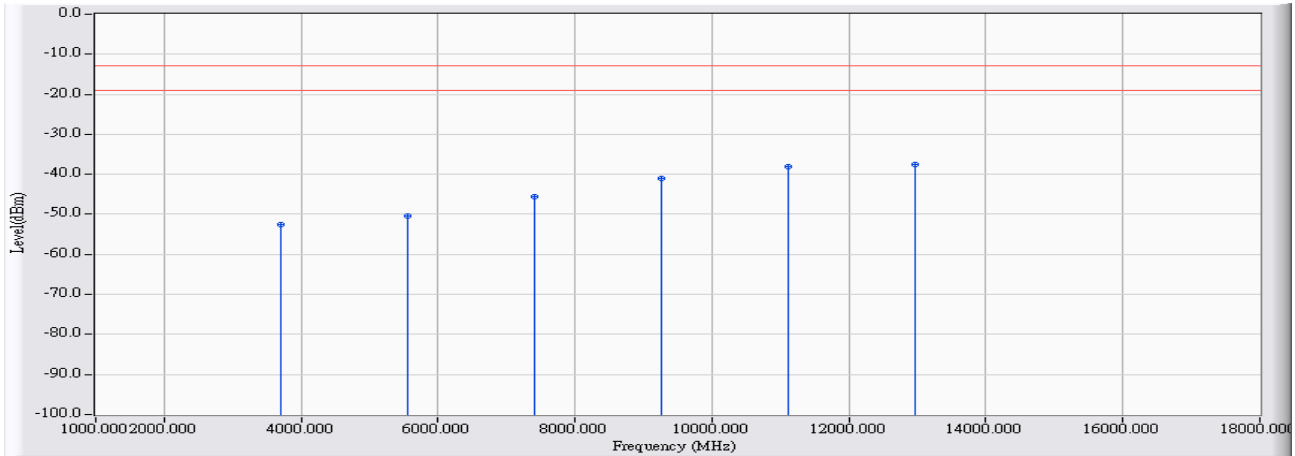

		Frequency (MHz)	Correct Factor (dB)	Reading Level (dBm)	Measure Level (dBm)	Margin (dB)	Limit (dBm)	Detector Type
1		3704.800	12.187	-64.810	-52.623	-39.623	-13.000	PEAK
2		5557.200	16.549	-66.900	-50.352	-37.352	-13.000	PEAK
3		7409.600	23.726	-69.420	-45.695	-32.695	-13.000	PEAK
4		9262.000	28.604	-69.660	-41.057	-28.057	-13.000	PEAK
5		11114.400	33.327	-71.370	-38.044	-25.044	-13.000	PEAK
6	*	12966.800	33.624	-71.280	-37.655	-24.655	-13.000	PEAK

Note:

1. All readings above 1GHz are performed with peak and/or average measurements as necessary.
2. Peak measurements: RBW = 1MHz, VBW = 1MHz, Sweep: Auto.
3. Average measurements: RBW = 1MHz, VBW = 10 Hz, Sweep: Auto.
4. “ * ”, means this data is the worst emission level.
5. Measurement Level = Reading Level + Correct Factor.
6. The average measurement was not performed when the peak measured data under the limit of average detection.
7. The Emission above 18GHz were not included is because their levels are too low.

Site : CB4-H	Time : 2017/02/23
Limit : Part_22/24_00M_PK	Margin : 6
Probe : CB4-H_CE_Sub_B433_1-18GHz_3M_0217 - HORIZONTAL	Power : DC 3.8V
EUT : LE910C1-NA	Note : Mode 15: WCDMA Band 2_HSUPA Mode_Link 1880MHz

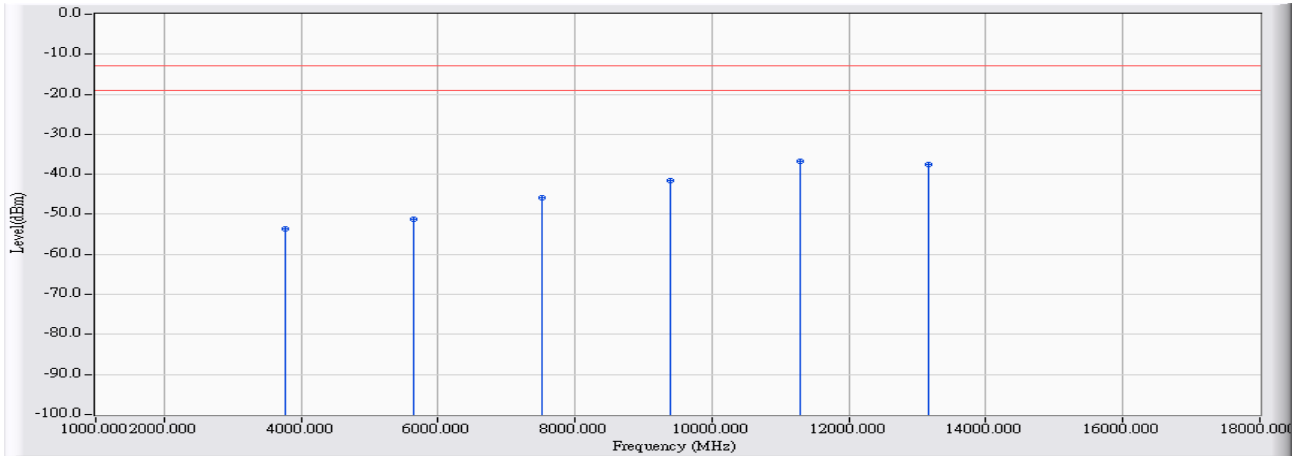

		Frequency (MHz)	Correct Factor (dB)	Reading Level (dBm)	Measure Level (dBm)	Margin (dB)	Limit (dBm)	Detector Type
1		3760.000	12.331	-65.880	-53.549	-40.549	-13.000	PEAK
2		5640.000	16.663	-67.900	-51.236	-38.236	-13.000	PEAK
3		7520.000	23.544	-69.490	-45.946	-32.946	-13.000	PEAK
4		9400.000	28.736	-70.170	-41.434	-28.434	-13.000	PEAK
5	*	11280.000	33.758	-70.480	-36.722	-23.722	-13.000	PEAK
6		13160.000	32.895	-70.460	-37.566	-24.566	-13.000	PEAK

Note:

1. All readings above 1GHz are performed with peak and/or average measurements as necessary.
2. Peak measurements: RBW = 1MHz, VBW = 1MHz, Sweep: Auto.
3. Average measurements: RBW = 1MHz, VBW = 10 Hz, Sweep: Auto.
4. “ * ”, means this data is the worst emission level.
5. Measurement Level = Reading Level + Correct Factor.
6. The average measurement was not performed when the peak measured data under the limit of average detection.
7. The Emission above 18GHz were not included is because their levels are too low.

Site : CB4-H	Time : 2017/02/23
Limit : Part_22/24_00M_PK	Margin : 6
Probe : CB4-H_CE_Sub_B433_1-18GHz_3M_0217 - VERTICAL	Power : DC 3.8V
EUT : LE910C1-NA	Note : Mode 15: WCDMA Band 2_HSUPA Mode_Link 1880MHz

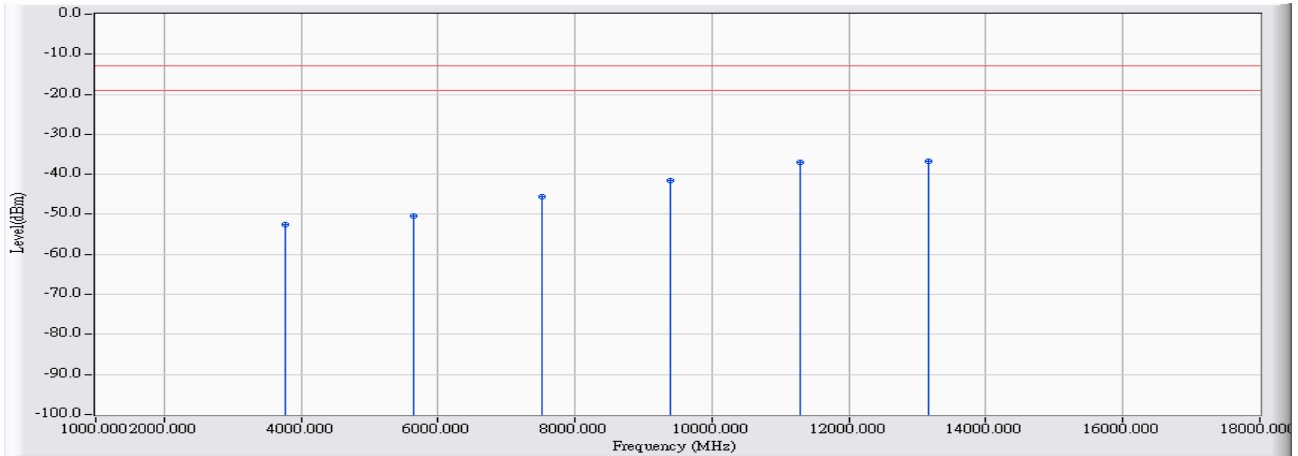

		Frequency (MHz)	Correct Factor (dB)	Reading Level (dBm)	Measure Level (dBm)	Margin (dB)	Limit (dBm)	Detector Type
1		3760.000	12.217	-64.730	-52.512	-39.512	-13.000	PEAK
2		5640.000	16.688	-67.070	-50.381	-37.381	-13.000	PEAK
3		7520.000	23.734	-69.210	-45.476	-32.476	-13.000	PEAK
4		9400.000	28.694	-70.380	-41.686	-28.686	-13.000	PEAK
5		11280.000	33.863	-70.870	-37.007	-24.007	-13.000	PEAK
6	*	13160.000	33.279	-69.960	-36.682	-23.682	-13.000	PEAK

Note:

1. All readings above 1GHz are performed with peak and/or average measurements as necessary.
2. Peak measurements: RBW = 1MHz, VBW = 1MHz, Sweep: Auto.
3. Average measurements: RBW = 1MHz, VBW = 10 Hz, Sweep: Auto.
4. “ * ”, means this data is the worst emission level.
5. Measurement Level = Reading Level + Correct Factor.
6. The average measurement was not performed when the peak measured data under the limit of average detection.
7. The Emission above 18GHz were not included is because their levels are too low.

Site : CB4-H	Time : 2017/02/23
Limit : Part_22/24_00M_PK	Margin : 6
Probe : CB4-H_CE_Sub_B433_1-18GHz_3M_0217 - HORIZONTAL	Power : DC 3.8V
EUT : LE910C1-NA	Note : Mode 15: WCDMA Band 2_HSUPA Mode_Link 1907.6MHz

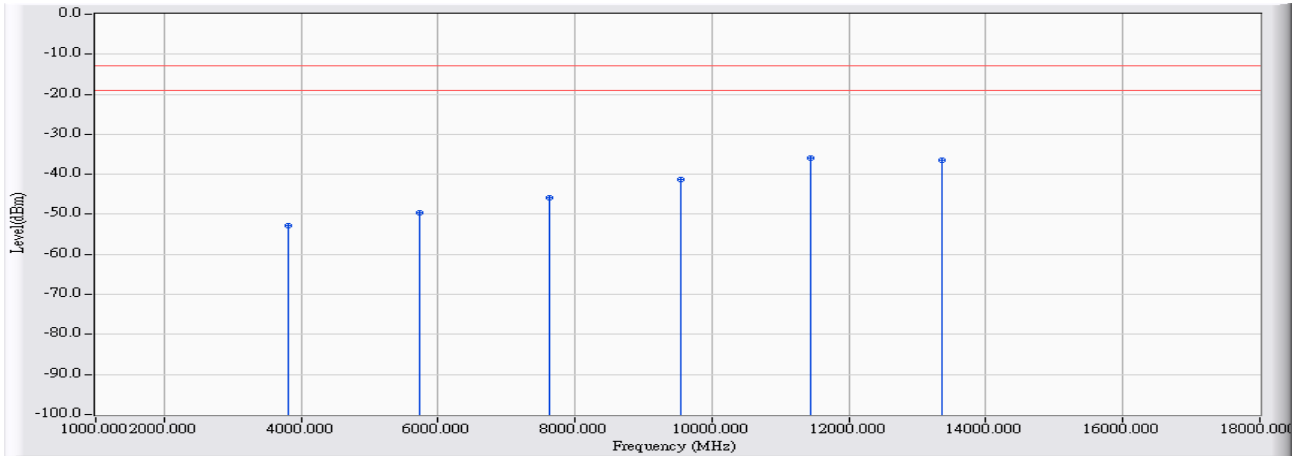

		Frequency (MHz)	Correct Factor (dB)	Reading Level (dBm)	Measure Level (dBm)	Margin (dB)	Limit (dBm)	Detector Type
1		3815.200	12.440	-65.200	-52.760	-39.760	-13.000	PEAK
2		5722.800	16.861	-66.580	-49.719	-36.719	-13.000	PEAK
3		7630.400	23.397	-69.210	-45.814	-32.814	-13.000	PEAK
4		9538.000	29.014	-70.420	-41.406	-28.406	-13.000	PEAK
5	*	11445.600	34.890	-70.870	-35.980	-22.980	-13.000	PEAK
6		13353.200	33.373	-69.760	-36.387	-23.387	-13.000	PEAK

Note:

1. All readings above 1GHz are performed with peak and/or average measurements as necessary.
2. Peak measurements: RBW = 1MHz, VBW = 1MHz, Sweep: Auto.
3. Average measurements: RBW = 1MHz, VBW = 10 Hz, Sweep: Auto.
4. “ * ”, means this data is the worst emission level.
5. Measurement Level = Reading Level + Correct Factor.
6. The average measurement was not performed when the peak measured data under the limit of average detection.
7. The Emission above 18GHz were not included is because their levels are too low.

Site : CB4-H	Time : 2017/02/23
Limit : Part_22/24_00M_PK	Margin : 6
Probe : CB4-H_CE_Sub_B433_1-18GHz_3M_0217 - VERTICAL	Power : DC 3.8V
EUT : LE910C1-NA	Note : Mode 15: WCDMA Band 2_HSUPA Mode_Link 1907.6MHz

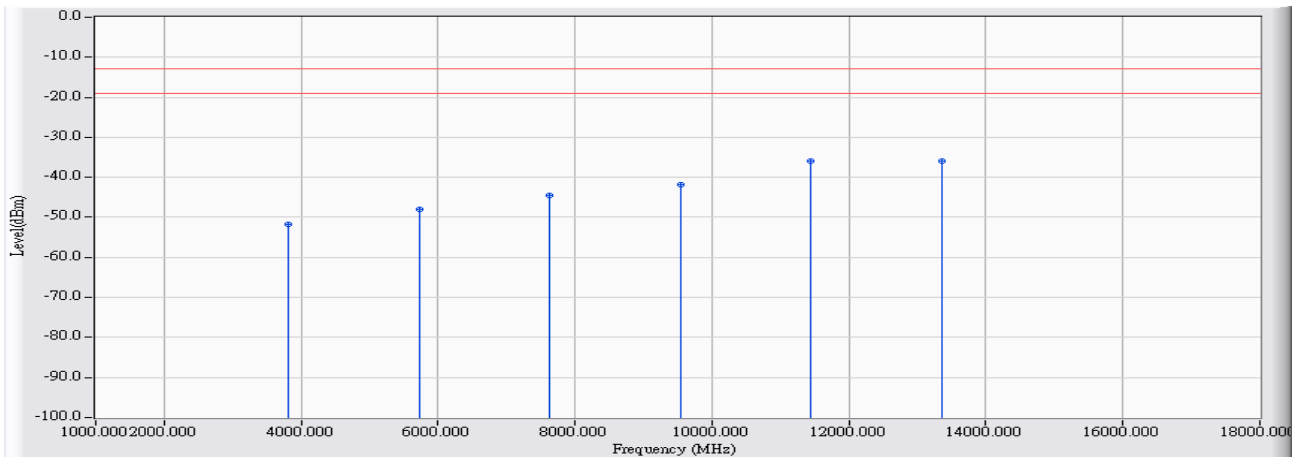

		Frequency (MHz)	Correct Factor (dB)	Reading Level (dBm)	Measure Level (dBm)	Margin (dB)	Limit (dBm)	Detector Type
1		3815.200	12.086	-63.730	-51.644	-38.644	-13.000	PEAK
2		5722.800	16.829	-64.930	-48.100	-35.100	-13.000	PEAK
3		7630.400	23.529	-68.010	-44.482	-31.482	-13.000	PEAK
4		9538.000	28.847	-70.610	-41.762	-28.762	-13.000	PEAK
5		11445.600	34.909	-70.850	-35.942	-22.942	-13.000	PEAK
6	*	13353.200	33.701	-69.500	-35.800	-22.800	-13.000	PEAK

Note:

1. All readings above 1GHz are performed with peak and/or average measurements as necessary.
2. Peak measurements: RBW = 1MHz, VBW = 1MHz, Sweep: Auto.
3. Average measurements: RBW = 1MHz, VBW = 10 Hz, Sweep: Auto.
4. “ * ”, means this data is the worst emission level.
5. Measurement Level = Reading Level + Correct Factor.
6. The average measurement was not performed when the peak measured data under the limit of average detection.
7. The Emission above 18GHz were not included is because their levels are too low.

Site : CB4-H	Time : 2017/02/23
Limit : Part_22/24_00M_PK	Margin : 6
Probe : CB4-H_CE_Sub_B433_1-18GHz_3M_0217 - HORIZONTAL	Power : DC 3.8V
EUT : LE910C1-NA	Note : Mode 15: WCDMA Band 2_HSUPA Mode_Idle 1852.4MHz

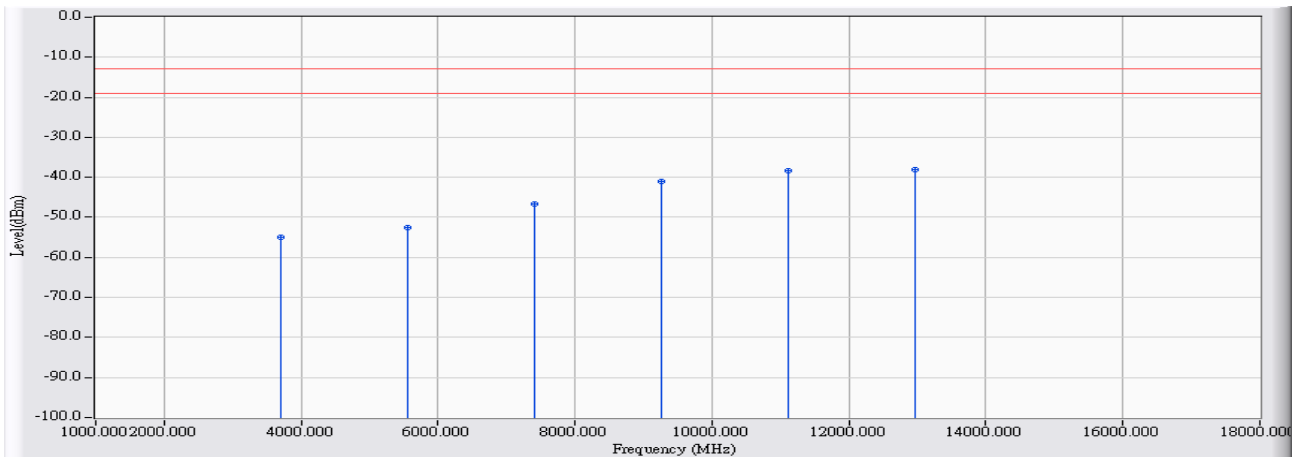

		Frequency (MHz)	Correct Factor (dB)	Reading Level (dBm)	Measure Level (dBm)	Margin (dB)	Limit (dBm)	Detector Type
1		3704.800	12.264	-67.150	-54.886	-41.886	-13.000	PEAK
2		5557.200	16.467	-69.020	-52.553	-39.553	-13.000	PEAK
3		7409.600	23.598	-70.370	-46.772	-33.772	-13.000	PEAK
4		9262.000	28.552	-69.540	-40.989	-27.989	-13.000	PEAK
5		11114.400	33.261	-71.590	-38.329	-25.329	-13.000	PEAK
6	*	12966.800	33.164	-71.280	-38.115	-25.115	-13.000	PEAK

Note:

1. All readings above 1GHz are performed with peak and/or average measurements as necessary.
2. Peak measurements: RBW = 1MHz, VBW = 1MHz, Sweep: Auto.
3. Average measurements: RBW = 1MHz, VBW = 10 Hz, Sweep: Auto.
4. “ * ”, means this data is the worst emission level.
5. Measurement Level = Reading Level + Correct Factor.
6. The average measurement was not performed when the peak measured data under the limit of average detection.
7. The Emission above 18GHz were not included is because their levels are too low.

Site : CB4-H	Time : 2017/02/23
Limit : Part_22/24_00M_PK	Margin : 6
Probe : CB4-H_CE_Sub_B433_1-18GHz_3M_0217 - VERTICAL	Power : DC 3.8V
EUT : LE910C1-NA	Note : Mode 15: WCDMA Band 2_HSUPA Mode_Idle 1852.4MHz

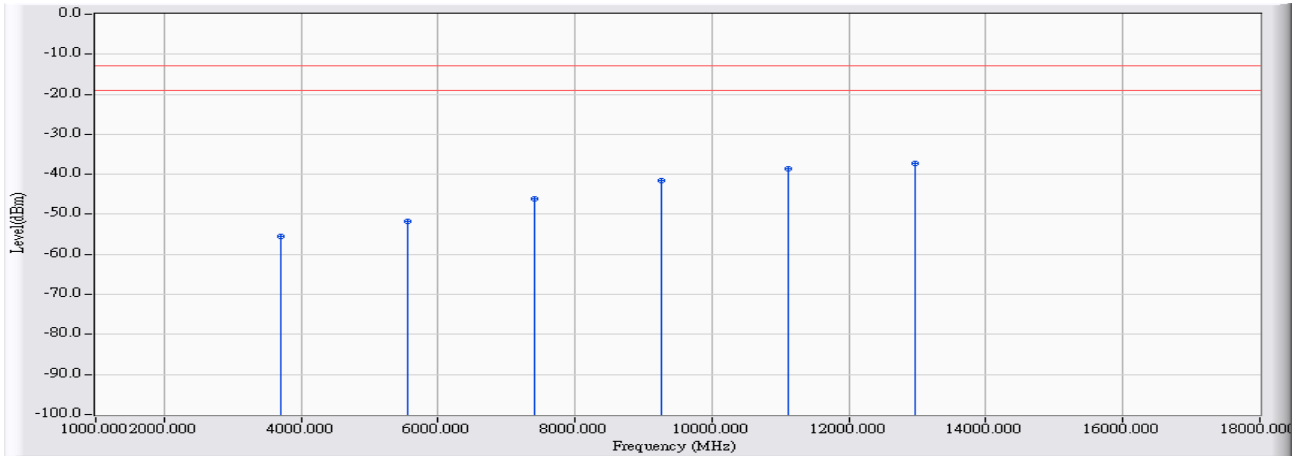

		Frequency (MHz)	Correct Factor (dB)	Reading Level (dBm)	Measure Level (dBm)	Margin (dB)	Limit (dBm)	Detector Type
1		3704.800	12.187	-67.740	-55.553	-42.553	-13.000	PEAK
2		5557.200	16.549	-68.280	-51.732	-38.732	-13.000	PEAK
3		7409.600	23.726	-69.950	-46.225	-33.225	-13.000	PEAK
4		9262.000	28.604	-70.180	-41.577	-28.577	-13.000	PEAK
5		11114.400	33.327	-71.860	-38.534	-25.534	-13.000	PEAK
6	*	12966.800	33.624	-70.880	-37.255	-24.255	-13.000	PEAK

Note:

1. All readings above 1GHz are performed with peak and/or average measurements as necessary.
2. Peak measurements: RBW = 1MHz, VBW = 1MHz, Sweep: Auto.
3. Average measurements: RBW = 1MHz, VBW = 10 Hz, Sweep: Auto.
4. “ * ”, means this data is the worst emission level.
5. Measurement Level = Reading Level + Correct Factor.
6. The average measurement was not performed when the peak measured data under the limit of average detection.
7. The Emission above 18GHz were not included is because their levels are too low.

Site : CB4-H	Time : 2017/02/23
Limit : Part_22/24_00M_PK	Margin : 6
Probe : CB4-H_CE_Sub_B433_1-18GHz_3M_0217 - HORIZONTAL	Power : DC 3.8V
EUT : LE910C1-NA	Note : Mode 15: WCDMA Band 2_HSUPA Mode_Idle 1880MHz

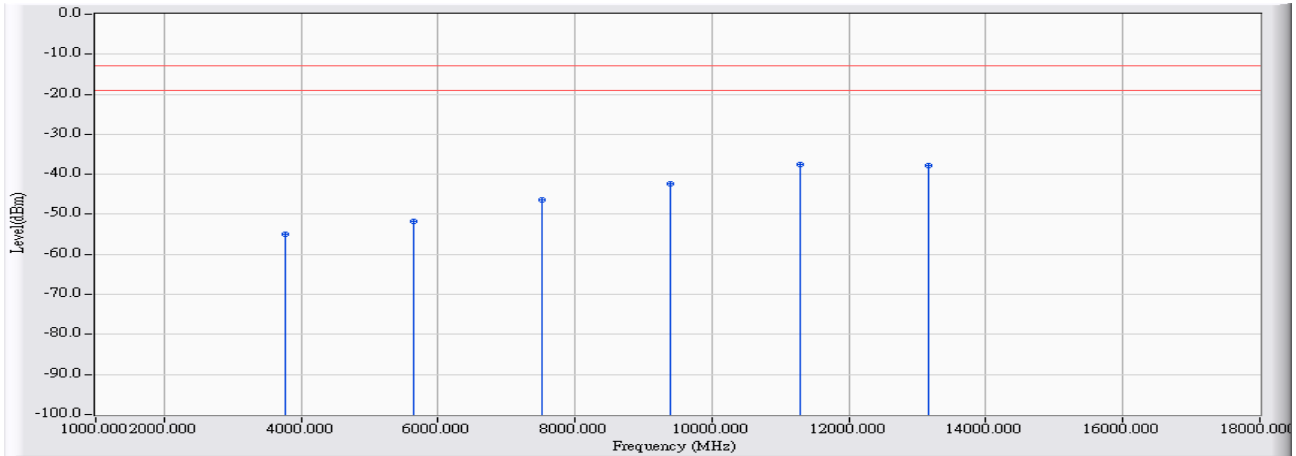

		Frequency (MHz)	Correct Factor (dB)	Reading Level (dBm)	Measure Level (dBm)	Margin (dB)	Limit (dBm)	Detector Type
1		3760.000	12.331	-67.180	-54.849	-41.849	-13.000	PEAK
2		5640.000	16.663	-68.520	-51.856	-38.856	-13.000	PEAK
3		7520.000	23.544	-69.870	-46.326	-33.326	-13.000	PEAK
4		9400.000	28.736	-71.150	-42.414	-29.414	-13.000	PEAK
5	*	11280.000	33.758	-71.200	-37.442	-24.442	-13.000	PEAK
6		13160.000	32.895	-70.710	-37.816	-24.816	-13.000	PEAK

Note:

1. All readings above 1GHz are performed with peak and/or average measurements as necessary.
2. Peak measurements: RBW = 1MHz, VBW = 1MHz, Sweep: Auto.
3. Average measurements: RBW = 1MHz, VBW = 10 Hz, Sweep: Auto.
4. “ * ”, means this data is the worst emission level.
5. Measurement Level = Reading Level + Correct Factor.
6. The average measurement was not performed when the peak measured data under the limit of average detection.
7. The Emission above 18GHz were not included is because their levels are too low.

Site : CB4-H	Time : 2017/02/23
Limit : Part_22/24_00M_PK	Margin : 6
Probe : CB4-H_CE_Sub_B433_1-18GHz_3M_0217 - VERTICAL	Power : DC 3.8V
EUT : LE910C1-NA	Note : Mode 15: WCDMA Band 2_HSUPA Mode_Idle 1880MHz

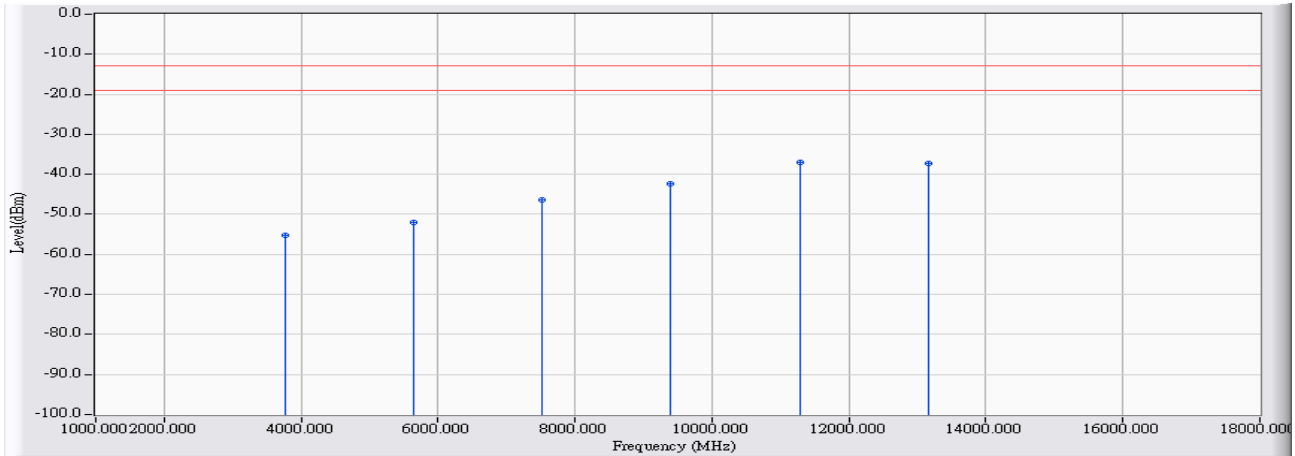

		Frequency (MHz)	Correct Factor (dB)	Reading Level (dBm)	Measure Level (dBm)	Margin (dB)	Limit (dBm)	Detector Type
1		3760.000	12.217	-67.450	-55.232	-42.232	-13.000	PEAK
2		5640.000	16.688	-68.780	-52.091	-39.091	-13.000	PEAK
3		7520.000	23.734	-70.140	-46.406	-33.406	-13.000	PEAK
4		9400.000	28.694	-71.090	-42.396	-29.396	-13.000	PEAK
5	*	11280.000	33.863	-70.870	-37.007	-24.007	-13.000	PEAK
6		13160.000	33.279	-70.560	-37.282	-24.282	-13.000	PEAK

Note:

1. All readings above 1GHz are performed with peak and/or average measurements as necessary.
2. Peak measurements: RBW = 1MHz, VBW = 1MHz, Sweep: Auto.
3. Average measurements: RBW = 1MHz, VBW = 10 Hz, Sweep: Auto.
4. “ * ”, means this data is the worst emission level.
5. Measurement Level = Reading Level + Correct Factor.
6. The average measurement was not performed when the peak measured data under the limit of average detection.
7. The Emission above 18GHz were not included is because their levels are too low.

Site : CB4-H	Time : 2017/02/23
Limit : Part_22/24_00M_PK	Margin : 6
Probe : CB4-H_CE_Sub_B433_1-18GHz_3M_0217 - HORIZONTAL	Power : DC 3.8V
EUT : LE910C1-NA	Note : Mode 15: WCDMA Band 2_HSUPA Mode_Idle 1907.6MHz

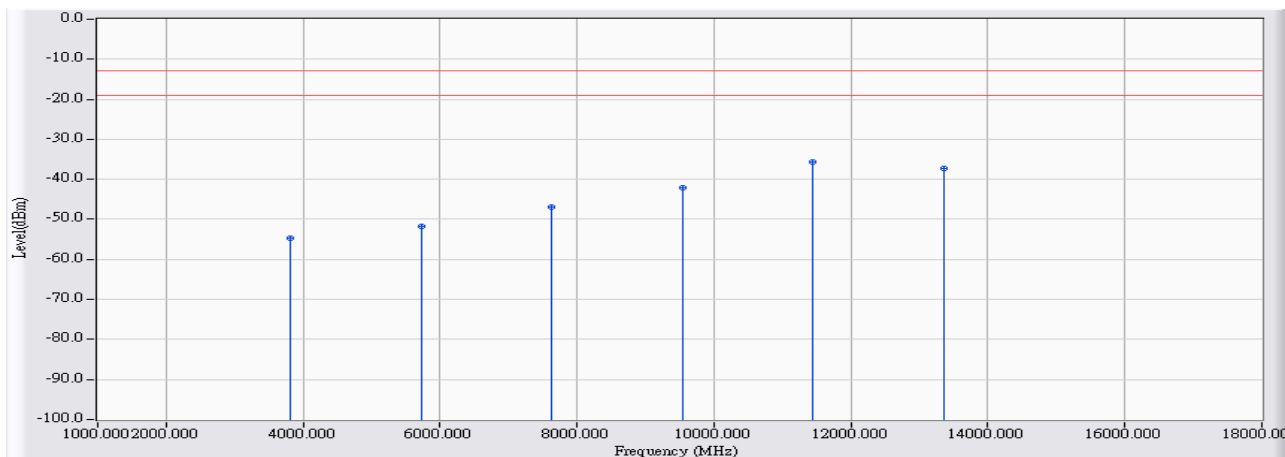

		Frequency (MHz)	Correct Factor (dB)	Reading Level (dBm)	Measure Level (dBm)	Margin (dB)	Limit (dBm)	Detector Type
1		3815.200	12.440	-67.260	-54.820	-41.820	-13.000	PEAK
2		5722.800	16.861	-68.560	-51.699	-38.699	-13.000	PEAK
3		7630.400	23.397	-70.270	-46.874	-33.874	-13.000	PEAK
4		9538.000	29.014	-71.120	-42.106	-29.106	-13.000	PEAK
5	*	11445.600	34.890	-70.650	-35.760	-22.760	-13.000	PEAK
6		13353.200	33.373	-70.700	-37.327	-24.327	-13.000	PEAK

Note:

1. All readings above 1GHz are performed with peak and/or average measurements as necessary.
2. Peak measurements: RBW = 1MHz, VBW = 1MHz, Sweep: Auto.
3. Average measurements: RBW = 1MHz, VBW = 10 Hz, Sweep: Auto.
4. “ * ”, means this data is the worst emission level.
5. Measurement Level = Reading Level + Correct Factor.
6. The average measurement was not performed when the peak measured data under the limit of average detection.
7. The Emission above 18GHz were not included is because their levels are too low.

Site : CB4-H	Time : 2017/02/23
Limit : Part_22/24_00M_PK	Margin : 6
Probe : CB4-H_CE_Sub_B433_1-18GHz_3M_0217 - VERTICAL	Power : DC 3.8V
EUT : LE910C1-NA	Note : Mode 15: WCDMA Band 2_HSUPA Mode_Idle 1907.6MHz

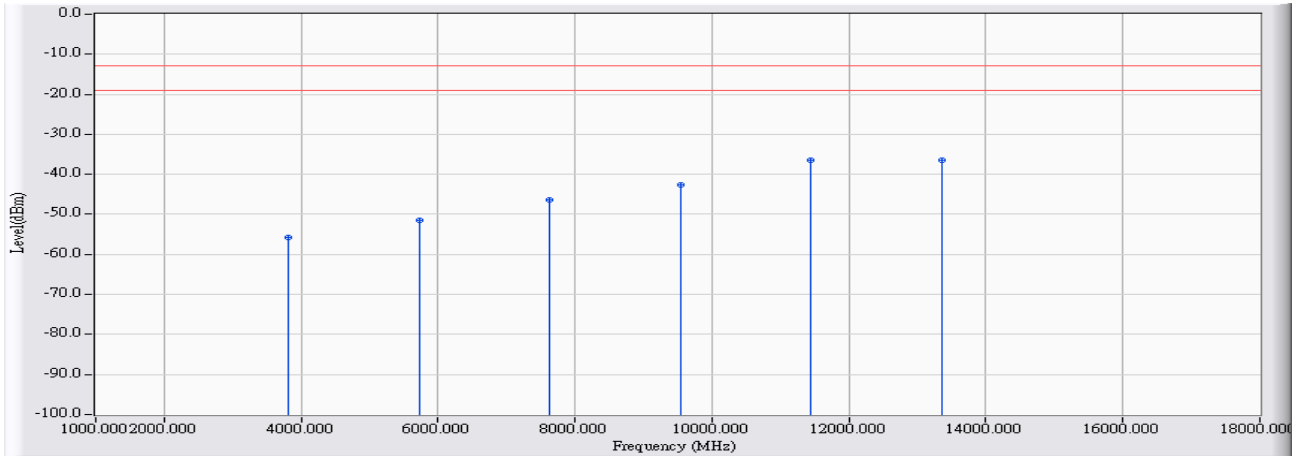

		Frequency (MHz)	Correct Factor (dB)	Reading Level (dBm)	Measure Level (dBm)	Margin (dB)	Limit (dBm)	Detector Type
1		3815.200	12.086	-67.860	-55.774	-42.774	-13.000	PEAK
2		5722.800	16.829	-68.290	-51.460	-38.460	-13.000	PEAK
3		7630.400	23.529	-69.870	-46.342	-33.342	-13.000	PEAK
4		9538.000	28.847	-71.380	-42.532	-29.532	-13.000	PEAK
5		11445.600	34.909	-71.290	-36.382	-23.382	-13.000	PEAK
6	*	13353.200	33.701	-70.030	-36.330	-23.330	-13.000	PEAK

Note:

1. All readings above 1GHz are performed with peak and/or average measurements as necessary.
2. Peak measurements: RBW = 1MHz, VBW = 1MHz, Sweep: Auto.
3. Average measurements: RBW = 1MHz, VBW = 10 Hz, Sweep: Auto.
4. “ * ”, means this data is the worst emission level.
5. Measurement Level = Reading Level + Correct Factor.
6. The average measurement was not performed when the peak measured data under the limit of average detection.
7. The Emission above 18GHz were not included is because their levels are too low.

Site : CB4-H	Time : 2017/02/23
Limit : Part_22/24_00M_PK	Margin : 6
Probe : CB4-H_CE_Sub_B433_1-18GHz_3M_0217 - HORIZONTAL	Power : DC 3.8V
EUT : LE910C1-NA	Note : Mode 16: WCDMA Band 2_HSDPA Mode_Link 1852.4MHz

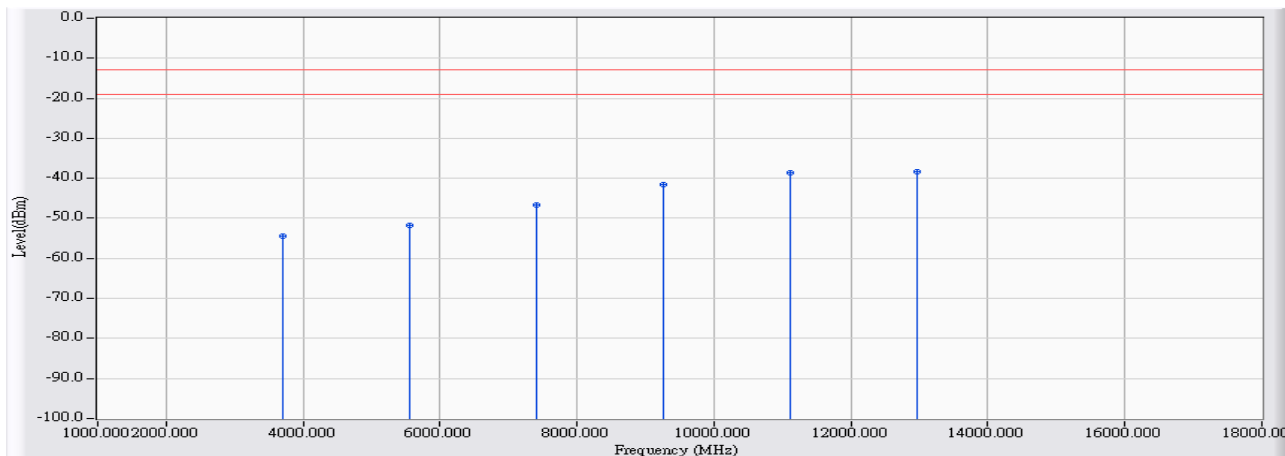

		Frequency (MHz)	Correct Factor (dB)	Reading Level (dBm)	Measure Level (dBm)	Margin (dB)	Limit (dBm)	Detector Type
1		3704.800	12.264	-66.610	-54.346	-41.346	-13.000	PEAK
2		5557.200	16.467	-68.270	-51.803	-38.803	-13.000	PEAK
3		7409.600	23.598	-70.270	-46.672	-33.672	-13.000	PEAK
4		9262.000	28.552	-70.240	-41.689	-28.689	-13.000	PEAK
5		11114.400	33.261	-71.810	-38.549	-25.549	-13.000	PEAK
6	*	12966.800	33.164	-71.410	-38.245	-25.245	-13.000	PEAK

Note:

1. All readings above 1GHz are performed with peak and/or average measurements as necessary.
2. Peak measurements: RBW = 1MHz, VBW = 1MHz, Sweep: Auto.
3. Average measurements: RBW = 1MHz, VBW = 10 Hz, Sweep: Auto.
4. “ * ”, means this data is the worst emission level.
5. Measurement Level = Reading Level + Correct Factor.
6. The average measurement was not performed when the peak measured data under the limit of average detection.
7. The Emission above 18GHz were not included is because their levels are too low.

Site : CB4-H	Time : 2017/02/23
Limit : Part_22/24_00M_PK	Margin : 6
Probe : CB4-H_CE_Sub_B433_1-18GHz_3M_0217 - VERTICAL	Power : DC 3.8V
EUT : LE910C1-NA	Note : Mode 16: WCDMA Band 2_HSDPA Mode_Link 1852.4MHz

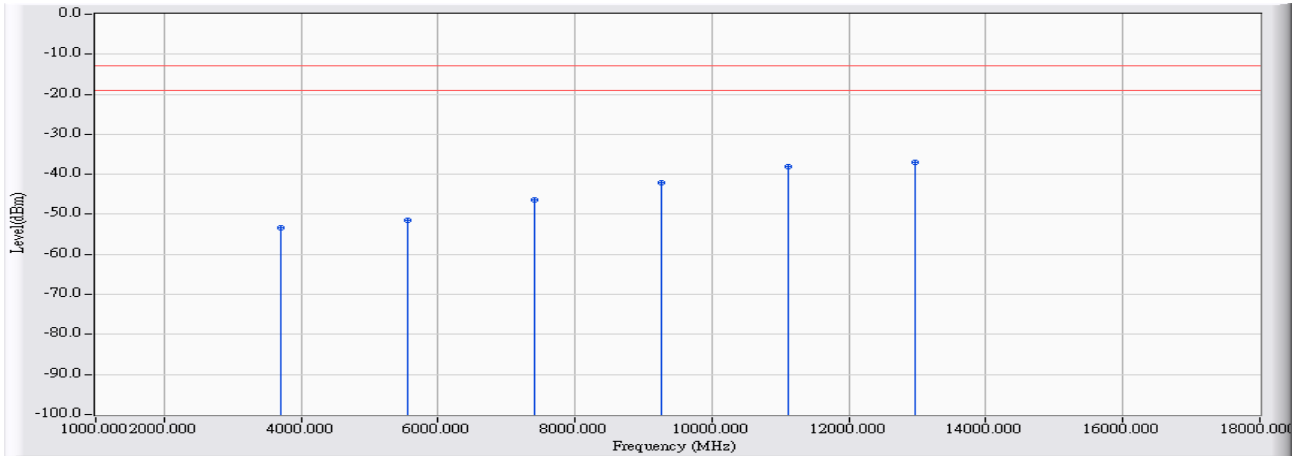

		Frequency (MHz)	Correct Factor (dB)	Reading Level (dBm)	Measure Level (dBm)	Margin (dB)	Limit (dBm)	Detector Type
1		3704.800	12.187	-65.610	-53.423	-40.423	-13.000	PEAK
2		5557.200	16.549	-67.920	-51.372	-38.372	-13.000	PEAK
3		7409.600	23.726	-70.120	-46.395	-33.395	-13.000	PEAK
4		9262.000	28.604	-70.600	-41.997	-28.997	-13.000	PEAK
5		11114.400	33.327	-71.470	-38.144	-25.144	-13.000	PEAK
6	*	12966.800	33.624	-70.680	-37.055	-24.055	-13.000	PEAK

Note:

1. All readings above 1GHz are performed with peak and/or average measurements as necessary.
2. Peak measurements: RBW = 1MHz, VBW = 1MHz, Sweep: Auto.
3. Average measurements: RBW = 1MHz, VBW = 10 Hz, Sweep: Auto.
4. “ * ”, means this data is the worst emission level.
5. Measurement Level = Reading Level + Correct Factor.
6. The average measurement was not performed when the peak measured data under the limit of average detection.
7. The Emission above 18GHz were not included is because their levels are too low.

Site : CB4-H	Time : 2017/02/23
Limit : Part_22/24_00M_PK	Margin : 6
Probe : CB4-H_CE_Sub_B433_1-18GHz_3M_0217 - HORIZONTAL	Power : DC 3.8V
EUT : LE910C1-NA	Note : Mode 16: WCDMA Band 2_HSDPA Mode_Link 1880MHz

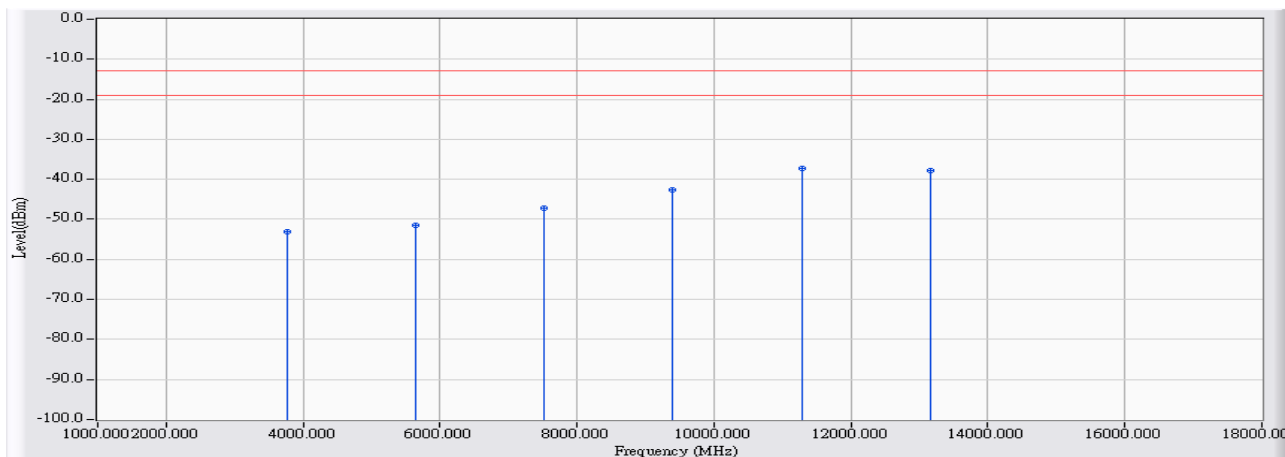

		Frequency (MHz)	Correct Factor (dB)	Reading Level (dBm)	Measure Level (dBm)	Margin (dB)	Limit (dBm)	Detector Type
1		3760.000	12.331	-65.500	-53.169	-40.169	-13.000	PEAK
2		5640.000	16.663	-68.070	-51.406	-38.406	-13.000	PEAK
3		7520.000	23.544	-70.810	-47.266	-34.266	-13.000	PEAK
4		9400.000	28.736	-71.340	-42.604	-29.604	-13.000	PEAK
5	*	11280.000	33.758	-71.090	-37.332	-24.332	-13.000	PEAK
6		13160.000	32.895	-70.760	-37.866	-24.866	-13.000	PEAK

Note:

1. All readings above 1GHz are performed with peak and/or average measurements as necessary.
2. Peak measurements: RBW = 1MHz, VBW = 1MHz, Sweep: Auto.
3. Average measurements: RBW = 1MHz, VBW = 10 Hz, Sweep: Auto.
4. “ * ”, means this data is the worst emission level.
5. Measurement Level = Reading Level + Correct Factor.
6. The average measurement was not performed when the peak measured data under the limit of average detection.
7. The Emission above 18GHz were not included is because their levels are too low.

Site : CB4-H	Time : 2017/02/23
Limit : Part_22/24_00M_PK	Margin : 6
Probe : CB4-H_CE_Sub_B433_1-18GHz_3M_0217 - VERTICAL	Power : DC 3.8V
EUT : LE910C1-NA	Note : Mode 16: WCDMA Band 2_HSDPA Mode_Link 1880MHz

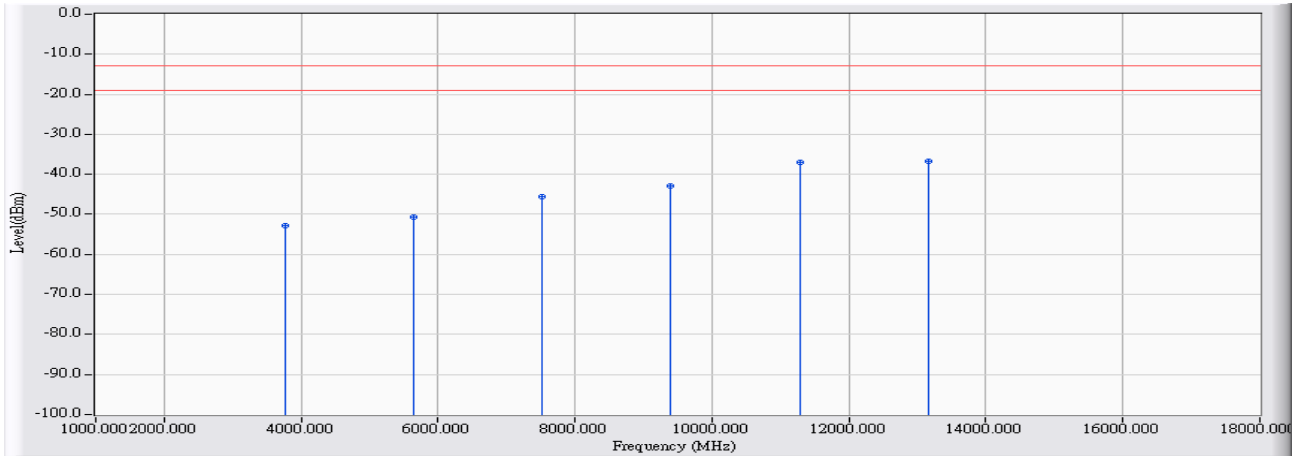

		Frequency (MHz)	Correct Factor (dB)	Reading Level (dBm)	Measure Level (dBm)	Margin (dB)	Limit (dBm)	Detector Type
1		3760.000	12.217	-65.000	-52.782	-39.782	-13.000	PEAK
2		5640.000	16.688	-67.330	-50.641	-37.641	-13.000	PEAK
3		7520.000	23.734	-69.360	-45.626	-32.626	-13.000	PEAK
4		9400.000	28.694	-71.540	-42.846	-29.846	-13.000	PEAK
5		11280.000	33.863	-70.850	-36.987	-23.987	-13.000	PEAK
6	*	13160.000	33.279	-70.050	-36.772	-23.772	-13.000	PEAK

Note:

1. All readings above 1GHz are performed with peak and/or average measurements as necessary.
2. Peak measurements: RBW = 1MHz, VBW = 1MHz, Sweep: Auto.
3. Average measurements: RBW = 1MHz, VBW = 10 Hz, Sweep: Auto.
4. “ * ”, means this data is the worst emission level.
5. Measurement Level = Reading Level + Correct Factor.
6. The average measurement was not performed when the peak measured data under the limit of average detection.
7. The Emission above 18GHz were not included is because their levels are too low.

Site : CB4-H	Time : 2017/02/23
Limit : Part_22/24_00M_PK	Margin : 6
Probe : CB4-H_CE_Sub_B433_1-18GHz_3M_0217 - HORIZONTAL	Power : DC 3.8V
EUT : LE910C1-NA	Note : Mode 16: WCDMA Band 2_HSDPA Mode_Link 1907.6MHz

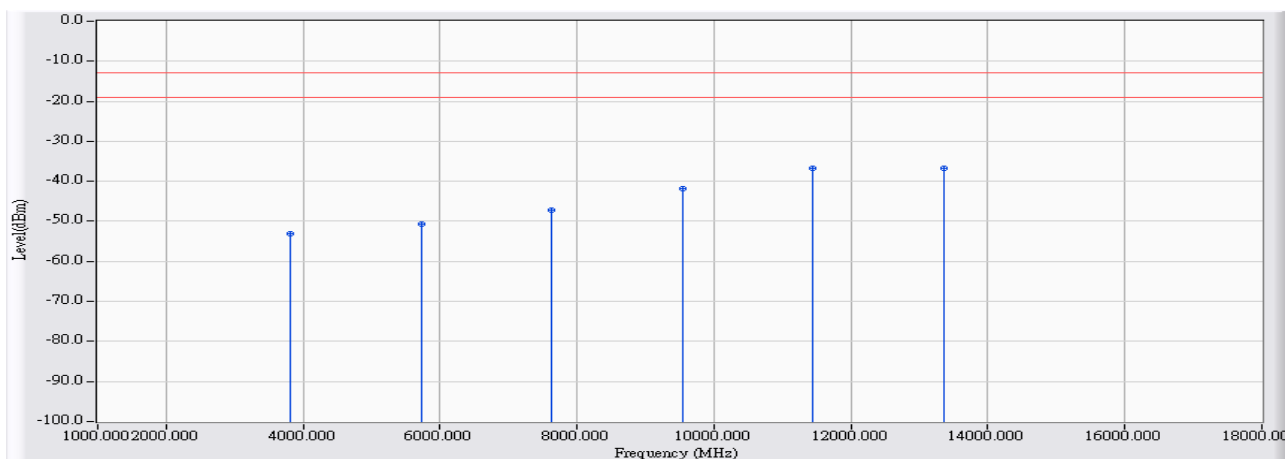

		Frequency (MHz)	Correct Factor (dB)	Reading Level (dBm)	Measure Level (dBm)	Margin (dB)	Limit (dBm)	Detector Type
1		3815.200	12.440	-65.580	-53.140	-40.140	-13.000	PEAK
2		5722.800	16.861	-67.600	-50.739	-37.739	-13.000	PEAK
3		7630.400	23.397	-70.450	-47.054	-34.054	-13.000	PEAK
4		9538.000	29.014	-70.750	-41.736	-28.736	-13.000	PEAK
5	*	11445.600	34.890	-71.700	-36.810	-23.810	-13.000	PEAK
6		13353.200	33.373	-70.230	-36.857	-23.857	-13.000	PEAK

Note:

1. All readings above 1GHz are performed with peak and/or average measurements as necessary.
2. Peak measurements: RBW = 1MHz, VBW = 1MHz, Sweep: Auto.
3. Average measurements: RBW = 1MHz, VBW = 10 Hz, Sweep: Auto.
4. “ * ”, means this data is the worst emission level.
5. Measurement Level = Reading Level + Correct Factor.
6. The average measurement was not performed when the peak measured data under the limit of average detection.
7. The Emission above 18GHz were not included is because their levels are too low.

Site : CB4-H	Time : 2017/02/23
Limit : Part_22/24_00M_PK	Margin : 6
Probe : CB4-H_CE_Sub_B433_1-18GHz_3M_0217 - VERTICAL	Power : DC 3.8V
EUT : LE910C1-NA	Note : Mode 16: WCDMA Band 2_HSDPA Mode_Link 1907.6MHz

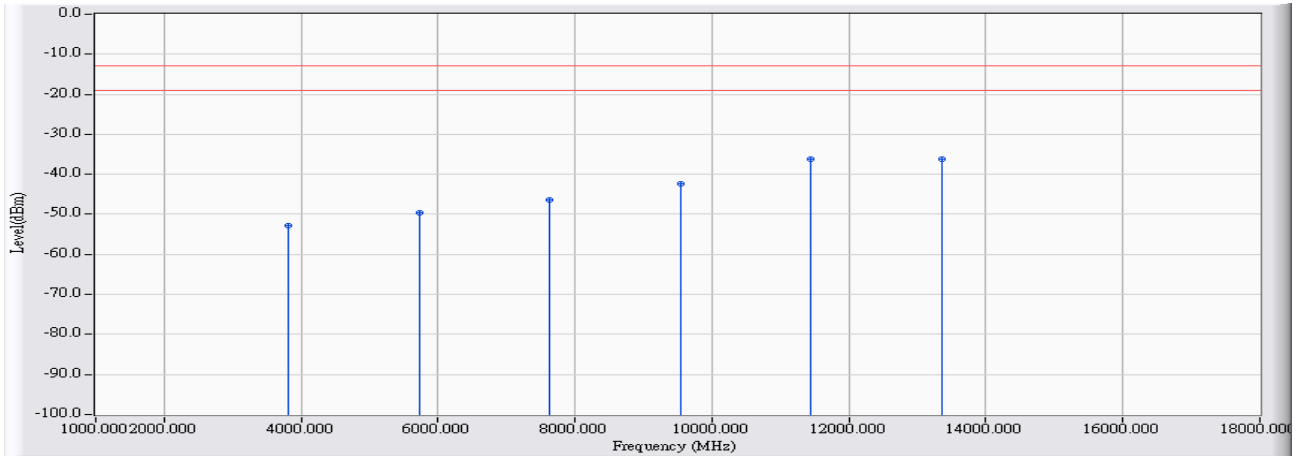

		Frequency (MHz)	Correct Factor (dB)	Reading Level (dBm)	Measure Level (dBm)	Margin (dB)	Limit (dBm)	Detector Type
1		3815.200	12.086	-64.890	-52.804	-39.804	-13.000	PEAK
2		5722.800	16.829	-66.330	-49.500	-36.500	-13.000	PEAK
3		7630.400	23.529	-69.940	-46.412	-33.412	-13.000	PEAK
4		9538.000	28.847	-71.200	-42.352	-29.352	-13.000	PEAK
5		11445.600	34.909	-71.210	-36.302	-23.302	-13.000	PEAK
6	*	13353.200	33.701	-69.810	-36.110	-23.110	-13.000	PEAK

Note:

1. All readings above 1GHz are performed with peak and/or average measurements as necessary.
2. Peak measurements: RBW = 1MHz, VBW = 1MHz, Sweep: Auto.
3. Average measurements: RBW = 1MHz, VBW = 10 Hz, Sweep: Auto.
4. “ * ”, means this data is the worst emission level.
5. Measurement Level = Reading Level + Correct Factor.
6. The average measurement was not performed when the peak measured data under the limit of average detection.
7. The Emission above 18GHz were not included is because their levels are too low.

Site : CB4-H	Time : 2017/02/23
Limit : Part_22/24_00M_PK	Margin : 6
Probe : CB4-H_CE_Sub_B433_1-18GHz_3M_0217 - HORIZONTAL	Power : DC 3.8V
EUT : LE910C1-NA	Note : Mode 16: WCDMA Band 2_HSDPA Mode_Idle 1852.4MHz

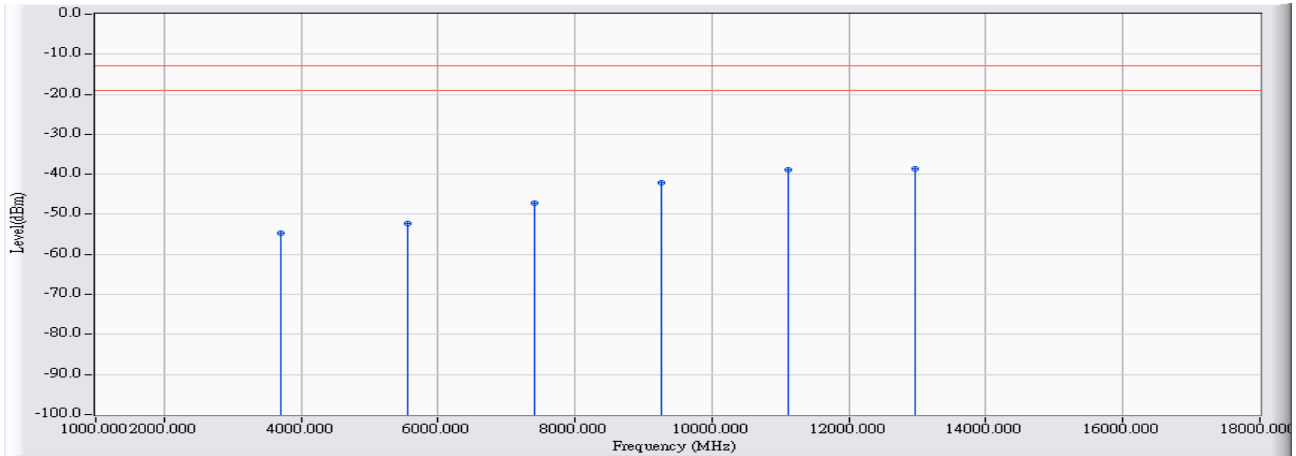

		Frequency (MHz)	Correct Factor (dB)	Reading Level (dBm)	Measure Level (dBm)	Margin (dB)	Limit (dBm)	Detector Type
1		3704.800	12.264	-66.930	-54.666	-41.666	-13.000	PEAK
2		5557.200	16.467	-68.720	-52.253	-39.253	-13.000	PEAK
3		7409.600	23.598	-70.670	-47.072	-34.072	-13.000	PEAK
4		9262.000	28.552	-70.760	-42.209	-29.209	-13.000	PEAK
5		11114.400	33.261	-72.040	-38.779	-25.779	-13.000	PEAK
6	*	12966.800	33.164	-71.810	-38.645	-25.645	-13.000	PEAK

Note:

1. All readings above 1GHz are performed with peak and/or average measurements as necessary.
2. Peak measurements: RBW = 1MHz, VBW = 1MHz, Sweep: Auto.
3. Average measurements: RBW = 1MHz, VBW = 10 Hz, Sweep: Auto.
4. “ * ”, means this data is the worst emission level.
5. Measurement Level = Reading Level + Correct Factor.
6. The average measurement was not performed when the peak measured data under the limit of average detection.
7. The Emission above 18GHz were not included is because their levels are too low.

Site : CB4-H	Time : 2017/02/23
Limit : Part_22/24_00M_PK	Margin : 6
Probe : CB4-H_CE_Sub_B433_1-18GHz_3M_0217 - VERTICAL	Power : DC 3.8V
EUT : LE910C1-NA	Note : Mode 16: WCDMA Band 2_HSDPA Mode_Idle 1852.4MHz

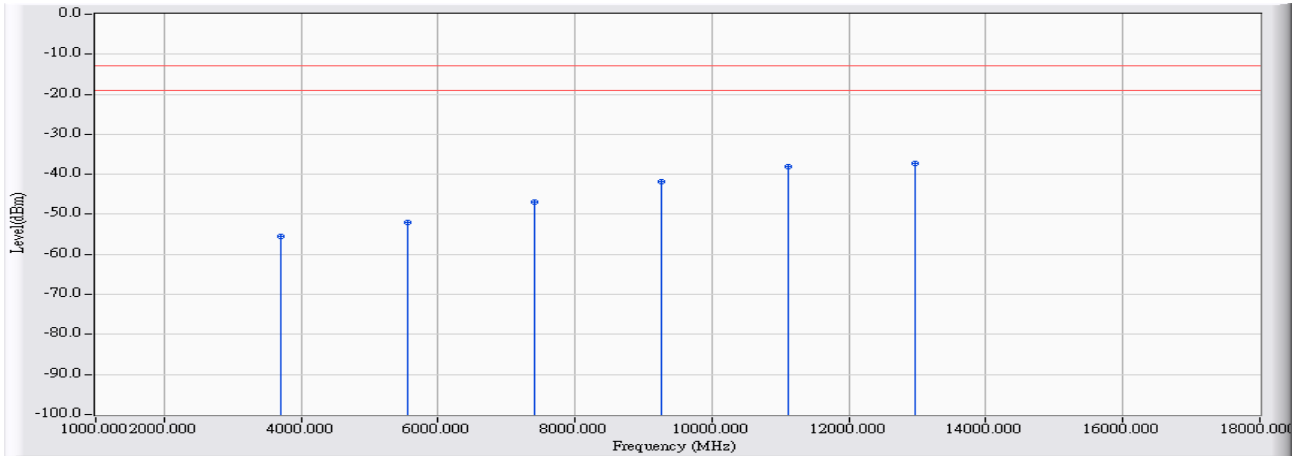

		Frequency (MHz)	Correct Factor (dB)	Reading Level (dBm)	Measure Level (dBm)	Margin (dB)	Limit (dBm)	Detector Type
1		3704.800	12.187	-67.790	-55.603	-42.603	-13.000	PEAK
2		5557.200	16.549	-68.590	-52.042	-39.042	-13.000	PEAK
3		7409.600	23.726	-70.670	-46.945	-33.945	-13.000	PEAK
4		9262.000	28.604	-70.490	-41.887	-28.887	-13.000	PEAK
5		11114.400	33.327	-71.390	-38.064	-25.064	-13.000	PEAK
6	*	12966.800	33.624	-71.010	-37.385	-24.385	-13.000	PEAK

Note:

1. All readings above 1GHz are performed with peak and/or average measurements as necessary.
2. Peak measurements: RBW = 1MHz, VBW = 1MHz, Sweep: Auto.
3. Average measurements: RBW = 1MHz, VBW = 10 Hz, Sweep: Auto.
4. “ * ”, means this data is the worst emission level.
5. Measurement Level = Reading Level + Correct Factor.
6. The average measurement was not performed when the peak measured data under the limit of average detection.
7. The Emission above 18GHz were not included is because their levels are too low.

Site : CB4-H	Time : 2017/02/23
Limit : Part_22/24_00M_PK	Margin : 6
Probe : CB4-H_CE_Sub_B433_1-18GHz_3M_0217 - HORIZONTAL	Power : DC 3.8V
EUT : LE910C1-NA	Note : Mode 16: WCDMA Band 2_HSDPA Mode_Idle 1880MHz

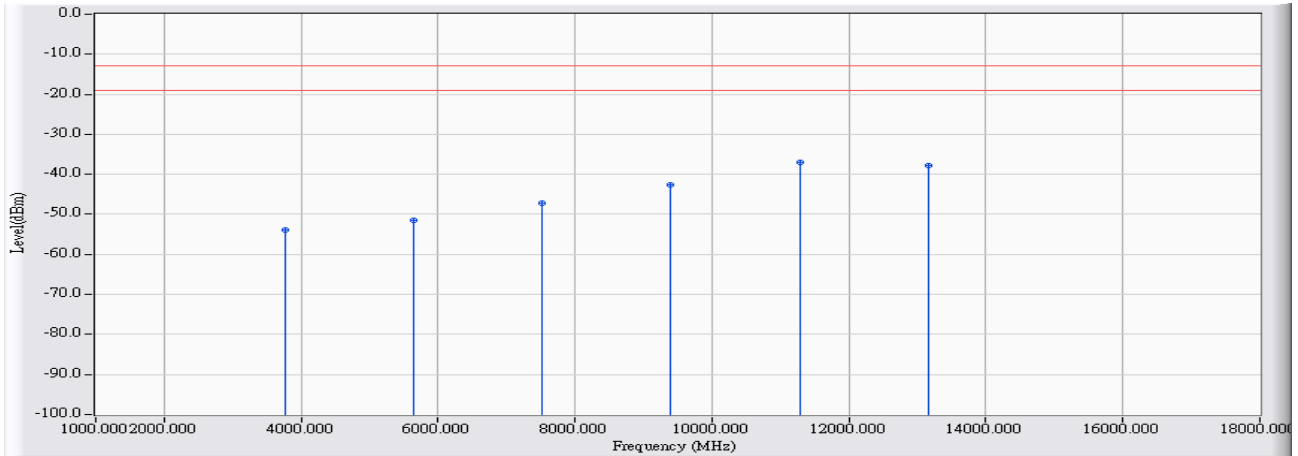

		Frequency (MHz)	Correct Factor (dB)	Reading Level (dBm)	Measure Level (dBm)	Margin (dB)	Limit (dBm)	Detector Type
1		3760.000	12.331	-66.210	-53.879	-40.879	-13.000	PEAK
2		5640.000	16.663	-68.100	-51.436	-38.436	-13.000	PEAK
3		7520.000	23.544	-70.820	-47.276	-34.276	-13.000	PEAK
4		9400.000	28.736	-71.400	-42.664	-29.664	-13.000	PEAK
5	*	11280.000	33.758	-70.700	-36.942	-23.942	-13.000	PEAK
6		13160.000	32.895	-70.750	-37.856	-24.856	-13.000	PEAK

Note:

1. All readings above 1GHz are performed with peak and/or average measurements as necessary.
2. Peak measurements: RBW = 1MHz, VBW = 1MHz, Sweep: Auto.
3. Average measurements: RBW = 1MHz, VBW = 10 Hz, Sweep: Auto.
4. “ * ”, means this data is the worst emission level.
5. Measurement Level = Reading Level + Correct Factor.
6. The average measurement was not performed when the peak measured data under the limit of average detection.
7. The Emission above 18GHz were not included is because their levels are too low.

Site : CB4-H	Time : 2017/02/23
Limit : Part_22/24_00M_PK	Margin : 6
Probe : CB4-H_CE_Sub_B433_1-18GHz_3M_0217 - VERTICAL	Power : DC 3.8V
EUT : LE910C1-NA	Note : Mode 16: WCDMA Band 2_HSDPA Mode_Idle 1880MHz

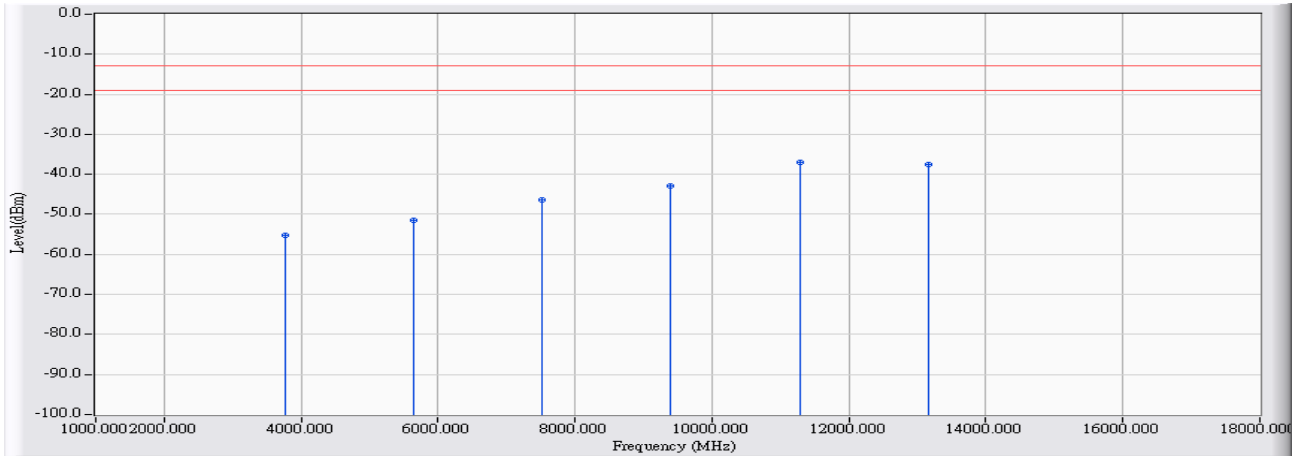

		Frequency (MHz)	Correct Factor (dB)	Reading Level (dBm)	Measure Level (dBm)	Margin (dB)	Limit (dBm)	Detector Type
1		3760.000	12.217	-67.500	-55.282	-42.282	-13.000	PEAK
2		5640.000	16.688	-68.290	-51.601	-38.601	-13.000	PEAK
3		7520.000	23.734	-70.200	-46.466	-33.466	-13.000	PEAK
4		9400.000	28.694	-71.490	-42.796	-29.796	-13.000	PEAK
5	*	11280.000	33.863	-70.780	-36.917	-23.917	-13.000	PEAK
6		13160.000	33.279	-70.690	-37.412	-24.412	-13.000	PEAK

Note:

1. All readings above 1GHz are performed with peak and/or average measurements as necessary.
2. Peak measurements: RBW = 1MHz, VBW = 1MHz, Sweep: Auto.
3. Average measurements: RBW = 1MHz, VBW = 10 Hz, Sweep: Auto.
4. “ * ”, means this data is the worst emission level.
5. Measurement Level = Reading Level + Correct Factor.
6. The average measurement was not performed when the peak measured data under the limit of average detection.
7. The Emission above 18GHz were not included is because their levels are too low.

Site : CB4-H	Time : 2017/02/23
Limit : Part_22/24_00M_PK	Margin : 6
Probe : CB4-H_CE_Sub_B433_1-18GHz_3M_0217 - HORIZONTAL	Power : DC 3.8V
EUT : LE910C1-NA	Note : Mode 16: WCDMA Band 2_HSDPA Mode_Idle 1907.6MHz

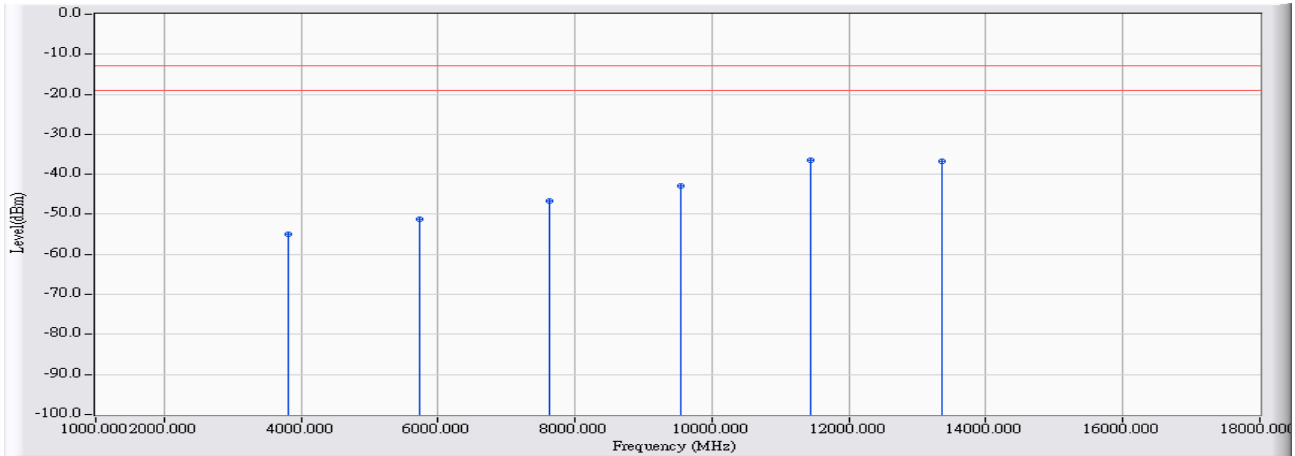

		Frequency (MHz)	Correct Factor (dB)	Reading Level (dBm)	Measure Level (dBm)	Margin (dB)	Limit (dBm)	Detector Type
1		3815.200	12.440	-67.440	-55.000	-42.000	-13.000	PEAK
2		5722.800	16.861	-68.120	-51.259	-38.259	-13.000	PEAK
3		7630.400	23.397	-70.110	-46.714	-33.714	-13.000	PEAK
4		9538.000	29.014	-71.880	-42.866	-29.866	-13.000	PEAK
5	*	11445.600	34.890	-71.330	-36.440	-23.440	-13.000	PEAK
6		13353.200	33.373	-70.030	-36.657	-23.657	-13.000	PEAK

Note:

1. All readings above 1GHz are performed with peak and/or average measurements as necessary.
2. Peak measurements: RBW = 1MHz, VBW = 1MHz, Sweep: Auto.
3. Average measurements: RBW = 1MHz, VBW = 10 Hz, Sweep: Auto.
4. “ * ”, means this data is the worst emission level.
5. Measurement Level = Reading Level + Correct Factor.
6. The average measurement was not performed when the peak measured data under the limit of average detection.
7. The Emission above 18GHz were not included is because their levels are too low.

Site : CB4-H	Time : 2017/02/23
Limit : Part_22/24_00M_PK	Margin : 6
Probe : CB4-H_CE_Sub_B433_1-18GHz_3M_0217 - VERTICAL	Power : DC 3.8V
EUT : LE910C1-NA	Note : Mode 16: WCDMA Band 2_HSDPA Mode_Idle 1907.6MHz

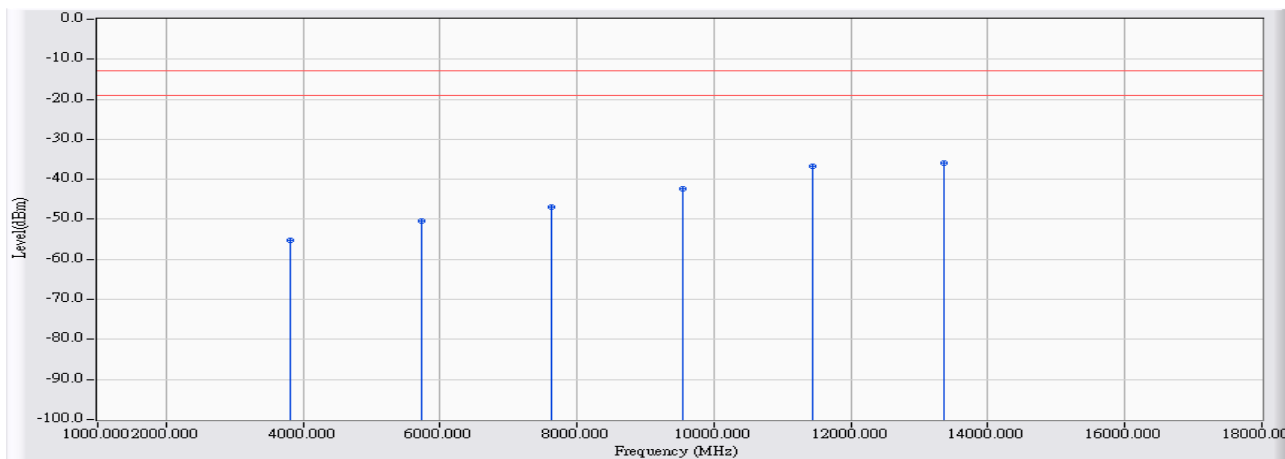

		Frequency (MHz)	Correct Factor (dB)	Reading Level (dBm)	Measure Level (dBm)	Margin (dB)	Limit (dBm)	Detector Type
1		3815.200	12.086	-67.350	-55.264	-42.264	-13.000	PEAK
2		5722.800	16.829	-67.130	-50.300	-37.300	-13.000	PEAK
3		7630.400	23.529	-70.500	-46.972	-33.972	-13.000	PEAK
4		9538.000	28.847	-71.290	-42.442	-29.442	-13.000	PEAK
5		11445.600	34.909	-71.620	-36.712	-23.712	-13.000	PEAK
6	*	13353.200	33.701	-69.530	-35.830	-22.830	-13.000	PEAK

Note:

1. All readings above 1GHz are performed with peak and/or average measurements as necessary.
2. Peak measurements: RBW = 1MHz, VBW = 1MHz, Sweep: Auto.
3. Average measurements: RBW = 1MHz, VBW = 10 Hz, Sweep: Auto.
4. “ * ”, means this data is the worst emission level.
5. Measurement Level = Reading Level + Correct Factor.
6. The average measurement was not performed when the peak measured data under the limit of average detection.
7. The Emission above 18GHz were not included is because their levels are too low.

7. Frequency Stability Under Temperature & Voltage Variations

7.1. Test Equipment

The following test equipments are used during the RF power output tests:

Frequency Stability Under Temperature & Voltage Variations/SR10-H

Instrument	Manufacturer	Model No.	Serial No	Next Cal. Date
Signal & Spectrum Analyzer	R&S	FSV40	101049	2018/01/22
Temperature & Humidity Chamber	WIT	TH-1S-B	1082101	2018/01/18

Note: All equipments upon which need to be calibrated are with calibration period of 1 year.

7.2. Test Setup

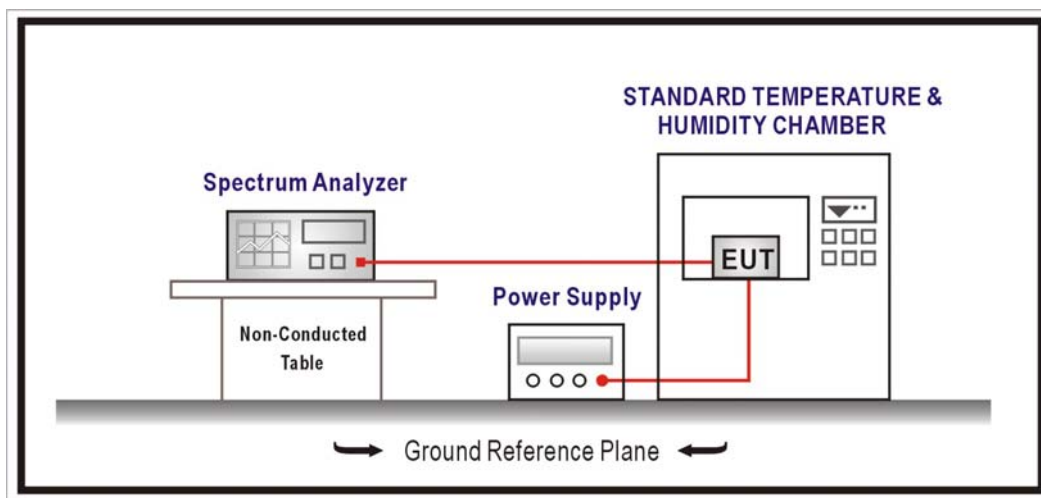

7.3. Limit

The frequency stability shall be sufficient to ensure that the fundamental emission stays within the authorized frequency block.

Limit	< ± 2.5 ppm
-------	-------------

7.4. Test Procedure

Frequency Stability Under Temperature Variations:

The equipment under test was connected to an external AC or DC power supply and input rated voltage. RF output was connected to a frequency counter or spectrum analyzer via feed through attenuators. The EUT was placed inside the temperature chamber. Set the spectrum analyzer RBW low enough to obtain the desired frequency resolution and measure EUT 20°C operating frequency as reference frequency. Turn EUT off and set the chamber temperature to -30°C. After the temperature stabilized for approximately 30 minutes recorded the frequency. Repeat step measure with 10°C increased per stage until the highest temperature of +50°C reached.

Frequency Stability Under Voltage Variations:

Set chamber temperature to 20°C. Use a variable AC power supply / DC power source to power the EUT and set the voltage to rated voltage. Set the spectrum analyzer RBW low enough to obtain the desired frequency resolution and recorded the frequency.

Reduce the input voltage to specify extreme voltage variation ($\pm 15\%$) and endpoint, record the maximum frequency change.

7.5. Uncertainty

The measurement uncertainty is defined as ± 10 Hz.

7.6. Test Result

Product	LE910C1-NA		
Test Item	Frequency Stability Under Temperature & Voltage Variations		
Test Mode	Mode 1: GSM 850_Link Mode		
Date of Test	2017/02/07	Test Site	SR10-H

824.2 MHz

FREQUENCY STABILITY

Voltage (VDC)	Frequency Error	Frequency Error(ppm)
4.2	22	-0.0263
3.7	17	-0.0203
3.4	21	-0.0254

AFC FREQ ERROR vs. TEMPERATURE

TEMPERATURE	Frequency Error(Hz)	Frequency Error (ppm)
-30	-17	0.0210
-20	16	-0.0195
-10	17	-0.0203
0	18	-0.0215
+10	17	-0.0209
+20	17	-0.0203
+30	16	-0.0197
+40	19	-0.0230
+50	19	-0.0236

Product	LE910C1-NA		
Test Item	Frequency Stability Under Temperature & Voltage Variations		
Test Mode	Mode 1: GSM 850_Link Mode		
Date of Test	2017/02/07	Test Site	SR10-H

836.6 MHz

FREQUENCY STABILITY

Voltage (VDC)	Frequency Error	Frequency Error(ppm)
4.2	22	-0.0258
3.7	20	-0.0233
3.4	22	-0.0263

AFC FREQ ERROR vs. TEMPERATURE

TEMPERATURE	Frequency Error(Hz)	Frequency Error (ppm)
-30	19	-0.0230
-20	19	-0.0223
-10	18	-0.0210
0	21	-0.0254
+10	19	-0.0224
+20	20	-0.0233
+30	18	-0.0215
+40	16	-0.0192
+50	18	-0.0217

Product	LE910C1-NA		
Test Item	Frequency Stability Under Temperature & Voltage Variations		
Test Mode	Mode 1: GSM 850_Link Mode		
Date of Test	2017/02/07	Test Site	SR10-H

848.8 MHz

FREQUENCY STABILITY

Voltage (VDC)	Frequency Error	Frequency Error(ppm)
4.2	24	-0.0281
3.7	19	-0.0218
3.4	21	-0.0249

AFC FREQ ERROR vs. TEMPERATURE

TEMPERATURE	Frequency Error(Hz)	Frequency Error (ppm)
-30	19	-0.0220
-20	16	-0.0193
-10	16	-0.0189
0	14	-0.0168
+10	16	-0.0186
+20	19	-0.0218
+30	17	-0.0205
+40	22	-0.0254
+50	18	-0.0207

Product	LE910C1-NA		
Test Item	Frequency Stability Under Temperature & Voltage Variations		
Test Mode	Mode 3: DCS 1900_Link Mode		
Date of Test	2017/02/07	Test Site	SR10-H

1850.2 MHz

FREQUENCY STABILITY

Voltage (VDC)	Frequency Error	Frequency Error(ppm)
4.2	9	-0.0050
3.7	-12	0.0067
3.4	8	-0.0044

AFC FREQ ERROR vs. TEMPERATURE

TEMPERATURE	Frequency Error(Hz)	Frequency Error (ppm)
-30	-12	0.0066
-20	-10	0.0055
-10	-10	0.0052
0	9	-0.0047
+10	7	-0.0036
+20	-12	0.0067
+30	-8	0.0044
+40	-10	0.0054
+50	7	-0.0040

Product	LE910C1-NA		
Test Item	Frequency Stability Under Temperature & Voltage Variations		
Test Mode	Mode 3: DCS 1900_Link Mode		
Date of Test	2017/02/07	Test Site	SR10-H

1880.0 MHz

FREQUENCY STABILITY

Voltage (VDC)	Frequency Error	Frequency Error(ppm)
4.2	13	-0.0070
3.7	-9	0.0049
3.4	11	-0.0061

AFC FREQ ERROR vs. TEMPERATURE

TEMPERATURE	Frequency Error(Hz)	Frequency Error (ppm)
-30	17	-0.0089
-20	16	-0.0085
-10	14	-0.0075
0	13	-0.0067
+10	-10	0.0052
+20	-9	0.0049
+30	11	-0.0059
+40	9	-0.0047
+50	13	-0.0069

Product	LE910C1-NA		
Test Item	Frequency Stability Under Temperature & Voltage Variations		
Test Mode	Mode 3: DCS 1900_Link Mode		
Date of Test	2017/02/07	Test Site	SR10-H

1909.8 MHz

FREQUENCY STABILITY

Voltage (VDC)	Frequency Error	Frequency Error(ppm)
4.2	13	-0.0067
3.7	9	-0.0047
3.4	14	-0.0075

AFC FREQ ERROR vs. TEMPERATURE

TEMPERATURE	Frequency Error(Hz)	Frequency Error (ppm)
-30	10	-0.0050
-20	10	-0.0051
-10	10	-0.0051
0	11	-0.0057
+10	-8	0.0043
+20	9	-0.0047
+30	-9	0.0046
+40	-8	0.0042
+50	14	-0.0071

Product	LE910C1-NA		
Test Item	Frequency Stability Under Temperature & Voltage Variations		
Test Mode	Mode 9: WCDMA Band 5_Link Mode		
Date of Test	2017/02/07	Test Site	SR10-H

826.4 MHz

FREQUENCY STABILITY

Voltage (VDC)	Frequency Error	Frequency Error(ppm)
4.2	2	-0.0025
3.7	2	-0.0030
3.4	3	-0.0032

AFC FREQ ERROR vs. TEMPERATURE

TEMPERATURE	Frequency Error(Hz)	Frequency Error (ppm)
-30	-5	0.0066
-20	-6	0.0070
-10	-5	0.0062
0	-4	0.0050
+10	-3	0.0042
+20	2	-0.0024
+30	-3	0.0032
+40	4	-0.0054
+50	3	-0.0035

Product	LE910C1-NA		
Test Item	Frequency Stability Under Temperature & Voltage Variations		
Test Mode	Mode 9: WCDMA Band 5_Link Mode		
Date of Test	2017/02/07	Test Site	SR10-H

836.6 MHz

FREQUENCY STABILITY

Voltage (VDC)	Frequency Error	Frequency Error(ppm)
4.2	2	-0.0023
3.7	3	-0.0033
3.4	-3	0.0032

AFC FREQ ERROR vs. TEMPERATURE

TEMPERATURE	Frequency Error(Hz)	Frequency Error (ppm)
-30	-2	0.0028
-20	3	-0.0030
-10	4	-0.0049
0	-2	0.0029
+10	3	-0.0037
+20	3	-0.0036
+30	2	-0.0025
+40	-2	0.0026
+50	-3	0.0041

Product	LE910C1-NA		
Test Item	Frequency Stability Under Temperature & Voltage Variations		
Test Mode	Mode 9: WCDMA Band 5_Link Mode		
Date of Test	2017/02/07	Test Site	SR10-H

846.6MHz

FREQUENCY STABILITY

Voltage (VDC)	Frequency Error	Frequency Error(ppm)
4.2	-3	0.0034
3.7	-2	0.0028
3.4	-3	0.0031

AFC FREQ ERROR vs. TEMPERATURE

TEMPERATURE	Frequency Error(Hz)	Frequency Error (ppm)
-30	5	-0.0065
-20	5	-0.0059
-10	5	-0.0057
0	5	-0.0055
+10	3	-0.0035
+20	-2	0.0024
+30	-2	0.0028
+40	4	-0.0044
+50	-4	0.0047

Product	LE910C1-NA		
Test Item	Frequency Stability Under Temperature & Voltage Variations		
Test Mode	Mode 11: WCDMA Band 2_Link Mode		
Date of Test	2017/02/07	Test Site	SR10-H

1852.4 MHz

FREQUENCY STABILITY

Voltage (VDC)	Frequency Error	Frequency Error(ppm)
4.2	-11	0.0060
3.7	-8	0.0041
3.4	-8	0.0044

AFC FREQ ERROR vs. TEMPERATURE

TEMPERATURE	Frequency Error(Hz)	Frequency Error (ppm)
-30	-10	0.0055
-20	-10	0.0052
-10	-10	0.0056
0	-10	0.0052
+10	-7	0.0037
+20	-8	0.0043
+30	7	-0.0037
+40	6	-0.0032
+50	9	-0.0049

Product	LE910C1-NA		
Test Item	Frequency Stability Under Temperature & Voltage Variations		
Test Mode	Mode 11: WCDMA Band 2_Link Mode		
Date of Test	2017/02/07	Test Site	SR10-H

1880.0 MHz

FREQUENCY STABILITY

Voltage (VDC)	Frequency Error	Frequency Error(ppm)
4.2	5	-0.0029
3.7	4	-0.0023
3.4	6	-0.0030

AFC FREQ ERROR vs. TEMPERATURE

TEMPERATURE	Frequency Error(Hz)	Frequency Error (ppm)
-30	-5	0.0029
-20	-4	0.0024
-10	-7	0.0038
0	-5	0.0028
+10	-4	0.0024
+20	4	-0.0021
+30	-4	0.0023
+40	-6	0.0030
+50	-7	0.0037

Product	LE910C1-NA		
Test Item	Frequency Stability Under Temperature & Voltage Variations		
Test Mode	Mode 11: WCDMA Band 2_Link Mode		
Date of Test	2017/02/07	Test Site	SR10-H

1907.6 MHz

FREQUENCY STABILITY

Voltage (VDC)	Frequency Error	Frequency Error(ppm)
4.2	-6	0.0033
3.7	6	-0.0033
3.4	-4	0.0023

AFC FREQ ERROR vs. TEMPERATURE

TEMPERATURE	Frequency Error(Hz)	Frequency Error (ppm)
-30	12	-0.0064
-20	11	-0.0056
-10	10	-0.0053
0	10	-0.0050
+10	7	-0.0037
+20	6	-0.0031
+30	-7	0.0035
+40	-8	0.0040
+50	-9	0.0046