



FCC 47 CFR PART 15 SUBPART B

Product Type : 2G/3G Module
Applicant : Telit Communications S.p.A.
Address : Via Stazione di Prosecco, 5/B, Sgonico, TS 34010, Italy
Trade Name : Telit
Model Number : HE910
Test Specification : FCC 47 CFR PART 15 SUBPART B: Oct., 2010
ANSI C63.4: 2009
CISPR 22: 1997
ICES-003: Issue 4
Receive Date : Nov. 30, 2011
Issue Date : Feb. 01, 2012

Issue by

A Test Lab Techno Corp.
No. 140-1, Changan Street, Bade City,
Taoyuan County 334, Taiwan R.O.C.
Tel : +886-3-2710188 / Fax : +886-3-2710190



Taiwan Accreditation Foundation accreditation number: 1330

Note: This report shall not be reproduced except in full, without the written approval of A Test Lab Techno Corp. This document may be altered or revised by A Test Lab Techno Corp. personnel only, and shall be noted in the revision section of the document. The client should not use it to claim product endorsement by TAF, or any government agencies. The test results in the report only apply to the tested sample.

Revision History

Rev.	Issue Date	Revisions	Revised By
00	Dec. 20, 2011	Initial Issue	
01	Feb. 01, 2012	Add WCDMA band IV test result.	Joyce Liao

Verification of Compliance

Issued Date: 2012/02/01

Product Type : 2G/3G Module
Applicant : Telit Communications S.p.A.
Address : Via Stazione di Prosecco, 5/B, Sgonico, TS 34010, Italy
Trade Name : Telit
Model Number : HE910
FCC ID : RI7HE910
IC : 5131A-HE910
EUT Rated Voltage : DC 3.8V
Test Voltage : DC 3.8V
Applicable : FCC 47 CFR PART 15 SUBPART B: Oct., 2010
Standard : ANSI C63.4: 2009
CISPR 22: 1997
ICES-003: Issue 4
Test Result : Complied
Performing Lab. : A Test Lab Techno Corp.

No. 140-1, Changan Street, Bade City
Taoyuan County 334, Taiwan R.O.C.

Tel : +886-3-2710188 / Fax : +886-3-2710190

Taiwan Accreditation Foundation accreditation number:

1330

<http://www.atl-lab.com.tw/e-index.htm>



The above equipment has been tested by A Test Lab Techno Corp., and found compliance with the requirements set forth in the technical standards mentioned above. The results of testing in this report apply only to the product/system, which was tested. Other similar equipment will not necessarily produce the same results due to production tolerance and measurement uncertainties.

Approved By :



(Manager)

(Murphy Wang)

Reviewed By :



(Testing Engineer)

(Charlie Chang)

TABLE OF CONTENTS

1	General Information	5
2	EUT Description	6
3	Test Methodology.....	7
3.1.	Decision of Test Mode	7
3.2.	EUT System Operation.....	7
3.3.	Configuration of Test System Details.....	8
3.4.	Test Site Environment.....	8
4	Emission Test	9
4.1.	Conducted Emission Measurement	9
4.2.	Radiated Interference Measurement.....	21

1 General Information

1.1 Summary of Test Result

Emission			
Standard	Item	Result	Remark
FCC 47 CFR PART 15 SUBPART B: Oct., 2010 ANSI C63.4: 2009 ICES-003: Issue 4	15.107: Conducted Emission	PASS	Meet Class B limit
FCC 47 CFR PART 15 SUBPART B: Oct., 2010 ANSI C63.4: 2009 ICES-003: Issue 4	15.109: Radiated Emission	PASS	Meet Class B limit

The test results of this report relate only to the tested sample(s) identified in this report. Manufacturer or whom it may concern should recognize the pass or fail of the test result.

1.2 Measurement Uncertainty

Conducted Emission

The measurement uncertainty is evaluated as ± 2.24 dB.

Conducted Emissions (Telecommunication Ports)

The measurement uncertainty is evaluated as ± 2.24 dB.

Radiated Emission

The measurement uncertainty of 30 MHz - 1GHz is evaluated as ± 3.072 dB.

The measurement uncertainty of 1GHz - 40GHz is evaluated as ± 3.072 dB.

2 EUT Description

Product	:	2G/3G Module
Trade Name	:	Telit
Model Number	:	HE910
FCC ID	:	RI7HE910
IC	:	5131A-HE910
Applicant	:	Telit Communications S.p.A. Via Stazione di Prosecco, 5/B, Sgonico, TS 34010, Italy
Manufacturer	:	Telit Communications S.p.A. Via Stazione di Prosecco, 5/B, Sgonico, TS 34010, Italy
Hardware Version	:	0
Software Version	:	12.00.002

I/O Port Description :

I/O PORT TYPES	Q'TY	Test Description
1). Signal Port	1	Connected to Antenna
2). Signal Port	1	Connected to Fixture

3 Test Methodology

3.1. Decision of Test Mode

3.1.1 The following test mode(s) were scanned during the preliminary test:

Pre-Test Mode
Mode 1: GPRS850+GPS with DC Power Mode
Mode 2: GPRS1900+GPS with DC Power Mode
Mode 3: WCDMA Band II+GPS with DC Power Mode
Mode 4: WCDMA Band V+GPS with DC Power Mode
Mode 5: WCDMA Band IV+GPS with DC Power Mode

3.1.2 After the preliminary scan, the following test mode was found to produce the highest emission level.

Final Test Mode			
Emission	Conducted Emission		Mode 1 / Mode 2 / Mode 3 / Mode 4 / Mode 5
	Radiated Emission	Below 1GHz	Mode 1 / Mode 2 / Mode 3 / Mode 4 / Mode 5
		Above 1GHz	Mode 1 / Mode 2 / Mode 3 / Mode 4 / Mode 5

Then, the above highest emission mode of the configuration of the EUT and cable was chosen for all final test items.

3.2. EUT Exercise Software

1. Setup the EUT and simulators as shown on 3.3.
2. Turn on the power of all equipment.
3. The EUT will start to operate function.

3.3. Configuration of Test System Details

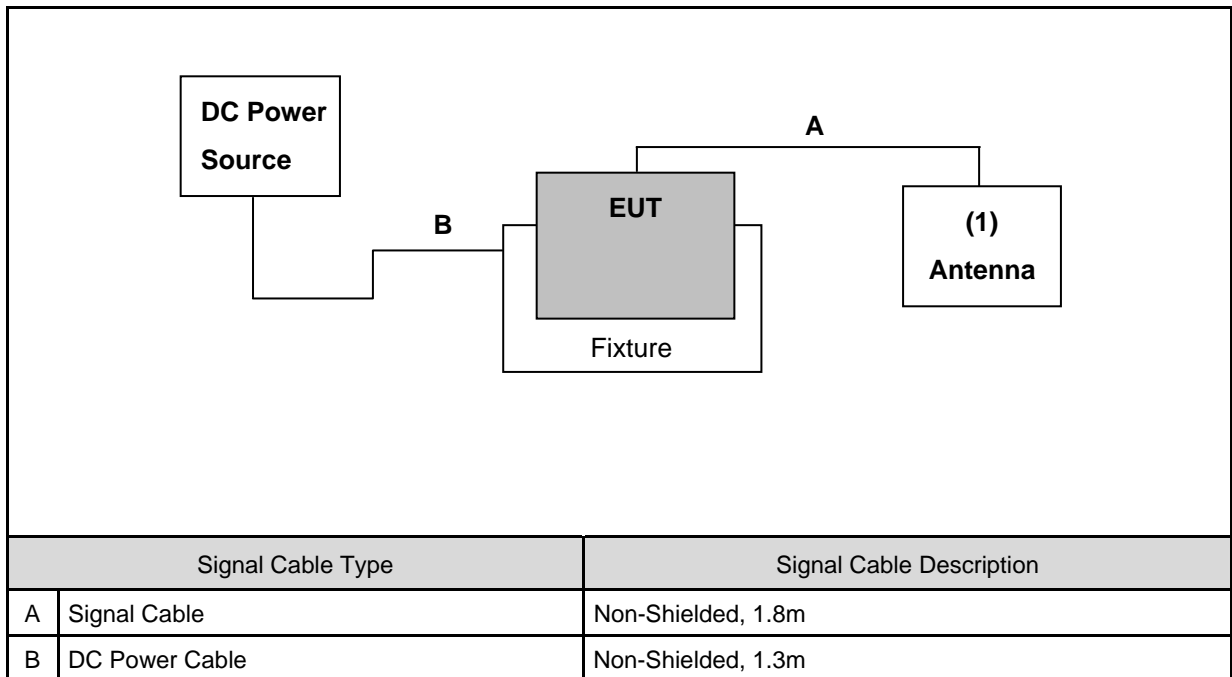

Devices Description					
	Product	Manufacturer	Model Number	Serial Number	Power Cord
1.	Antenna (Max Gain: 2.14 dBi)	Tel Cab	T-AT314	N/A	N/A

3.4. Test Site Environment

Items	Test Item	Required (IEC 68-1)	Actual
Temperature (°C)	FCC part 15: 15.107 Conducted Emission	15-35	22
Humidity (%RH)		25-75	65
Barometric pressure (mbar)		860-1060	950
Temperature (°C)	FCC part 15: 15.109 Radiated Emission	15-35	26
Humidity (%RH)		25-75	60
Barometric pressure (mbar)		860-1060	950

4 Emission Test

4.1. Conducted Emission Measurement

4.1.1. Limit

A.C. Mains Conducted Interference Limit :

Frequency (MHz)	Class A (dBuV)		Class B (dBuV)	
	Quasi-peak	Average	Quasi-peak	Average
0.15 - 0.5	79	66	66 - 56	56 - 46
0.50 - 5.0	73	60	56	46
5.0 - 30.0	73	60	60	50

NOTE: (1) The lower limit shall apply at the transition frequencies.

(2) The limit decreases in line with the logarithm of the frequency in the range 0.15 to 0.50 MHz.

4.1.2. Test Instruments

Description	Manufacturer	Model Number	Serial Number	Cal. Date	Remark
Test Receiver	R&S	ESCI	100367	06/30/2011	(1)
LISN	R&S	ENV216	101040	03/04/2011	(1)
LISN	R&S	ENV216	101041	03/04/2011	(1)
Universal Radio Communication Tester	R&S	CMU200	109369	08/10/2010	(2)
Signal Generator	R&S	SMU200A	102598	02/23/2011	(1)
Test Site	ATL	TE02	TE02	N.C.R.	-----

Remark: (1) Calibration period 1 year. (2) Calibration period 2 years.

NOTE: N.C.R. = No Calibration Request.

4.1.3. Test Setup

A.C. mains setup

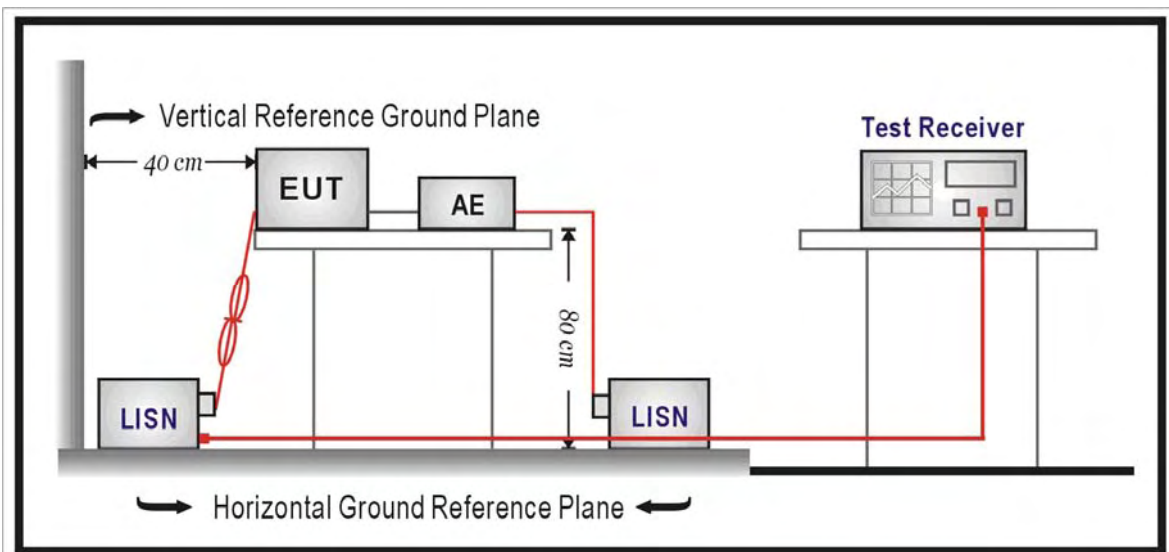

4.1.4. Test Procedure

The EUT and simulators are connected to the main power through a line impedance stabilization network (L.I.S.N.). This provides a 50 ohm /50uH coupling impedance for the measuring equipment. The peripheral devices are also connected to the main power through a LISN that provides a 50ohm/50uH coupling impedance with 50ohm termination.

For A.C. mains conducted interference, measured both sides of A.C. lines and carried out using quasi-peak and average detector receivers of maximum conducted interference.

Conducted emissions were investigated over the frequency range from 0.15 MHz to 30 MHz using a receiver bandwidth of 9 kHz. The equipment under test (EUT) shall be meet the limits in section 4.1.1, as applicable, including the average limit and the quasi-peak limit when using respectively, an average detector and quasi-peak detector measured in accordance with the methods described of related standard. The voltage limits shall be met. If the average limit is met when using a quasi-peak detector receiver, the EUT shall be deemed to meet both limits and measurement with the average detector receiver is unnecessary.

If the reading of the measuring receiver shows fluctuations close to the limit, the reading shall be observed for at least 15 s at each measurement frequency; the higher reading shall be recorded with the exception of any brief isolated high reading which shall be ignored.

4.1.5. Test Result

Standard:	FCC Part 15B Class B	Line:	+
Test item:	Conducted Emission	Power:	DC 3.8V
Model:	HE910	Temp.(°C)/Hum.(%RH):	22(°C)/65%RH
Mode:	Mode 1	Date:	2011/12/01
		Test By:	Charlie Chang
Description:			

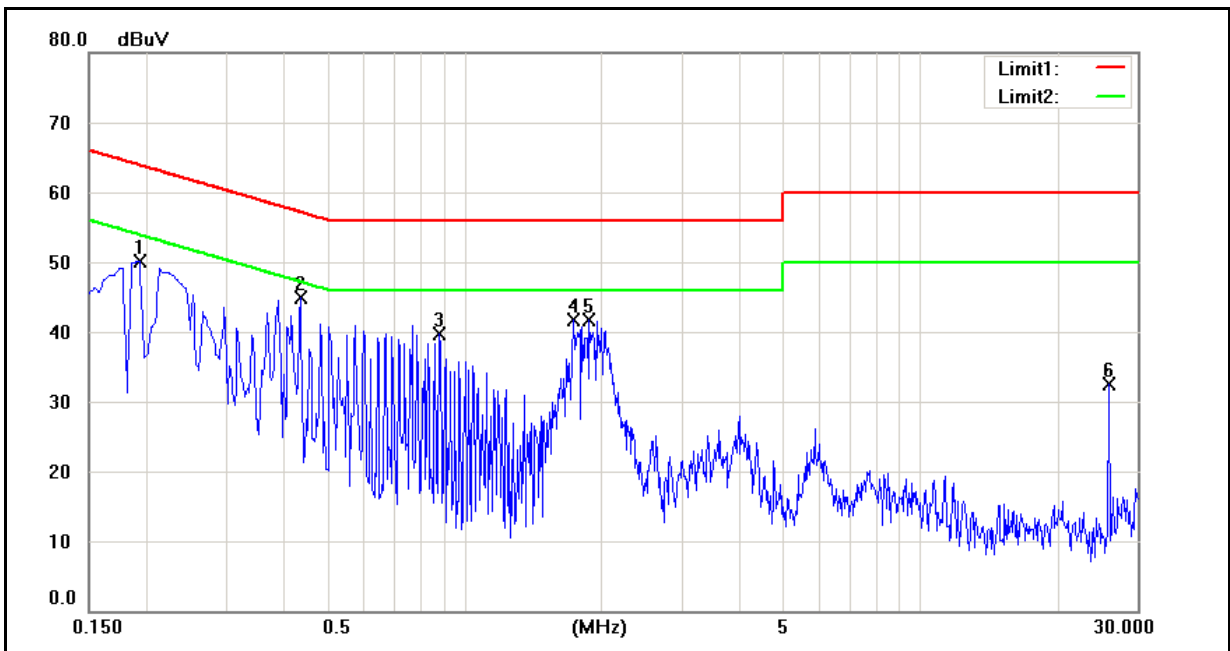

No.	Frequency (MHz)	QP reading (dBuV)	AVG reading (dBuV)	Correction factor (dB)	QP result (dBuV)	AVG result (dBuV)	QP limit (dBuV)	AVG limit (dBuV)	QP margin (dB)	AVG margin (dB)	Remark
1	0.1940	44.25	25.42	0.76	45.01	26.18	63.86	53.86	-18.85	-27.68	Pass
2	0.4380	34.07	16.99	0.53	34.60	17.52	57.10	47.10	-22.50	-29.58	Pass
3	0.8820	29.24	9.74	0.34	29.58	10.08	56.00	46.00	-26.42	-35.92	Pass
4	1.7420	34.90	24.96	0.24	35.14	25.20	56.00	46.00	-20.86	-20.80	Pass
5	1.8780	37.84	29.02	0.23	38.07	29.25	56.00	46.00	-17.93	-16.75	Pass
6	26.0020	25.08	24.38	1.00	26.08	25.38	60.00	50.00	-33.92	-24.62	Pass

Standard:	FCC Part 15B Class B	Line:	-
Test item:	Conducted Emission	Power:	DC 3.8V
Model:	HE910	Temp.(°C)/Hum.(%RH):	22(°C)/65%RH
Mode:	Mode 1	Date:	2011/12/01
		Test By:	Charlie Chang
Description:			

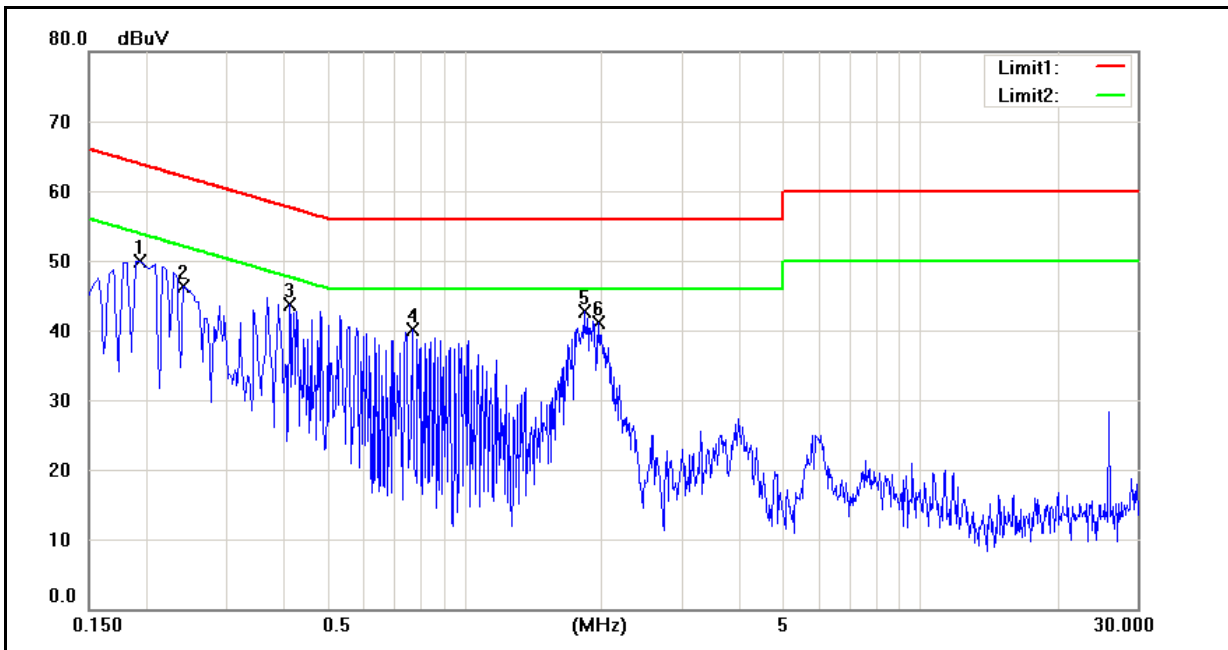

No.	Frequency (MHz)	QP reading (dBuV)	AVG reading (dBuV)	Correction factor (dB)	QP result (dBuV)	AVG result (dBuV)	QP limit (dBuV)	AVG limit (dBuV)	QP margin (dB)	AVG margin (dB)	Remark
1	0.1940	44.41	25.39	0.76	45.17	26.15	63.86	53.86	-18.69	-27.71	Pass
2	0.2430	40.71	23.24	0.70	41.41	23.94	61.99	51.99	-20.58	-28.05	Pass
3	0.4140	34.55	17.72	0.54	35.09	18.26	57.57	47.57	-22.48	-29.31	Pass
4	0.7700	30.18	11.10	0.39	30.57	11.49	56.00	46.00	-25.43	-34.51	Pass
5	1.8380	36.32	27.45	0.23	36.55	27.68	56.00	46.00	-19.45	-18.32	Pass
6	1.9740	35.65	25.96	0.23	35.88	26.19	56.00	46.00	-20.12	-19.81	Pass

Standard:	FCC Part 15B Class B	Line:	+
Test item:	Conducted Emission	Power:	DC 3.8V
Model:	HE910	Temp.(°C)/Hum.(%RH):	22(°C)/65%RH
Mode:	Mode 2	Date:	2011/12/01
		Test By:	Charlie Chang
Description:			

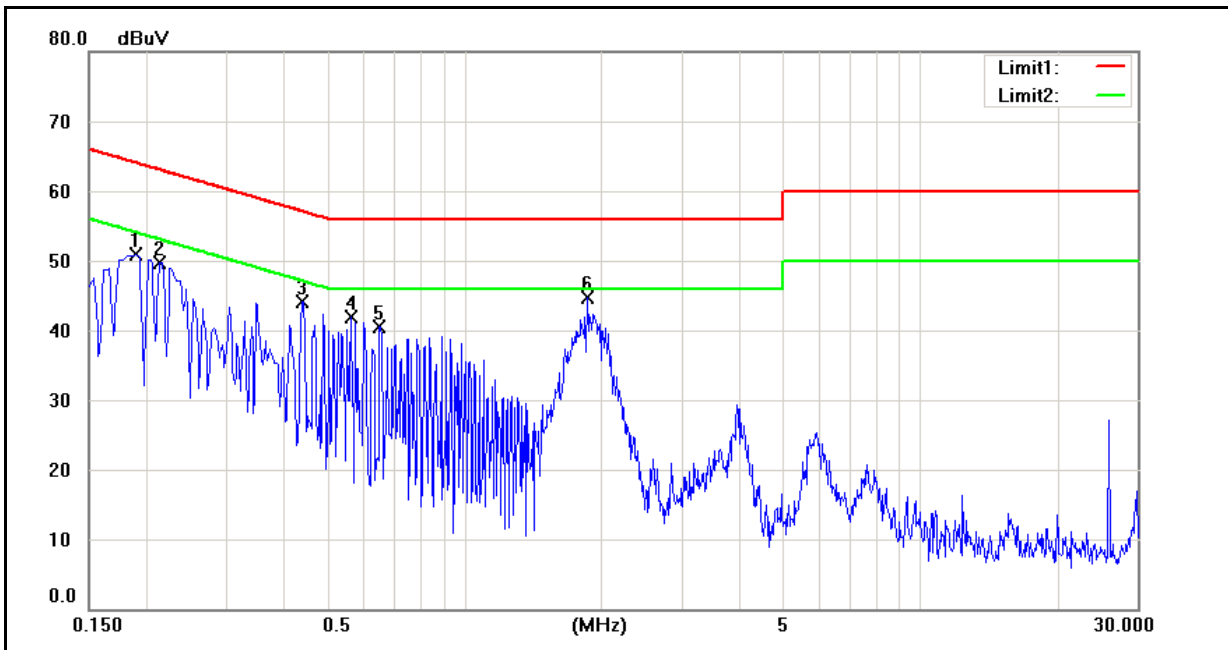

No.	Frequency (MHz)	QP reading (dBuV)	AVG reading (dBuV)	Correction factor (dB)	QP result (dBuV)	AVG result (dBuV)	QP limit (dBuV)	AVG limit (dBuV)	QP margin (dB)	AVG margin (dB)	Remark
1	0.1900	45.58	26.10	0.78	46.36	26.88	64.04	54.04	-17.68	-27.16	Pass
2	0.2162	43.44	24.59	0.73	44.17	25.32	62.96	52.96	-18.79	-27.64	Pass
3	0.4420	34.86	16.58	0.52	35.38	17.10	57.02	47.02	-21.64	-29.92	Pass
4	0.5660	32.54	13.70	0.47	33.01	14.17	56.00	46.00	-22.99	-31.83	Pass
5	0.6540	31.09	10.23	0.44	31.53	10.67	56.00	46.00	-24.47	-35.33	Pass
6	1.8660	36.89	26.96	0.23	37.12	27.19	56.00	46.00	-18.88	-18.81	Pass

Standard:	FCC Part 15B Class B	Line:	-
Test item:	Conducted Emission	Power:	DC 3.8V
Model:	HE910	Temp.(°C)/Hum.(%RH):	22(°C)/65%RH
Mode:	Mode 2	Date:	2011/12/01
		Test By:	Charlie Chang
Description:			

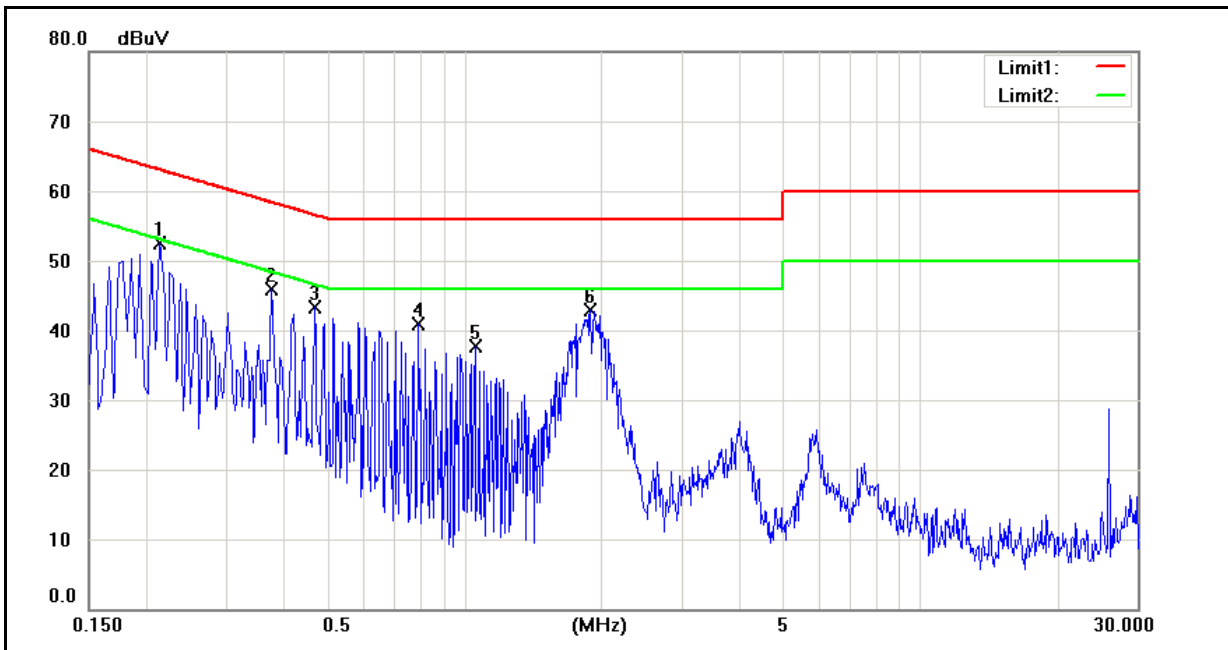

No.	Frequency (MHz)	QP reading (dBuV)	AVG reading (dBuV)	Correction factor (dB)	QP result (dBuV)	AVG result (dBuV)	QP limit (dBuV)	AVG limit (dBuV)	QP margin (dB)	AVG margin (dB)	Remark
1	0.2140	43.80	24.72	0.73	44.53	25.45	63.05	53.05	-18.52	-27.60	Pass
2	0.3780	34.58	19.56	0.57	35.15	20.13	58.32	48.32	-23.17	-28.19	Pass
3	0.4700	34.65	15.27	0.51	35.16	15.78	56.51	46.51	-21.35	-30.73	Pass
4	0.7940	30.55	10.35	0.38	30.93	10.73	56.00	46.00	-25.07	-35.27	Pass
5	1.0580	27.60	11.39	0.28	27.88	11.67	56.00	46.00	-28.12	-34.33	Pass
6	1.8940	38.14	28.99	0.23	38.37	29.22	56.00	46.00	-17.63	-16.78	Pass

Standard:	FCC Part 15B Class B	Line:	+
Test item:	Conducted Emission	Power:	DC 3.8V
Model:	HE910	Temp.(°C)/Hum.(%RH):	22(°C)/65%RH
Mode:	Mode 3	Date:	2011/12/01
		Test By:	Charlie Chang
Description:			

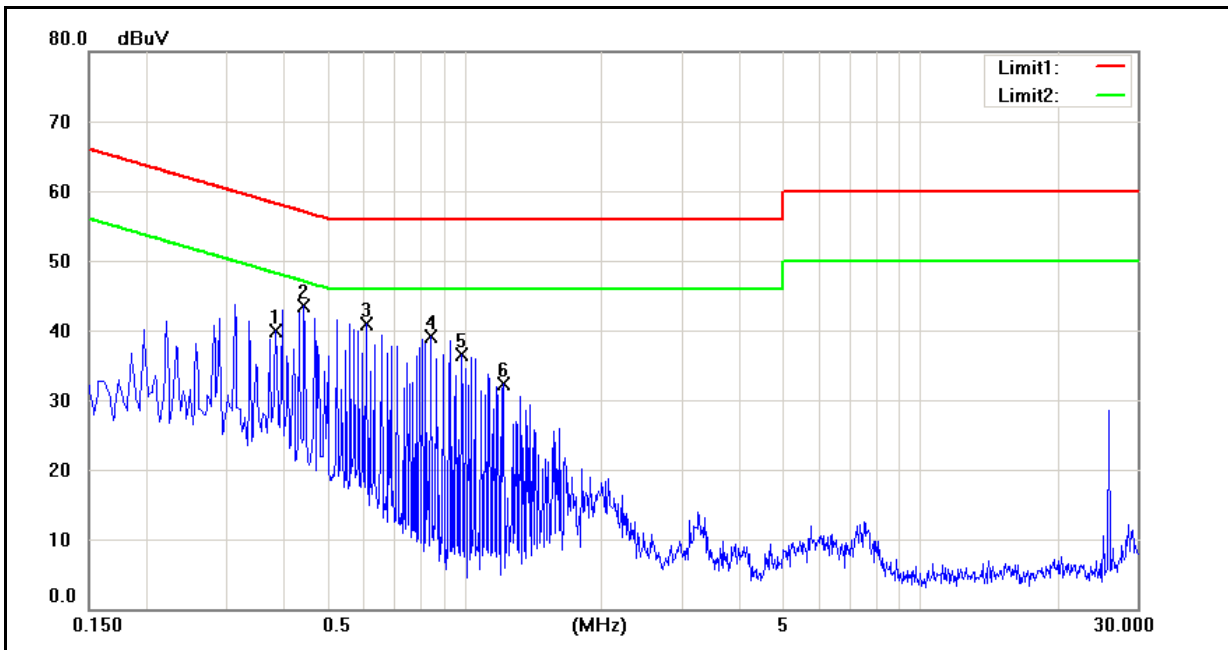

No.	Frequency (MHz)	QP reading (dBuV)	AVG reading (dBuV)	Correction factor (dB)	QP result (dBuV)	AVG result (dBuV)	QP limit (dBuV)	AVG limit (dBuV)	QP margin (dB)	AVG margin (dB)	Remark
1	0.3860	35.18	21.82	0.56	35.74	22.38	58.15	48.15	-22.41	-25.77	Pass
2	0.4460	34.80	15.78	0.52	35.32	16.30	56.95	46.95	-21.63	-30.65	Pass
3	0.6100	31.92	10.82	0.45	32.37	11.27	56.00	46.00	-23.63	-34.73	Pass
4	0.8460	30.00	5.66	0.35	30.35	6.01	56.00	46.00	-25.65	-39.99	Pass
5	0.9860	28.43	4.27	0.30	28.73	4.57	56.00	46.00	-27.27	-41.43	Pass
6	1.2220	23.39	2.22	0.27	23.66	2.49	56.00	46.00	-32.34	-43.51	Pass

Standard:	FCC Part 15B Class B	Line:	-
Test item:	Conducted Emission	Power:	DC 3.8V
Model:	HE910	Temp.(°C)/Hum.(%RH):	22(°C)/65%RH
Mode:	Mode 3	Date:	2011/12/01
		Test By:	Charlie Chang
Description:			

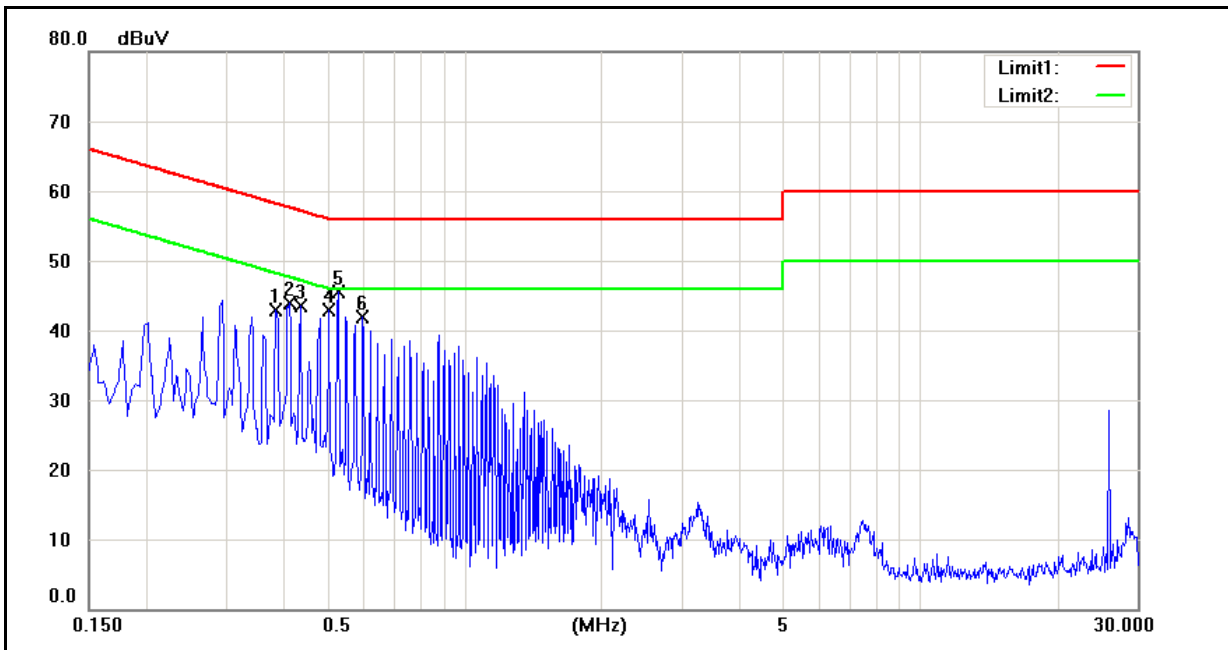

No.	Frequency (MHz)	QP reading (dBuV)	AVG reading (dBuV)	Correction factor (dB)	QP result (dBuV)	AVG result (dBuV)	QP limit (dBuV)	AVG limit (dBuV)	QP margin (dB)	AVG margin (dB)	Remark
1	0.3860	35.17	21.04	0.56	35.73	21.60	58.15	48.15	-22.42	-26.55	Pass
2	0.4140	34.91	16.72	0.54	35.45	17.26	57.57	47.57	-22.12	-30.31	Pass
3	0.4380	34.98	15.98	0.53	35.51	16.51	57.10	47.10	-21.59	-30.59	Pass
4	0.5060	33.34	13.89	0.50	33.84	14.39	56.00	46.00	-22.16	-31.61	Pass
5	0.5300	32.79	13.24	0.49	33.28	13.73	56.00	46.00	-22.72	-32.27	Pass
6	0.5980	32.13	11.13	0.46	32.59	11.59	56.00	46.00	-23.41	-34.41	Pass

Standard:	FCC Part 15B Class B	Line:	+
Test item:	Conducted Emission	Power:	DC 3.8V
Model:	HE910	Temp.(°C)/Hum.(%RH):	22(°C)/65%RH
Mode:	Mode 4	Date:	2011/12/01
		Test By:	Charlie Chang
Description:			

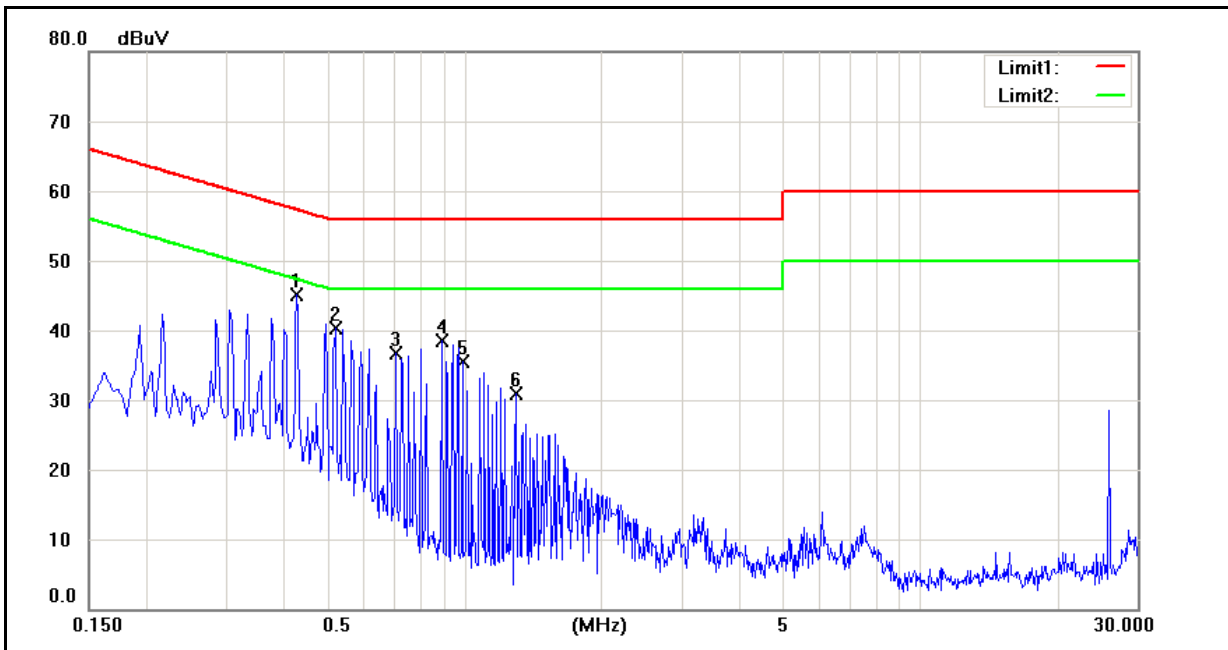

No.	Frequency (MHz)	QP reading (dBuV)	AVG reading (dBuV)	Correction factor (dB)	QP result (dBuV)	AVG result (dBuV)	QP limit (dBuV)	AVG limit (dBuV)	QP margin (dB)	AVG margin (dB)	Remark
1	0.4300	35.07	16.97	0.53	35.60	17.50	57.25	47.25	-21.65	-29.75	Pass
2	0.5220	33.28	13.59	0.49	33.77	14.08	56.00	46.00	-22.23	-31.92	Pass
3	0.7100	30.92	8.21	0.41	31.33	8.62	56.00	46.00	-24.67	-37.38	Pass
4	0.8940	29.18	4.78	0.33	29.51	5.11	56.00	46.00	-26.49	-40.89	Pass
5	0.9900	28.28	3.77	0.29	28.57	4.06	56.00	46.00	-27.43	-41.94	Pass
6	1.2980	22.16	1.85	0.26	22.42	2.11	56.00	46.00	-33.58	-43.89	Pass

Standard:	FCC Part 15B Class B	Line:	-
Test item:	Conducted Emission	Power:	DC 3.8V
Model:	HE910	Temp.(°C)/Hum.(%RH):	22(°C)/65%RH
Mode:	Mode 4	Date:	2011/12/01
		Test By:	Charlie Chang
Description:			

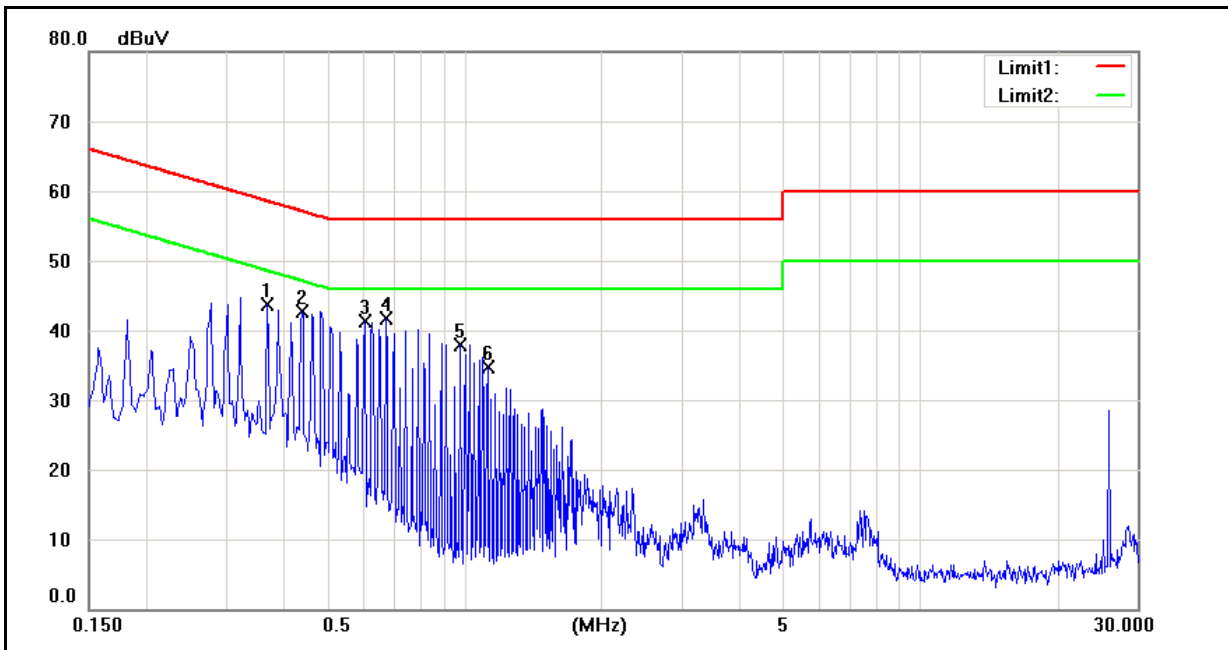

No.	Frequency (MHz)	QP reading (dBuV)	AVG reading (dBuV)	Correction factor (dB)	QP result (dBuV)	AVG result (dBuV)	QP limit (dBuV)	AVG limit (dBuV)	QP margin (dB)	AVG margin (dB)	Remark
1	0.3700	34.42	18.32	0.57	34.99	18.89	58.50	48.50	-23.51	-29.61	Pass
2	0.4420	34.74	16.16	0.52	35.26	16.68	57.02	47.02	-21.76	-30.34	Pass
3	0.6060	32.12	10.95	0.46	32.58	11.41	56.00	46.00	-23.42	-34.59	Pass
4	0.6740	31.03	8.96	0.43	31.46	9.39	56.00	46.00	-24.54	-36.61	Pass
5	0.9820	27.66	4.69	0.30	27.96	4.99	56.00	46.00	-28.04	-41.01	Pass
6	1.1260	25.58	3.07	0.28	25.86	3.35	56.00	46.00	-30.14	-42.65	Pass

Standard:	FCC Part 15B Class B	Line:	+
Test item:	Conducted Emission	Power:	DC 3.8V
Model:	HE910	Temp.(°C)/Hum.(%RH):	22(°C)/65%RH
Mode:	Mode 5	Date:	2012/01/30
		Test By:	Charlie Chang
Description:			

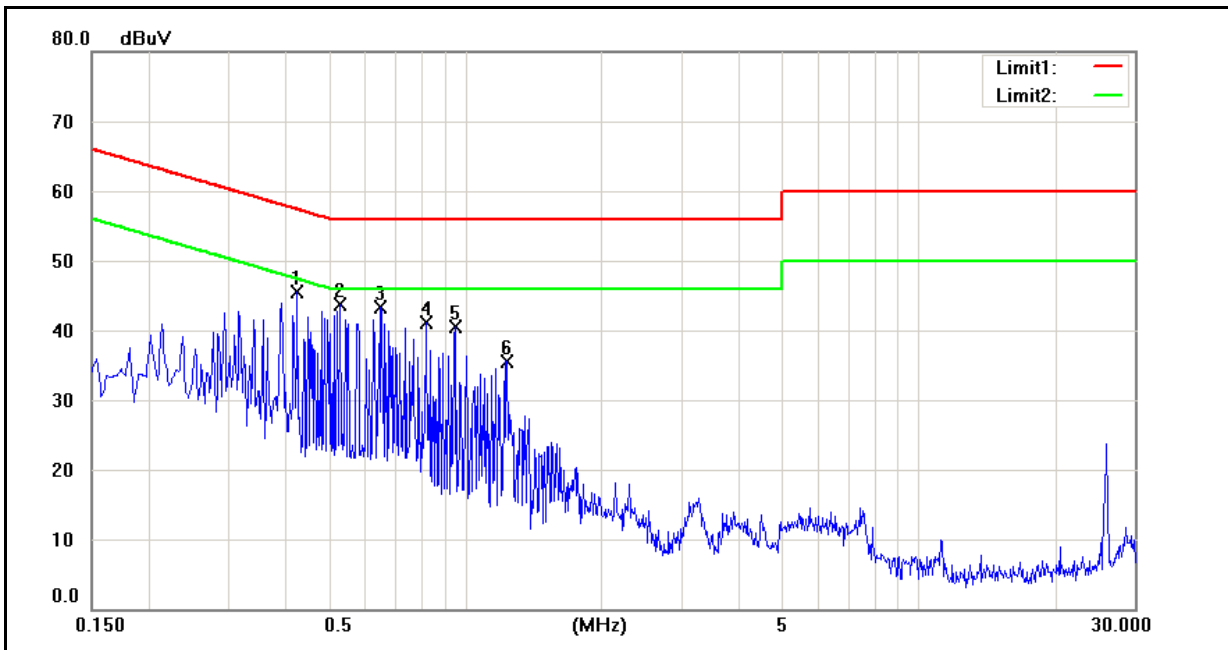

No.	Frequency (MHz)	QP reading (dBuV)	AVG reading (dBuV)	Correction factor (dB)	QP result (dBuV)	AVG result (dBuV)	QP limit (dBuV)	AVG limit (dBuV)	QP margin (dB)	AVG margin (dB)	Remark
1	0.4220	34.61	18.12	0.53	35.14	18.65	57.41	47.41	-22.27	-28.76	Pass
2	0.5340	32.75	13.67	0.49	33.24	14.16	56.00	46.00	-22.76	-31.84	Pass
3	0.6460	31.41	10.18	0.44	31.85	10.62	56.00	46.00	-24.15	-35.38	Pass
4	0.8200	29.98	7.49	0.37	30.35	7.86	56.00	46.00	-25.65	-38.14	Pass
5	0.9620	28.68	5.56	0.31	28.99	5.87	56.00	46.00	-27.01	-40.13	Pass
6	1.2440	22.35	3.18	0.27	22.62	3.45	56.00	46.00	-33.38	-42.55	Pass

Standard:	FCC Part 15B Class B	Line:	-
Test item:	Conducted Emission	Power:	DC 3.8V
Model:	HE910	Temp.(°C)/Hum.(%RH):	22(°C)/65%RH
Mode:	Mode 5	Date:	2012/01/30
		Test By:	Charlie Chang
Description:			

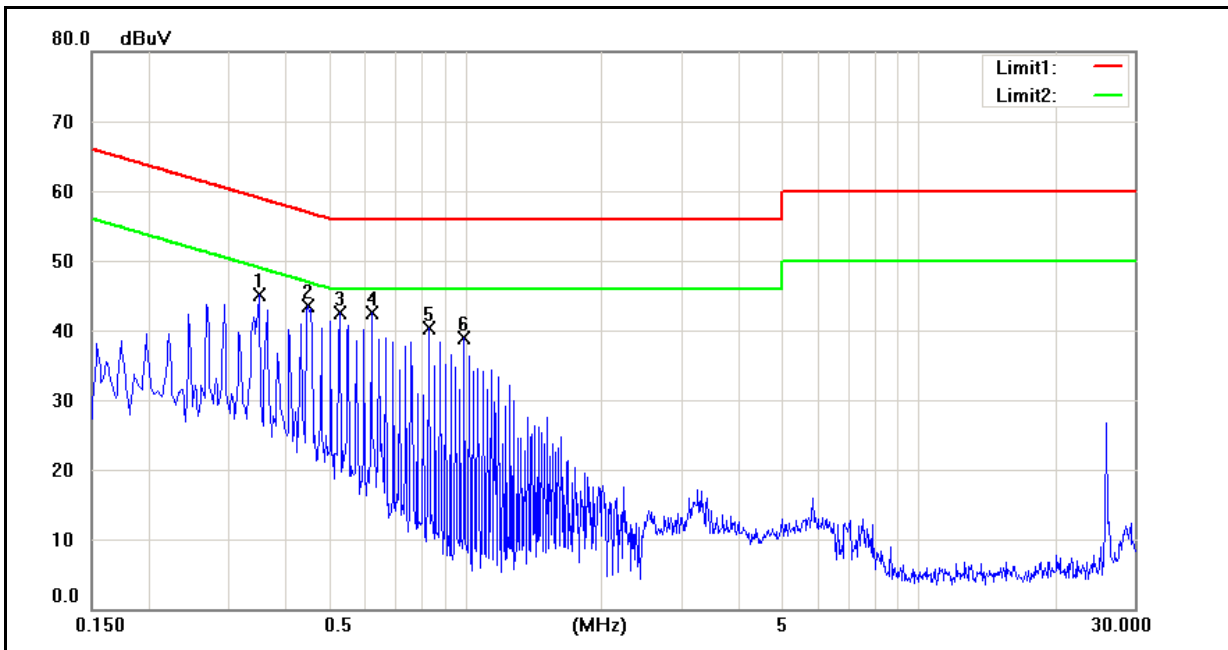

No.	Frequency (MHz)	QP reading (dBuV)	AVG reading (dBuV)	Correction factor (dB)	QP result (dBuV)	AVG result (dBuV)	QP limit (dBuV)	AVG limit (dBuV)	QP margin (dB)	AVG margin (dB)	Remark
1	0.3520	33.69	18.32	0.59	34.28	18.91	58.92	48.92	-24.64	-30.01	Pass
2	0.4460	34.53	16.17	0.52	35.05	16.69	56.95	46.95	-21.90	-30.26	Pass
3	0.5300	32.83	13.14	0.49	33.32	13.63	56.00	46.00	-22.68	-32.37	Pass
4	0.6220	31.51	10.29	0.45	31.96	10.74	56.00	46.00	-24.04	-35.26	Pass
5	0.8340	29.70	6.65	0.36	30.06	7.01	56.00	46.00	-25.94	-38.99	Pass
6	0.9960	27.73	5.69	0.29	28.02	5.98	56.00	46.00	-27.98	-40.02	Pass

4.2. Radiated Interference Measurement

4.2.1. Limit

Under 1GHz test shall not exceed following value:

FCC 47 CFR PART 15 SUBPART B				
Frequency range (MHz)	Class A		Class B	
	Distance (m)	dBuV/m	Distance (m)	dBuV/m
30 to 88	10	39	3	40
88 to 216	10	43.5	3	43.5
216 to 960	10	46.4	3	46
Above 960	10	49.5	3	54

CISPR 22				
Frequency range (MHz)	Class A		Class B	
	Distance (m)	dBuV/m	Distance (m)	dBuV/m
30 to 230	10	40	10	30
230 to 1000	10	47	10	37

Above 1GHz test shall not exceed following value:

Frequency (MHz)	dBuV/m (Distance 3m)			
	Class A		Class B	
	Average	Peak	Average	Peak
1000 ~ 40000	49.5	69.5	54	74

Remark:

1. The tighter limit shall apply at the edge between two frequency bands.
2. Distance refers to the distance in meters between the measuring instrument antenna and the closed point of any part of the device or system.
3. RF Voltage (dBuV/m) = 20 log RF Voltage (uV/m)
4. Peak detector limit is corresponding to 20 dB above the maximum permitted average limit.

4.2.2. Test Instruments

3 Meter Chamber					
Equipment	Manufacturer	Model Number	Serial Number	Cal. Date	Remark
Spectrum Analyzer	Agilent	E4445A	MY46181986	06/16/2011	(1)
Amplifier	Mini-Circuits	ZKL-1R5+	N/A	05/30/2011	(1)
Amplifier	Mini-Circuits	ZVA-213-S+	N/A	05/30/2011	(1)
RF Pre-selector	Agilent	N9039A	MY46520255	05/16/2011	(1)
Double-Ridged Waveguide Horn	ETS-Lindgren	3117	00128055	08/25/2011	(1)
Trilog-Broadband Antenna	Schwarzbeck Mess-Elektronik	SB AC VULB	9168-419	05/10/2011	(1)
Universal Radio Communication Tester	R&S	CMU200	109369	08/10/2010	(2)
Signal Generator	R&S	SMU200A	102598	02/23/2011	(1)
Test Site	ATL	TE09	TE09	05/13/2011	(1)

10 Meter Chamber					
Equipment	Manufacturer	Model Number	Serial Number	Cal. Date	Remark
Pre Amplifier	Agilent	8447D	2944A11120	01/11/2011	(1)
Pre Amplifier	Agilent	8447D	2944A11119	01/11/2011	(1)
Test Receiver	R&S	ESCI	100722	10/18/2011	(1)
Test Receiver	R&S	ESCI	101000	12/26/2011	(1)
Broadband Antenna	SCHWARZBECK MESS-ELEKTRONIK	VULB 9160	9160-3268	07/01/2011	(1)
Broadband Antenna	SCHWARZBECK MESS-ELEKTRONIK	VULB 9160	9160-3273	12/27/2011	(1)
Horn Antenna (1~18GHz)	SCHWARZBECK MESS-ELEKTRONIK	BBHA9120D	9120D-550	06/29/2011	(1)
Horn Antenna (18~40GHz)	SCHWARZBECK MESS-ELEKTRONIK	BBHA9170	9170-320	06/28/2011	(1)
Universal Radio Communication Tester	R&S	CMU200	109369	08/10/2010	(2)
Signal Generator	R&S	SMU200A	102598	02/23/2011	(1)
Test Site	ATL	TE06	TE06	09/05/2011	(1)

Remark: ⁽¹⁾ Calibration period 1 year. ⁽²⁾ Calibration period 2 years.

NOTE: N.C.R. = No Calibration Request.

4.2.3. Setup

Below 1GHz

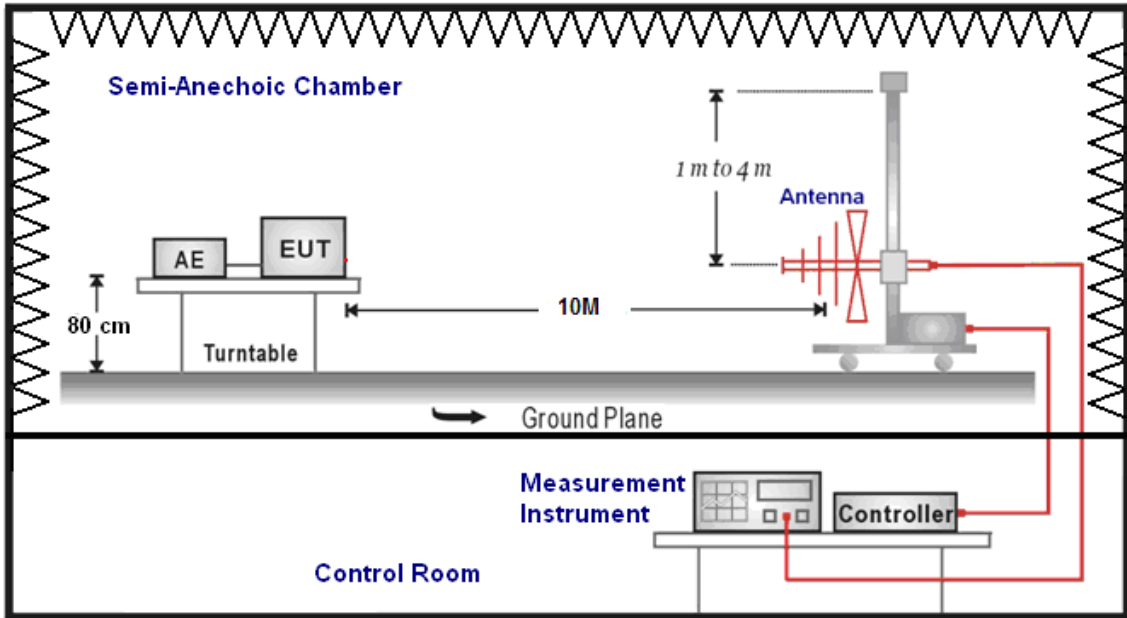

Above 1GHz

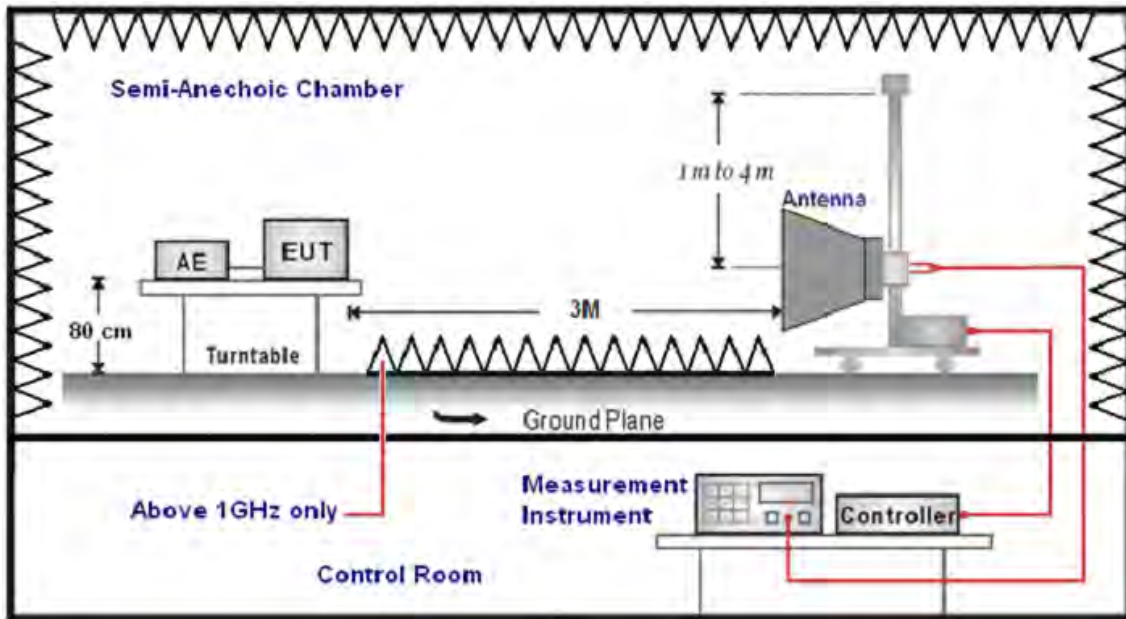

4.2.4. Test Procedure

The EUT and its simulators are placed on a turn table which is 0.8 meter above ground. When the EUT is floor-standing equipment, it is placed on the ground plane which has a 3-12 mm non-conductive covering to insulate the EUT from the ground plane.

The turn table can rotate 360 degrees to determine the position of the maximum emission level. The EUT was positioned such that the distance from antenna to the EUT was 10 meters for under 1GHz, and 3 meter for above 1GHz, the highest frequency performed according to internal source frequency of the EUT, the specification was below:

Highest frequency generated or used in the device or on which the device operates or tunes (MHz)	Upper frequency of measurement range (MHz)
Below 1.705	30
1.705 - 108	1000
108 - 500	2000
500 - 1000	5000
Above 1000	5th harmonic of the highest frequency or 40 GHz, whichever is lower

According to this standard paragraph 15.109, as an alternative to the radiated emission limits, digital devices may be shown to comply with the standards contained in Third Edition of the International Special Committee on Radio Interference (CISPR), Pub. 22, "Information Technology Equipment - Radio Disturbance Characteristics - Limits and Methods of Measurement".

The antenna can move up and down between 1 meter and 4 meters to find out the maximum emission level. Both horizontal and vertical polarization of the antenna are set on measurement. In order to find the maximum emission, all of the interface cables must be manipulated on radiated measurement.

Radiated emissions were investigated over the frequency range from 30MHz to 1GHz using a receiver bandwidth of 120 kHz. Radiated was performed at an antenna to EUT distance of 10 meters.

4.2.5. Test Result

Standard:	CISPR 22 Class B	Test Distance:	10m
Test item:	Radiated Emission	Power:	DC 3.8V
Model:	HE910	Temp.(°C)/Hum.(%RH):	26(°C)/60%RH
Mode:	Mode 1	Date:	2011/12/02
Ant.Polar.:	Horizontal	Test By:	Charlie Chang

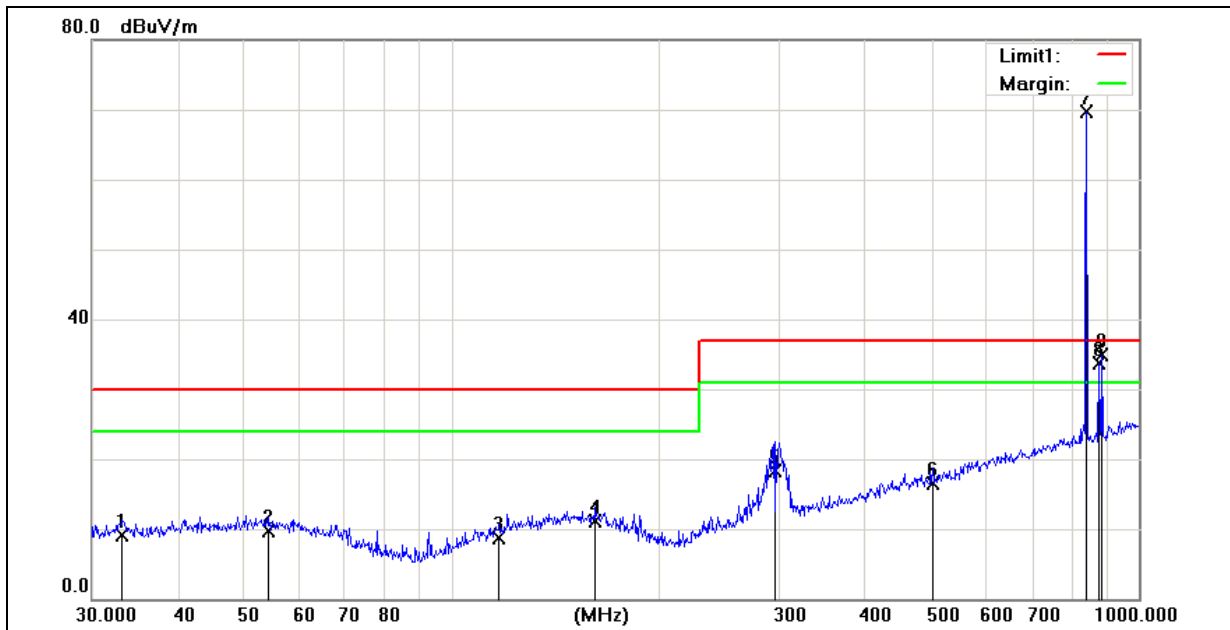

No.	Frequency (MHz)	Reading (dBuV)	Correct Factor(dB/m)	Result (dBuV/m)	Limit (dBuV/m)	Margin (dB)	Height (cm)	Degree (°)	Remark
1	33.2112	24.55	-15.35	9.20	30.00	-20.80	294	0	QP
2	54.0711	24.21	-14.51	9.70	30.00	-20.30	400	337	QP
3	117.3603	23.34	-14.54	8.80	30.00	-21.20	200	303	QP
4	162.0414	24.00	-12.80	11.20	30.00	-18.80	100	359	QP
5	296.1836	30.01	-11.61	18.40	37.00	-18.60	400	0	QP
6	501.1790	24.35	-7.85	16.50	37.00	-20.50	300	52	QP
7	839.1818	71.39	-1.69	69.70	N/A	N/A	400	10	TX
8	875.2470	34.69	-1.03	33.66	N/A	N/A	300	21	BS
9	884.5030	35.83	-0.87	34.96	N/A	N/A	400	0	RX

Note: TX: the transmitting signal of Universal Radio Communication Tester.

RX: the receiving signal of Universal Radio Communication Tester.

BS: the signal of Universal Radio Communication Tester.

Standard:	CISPR 22 Class B	Test Distance:	10m
Test item:	Radiated Emission	Power:	DC 3.8V
Model:	HE910	Temp.(°C)/Hum.(%RH):	26(°C)/60%RH
Mode:	Mode 1	Date:	2011/12/02
Ant.Polar.:	Vertical	Test By:	Charlie Chang

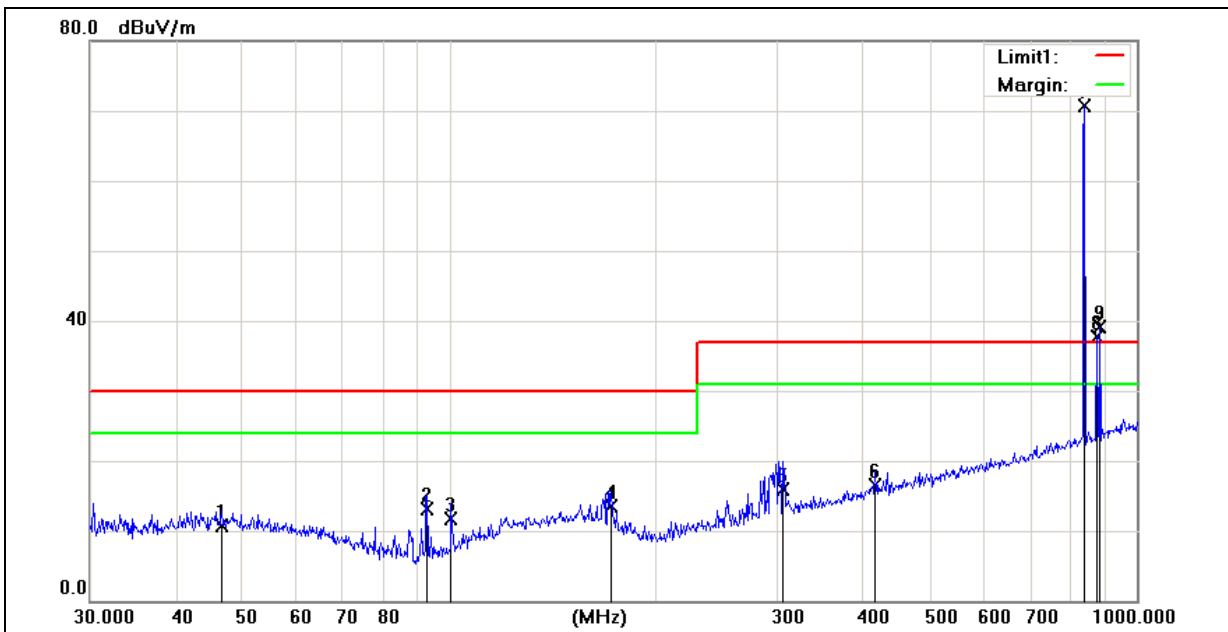

No.	Frequency (MHz)	Reading (dBuV)	Correct Factor(dB/m)	Result (dBuV/m)	Limit (dBuV/m)	Margin (dB)	Height (cm)	Degree (°)	Remark
1	46.6664	24.16	-13.36	10.80	30.00	-19.20	100	6	QP
2	92.7871	31.24	-18.14	13.10	30.00	-16.90	300	360	QP
3	100.5806	28.49	-16.69	11.80	30.00	-18.20	200	329	QP
4	171.9946	25.75	-12.15	13.60	30.00	-16.40	100	4	QP
5	305.6800	25.89	-9.99	15.90	37.00	-21.10	100	13	QP
6	416.1791	24.17	-7.67	16.50	37.00	-20.50	100	348	QP
7	839.1818	70.42	0.35	70.77	N/A	N/A	100	16	TX
8	875.2470	36.74	1.02	37.76	N/A	N/A	100	225	BS
9	884.5030	37.90	1.16	39.06	N/A	N/A	100	0	RX

Note: TX: the transmitting signal of Universal Radio Communication Tester.

RX: the receiving signal of Universal Radio Communication Tester.

BS: the signal of Universal Radio Communication Tester.

Standard:	FCC Part 15B Class B	Test Distance:	3m
Test item:	Radiated Emission	Power:	DC 3.8V
Model:	HE910	Temp.(°C)/Hum.(%RH):	26(°C)/60%RH
Mode:	Mode 1 (1GHz~6GHz)	Date:	2011/12/02
Ant.Polar.:	Horizontal	Test By:	Charlie Chang

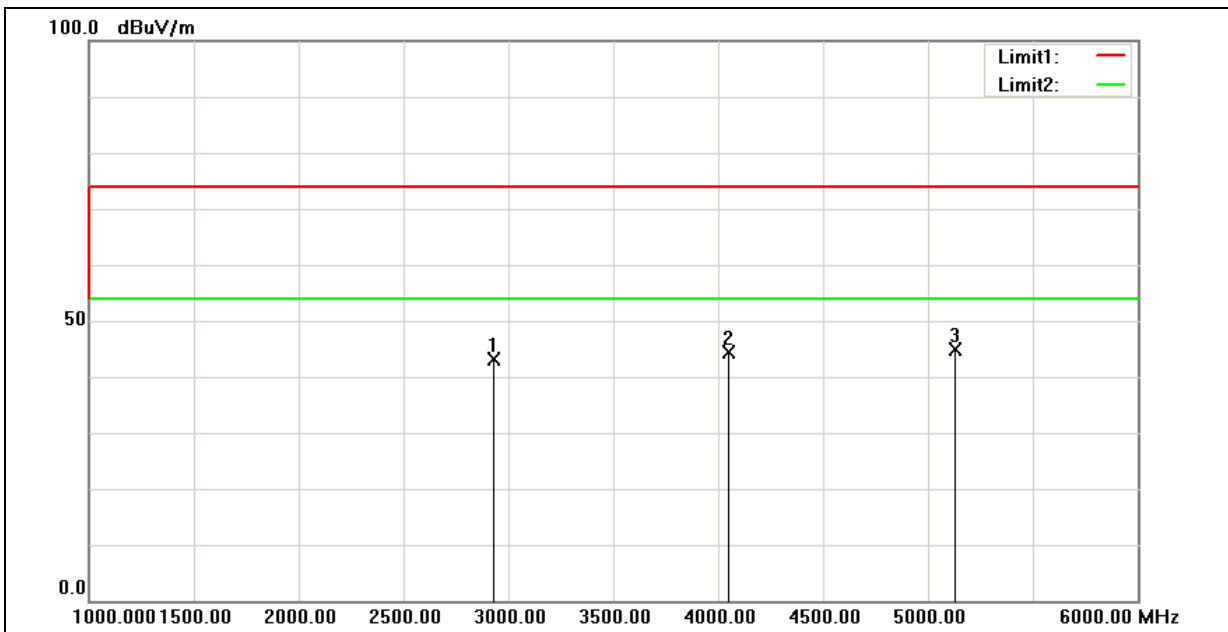

No.	Frequency (MHz)	Reading (dBuV)	Correct Factor(dB/m)	Result (dBuV/m)	Limit (dBuV/m)	Margin (dB)	Remark
1	2930.000	60.12	-16.87	43.25	74.00	-30.75	peak
2	4050.000	58.72	-14.36	44.36	74.00	-29.64	peak
3	5130.000	57.22	-12.40	44.82	74.00	-29.18	peak

Standard:	FCC Part 15B Class B	Test Distance:	3m
Test item:	Radiated Emission	Power:	DC 3.8V
Model:	HE910	Temp.(°C)/Hum.(%RH):	26(°C)/60%RH
Mode:	Mode 1 (1GHz~6GHz)	Date:	2011/12/02
Ant.Polar.:	Vertical	Test By:	Charlie Chang

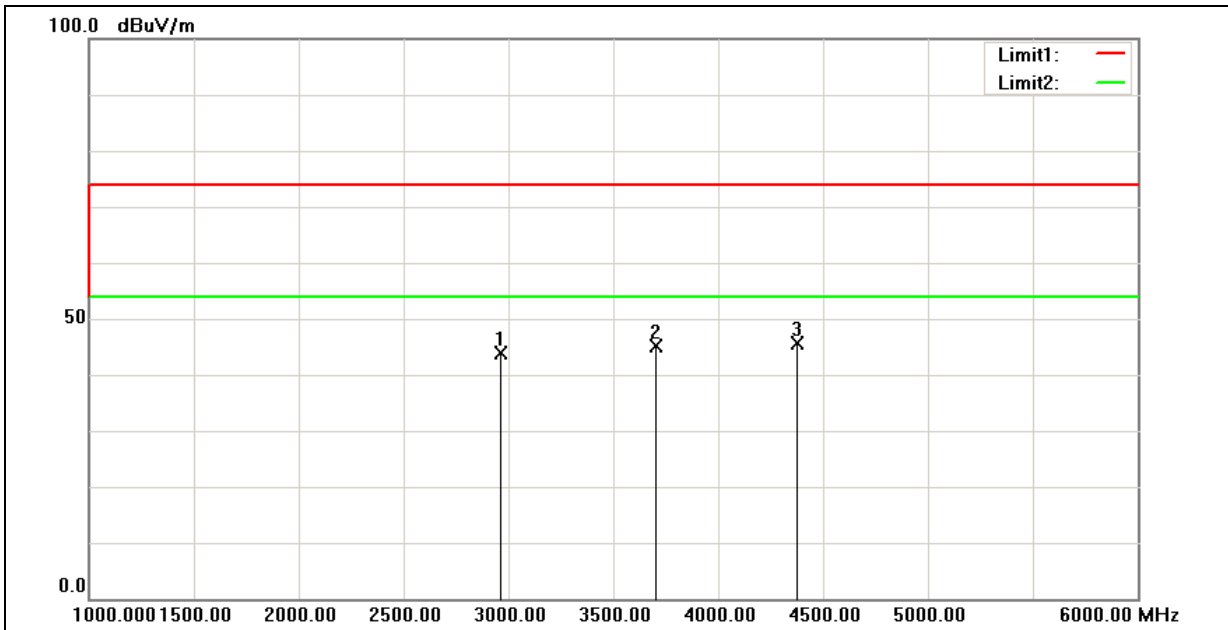

No.	Frequency (MHz)	Reading (dBuV)	Correct Factor(dB/m)	Result (dBuV/m)	Limit (dBuV/m)	Margin (dB)	Remark
1	2965.000	60.55	-16.78	43.77	74.00	-30.23	peak
2	3705.000	60.55	-15.47	45.08	74.00	-28.92	peak
3	4375.000	59.13	-13.49	45.64	74.00	-28.36	peak

Standard:	CISPR 22 Class B	Test Distance:	10m
Test item:	Radiated Emission	Power:	DC 3.8V
Model:	HE910	Temp.(°C)/Hum.(%RH):	26(°C)/60%RH
Mode:	Mode 2	Date:	2011/12/02
Ant.Polar.:	Horizontal	Test By:	Charlie Chang

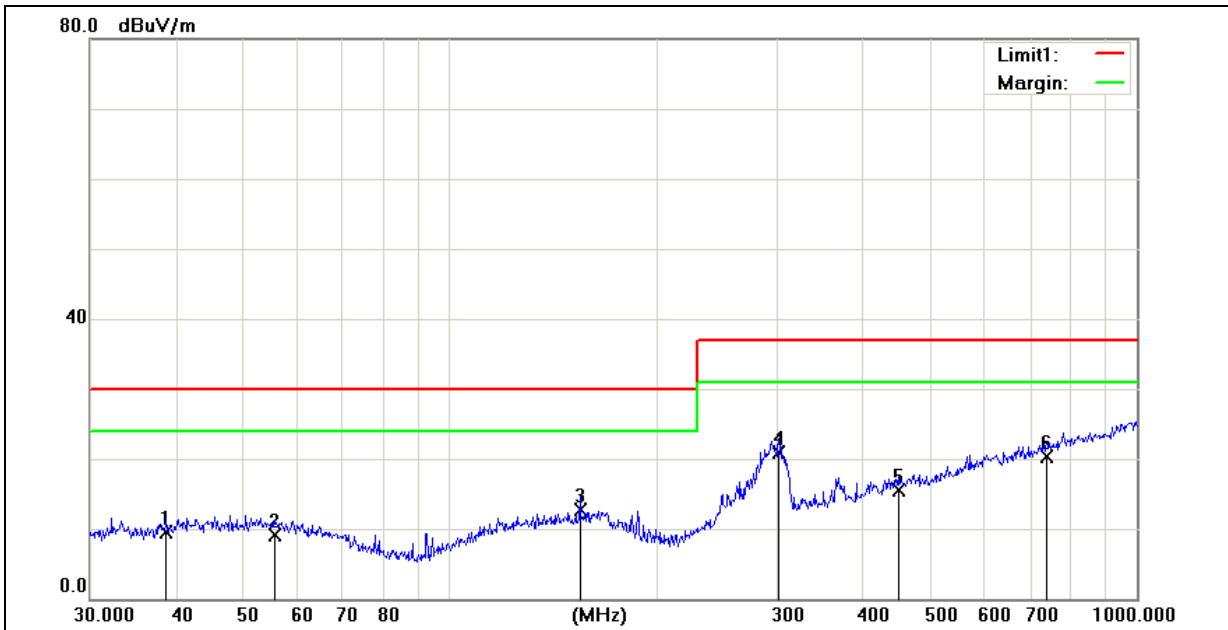

No.	Frequency (MHz)	Reading (dBuV)	Correct Factor(dB/m)	Result (dBuV/m)	Limit (dBuV/m)	Margin (dB)	Height (cm)	Degree (°)	Remark
1	38.7518	24.56	-14.96	9.60	30.00	-20.40	399	237	QP
2	55.6094	23.81	-14.61	9.20	30.00	-20.80	100	146	QP
3	154.8204	25.74	-12.94	12.80	30.00	-17.20	200	0	QP
4	301.4224	32.31	-11.41	20.90	37.00	-16.10	300	21	QP
5	449.5558	23.93	-8.43	15.50	37.00	-21.50	200	0	QP
6	739.6604	23.44	-3.04	20.40	37.00	-16.60	173	360	QP

Standard:	CISPR 22 Class B	Test Distance:	10m
Test item:	Radiated Emission	Power:	DC 3.8V
Model:	HE910	Temp.(°C)/Hum.(%RH):	26(°C)/60%RH
Mode:	Mode 2	Date:	2011/12/02
Ant.Polar.:	Vertical	Test By:	Charlie Chang

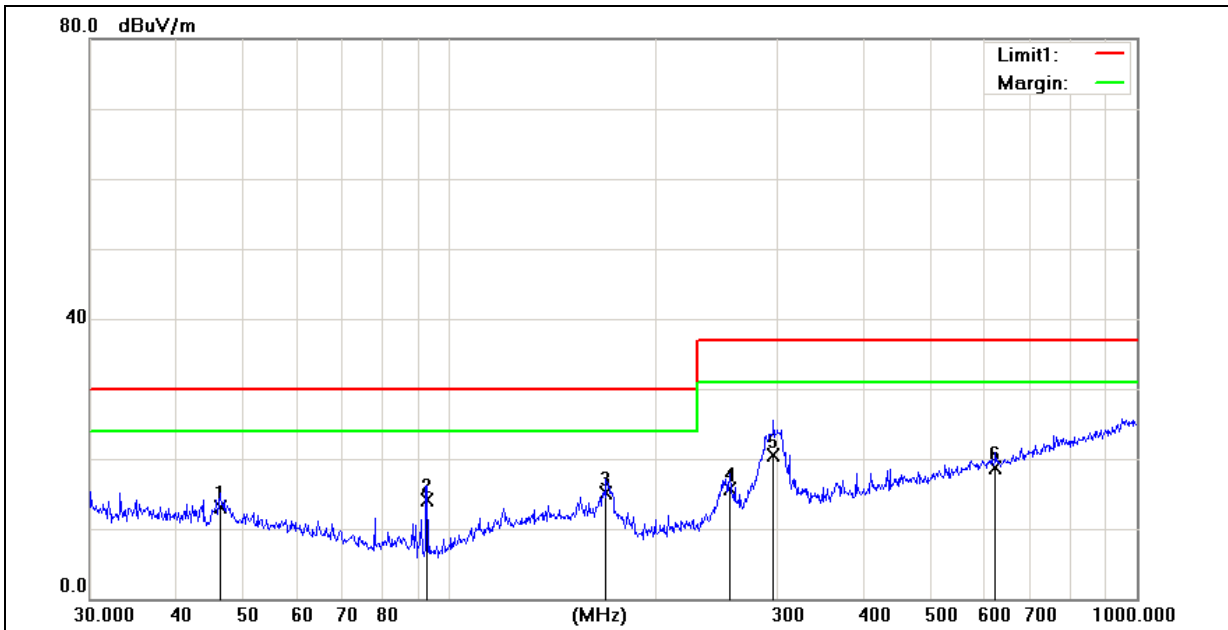

No.	Frequency (MHz)	Reading (dBuV)	Correct Factor(dB/m)	Result (dBuV/m)	Limit (dBuV/m)	Margin (dB)	Height (cm)	Degree (°)	Remark
1	46.3402	26.46	-13.36	13.10	30.00	-16.90	104	360	QP
2	92.7871	32.24	-18.14	14.10	30.00	-15.90	199	120	QP
3	169.0054	27.02	-11.92	15.10	30.00	-14.90	100	360	QP
4	255.6231	27.56	-11.76	15.80	37.00	-21.20	100	128	QP
5	296.1836	30.75	-10.25	20.50	37.00	-16.50	300	40	QP
6	622.8900	22.43	-3.63	18.80	37.00	-18.20	400	82	QP

Standard:	FCC Part 15B Class B	Test Distance:	3m
Test item:	Radiated Emission	Power:	DC 3.8V
Model:	HE910	Temp.(°C)/Hum.(%RH):	26(°C)/60%RH
Mode:	Mode 2 (1GHz~6GHz)	Date:	2011/12/02
Ant.Polar.:	Horizontal	Test By:	Charlie Chang

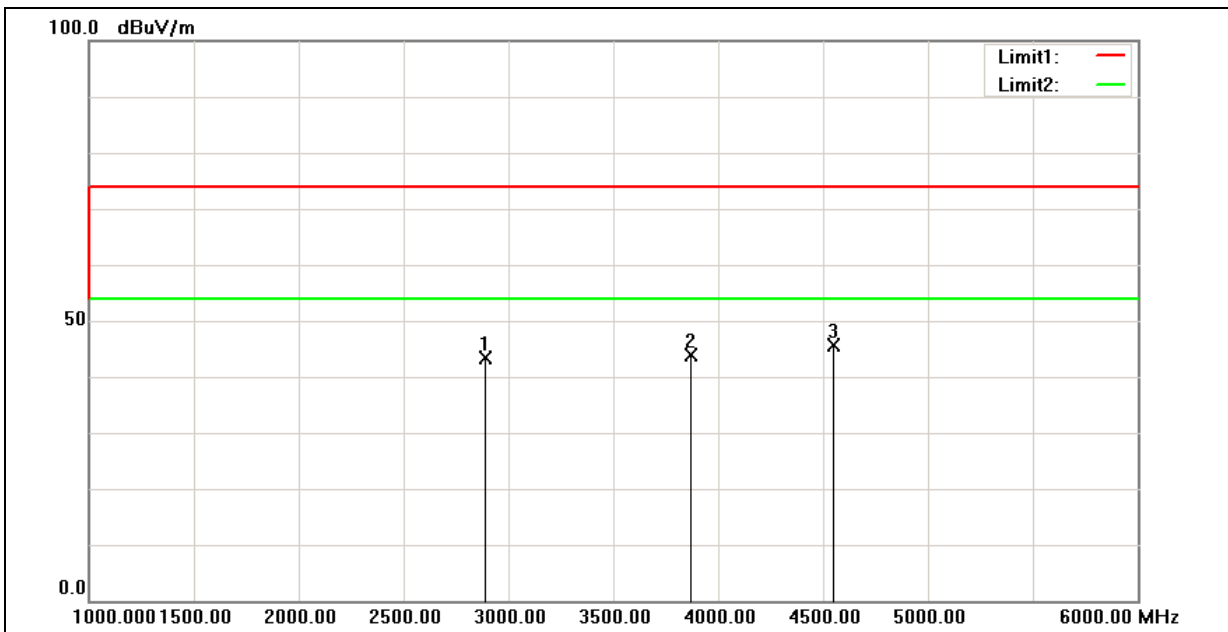

No.	Frequency (MHz)	Reading (dBuV)	Correct Factor(dB/m)	Result (dBuV/m)	Limit (dBuV/m)	Margin (dB)	Remark
1	2890.000	60.41	-17.00	43.41	74.00	-30.59	peak
2	3870.000	58.77	-14.93	43.84	74.00	-30.16	peak
3	4550.000	58.71	-13.10	45.61	74.00	-28.39	peak

Standard:	FCC Part 15B Class B	Test Distance:	3m
Test item:	Radiated Emission	Power:	DC 3.8V
Model:	HE910	Temp.(°C)/Hum.(%RH):	26(°C)/60%RH
Mode:	Mode 2 (1GHz~6GHz)	Date:	2011/12/02
Ant.Polar.:	Vertical	Test By:	Charlie Chang

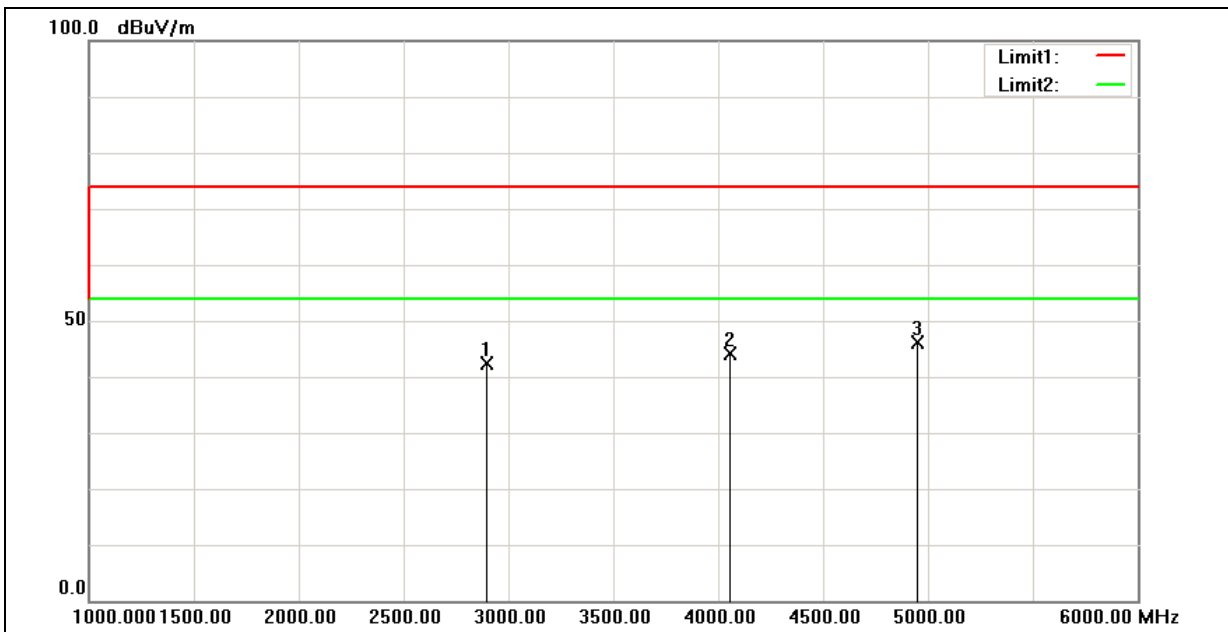

No.	Frequency (MHz)	Reading (dBuV)	Correct Factor(dB/m)	Result (dBuV/m)	Limit (dBuV/m)	Margin (dB)	Remark
1	2895.000	59.43	-16.98	42.45	74.00	-31.55	peak
2	4055.000	58.41	-14.36	44.05	74.00	-29.95	peak
3	4950.000	58.76	-12.67	46.09	74.00	-27.91	peak

Standard:	CISPR 22 Class B	Test Distance:	10m
Test item:	Radiated Emission	Power:	DC 3.8V
Model:	HE910	Temp.(°C)/Hum.(%RH):	26(°C)/60%RH
Mode:	Mode 3	Date:	2011/12/02
Ant.Polar.:	Horizontal	Test By:	Charlie Chang

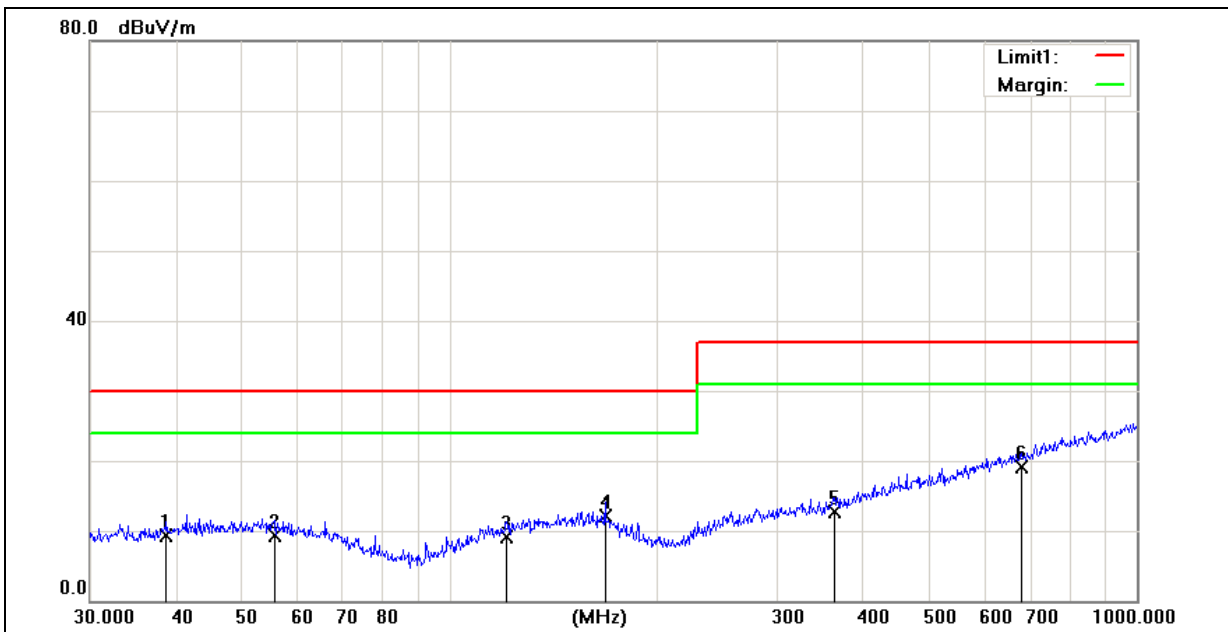

No.	Frequency (MHz)	Reading (dBuV)	Correct Factor(dB/m)	Result (dBuV/m)	Limit (dBuV/m)	Margin (dB)	Height (cm)	Degree (°)	Remark
1	38.7518	24.26	-14.96	9.30	30.00	-20.70	300	327	QP
2	55.6094	24.01	-14.61	9.40	30.00	-20.60	200	204	QP
3	121.1231	23.34	-14.24	9.10	30.00	-20.90	300	1	QP
4	168.4138	25.16	-13.06	12.10	30.00	-17.90	400	54	QP
5	362.9844	23.33	-10.53	12.80	37.00	-24.20	300	1	QP
6	679.9600	23.54	-4.44	19.10	37.00	-17.90	400	241	QP

Standard:	CISPR 22 Class B	Test Distance:	10m
Test item:	Radiated Emission	Power:	DC 3.8V
Model:	HE910	Temp.(°C)/Hum.(%RH):	26(°C)/60%RH
Mode:	Mode 3	Date:	2011/12/02
Ant.Polar.:	Vertical	Test By:	Charlie Chang

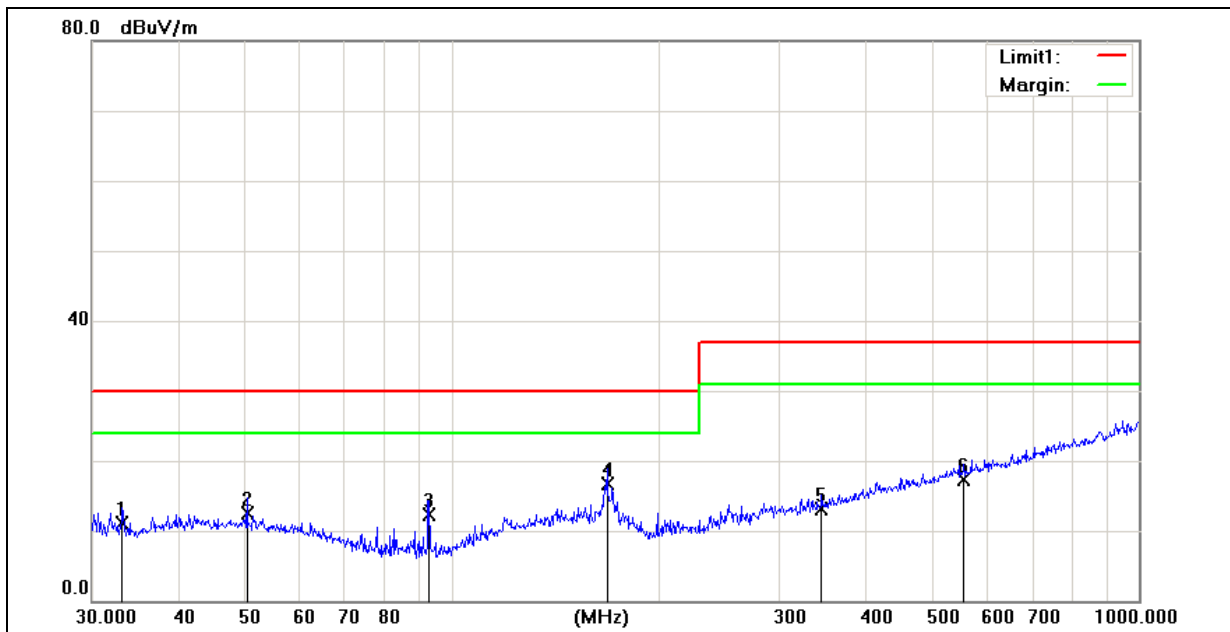

No.	Frequency (MHz)	Reading (dBuV)	Correct Factor(dB/m)	Result (dBuV/m)	Limit (dBuV/m)	Margin (dB)	Height (cm)	Degree (°)	Remark
1	33.2112	25.67	-14.47	11.20	30.00	-18.80	100	0	QP
2	50.4090	25.96	-13.36	12.60	30.00	-17.40	100	88	QP
3	92.7871	30.54	-18.14	12.40	30.00	-17.60	200	313	QP
4	168.4138	28.72	-11.92	16.80	30.00	-13.20	100	343	QP
5	345.5952	22.31	-9.21	13.10	37.00	-23.90	189	0	QP
6	556.7744	22.42	-5.02	17.40	37.00	-19.60	100	0	QP

Standard:	FCC Part 15B Class B	Test Distance:	3m
Test item:	Radiated Emission	Power:	DC 3.8V
Model:	HE910	Temp.(°C)/Hum.(%RH):	26(°C)/60%RH
Mode:	Mode 3 (1GHz~6GHz)	Date:	2011/12/02
Ant.Polar.:	Horizontal	Test By:	Charlie Chang

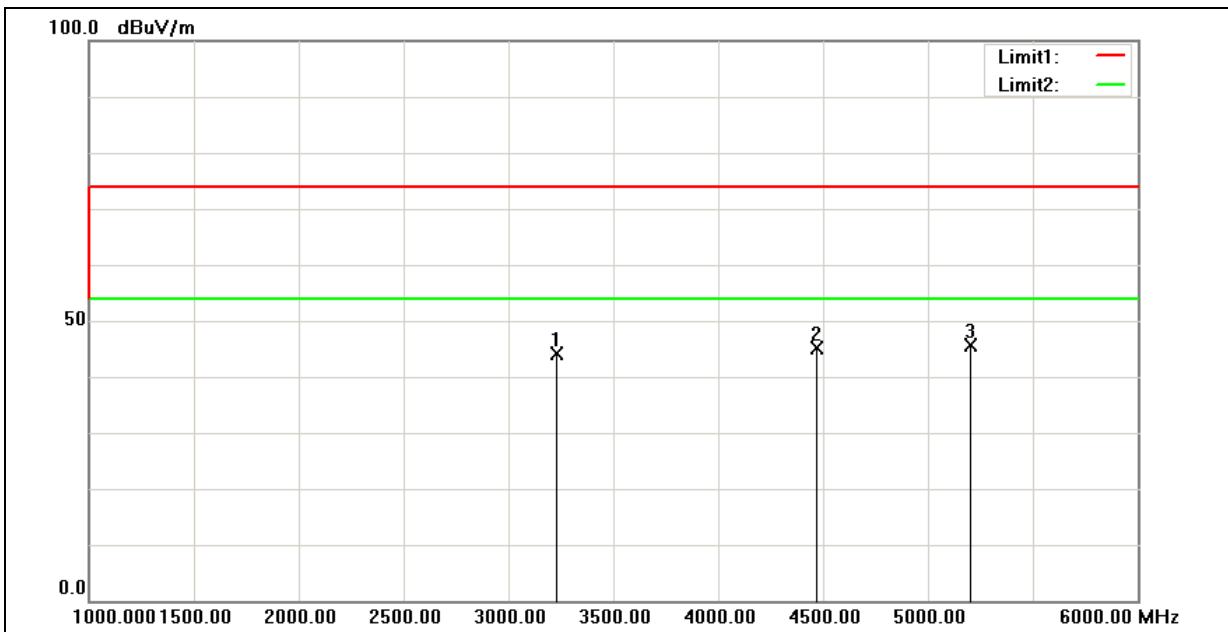

No.	Frequency (MHz)	Reading (dBuV)	Correct Factor(dB/m)	Result (dBuV/m)	Limit (dBuV/m)	Margin (dB)	Remark
1	3230.000	60.66	-16.43	44.23	74.00	-29.77	peak
2	4470.000	58.23	-13.22	45.01	74.00	-28.99	peak
3	5205.000	57.89	-12.27	45.62	74.00	-28.38	peak

Standard:	FCC Part 15B Class B	Test Distance:	3m
Test item:	Radiated Emission	Power:	DC 3.8V
Model:	HE910	Temp.(°C)/Hum.(%RH):	26(°C)/60%RH
Mode:	Mode 3 (1GHz~6GHz)	Date:	2011/12/02
Ant.Polar.:	Vertical	Test By:	Charlie Chang

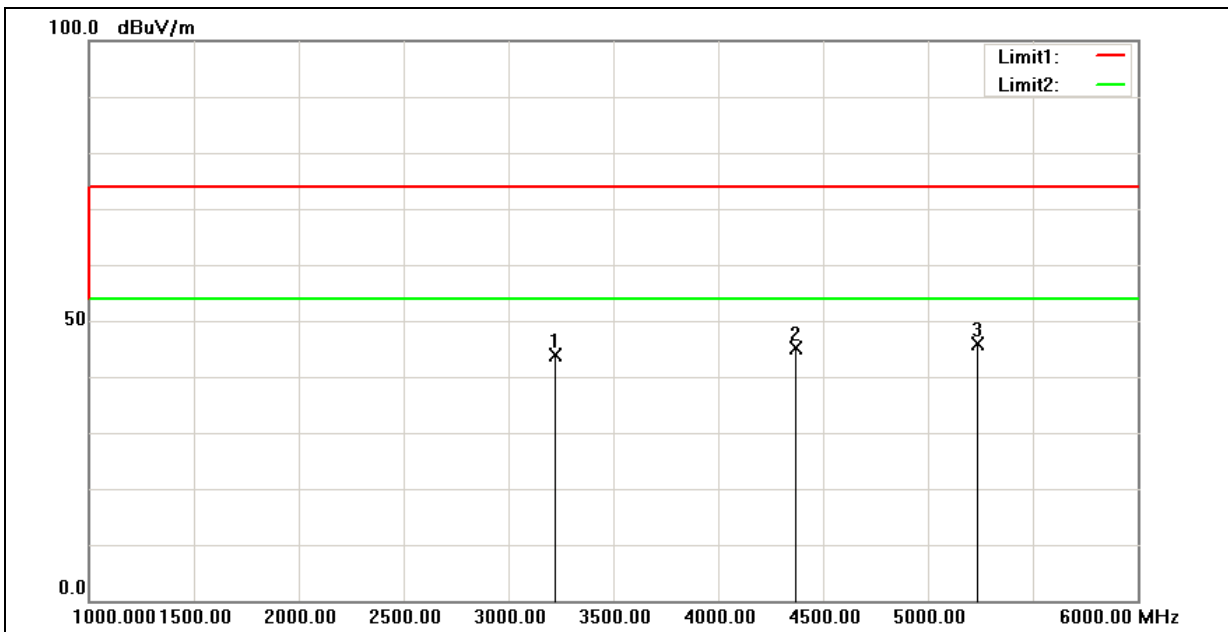

No.	Frequency (MHz)	Reading (dBuV)	Correct Factor(dB/m)	Result (dBuV/m)	Limit (dBuV/m)	Margin (dB)	Remark
1	3225.000	60.41	-16.43	43.98	74.00	-30.02	peak
2	4370.000	58.58	-13.50	45.08	74.00	-28.92	peak
3	5235.000	57.99	-12.22	45.77	74.00	-28.23	peak

Standard:	CISPR 22 Class B	Test Distance:	10m
Test item:	Radiated Emission	Power:	DC 3.8V
Model:	HE910	Temp.(°C)/Hum.(%RH):	26(°C)/60%RH
Mode:	Mode 4	Date:	2011/12/02
Ant.Polar.:	Horizontal	Test By:	Charlie Chang

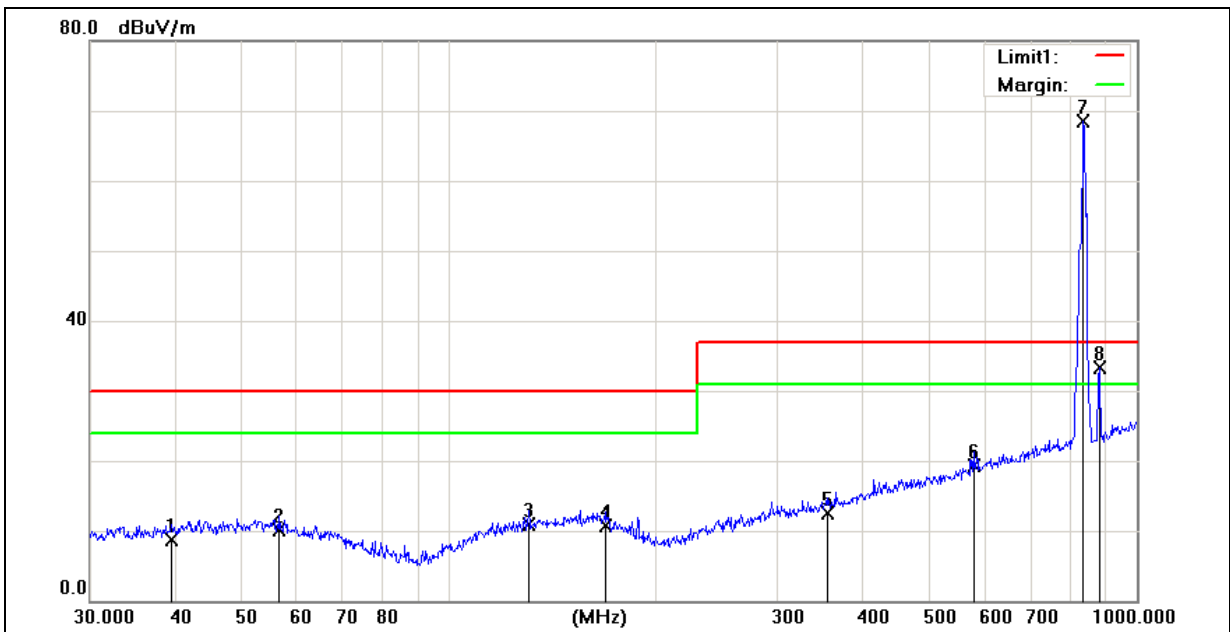

No.	Frequency (MHz)	Reading (dBuV)	Correct Factor(dB/m)	Result (dBuV/m)	Limit (dBuV/m)	Margin (dB)	Height (cm)	Degree (°)	Remark
1	39.4371	23.74	-14.94	8.80	30.00	-21.20	300	359	QP
2	56.5930	24.77	-14.67	10.10	30.00	-19.90	100	108	QP
3	130.3790	24.75	-13.85	10.90	30.00	-19.10	300	359	QP
4	168.4138	23.76	-13.06	10.70	30.00	-19.30	300	47	QP
5	354.1831	23.24	-10.64	12.60	37.00	-24.40	309	360	QP
6	578.6700	25.61	-6.21	19.40	37.00	-17.60	200	252	QP
7	836.2443	70.24	-1.73	68.51	N/A	N/A	100	171	TX
8	881.4067	34.28	-0.90	33.38	N/A	N/A	100	265	RX

Note: TX: the transmitting signal of Universal Radio Communication Tester.

RX: the receiving signal of Universal Radio Communication Tester.

Standard:	CISPR 22 Class B	Test Distance:	10m
Test item:	Radiated Emission	Power:	DC 3.8V
Model:	HE910	Temp.(°C)/Hum.(%RH):	26(°C)/60%RH
Mode:	Mode 4	Date:	2011/12/02
Ant.Polar.:	Vertical	Test By:	Charlie Chang

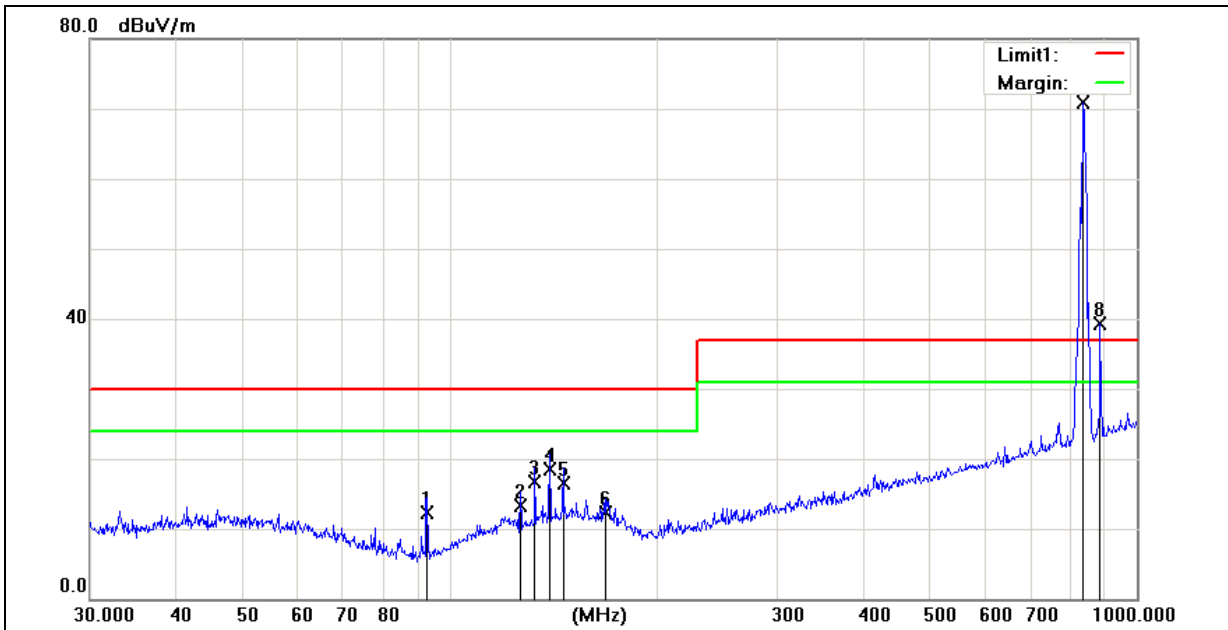

No.	Frequency (MHz)	Reading (dBuV)	Correct Factor(dB/m)	Result (dBuV/m)	Limit (dBuV/m)	Margin (dB)	Height (cm)	Degree (°)	Remark
1	92.7871	30.54	-18.14	12.40	30.00	-17.60	300	231	QP
2	126.7723	26.53	-13.23	13.30	30.00	-16.70	100	357	QP
3	133.1511	29.40	-12.70	16.70	30.00	-13.30	100	357	QP
4	139.8508	30.87	-12.27	18.60	30.00	-11.40	100	357	QP
5	146.3735	28.62	-12.12	16.50	30.00	-13.50	100	357	QP
6	168.4138	24.22	-11.92	12.30	30.00	-17.70	100	164	QP
7	833.3171	70.73	0.22	70.95	N/A	N/A	400	113	TX
8	884.5030	38.20	1.16	39.36	N/A	N/A	400	157	RX

Note: TX: the transmitting signal of Universal Radio Communication Tester.

RX: the receiving signal of Universal Radio Communication Tester.

Standard:	FCC Part 15B Class B	Test Distance:	3m
Test item:	Radiated Emission	Power:	DC 3.8V
Model:	HE910	Temp.(°C)/Hum.(%RH):	26(°C)/60%RH
Mode:	Mode 4 (1GHz~6GHz)	Date:	2011/12/02
Ant.Polar.:	Horizontal	Test By:	Charlie Chang

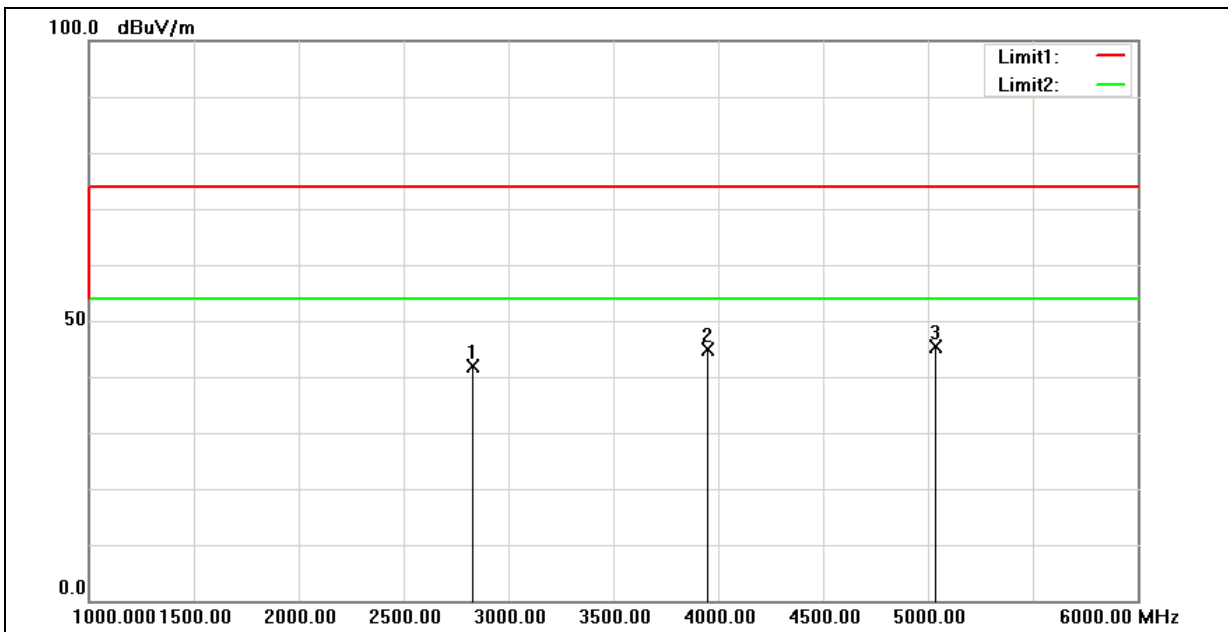

No.	Frequency (MHz)	Reading (dBuV)	Correct Factor(dB/m)	Result (dBuV/m)	Limit (dBuV/m)	Margin (dB)	Remark
1	2830.000	59.02	-17.16	41.86	74.00	-32.14	peak
2	3950.000	59.45	-14.67	44.78	74.00	-29.22	peak
3	5035.000	57.98	-12.56	45.42	74.00	-28.58	peak

Standard:	FCC Part 15B Class B	Test Distance:	3m
Test item:	Radiated Emission	Power:	DC 3.8V
Model:	HE910	Temp.(°C)/Hum.(%RH):	26(°C)/60%RH
Mode:	Mode 4 (1GHz~6GHz)	Date:	2011/12/02
Ant.Polar.:	Vertical	Test By:	Charlie Chang

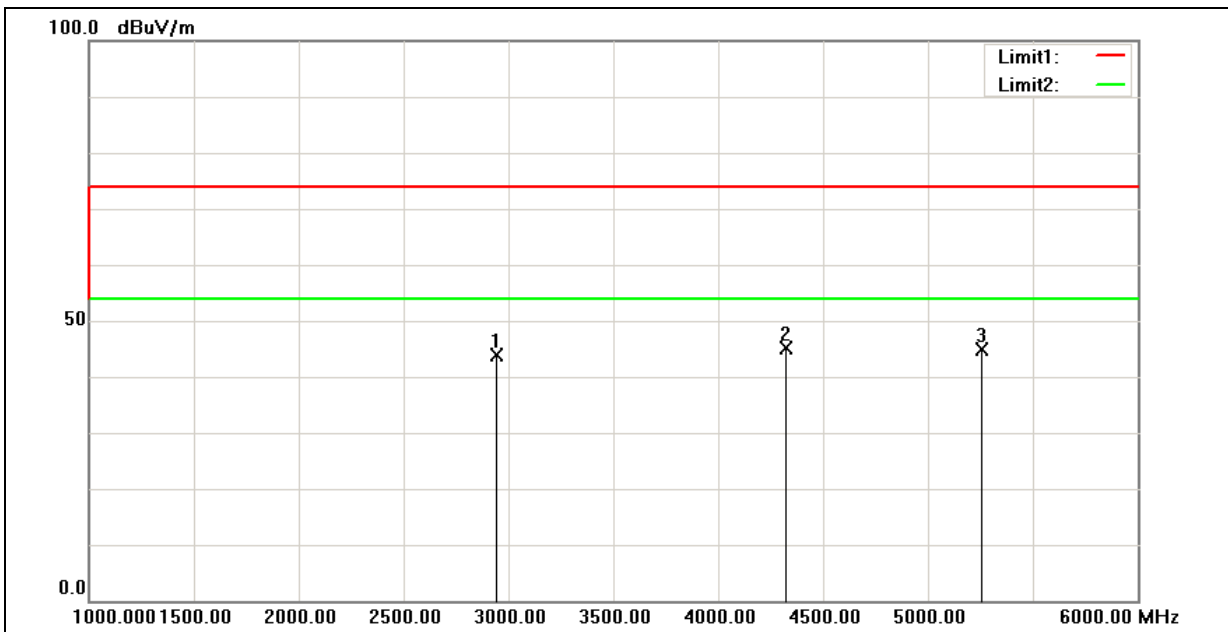

No.	Frequency (MHz)	Reading (dBuV)	Correct Factor(dB/m)	Result (dBuV/m)	Limit (dBuV/m)	Margin (dB)	Remark
1	2945.000	60.65	-16.83	43.82	74.00	-30.18	peak
2	4325.000	58.72	-13.63	45.09	74.00	-28.91	peak
3	5255.000	57.03	-12.17	44.86	74.00	-29.14	peak

Standard:	CISPR 22 Class B	Test Distance:	10m
Test item:	Radiated Emission	Power:	DC 3.8V
Model:	HE910	Temp.(°C)/Hum.(%RH):	26(°C)/60%RH
Mode:	Mode 5	Date:	2012/01/31
Ant.Polar.:	Horizontal	Test By:	Charlie Chang

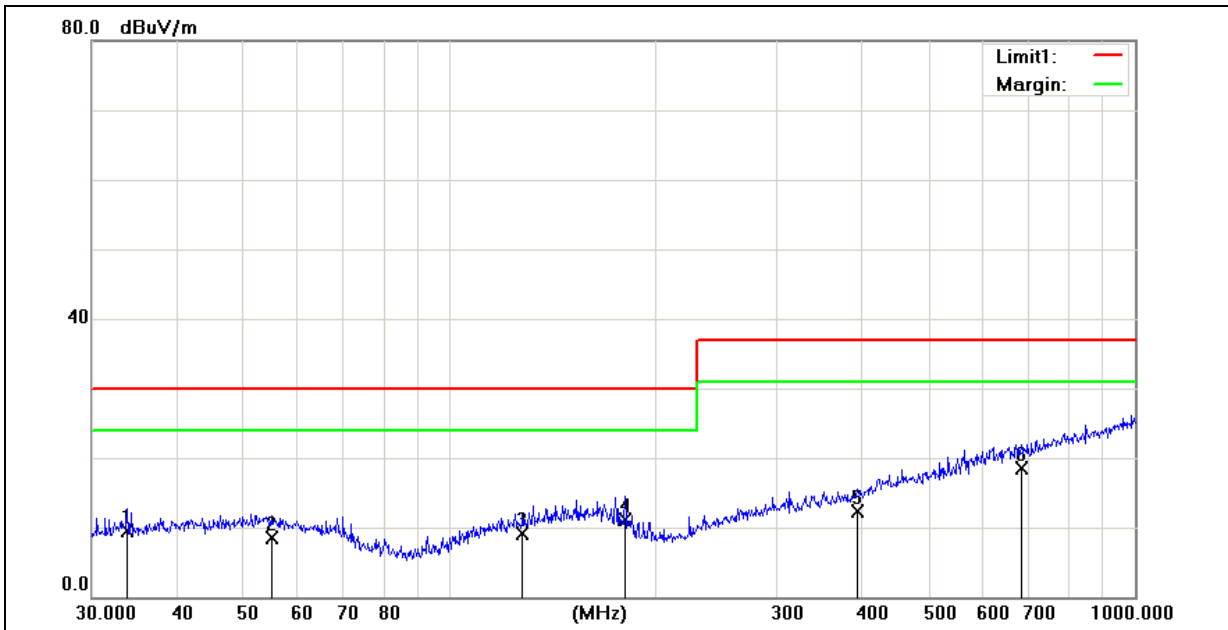

No.	Frequency (MHz)	Reading (dBuV)	Correct Factor(dB/m)	Result (dBuV/m)	Limit (dBuV/m)	Margin (dB)	Height (cm)	Degree (°)	Remark
1	33.7986	24.87	-15.27	9.60	30.00	-20.40	300	157	QP
2	54.8348	23.07	-14.57	8.50	30.00	-21.50	200	324	QP
3	127.6645	23.10	-14.00	9.10	30.00	-20.90	200	25	QP
4	180.0165	25.57	-14.37	11.20	30.00	-18.80	300	76	QP
5	393.4723	22.26	-9.86	12.40	37.00	-24.60	400	320	QP
6	682.3484	22.82	-4.32	18.50	37.00	-18.50	200	55	QP

Note: TX: the transmitting signal of Universal Radio Communication Tester.

RX: the receiving signal of Universal Radio Communication Tester.

Standard:	CISPR 22 Class B	Test Distance:	10m
Test item:	Radiated Emission	Power:	DC 3.8V
Model:	HE910	Temp.(°C)/Hum.(%RH):	26(°C)/60%RH
Mode:	Mode 5	Date:	2012/01/31
Ant.Polar.:	Vertical	Test By:	Charlie Chang

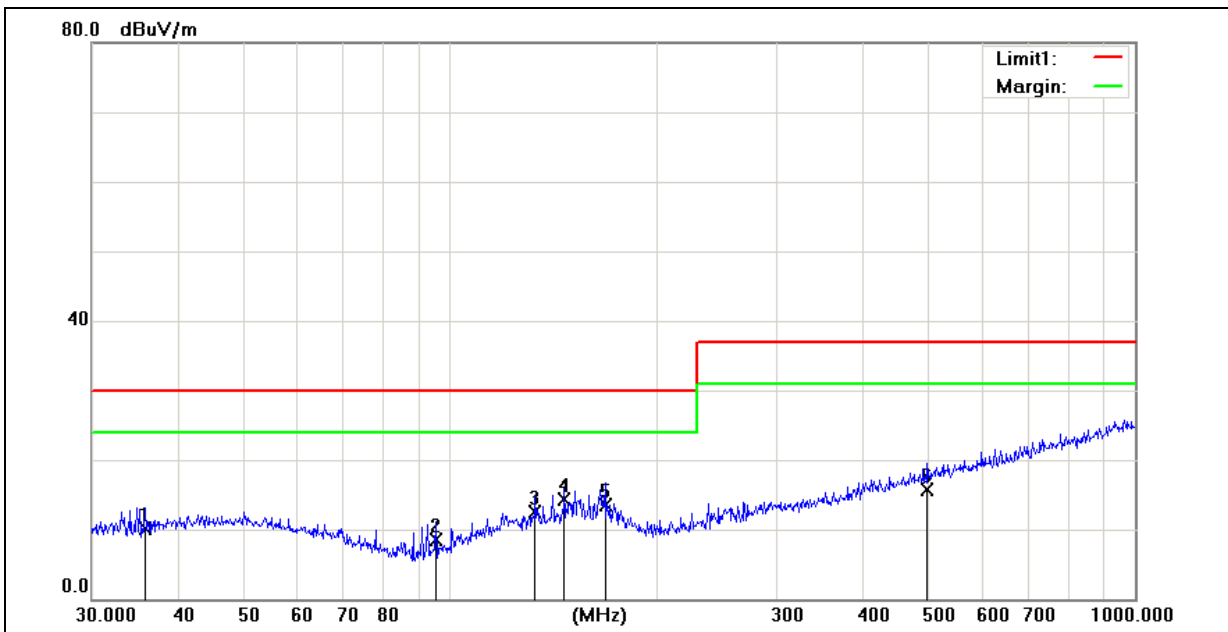

No.	Frequency (MHz)	Reading (dBuV)	Correct Factor(dB/m)	Result (dBuV/m)	Limit (dBuV/m)	Margin (dB)	Height (cm)	Degree (°)	Remark
1	35.8746	24.37	-14.27	10.10	30.00	-19.90	100	21	QP
2	95.4270	26.16	-17.66	8.50	30.00	-21.50	100	360	QP
3	133.1511	25.30	-12.70	12.60	30.00	-17.40	300	174	QP
4	146.8876	26.41	-12.11	14.30	30.00	-15.70	200	225	QP
5	168.4138	25.52	-11.92	13.60	30.00	-16.40	100	5	QP
6	497.6764	22.11	-6.31	15.80	37.00	-21.20	200	73	QP

Note: TX: the transmitting signal of Universal Radio Communication Tester.

RX: the receiving signal of Universal Radio Communication Tester.

Standard:	FCC Part 15B Class B	Test Distance:	3m
Test item:	Radiated Emission	Power:	DC 3.8V
Model:	HE910	Temp.(°C)/Hum.(%RH):	26(°C)/60%RH
Mode:	Mode 5 (1GHz~6GHz)	Date:	2012/01/31
Ant.Polar.:	Horizontal	Test By:	Charlie Chang

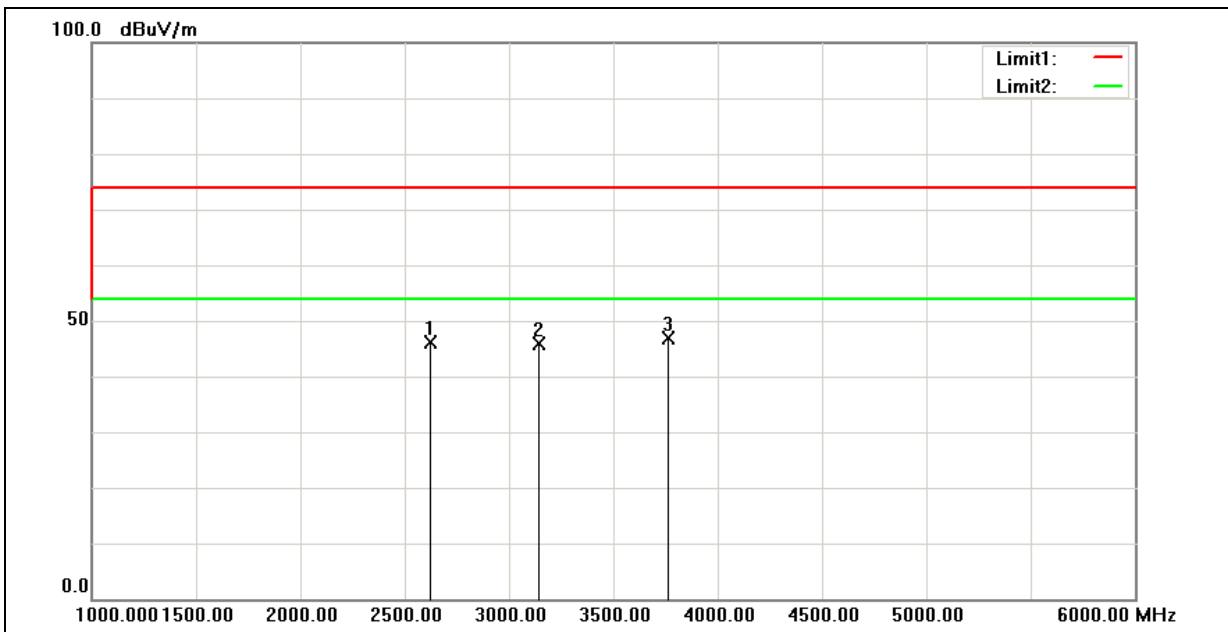

No.	Frequency (MHz)	Reading (dBuV)	Correct Factor(dB/m)	Result (dBuV/m)	Limit (dBuV/m)	Margin (dB)	Remark
1	2620.000	63.91	-17.78	46.13	74.00	-27.87	peak
2	3145.000	62.52	-16.52	46.00	74.00	-28.00	peak
3	3760.000	62.16	-15.28	46.88	74.00	-27.12	peak

Standard:	FCC Part 15B Class B	Test Distance:	3m
Test item:	Radiated Emission	Power:	DC 3.8V
Model:	HE910	Temp.(°C)/Hum.(%RH):	26(°C)/60%RH
Mode:	Mode 5 (1GHz~6GHz)	Date:	2012/01/31
Ant.Polar.:	Vertical	Test By:	Charlie Chang

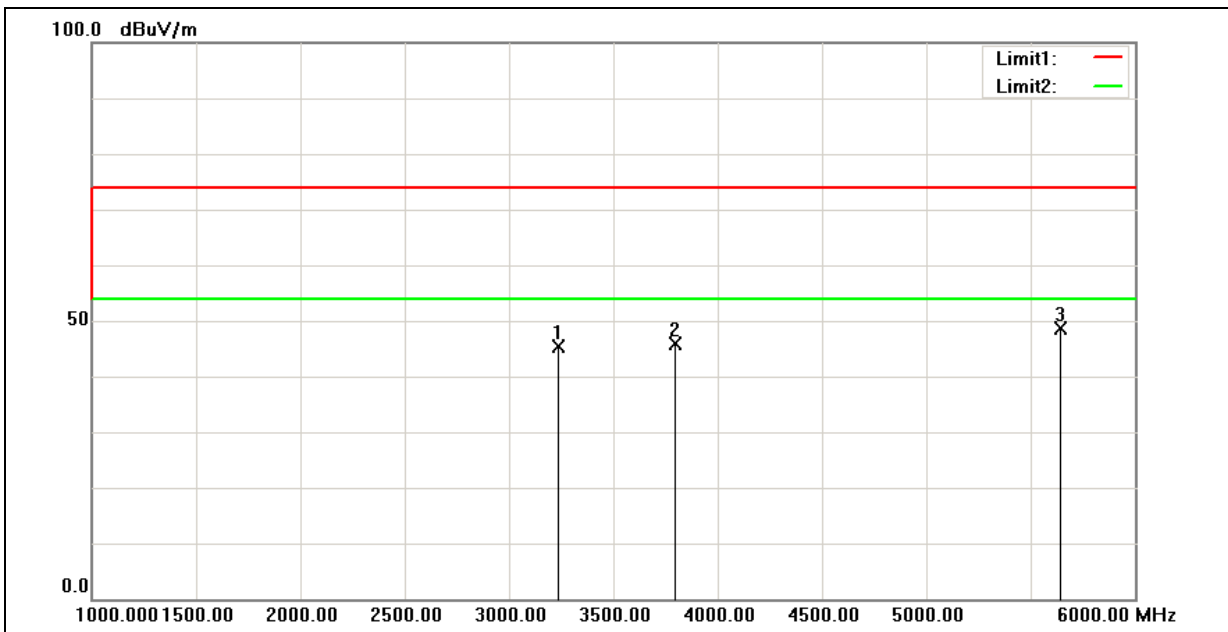

No.	Frequency (MHz)	Reading (dBuV)	Correct Factor(dB/m)	Result (dBuV/m)	Limit (dBuV/m)	Margin (dB)	Remark
1	3235.000	61.71	-16.43	45.28	74.00	-28.72	peak
2	3795.000	61.03	-15.17	45.86	74.00	-28.14	peak
3	5640.000	60.00	-11.26	48.74	74.00	-25.26	peak