

FCC 47 CFR PART 22H and 24E

Product Type : 2G Module

Applicant : Telit Communications S.p.A.

Address : Via Stazione di Prosecco, 5/B, Sgonico, TS 34010, Italy

Trade Name : Telit

Model Number : GE910-QUAD

Test Specification : FCC 47 CFR PART 22H: Oct, 2011
FCC 47 CFR PART 24E: Oct, 2011
CANADA RSS-132 ISSUE 2: Sep., 2005
CANADA RSS-133 ISSUE 5: Feb., 2009
Canada RSS-Gen ISSUE 3: Dec., 2010
ANSI/TIA-603-C-2004

Receive Date : May 18, 2012

Issue Date : Jun. 01, 2012

Issue by

A Test Lab Techno Corp.
No. 140-1, Changan Street, Bade City,
Taoyuan County 334, Taiwan R.O.C.
Tel : +886-3-2710188 / Fax : +886-3-2710190



Taiwan Accreditation Foundation accreditation number: 1330

Note: This report shall not be reproduced except in full, without the written approval of A Test Lab Techno Corp. This document may be altered or revised by A Test Lab Techno Corp. personnel only, and shall be noted in the revision section of the document. The client should not use it to claim product endorsement by TAF, or any government agencies. The test results in the report only apply to the tested sample.

Revision History

Rev.	Issue Date	Revisions	Revised By
00	Jun. 01, 2012	Initial Issue	

Verification of Compliance

Issued Date: 2012/06/01

Product Type : 2G Module
Applicant : Telit Communications S.p.A.
Address : Via Stazione di Prosecco, 5/B, Sgonico, TS 34010, Italy
Trade Name : Telit
Model Number : GE910-QUAD
FCC ID : R17GE910
IC : 5131A-GE910
EUT Rated Voltage : DC 3.8V
Test Voltage : DC 3.8V
Applicable Standard : FCC 47 CFR PART 22H: Oct, 2011
FCC 47 CFR PART 24E: Oct, 2011
CANADA RSS-132 ISSUE 2: Sep., 2005
CANADA RSS-133 ISSUE 5: Feb., 2009
Canada RSS-Gen ISSUE 3: Dec., 2010
ANSI/TIA-603-C-2004

Test Result : Complied

Performing Lab. : A Test Lab Techno Corp.

No. 140-1, Changan Street, Bade City
Taoyuan County 334, Taiwan R.O.C.

Tel : +886-3-2710188 / Fax : +886-3-2710190

Taiwan Accreditation Foundation accreditation number:
1330



<http://www.atl-lab.com.tw/e-index.htm>

The above equipment was tested by A Test Lab Techno Corp. The test data, data evaluation, test procedures, and equipment configurations shown in this report were made in accordance with the procedures given in ANSI C63.4: 2009 and the energy emitted by the sample tested as described in this report is in compliance with the requirements of FCC Rules Part 22H, Part 24E.
The test results of this report relate only to the tested sample identified in this report.

Approved By : 

(Manager)

(Murphy Wang)

Reviewed By : 

(Testing Engineer)

(Fly Lu)

TABLE OF CONTENTS

1	General Information	6
1.1	EUT Description.....	6
1.2	Mode of Operation	6
1.3	EUT Exercise Software.....	7
1.4	Configuration of Test System Details.....	7
1.5	Test Site Environment.....	7
1.6	Summary of Test Result.....	8
2	RF Output Power Test.....	9
2.1	Limit	9
2.2	Test Instruments	9
2.3	Test Setup	9
2.4	Test Procedure.....	9
2.5	Uncertainty.....	10
2.6	Test Result	10
3	Effective Radiated Power / Equivalent Isotropic Radiated Power Test	11
3.1	Limit	11
3.2	Test Instruments	11
3.3	Test Setup	12
3.4	Test Procedure.....	13
3.5	Uncertainty.....	13
3.6	Test Result	14
4	Occupied Bandwidth Test	15
4.1	Limit	15
4.2	Test Instruments	15
4.3	Setup.....	15
4.4	Test Procedure.....	16
4.5	Uncertainty.....	16
4.6	Test Result	17
5	Conducted Emission Test	23
5.1	Limit	23
5.2	Test Instruments	23
5.3	Setup.....	23
5.4	Test Procedure.....	24
5.5	Uncertainty.....	24
5.6	Test Result	24

6	Field Strength of Spurious Radiation Test	25
6.1	Limit	25
6.2	Test Instruments	25
6.3	Setup.....	25
6.4	Test Procedure.....	26
6.5	Uncertainty.....	26
6.6	Test Result	27
7	Frequency Stability (Temperature Variation) Test.....	61
7.1	Limit	61
7.2	Test Instruments	61
7.3	Setup.....	61
7.4	Test Procedure.....	62
7.5	Uncertainty.....	62
7.6	Test Result	63
8	Frequency Stability (Voltage Variation) Test.....	64
8.1	Limit	64
8.2	Test Instruments	64
8.3	Setup.....	64
8.4	Test Procedure.....	64
8.5	Uncertainty.....	65
8.6	Test Result	65

1 General Information

1.1. EUT Description

Applicant	Telit Communications S.p.A.				
Applicant Address	Via Stazione di Prosecco, 5/B, Sgonico, TS 34010, Italy				
Manufacturer	Telit Communications S.p.A.				
Manufacturer Address	Via Stazione di Prosecco, 5/B, Sgonico, TS 34010, Italy				
Product Type	2G Module				
Trade Name	Telit				
Model Number	GE910-QUAD				
IMEI Number	351732059000706				
FCC ID	R17GE910				
IC	5131A-GE910				
Hardware Version	0				
Software Version	13.00.000-B008				
Mode	GSM/GPRS	Band	UL Frequency (MHz)	DL Frequency (MHz)	Modulation
		850	824.2 ~ 848.8	869.2 ~ 893.8	GMSK/8PSK
		1900	1850.2 ~ 1909.8	1930.2 ~ 1989.8	GMSK/8PSK
Channel Control	Auto				
Max. RF Output power	GSM/GPRS 850: 32.39 dBm / 1.734 W GSM/GPRS 1900: 29.81 dBm / 0.957 W				
Max. ERP/EIRP	GSM/GPRS 850: 30.88 dBm / 1.225 W GSM/GPRS 1900: 26.27 dBm / 0.424 W				
Emission Designator	GSM/GPRS 850: 246KGXW GSM/GPRS 1900: 245KGXW				

1.2. Mode of Operation

ATL has verified the construction and function in typical operation. All the test modes were carried out with the EUT in normal operation, which was shown in this test report and defined as:

Test Mode
Mode 1: GSM 850 Link
Mode 2: GSM 1900 Link
Mode 3: Receive Mode

Note: Regards to the frequency band operation: the lowest, middle and highest frequency of channel were selected to perform the test, then shown on this report.

Tested System Details

The types for all equipments, plus descriptions of all cables used in the tested system (including inserted cards) are:

	Product	Manufacturer	Model Number	Serial Number	Power Cord
1.	Universal Radio Communication Tester	R&S	CMU200	109369	Non-Shielded, 1.8m

1.3. EUT Exercise Software

1.	Setup the EUT and Base Station (CMU200) as shown on 1.4.
2.	Turn on the power of all equipment.

1.4. Configuration of Test System Details

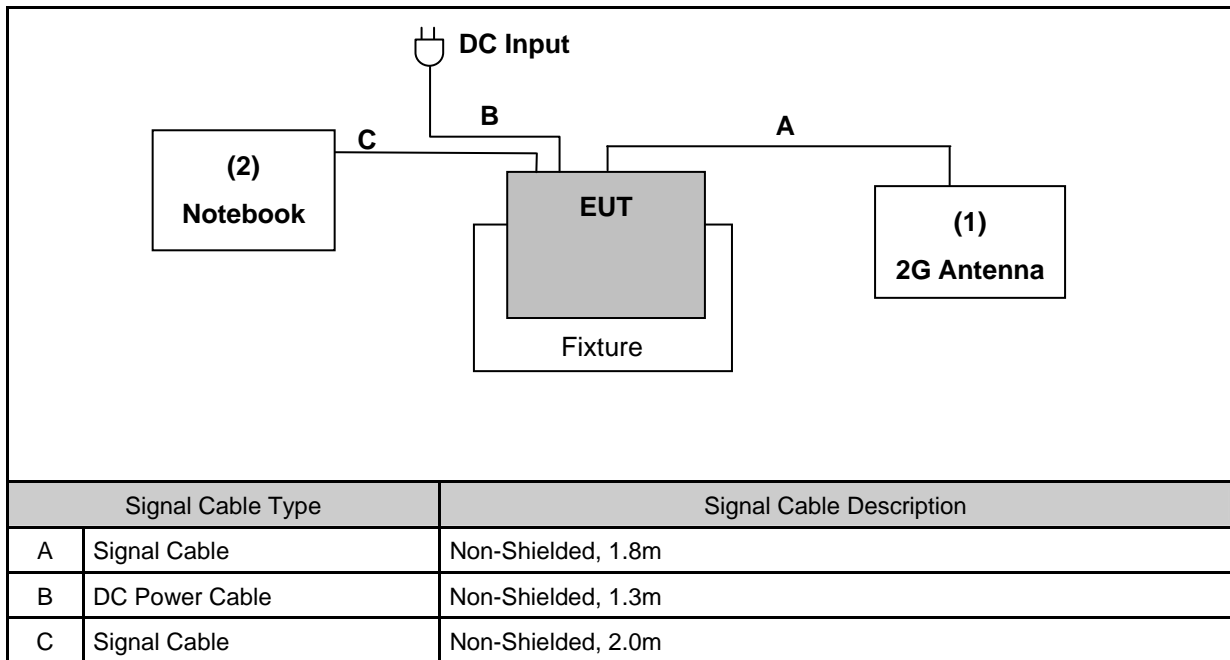

Devices Description					
	Product	Manufacturer	Model Number	Serial Number	Power Cord
1.	2G Antenna (Max. Gain: 2.14 dBi)	Tel Cab	T-AT311	N/A	N/A
2.	Notebook	DELL	640M	CN-0MG532-70166-6C8-036T	Non-Shielded, 2.0m

1.5. Test Site Environment

Items	Required (IEC 68-1)	Actual
Temperature (°C)	15-35	26
Humidity (%RH)	25-75	60
Barometric pressure (mbar)	860-1060	950

1.6. Summary of Test Result

Description	FCC Rule	IC Rule	Limit	Result
Conducted Output Power	§2.1046	N/A	N/A	Pass
Effective Radiated Power	§22.913(a)(2)	RSS-132(4.4) SRSP-503(5.1.3)	< 7 Watts for FCC (<6.3 Watts for IC)	Pass
Equivalent Isotropic Radiated Power	§24.232(c)	RSS-133 (6.4) SRSP-510(5.1.2)	< 2 Watts	Pass
Occupied Bandwidth	§2.1049 §22.917(a) §24.238(a)	RSS-Gen (4.6.1)	N/A	Pass
Band Edge Measurement	§2.1051 §22.917(a) §24.238(a)	RSS-132 (4.5.1)RSS-133 (6.5.1)	< 43+10log ₁₀ (P[Watts])	Pass
Conducted Emission	§2.1051 §22.917(a) §24.238(a)	RSS-132 (4.5.1) RSS-133 (6.5.1)	< 43+10log ₁₀ (P[Watts])	Pass
Field Strength of Spurious Radiation	§2.1053 §22.917(a) §24.238(a)	RSS-132 (4.5.1) RSS-133 (6.5.1) RSS-Gen (4.10)	< 43+10log ₁₀ (P[Watts])	Pass
Frequency Stability for Temperature & Voltage	§2.1055 §22.355 §24.235	RSS-132(4.3) RSS-133(6.3)	< 2.5 ppm	Pass

2 RF Output Power Test

2.1. Limit

N/A

2.2. Test Instruments

Describe	Manufacturer	Model No.	Serial No.	Cal. Date	Remark
Universal Radio Communication Tester	ROHDE & SCHWARZ	CMU200	109369	08/10/2010	(2)
Single Channel PK Power Sensor	Agilent	N1911A	MY45101619	12/15/2011	(1)
Wideband Power Meter	Agilent	N1921A	MY45241957	12/15/2011	(1)
Test Site	ATL	TE05	TE05	N.C.R.	-----

Remark: ⁽¹⁾ Calibration period 1 year. ⁽²⁾ Calibration period 2 years.

NOTE: N.C.R. = No Calibration Request.

2.3. Test Setup

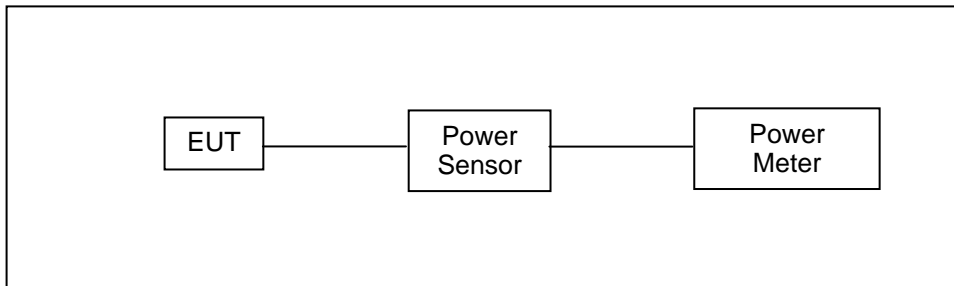

2.4. Test Procedure

The measurement is made according to ANSI/TIA-603-C-2004 as follows:

1. The transmitter output was connected to power meter and base station through power divider.
2. Set base station for EUT at GSM 850: PCL=5 and PCS 1900: PCL=0.
3. Set base station for EUT at WCDMA Band V and WCDMA Band II, power level was set to maximum.
4. Select lowest, middle, and highest channels for each band.

2.5. Uncertainty

The measurement uncertainty is defined as for RF output power measurement is 1.2 dB.

2.6. Test Result

Model Number	GE910-QUAD					
Test Item	RF Output Power					
Test Mode	Mode 1: GSM 850 Link					
Date of Test	05/23/2012			Test Site	TE05	
Bands	Data Rate	Frequency (MHz)	Burst Average Power		Peak Power	
			(dBm)	(W)	(dBm)	(W)
GSM 850	-----	824.2	31.96	1.570	32.12	1.629
		836.6	32.14	1.637	32.21	1.663
		848.8	32.22	1.667	32.31	1.702
GRRS 850	4Down1Up	824.2	32.11	1.626	32.18	1.652
		836.6	32.19	1.656	32.28	1.690
		848.8	32.26	1.683	32.39	1.734
	3Down2Up	824.2	31.99	1.581	32.16	1.644
		836.6	32.17	1.648	32.25	1.679
		848.8	32.21	1.663	32.34	1.714

Note: The peak power testing result was used peak detector.

Model Number	GE910-QUAD					
Test Item	RF Output Power					
Test Mode	Mode 2: GSM 1900 Link					
Date of Test	05/23/2012			Test Site	TE05	
Bands	Data Rate	Frequency (MHz)	Burst Average Power		Peak Power	
			(dBm)	(W)	(dBm)	(W)
GSM 1900	-----	1850.20	29.51	0.893	29.72	0.938
		1880.00	29.63	0.918	29.79	0.953
		1909.80	29.44	0.879	29.51	0.893
GRRS 1900	4Down1Up	1850.20	29.67	0.927	29.81	0.957
		1880.00	29.65	0.923	29.79	0.953
		1909.80	29.49	0.889	29.58	0.908
	3Down2Up	1850.20	29.65	0.923	29.77	0.948
		1880.00	29.64	0.920	29.75	0.944
		1909.80	29.46	0.883	29.56	0.904

Note: The peak power testing result was used peak detector.

3 Effective Radiated Power / Equivalent Isotropic Radiated Power Test

3.1. Limit

For FCC Part 22.913(a)(2): The ERP of mobile transmitters and auxiliary test transmitters must not exceed 7 Watts.

For FCC Part 24.232(b): The EIRP of mobile transmitters and auxiliary test transmitters must not exceed 2 Watts.

3.2. Test Instruments

3 Meter Chamber					
Equipment	Manufacturer	Model Number	Serial Number	Cal. Date	Remark
RF Pre-selector	Agilent	N9039A	MY46520256	01/16/2012	(1)
Spectrum Analyzer	Agilent	E4446A	MY46180578	01/16/2012	(1)
Pre Amplifier	Agilent	8449B	3008A02237	02/22/2012	(1)
Pre Amplifier	Agilent	8447D	2944A10961	02/22/2012	(1)
Broadband Antenna (30MHz~1GHz)	SCHWARZBECK MESS-ELEKTRONIK	VULB9163	9163-270	07/29/2011	(1)
Horn Antenna (1~18GHz)	SCHWARZBECK MESS-ELEKTRONIK	BBHA9120D	9120D-550	06/29/2011	(1)
Horn Antenna (18~40GHz)	SCHWARZBECK MESS-ELEKTRONIK	BBHA9170	9170-320	06/28/2011	(1)
Test Site	ATL	TE01	888001	12/20/2011	(1)

Remark: ⁽¹⁾ Calibration period 1 year. ⁽²⁾ Calibration period 2 years.

NOTE: N.C.R. = No Calibration Request.

3.3. Test Setup

Below 1 GHz

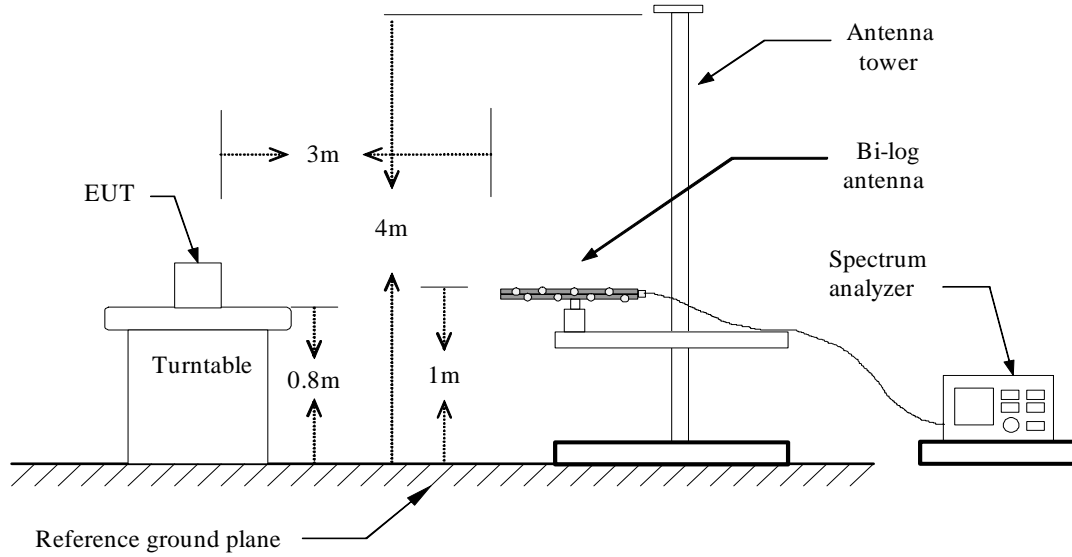

Above 1 GHz

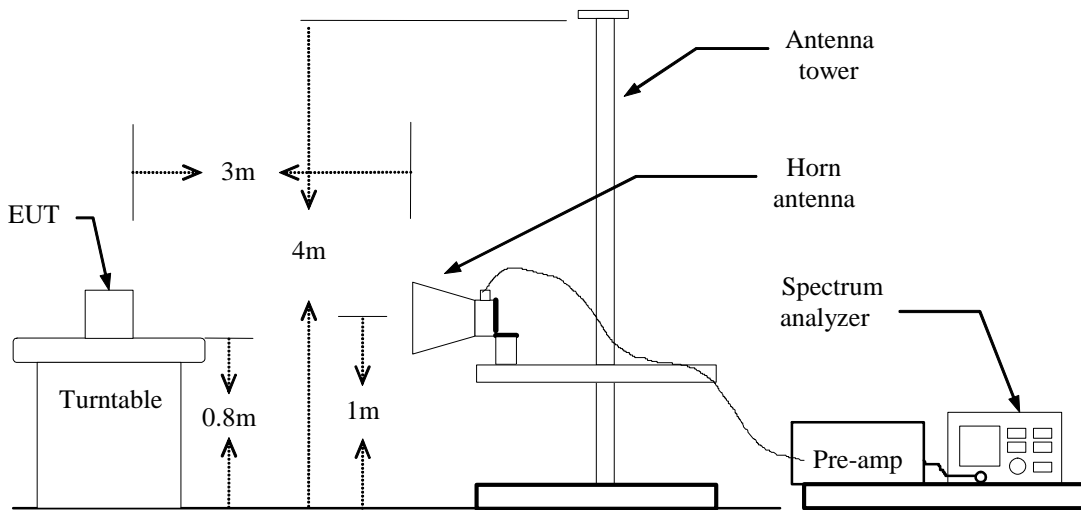

For Substituted Method Test Set-UP

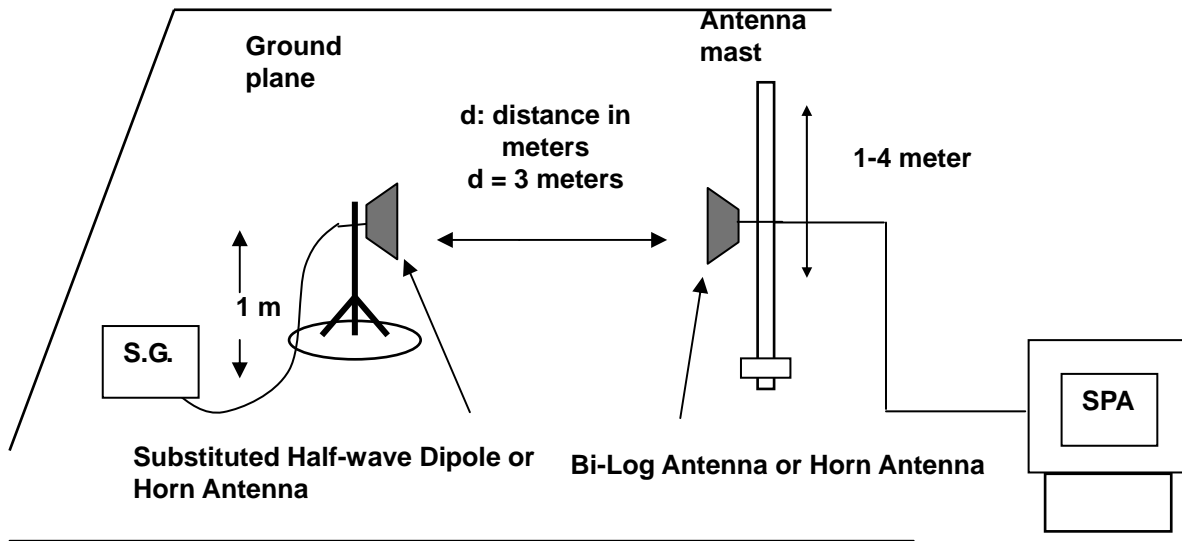

3.4. Test Procedure

The measurement is made according to ANSI/TIA-603-C-2004 as follows:

The EUT was placed on a non-conductive turntable using a non-conductive support. The radiated emission at the fundamental frequency was measured at 3 m with a test antenna and EMI spectrum analyzer.

During the measurement of the EUT, the resolution bandwidth was set to 3MHz and the average bandwidth was set to 3MHz. The highest emission was recorded with the rotation of the turntable and the lowering of the test antenna. The reading was recorded and the field strength (E in dBuV/m) was calculated.

ERP in frequency band 824-849MHz, and EIRP in frequency band 1851.25 –1910MHz were measured using a substitution method. The EUT was replaced by half-wave dipole (824-849MHz) or horn antenna (1851.25-1910MHz) connected to a signal generator. The spectrum analyzer reading was recorded and ERP/EIRP was calculated as follows:

$$\text{ERP} = \text{S.G. output (dBm)} + \text{Antenna Gain (dBd)} - \text{Cable (dB)}$$

$$\text{EIRP} = \text{S.G. output (dBm)} + \text{Antenna Gain (dBi)} - \text{Cable (dB)}$$

3.5. Uncertainty

The measurement uncertainty is defined as for Field Strength of Spurious Radiation measurement is ± 3.072 dB.

3.6. Test Result

Model Number	GE910-QUAD						
Test Item	ERP/EIRP						
Test Mode	Mode 1: GSM 850 Link						
Date of Test	05/30/2012				Test Site	TE01	
Bands	Frequency (MHz)	Ant. Polar.	Read Level (dBm)	Correction factor (dBm)	ERP		Limit
					(dBm)	(W)	
GSM 850	824.2	H	16.18	11.96	28.14	0.652	< 7W
		V	15.42	11.29	26.71	0.469	< 7W
	836.4	H	18.57	12.07	30.64	1.159	< 7W
		V	17.38	11.34	28.72	0.745	< 7W
	848.8	H	18.38	12.50	30.88	1.225	< 7W
		V	16.93	11.47	28.40	0.692	< 7W

Model Number	GE910-QUAD						
Test Item	ERP/EIRP						
Test Mode	Mode 2: GSM 1900 Link						
Date of Test	05/30/2012				Test Site	TE01	
Bands	Frequency (MHz)	Ant. Polar.	Read Level (dBm)	Correction factor (dBm)	EIRP		Limit
					(dBm)	(W)	
GSM 1900	1850.20	H	10.74	10.49	21.23	0.133	< 2W
		V	16.93	8.33	25.26	0.336	< 2W
	1880.00	H	11.67	10.51	22.18	0.165	< 2W
		V	17.43	8.57	26.00	0.398	< 2W
	1909.80	H	13.15	10.52	23.67	0.233	< 2W
		V	17.46	8.81	26.27	0.424	< 2W

Note: 1. ERP/EIRP = Read Level + Correction factor.

2. For WCDMA signals, a peak detector is used with RBW = VBW = 5MHz.

3. For AMPS, GSM, and NADC TDMA signals, a peak detector is used, with RBW = VBW= 1 MHz.

4 Occupied Bandwidth Test

4.1. Limit

The Occupied Bandwidth Limit:

N/A.

The Band Edge Limit:

The power of any emission outside of the authorized operating frequency ranges must be attenuated below the transmitting power (P) by a factor of at least $43 + 10\log(P)$ dB.

4.2. Test Instruments

Describe	Manufacturer	Model No.	Serial No.	Cal. Date	Remark
Spectrum Analyzer	Agilent	E4445A	MY46181986	05/10/2012	(2)
Universal Radio Communication Tester	ROHDE & SCHWARZ	CMU200	109369	08/10/2010	(2)
Attenuator	RADIALL	R41572000	0603033073	N.C.R.	-----
Power divider	Agilent	87302C	3239A00760	N.C.R.	-----
Test Site	ATL	TE05	TE05	N.C.R.	-----

Remark: ⁽¹⁾ Calibration period 1 year. ⁽²⁾ Calibration period 2 years.

NOTE: N.C.R. = No Calibration Request.

4.3. Setup

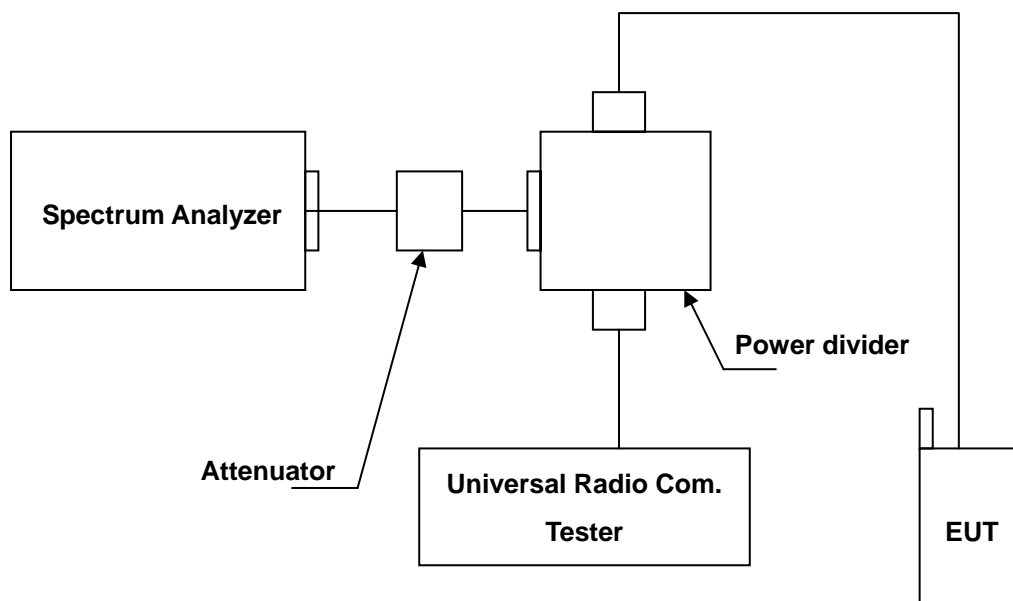

4.4. Test Procedure

The measurement is made according to FCC rules part 22 and 24:

1. The EUT was connected to Spectrum Analyzer and Base Station via power divider.
2. The occupied bandwidth of middle channel for the highest and lowest RF powers was measured.
3. The band edge of low and high channels for the highest RF powers within the transmitting frequency band were measured. Setting RBW as roughly BW/100.
4. The band edge setting:
 - a. RB=3 kHz; VB=3 kHz for GSM 850 and PCS 1900.
 - b. RB=100 kHz; VB=100 kHz for WCDMA Band V and WCDMA Band II.

4.5. Uncertainty

The measurement uncertainty is defined as $\pm 10\text{Hz}$

4.6. Test Result

99% Occupied Bandwidth

Model Number	GE910-QUAD		
Test Item	Occupied Bandwidth		
Test Mode	Mode 1: GSM 850 Link		
Date of Test	05/23/2012	Test Site	TE05
Channel No.	Frequency (MHz)	99% Bandwidth (kHz)	Note
128	824.2	242.5002	RBW:10kHz , VBW:30kHz
190	836.6	244.3040	RBW:10kHz , VBW:30kHz
251	848.8	246.3387	RBW:10kHz , VBW:30kHz

Figure Channel 128

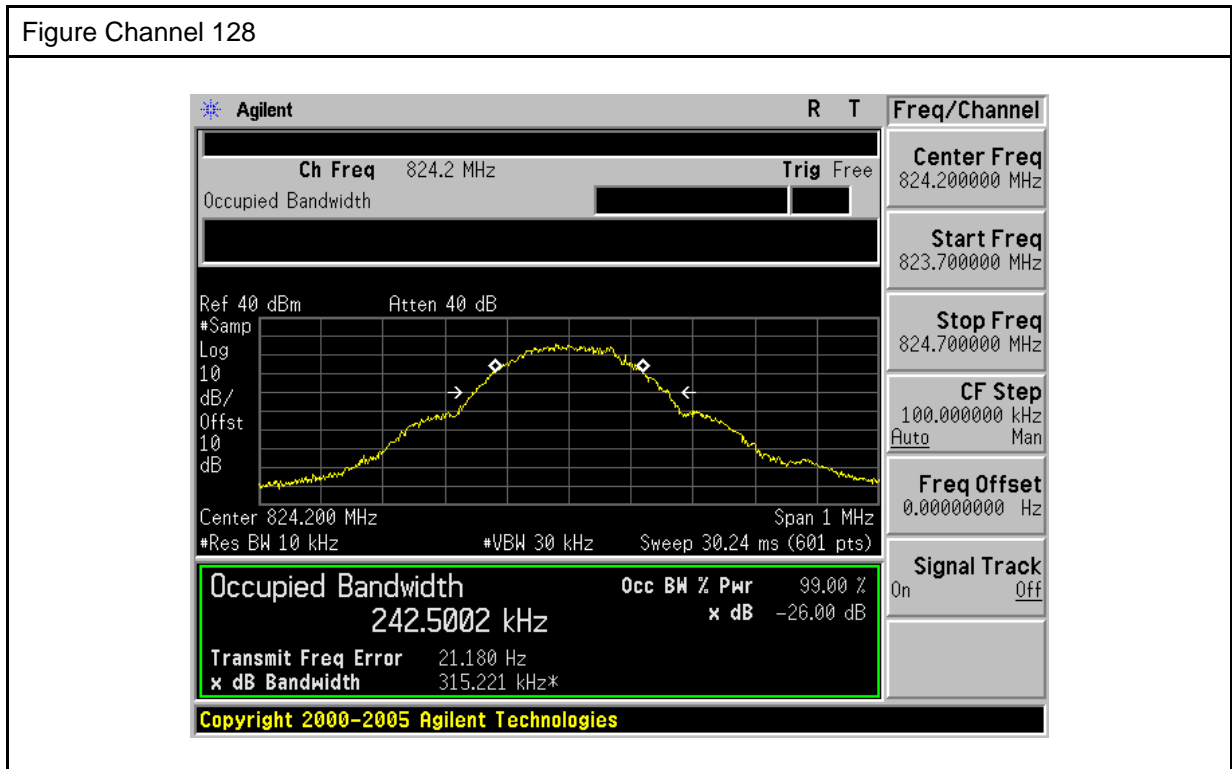

Figure Channel 190

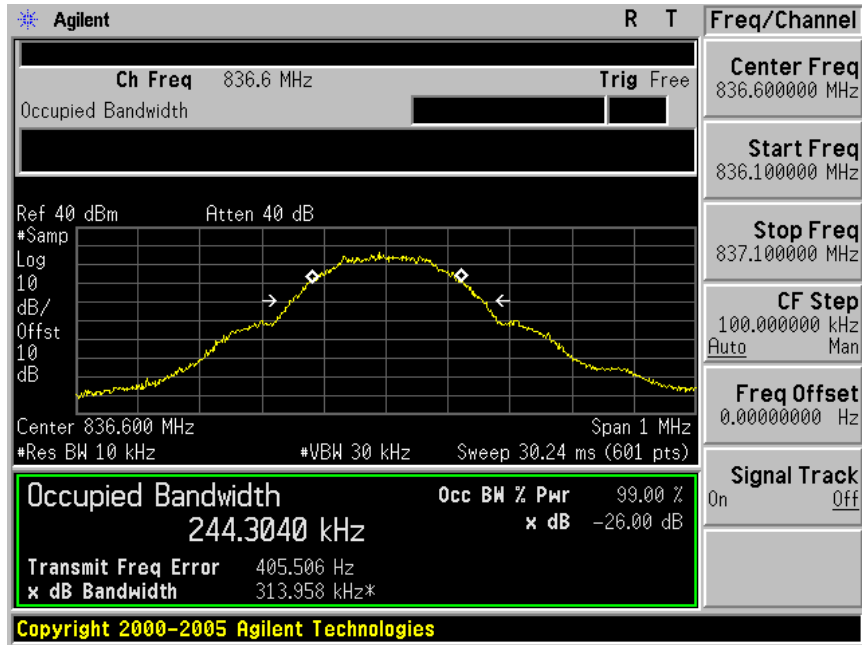
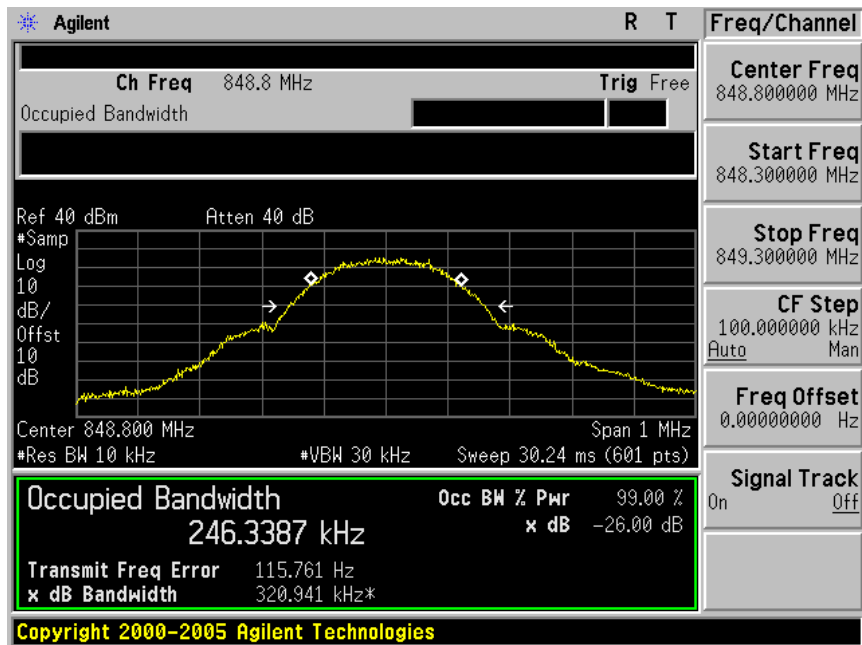

Figure Channel 251



Model Number	GE910-QUAD		
Test Item	Occupied Bandwidth		
Test Mode	Mode 2: GSM 1900 Link		
Date of Test	05/23/2012	Test Site	TE05
Channel No.	Frequency (MHz)	99% Bandwidth (kHz)	Note
512	1850.20	245.2618	RBW:10kHz , VBW:30kHz
661	1880.00	243.9272	RBW:10kHz , VBW:30kHz
810	1909.80	244.5182	RBW:10kHz , VBW:30kHz

Figure Channel 512

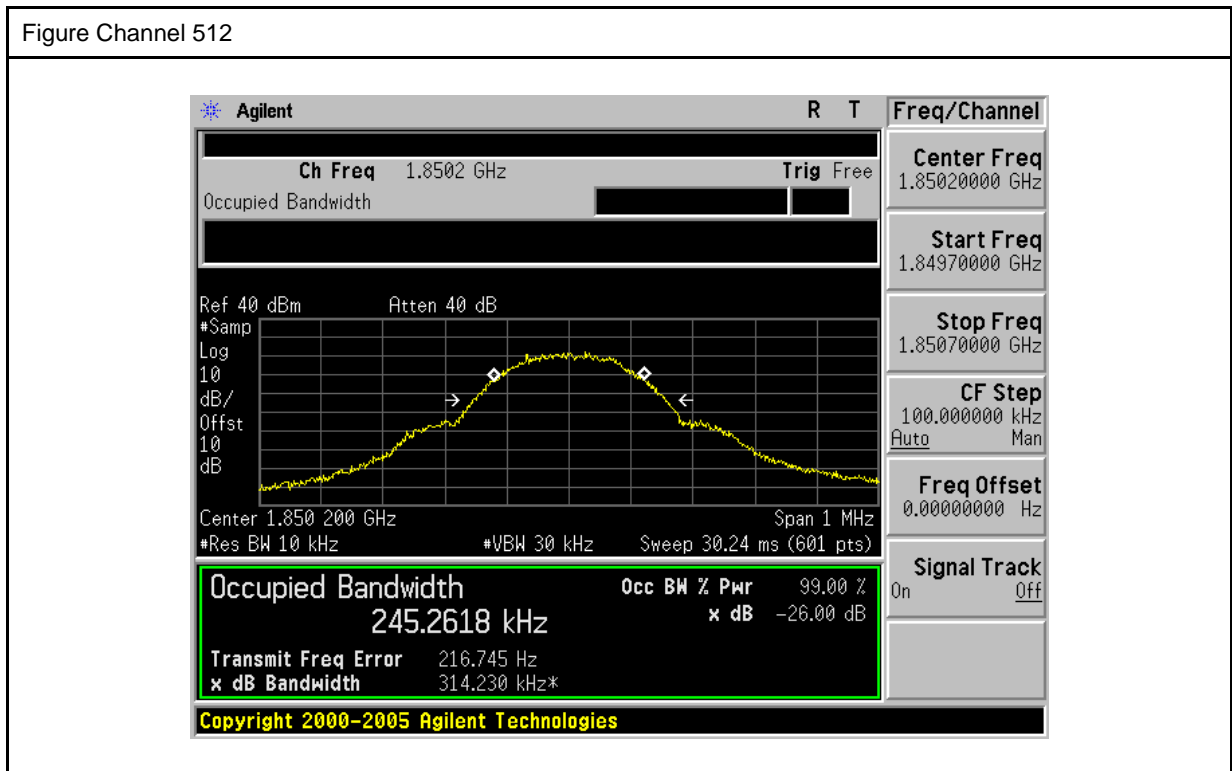

Figure Channel 661

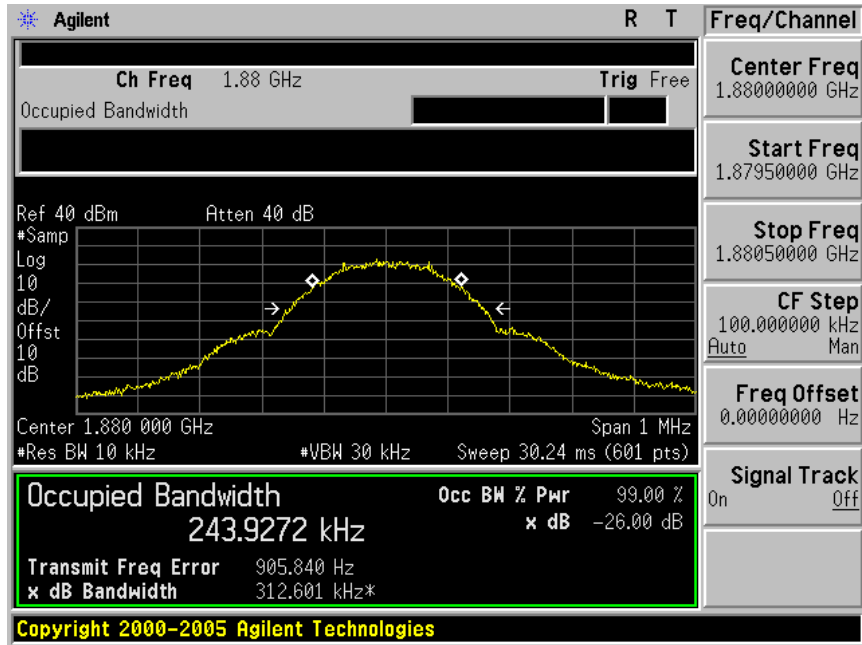
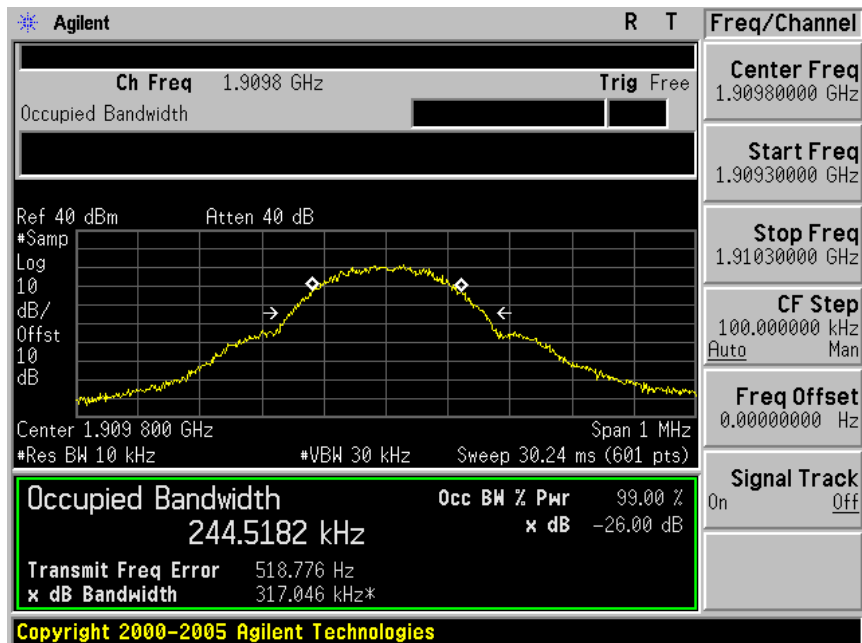

Figure Channel 810



Band Edge

Model Number	GE910-QUAD				
Test Item	Band Edge				
Test Mode	Mode 1: GSM 850 Link				
Date of Test	05/21/2012		Test Site	TE05	
Band	Channel	Frequency (MHz)	Bandwidth (dBm)	Limit (dBm)	Result
Lower	128	824.0000	-18.68	-13	Pass
Higher	251	849.0000	-16.08	-13	Pass

Lower Band

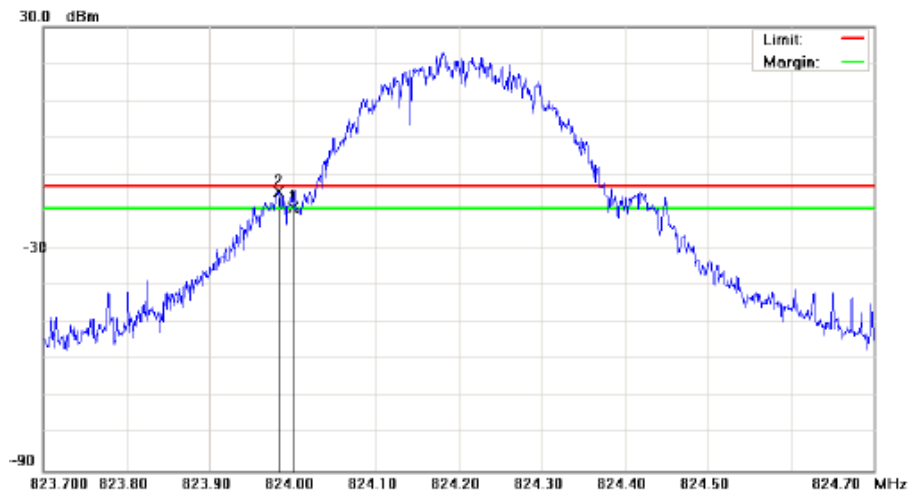

Higher Band

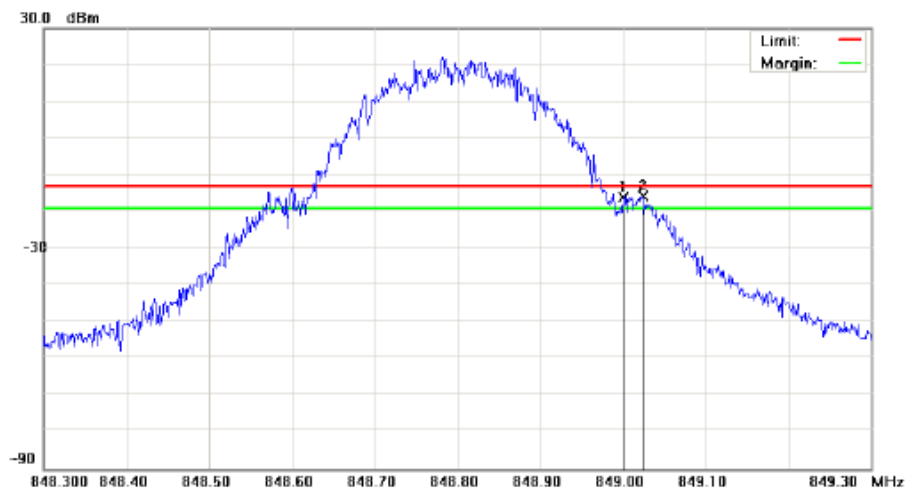

Model Number	GE910-QUAD				
Test Item	Band Edge				
Test Mode	Mode 2: GSM 1900 Link				
Date of Test	05/21/2012		Test Site	TE05	
Band	Channel	Frequency (MHz)	Bandwidth (dBm)	Limit (dBm)	Result
Lower	512	1850.000	-28.05	-13	Pass
Higher	810	1910.000	-33.68	-13	Pass

Lower Band

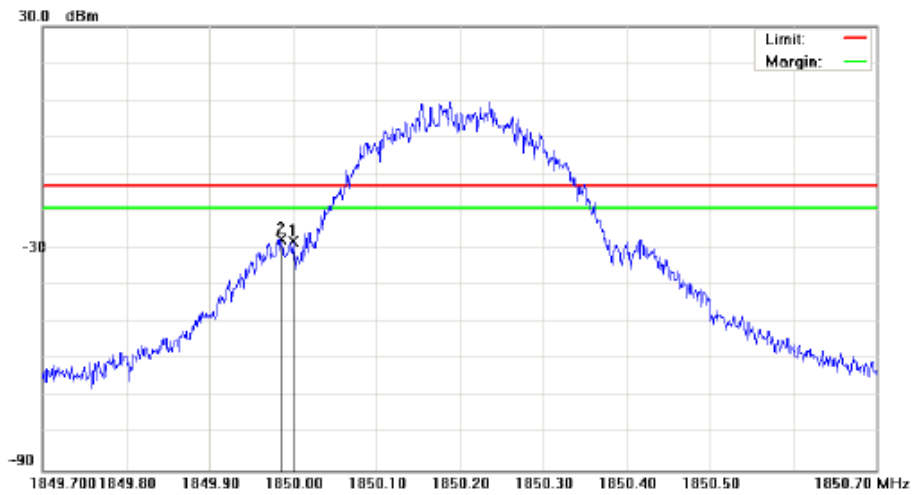

Higher Band

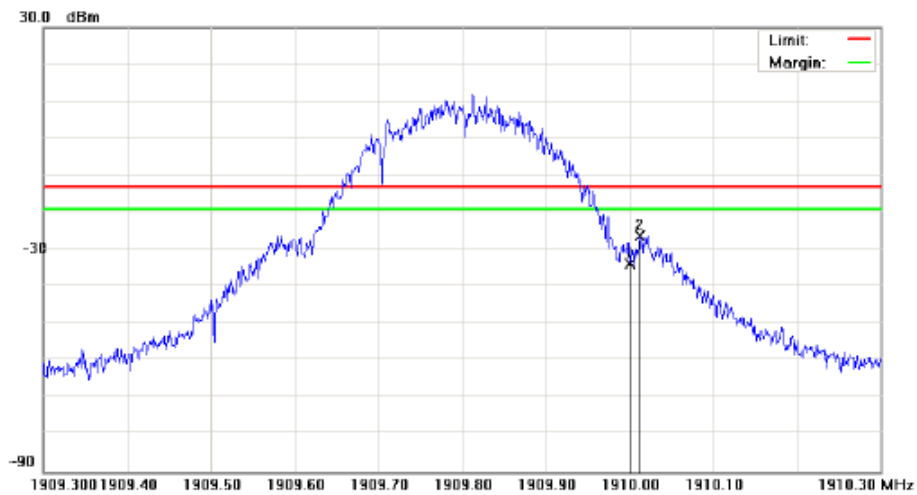

5 Conducted Emission Test

5.1. Limit

The power of any emission outside of the authorized operating frequency ranges must be attenuated below the transmitting power (P) by a factor of at least $43 + 10\log(P)$ dB.

5.2. Test Instruments

Describe	Manufacturer	Model No.	Serial No.	Cal. Date	Remark
Spectrum Analyzer	Agilent	E4445A	MY46181986	05/10/2012	(1)
Universal Radio Communication Tester	ROHDE & SCHWARZ	CMU200	109369	08/10/2010	(2)
Attenuator	RADIALL	R41572000	0603033073	N.C.R.	-----
Power divider	Agilent	87302C	3239A00760	N.C.R.	-----
Test Site	ATL	TE05	TE05	N.C.R.	-----

Remark: ⁽¹⁾ Calibration period 1 year. ⁽²⁾ Calibration period 2 years.

NOTE: N.C.R. = No Calibration Request.

5.3. Setup

Below 2.8GHz

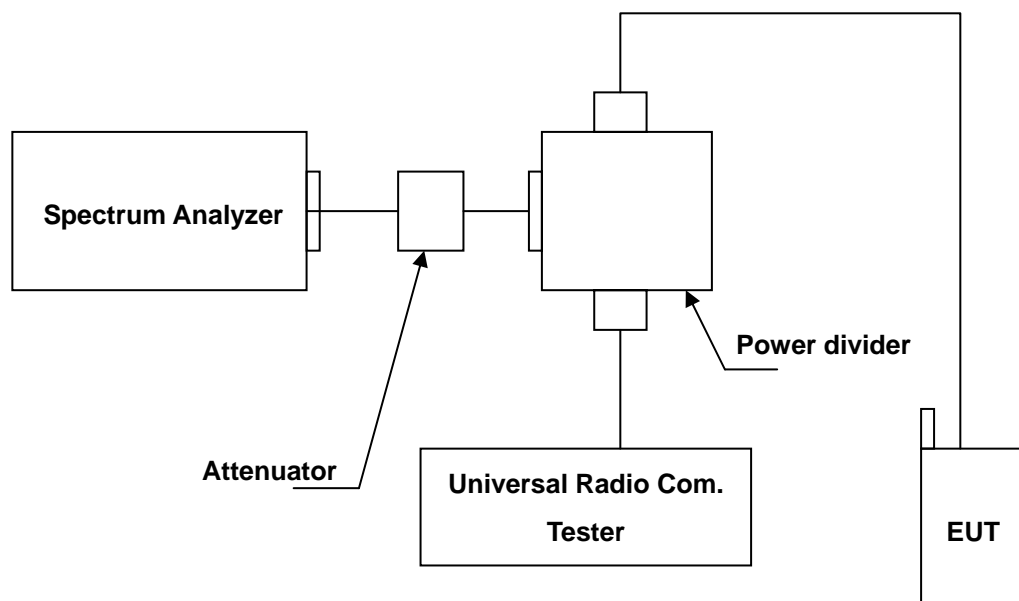

Above 2.8GHz

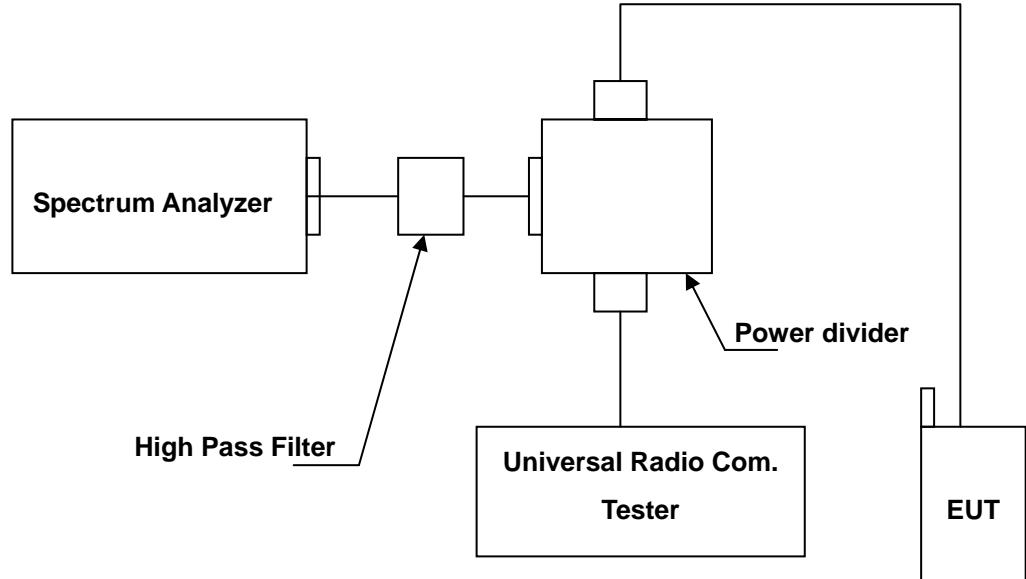

5.4. Test Procedure

1. The EUT was connected to Spectrum Analyzer and Base Station via power divider.
2. The middle channel for the highest RF power within the transmitting frequency was measured.
3. The conducted spurious emission for the whole frequency range was taken.
4. Test setting at GSM 850 RB>100 kHz, VB>100 kHz; PCS 1900 RB>1MHz, VB>1MHz.

5.5. Uncertainty

The measurement uncertainty is evaluated as ± 2.24 dB.

5.6. Test Result

Model Number	GE910-QUAD		
Test Item	Conducted Emission		
Mode	Mode 1: GSM 850 Link Mode 2: GSM 1900 Link		
Date of Test	05/21/2012	Test Site	TE05

File: GE910-QUAD(CH128)

Data :#1

Date: 2012/5/21

Time: 下午 04:18:58

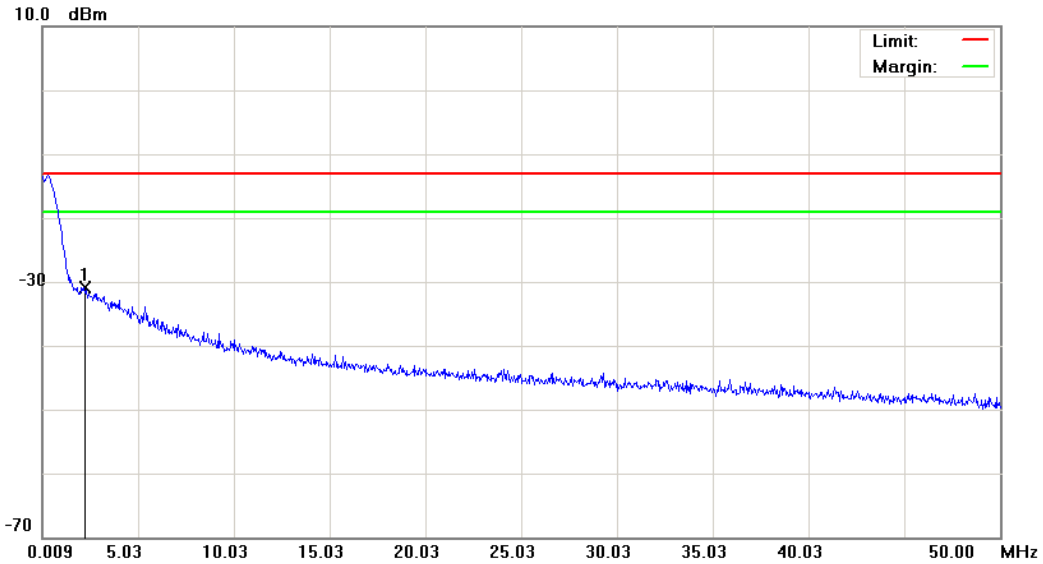

Site: : RF Conducted

 Polarization: *Conducted po*

Temperature: 23 °C

Limit: FCC Part 22 conducted(9k-12.75G)

Power: DC 3.8V

Humidity: 55.2 %

EUT: 2G Module

Distance:

RBW: 1000 kHz VBW: 1000kHz

M/N: GE910-QUAD

Mode: 1

Note:

No.	Mk.	Freq.	Reading Level	Correct Factor	Measurement	Limit	Over	Antenna Height	Table Degree	
		MHz	dBm	dB	dBm	dBm	dB	cm	degree	Comment
1	*	2.1836	-62.17	31.34	-30.83	-13.00	-17.83			peak

*:Maximum data x:Over limit !:over margin

File: GE910-QUAD(CH128)

Data :#2

Date: 2012/5/21

Time: 下午 04:19:23

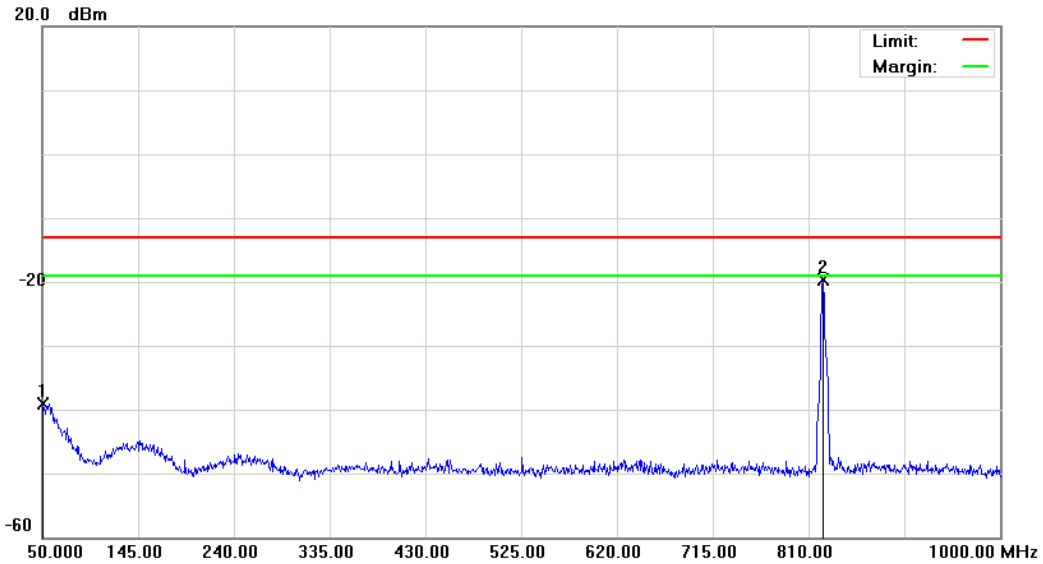

Site: : RF Conducted

 Polarization: *Conducted po*

Temperature: 23 °C

Limit: FCC Part 22 conducted(9k-12.75G)

Power: DC 3.8V

Humidity: 55.2 %

EUT: 2G Module

Distance:

RBW: 1000 kHz VBW: 1000kHz

M/N: GE910-QUAD

Mode: 1

Note:

No.	Mk.	Freq. MHz	Reading Level dBm	Correct Factor dB	Measure- ment dBm	Limit dBm	Over dB	Detector	Antenna Height cm	Table Degree degree	Comment
1		50.0000	-53.77	14.69	-39.08	-13.00	-26.08	peak			
2	*	824.2500	-23.59	3.84	-19.75	-13.00	-6.75	peak			Tx

*:Maximum data x:Over limit !:over margin

File: GE910-QUAD(CH128)

Data :#3

Date: 2012/5/21

Time: 下午 04:32:47

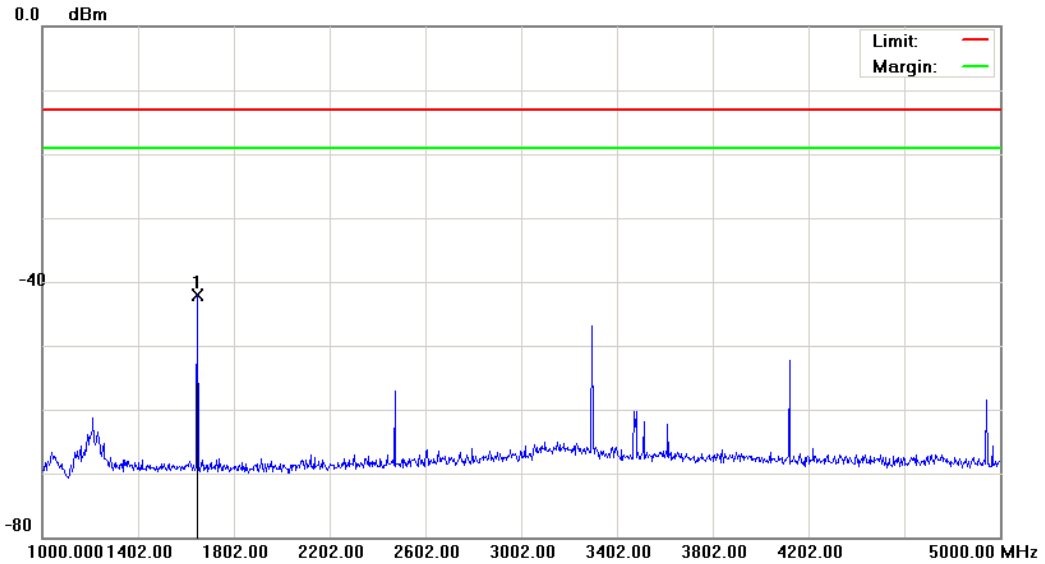

Site: : RF Conducted

 Polarization: *Conducted po*

Temperature: 23 °C

Limit: FCC Part 22 conducted(9k-12.75G)

Power: DC 3.8V

Humidity: 55.2 %

EUT: 2G Module

Distance:

RBW: 1000 kHz VBW: 1000kHz

M/N: GE910-QUAD

Mode: 1

Note:

No.	Mk.	Freq. MHz	Reading Level dBm	Correct Factor dB	Measure- ment dBm	Limit dBm	Over dB	Detector	Antenna Height cm	Table Degree degree	Comment
1	*	1648.000	-46.49	4.45	-42.04	-13.00	-29.04	peak			

*:Maximum data x:Over limit !:over margin

File: GE910-QUAD(CH128)

Data :#4

Date: 2012/5/21

Time: 下午 04:33:11

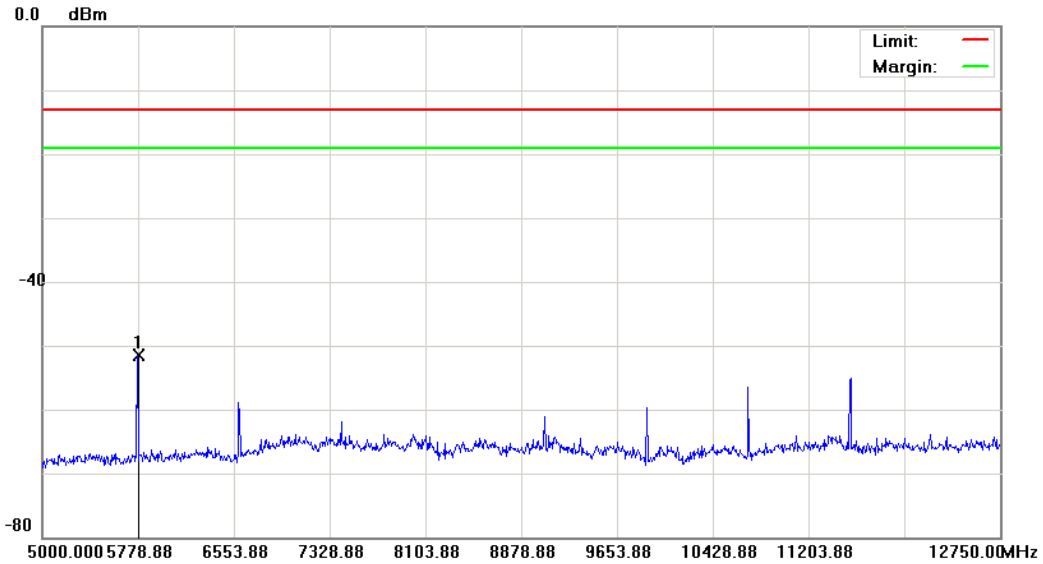

Site: : RF Conducted	Polarization: Conducted po	Temperature: 23 °C
Limit: FCC Part 22 conducted(9k-12.75G)	Power: DC 3.8V	Humidity: 55.2 %
EUT: 2G Module	Distance:	RBW: 1000 kHz VBW: 1000kHz
M/N: GE910-QUAD		
Mode: 1		
Note:		

No.	Mk.	Freq. MHz	Reading Level dBm	Correct Factor dB	Measure- ment dBm	Limit dBm	Over dB	Antenna Height cm	Table Degree degree	Comment
1	*	5771.125	-56.60	5.01	-51.59	-13.00	-38.59	peak		

*:Maximum data x:Over limit !:over margin

File: GE910-QUAD(CH190)

Data :#1

Date: 2012/5/21

Time: 下午 04:21:22

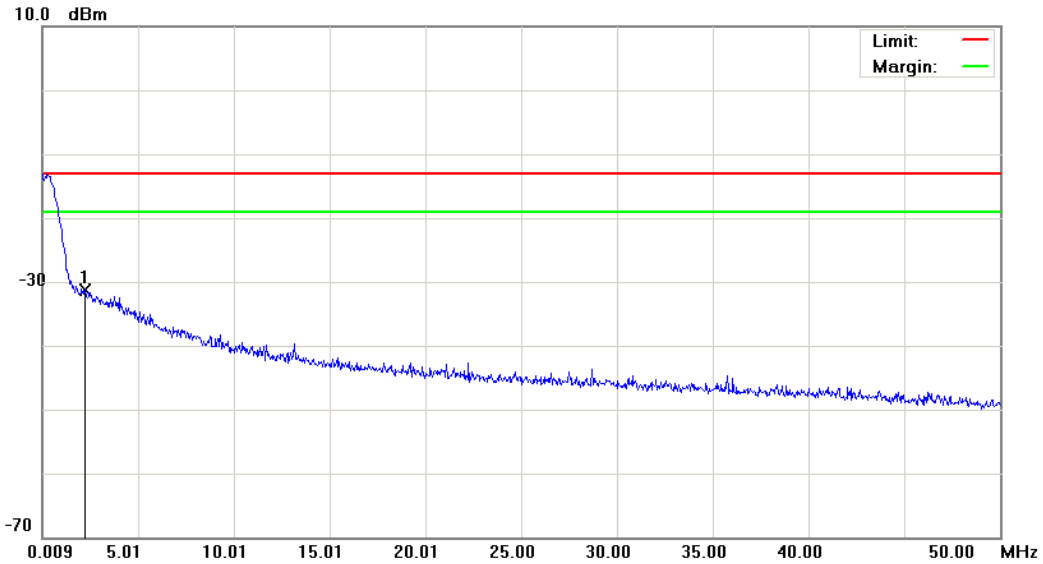

Site: : RF Conducted

 Polarization: *Conducted po*

Temperature: 23 °C

Limit: FCC Part 22 conducted(9k-12.75G)

Power: DC 3.8V

Humidity: 55.2 %

EUT: 2G Module

Distance:

RBW: 1000 kHz VBW: 1000kHz

M/N: GE910-QUAD

Mode: 1

Note:

No.	Mk.	Freq.	Reading Level	Correct Factor	Measurement	Limit	Over	Antenna Height	Table Degree	
		MHz	dBm	dB	dBm	dBm	dB	cm	degree	Comment
1	*	2.2585	-62.43	31.14	-31.29	-13.00	-18.29			peak

*:Maximum data x:Over limit !:over margin

File: GE910-QUAD(CH190)

Data :#2

Date: 2012/5/21

Time: 下午 04:21:47

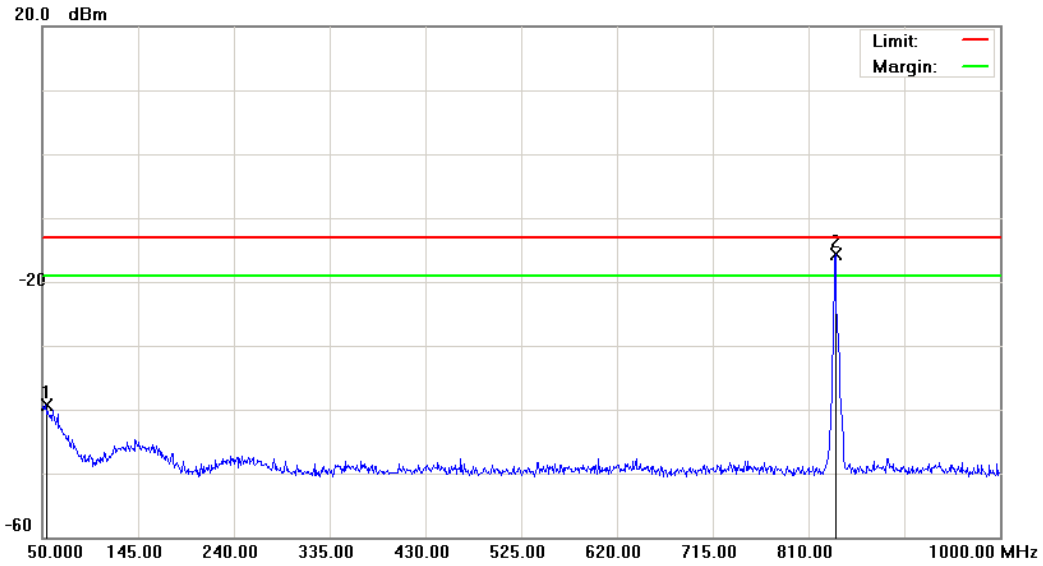

Site: : RF Conducted

 Polarization: *Conducted po*

Temperature: 23 °C

Limit: FCC Part 22 conducted(9k-12.75G)

Power: DC 3.8V

Humidity: 55.2 %

EUT: 2G Module

Distance:

RBW: 1000 kHz VBW: 1000kHz

M/N: GE910-QUAD

Mode: 1

Note:

No.	Mk.	Freq. MHz	Reading Level dBm	Correct Factor dB	Measure- ment dBm	Limit dBm	Over dB	Detector	Antenna Height cm	Table Degree degree	Comment
1		53.3250	-53.37	14.10	-39.27	-13.00	-26.27	peak			
2	*	836.6000	-19.63	3.96	-15.67	-13.00	-2.67	peak			Tx

*:Maximum data x:Over limit !:over margin

File:GE910-QUAD(CH190)

Data :#3

Date:2012/5/21

Time: 下午 04:33:50

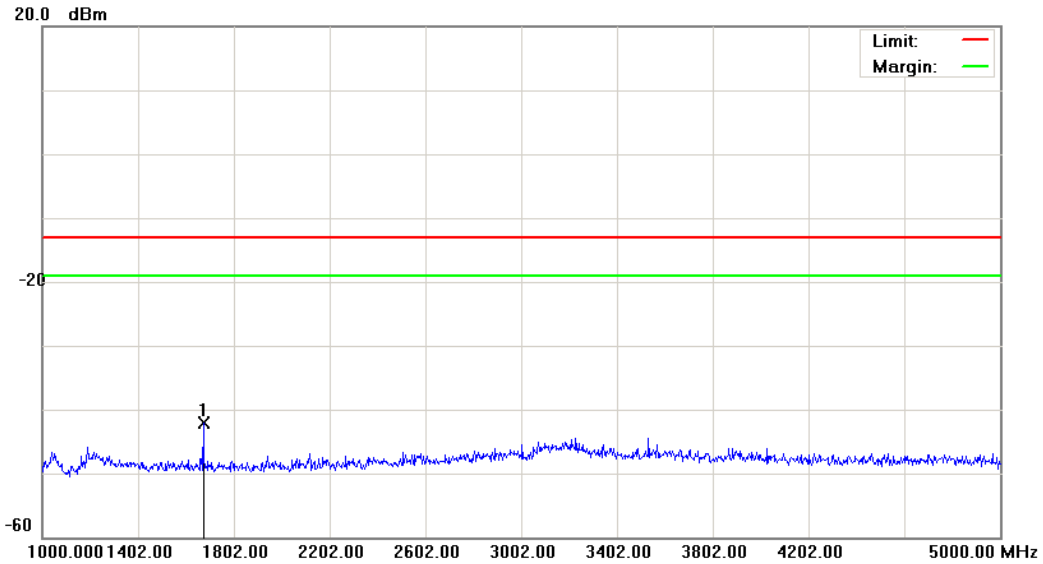

Site: : RF Conducted

 Polarization: *Conducted po*

Temperature: 23 °C

Limit: FCC Part 22 conducted(9k-12.75G)

Power: DC 3.8V

Humidity: 55.2 %

EUT: 2G Module

Distance:

RBW: 1000 kHz VBW: 1000kHz

M/N: GE910-QUAD

Mode: 1

Note:

No.	Mk.	Freq.	Reading Level	Correct Factor	Measurement	Limit	Over	Antenna Height	Table Degree
		MHz	dBm	dB	dBm	dBm	dB	cm	degree
1	*	1674.000	-46.53	4.46	-42.07	-13.00	-29.07	peak	

*:Maximum data x:Over limit !:over margin

File: GE910-QUAD(CH190)

Data :#4

Date: 2012/5/21

Time: 下午 04:34:14

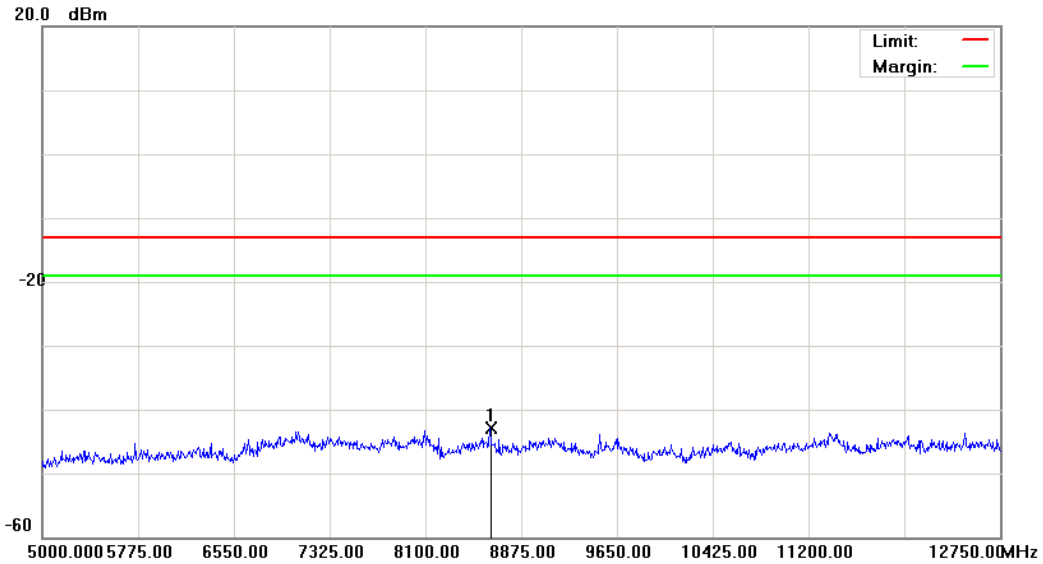

Site: : RF Conducted

 Polarization: *Conducted po*

Temperature: 23 °C

Limit: FCC Part 22 conducted(9k-12.75G)

Power: DC 3.8V

Humidity: 55.2 %

EUT: 2G Module

Distance:

RBW: 1000 kHz VBW: 1000kHz

M/N: GE910-QUAD

Mode: 1

Note:

No.	Mk.	Freq.	Reading Level	Correct Factor	Measurement	Limit	Over	Antenna Height	Table Degree	Detector	Comment
		MHz	dBm	dB	dBm	dBm	dB	cm	degree		
1	*	8623.125	-48.73	5.83	-42.90	-13.00	-29.90			peak	

*:Maximum data x:Over limit !:over margin

File: GE910-QUAD(CH251)

Data :#1

Date: 2012/5/21

Time: 下午 04:23:51

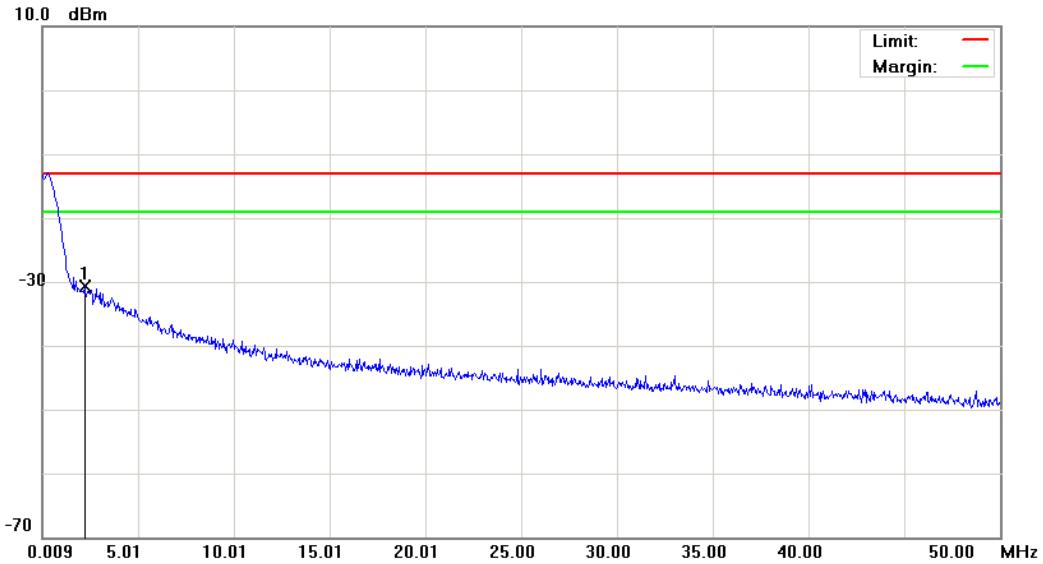

Site: : RF Conducted

 Polarization: *Conducted po*

Temperature: 23 °C

Limit: FCC Part 22 conducted(9k-12.75G)

Power: DC 3.8V

Humidity: 55.2 %

EUT: 2G Module

Distance:

RBW: 1000 kHz VBW: 1000kHz

M/N: GE910-QUAD

Mode: 1

Note:

No.	Mk.	Freq.	Reading Level	Correct Factor	Measurement	Limit	Over	Antenna Height	Table Degree	
		MHz	dBm	dB	dBm	dBm	dB	cm	degree	Comment
1	*	2.2336	-61.99	31.20	-30.79	-13.00	-17.79			peak

*:Maximum data x:Over limit !:over margin

File:GE910-QUAD(CH251)

Data :#2

Date:2012/5/21

Time: 下午 04:24:15

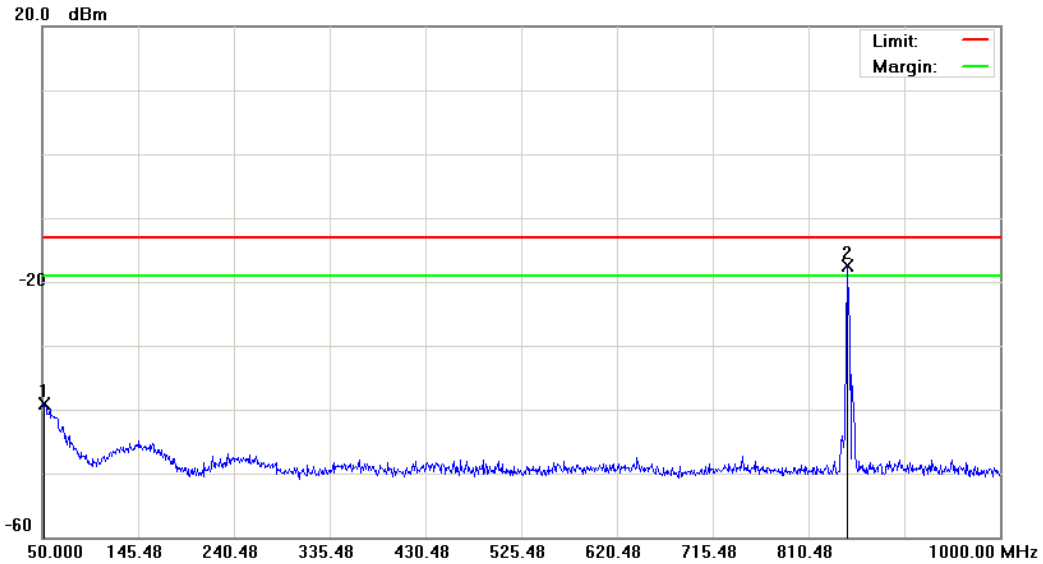

Site: : RF Conducted

 Polarization: *Conducted po*

Temperature: 23 °C

Limit: FCC Part 22 conducted(9k-12.75G)

Power: DC 3.8V

Humidity: 55.2 %

EUT: 2G Module

Distance:

RBW: 1000 kHz VBW: 1000kHz

M/N: GE910-QUAD

Mode: 1

Note:

No.	Mk.	Freq. MHz	Reading Level dBm	Correct Factor dB	Measure- ment dBm	Limit dBm	Over dB	Detector	Antenna Height cm	Table Degree degree	Comment
1		51.4250	-53.48	14.44	-39.04	-13.00	-26.04	peak			
2	*	848.9500	-21.55	3.98	-17.57	-13.00	-4.57	peak			Tx

*:Maximum data x:Over limit !:over margin

File:GE910-QUAD(CH251)

Data :#3

Date:2012/5/21

Time: 下午 04:35:24

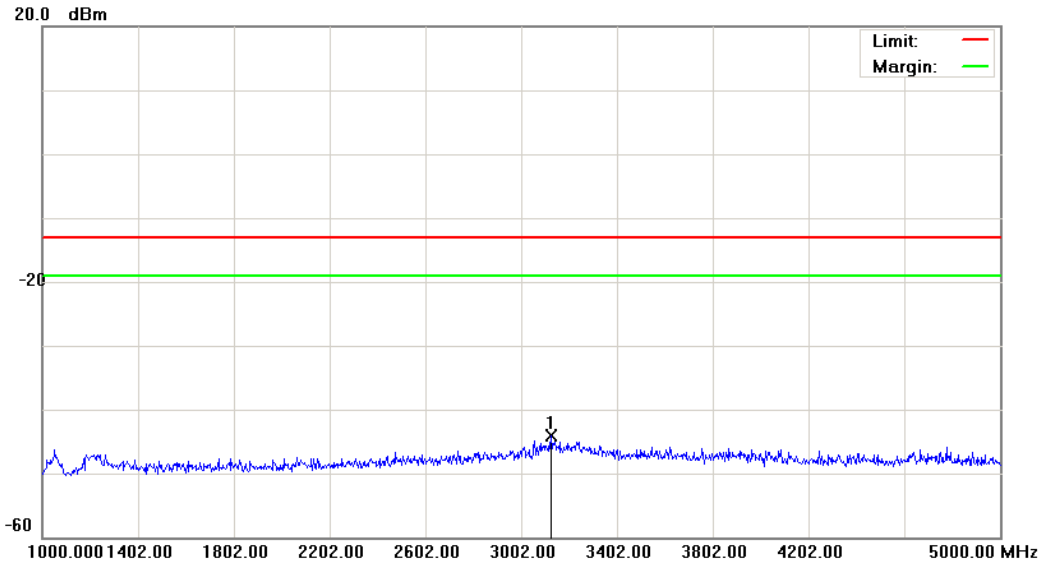

Site: : RF Conducted

 Polarization: *Conducted po*

Temperature: 23 °C

Limit: FCC Part 22 conducted(9k-12.75G)

Power: DC 3.8V

Humidity: 55.2 %

EUT: 2G Module

Distance:

RBW: 1000 kHz VBW: 1000kHz

M/N: GE910-QUAD

Mode: 1

Note:

No.	Mk.	Freq.	Reading Level	Correct Factor	Measurement	Limit	Over	Antenna Height	Table Degree	Detector	Comment
		MHz	dBm	dB	dBm	dBm	dB	cm	degree		
1	*	3124.000	-48.75	4.56	-44.19	-13.00	-31.19			peak	

*:Maximum data x:Over limit !:over margin

File:GE910-QUAD(CH251)

Data :#4

Date:2012/5/21

Time: 下午 04:35:48

20.0 dBm

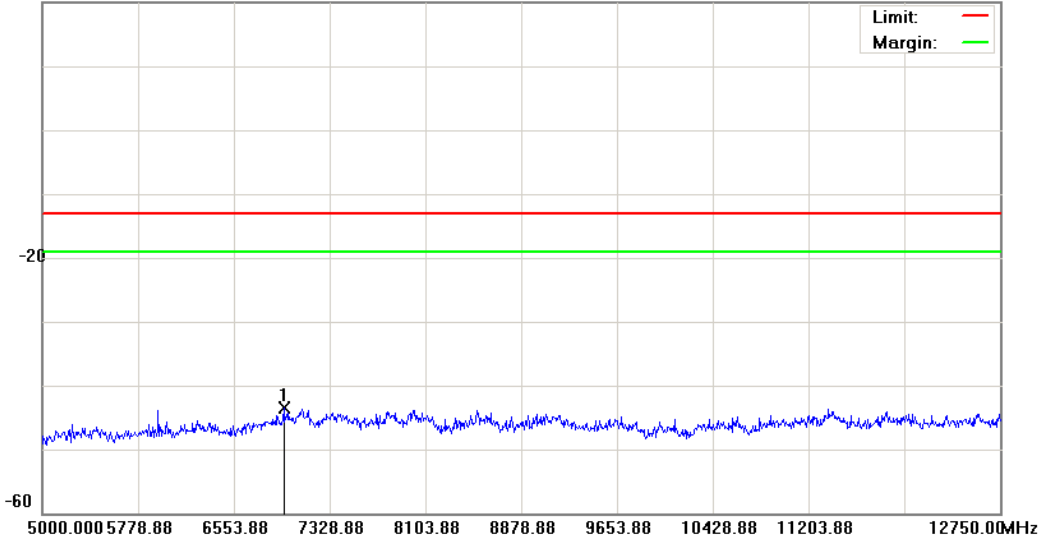

Site: : RF Conducted	Polarization: Conducted po	Temperature: 23 ℃
Limit: FCC Part 22 conducted(9k-12.75G)	Power: DC 3.8V	Humidity: 55.2 %
EUT: 2G Module	Distance:	RBW: 1000 kHz VBW: 1000kHz
M/N: GE910-QUAD		
Mode: 1		
Note:		

No.	Mk.	Freq. MHz	Reading Level dBm	Correct Factor dB	Measure- ment dBm	Limit dBm	Over dB	Detector	Antenna Height cm	Table Degree degree	Comment
1	*	6956.875	-48.50	5.01	-43.49	-13.00	-30.49	peak			

*:Maximum data x:Over limit !:over margin

File: GE910-QUAD(CH512)

Data :#1

Date: 2012/5/21

Time: 下午 04:02:57

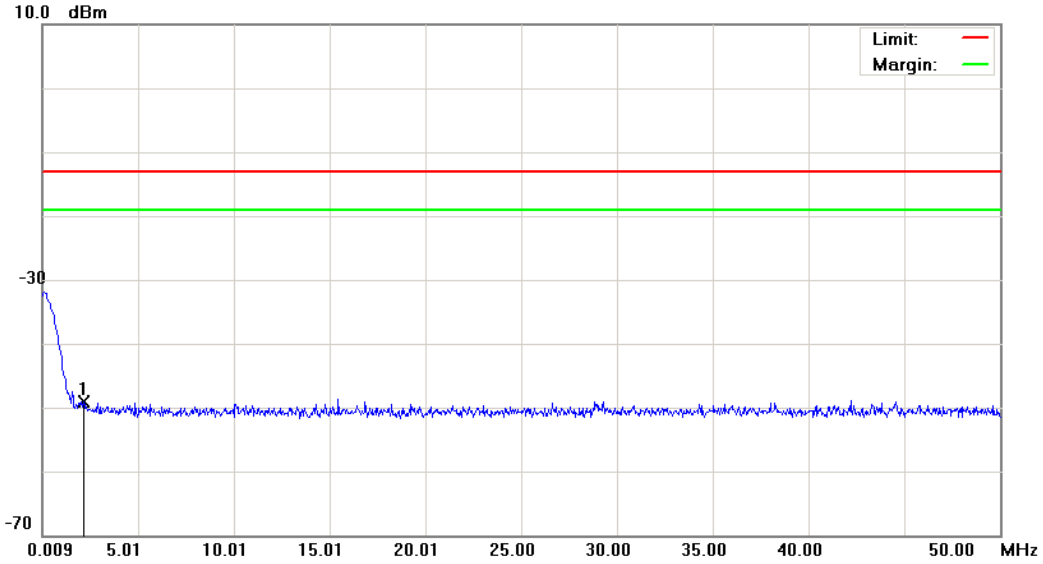

Site: : RF Conducted	Polarization: Conducted po	Temperature: 23 °C
Limit: FCC Part 24 conducted(9k-12.75G)	Power: DC 3.8V	Humidity: 55.2 %
EUT: 2G Module	Distance:	RBW: 1000 kHz VBW: 1000kHz
M/N: GE910-QUAD		
Mode: 2		
Note:		

No.	Mk.	Freq.	Reading Level	Correct Factor	Measurement	Limit	Over	Antenna Height	Table Degree	
		MHz	dBm	dB	dBm	dBm	dB	cm	degree	Comment
1	*	2.1585	-62.14	13.12	-49.02	-13.00	-36.02			peak

*:Maximum data x:Over limit !:over margin

File: GE910-QUAD(CH512)

Data :#2

Date: 2012/5/21

Time: 下午 04:03:21

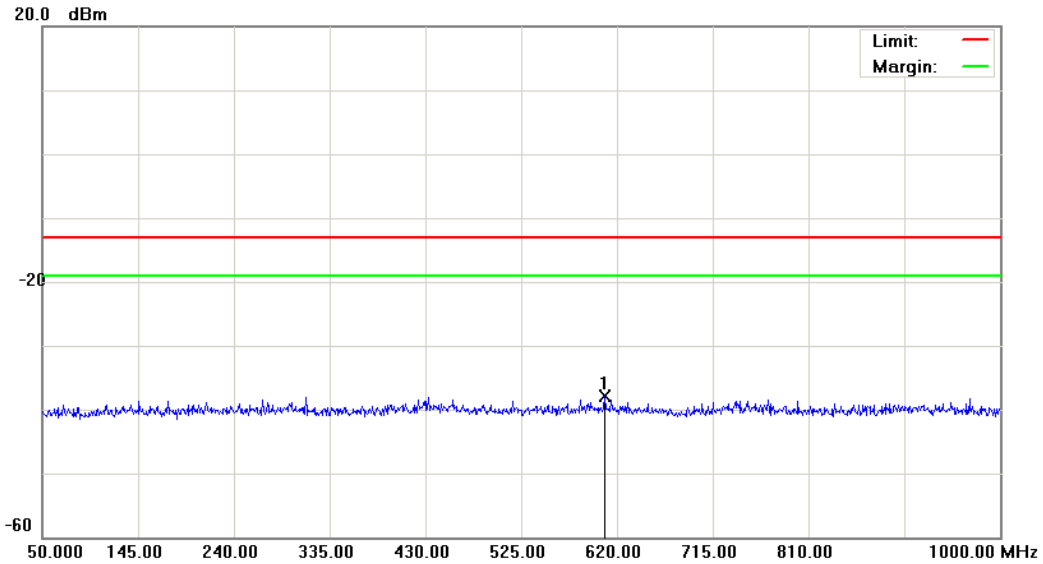

Site: : RF Conducted

 Polarization: *Conducted po*

Temperature: 23 °C

Limit: FCC Part 24 conducted(9k-12.75G)

Power: DC 3.8V

Humidity: 55.2 %

EUT: 2G Module

Distance:

RBW: 1000 kHz VBW: 1000kHz

M/N: GE910-QUAD

Mode: 2

Note:

No.	Mk.	Freq. MHz	Reading Level dBm	Correct Factor dB	Measure- ment dBm	Limit dBm	Over dB	Detector	Antenna Height cm	Table Degree degree	Comment
1	*	607.6500	-51.02	13.17	-37.85	-13.00	-24.85	peak			

*:Maximum data x:Over limit !:over margin

File:GE910-QUAD(CH512)

Data :#3

Date:2012/5/21

Time: 下午 04:10:22

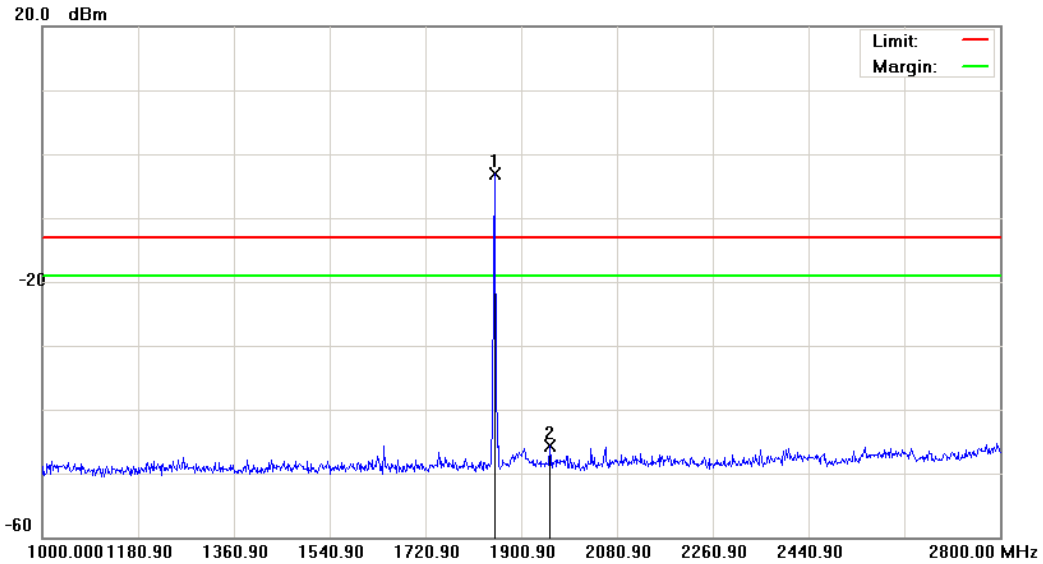

Site: : RF Conducted	Polarization: Conducted po	Temperature: 23 °C
Limit: FCC Part 24 conducted(9k-12.75G)	Power: DC 3.8V	Humidity: 55.2 %
EUT: 2G Module	Distance:	RBW: 1000 kHz VBW: 1000kHz
M/N: GE910-QUAD		
Mode: 2		
Note:		

No.	Mk.	Freq. MHz	Reading Level dBm	Correct Factor dB	Measure- ment dBm	Limit dBm	Over dB	Detector	Antenna Height cm	Table Degree degree	Comment
1	*	1850.500	-7.32	4.26	-3.06	-13.00	9.94	peak			Tx
2		1954.000	-50.41	4.69	-45.72	-13.00	-32.72	peak			

*:Maximum data x:Over limit !:over margin

File: GE910-QUAD(CH512)

Data :#4

Date: 2012/5/21

Time: 下午 04:39:11

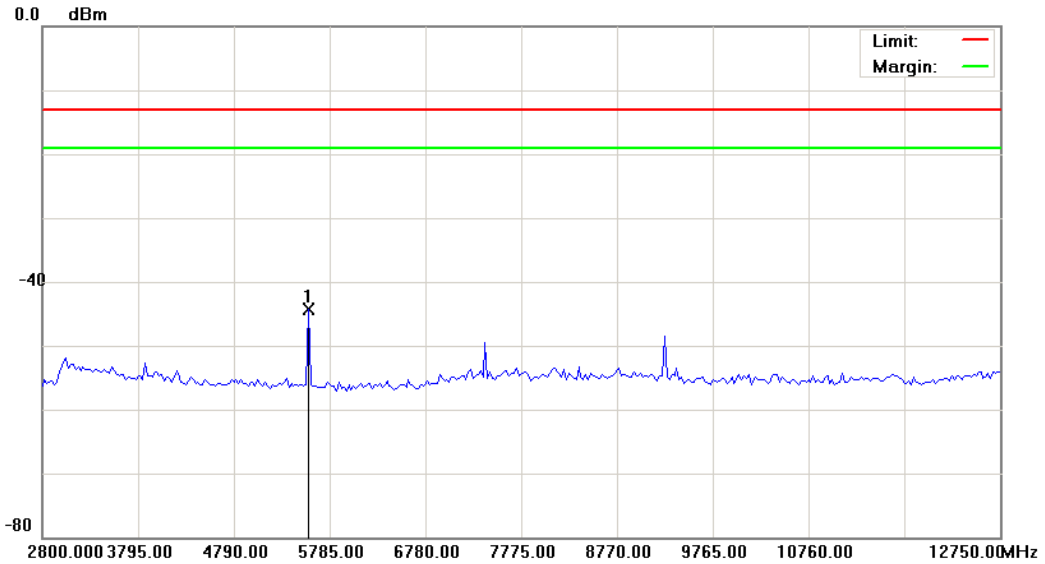

Site: : RF Conducted

 Polarization: **Conducted po**

Temperature: 23 °C

Limit: FCC Part 24 conducted(9k-12.75G)

Power: DC 3.8V

Humidity: 55.2 %

EUT: 2G Module

Distance:

RBW: 1000 kHz VBW: 1000kHz

M/N: GE910-QUAD

Mode: 2

Note:

No.	Mk.	Freq. MHz	Reading Level dBm	Correct Factor dB	Measure- ment dBm	Limit dBm	Over dB	Detector	Antenna Height cm	Table Degree degree	Comment
1	*	5561.125	-49.26	4.89	-44.37	-13.00	-31.37	peak			

*:Maximum data x:Over limit !:over margin

File: GE910-QUAD(CH512)

Data :#5

Date: 2012/5/21

Time: 下午 04:39:33

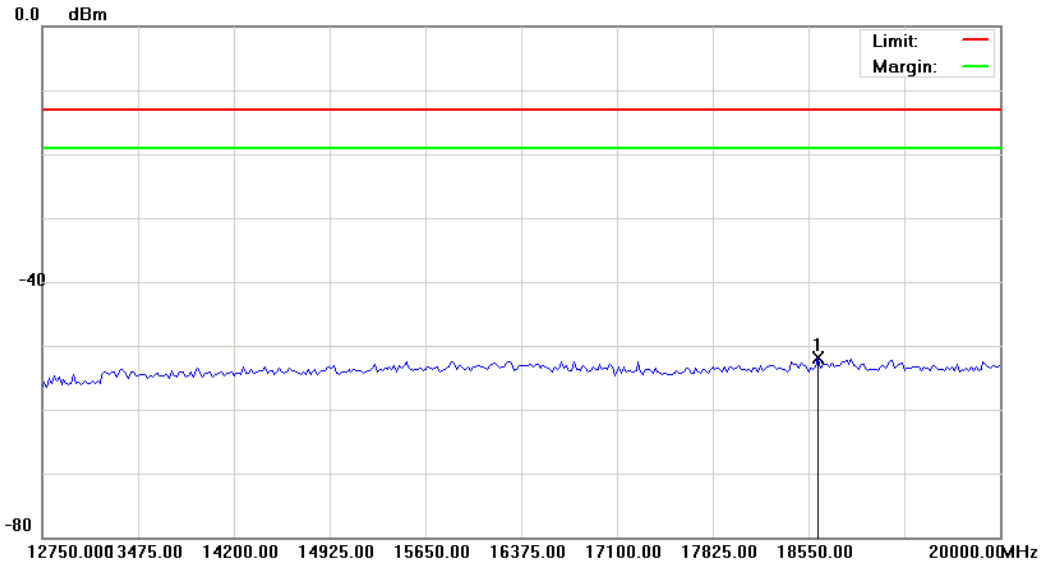

Site: : RF Conducted

 Polarization: *Conducted po*

Temperature: 23 °C

Limit: FCC Part 24 conducted(9k-12.75G)

Power: DC 3.8V

Humidity: 55.2 %

EUT: 2G Module

Distance:

RBW: 1000 kHz VBW: 1000kHz

M/N: GE910-QUAD

Mode: 2

Note:

No.	Mk.	Freq. MHz	Reading Level dBm	Correct Factor dB	Measure- ment dBm	Limit dBm	Over dB	Antenna Height cm	Table Degree degree	Comment
1	*	18622.500	-58.96	7.05	-51.91	-13.00	-38.91	peak		

*:Maximum data x:Over limit !:over margin

File: GE910-QUAD(CH661)

Data :#1

Date: 2012/5/21

Time: 下午 04:04:19

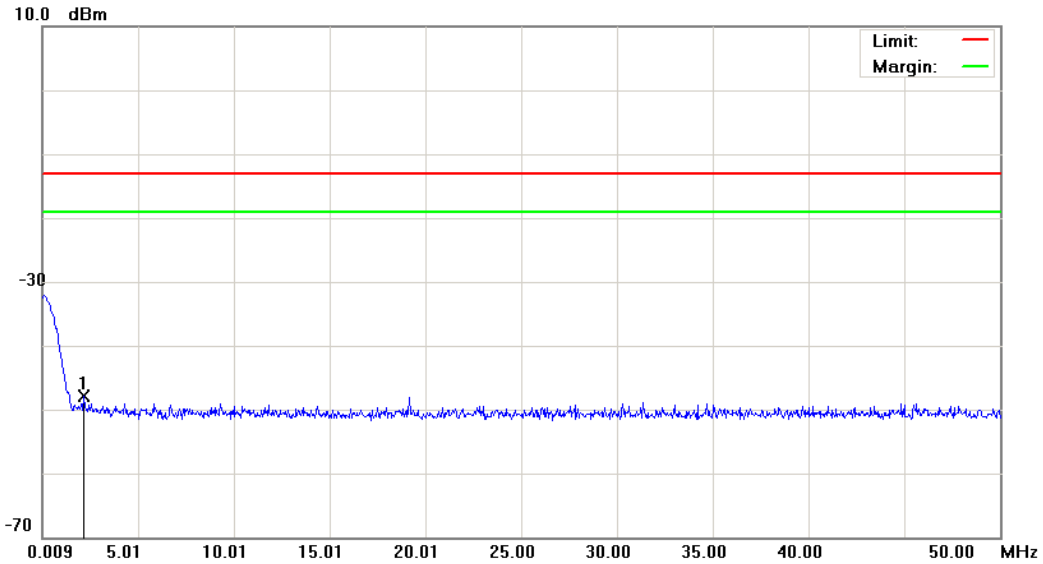

Site: : RF Conducted

 Polarization: *Conducted po*

Temperature: 23 °C

Limit: FCC Part 24 conducted(9k-12.75G)

Power: DC 3.8V

Humidity: 55.2 %

EUT: 2G Module

Distance:

RBW: 1000 kHz VBW: 1000kHz

M/N: GE910-QUAD

Mode: 2

Note:

No.	Mk.	Freq.	Reading Level	Correct Factor	Measurement	Limit	Over	Antenna Height	Table Degree	
		MHz	dBm	dB	dBm	dBm	dB	cm	degree	Comment
1	*	2.1585	-61.11	13.12	-47.99	-13.00	-34.99			peak

*:Maximum data x:Over limit !:over margin

File: GE910-QUAD(CH661)

Data :#2

Date: 2012/5/21

Time: 下午 04:04:43

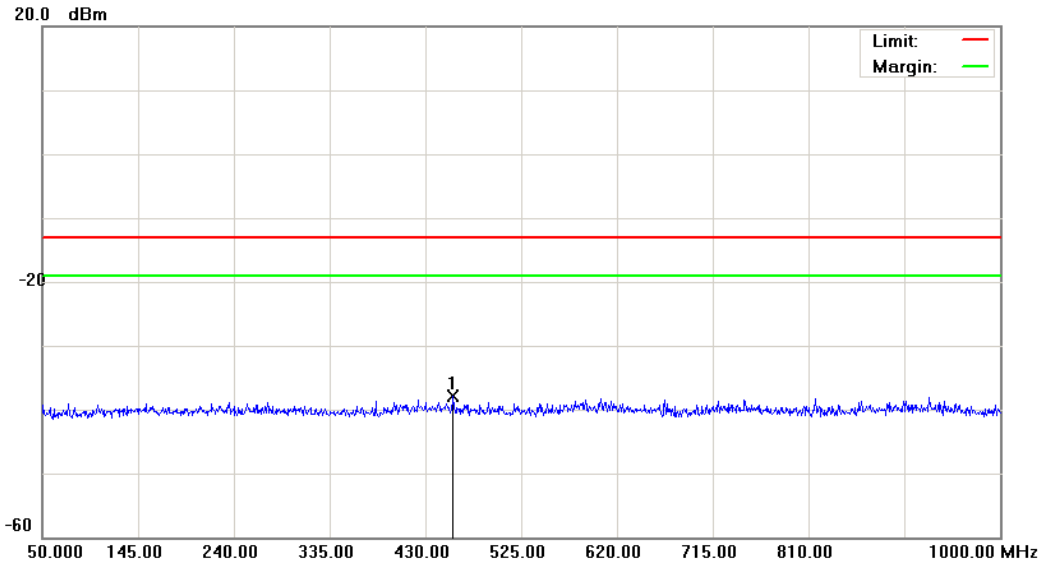

Site: : RF Conducted

 Polarization: *Conducted po*

Temperature: 23 °C

Limit: FCC Part 24 conducted(9k-12.75G)

Power: DC 3.8V

Humidity: 55.2 %

EUT: 2G Module

Distance:

RBW: 1000 kHz VBW: 1000kHz

M/N: GE910-QUAD

Mode: 2

Note:

No.	Mk.	Freq.	Reading Level	Correct Factor	Measurement	Limit	Over	Antenna Height	Table Degree
		MHz	dBm	dB	dBm	dBm	dB	cm	degree
1	*	457.5500	-51.11	13.21	-37.90	-13.00	-24.90	peak	

*:Maximum data x:Over limit !:over margin

File:GE910-QUAD(CH661)

Data :#3

Date:2012/5/21

Time: 下午 04:14:59

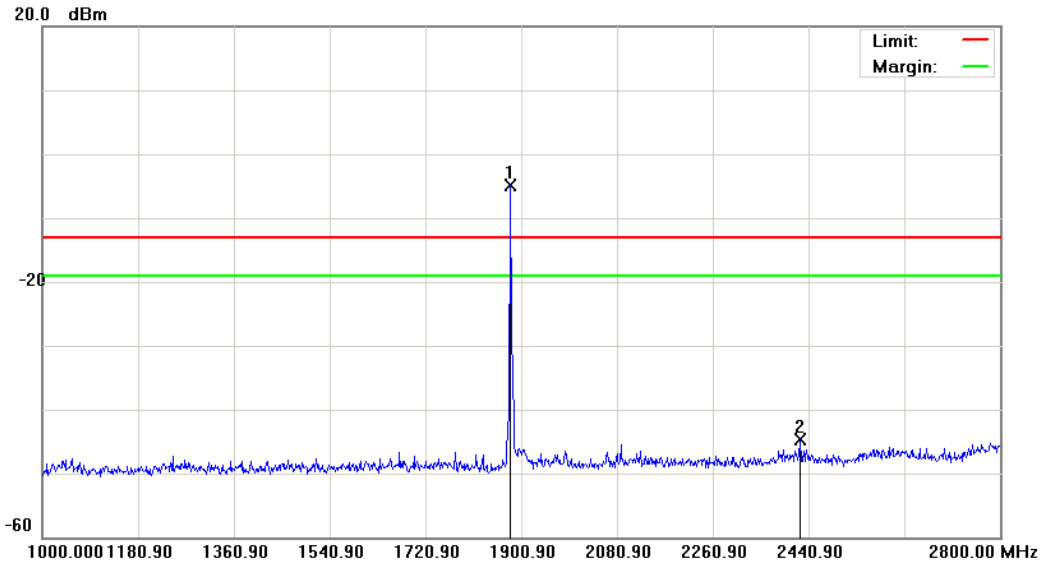

Site: : RF Conducted

 Polarization: **Conducted po**

Temperature: 23 °C

Limit: FCC Part 24 conducted(9k-12.75G)

Power: DC 3.8V

Humidity: 55.2 %

EUT: 2G Module

Distance:

RBW: 1000 kHz VBW: 1000kHz

M/N: GE910-QUAD

Mode: 2

Note:

No.	Mk.	Freq. MHz	Reading Level dBm	Correct Factor dB	Measure- ment dBm	Limit dBm	Over dB	Detector	Antenna Height cm	Table Degree degree	Comment
1	*	1880.200	-9.53	4.65	-4.88	-13.00	8.12	peak			Tx
2		2423.800	-49.91	5.12	-44.79	-13.00	-31.79	peak			

*:Maximum data x:Over limit !:over margin

File: GE910-QUAD(CH661)

Data :#4

Date: 2012/5/21

Time: 下午 04:45:17

20.0 dBm

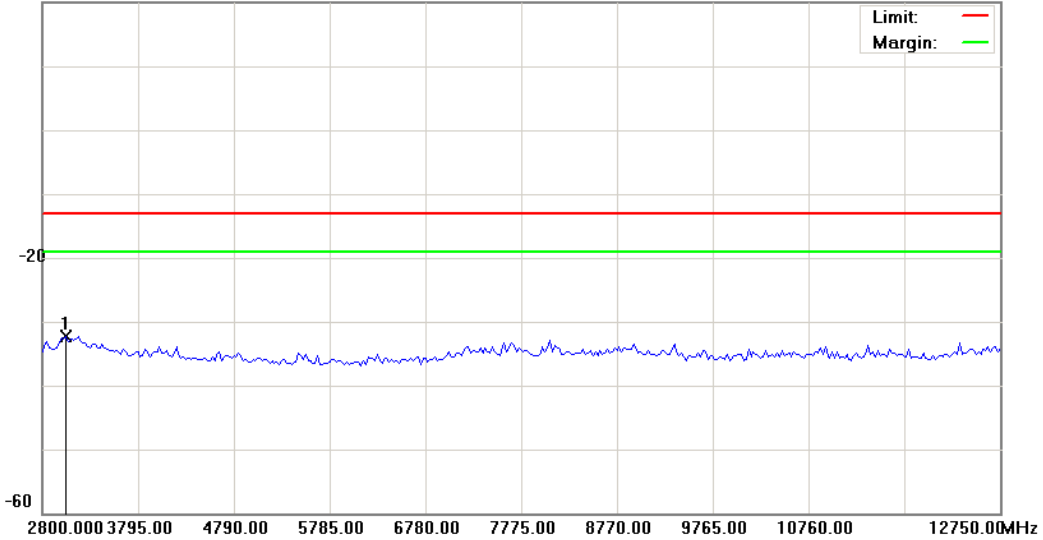

Site: : RF Conducted	Polarization: Conducted po	Temperature: 23 °C
Limit: FCC Part 24 conducted(9k-12.75G)	Power: DC 3.8V	Humidity: 55.2 %
EUT: 2G Module	Distance:	RBW: 1000 kHz VBW: 1000kHz
M/N: GE910-QUAD		
Mode: 2		
Note:		

No.	Mk.	Freq. MHz	Reading Level dBm	Correct Factor dB	Measure- ment dBm	Limit dBm	Over dB	Detector	Antenna Height cm	Table Degree degree	Comment
1	*	3048.750	-37.73	5.47	-32.26	-13.00	-19.26	peak			

*:Maximum data x:Over limit !:over margin

File: GE910-QUAD(CH661)

Data :#5

Date: 2012/5/21

Time: 下午 04:45:39

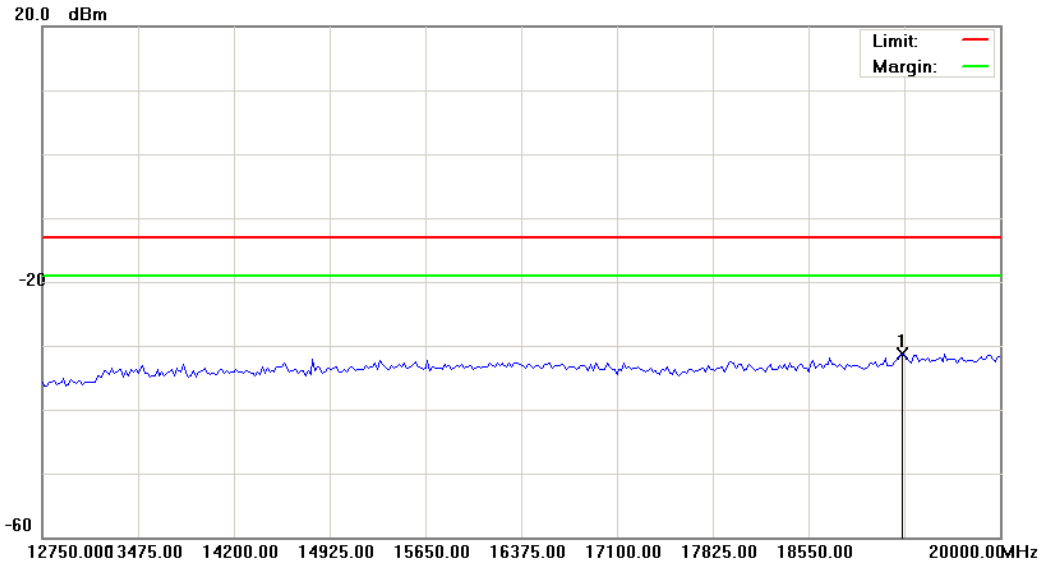

Site: : RF Conducted

 Polarization: **Conducted po**

Temperature: 23 °C

Limit: FCC Part 24 conducted(9k-12.75G)

Power: DC 3.8V

Humidity: 55.2 %

EUT: 2G Module

Distance:

RBW: 1000 kHz VBW: 1000kHz

M/N: GE910-QUAD

Mode: 2

Note:

No.	Mk.	Freq. MHz	Reading Level dBm	Correct Factor dB	Measure- ment dBm	Limit dBm	Over dB	Detector	Antenna Height cm	Table Degree degree	Comment
1	*	19256.875	-38.43	7.23	-31.20	-13.00	-18.20	peak			

*:Maximum data x:Over limit !:over margin

File: GE910-QUAD(CH810)

Data :#1

Date: 2012/5/21

Time: 下午 04:05:52

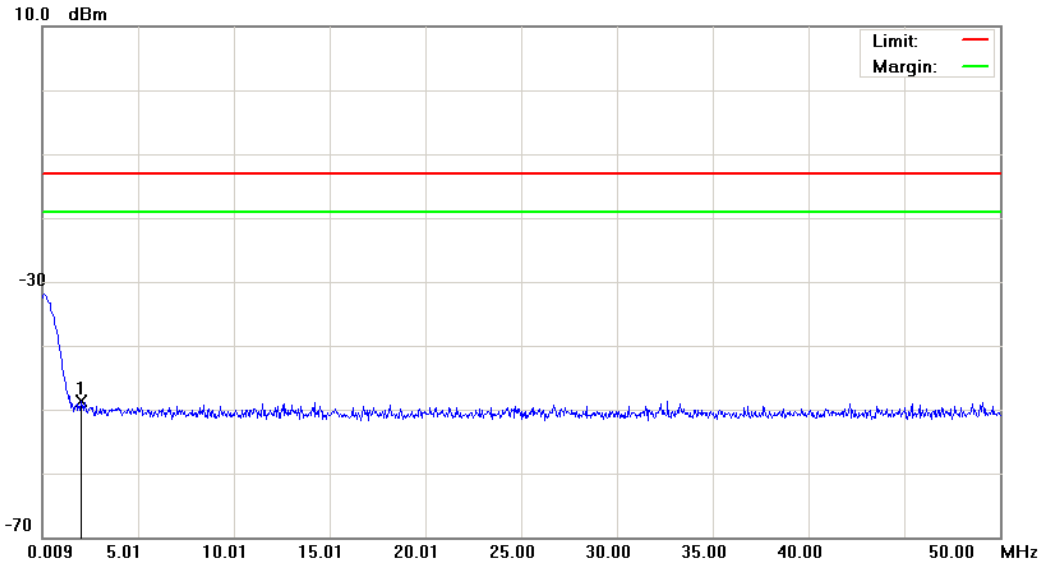

Site: : RF Conducted	Polarization: <i>Conducted po</i>	Temperature: 23 °C
Limit: FCC Part 24 conducted(9k-12.75G)	Power: DC 3.8V	Humidity: 55.2 %
EUT: 2G Module	Distance:	RBW: 1000 kHz VBW: 1000kHz
M/N: GE910-QUAD		
Mode: 2		
Note:		

No.	Mk.	Freq.	Reading Level	Correct Factor	Measurement	Limit	Over	Antenna Height	Table Degree	
		MHz	dBm	dB	dBm	dBm	dB	cm	degree	Comment
1	*	2.0335	-61.92	13.20	-48.72	-13.00	-35.72			peak

*:Maximum data x:Over limit !:over margin

File: GE910-QUAD(CH810)

Data :#2

Date: 2012/5/21

Time: 下午 04:06:16

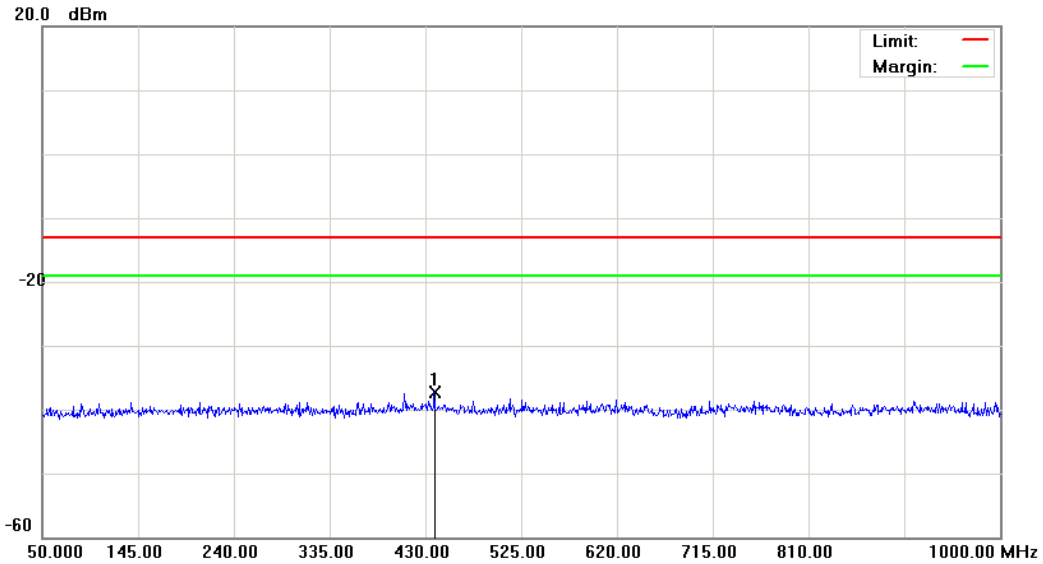

Site: : RF Conducted

 Polarization: *Conducted po*

Temperature: 23 °C

Limit: FCC Part 24 conducted(9k-12.75G)

Power: DC 3.8V

Humidity: 55.2 %

EUT: 2G Module

Distance:

RBW: 1000 kHz VBW: 1000kHz

M/N: GE910-QUAD

Mode: 2

Note:

No.	Mk.	Freq.	Reading Level	Correct Factor	Measurement	Limit	Over	Antenna Height	Table Degree	
		MHz	dBm	dB	dBm	dBm	dB	cm	degree	Comment
1	*	439.0250	-50.44	13.21	-37.23	-13.00	-24.23			peak

*:Maximum data x:Over limit !:over margin

File:GE910-QUAD(CH810)

Data :#3

Date:2012/5/21

Time: 下午 04:16:36

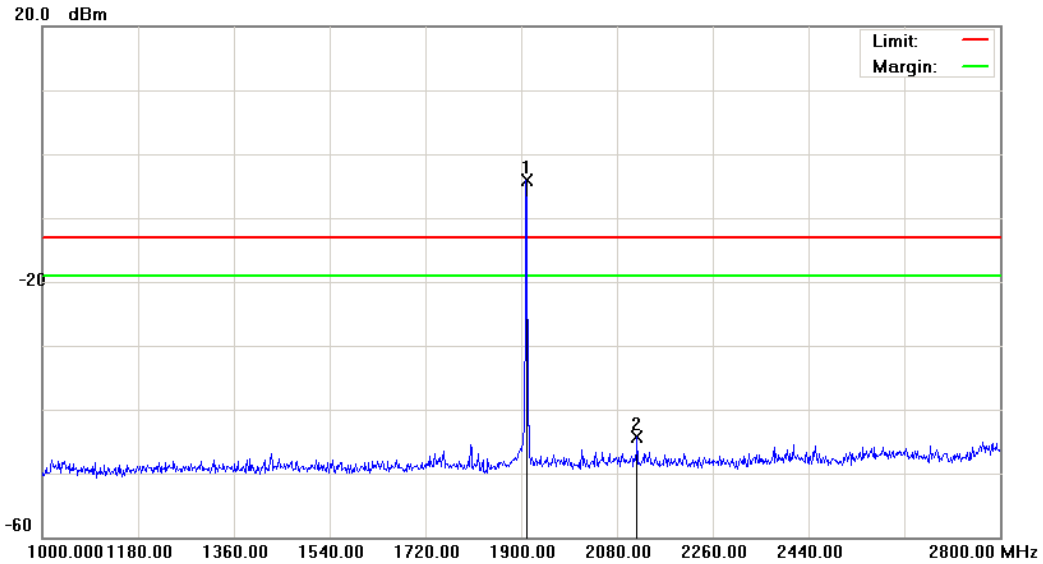

Site: : RF Conducted

 Polarization: *Conducted po*

Temperature: 23 °C

Limit: FCC Part 24 conducted(9k-12.75G)

Power: DC 3.8V

Humidity: 55.2 %

EUT: 2G Module

Distance:

RBW: 1000 kHz VBW: 1000kHz

M/N: GE910-QUAD

Mode: 2

Note:

No.	Mk.	Freq. MHz	Reading Level dBm	Correct Factor dB	Measure- ment dBm	Limit dBm	Over dB	Detector	Antenna Height cm	Table Degree degree	Comment
1	*	1909.900	-9.80	5.71	-4.09	-13.00	8.91	peak			Tx
2		2117.800	-49.04	4.73	-44.31	-13.00	-31.31	peak			

*:Maximum data x:Over limit !:over margin

File: GE910-QUAD(CH810)

Data :#4

Date: 2012/5/21

Time: 下午 04:46:17

20.0 dBm

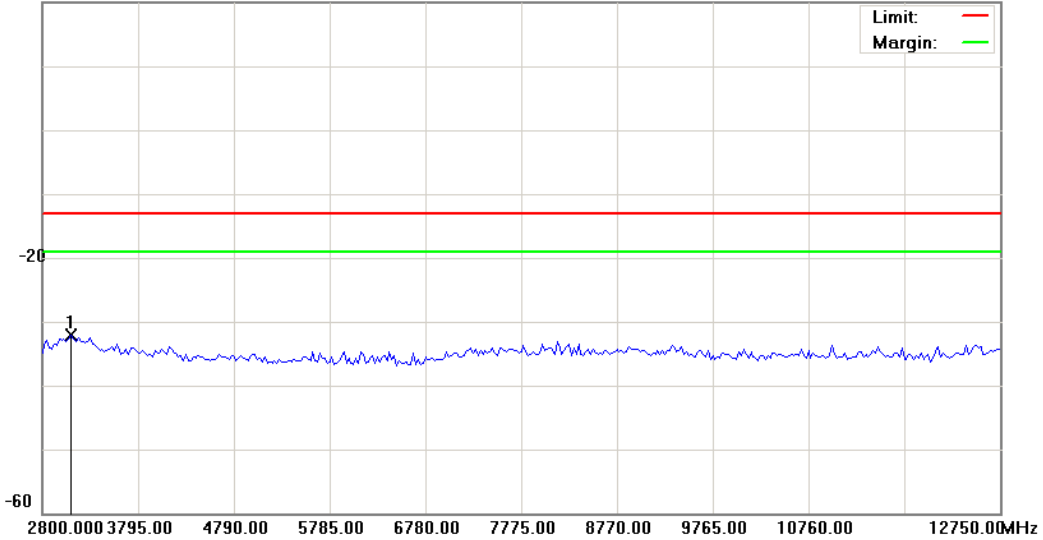

Site: : RF Conducted	Polarization: Conducted po	Temperature: 23 °C
Limit: FCC Part 24 conducted(9k-12.75G)	Power: DC 3.8V	Humidity: 55.2 %
EUT: 2G Module	Distance:	RBW: 1000 kHz VBW: 1000kHz
M/N: GE910-QUAD		
Mode: 2		
Note:		

No.	Mk.	Freq. MHz	Reading Level dBm	Correct Factor dB	Measure- ment dBm	Limit dBm	Over dB	Detector	Antenna Height cm	Table Degree degree	Comment
1	*	3098.500	-37.35	5.32	-32.03	-13.00	-19.03	peak			

*:Maximum data x:Over limit !:over margin

File: GE910-QUAD(CH810)

Data :#5

Date: 2012/5/21

Time: 下午 04:46:39

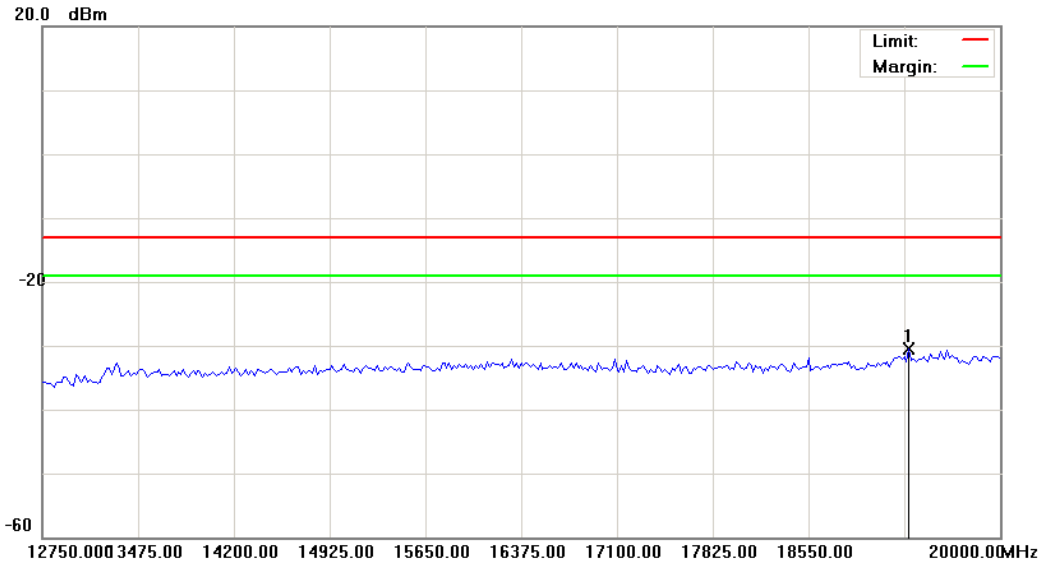

Site: : RF Conducted	Polarization: Conducted po	Temperature: 23 °C
Limit: FCC Part 24 conducted(9k-12.75G)	Power: DC 3.8V	Humidity: 55.2 %
EUT: 2G Module	Distance:	RBW: 1000 kHz VBW: 1000kHz
M/N: GE910-QUAD		
Mode: 2		
Note:		

No.	Mk.	Freq.	Reading Level	Correct Factor	Measurement	Limit	Over	Antenna Height	Table Degree	
		MHz	dBm	dB	dBm	dBm	dB	cm	degree	Comment
1	*	19311.250	-37.78	7.24	-30.54	-13.00	-17.54			peak

*:Maximum data x:Over limit !:over margin

6 Field Strength of Spurious Radiation Test

6.1. Limit

The power of any emission outside of the authorized operating frequency ranges must be attenuated below the transmitting power (P) by a factor of at least $43 + 10\log(P)$ dB.

It is measured by means of a calibrated spectrum analyzer and scanned from 30 MHz up to a frequency including its 10th harmonic.

6.2. Test Instruments

3 Meter Chamber					
Equipment	Manufacturer	Model Number	Serial Number	Cal. Date	Remark
RF Pre-selector	Agilent	N9039A	MY46520256	01/16/2012	(1)
Spectrum Analyzer	Agilent	E4446A	MY46180578	01/16/2012	(1)
Pre Amplifier	Agilent	8449B	3008A02237	02/22/2012	(1)
Pre Amplifier	Agilent	8447D	2944A10961	02/22/2012	(1)
Broadband Antenna (30MHz~1GHz)	SCHWARZBECK MESS-ELEKTRONIK	VULB9163	9163-270	07/29/2011	(1)
Horn Antenna (1~18GHz)	SCHWARZBECK MESS-ELEKTRONIK	BBHA9120D	9120D-550	06/29/2011	(1)
Horn Antenna (18~40GHz)	SCHWARZBECK MESS-ELEKTRONIK	BBHA9170	9170-320	06/28/2011	(1)
Test Site	ATL	TE01	888001	12/20/2011	(1)

Remark: ⁽¹⁾ Calibration period 1 year. ⁽²⁾ Calibration period 2 years.

NOTE: N.C.R. = No Calibration Request.

6.3. Setup

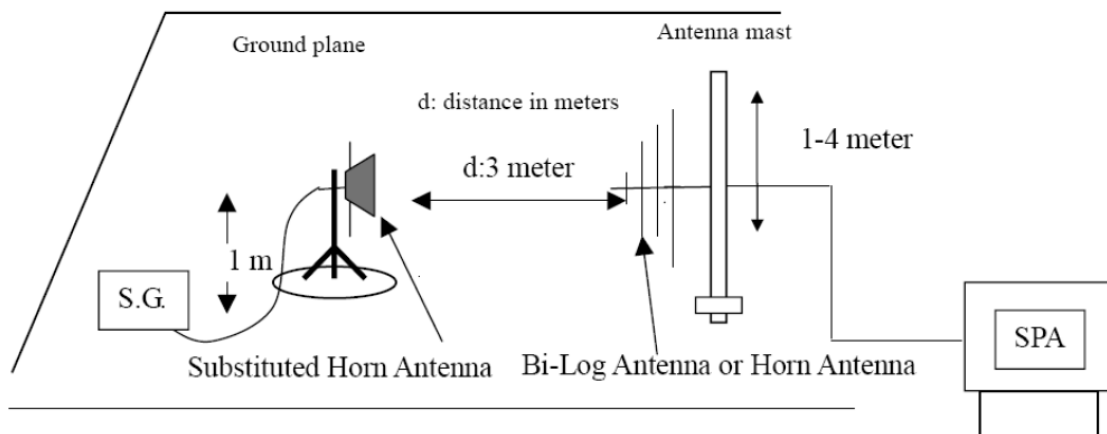

6.4. Test Procedure

The measurement is made according to ANSI/TIA-603-C-2004 as follows:

The equipment under test is placed inside the semi-anechoic chamber on a wooden table at the turntable center. For each spurious frequency, the antenna mast is raised and lowered from 1 to 4 meters and the turntable is rotated 360 degrees to obtain a maximum reading on the spectrum analyzer. This is repeated for both horizontal and vertical polarizations of the receive antenna.

The equipment under test is then replaced with a substitution antenna fed by a signal generator. With the signal generator tuned to a particular spurious frequency, the antenna mast is raised and lowered from 1 to 4 meters to obtain a maximum reading at the spectrum analyzer. The output of the signal generator is then adjusted until a reading identical to that obtained with the actual transmitter is achieved.

The power in dBm of each spurious emission is calculated by correcting the signal generator level for cable loss and gain of the substitution antenna referenced to a dipole. A fully charged battery was used for the supply voltage.

The settings of the receiver were as follows:

Units	dBm
Resolution Bandwidth	1 MHz
Video Bandwidth	Auto
Sweep Time	Auto

The field strength of spurious emission was measured in the following position: EUT stand-up position (Z axis), lie-down position (X, Y axis). The worst emission was found in **lie-down position (X axis)** and the worst case was recorded.

6.5. Uncertainty

The measurement uncertainty is defined as for Field Strength of Spurious Radiation measurement is ± 3.072 dB.

6.6. Test Result

Standard:	FCC Part 22	Test Distance:	3m
Test item:	Radiated Emission	Power:	AC 120V/60Hz
Model:	GE910-QUAD	Temp.(°C)/Hum.(%RH):	26(°C)/60%RH
Mode:	Mode 1	Date:	05/30/2012
Frequency:	824.2 MHz	Test By:	Fly Lu

No.	Frequency (MHz)	Reading (dBm)	Correct Factor(dB)	Result (dBm)	Limit (dBm)	Margin (dB)	Remark	Ant.Polar. H / V
1	200.0000	-61.64	2.95	-58.69	-13.00	-45.69	peak	H
2	300.0000	-62.04	-2.36	-64.40	-13.00	-51.40	peak	H
3	399.5000	-64.66	2.50	-62.16	-13.00	-49.16	peak	H
4	501.0000	-67.75	7.00	-60.75	-13.00	-47.75	peak	H
5	609.5000	-70.31	7.82	-62.49	-13.00	-49.49	peak	H
6	772.0000	-71.48	9.74	-61.74	-13.00	-48.74	peak	H
7	3706.000	-69.86	19.96	-49.90	-13.00	-36.90	peak	H
8	5411.000	-71.81	23.48	-48.33	-13.00	-35.33	peak	H
9	7226.000	-71.71	25.96	-45.75	-13.00	-32.75	peak	H
1	200.0000	-59.15	10.15	-49.00	-13.00	-36.00	peak	V
2	300.0000	-62.88	2.71	-60.17	-13.00	-47.17	peak	V
3	399.0000	-56.67	1.35	-55.32	-13.00	-42.32	peak	V
4	530.0000	-63.06	3.68	-59.38	-13.00	-46.38	peak	V
5	644.5000	-68.47	8.79	-59.68	-13.00	-46.68	peak	V
6	731.5000	-68.11	10.65	-57.46	-13.00	-44.46	peak	V
7	3893.000	-68.77	20.36	-48.41	-13.00	-35.41	peak	V
8	5455.000	-70.92	23.48	-47.44	-13.00	-34.44	peak	V
9	6951.000	-71.49	25.44	-46.05	-13.00	-33.05	peak	V

Standard:	FCC Part 22	Test Distance:	3m
Test item:	Radiated Emission	Power:	AC 120V/60Hz
Model:	GE910-QUAD	Temp.(°C)/Hum.(%RH):	26(°C)/60%RH
Mode:	Mode 1	Date:	05/30/2012
Frequency:	836.6 MHz	Test By:	Fly Lu

No.	Frequency (MHz)	Reading (dBm)	Correct Factor(dB)	Result (dBm)	Limit (dBm)	Margin (dB)	Remark	Ant.Polar. H / V
1	200.0000	-61.96	2.95	-59.01	-13.00	-46.01	peak	H
2	300.0000	-61.80	-2.36	-64.16	-13.00	-51.16	peak	H
3	399.5000	-65.57	2.50	-63.07	-13.00	-50.07	peak	H
4	530.0000	-68.64	7.95	-60.69	-13.00	-47.69	peak	H
5	631.5000	-70.55	7.20	-63.35	-13.00	-50.35	peak	H
6	732.5000	-69.85	7.92	-61.93	-13.00	-48.93	peak	H
7	3761.000	-69.11	15.99	-53.12	-13.00	-40.12	peak	H
8	5972.000	-72.19	22.97	-49.22	-13.00	-36.22	peak	H
9	7644.000	-72.00	29.32	-42.68	-13.00	-29.68	peak	H
1	200.0000	-58.41	10.15	-48.26	-13.00	-35.26	peak	V
2	300.0000	-63.95	2.71	-61.24	-13.00	-48.24	peak	V
3	398.5000	-55.48	1.34	-54.14	-13.00	-41.14	peak	V
4	530.0000	-62.60	3.68	-58.92	-13.00	-45.92	peak	V
5	644.5000	-68.91	8.79	-60.12	-13.00	-47.12	peak	V
6	764.0000	-63.30	11.03	-52.27	-13.00	-39.27	peak	V
7	3585.000	-68.56	19.69	-48.87	-13.00	-35.87	peak	V
8	5488.000	-70.60	23.48	-47.12	-13.00	-34.12	peak	V
9	7369.000	-71.50	26.24	-45.26	-13.00	-32.26	peak	V

Standard:	FCC Part 22	Test Distance:	3m
Test item:	Radiated Emission	Power:	AC 120V/60Hz
Model:	GE910-QUAD	Temp.(°C)/Hum.(%RH):	26(°C)/60%RH
Mode:	Mode 1	Date:	05/30/2012
Frequency:	848.8 MHz	Test By:	Fly Lu

No.	Frequency (MHz)	Reading (dBm)	Correct Factor(dB)	Result (dBm)	Limit (dBm)	Margin (dB)	Remark	Ant.Polar. H / V
1	200.0000	-62.43	2.95	-59.48	-13.00	-46.48	peak	H
2	300.0000	-61.23	-2.36	-63.59	-13.00	-50.59	peak	H
3	399.5000	-64.61	2.50	-62.11	-13.00	-49.11	peak	H
4	501.0000	-67.57	7.00	-60.57	-13.00	-47.57	peak	H
5	587.0000	-69.54	7.72	-61.82	-13.00	-48.82	peak	H
6	732.5000	-67.18	7.92	-59.26	-13.00	-46.26	peak	H
7	3728.000	-68.67	15.92	-52.75	-13.00	-39.75	peak	H
8	5895.000	-70.79	22.77	-48.02	-13.00	-35.02	peak	H
9	7633.000	-70.89	29.31	-41.58	-13.00	-28.58	peak	H
1	200.0000	-58.67	10.15	-48.52	-13.00	-35.52	peak	V
2	300.0000	-63.46	2.71	-60.75	-13.00	-47.75	peak	V
3	399.5000	-57.06	1.33	-55.73	-13.00	-42.73	peak	V
4	530.0000	-62.67	3.68	-58.99	-13.00	-45.99	peak	V
5	644.5000	-70.25	8.79	-61.46	-13.00	-48.46	peak	V
6	732.5000	-68.11	10.62	-57.49	-13.00	-44.49	peak	V
7	3838.000	-70.13	20.24	-49.89	-13.00	-36.89	peak	V
8	6159.000	-72.30	23.44	-48.86	-13.00	-35.86	peak	V
9	7985.000	-71.55	26.35	-45.20	-13.00	-32.20	peak	V

Standard:	FCC Part 24	Test Distance:	3m
Test item:	Radiated Emission	Power:	AC 120V/60Hz
Model:	GE910-QUAD	Temp.(°C)/Hum.(%RH):	26(°C)/60%RH
Mode:	Mode 2	Date:	05/30/2012
Frequency:	1850.2 MHz	Test By:	Fly Lu

No.	Frequency (MHz)	Reading (dBm)	Correct Factor(dB)	Result (dBm)	Limit (dBm)	Margin (dB)	Remark	Ant.Polar. H / V
1	200.0000	-62.45	2.95	-59.50	-13.00	-46.50	peak	H
2	300.0000	-62.03	-2.36	-64.39	-13.00	-51.39	peak	H
3	399.0000	-64.62	2.46	-62.16	-13.00	-49.16	peak	H
4	501.0000	-67.93	7.00	-60.93	-13.00	-47.93	peak	H
5	644.5000	-72.23	6.90	-65.33	-13.00	-52.33	peak	H
6	799.5000	-74.04	11.22	-62.82	-13.00	-49.82	peak	H
7	4069.000	-69.84	16.54	-53.30	-13.00	-40.30	peak	H
8	6071.000	-72.54	23.49	-49.05	-13.00	-36.05	peak	H
9	7556.000	-72.24	29.25	-42.99	-13.00	-29.99	peak	H
1	200.0000	-59.39	10.15	-49.24	-13.00	-36.24	peak	V
2	300.0000	-64.51	2.71	-61.80	-13.00	-48.80	peak	V
3	399.5000	-56.11	1.33	-54.78	-13.00	-41.78	peak	V
4	530.0000	-63.06	3.68	-59.38	-13.00	-46.38	peak	V
5	644.5000	-69.30	8.79	-60.51	-13.00	-47.51	peak	V
6	796.5000	-71.29	11.77	-59.52	-13.00	-46.52	peak	V
7	4014.000	-69.29	20.64	-48.65	-13.00	-35.65	peak	V
8	5983.000	-71.54	22.78	-48.76	-13.00	-35.76	peak	V
9	7545.000	-71.78	26.48	-45.30	-13.00	-32.30	peak	V

Standard:	FCC Part 24	Test Distance:	3m
Test item:	Radiated Emission	Power:	AC 120V/60Hz
Model:	GE910-QUAD	Temp.(°C)/Hum.(%RH):	26(°C)/60%RH
Mode:	Mode 2	Date:	05/30/2012
Frequency:	1880.0 MHz	Test By:	Fly Lu

No.	Frequency (MHz)	Reading (dBm)	Correct Factor(dB)	Result (dBm)	Limit (dBm)	Margin (dB)	Remark	Ant.Polar. H / V
1	215.0000	-59.64	0.06	-59.58	-13.00	-46.58	peak	H
2	300.0000	-62.03	-2.36	-64.39	-13.00	-51.39	peak	H
3	399.5000	-64.95	2.50	-62.45	-13.00	-49.45	peak	H
4	530.0000	-68.70	7.95	-60.75	-13.00	-47.75	peak	H
5	644.5000	-72.27	6.90	-65.37	-13.00	-52.37	peak	H
6	796.5000	-72.04	11.06	-60.98	-13.00	-47.98	peak	H
7	4113.000	-69.94	16.60	-53.34	-13.00	-40.34	peak	H
8	5972.000	-72.02	22.97	-49.05	-13.00	-36.05	peak	H
9	7358.000	-72.34	28.74	-43.60	-13.00	-30.60	peak	H
1	199.0000	-58.63	9.20	-49.43	-13.00	-36.43	peak	V
2	300.0000	-64.07	2.71	-61.36	-13.00	-48.36	peak	V
3	398.5000	-57.23	1.34	-55.89	-13.00	-42.89	peak	V
4	530.0000	-62.95	3.68	-59.27	-13.00	-46.27	peak	V
5	644.5000	-69.29	8.79	-60.50	-13.00	-47.50	peak	V
6	796.5000	-71.40	11.77	-59.63	-13.00	-46.63	peak	V
7	3992.000	-68.91	20.58	-48.33	-13.00	-35.33	peak	V
8	6038.000	-70.35	22.92	-47.43	-13.00	-34.43	peak	V
9	7578.000	-71.46	26.47	-44.99	-13.00	-31.99	peak	V

Standard:	FCC Part 24	Test Distance:	3m
Test item:	Radiated Emission	Power:	AC 120V/60Hz
Model:	GE910-QUAD	Temp.(°C)/Hum.(%RH):	26(°C)/60%RH
Mode:	Mode 2	Date:	05/30/2012
Frequency:	1909.8 MHz	Test By:	Fly Lu

No.	Frequency (MHz)	Reading (dBm)	Correct Factor(dB)	Result (dBm)	Limit (dBm)	Margin (dB)	Remark	Ant.Polar. H / V
1	215.0000	-60.72	0.06	-60.66	-13.00	-47.66	peak	H
2	300.0000	-61.31	-2.36	-63.67	-13.00	-50.67	peak	H
3	399.5000	-65.05	2.50	-62.55	-13.00	-49.55	peak	H
4	530.0000	-68.68	7.95	-60.73	-13.00	-47.73	peak	H
5	644.5000	-71.94	6.90	-65.04	-13.00	-52.04	peak	H
6	797.0000	-71.22	11.07	-60.15	-13.00	-47.15	peak	H
7	4146.000	-69.67	16.62	-53.05	-13.00	-40.05	peak	H
8	6335.000	-73.00	25.12	-47.88	-13.00	-34.88	peak	H
9	7754.000	-72.18	29.41	-42.77	-13.00	-29.77	peak	H
1	200.0000	-58.94	10.15	-48.79	-13.00	-35.79	peak	V
2	300.0000	-64.27	2.71	-61.56	-13.00	-48.56	peak	V
3	399.0000	-55.30	1.35	-53.95	-13.00	-40.95	peak	V
4	530.0000	-63.07	3.68	-59.39	-13.00	-46.39	peak	V
5	644.5000	-70.23	8.79	-61.44	-13.00	-48.44	peak	V
6	797.0000	-71.49	11.77	-59.72	-13.00	-46.72	peak	V
7	3002.000	-67.78	16.43	-51.35	-13.00	-38.35	peak	V
8	5708.000	-71.07	23.18	-47.89	-13.00	-34.89	peak	V
9	7765.000	-71.03	26.43	-44.60	-13.00	-31.60	peak	V

Standard:	RSS-Gen	Test Distance:	3m
Test item:	Radiated Emission	Power:	AC 120V/60Hz
Model:	GE910-QUAD	Temp.(°C)/Hum.(%RH):	26(°C)/60%RH
Mode:	Mode 3	Date:	05/29/2012
		Test By:	Fly Lu

No.	Frequency (MHz)	Reading (dBm)	Correct Factor(dB)	Result (dBm)	Limit (dBm)	Margin (dB)	Remark	Ant.Polar. H / V
1	3448.000	38.42	3.20	41.62	74.00	-32.38	peak	H
2	5054.500	36.31	8.66	44.97	74.00	-29.03	peak	H
3	6559.000	35.85	13.28	49.13	74.00	-24.87	peak	H
1	3473.500	38.13	3.25	41.38	74.00	-32.62	peak	V
2	5564.500	36.38	10.10	46.48	74.00	-27.52	peak	V
3	7375.000	35.06	15.85	50.91	74.00	-23.09	peak	V

7 Frequency Stability (Temperature Variation) Test

7.1. Limit

The frequency stability shall be measured by variation of ambient temperature and variation of primary supply voltage to ensure that the fundamental emission stays within the authorized frequency block. The frequency stability of the transmitter shall be maintained within $\pm 0.00025\%$ ($\pm 2.5\text{ppm}$) of the center frequency.

7.2. Test Instruments

Describe	Manufacturer	Model No.	Serial No.	Cal. Date	Remark
Universal Radio Communication Tester	ROHDE & SCHWARZ	CMU200	109369	08/10/2010	(2)
Temperature & Humidity Chamber	TAICHY	MHU-225LA	980729	08/24/2011	(1)
Test Site	ATL	TE05	TE05	N.C.R.	-----

Remark: ⁽¹⁾ Calibration period 1 year. ⁽²⁾ Calibration period 2 years.

NOTE: N.C.R. = No Calibration Request.

7.3. Setup

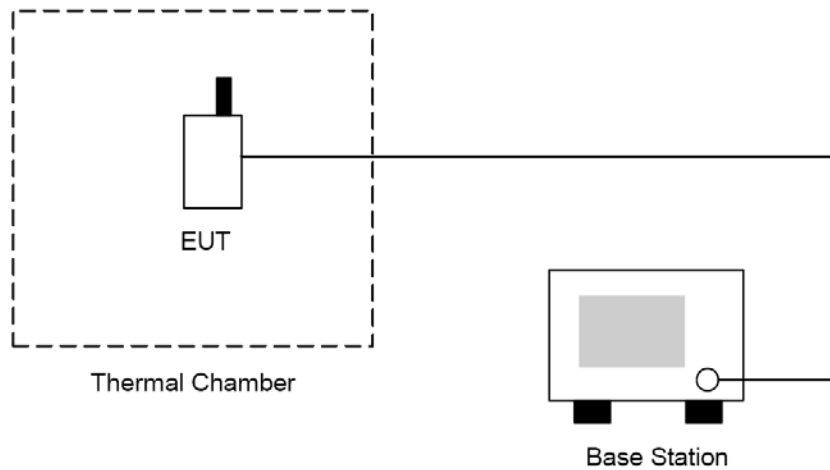

7.4. Test Procedure

The measurement is made according to FCC rules part 22 and 24:

1. The EUT and test equipment were set up as shown on the following section.
2. With all power removed, the temperature was decreased to -30°C and permitted to stabilize for three hours. Power was applied and the maximum change in frequency was note within one minute.
3. With power OFF, the temperature was raised in 10°C steps. The sample was permitted to stabilize at each step for at least one-half hour. Power was applied and the maximum frequency change was noted within one minute.
4. The temperature tests were performed for the worst case.
5. Test data was recorded.

7.5. Uncertainty

The measurement uncertainty is defined as for Frequency Stability (Temperature Variation) measurement is $\pm 10\text{Hz}$.

7.6. Test Result

Model Number	GE910-QUAD			
Test Item	Frequency Stability (Temperature Variation)			
Test Mode	Mode 1: GSM 850 Link			
Date of Test	05/23/2012		Test Site	TE05
Temperature (°C)	Deviation (Hz)	Deviation (ppm)	Limit (ppm)	Result
-30	-29	-0.035	±2.5	Pass
-20	-22	-0.026	±2.5	Pass
-10	-24	-0.029	±2.5	Pass
0	-31	-0.037	±2.5	Pass
10	-27	-0.032	±2.5	Pass
20	-32	-0.038	±2.5	Pass
30	-23	-0.027	±2.5	Pass
40	-26	-0.031	±2.5	Pass
50	-27	-0.032	±2.5	Pass

Model Number	GE910-QUAD			
Test Item	Frequency Stability (Temperature Variation)			
Test Mode	Mode 2: GSM 1900 Link			
Date of Test	05/23/2012		Test Site	TE05
Temperature (°C)	Deviation (Hz)	Deviation (ppm)	Limit (ppm)	Result
-30	-32	-0.017	±2.5	Pass
-20	-37	-0.020	±2.5	Pass
-10	-29	-0.015	±2.5	Pass
0	-45	-0.024	±2.5	Pass
10	-48	-0.026	±2.5	Pass
20	-46	-0.024	±2.5	Pass
30	-21	-0.011	±2.5	Pass
40	-26	-0.014	±2.5	Pass
50	-31	-0.016	±2.5	Pass

8 Frequency Stability (Voltage Variation) Test

8.1. Limit

The frequency stability shall be measured by variation of ambient temperature and variation of primary supply voltage to ensure that the fundamental emission stays within the authorized frequency block. The frequency stability of the transmitter shall be maintained within $\pm 0.00025\%$ ($\pm 2.5\text{ppm}$) of the center frequency.

8.2. Test Instruments

Describe	Manufacturer	Model No.	Serial No.	Cal. Date	Remark
Universal Radio Communication Tester	ROHDE & SCHWARZ	CMU200	109369	08/10/2010	(2)
Temperature & Humidity Chamber	TAICHY	MHU-225LA	980729	08/24/2011	(1)
Test Site	ATL	TE05	TE05	N.C.R.	-----

Remark: ⁽¹⁾ Calibration period 1 year. ⁽²⁾ Calibration period 2 years.

NOTE: N.C.R. = No Calibration Request.

8.3. Setup

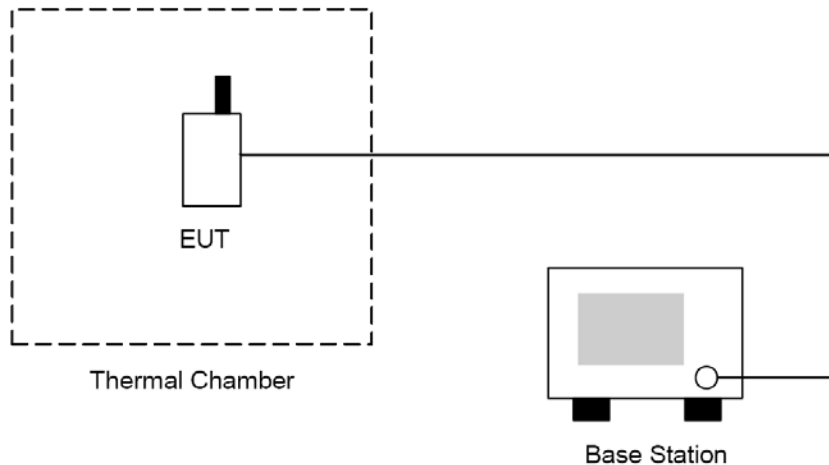

8.4. Test Procedure

1. The EUT was placed in a temperature chamber at $25 \pm 5^\circ\text{C}$ and connected as the following section.
2. The power supply voltage to the EUT was varied from BEP to 115% of the nominal value measured at the input to the EUT.
3. The variation in frequency was measured for the worst case.

8.5. Uncertainty

The measurement uncertainty is defined as for Frequency Stability (Voltage Variation) measurement is $\pm 10\text{Hz}$.

8.6. Test Result

Model Number	GE910-QUAD				
Test Item	Frequency Stability (Voltage Variation)				
Test Mode	Mode 1: GSM 850 Link				
Date of Test	05/23/2012		Test Site	TE05	
Level	Voltage [V]	Deviation [Hz]	Deviation [ppm]	Limit [ppm]	Result
Battery full point	4.20	-32	-0.038	± 2.5	Pass
Normal	3.80	-34	-0.041	± 2.5	Pass
Battery cut-off point	3.40	-29	-0.035	± 2.5	Pass

Model Number	GE910-QUAD				
Test Item	Frequency Stability (Voltage Variation)				
Test Mode	Mode 2: GSM 1900 Link				
Date of Test	05/23/2012		Test Site	TE05	
Level	Voltage [V]	Deviation [Hz]	Deviation [ppm]	Limit [ppm]	Result
Battery full point	4.20	-39	-0.021	± 2.5	Pass
Normal	3.80	-41	-0.022	± 2.5	Pass
Battery cut-off point	3.40	-34	-0.018	± 2.5	Pass