



# FCC RADIO TEST REPORT

FCC ID : RI7FN990A40  
Equipment : 5G NR Module  
Brand Name :   
Model Name : FN990A40  
Marketing Name : FN990A40  
Applicant : Telit Communications S.p.A.  
Viale Stazione di Prosecco 5/b, Trieste 34010, Italy  
Manufacturer : Telit Communications S.p.A.  
Viale Stazione di Prosecco 5/b, Trieste 34010, Italy  
Standard : FCC 47 CFR Part 2, Part 27(D)

The product was received on Jul. 07, 2022 and testing was performed from Jul. 29, 2022 to Nov. 24, 2022. We, Sporton International Inc. EMC & Wireless Communications Laboratory, would like to declare that the tested sample has been evaluated in accordance with the test procedures given in ANSI / TIA-603-E and has been in compliance with the applicable technical standards.

The test results in this report apply exclusively to the tested model / sample. Without written approval of Sporton International Inc. EMC & Wireless Communications Laboratory, the test report shall not be reproduced except in full.

*Louis Wu*

Approved by: Louis Wu

**Sporton International Inc. EMC & Wireless Communications Laboratory**

No. 52, Huaya 1st Rd., Guishan Dist., Taoyuan City 333, Taiwan (R.O.C.)



## Table of Contents

<b>Table of Contents</b> .....	<b>2</b>
<b>History of this test report</b> .....	<b>3</b>
<b>Summary of Test Result</b> .....	<b>4</b>
<b>1 General Description</b> .....	<b>5</b>
1.1 Product Feature of Equipment Under Test.....	5
1.2 Modification of EUT .....	5
1.3 Testing Site .....	5
1.4 Applied Standards .....	6
<b>2 Test Configuration of Equipment Under Test</b> .....	<b>7</b>
2.1 Test Mode.....	7
2.2 Connection Diagram of Test System.....	8
2.3 Support Unit used in test configuration and system .....	8
2.4 Measurement Results Explanation Example.....	8
2.5 Frequency List of Low/Middle/High Channels .....	9
<b>3 Conducted Test Items</b> .....	<b>10</b>
3.1 Measuring Instruments .....	10
3.2 Conducted Output Power Measurement .....	11
3.3 Peak-to-Average Ratio .....	12
3.4 Effective Isotropic Radiated Power.....	13
3.5 Occupied Bandwidth.....	14
3.6 Conducted Band Edge .....	15
3.7 Conducted Spurious Emission .....	16
3.8 Frequency Stability .....	17
<b>4 Radiated Test Items</b> .....	<b>18</b>
4.1 Measuring Instruments .....	18
4.2 Radiated Spurious Emission Measurement .....	20
<b>5 List of Measuring Equipment</b> .....	<b>21</b>
<b>6 Uncertainty of Evaluation</b> .....	<b>23</b>
<b>Appendix A. Test Results of Conducted Test</b>	
<b>Appendix B. Test Results of Radiated Test</b>	
<b>Appendix C. Setup Photographs</b>	



### History of this test report

Report No.	Version	Description	Issued Date
FG270608F	01	Initial issue of report	Dec. 07, 2022



### Summary of Test Result

Report Clause	Ref Std. Clause	Test Items	Result (PASS/FAIL)	Remark
3.2	§2.1046	Conducted Output Power	Reporting only	-
3.3	-	Peak-to-Average Ratio	Reporting only	-
3.4	§27.50 (a)(3)	Effective Isotropic Radiated Power	Pass	-
3.5	§2.1049	Occupied Bandwidth	Reporting only	-
3.6	§2.1051 §27.53 (a)(4)	Conducted Band Edge Measurement	Pass	-
3.7	§2.1051 §27.53 (a)(4)	Conducted Spurious Emission	Pass	-
3.8	§2.1055 §27.54	Frequency Stability Temperature & Voltage	Pass	-
4.2	§2.1053 §27.53 (a)(4)	Radiated Spurious Emission	Pass	10.71 dB under the limit at 9216.000 MHz

**Declaration of Conformity:**

- The test results (PASS/FAIL) with all measurement uncertainty excluded are presented in accordance with the regulation limits or requirements declared by manufacturers. It's means measurement values may risk exceeding the limit of regulation standards, if measurement uncertainty is include in test results.
- The measurement uncertainty please refer to this report "Uncertainty of Evaluation".

**Comments and Explanations:**

The product specifications of the EUT presented in the report are declared by the manufacturer who shall take full responsibility for the authenticity.

**Reviewed by: Avis Chuang**

**Report Producer: Clio Lo**



# 1 General Description

## 1.1 Product Feature of Equipment Under Test

WCDMA/LTE/5G NR, and GNSS

Product Feature	
Antenna Type	WWAN: Monopole Antenna GPS/Glonass/BDS/Galileo/SBAS: Monopole Antenna
Test Antenna Gain	5G NR n30: 1.0 dBi

**Remark:** The EUT's information above is declared by manufacturer. Please refer to Comments and Explanations in report summary.

## 1.2 Modification of EUT

No modifications are made to the EUT during all test items.

## 1.3 Testing Site

Test Site	Sporton International Inc. EMC & Wireless Communications Laboratory	
Test Site Location	No.52, Huaya 1st Rd., Guishan Dist., Taoyuan City 333, Taiwan (R.O.C.) TEL: +886-3-327-3456 FAX: +886-3-328-4978	
Test Site No.	Sporton Site No.	
	TH03-HY	03CH07-HY
Test Engineer	Luffy Lin	Stan Hsieh and Howard Huang
Temperature (°C)	23.5~24.1	22.6~26.8
Relative Humidity (%)	48~52	56.6~64.5

**Note:** The test site complies with ANSI C63.4 2014 requirement.

FCC Designation No.: TW1190



## **1.4 Applied Standards**

According to the specifications of the manufacturer, the EUT must comply with the requirements of the following standards:

- ♦ ANSI C63.26-2015
- ♦ FCC 47 CFR Part 2, Part 27(D)
- ♦ ANSI / TIA-603-E
- ♦ FCC KDB 971168 Power Meas License Digital Systems D01 v03r01
- ♦ FCC KDB 412172 D01 Determining ERP and EIRP v01r01
- ♦ FCC KDB 414788 D01 Radiated Test Site v01r01

**Remark:**

1. All test items were verified and recorded according to the standards and without any deviation during the test.
2. This EUT has also been tested and complied with the requirements of FCC Part 15, Subpart B, recorded in a separate test report.
3. The TAF code is not including all the FCC KDB listed without accreditation.



## 2 Test Configuration of Equipment Under Test

### 2.1 Test Mode

Antenna port conducted and radiated test items listed below are performed according to KDB 971168 D01 Power Meas. License Digital Systems v03r01 with maximum output power.

For radiated measurement, the measured emission level of the EUT was maximized by rotating the EUT on a turntable, adjusting the orientation of the EUT and EUT antenna in two config (Ant. Horizontal and Ant. Vertical), and adjusting the measurement antenna orientation, following C63.26 exploratory test procedures and only the worst case emissions were reported in this report.

Test Items	Band	Bandwidth (MHz)						Modulation					RB #			Test Channel		
		1.4	3	5	10	15	20	PI/2 BPSK	QPSK	16QAM	64QAM	256QAM	1	Half	Full	L	M	H
Max. Output Power	n30	-	-	-	v	-	-	v	v	v	v	v	v	v	v			v
Peak-to-Average Ratio	n30	-	-	-	v	-	-	v	v	v	v	v			v			v
E.I.R.P	n30	-	-	-	v	-	-	v	v	v	v	v	Max. Power					
26dB and 99% Bandwidth	n30	-	-	-	v	-	-	v	v	v	v	v			v			v
Conducted Band Edge	n30	-	-	-	v	-	-	v	v	v	v	v			v			v
Conducted Spurious Emission	n30	-	-	-	v	-	-		v				v					v
Frequency Stability	n30	-	-	-	v	-	-	v							v			v
Radiated Spurious Emission	n30	Worst Case																v
Remark	<ol style="list-style-type: none"> <li>The mark "v" means that this configuration is chosen for testing</li> <li>The mark "-" means that this bandwidth is not supported.</li> <li>The device is investigated from 30MHz to 10 times of fundamental signal for radiated spurious emission test under different RB size/offset and modulations in exploratory test. Subsequently, only the worst case emissions are reported.</li> <li>For radiated measurement, pre-scanned in two modes, DFT-s OFDM and CP OFDM. The worst cases (DFT-s OFDM) were recorded in this report, the worst modes of FR1 and LTE for simultaneous transmission were verified and compliant.</li> <li>Test combination are EN-DC 5A-n30A, EN-DC 12A-n30A, EN-DC 14A-n30A.</li> <li>One representative bandwidth is selected to perform PAR and frequency stability.</li> </ol>																	

## 2.2 Connection Diagram of Test System

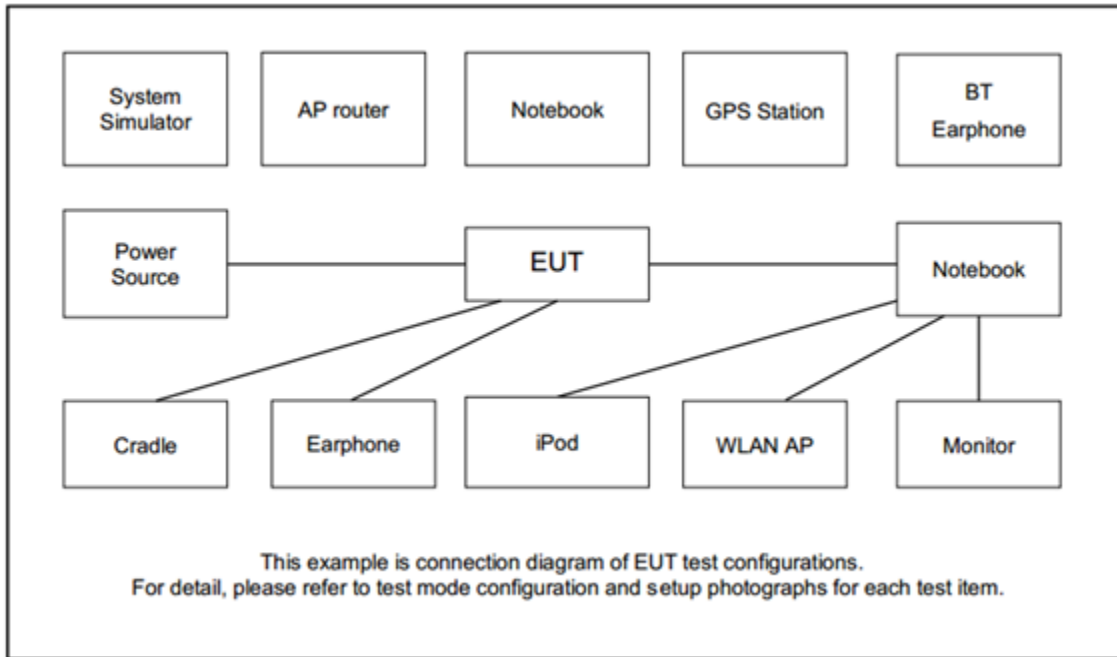

## 2.3 Support Unit used in test configuration and system

Item	Equipment	Brand Name	Model No.	FCC ID	Data Cable	Power Cord
1.	5G Wireless Test Platform	Anritsu	MT8000A	N/A	N/A	Unshielded, 1.8 m
2.	System Simulator	Anritsu	MT8821C	N/A	N/A	Unshielded, 1.8 m

## 2.4 Measurement Results Explanation Example

### For all conducted test items:

The offset level is set in the spectrum analyzer to compensate the RF cable loss and attenuator factor between EUT conducted output port and spectrum analyzer. With the offset compensation, the spectrum analyzer reading level is exactly the EUT RF output level.

The spectrum analyzer offset is derived from RF cable loss and attenuator factor.

*Offset = RF cable loss + attenuator factor.*

Following shows an offset computation example with cable loss 4.2 dB and 10dB attenuator.

Example :

$$\begin{aligned} \text{Offset(dB)} &= \text{RF cable loss(dB)} + \text{attenuator factor(dB)} \\ &= 4.2 + 10 = 14.2 \text{ (dB)} \end{aligned}$$





## 2.5 Frequency List of Low/Middle/High Channels

5G NR n30 Channel and Frequency List				
BW [MHz]	Channel/Frequency(MHz)	Lowest	Middle	Highest
10	Channel	-	27710	-
	Frequency	-	2310	-

### 3 Conducted Test Items

#### 3.1 Measuring Instruments

See list of measuring instruments of this test report.

##### 3.1.1 Test Setup

##### 3.1.2 Conducted Output Power

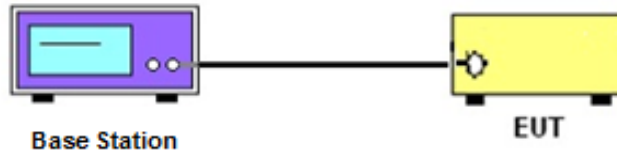

##### 3.1.3 Peak-to-Average Ratio, Occupied Bandwidth, 26dB Bandwidth ,Band-Edge and Conducted Spurious Emission

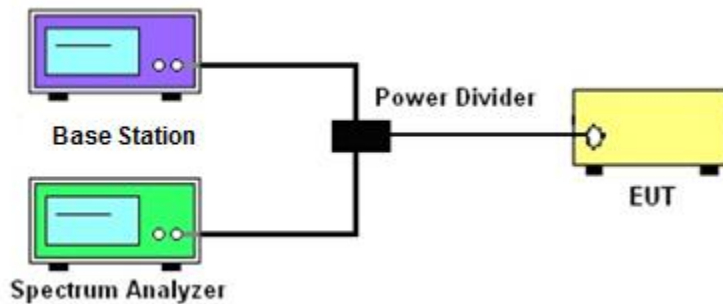

##### 3.1.4 Frequency Stability

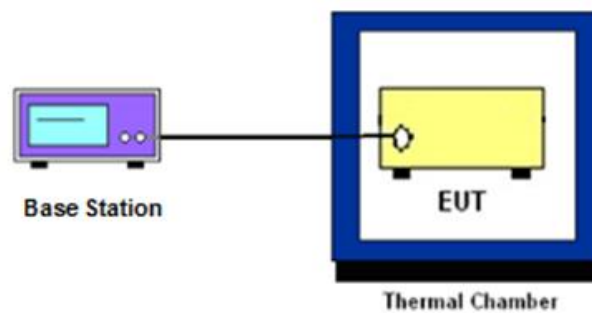

##### 3.1.5 Test Result of Conducted Test

Please refer to Appendix A.



## **3.2 Conducted Output Power Measurement**

### **3.2.1 Description of the Conducted Output Power Measurement**

A base station simulator was used to establish communication with the EUT. Its parameters were set to transmit the maximum power on the EUT. The measured power in the radio frequency on the transmitter output terminals shall be reported.

### **3.2.2 Test Procedures**

1. The transmitter output port was connected to the system simulator.
2. Set EUT at maximum power through the system simulator.
3. Select lowest, middle, and highest channels for each band and different modulation.
4. Measure and record the power level from the system simulator.



### **3.3 Peak-to-Average Ratio**

#### **3.3.1 Description of the PAR Measurement**

Power Complementary Cumulative Distribution Function (CCDF) curves provide a means for characterizing the power peaks of a digitally modulated signal on a statistical basis. A CCDF curve depicts the probability of the peak signal amplitude exceeding the average power level. Most contemporary measurement instrumentation include the capability to produce CCDF curves for an input signal provided that the instrument's resolution bandwidth can be set wide enough to accommodate the entire input signal bandwidth. In measuring transmissions in this band using an average power technique, the peak-to-average ratio (PAR) of the transmission may not exceed 13 dB.

#### **3.3.2 Test Procedures**

The testing follows ANSI C63.26-2015 Section 5.2.6

1. The EUT was connected to spectrum and system simulator via a power divider.
2. Set the CCDF (Complementary Cumulative Distribution Function) option in spectrum analyzer.
3. The highest RF powers were measured and recorded the maximum PAPR level associated with a probability of 0.1 %.
4. Record the deviation as Peak to Average Ratio.



## 3.4 Effective Isotropic Radiated Power

### 3.4.1 Description of EIRP Power

For mobile and portable stations transmitting in the 2305-2315 MHz band or the 2350-2360 MHz band, the average EIRP must not exceed 50 milliwatts within any 1 megahertz of authorized bandwidth, *except that* for mobile and portable stations compliant with 3GPP LTE standards or another advanced mobile broadband protocol that avoids concentrating energy at the edge of the operating band the average EIRP must not exceed 250 milliwatts within any 5 megahertz of authorized bandwidth but may exceed 50 milliwatts within any 1 megahertz of authorized bandwidth. For mobile and portable stations using time division duplexing (TDD) technology, the duty cycle must not exceed 38 percent in the 2305-2315 MHz and 2350-2360 MHz bands. Mobile and portable stations using FDD technology are restricted to transmitting in the 2305-2315 MHz band. Power averaging shall not include intervals in which the transmitter is off.

**Remark:** EIRP use worst case measure the total power to cover per 5MHz Power.

According to KDB 412172 D01 Power Approach,

$EIRP = P_T + G_T - L_C$ , where

$P_T$  = transmitter output power in dBm

$G_T$  = gain of the transmitting antenna in dBi

$L_C$  = signal attenuation in the connecting cable between the transmitter and antenna in dB

### 3.4.2 Test Procedures

The testing follows ANSI C63.26-2015 Section 5.2.4.5

1. Determine the EIRP by adding the effective antenna gain to the adjusted power level.



## **3.5 Occupied Bandwidth**

### **3.5.1 Description of Occupied Bandwidth Measurement**

The occupied bandwidth is the width of a frequency band such that, below the lower and above the upper frequency limits, the mean powers emitted are each equal to a specified percentage 0.5% of the total mean transmitted power.

The 26 dB emission bandwidth is defined as the frequency range between two points, one above and one below the carrier frequency, at which the spectral density of the emission is attenuated 26 dB below the maximum in-band spectral density of the modulated signal. Spectral density (power per unit bandwidth) is to be measured with a detector of resolution bandwidth equal to approximately 1.0% of the emission bandwidth.

### **3.5.2 Test Procedures**

The testing follows ANSI C63.26-2015 Section 5.4.3 (26dB) and Section 5.4.4 (99OB)

1. The EUT was connected to spectrum analyzer and system simulator via a power divider.
2. The spectrum analyzer center frequency is set to the nominal EUT channel center frequency. The span range for the spectrum analyzer shall be between two and five times the anticipated OBW.
3. The nominal resolution bandwidth (RBW) shall be in the range of 1 to 5 % of the anticipated OBW, and the VBW shall be at least 3 times the RBW.
4. Set the detection mode to peak, and the trace mode to max hold.
5. Determine the reference value: Set the EUT to transmit a modulated signal. Allow the trace to stabilize. Set the spectrum analyzer marker to the highest level of the displayed trace.  
(this is the reference value)
6. Determine the “-26 dB down amplitude” as equal to (Reference Value – X).
7. Place two markers, one at the lowest and the other at the highest frequency of the envelope of the spectral display such that each marker is at or slightly below the “-X dB down amplitude” determined in step 6. If a marker is below this “-X dB down amplitude” value it shall be placed as close as possible to this value. The OBW is the positive frequency difference between the two markers.
8. Use the 99 % power bandwidth function of the spectrum analyzer and report the measured bandwidth.



## 3.6 Conducted Band Edge

### 3.6.1 Description of Conducted Band Edge Measurement

27.53 (a)(4)

For mobile and portable stations operating in the 2305-2315 MHz and 2350-2360 MHz bands:

- (i) By a factor of not less than:  $43 + 10 \log (P)$  dB on all frequencies between 2305 and 2320 MHz and on all frequencies between 2345 and 2360 MHz that are outside the licensed band(s) of operation, not less than  $55 + 10 \log (P)$  dB on all frequencies between 2320 and 2324 MHz and on all frequencies between 2341 and 2345 MHz, not less than  $61 + 10 \log (P)$  dB on all frequencies between 2324 and 2328 MHz and on all frequencies between 2337 and 2341 MHz, and not less than  $67 + 10 \log (P)$  dB on all frequencies between 2328 and 2337 MHz.
- (ii) By a factor of not less than  $43 + 10 \log (P)$  dB on all frequencies between 2300 and 2305 MHz,  $55 + 10 \log (P)$  dB on all frequencies between 2296 and 2300 MHz,  $61 + 10 \log (P)$  dB on all frequencies between 2292 and 2296 MHz,  $67 + 10 \log (P)$  dB on all frequencies between 2288 and 2292 MHz, and  $70 + 10 \log (P)$  dB below 2288 MHz.
- (iii) By a factor of not less than  $43 + 10 \log (P)$  dB on all frequencies between 2360 and 2365 MHz, and not less than  $70 + 10 \log (P)$  dB above 2365 MHz.

### 3.6.2 Test Procedures

The testing follows FCC KDB 971168 D01 v03r01 Section 6.1.

1. The EUT was connected to spectrum analyzer and system simulator via a power divider.
2. The band edges of low and high channels for the highest RF powers were measured.
3. Set RBW  $\geq$  1% EBW in the 1MHz band immediately outside and adjacent to the band edge.
4. Beyond the 1 MHz band from the band edge, RBW=1MHz was used.
5. Set spectrum analyzer with RMS detector.
6. The RF fundamental frequency should be excluded against the limit line in the operating frequency band.
7. Checked that all the results comply with the emission limit line.

The limit line is derived from  $43 + 10\log(P)$ dB below the transmitter power P(Watts)



## 3.7 Conducted Spurious Emission

### 3.7.1 Description of Conducted Spurious Emission Measurement

The power of any emission outside of the authorized operating frequency ranges must be lower than the transmitter power (P) by a factor of at least  $70 + 10 \log (P)$  dB.

It is measured by means of a calibrated spectrum analyzer and scanned from 9 kHz up to a frequency including its 10<sup>th</sup> harmonic.

### 3.7.2 Test Procedures

The testing follows FCC KDB 971168 D01 v03r01 Section 6.1.

1. The EUT was connected to spectrum analyzer and system simulator via a power divider.
2. The RF output of EUT was connected to the spectrum analyzer by RF cable and attenuator. The path loss was compensated to the results for each measurement.
3. The middle channel for the highest RF power within the transmitting frequency was measured.
4. The conducted spurious emission for the whole frequency range was taken.
5. Make the measurement with the spectrum analyzer's RBW = 1MHz, VBW = 3MHz.
6. Set spectrum analyzer with RMS detector.
7. Taking the record of maximum spurious emission.
8. The RF fundamental frequency should be excluded against the limit line in the operating frequency band.
9. The limit line is derived from  $70 + 10\log(P)$ dB below the transmitter power P(Watts)  
=  $P(W) - [70 + 10\log(P)]$  (dB)  
=  $[30 + 10\log(P)]$  (dBm) -  $[70 + 10\log(P)]$  (dB)  
= -40dBm.





## 3.8 Frequency Stability

### 3.8.1 Description of Frequency Stability Measurement

The frequency stability shall be sufficient to ensure that the fundamental emission stays within the authorized frequency block.

### 3.8.2 Test Procedures for Temperature Variation

The testing follows FCC KDB 971168 D01 v03r01 Section 9.0.

1. The EUT was set up in the thermal chamber and connected with the system simulator.
2. With power OFF, the temperature was decreased to -30°C and the EUT was stabilized before testing. Power was applied and the maximum change in frequency was recorded within one minute.
3. With power OFF, the temperature was raised in 10°C step up to 50°C. The EUT was stabilized at each step for at least half an hour. Power was applied and the maximum frequency change was recorded within one minute.

### 3.8.3 Test Procedures for Voltage Variation

The testing follows FCC KDB 971168 D01 v03r01 Section 9.0.

1. The EUT was placed in a temperature chamber at 20±5° C and connected with the system simulator.
2. The power supply voltage to the EUT was varied from 85% to 115% of the nominal value measured at the input to the EUT.
3. The variation in frequency was measured for the worst case.

## 4 Radiated Test Items

### 4.1 Measuring Instruments

See list of measuring instruments of this test report.

#### 4.1.1 Test Setup

For radiated test below 30MHz

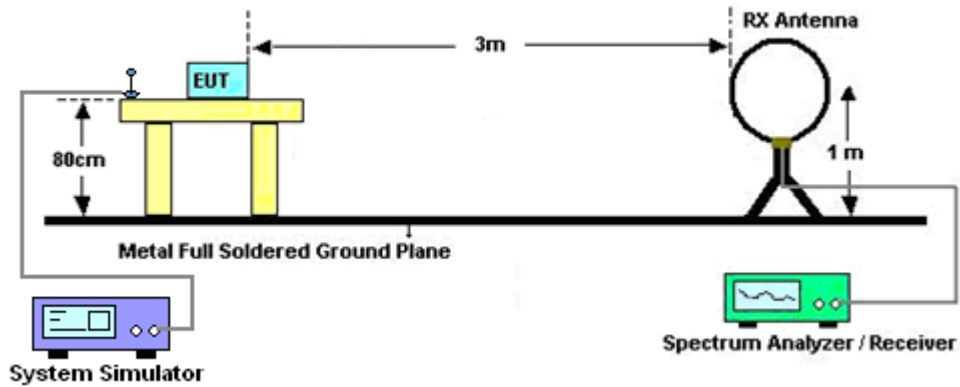

For radiated test from 30MHz to 1GHz

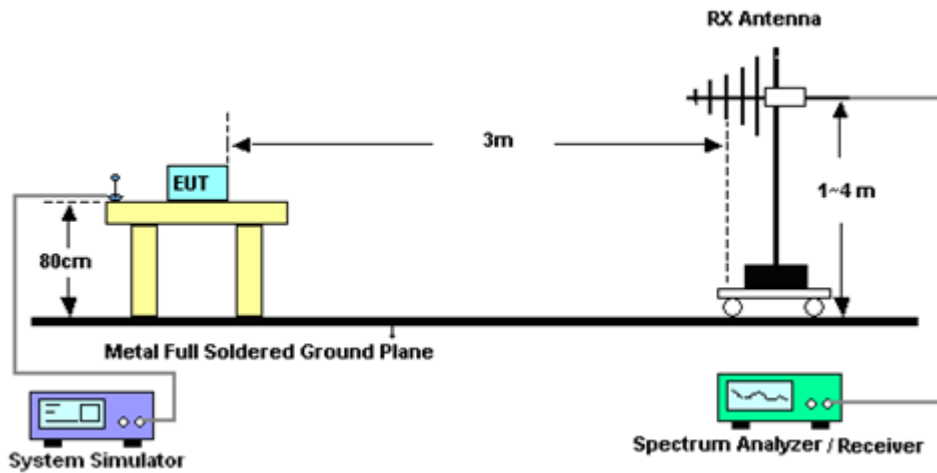

For radiated test from 1GHz to 18GHz

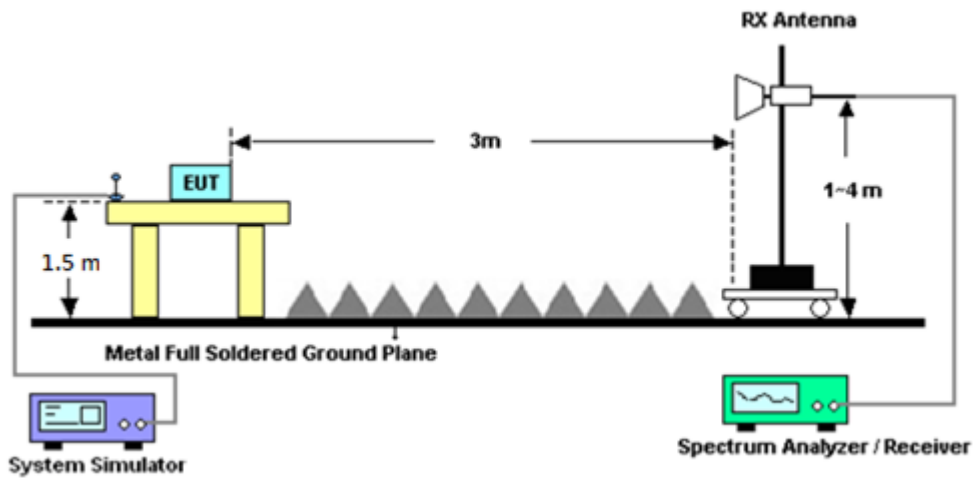

For radiated test above 18GHz

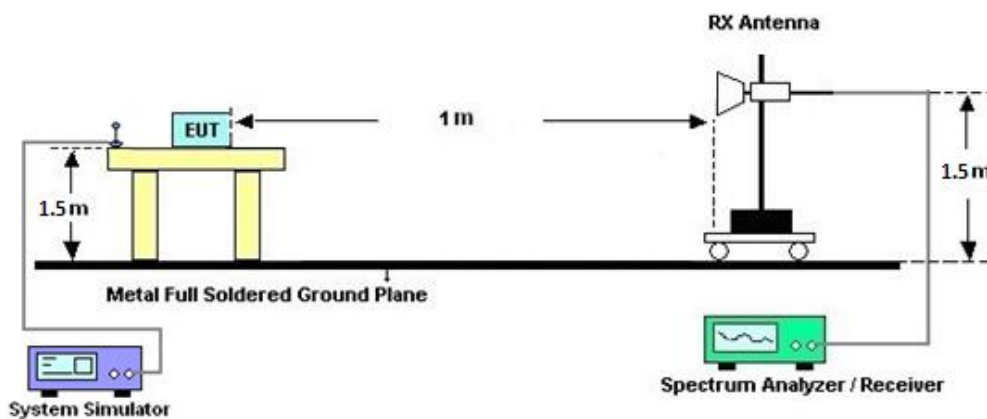

#### 4.1.2 Test Result of Radiated Test

Please refer to Appendix B.

**Note:**

The low frequency, which started from 9 kHz to 30MHz, was pre-scanned and the result which was 20dB lower than the limit line was not reported.

There is adequate comparison measurement of both open-field test site and alternative test site - semi-Anechoic chamber according to 414788 D01 Radiated Test Site v01r01, and the result came out very similar.



## 4.2 Radiated Spurious Emission Measurement

### 4.2.1 Description of Radiated Spurious Emission Measurement

The radiated spurious emission was measured by substitution method according to ANSI / TIA-603-E  
The power of any emission outside of the authorized operating frequency ranges must be attenuated below the transmitter power (P) by a factor of at least  $70 + 10 \log (P)$  dB.  
The spectrum is scanned from 30 MHz up to a frequency including its 10th harmonic.

### 4.2.2 Test Procedures

The testing follows FCC KDB 971168 D01 v03r01 Section 7 and ANSI / TIA-603-E Section 2.2.12.

1. The EUT was placed on a turntable with 0.8 meter height for frequency below 1GHz and 1.5 meter height for frequency above 1GHz respectively above ground.
2. The EUT was set 3 meters from the receiving antenna mounted on the antenna tower.
3. The table was rotated 360 degrees to determine the position of the highest spurious emission.
4. The height of the receiving antenna is varied between 1m to 4m to search the maximum spurious emission for both horizontal and vertical polarizations.
5. During the measurement, the system simulator parameters were set to force the EUT transmitting at maximum output power.
6. Make the measurement with the spectrum analyzer's RBW = 1MHz, VBW = 3MHz, taking the record of maximum spurious emission.
7. Measure the burst average result by setting trace = max hold or trace = average with duty cycle factor when margin is not enough.
8. A horn antenna was substituted in place of the EUT and was driven by a signal generator.
9. Tune the output power of signal generator to the same emission level with EUT maximum spurious emission.
10. The RF fundamental frequency should be excluded against the limit line in the operating frequency band.

$$\text{EIRP (dBm)} = \text{S.G. Power} - \text{Tx Cable Loss} + \text{Tx Antenna Gain}$$

$$\text{ERP (dBm)} = \text{EIRP} - 2.15$$

The limit line is derived from  $70 + 10\log(P)$ dB below the transmitter power P(Watts)

$$= P(W) - [70 + 10\log(P)] \text{ (dB)}$$

$$= [30 + 10\log(P)] \text{ (dBm)} - [70 + 10\log(P)] \text{ (dB)}$$

$$= -40\text{dBm.}$$



## 5 List of Measuring Equipment

Instrument	Brand Name	Model No.	Serial No.	Characteristics	Calibration Date	Test Date	Due Date	Remark
Loop Antenna	Rohde & Schwarz	HFH2-Z2	100488	9 kHz~30 MHz	May 13, 2022	Jul. 29, 2022~ Aug. 11, 2022	May 12, 2023	Radiation (03CH07-HY)
RF Cable	HUBER + SUHNER	SUCOFLEX 104	MY9837/4PE	9kHz~30MHz	Mar. 10, 2022	Jul. 29, 2022~ Aug. 11, 2022	Mar. 09, 2023	Radiation (03CH07-HY)
Bilog Antenna	TESEQ	CBL 6111D & 00800N1D01N-06	35419 & 03	30MHz~1GHz	Apr. 24, 2022	Jul. 29, 2022~ Aug. 11, 2022	Apr. 23, 2023	Radiation (03CH07-HY)
Double Ridge Horn Antenna	ESCO	3117	00075962	1GHz ~ 18GHz	Dec. 03, 2021	Jul. 29, 2022~ Aug. 11, 2022	Dec. 02, 2022	Radiation (03CH07-HY)
Preamplifier	MITEQ	AMF-7D-0010180 0-30-10P	1590075	1GHz~18GHz	Apr. 21, 2022	Jul. 29, 2022~ Aug. 11, 2022	Apr. 20, 2023	Radiation (03CH07-HY)
Preamplifier	COM-POWER	PA-103A	161241	10MHz~1GHz	Oct. 04, 2021	Jul. 29, 2022~ Aug. 11, 2022	Oct. 03, 2022	Radiation (03CH07-HY)
Preamplifier	Agilent	8449B	3008A02362	1GHz~26.5GHz	Oct. 04, 2021	Jul. 29, 2022~ Aug. 11, 2022	Oct. 03, 2022	Radiation (03CH07-HY)
Preamplifier	EMEC	EM18G40G	0600789	18-40GHz	Jul. 21, 2022	Jul. 29, 2022~ Aug. 11, 2022	Jul. 20, 2023	Radiation (03CH07-HY)
Spectrum Analyzer	Agilent	N9030A	MY52350276	3Hz~44GHz	Jul. 22, 2022	Jul. 29, 2022~ Aug. 11, 2022	Jul. 21, 2023	Radiation (03CH07-HY)
RF Cable	HUBER + SUHNER	SUCOFLEX 104	MY15682/4	30MHz to 18GHz	Feb. 23, 2022	Jul. 29, 2022~ Aug. 11, 2022	Feb. 22, 2023	Radiation (03CH07-HY)
RF Cable	HUBER + SUHNER	SUCOFLEX 104	MY24971/4	9kHz to 18GHz	Feb. 23, 2022	Jul. 29, 2022~ Aug. 11, 2022	Feb. 22, 2023	Radiation (03CH07-HY)
RF Cable	HUBER + SUHNER	SUCOFLEX 104	MY28655/4	9kHz to 18GHz	Feb. 23, 2022	Jul. 29, 2022~ Aug. 11, 2022	Feb. 22, 2023	Radiation (03CH07-HY)
RF Cable	HUBER + SUHNER	SUCOFLEX 126	532078/126E	30MHz~18GHz	Sep. 17, 2021	Jul. 29, 2022~ Aug. 11, 2022	Sep. 16, 2022	Radiation (03CH07-HY)
RF Cable	HUBER + SUHNER	SUCOFLEX 102	MY2858/2	18GHz~40GHz	Feb. 23, 2022	Jul. 29, 2022~ Aug. 11, 2022	Feb. 22, 2023	Radiation (03CH07-HY)
RF Cable	HUBER + SUHNER	SUCOFLEX 102	801606/2	9KHz ~ 40GHz	Apr. 14, 2022	Jul. 29, 2022~ Aug. 11, 2022	Apr. 13, 2023	Radiation (03CH07-HY)
Controller	EMEC	EM1000	N/A	Control Ant Mast	N/A	Jul. 29, 2022~ Aug. 11, 2022	N/A	Radiation (03CH07-HY)
Controller	MF	MF-7802	N/A	Control Turn table	N/A	Jul. 29, 2022~ Aug. 11, 2022	N/A	Radiation (03CH07-HY)
Antenna Mast	EMEC	AM-BS-4500E	N/A	Boresight mast 1M~4M	N/A	Jul. 29, 2022~ Aug. 11, 2022	N/A	Radiation (03CH07-HY)
Turn Table	ChainTek	Chaintek 3000	N/A	0~360 Degree	N/A	Jul. 29, 2022~ Aug. 11, 2022	N/A	Radiation (03CH07-HY)
Software	Audix	E3	N/A	N/A	N/A	Jul. 29, 2022~ Aug. 11, 2022	N/A	Radiation (03CH07-HY)
USB Data Logger	TECPEL	TR-32	HE17XB2495	N/A	Mar. 07, 2022	Jul. 29, 2022~ Aug. 11, 2022	Mar. 06, 2023	Radiation (03CH07-HY)
Horn Antenna	ETS-Lindgren	3117	00143261	1GHz~18GHz	Feb. 11, 2022	Jul. 29, 2022~ Aug. 11, 2022	Feb. 10, 2023	Radiation (03CH07-HY)
SHF-EHF Horn Antenna	SCHWARZBECK	BBHA 9170	BBHA9170251	18GHz~40GHz	Nov. 30, 2021	Jul. 29, 2022~ Aug. 11, 2022	Nov. 29, 2022	Radiation (03CH07-HY)
Signal Generator	Anritsu	MG3710A	6261943042	2G / 3G / LTE / 5G FR1	May 23, 2022	Jul. 29, 2022~ Aug. 11, 2022	May 22, 2023	Radiation (03CH07-HY)
DC Power Supply	GW Instek	GPE-2323	GEU871219	0V~64V ; 0A~6A	Dec. 21, 2021	Jul. 29, 2022~ Aug. 11, 2022	Dec. 20, 2022	Radiation (03CH07-HY)



Instrument	Brand Name	Model No.	Serial No.	Characteristics	Calibration Date	Test Date	Due Date	Remark
Programmable Power Supply	GW Instek	PSS-2005	EL883644	50Hz~60Hz	Dec. 03, 2021	Aug. 01, 2022~ Nov. 24, 2022	Dec. 02, 2023	Conducted (TH03-HY)
Hygrometer	Testo	608-H11	34893241	NA	Mar. 18, 2022	Aug. 01, 2022~ Nov. 24, 2022	Mar. 17, 2023	Conducted (TH03-HY)
Signal Analyzer	Rohde & Schwarz	FSV3044	101048	10Hz~44GHz	May 05, 2022	Aug. 01, 2022~ Nov. 24, 2022	May 04, 2023	Conducted (TH03-HY)
Temperature Chamber	ESPEC	SH-641	92013720	-40°C ~90°C	Sep. 09, 2021	Aug. 01, 2022~ Sep. 07, 2022	Sep. 08, 2022	Conducted (TH03-HY)
Temperature Chamber	ESPEC	SH-641	92013720	-40°C ~90°C	Sep. 07, 2022	Sep. 08, 2022~ Nov. 24, 2022	Sep. 06, 2023	Conducted (TH03-HY)
Base Station (Measure)	Anritsu	MT8821C	6262116730	LTE	Jun. 15, 2021	Aug. 01, 2022~ Nov. 24, 2022	Jun. 14, 2023	Conducted (TH03-HY)
Base Station (Measure)	Anritsu	MT8000A	6262134933	FR1	Jun. 13, 2022	Aug. 01, 2022~ Nov. 24, 2022	Jun. 12, 2023	Conducted (TH03-HY)



## 6 Uncertainty of Evaluation

### Uncertainty of Radiated Emission Measurement (30 MHz ~ 1000 MHz)

Measuring Uncertainty for a Level of Confidence of 95% ( $U = 2Uc(y)$ )	3.25 dB
---	---------

### Uncertainty of Radiated Emission Measurement (1 GHz ~ 18 GHz)

Measuring Uncertainty for a Level of Confidence of 95% ( $U = 2Uc(y)$ )	3.50 dB
---	---------

### Uncertainty of Radiated Emission Measurement (18 GHz ~ 40 GHz)

Measuring Uncertainty for a Level of Confidence of 95% ( $U = 2Uc(y)$ )	4.08 dB
---	---------



## Appendix A. Test Results of Conducted Test

### Conducted Output Power(Average power) and EIRP

NR n30 Maximum Average Power [dBm] (GT - LC = 1 dB)								
BW [MHz]	RB Size	RB Offset	Mod	Lowest	Middle	Highest	EIRP (dBm)	EIRP(W)
10	1	1	PI/2 BPSK	-	22.97	-	23.97	0.2495
10	1	50		-	22.96	-		
10	25	12		-	22.94	-		
10	1	0		-	22.85	-		
10	1	51		-	22.47	-		
10	50	0		-	22.68	-		
10	1	1	QPSK	-	22.96	-	23.01	0.2000
10	1	50		-	22.91	-		
10	25	12		-	22.95	-		
10	1	0		-	22.05	-		
10	1	51		-	22.03	-		
10	50	0		-	22.27	-		
10	1	1	16-QAM	-	22.01	-	23.01	0.2000
10	1	1	64-QAM	-	20.67	-		
10	1	1	256-QAM	-	17.95	-		
Limit	EIRP < 250 mW/5MHz			Result			Pass	

Total EIRP power is less than partial EIRP limit 250 mW/5MHz.





# FR1 n30

## Peak-to-Average Ratio

Mode	FR1 n30 / 10MHz / DFT-S OFDM				
Mod.	PI/2 BPSK	QPSK	16QAM	64QAM	Limit: 13dB
RB Size	Full RB	Full RB	Full RB	Full RB	Result
Middle CH	4.14	5.82	5.74	6.08	PASS
Mode	FR1 n30 / 10MHz / DFT-S OFDM				
Mod.	256QAM				Limit: 13dB
RB Size	Full RB				Result
Middle CH	6.82				PASS



FR1 n30 / 10MHz / DFT-S OFDM / Middle Channel / Full RB

PI/2 BPSK

QPSK

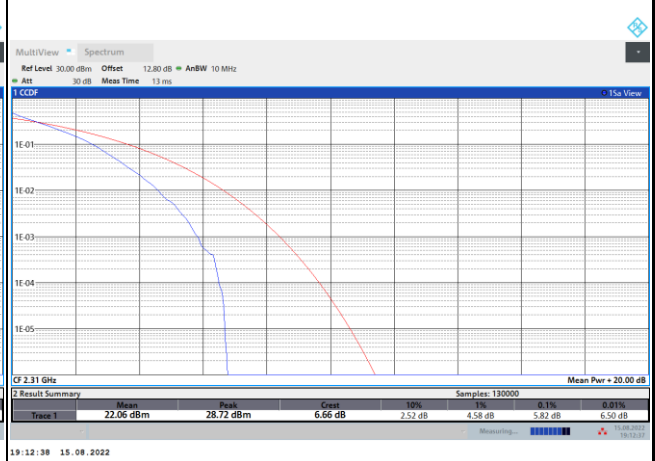
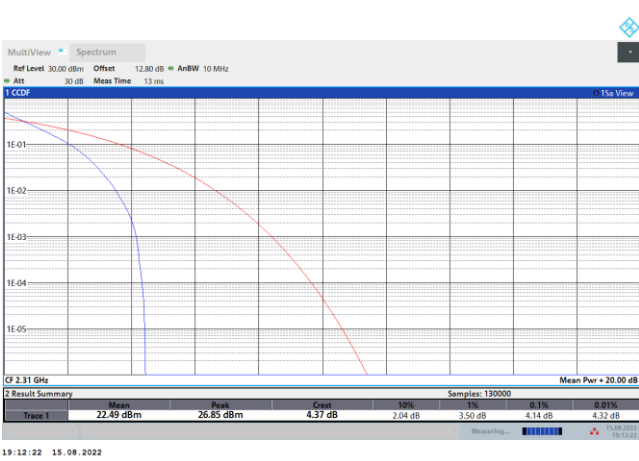

16QAM

64QAM

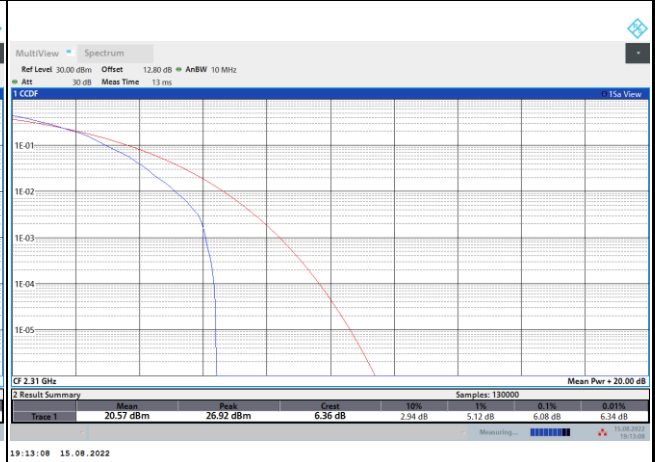
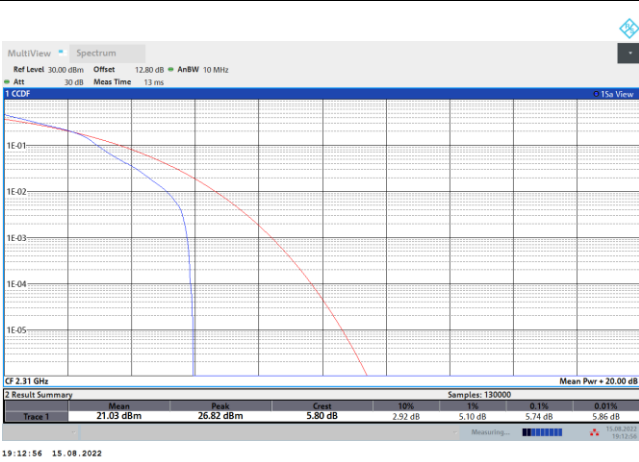

256QAM

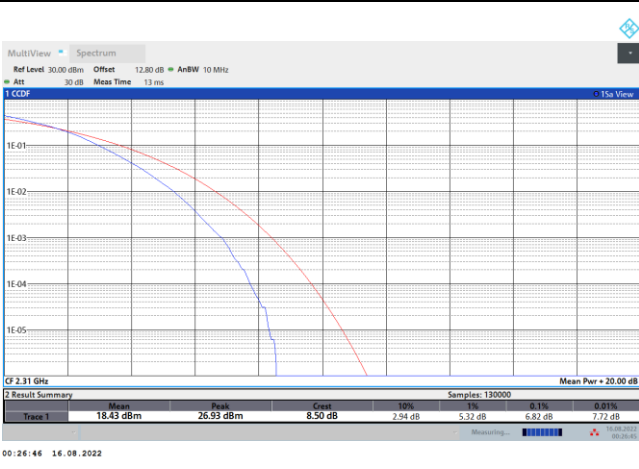



**26dB Bandwidth**

Mode	FR1 n30 : 26dB BW(MHz) / DFT-S OFDM							
BW	5MHz		10MHz					
Mod.	PI/2 BPSK		PI/2 BPSK					
Middle CH	-		9.55					

Mode	FR1 n30 : 26dB BW(MHz) / CP OFDM							
BW	5MHz		10MHz					
Mod.	QPSK	16QAM	QPSK	16QAM				
Middle CH	-	-	9.99	9.95				
Mod.	64QAM	256QAM	64QAM	256QAM				
Middle CH	-	-	9.95	9.95				



FR1 n30 / 10MHz / DFT-S OFDM / Middle Channel / Full RB

PI/2 BPSK

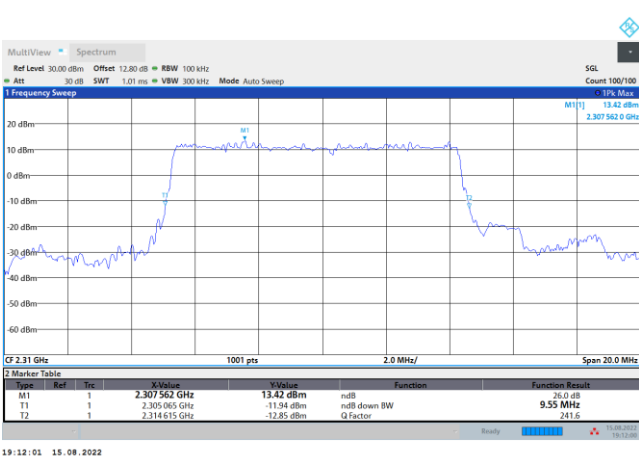

FR1 n30 / 10MHz / CP OFDM / Middle Channel / Full RB

QPSK

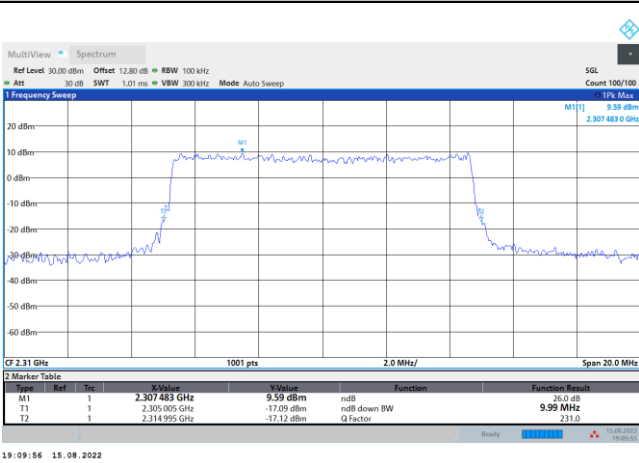

16QAM

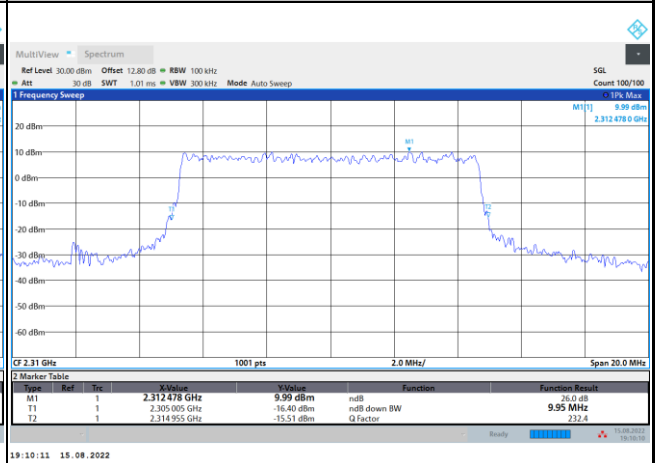

64QAM

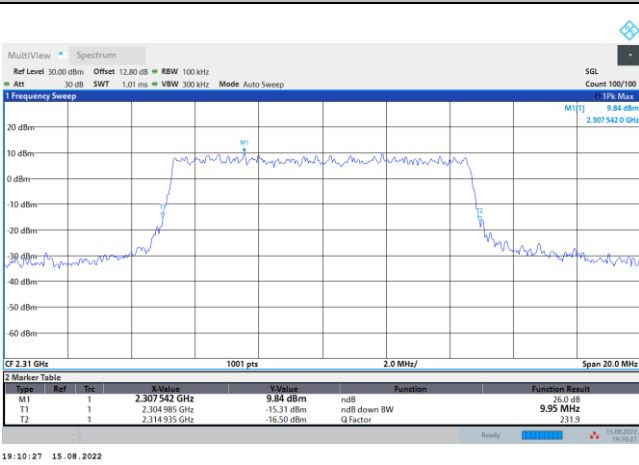

256QAM

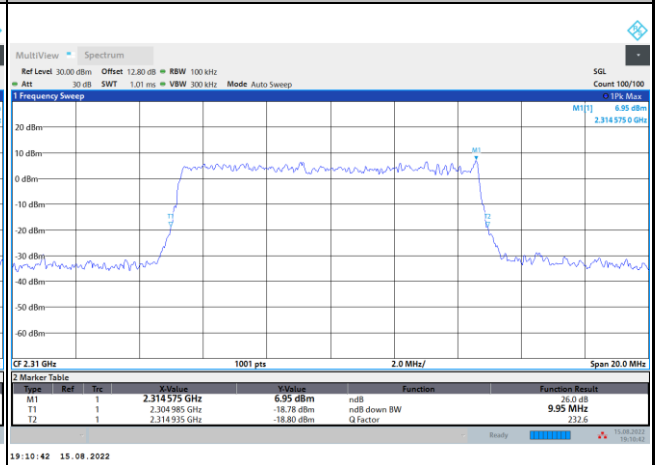



## Occupied Bandwidth

Mode	FR1 n30 : 99%OBW(MHz) / DFT-S OFDM							
BW	5MHz		10MHz					
Mod.	PI/2 BPSK		PI/2 BPSK					
Middle CH	-		8.92					

Mode	FR1 n30 : 99%OBW (MHz) / CP OFDM							
BW	5MHz		10MHz					
Mod.	QPSK	16QAM	QPSK	16QAM				
Middle CH	-	-	9.28	9.29				
Mod.	64QAM	256QAM	64QAM	256QAM				
Middle CH	-	-	9.30	9.32				



FR1 n30 / 10MHz / DFT-S OFDM / Middle Channel / Full RB

PI/2 BPSK

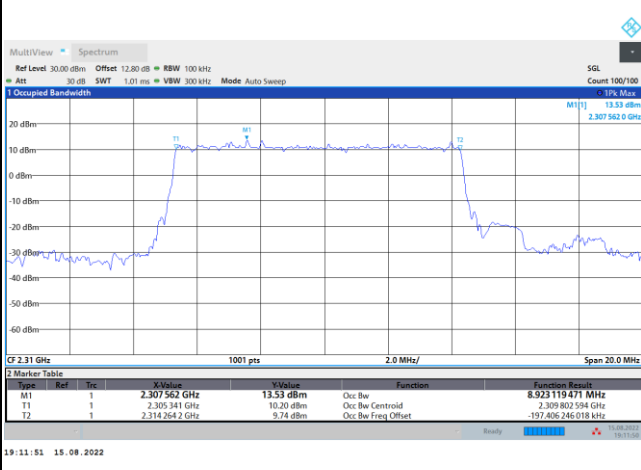

FR1 n30 / 10MHz / CP OFDM / Middle Channel / Full RB

QPSK

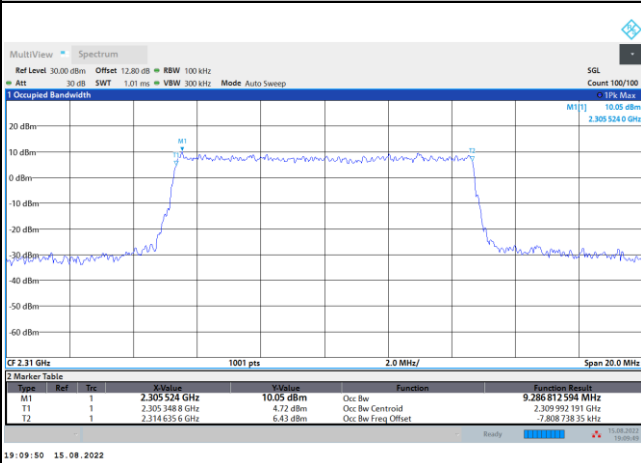

16QAM

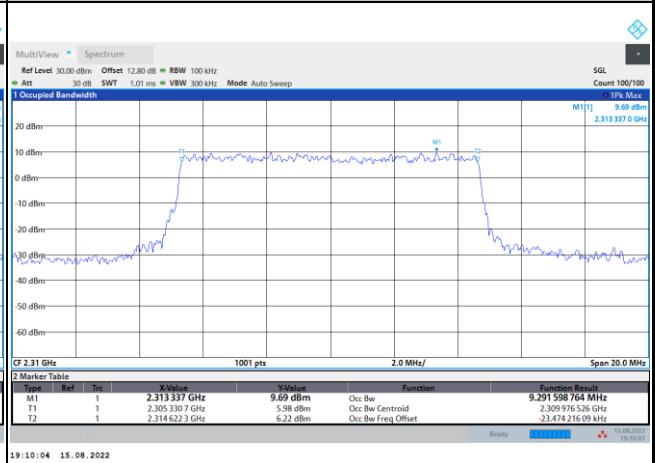

64QAM

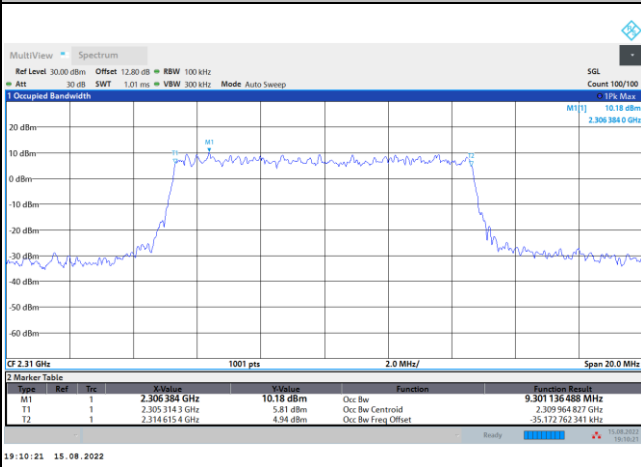

256QAM

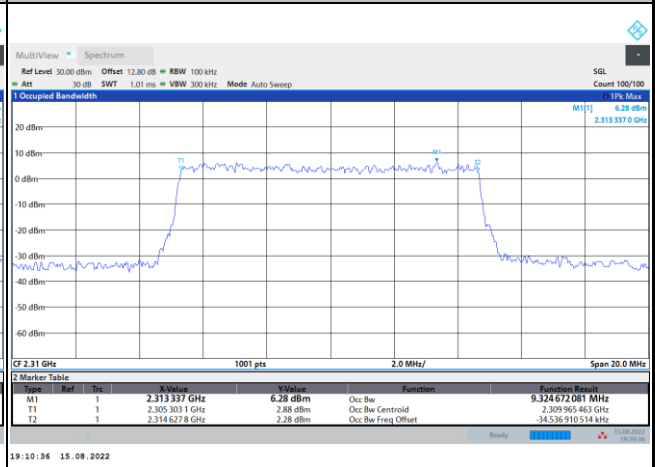



# Conducted Band Edge

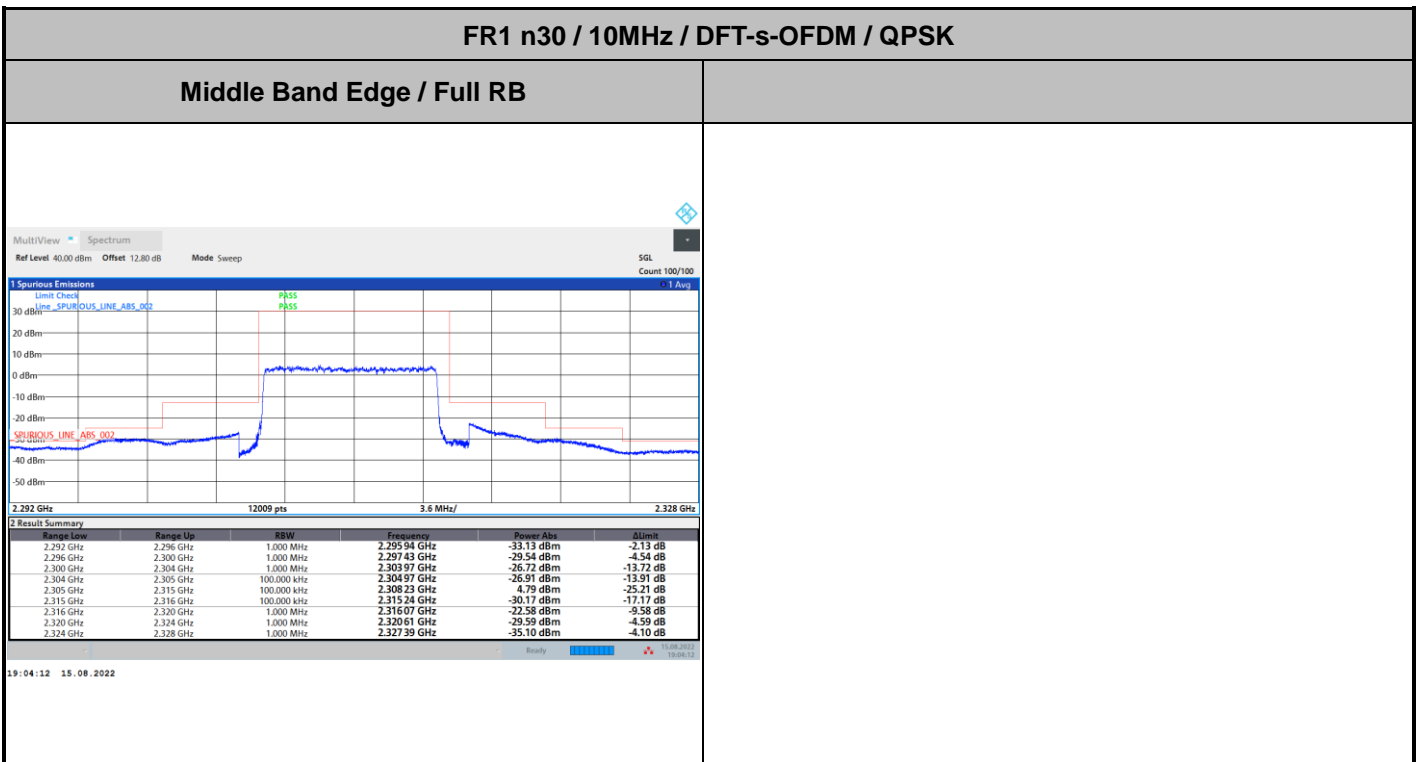
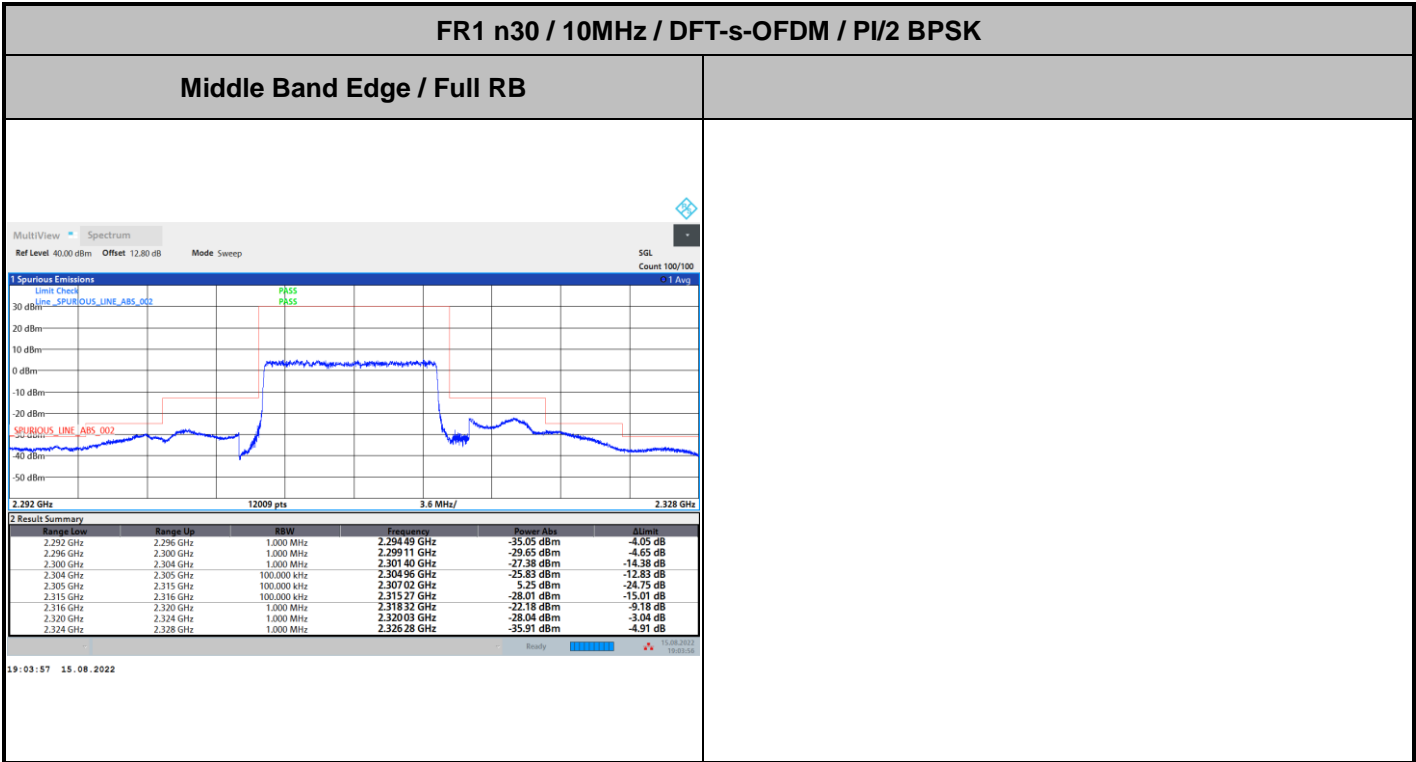



FR1 n30 / 10MHz / DFT-s-OFDM / 16QAM

Middle Band Edge / Full RB

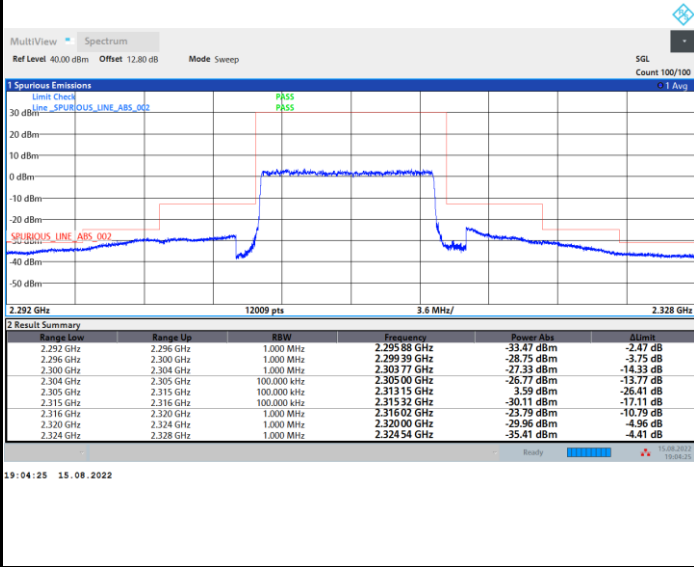

FR1 n30 / 10MHz / DFT-s-OFDM / 64QAM

Middle Band Edge / Full RB

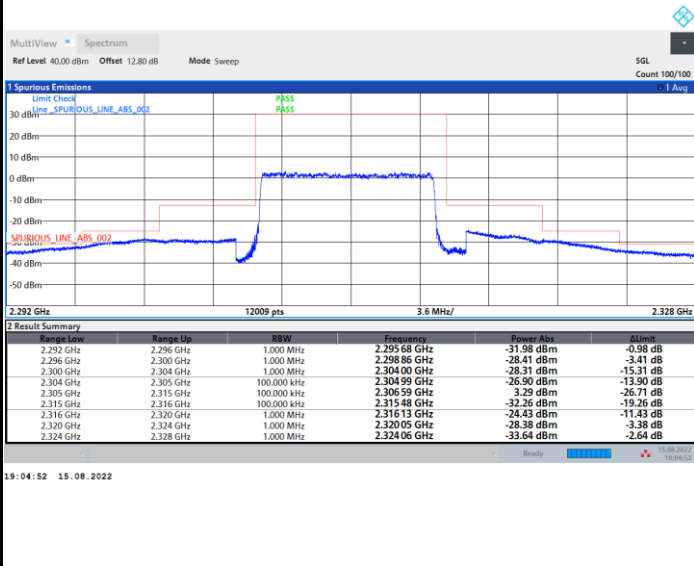





FR1 n30 / 10MHz / DFT-s-OFDM / 256QAM

Middle Band Edge / Full RB

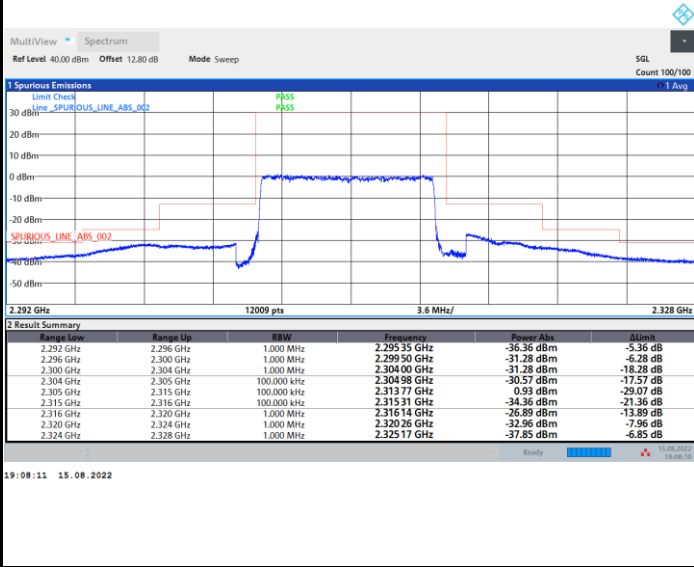

FR1 n30 / 10MHz / CP OFDM / QPSK / Full RB

Middle Band Edge / Full RB

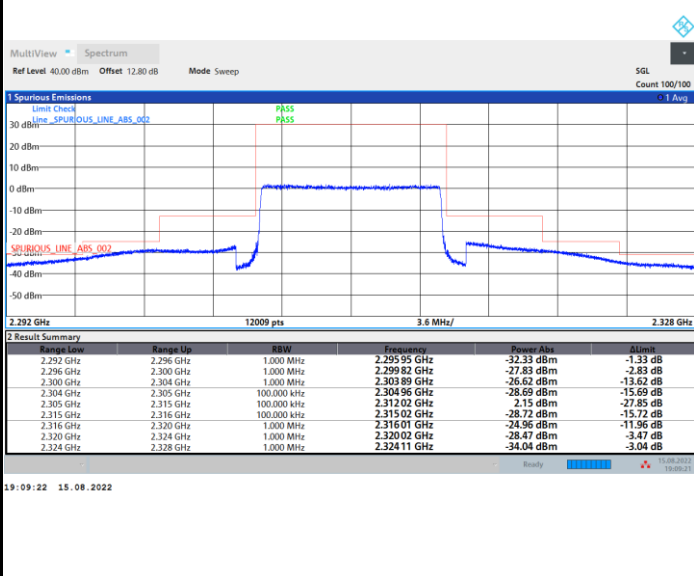



# Conducted Spurious Emission

FR1 n30 / 10MHz / DFT-S OFDM / QPSK / 1RB1

Middle Channel

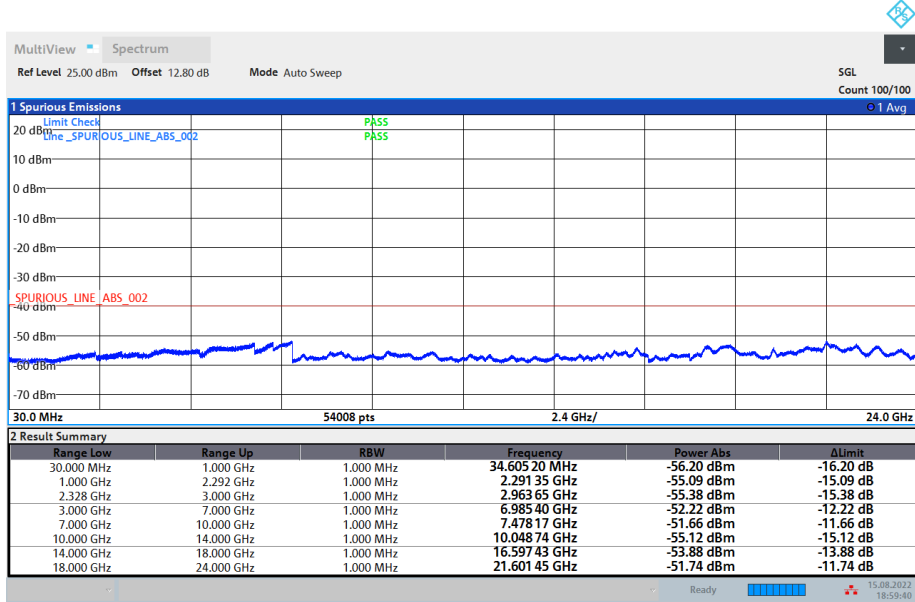

18:59:40 15.08.2022



### Frequency Stability

Test Conditions		FR1 n30 (BPSK) / Middle Channel	Limit
Temperature (°C)	Voltage (Volt)	BW 10MHz	Note 2.
		Deviation (ppm)	Result
50	Normal Voltage	0.0047	PASS
40	Normal Voltage	0.0005	
30	Normal Voltage	0.0002	
20(Ref.)	Normal Voltage	0.0000	
10	Normal Voltage	0.0046	
0	Normal Voltage	0.0035	
-10	Normal Voltage	0.0063	
-20	Normal Voltage	0.0065	
-30	Normal Voltage	0.0016	
20	Maximum Voltage	0.0049	
20	Normal Voltage	0.0000	
20	Battery End Point	0.0014	

**Note:**

- 1. Normal Voltage = 3.3 V. ; Battery End Point (BEP) = 3.135 V. ; Maximum Voltage = 4.4 V.
- 2. The frequency fundamental emissions stay within the authorized frequency block.



### Appendix B. Test Results of Radiated Test

<Ant. 0>

### 5G NR n30

5G NR n30/ 10MHz / PI/2 BPSK									
Channel	Frequency ( MHz )	EIRP ( dBm )	Limit ( dBm )	Margin ( dB )	SPA Reading (dBm)	S.G. Power ( dBm )	TX Cable loss ( dB )	TX Antenna Gain (dBi)	Polarization (H/V)
Middle	4608	-59.11	-40	-19.11	-81.41	-65.91	2.11	8.92	H
	6912	-55.57	-40	-15.57	-82.45	-63.65	2.62	10.69	H
	9216	-52.67	-40	-12.67	-82.59	-62.75	2.53	12.61	H
									H
									H
									H
									H
	4608	-59.10	-40	-19.10	-81.41	-65.9	2.11	8.92	V
	6912	-55.77	-40	-15.77	-82.65	-63.85	2.62	10.69	V
	9216	-52.65	-40	-12.65	-82.99	-62.73	2.53	12.61	V
									V
									V
									V
									V

Remark: Spurious emissions within 30-1000MHz were found more than 20dB below limit line.



<Ant. 0 + Ant. 2>

**EN-DC 5A-n30A**

EN-DC 5A-n30A / 10MHz / PI/2 BPSK									
Channel	Frequency ( MHz )	EIRP ( dBm )	Limit ( dBm )	Margin ( dB )	SPA Reading (dBm)	S.G. Power ( dBm )	TX Cable loss ( dB )	TX Antenna Gain (dBi)	Polarization (H/V)
Middle	4608	-57.34	-40	-17.34	-79.64	-64.14	2.11	8.92	H
	6912	-54.02	-40	-14.02	-80.9	-62.1	2.62	10.69	H
	9216	-50.92	-40	-10.92	-80.84	-61	2.53	12.61	H
									H
									H
									H
									H
	4608	-57.35	-40	-17.35	-79.66	-64.15	2.11	8.92	V
	6912	-54.47	-40	-14.47	-81.35	-62.55	2.62	10.69	V
	9216	-50.71	-40	-10.71	-81.05	-60.79	2.53	12.61	V
									V
									V
									V
									V

**Remark:** Spurious emissions within 30-1000MHz were found more than 20dB below limit line.



**EN-DC 12A-n30A**

EN-DC 12A-n30A / 10MHz / PI/2 BPSK									
Channel	Frequency ( MHz )	EIRP ( dBm )	Limit ( dBm )	Margin ( dB )	SPA Reading (dBm)	S.G. Power ( dBm )	TX Cable loss ( dB )	TX Antenna Gain (dBi)	Polarization (H/V)
Middle	4608	-57.20	-40	-17.20	-79.5	-64	2.11	8.92	H
	6912	-54.19	-40	-14.19	-81.07	-62.27	2.62	10.69	H
	9216	-50.83	-40	-10.83	-80.75	-60.91	2.53	12.61	H
									H
									H
									H
									H
	4608	-57.42	-40	-17.42	-79.73	-64.22	2.11	8.92	V
	6912	-54.01	-40	-14.01	-80.89	-62.09	2.62	10.69	V
	9216	-50.82	-40	-10.82	-81.17	-60.9	2.53	12.61	V
									V
									V
									V
									V

**Remark:** Spurious emissions within 30-1000MHz were found more than 20dB below limit line.



**EN-DC 14A-n30A**

EN-DC 14A-n30A / 10MHz / PI/2 BPSK									
Channel	Frequency ( MHz )	EIRP ( dBm )	Limit ( dBm )	Margin ( dB )	SPA Reading (dBm)	S.G. Power ( dBm )	TX Cable loss ( dB )	TX Antenna Gain (dBi)	Polarization (H/V)
Middle	4608	-57.05	-40	-17.05	-79.35	-63.85	2.11	8.92	H
	6912	-53.94	-40	-13.94	-80.82	-62.02	2.62	10.69	H
	9216	-51.09	-40	-11.09	-81.01	-61.17	2.53	12.61	H
									H
									H
									H
									H
	4608	-56.98	-40	-16.98	-79.29	-63.78	2.11	8.92	V
	6912	-53.81	-40	-13.81	-80.77	-61.89	2.62	10.69	V
	9216	-50.83	-40	-10.83	-81.17	-60.91	2.53	12.61	V
									V
									V
									V
									V

**Remark:** Spurious emissions within 30-1000MHz were found more than 20dB below limit line.