



FCC RADIO TEST REPORT

FCC ID : RI7FN990A40
Equipment : 5G NR Module
Brand Name : 
Model Name : FN990A40
Marketing Name : FN990A40
Applicant : Telit Communications S.p.A.
Viale Stazione di Prosecco 5/b, Trieste 34010, Italy
Manufacturer : Telit Communications S.p.A.
Viale Stazione di Prosecco 5/b, Trieste 34010, Italy
Standard : FCC 47 CFR Part 2, 27

The product was received on Jul. 07, 2022 and testing was performed from Aug. 13, 2022 to Dec. 03, 2022. We, Sporton International Inc. EMC & Wireless Communications Laboratory, would like to declare that the tested sample has been evaluated in accordance with the test procedures given in ANSI / TIA-603-E and has been in compliance with the applicable technical standards.

The test results in this report apply exclusively to the tested model / sample. Without written approval of Sporton International Inc. EMC & Wireless Communications Laboratory, the test report shall not be reproduced except in full.

Louis Wu

Approved by: Louis Wu

Sporton International Inc. EMC & Wireless Communications Laboratory

No. 52, Huaya 1st Rd., Guishan Dist., Taoyuan City 333, Taiwan (R.O.C.)



Table of Contents

History of this test report..... 3

Summary of Test Result..... 4

1 General Description 5

 1.1 Product Feature of Equipment Under Test..... 5

 1.2 Modification of EUT 5

 1.3 Testing Location 5

 1.4 Applicable Standards..... 6

2 Test Configuration of Equipment Under Test 7

 2.1 Test Mode..... 7

 2.2 Connection Diagram of Test System..... 8

 2.3 Support Unit used in test configuration and system 9

 2.4 Measurement Results Explanation Example..... 9

 2.5 Frequency List of Low/Middle/High Channels 9

3 Conducted Test Items..... 11

 3.1 Measuring Instruments 11

 3.2 Conducted Output Power and EIRP 12

 3.3 Peak-to-Average Ratio 13

 3.4 Occupied Bandwidth..... 14

 3.5 Conducted Band Edge 15

 3.6 Conducted Spurious Emission 16

 3.7 Frequency Stability 17

4 Radiated Test Items 18

 4.1 Measuring Instruments 18

 4.2 Radiated Spurious Emission Measurement 20

5 List of Measuring Equipment..... 21

6 Uncertainty of Evaluation..... 23

Appendix A. Test Results of Conducted Test

Appendix B. Test Results of Radiated Test

Appendix C. Test Setup Photographs



History of this test report

Report No.	Version	Description	Issue Date
FG270608M	01	Initial issue of report	Dec. 09, 2022



Summary of Test Result

Report Clause	Ref Std. Clause	Test Items	Result (PASS/FAIL)	Remark
3.2	§2.1046	Conducted Output Power	Reporting only	-
	§27.50 (k)(3)	Equivalent Isotropic Radiated Power	Pass	
3.3	§27.50 (k)(4)	Peak-to-Average Ratio	Pass	-
3.4	§2.1049	Occupied Bandwidth	Reporting only	-
3.5	§2.1051 §27.53 (n)(2)	Conducted Band Edge Measurement	Pass	-
3.6	§2.1051 §27.53 (n)(2)	Conducted Spurious Emission	Pass	-
3.7	§2.1055 §27.54	Frequency Stability Temperature & Voltage	Pass	-
4.2	§2.1053 §27.53 (n)(2)	Radiated Spurious Emission	Pass	Under limit 35.21 dB at 13804.000 MHz

Declaration of Conformity:

- The test results (PASS/FAIL) with all measurement uncertainty excluded are presented in accordance with the regulation limits or requirements declared by manufacturers. It's means measurement values may risk exceeding the limit of regulation standards, if measurement uncertainty is include in test results.
- The measurement uncertainty please refer to this report "Uncertainty of Evaluation".

Comments and Explanations:

The product specifications of the EUT presented in the report are declared by the manufacturer who shall take full responsibility for the authenticity.

Reviewed by: Avis Chuang

Report Producer: Lucy Wu



1 General Description

1.1 Product Feature of Equipment Under Test

WCDMA/LTE/5G NR, and GNSS

Product Feature	
Antenna Type	WWAN: Monopole Antenna GPS/Glonass/BDS/Galileo/SBAS: Monopole Antenna
Antenna Gain	LTE Band 42: 0.5 dBi

Remark: The EUT's information above is declared by manufacturer. Please refer to Comments and Explanations in report summary.

1.2 Modification of EUT

No modifications are made to the EUT during all test items.

1.3 Testing Location

Test Site	Sporton International Inc. EMC & Wireless Communications Laboratory
Test Site Location	No.52, Huaya 1st Rd., Guishan Dist., Taoyuan City 333, Taiwan (R.O.C.) TEL: +886-3-327-3456 FAX: +886-3-328-4978
Test Site No.	Sporton Site No. TH03-HY
Test Engineer	George Chen
Temperature (°C)	22.8~24.5
Relative Humidity (%)	51~58

Test Site	Sporton International Inc. Wensan Laboratory.
Test Site Location	No.58, Aly. 75, Ln. 564, Wenhua 3rd, Rd., Guishan Dist., Taoyuan City 333010, Taiwan (R.O.C.) TEL: +886-3-327-0868 FAX: +886-3-327-0855
Test Site No.	Sporton Site No. 03CH12-HY (TAF Code: 3786)
Test Engineer	Tim Lee, Wilson Wu and Jesse Fan
Temperature (°C)	20~25
Relative Humidity (%)	50~60
Remark	The Radiated Spurious Emission test item subcontracted to Sporton International Inc. Wensan Laboratory.

Note: The test site complies with ANSI C63.4 2014 requirement.

FCC Designation No.: TW1190 and TW3786



1.4 Applicable Standards

According to the specifications of the manufacturer, the EUT must comply with the requirements of the following standards:

- ♦ ANSI C63.26-2015
- ♦ ANSI / TIA-603-E
- ♦ FCC 47 CFR Part 2, 27
- ♦ FCC KDB 971168 D01 Power Meas. License Digital Systems v03r01
- ♦ FCC KDB 412172 D01 Determining ERP and EIRP v01r01
- ♦ FCC KDB 414788 D01 Radiated Test Site v01r01.

Remark:

1. All test items were verified and recorded according to the standards and without any deviation during the test.
2. This EUT has also been tested and complied with the requirements of FCC Part 15, Subpart B, recorded in a separate test report.
3. The TAF code is not including all the FCC KDB listed without accreditation.



2 Test Configuration of Equipment Under Test

2.1 Test Mode

Antenna port conducted and radiated test items listed below are performed according to KDB 971168 D01 Power Meas. License Digital Systems v03r01 with maximum output power.

For radiated measurement, the measured emission level of the EUT was maximized by rotating the EUT on a turntable, adjusting the orientation of the EUT and EUT antenna in two config (Ant. Horizontal and Ant. Vertical), and adjusting the measurement antenna orientation, following C63.26 exploratory test procedures and only the worst case emissions were reported in this report.

Test Items	Band	Bandwidth (MHz)						Modulation				RB #			Test Channel			
		1.4	3	5	10	15	20	QPSK	16QAM	64QAM	256QAM	1	Half	Full	L	M	H	
Max. Output Power	42	-	-	v	v	v	v	v	v	v	v	v	v	v	v	v	v	
26dB and 99% Bandwidth	42	-	-	v	v	v	v	v	v	v	v			v		v		
Conducted Band Edge	42	-	-	v	v	v	v	v	v	v	v	v		v	v		v	
Peak-to-Average Ratio	42	-	-					v	v	v	v			v		v		
Conducted Spurious Emission	42	-	-	v	v	v	v	v					v			v	v	v
E.R.P / E.I.R.P	42	-	-	v	v	v	v	v	v	v	v		Max. Power					
Frequency Stability	42	-	-		v			v						v		v		
Radiated Spurious Emission	42	Worst Case												v	v	v		
Remark	<ol style="list-style-type: none"> The mark "v" means that this configuration is chosen for testing The mark "-" means that this bandwidth is not supported. The device is investigated from 30MHz to 10 times of fundamental signal for radiated spurious emission test under different RB size/offset and modulations in exploratory test. Subsequently, only the worst case emissions are reported. One representative bandwidth is selected to perform PAR and frequency stability. 																	



Test Items	Band	Bandwidth (MHz)							Modulation				RB #			Test Channel		
		5+20	10+20	15+20	20+5	20+10	20+15	20+20	QPSK	16 QAM	64 QAM	256 QAM	1	Half	Full	L	M	H
Max. Output Power	42C_CA	v	v	v	v	v	v	v	v	v	v	v	v	v	v	v	v	v
26dB and 99% Bandwidth	42C_CA	v	v	v	v	v	v	v	v	v	v	v	v	v	v	v	v	v
Conducted Band Edge	42C_CA	v	v	v	v	v	v	v	v	v	v	v	v	v	v	v	v	
Conducted Spurious Emission	42C_CA	v	v	v	v	v	v	v	v	v	v	v	v	v	v	v	v	
E.I.R.P.	42C_CA	v	v	v	v	v	v	v	v	v	v	v	Max. Power					
Radiated Spurious Emission	42C_CA	Worst Case														v	v	v
Remark	1. The mark “v” means that this configuration is chosen for testing 2. The mark “-“ means that this bandwidth is not supported. 3. The device is investigated from 30MHz to 10 times of fundamental signal for radiated spurious emission test under different RB size/offset and modulations in exploratory test. Subsequently, only the worst case emissions are reported.																	

2.2 Connection Diagram of Test System

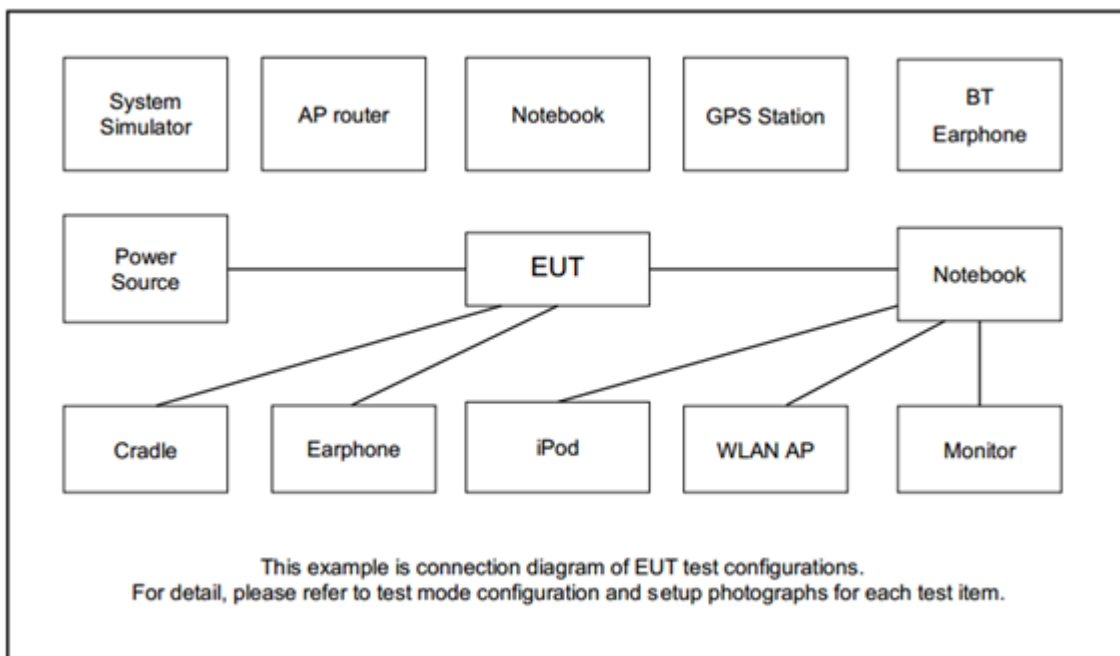



2.3 Support Unit used in test configuration and system

Item	Equipment	Brand Name	Model No.	FCC ID	Data Cable	Power Cord
1.	System Simulator	Anritsu	MT8821C	N/A	N/A	Unshielded, 1.8 m
2.	Power Supply	GW Instek	PSS-2005	N/A	N/A	Unshielded, 1.8 m

2.4 Measurement Results Explanation Example

For all conducted test items:

The offset level is set in the spectrum analyzer to compensate the RF cable loss and attenuator factor between EUT conducted output port and spectrum analyzer. With the offset compensation, the spectrum analyzer reading level is exactly the EUT RF output level.

The spectrum analyzer offset is derived from RF cable loss and attenuator factor.

Offset = RF cable loss + attenuator factor.

Following shows an offset computation example with cable loss 4.2 dB and 10dB attenuator.

Example :

$$\begin{aligned}
 \text{Offset(dB)} &= \text{RF cable loss(dB)} + \text{attenuator factor(dB)}. \\
 &= 4.2 + 10 = 14.2 \text{ (dB)}
 \end{aligned}$$

2.5 Frequency List of Low/Middle/High Channels

LTE Band 42 Channel and Frequency List				
BW [MHz]	Channel/Frequency(MHz)	Lowest	Middle	Highest
20	Channel	42190	42590	42990
	Frequency	3460	3500	3540
15	Channel	42165	42590	43015
	Frequency	3457.5	3500	3542.5
10	Channel	42140	42590	43040
	Frequency	3455	3500	3545
5	Channel	42115	42590	43115
	Frequency	3452.5	3500	3552.5



LTE Band 42C Channel and Frequency List_CA					
BW [MHz]	Channel/Frequency(MHz)		Lowest	Middle	Highest
20 + 20	PCC	Channel	42190	42491	42791
		Frequency	3460	3490.1	3520.1
	SCC	Channel	42388	42689	42990
		Frequency	3479.8	3509.9	3540
20 + 15	PCC	Channel	42190	42517	42844
		Frequency	3460	3492.7	3525.4
	SCC	Channel	42361	42688	43015
		Frequency	3477.1	3509.8	3542.5
15 + 20	PCC	Channel	42165	42492	42819
		Frequency	3457.5	3490.2	3522.9
	SCC	Channel	42336	42663	42990
		Frequency	3474.6	3507.3	3540
20 + 10	PCC	Channel	42190	42543	42896
		Frequency	3460	3495.3	3530.6
	SCC	Channel	42334	42687	43040
		Frequency	3474.4	3509.7	3545
10 + 20	PCC	Channel	42140	42493	42846
		Frequency	3455	3490.3	3525.6
	SCC	Channel	42284	42637	42990
		Frequency	3469.4	3504.7	3540
20 + 5	PCC	Channel	42190	42569	42948
		Frequency	3460	3497.9	3535.8
	SCC	Channel	42307	42686	43065
		Frequency	3471.7	3509.6	3547.5
5 + 20	PCC	Channel	42115	42494	42873
		Frequency	3452.5	3490.4	3528.3
	SCC	Channel	42232	42611	42990
		Frequency	3464.2	3502.1	3540

3 Conducted Test Items

3.1 Measuring Instruments

See list of measuring instruments of this test report.

3.1.1 Test Setup

3.1.2 Conducted Output Power

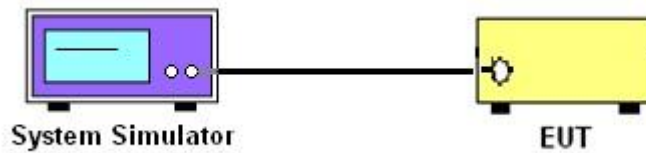

3.1.3 Peak-to-Average Ratio, Occupied Bandwidth ,Conducted Band-Edge and Conducted Spurious Emission

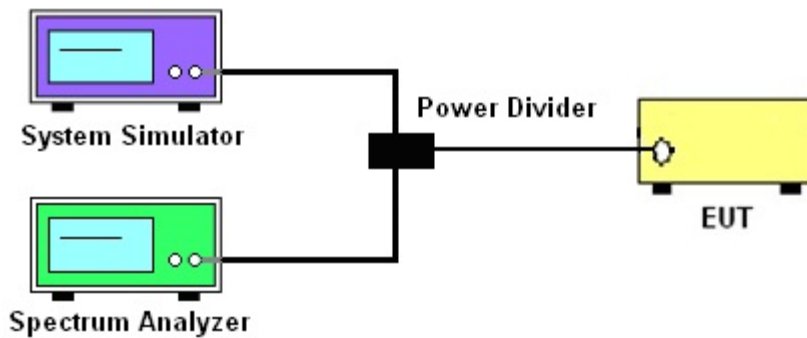

3.1.4 Frequency Stability

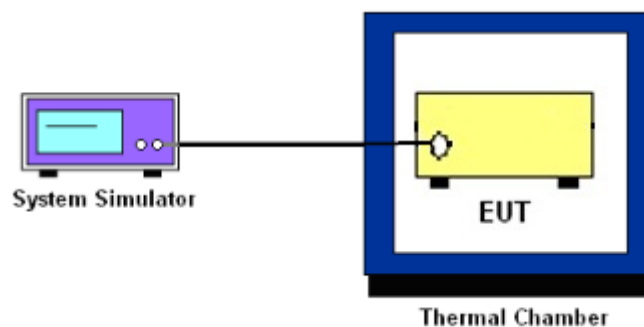

3.1.5 Test Result of Conducted Test

Please refer to Appendix A.



3.2 Conducted Output Power and EIRP

3.2.1 Description of the Conducted Output Power Measurement and EIRP Measurement

A system simulator was used to establish communication with the EUT. Its parameters were set to force the EUT transmitting at maximum output power. The measured power in the radio frequency on the transmitter output terminals shall be reported.

The EIRP of mobile transmitters must not exceed 1 Watts for LTE Band 42.

According to KDB 412172 D01 Power Approach,

$EIRP = P_T + G_T - L_C$, $ERP = EIRP - 2.15$, where

P_T = transmitter output power in dBm

G_T = gain of the transmitting antenna in dBi

L_C = signal attenuation in the connecting cable between the transmitter and antenna in dB

3.2.2 Test Procedures

1. The transmitter output port was connected to the system simulator.
2. Set EUT at maximum power through the system simulator.
3. Select lowest, middle, and highest channels for each band and different modulation.
4. Measure and record the power level from the system simulator.



3.3 Peak-to-Average Ratio

3.3.1 Description of the PAR Measurement

Power Complementary Cumulative Distribution Function (CCDF) curves provide a means for characterizing the power peaks of a digitally modulated signal on a statistical basis. A CCDF curve depicts the probability of the peak signal amplitude exceeding the average power level. Most contemporary measurement instrumentation include the capability to produce CCDF curves for an input signal provided that the instrument's resolution bandwidth can be set wide enough to accommodate the entire input signal bandwidth. In measuring transmissions in this band using an average power technique, the peak-to-average ratio (PAR) of the transmission may not exceed 13 dB.

3.3.2 Test Procedures

The testing follows ANSI C63.26-2015 Section 5.2.6

1. The EUT was connected to spectrum and system simulator via a power divider.
2. Set the CCDF (Complementary Cumulative Distribution Function) option in spectrum analyzer.
3. The highest RF powers were measured and recorded the maximum PAPR level associated with a probability of 0.1 %.
4. Record the deviation as Peak to Average Ratio.



3.4 Occupied Bandwidth

3.4.1 Description of Occupied Bandwidth Measurement

The occupied bandwidth is the width of a frequency band such that, below the lower and above the upper frequency limits, the mean powers emitted are each equal to a specified percentage 0.5% of the total mean transmitted power.

The 26 dB emission bandwidth is defined as the frequency range between two points, one above and one below the carrier frequency, at which the spectral density of the emission is attenuated 26 dB below the maximum in-band spectral density of the modulated signal. Spectral density (power per unit bandwidth) is to be measured with a detector of resolution bandwidth equal to approximately 1.0% of the emission bandwidth.

3.4.2 Test Procedures

The testing follows ANSI C63.26-2015 Section 5.4.3 (26dB) and Section 5.4.4 (99OB)

1. The EUT was connected to spectrum analyzer and system simulator via a power divider.
2. The spectrum analyzer center frequency is set to the nominal EUT channel center frequency. The span range for the spectrum analyzer shall be between two and five times the anticipated OBW.
3. The nominal resolution bandwidth (RBW) shall be in the range of 1 to 5 % of the anticipated OBW, and the VBW shall be at least 3 times the RBW.
4. Set the detection mode to peak, and the trace mode to max hold.
5. Determine the reference value: Set the EUT to transmit a modulated signal. Allow the trace to stabilize. Set the spectrum analyzer marker to the highest level of the displayed trace.
(this is the reference value)
6. Determine the “-26 dB down amplitude” as equal to (Reference Value – X).
7. Place two markers, one at the lowest and the other at the highest frequency of the envelope of the spectral display such that each marker is at or slightly below the “-X dB down amplitude” determined in step 6. If a marker is below this “-X dB down amplitude” value it shall be placed as close as possible to this value. The OBW is the positive frequency difference between the two markers.
8. Use the 99 % power bandwidth function of the spectrum analyzer and report the measured bandwidth.



3.5 Conducted Band Edge

3.5.1 Description of Conducted Band Edge Measurement

27.53 (n)(2)

(2) For mobile operations in the 3450-3550 MHz band, the conducted power of any emission outside the licensee's authorized bandwidth shall not exceed -13 dBm/MHz. Compliance with this paragraph (n)(2) is based on the use of measurement instrumentation employing a resolution bandwidth of 1 megahertz or greater. However, in the 1 megahertz bands immediately outside and adjacent to the licensee's frequency block, a resolution bandwidth of at least one percent of the emission bandwidth of the fundamental emission of the transmitter may be employed, but limited to a maximum of 200 kHz. In the bands between 1 and 5 MHz removed from the licensee's frequency block, the minimum resolution bandwidth for the measurement shall be 500 kHz. The emission bandwidth is defined as the width of the signal between two points, one below the carrier center frequency and one above the carrier center frequency, outside of which all emissions are attenuated at least 26 dB below the transmitter power.

3.5.2 Test Procedures

The testing follows FCC KDB 971168 D01 v03r01 Section 6.1.

1. The EUT was connected to spectrum analyzer and system simulator via a power divider.
2. The band edges of low and high channels for the highest RF powers were measured.
3. For $EBW < 20\text{MHz}$, set $RBW \geq 1\%$ EBW in the 1MHz band immediately outside and adjacent to the band edge.
4. For $EBW \geq 20\text{MHz}$, set $RBW = 200\text{kHz}$ in the 1MHz band immediately outside and adjacent to the band edge.
5. Between 1 ~5 MHz from the band edge, $RBW=500$ kHz was used.
6. Set spectrum analyzer with RMS detector.
7. The RF fundamental frequency should be excluded against the limit line in the operating frequency band.
8. Checked that all the results comply with the emission limit line.

The limit line is derived from $43 + 10\log(P)\text{dB}$ below the transmitter power P(Watts)



3.6 Conducted Spurious Emission

3.6.1 Description of Conducted Spurious Emission Measurement

The power of any emission outside of the authorized operating frequency ranges must be lower than the transmitter power (P) by a factor of at least $43 + 10 \log (P)$ dB.

It is measured by means of a calibrated spectrum analyzer and scanned from 30 MHz up to a frequency including its 10th harmonic.

3.6.2 Test Procedures

The testing follows FCC KDB 971168 D01 v03r01 Section 6.1.

1. The EUT was connected to spectrum analyzer and system simulator via a power divider.
2. The RF output of EUT was connected to the spectrum analyzer by RF cable and attenuator. The path loss was compensated to the results for each measurement.
3. The middle channel for the highest RF power within the transmitting frequency was measured.
4. The conducted spurious emission for the whole frequency range was taken.
5. Make the measurement with the spectrum analyzer's RBW = 1MHz, VBW = 3MHz.
6. Set spectrum analyzer with RMS detector.
7. Taking the record of maximum spurious emission.
8. The RF fundamental frequency should be excluded against the limit line in the operating frequency band.
9. The limit line is derived from $43 + 10\log(P)$ dB below the transmitter power P(Watts)



3.7 Frequency Stability

3.7.1 Description of Frequency Stability Measurement

27.54

The frequency stability shall be sufficient to ensure that the fundamental emission stays within the authorized frequency block.

3.7.2 Test Procedures for Temperature Variation

The testing follows FCC KDB 971168 D01 v03r01 Section 9.0.

1. The EUT was set up in the thermal chamber and connected with the system simulator.
2. With power OFF, the temperature was decreased to -30°C and the EUT was stabilized before testing. Power was applied and the maximum change in frequency was recorded within one minute.
3. With power OFF, the temperature was raised in 10°C step up to 50°C . The EUT was stabilized at each step for at least half an hour. Power was applied and the maximum frequency change was recorded within one minute.

3.7.3 Test Procedures for Voltage Variation

The testing follows FCC KDB 971168 D01 v03r01 Section 9.0.

1. The EUT was placed in a temperature chamber at $20\pm 5^{\circ}\text{C}$ and connected with the system simulator.
2. The power supply voltage to the EUT was varied from 85% to 115% of the nominal value measured at the input to the EUT.
3. The variation in frequency was measured for the worst case.

4 Radiated Test Items

4.1 Measuring Instruments

See list of measuring instruments of this test report.

4.1.1 Test Setup

For radiated test below 30MHz

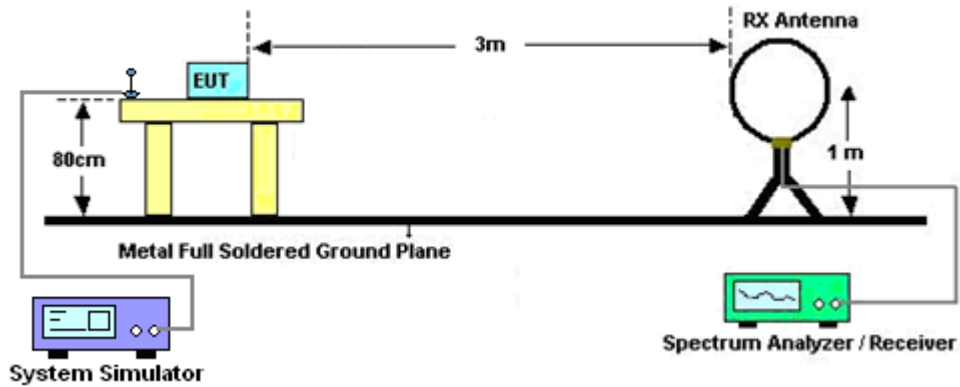

For radiated test from 30MHz to 1GHz

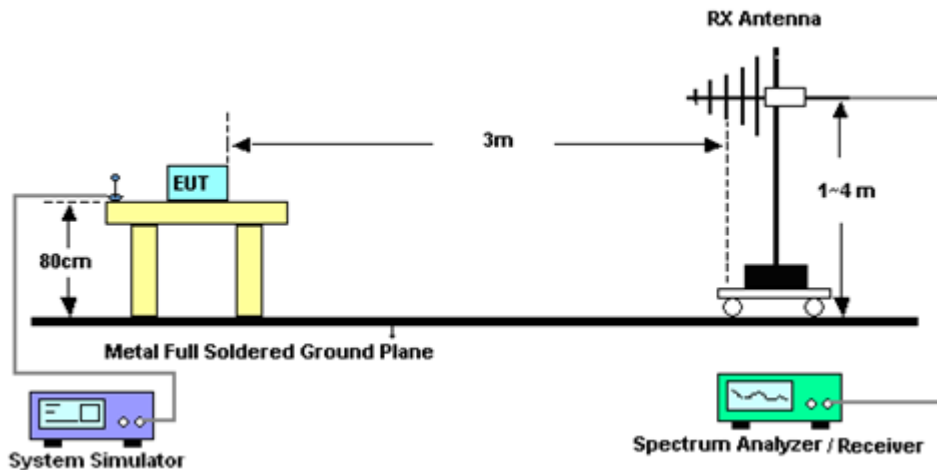

For radiated test from 1GHz to 18GHz

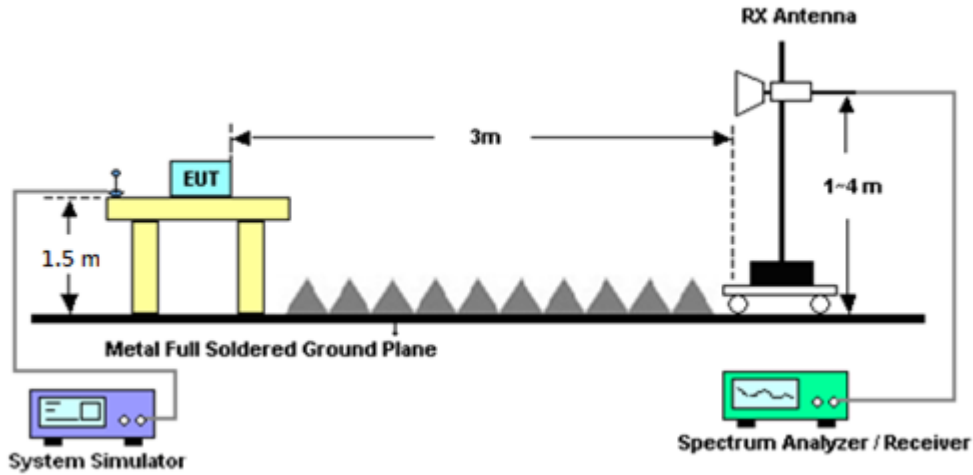

For radiated test above 18GHz

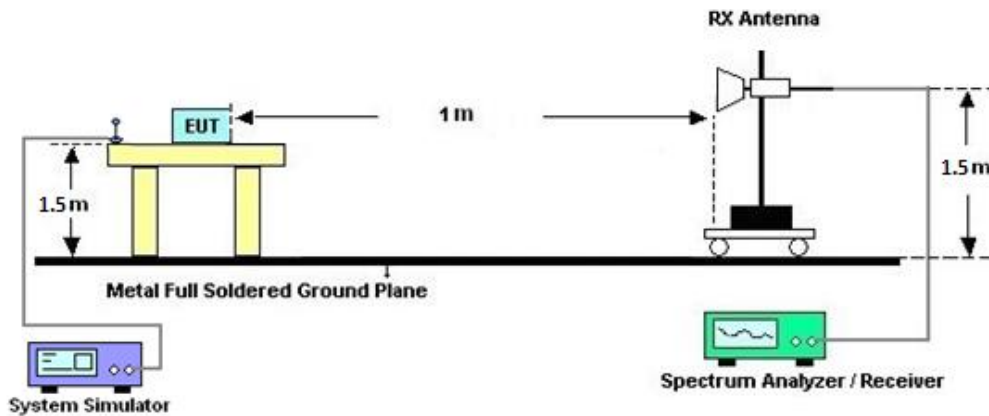

4.1.2 Test Result of Radiated Test

Please refer to Appendix B.

Note:

The low frequency, which started from 9 kHz to 30MHz, was pre-scanned and the result which was 20dB lower than the limit line was not reported.

There is adequate comparison measurement of both open-field test site and alternative test site - semi-Anechoic chamber according to 414788 D01 Radiated Test Site v01r01, and the result came out very similar.



4.2 Radiated Spurious Emission Measurement

4.2.1 Description of Radiated Spurious Emission Measurement

The radiated spurious emission was measured by substitution method according to ANSI / TIA-603-E. The power of any emission outside of the authorized operating frequency ranges must be attenuated below the transmitter power (P) by a factor of at least $43 + 10 \log (P)$ dB. The spectrum is scanned from 30 MHz up to a frequency including its 10th harmonic.

4.2.2 Test Procedures

The testing follows FCC KDB 971168 D01 v03r01 Section 7 and ANSI / TIA-603-E Section 2.2.12.

1. The EUT was placed on a turntable with 0.8 meter for frequency below 1GHz and 1.5 meter for frequency above 1GHz respectively above ground.
2. The EUT was set 3 meters from the receiving antenna, which was mounted on the antenna tower.
3. The table was rotated 360 degrees to determine the position of the highest spurious emission.
4. The height of the receiving antenna is varied between one meter and four meters to search the maximum spurious emission for both horizontal and vertical polarizations.
5. Make the measurement with the spectrum analyzer's RBW = 1MHz, VBW = 3MHz, taking the record of maximum spurious emission.
6. A horn antenna was substituted in place of the EUT and was driven by a signal generator.
7. Tune the output power of signal generator to the same emission level with EUT maximum spurious emission.
8. Taking the record of output power at antenna port.
9. Repeat step 7 to step 8 for another polarization.
10. The RF fundamental frequency should be excluded against the limit line in the operating frequency band.

The limit line is derived from $43 + 10\log(P)$ dB below the transmitter power P(Watts)

$EIRP \text{ (dBm)} = S.G. \text{ Power} - Tx \text{ Cable Loss} + Tx \text{ Antenna Gain}$

$ERP \text{ (dBm)} = EIRP - 2.15$



5 List of Measuring Equipment

Instrument	Brand Name	Model No.	Serial No.	Characteristics	Calibration Date	Test Date	Due Date	Remark
Loop Antenna	Rohde & Schwarz	HFH2-Z2	100488	9 kHz~30 MHz	May 13, 2022	Nov. 23, 2022~ Nov. 24, 2022	May 12, 2023	Radiation (03CH12-HY)
Horn Antenna	SCHWARZBECK	BBHA 9120 D	9120D-1328	1GHz~18GHz	Dec. 03, 2021	Nov. 23, 2022~ Nov. 24, 2022	Dec. 02, 2022	Radiation (03CH12-HY)
Bilog Antenna	TESEQ	CBL 6111D & 00800N1D01N-06	40103 & 07	30MHz~1GHz	Apr. 24, 2022	Nov. 23, 2022~ Nov. 24, 2022	Apr. 23, 2023	Radiation (03CH12-HY)
Bilog Antenna	TESEQ	CBL 6111D & N-6-06	35414 & AT-N0602	30MHz~1GHz	Oct. 08, 2022	Nov. 23, 2022~ Nov. 24, 2022	Oct. 07, 2023	Radiation (03CH12-HY)
Horn Antenna	SCHWARZBECK	BBHA 9120 D	9120D-1212	1GHz~18GHz	Mar. 10, 2022	Nov. 23, 2022~ Nov. 24, 2022	Mar. 09, 2023	Radiation (03CH12-HY)
SHF-EHF Horn Antenna	SCHWARZBECK	BBHA 9170	BBHA9170251	18GHz~40GHz	Nov. 30, 2021	Nov. 23, 2022~ Nov. 24, 2022	Nov. 29, 2022	Radiation (03CH12-HY)
SHF-EHF Horn Antenna	SCHWARZBECK	BBHA 9170	BBHA9170576	18GHz~40GHz	May 14, 2022	Nov. 23, 2022~ Nov. 24, 2022	May 13, 2023	Radiation (03CH12-HY)
Preamplifier	COM-POWER	PA-103	161075	10MHz~1GHz	Mar. 23, 2022	Nov. 23, 2022~ Nov. 24, 2022	Mar. 22, 2023	Radiation (03CH12-HY)
Preamplifier	Aglient	8449B	3008A02375	1GHz~26.5GHz	May 24, 2022	Nov. 23, 2022~ Nov. 24, 2022	May 23, 2023	Radiation (03CH12-HY)
Preamplifier	E-INSTRUMENT TECH LTD.	ERA-100M-18G-5 6-01-A70	EC1900249	1GHz-18GHz	Dec. 22, 2021	Nov. 23, 2022~ Nov. 24, 2022	Dec. 21, 2022	Radiation (03CH12-HY)
Preamplifier	E-INSTRUMENT TECH LTD.	ERA-100M-18G-5 6-01-A70	EC1900269	1GHz-18GHz	Dec. 27, 2021	Nov. 23, 2022~ Nov. 24, 2022	Dec. 26, 2022	Radiation (03CH12-HY)
Preamplifier	EMEC	EM18G40G	060715	18GHz~40GHz	Dec. 24, 2021	Nov. 23, 2022~ Nov. 24, 2022	Dec. 23, 2022	Radiation (03CH12-HY)
Spectrum Analyzer	Keysight	N9010A	MY53470118	10Hz~44GHz	Jan. 12, 2022	Nov. 23, 2022~ Nov. 24, 2022	Jan. 11, 2023	Radiation (03CH12-HY)
RF Cable	HUBER + SUHNER	SUCOFLEX 104	MY9837/4PE	9kHz~30MHz	Mar. 10, 2022	Nov. 23, 2022~ Nov. 24, 2022	Mar. 09, 2023	Radiation (03CH12-HY)
RF Cable	HUBER + SUHNER	SUCOFLEX 126E	0058/126E	30MHz~18GHz	Dec. 10, 2021	Nov. 23, 2022~ Nov. 24, 2022	Dec. 09, 2022	Radiation (03CH12-HY)
RF Cable	HUBER + SUHNER	SUCOFLEX 102	505134/2	30MHz~40GHz	Feb. 21, 2022	Nov. 23, 2022~ Nov. 24, 2022	Feb. 20, 2023	Radiation (03CH12-HY)
RF Cable	HUBER + SUHNER	SUCOFLEX 102	803953/2	30MHz~40GHz	Mar. 08, 2022	Nov. 23, 2022~ Nov. 24, 2022	Mar. 07, 2023	Radiation (03CH12-HY)
Filter	Wainwright	WHKX8-5872.5-6 750-18000-40ST	SN2	6.75GHz High Pass Filter	Mar. 15, 2022	Nov. 23, 2022~ Nov. 24, 2022	Mar. 14, 2023	Radiation (03CH12-HY)
Hygrometer	TECPEL	DTM-303B	TP140325	N/A	Nov. 26, 2021	Nov. 23, 2022~ Nov. 24, 2022	Nov. 25, 2022	Radiation (03CH12-HY)
Controller	EMEC	EM1000	N/A	Control Turn table & Ant Mast	N/A	Nov. 23, 2022~ Nov. 24, 2022	N/A	Radiation (03CH12-HY)
Antenna Mast	EMEC	AM-BS-4500-B	N/A	1m~4m	N/A	Nov. 23, 2022~ Nov. 24, 2022	N/A	Radiation (03CH12-HY)
Turn Table	EMEC	TT2000	N/A	0~360 Degree	N/A	Nov. 23, 2022~ Nov. 24, 2022	N/A	Radiation (03CH12-HY)
Software	Audix	E3 6.2009-8-24	RK-000989	N/A	N/A	Nov. 23, 2022~ Nov. 24, 2022	N/A	Radiation (03CH12-HY)



Instrument	Brand Name	Model No.	Serial No.	Characteristics	Calibration Date	Test Date	Due Date	Remark
Radio Communication Analyzer	Anritsu	MT8821C	6262025280	LTE FDD/TDD LTE-2CC DLCA/ULCA	Oct. 29, 2021	Aug. 13, 2022~ Oct. 27, 2022	Oct. 28, 2022	Conducted (TH03-HY)
Radio Communication Analyzer	Anritsu	MT8821C	6262025353	LTE FDD/TDD LTE-2CC DLCA/ULCA	Oct. 13, 2022	Oct. 28, 2022~ Dec. 03, 2022	Oct. 12, 2023	Conducted (TH03-HY)
Spectrum Analyzer	Rohde & Schwarz	FSV40	101908	10Hz~40GHz	Oct. 01, 2021	Aug. 13, 2022~ Sep. 26, 2022	Sep. 30, 2022	Conducted (TH03-HY)
Spectrum Analyzer	Rohde & Schwarz	FSV40	101908	10Hz~40GHz	Sep. 27, 2022	Oct. 28, 2022~ Dec. 03, 2022	Sep. 26, 2023	Conducted (TH03-HY)
Thermal Chamber	ESPEC	SH-641	92013720	-40°C ~90°C	Sep. 09, 2021	Aug. 13, 2022~ Sep. 07, 2022	Sep. 08, 2022	Conducted (TH03-HY)
Thermal Chamber	ESPEC	SH-641	92013720	-40°C ~90°C	Sep. 07, 2022	Sep. 08, 2022~ Dec. 03, 2022	Sep. 06, 2023	Conducted (TH03-HY)
DC Power Supply	GW Instek	GPP-2323	GES906037	0V~64V ; 0A~6A	Jan. 06, 2022	Aug. 13, 2022~ Dec. 03, 2022	Jan. 05, 2023	Conducted (TH03-HY)
Coupler	Warison	20dB 25W SMA Directional Coupler	#B	1-18GHz	Jan. 07, 2022	Aug. 13, 2022~ Dec. 03, 2022	Jan. 06, 2023	Conducted (TH03-HY)



6 Uncertainty of Evaluation

Uncertainty of Radiated Emission Measurement (30 MHz ~ 1000 MHz)

Measuring Uncertainty for a Level of Confidence of 95% ($U = 2Uc(y)$)	3.31 dB
---	---------

Uncertainty of Radiated Emission Measurement (1 GHz ~ 18 GHz)

Measuring Uncertainty for a Level of Confidence of 95% ($U = 2Uc(y)$)	3.25 dB
---	---------

Uncertainty of Radiated Emission Measurement (18 GHz ~ 40 GHz)

Measuring Uncertainty for a Level of Confidence of 95% ($U = 2Uc(y)$)	3.81 dB
---	---------



Appendix A. Test Results of Conducted Test

Conducted Output Power(Average power & EIRP)

LTE Band 42 Maximum Average Power [dBm] (GT - LC = 0.5 dB)								
BW [MHz]	RB Size	RB Offset	Mod	Lowest	Middle	Highest	EIRP (dBm)	EIRP (W)
20	1	0	QPSK	21.50	21.29	21.29	22.00	0.1585
20	1	49		21.42	21.37	21.16		
20	1	99		21.17	21.25	21.13		
20	50	0		20.37	20.45	20.40		
20	50	24		20.37	20.43	20.41		
20	50	50		20.39	20.28	20.29		
20	100	0		20.40	20.24	20.47		
20	1	0	16-QAM	20.40	20.35	20.12	20.90	0.1230
20	1	49		20.28	20.22	20.29		
20	1	99		20.18	20.18	20.00		
20	50	0		19.37	19.36	19.51		
20	50	24		19.42	19.31	19.21		
20	50	50		19.30	19.29	19.26		
20	100	0		19.36	19.32	19.33		
20	1	0	64-QAM	19.45	19.21	19.12	19.95	0.0989
20	1	49		19.19	19.19	19.30		
20	1	99		19.19	19.14	19.13		
20	50	0		18.52	18.49	18.30		
20	50	24		18.40	18.28	18.37		
20	50	50		18.50	18.40	18.21		
20	100	0		18.58	18.24	18.32		
20	1	0	256-QAM	16.45	16.40	16.23	16.95	0.0495
20	1	49		16.27	16.35	16.38		
20	1	99		16.37	16.44	16.38		
20	50	0		16.26	16.11	16.22		
20	50	24		16.40	16.20	16.19		
20	50	50		16.14	16.06	16.11		
20	100	0		16.15	15.91	16.26		
Limit	EIRP < 1W			Result			Pass	



LTE Band 42 Maximum Average Power [dBm] (GT - LC = 0.5 dB)								
BW [MHz]	RB Size	RB Offset	Mod	Lowest	Middle	Highest	EIRP (dBm)	EIRP (W)
15	1	0	QPSK	21.31	21.21	21.20	21.82	0.1521
15	1	37		21.32	21.31	21.16		
15	1	74		21.20	21.22	21.17		
15	36	0		20.46	20.53	20.32		
15	36	20		20.38	20.27	20.39		
15	36	39		20.25	20.21	20.28		
15	75	0		20.51	20.31	20.42		
15	1	0	16-QAM	20.40	20.38	20.26	20.90	0.1230
15	1	37		20.34	20.17	20.26		
15	1	74		20.19	20.02	20.02		
15	36	0		19.49	19.40	19.35		
15	36	20		19.39	19.31	19.33		
15	36	39		19.39	19.31	19.26		
15	75	0		19.53	19.18	19.32		
15	1	0	64-QAM	19.35	19.20	19.26	19.85	0.0966
15	1	37		19.33	19.20	19.23		
15	1	74		19.20	19.20	19.19		
15	36	0		18.41	18.51	18.27		
15	36	20		18.41	18.33	18.27		
15	36	39		18.35	18.25	18.35		
15	75	0		18.45	18.34	18.23		
15	1	0	256-QAM	16.55	16.50	16.21	17.05	0.0507
15	1	37		16.24	16.31	16.21		
15	1	74		16.38	16.32	16.21		
15	36	0		16.31	16.20	16.26		
15	36	20		16.38	16.17	16.21		
15	36	39		16.04	16.00	16.08		
15	75	0		16.05	15.93	16.14		
Limit	EIRP < 1W			Result			Pass	



LTE Band 42 Maximum Average Power [dBm] (GT - LC = 0.5 dB)								
BW [MHz]	RB Size	RB Offset	Mod	Lowest	Middle	Highest	EIRP (dBm)	EIRP (W)
10	1	0	QPSK	21.32	21.29	21.11	21.82	0.1521
10	1	25		21.21	21.27	21.21		
10	1	49		21.06	21.01	21.12		
10	25	0		20.32	20.48	20.27		
10	25	12		20.28	20.30	20.37		
10	25	25		20.30	20.30	20.11		
10	50	0		20.36	20.16	20.32		
10	1	0	16-QAM	20.38	20.44	20.20	20.94	0.1242
10	1	25		20.29	20.25	20.10		
10	1	49		20.21	20.19	20.12		
10	25	0		19.41	19.32	19.43		
10	25	12		19.28	19.29	19.25		
10	25	25		19.27	19.38	19.21		
10	50	0		19.31	19.18	19.36		
10	1	0	64-QAM	19.34	19.26	19.04	19.84	0.0964
10	1	25		19.21	19.25	19.18		
10	1	49		19.14	19.09	19.17		
10	25	0		18.43	18.34	18.24		
10	25	12		18.38	18.20	18.21		
10	25	25		18.26	18.20	18.30		
10	50	0		18.34	18.21	18.18		
10	1	0	256-QAM	16.39	16.34	16.11	16.89	0.0489
10	1	25		16.20	16.23	16.15		
10	1	49		16.35	16.24	16.26		
10	25	0		16.21	16.02	16.18		
10	25	12		16.34	16.03	16.17		
10	25	25		16.17	15.83	16.12		
10	50	0		16.19	15.85	16.13		
Limit	EIRP < 1W			Result			Pass	



LTE Band 42 Maximum Average Power [dBm] (GT - LC = 0.5 dB)								
BW [MHz]	RB Size	RB Offset	Mod	Lowest	Middle	Highest	EIRP (dBm)	EIRP (W)
5	1	0	QPSK	21.37	21.27	21.19	21.88	0.1542
5	1	12		21.38	21.30	21.09		
5	1	24		21.15	21.23	21.09		
5	12	0		20.48	20.49	20.34		
5	12	7		20.41	20.44	20.35		
5	12	13		20.18	20.17	20.22		
5	25	0		20.54	20.28	20.45		
5	1	0	16-QAM	20.45	20.39	20.17	20.95	0.1245
5	1	12		20.38	20.12	20.23		
5	1	24		20.13	20.04	20.05		
5	12	0		19.49	19.31	19.40		
5	12	7		19.35	19.31	19.21		
5	12	13		19.41	19.36	19.12		
5	25	0		19.34	19.17	19.33		
5	1	0	64-QAM	19.27	19.33	19.16	19.84	0.0964
5	1	12		19.34	19.23	19.22		
5	1	24		19.08	19.23	19.08		
5	12	0		18.44	18.46	18.26		
5	12	7		18.47	18.34	18.29		
5	12	13		18.37	18.35	18.31		
5	25	0		18.56	18.32	18.24		
5	1	0	256-QAM	16.39	16.43	16.27	16.93	0.0493
5	1	12		16.17	16.32	16.26		
5	1	24		16.23	16.31	16.35		
5	12	0		16.16	16.12	16.16		
5	12	7		16.31	16.03	16.20		
5	12	13		16.07	15.91	16.02		
5	25	0		16.13	15.91	16.06		
Limit	EIRP < 1W			Result			Pass	



LTE Band 42C_CA Maximum Average Power [dBm] (GT - LC = 0.5 dB)										
BW [MHz]	PCC		SCC		Mod	Lowest	Middle	Highest	EIRP (dBm)	EIRP (W)
	RB Size	RB Offset	RB Size	RB Offset						
20+20	100	0	100	0	QPSK	20.78	20.65	20.65	23.05	0.2018
20+20	1	0	1	99		14.39	14.20	14.16		
20+20	1	99	1	0		22.55	22.41	22.42		
20+20	100	0	100	0	16-QAM	19.78	19.66	19.64	22.58	0.1811
20+20	1	0	1	99		14.67	14.60	14.59		
20+20	1	99	1	0		22.08	21.95	22.01		
20+20	100	0	100	0	64-QAM	19.79	19.67	19.61	21.61	0.1449
20+20	1	0	1	99		14.70	14.66	14.56		
20+20	1	99	1	0		21.11	20.88	21.00		
20+20	100	0	100	0	256-QAM	17.77	17.66	17.63	18.43	0.0697
20+20	1	0	1	99		14.49	14.45	14.40		
20+20	1	99	1	0		17.93	17.77	17.81		
20+15	100	0	75	0	QPSK	20.76	20.64	20.63	23.16	0.2070
20+15	1	0	1	74		14.40	14.24	14.17		
20+15	1	74	1	0		22.66	22.36	22.40		
20+15	100	0	75	0	16-QAM	19.77	19.64	19.63	22.67	0.1849
20+15	1	0	1	74		14.78	14.69	14.63		
20+15	1	74	1	0		22.17	21.97	21.90		
20+15	100	0	75	0	64-QAM	19.77	19.63	19.64	21.67	0.1469
20+15	1	0	1	74		14.76	14.54	14.60		
20+15	1	74	1	0		21.17	20.93	20.94		
20+15	100	0	75	0	256-QAM	17.77	17.62	17.62	18.42	0.0695
20+15	1	0	1	74		14.64	14.53	14.44		
20+15	1	74	1	0		17.92	17.70	17.74		
15+20	75	0	100	0	QPSK	20.79	20.64	20.64	23.21	0.2094
15+20	1	0	1	99		14.34	14.18	14.14		
15+20	1	74	1	0		22.71	22.40	22.44		
15+20	75	0	100	0	16-QAM	19.76	19.64	19.64	22.65	0.1841
15+20	1	0	1	99		14.76	14.59	14.56		
15+20	1	74	1	0		22.15	21.96	21.91		
15+20	75	0	100	0	64-QAM	19.78	19.66	19.66	21.62	0.1452
15+20	1	0	1	99		14.66	14.64	14.54		
15+20	1	74	1	0		21.12	20.99	20.95		
15+20	75	0	100	0	256-QAM	17.78	17.64	17.64	18.39	0.0690
15+20	1	0	1	99		14.44	14.53	14.26		
15+20	1	74	1	0		17.89	17.79	17.74		
Limit	EIRP < 1W					Result			Pass	



LTE Band 42C_CA Maximum Average Power [dBm] (GT - LC = 0.5 dB)										
BW [MHz]	PCC		SCC		Mod	Lowest	Middle	Highest	EIRP (dBm)	EIRP (W)
	RB Size	RB Offset	RB Size	RB Offset						
20+10	100	0	50	0	QPSK	20.77	20.64	20.65	23.14	0.2061
20+10	1	0	1	49		14.41	14.28	14.22		
20+10	1	99	1	0		22.64	22.39	22.36		
20+10	100	0	50	0	16-QAM	19.78	19.67	19.64	22.67	0.1849
20+10	1	0	1	49		14.78	14.64	14.68		
20+10	1	99	1	0		22.17	21.89	21.96		
20+10	100	0	50	0	64-QAM	19.78	19.62	19.63	21.62	0.1452
20+10	1	0	1	49		14.77	14.61	14.61		
20+10	1	99	1	0		21.12	21.02	21.00		
20+10	100	0	50	0	256-QAM	17.76	17.63	17.62	18.53	0.0713
20+10	1	0	1	49		14.52	14.42	14.44		
20+10	1	99	1	0		18.03	17.82	17.72		
10+20	50	0	100	0	QPSK	20.80	20.66	20.65	23.23	0.2104
10+20	1	0	1	99		14.42	14.27	14.22		
10+20	1	49	1	0		22.73	22.46	22.48		
10+20	50	0	100	0	16-QAM	19.80	19.68	19.67	22.71	0.1866
10+20	1	0	1	99		14.79	14.67	14.61		
10+20	1	49	1	0		22.21	22.10	21.96		
10+20	50	0	100	0	64-QAM	19.83	19.67	19.66	21.67	0.1469
10+20	1	0	1	99		14.74	14.64	14.61		
10+20	1	49	1	0		21.17	20.99	21.08		
10+20	50	0	100	0	256-QAM	17.81	17.67	17.67	18.51	0.0710
10+20	1	0	1	99		14.66	14.52	14.50		
10+20	1	49	1	0		18.01	17.66	17.74		
20+5	100	0	25	0	QPSK	20.77	20.65	20.75	23.15	0.2065
20+5	1	0	1	24		14.41	14.25	14.38		
20+5	1	99	1	0		22.65	22.43	22.64		
20+5	100	0	25	0	16-QAM	19.79	19.66	19.77	22.69	0.1858
20+5	1	0	1	24		14.69	14.70	14.62		
20+5	1	99	1	0		22.19	22.06	22.12		
20+5	100	0	25	0	64-QAM	19.77	19.65	19.72	21.61	0.1449
20+5	1	0	1	24		14.77	14.62	14.77		
20+5	1	99	1	0		21.11	21.05	21.04		
20+5	100	0	25	0	256-QAM	17.80	17.65	17.90	18.53	0.0713
20+5	1	0	1	24		14.57	14.45	14.65		
20+5	1	99	1	0		17.99	17.85	18.03		
Limit	EIRP < 1W					Result			Pass	



LTE Band 42C_CA Maximum Average Power [dBm] (GT - LC = 0.5 dB)										
BW [MHz]	PCC		SCC		Mod	Lowest	Middle	Highest	EIRP (dBm)	EIRP (W)
	RB Size	RB Offset	RB Size	RB Offset						
5+20	25	0	100	0	QPSK	20.78	20.62	20.63	23.29	0.2133
5+20	1	0	1	99		14.36	14.14	14.16		
5+20	1	24	1	0		22.79	22.48	22.44		
5+20	25	0	100	0	16-QAM	19.79	19.65	19.67	22.67	0.1849
5+20	1	0	1	99		14.84	14.61	14.60		
5+20	1	24	1	0		22.17	22.05	21.97		
5+20	25	0	100	0	64-QAM	19.81	19.65	19.66	21.69	0.1476
5+20	1	0	1	99		14.67	14.71	14.65		
5+20	1	24	1	0		21.19	21.06	21.03		
5+20	25	0	100	0	256-QAM	17.81	17.65	17.64	18.62	0.0728
5+20	1	0	1	99		14.61	14.38	14.45		
5+20	1	24	1	0		18.12	17.85	17.83		
Limit	EIRP < 1W				Result			Pass		



LTE Band 42

Peak-to-Average Ratio

Mode	LTE Band 42 / 20MHz				
Mod.	QPSK	16QAM	64QAM	256QAM	Limit: 13dB
RB Size	Full RB	Full RB	Full RB	Full RB	Result
Middle CH	4.58	5.71	6.35	6.61	PASS

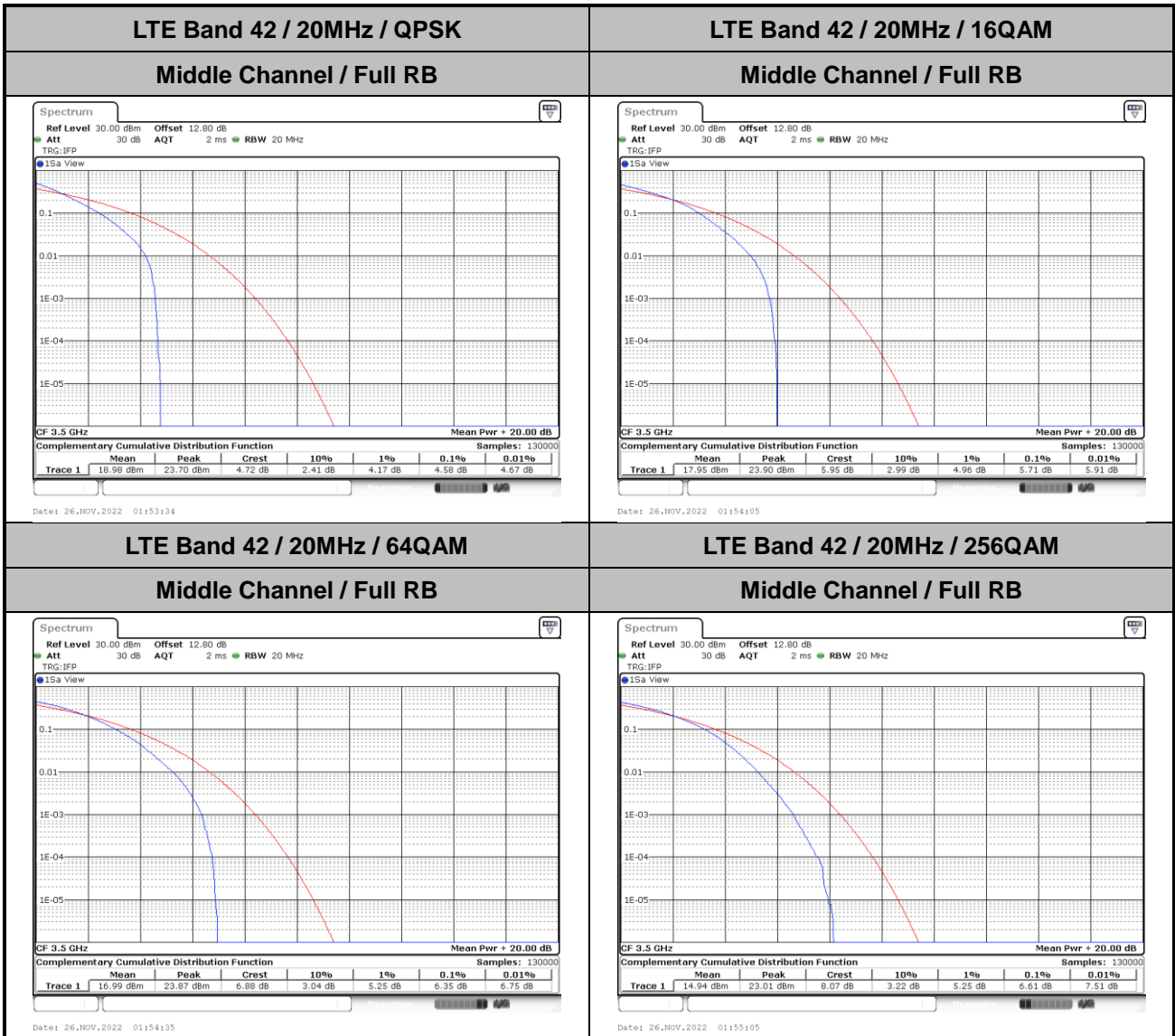



26dB Bandwidth

Mode	LTE Band 42 : 26dB BW(MHz)											
BW	1.4MHz		3MHz		5MHz		10MHz		15MHz		20MHz	
Mod.	QPSK	16QAM	QPSK	16QAM	QPSK	16QAM	QPSK	16QAM	QPSK	16QAM	QPSK	16QAM
Middle CH	-	-	-	-	5.03	4.90	9.91	9.81	14.30	14.18	18.74	18.70
Mode	LTE Band 42 : 26dB BW(MHz)											
BW	1.4MHz		3MHz		5MHz		10MHz		15MHz		20MHz	
Mod.	64QAM	256QAM	64QAM	256QAM	64QAM	256QAM	64QAM	256QAM	64QAM	256QAM	64QAM	256QAM
Middle CH	-	-	-	-	4.86	4.81	9.77	9.91	14.36	14.48	18.86	18.86



LTE Band 42

Middle Channel / 5MHz / QPSK

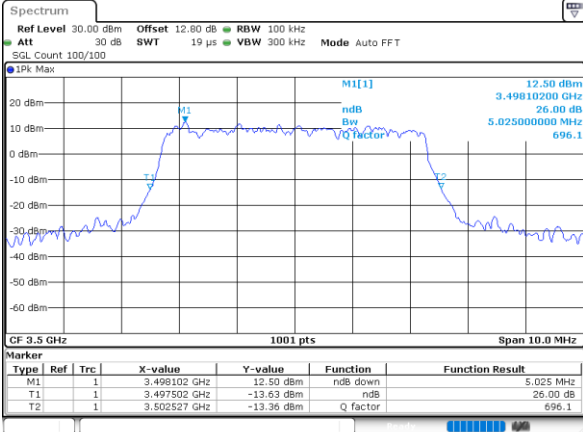

Date: 24.NOV.2022 10:24:56

Middle Channel / 5MHz / 16QAM

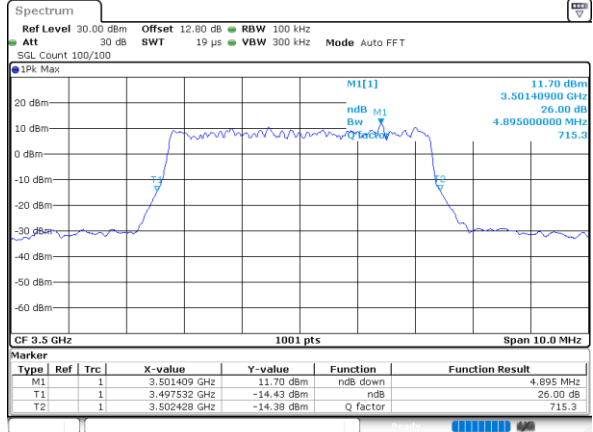

Date: 24.NOV.2022 10:25:25

Middle Channel / 10MHz / QPSK

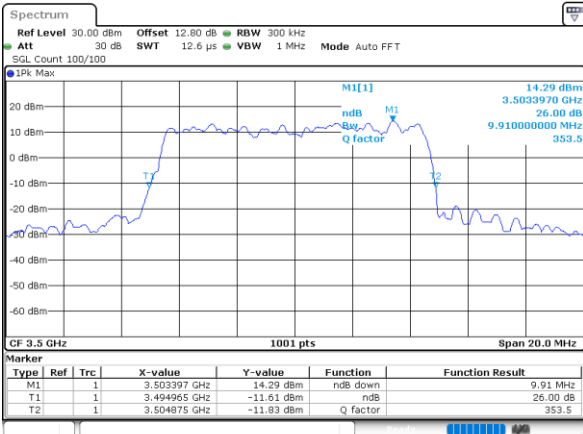

Date: 26.NOV.2022 01:45:02

Middle Channel / 10MHz / 16QAM

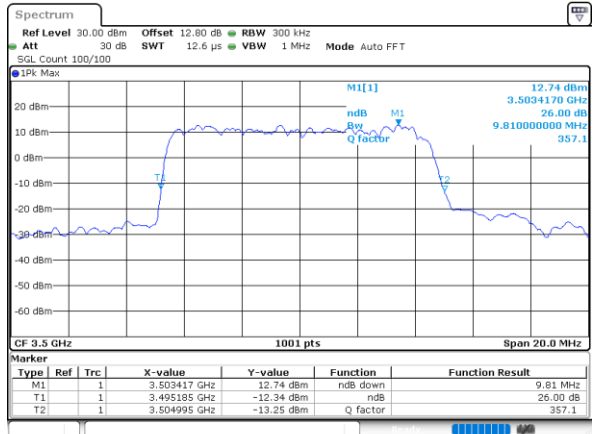

Date: 26.NOV.2022 01:45:31

Middle Channel / 15MHz / QPSK

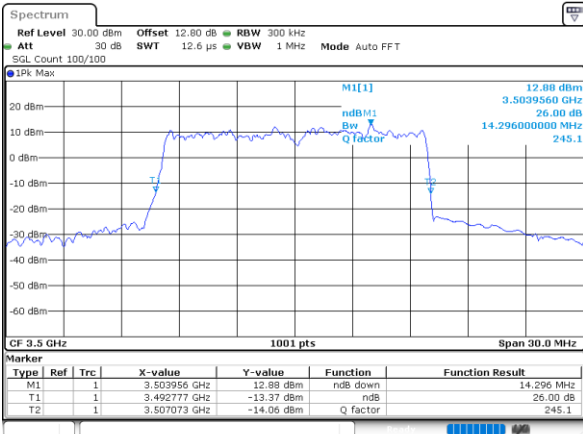

Date: 26.NOV.2022 01:47:59

Middle Channel / 15MHz / 16QAM

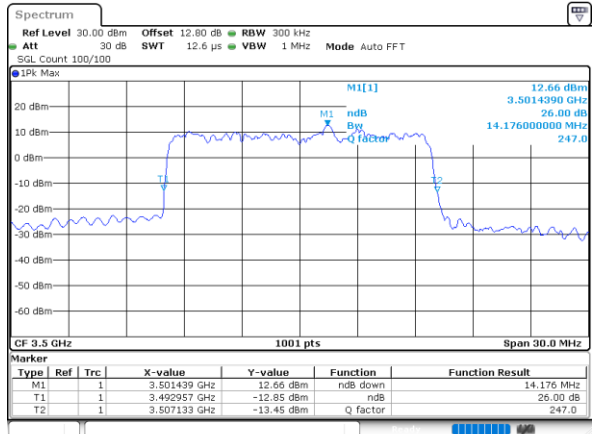

Date: 26.NOV.2022 01:48:28



LTE Band 42

Middle Channel / 20MHz / QPSK

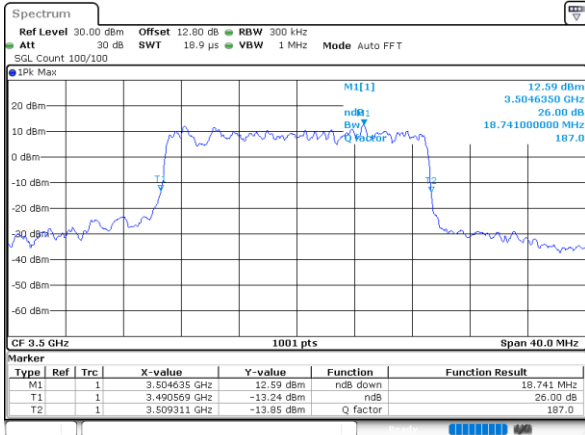

Date: 26.NOV.2022 01:50:56

Middle Channel / 20MHz / 16QAM

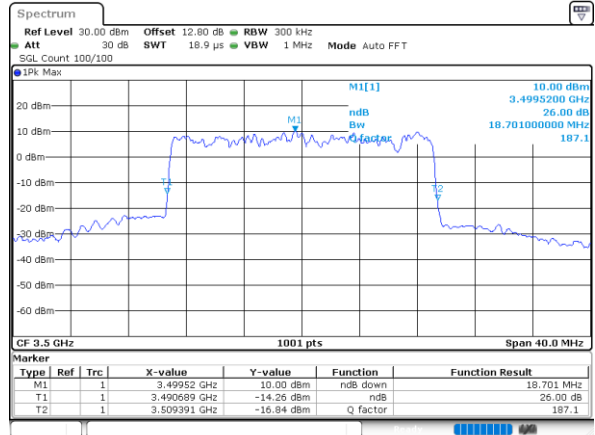

Date: 26.NOV.2022 01:51:25

Middle Channel / 5MHz / 64QAM

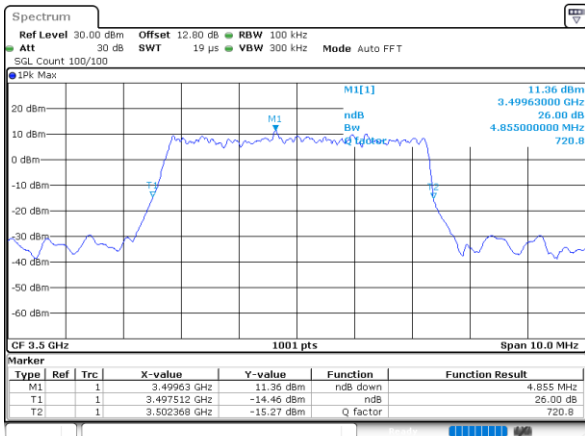

Date: 26.NOV.2022 01:43:30

Middle Channel / 10MHz / 64QAM

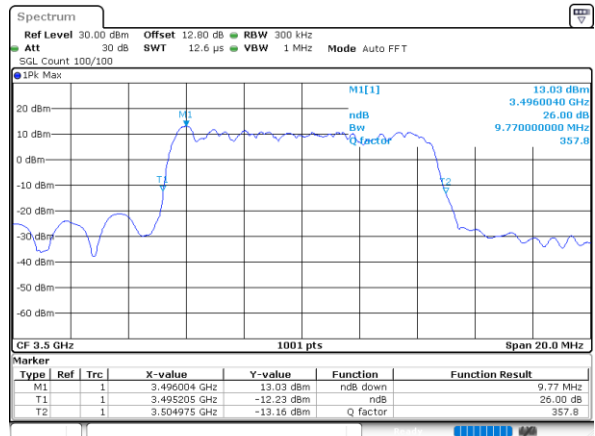

Date: 26.NOV.2022 01:46:27

Middle Channel / 15MHz / 64QAM

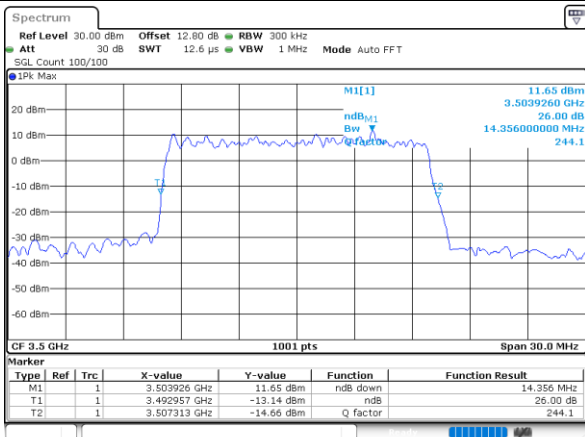

Date: 26.NOV.2022 01:49:25

Middle Channel / 20MHz / 64QAM

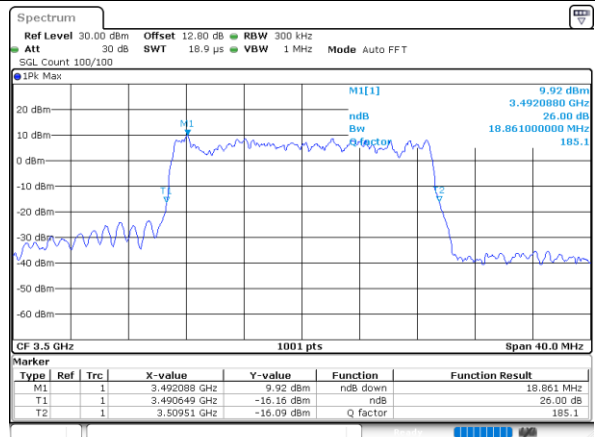

Date: 26.NOV.2022 01:52:22



LTE Band 42

Middle Channel / 5MHz / 256QAM

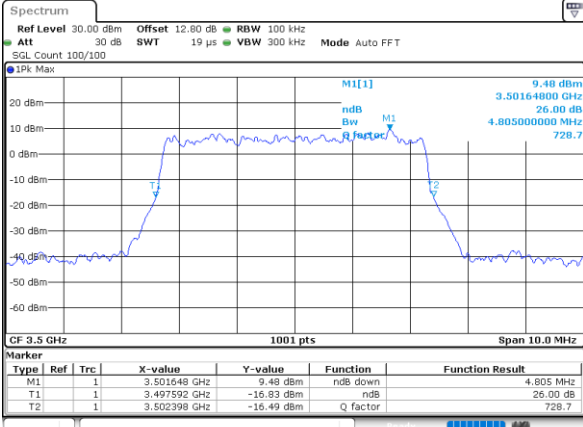

Date: 26.NOV.2022 01:43:59

Middle Channel / 10MHz / 256QAM

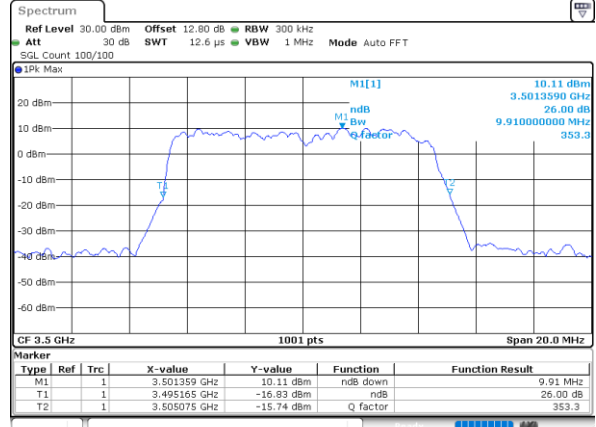

Date: 26.NOV.2022 01:46:56

Middle Channel / 15MHz / 256QAM

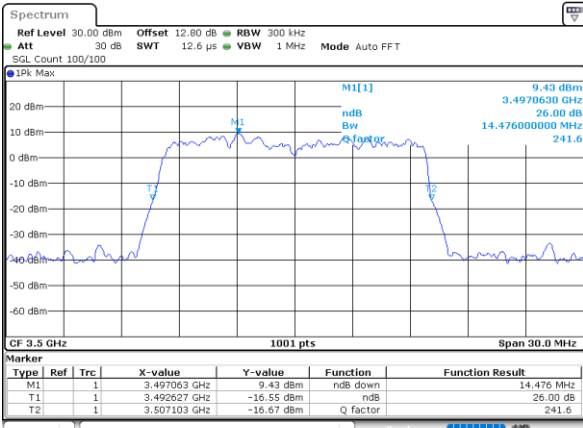

Date: 26.NOV.2022 01:49:53

Middle Channel / 20MHz / 256QAM

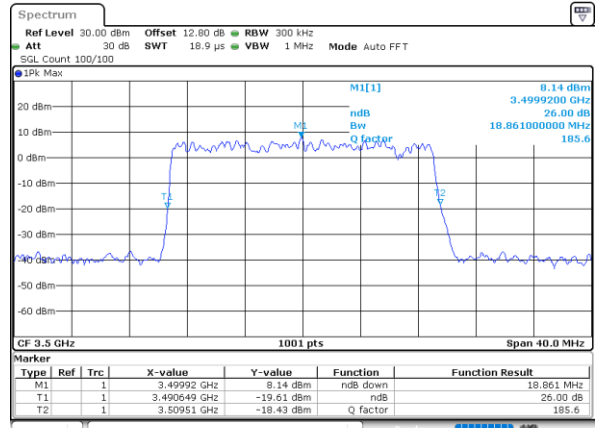

Date: 26.NOV.2022 01:52:50



Occupied Bandwidth

Mode	LTE Band 42 : 99%OBW(MHz)											
BW	1.4MHz		3MHz		5MHz		10MHz		15MHz		20MHz	
Mod.	QPSK	16QAM	QPSK	16QAM	QPSK	16QAM	QPSK	16QAM	QPSK	16QAM	QPSK	16QAM
Middle CH	-	-	-	-	4.50	4.50	9.05	8.99	13.49	13.43	17.82	17.94
Mode	LTE Band 42 : 99%OBW(MHz)											
BW	1.4MHz		3MHz		5MHz		10MHz		15MHz		20MHz	
Mod.	64QAM	256QAM	64QAM	256QAM	64QAM	256QAM	64QAM	256QAM	64QAM	256QAM	64QAM	256QAM
Middle CH	-	-	-	-	4.50	4.47	9.05	9.01	13.46	13.40	17.78	17.82



LTE Band 42

Middle Channel / 5MHz / QPSK

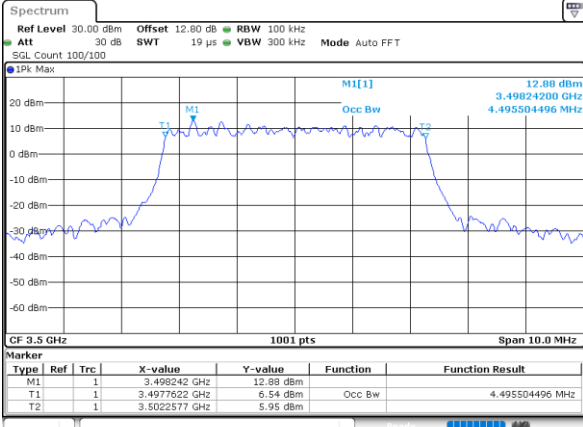

Date: 24.NOV.2022 10:24:41

Middle Channel / 5MHz / 16QAM

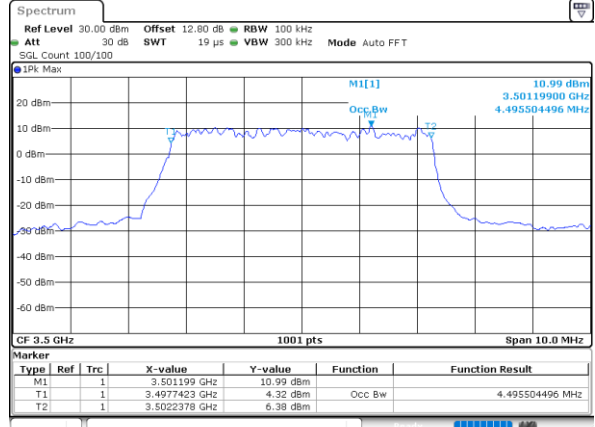

Date: 24.NOV.2022 10:25:43

Middle Channel / 10MHz / QPSK

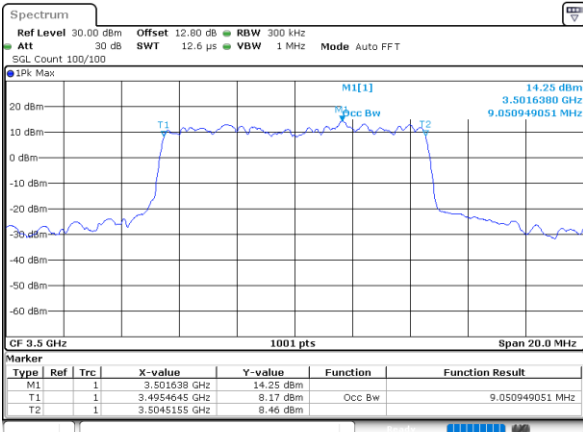

Date: 26.NOV.2022 01:44:48

Middle Channel / 10MHz / 16QAM

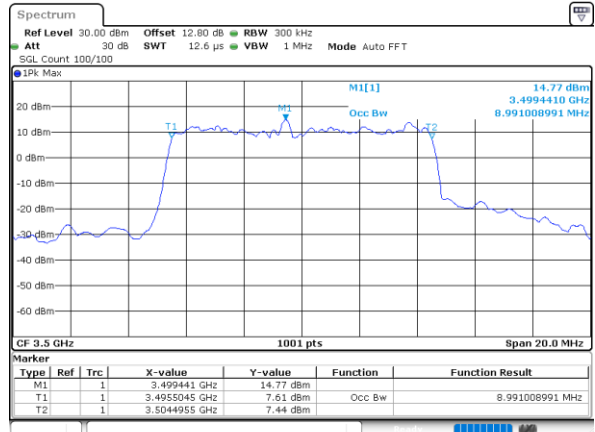

Date: 26.NOV.2022 01:45:45

Middle Channel / 15MHz / QPSK

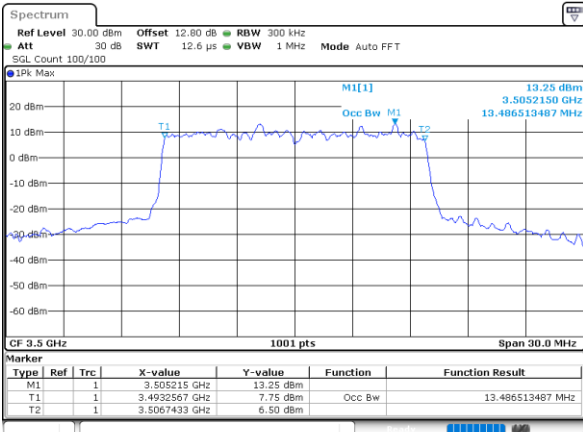

Date: 26.NOV.2022 01:47:45

Middle Channel / 15MHz / 16QAM

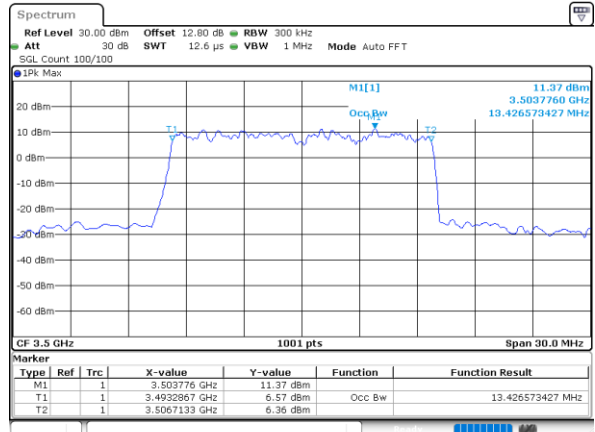

Date: 26.NOV.2022 01:48:42



LTE Band 42

Middle Channel / 20MHz / QPSK

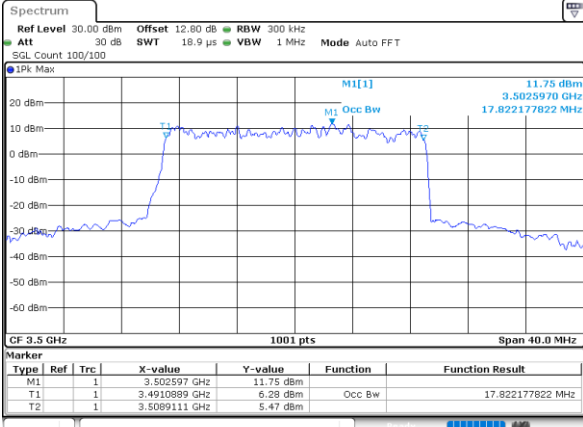

Date: 26.NOV.2022 01:50:42

Middle Channel / 20MHz / 16QAM

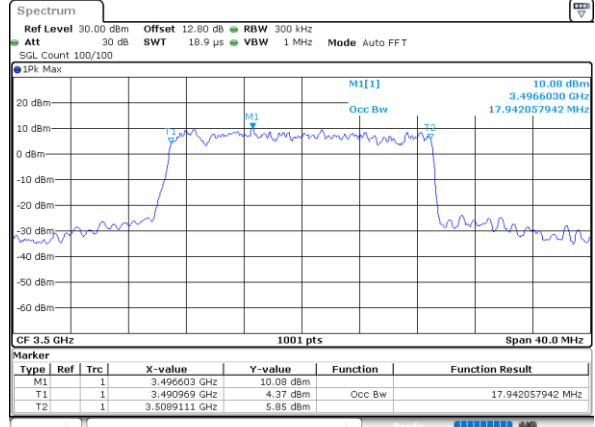

Date: 26.NOV.2022 01:51:39

Middle Channel / 5MHz / 64QAM

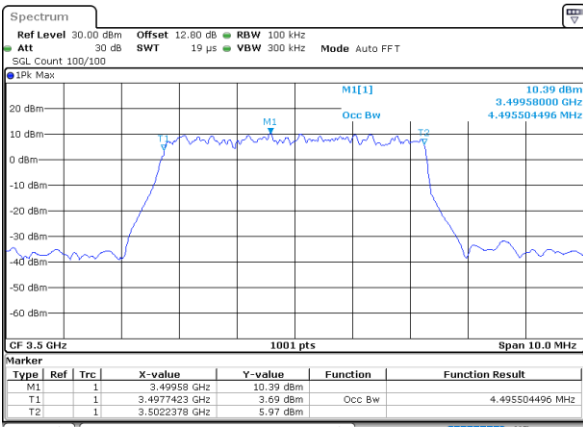

Date: 26.NOV.2022 01:43:16

Middle Channel / 10MHz / 64QAM

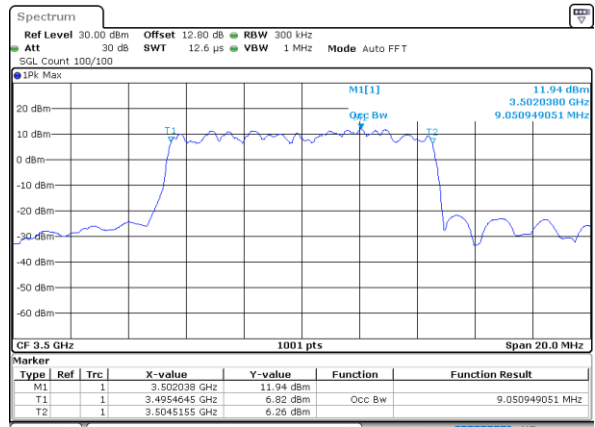

Date: 26.NOV.2022 01:46:13

Middle Channel / 15MHz / 64QAM

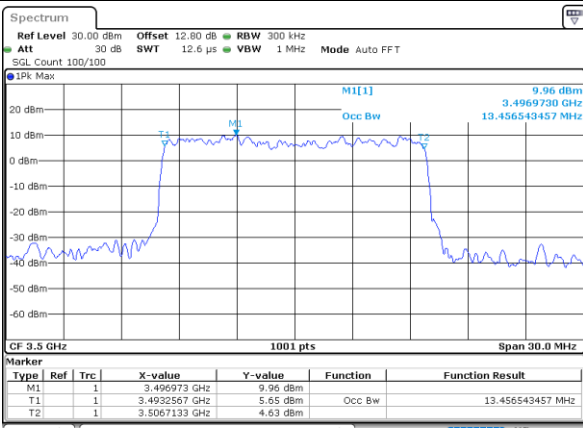

Date: 26.NOV.2022 01:49:10

Middle Channel / 20MHz / 64QAM

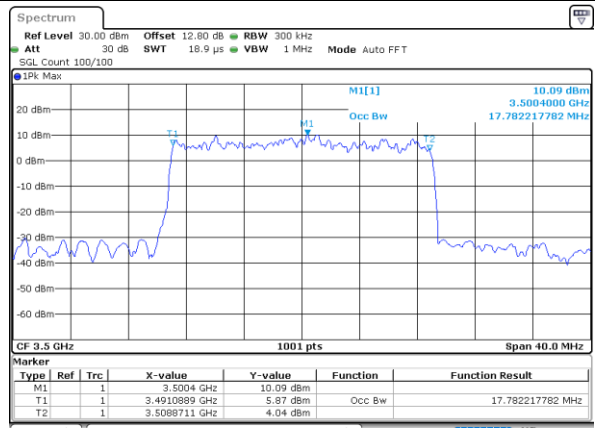

Date: 26.NOV.2022 01:52:08



LTE Band 42

Middle Channel / 5MHz / 256QAM

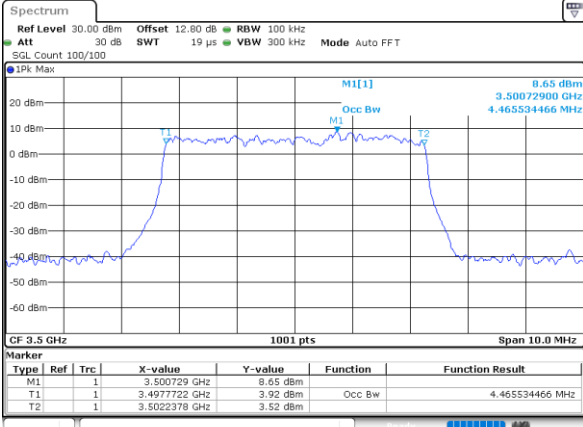

Date: 26.NOV.2022 01:44:13

Middle Channel / 10MHz / 256QAM

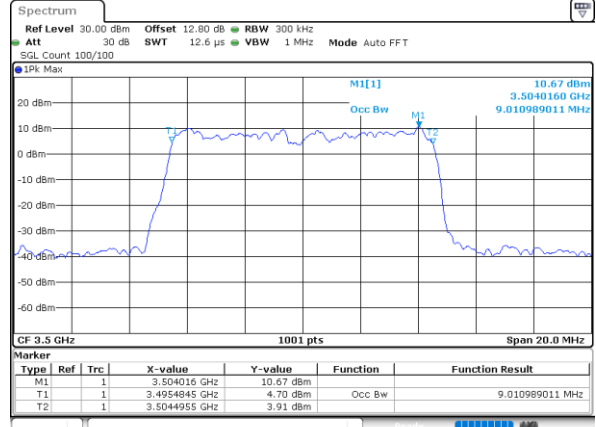

Date: 26.NOV.2022 01:47:10

Middle Channel / 15MHz / 256QAM

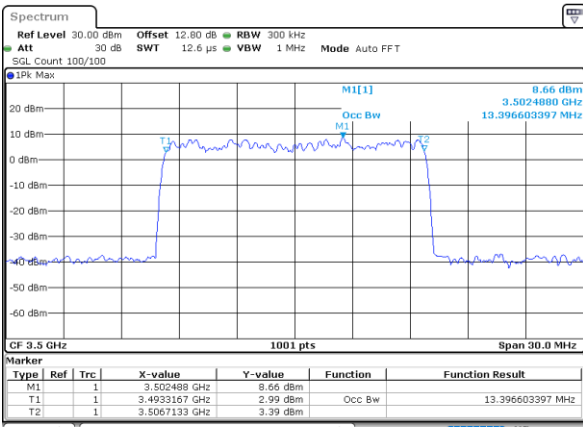

Date: 26.NOV.2022 01:50:07

Middle Channel / 20MHz / 256QAM

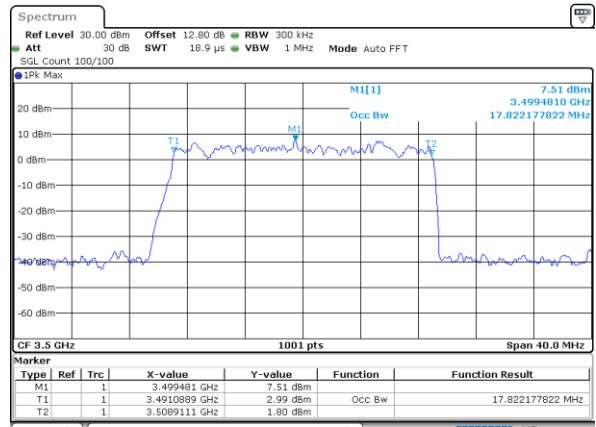

Date: 26.NOV.2022 01:53:05



Conducted Band Edge

LTE Band 42 / 5MHz / QPSK

Lowest Band Edge / 1 RB

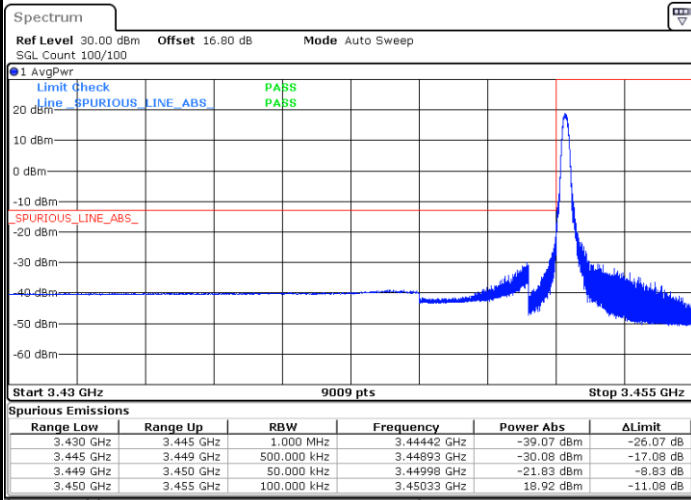

Date: 24.NOV.2022 08:10:55

Highest Band Edge / 1 RB

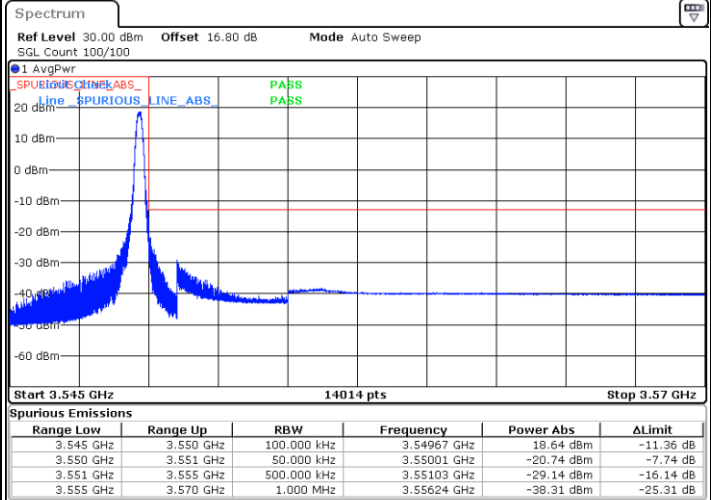

Date: 24.NOV.2022 08:20:13

Lowest Band Edge / Full RB

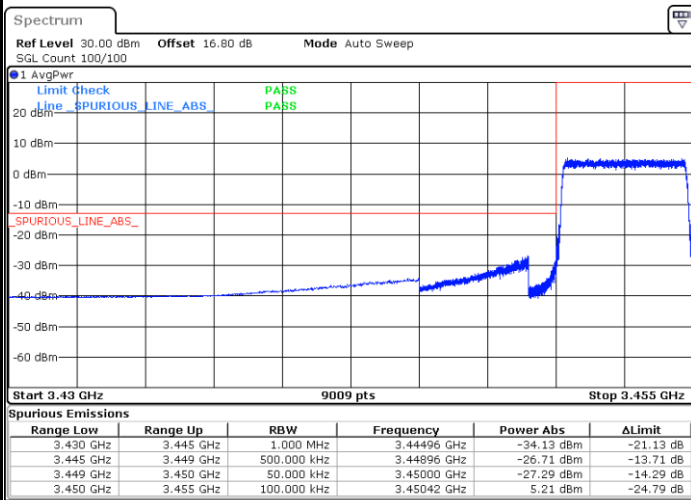

Date: 24.NOV.2022 10:30:19

Highest Band Edge / Full RB

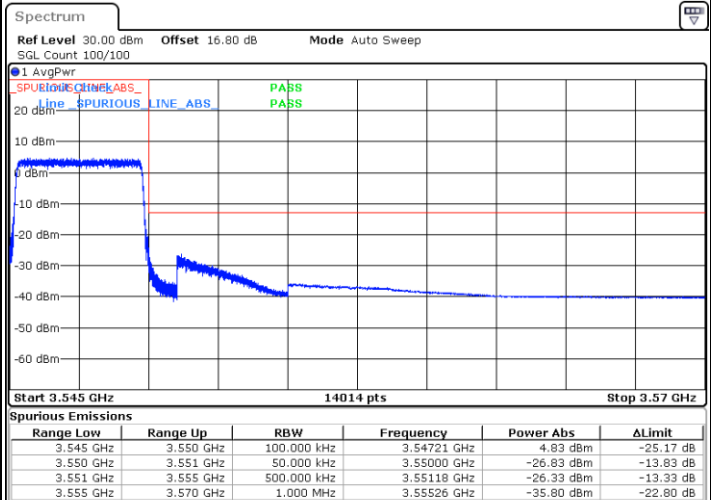

Date: 24.NOV.2022 10:39:29



LTE Band 42 / 5MHz / 16QAM

Lowest Band Edge / 1RB

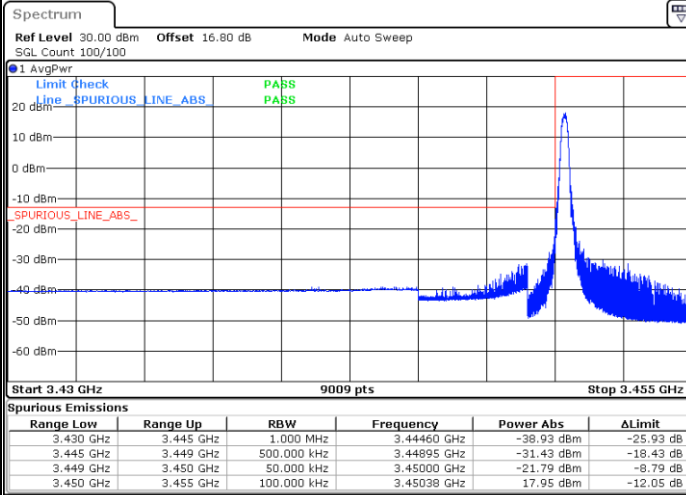

Date: 24.NOV.2022 08:12:04

Highest Band Edge / 1 RB

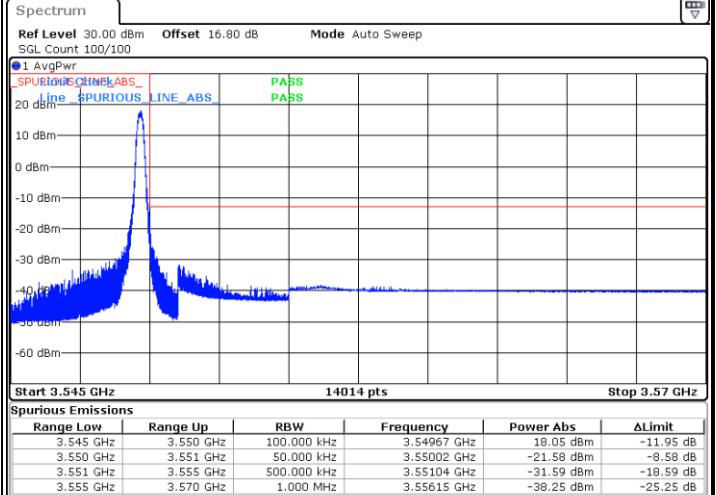

Date: 24.NOV.2022 08:21:21

Lowest Band Edge / Full RB

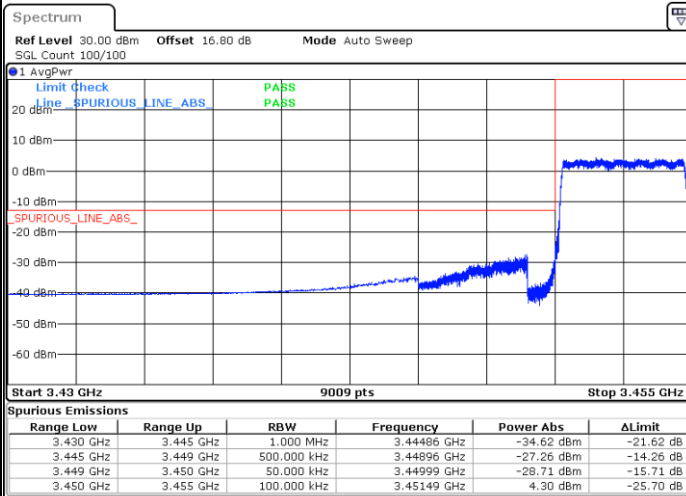

Date: 24.NOV.2022 08:16:43

Highest Band Edge / Full RB

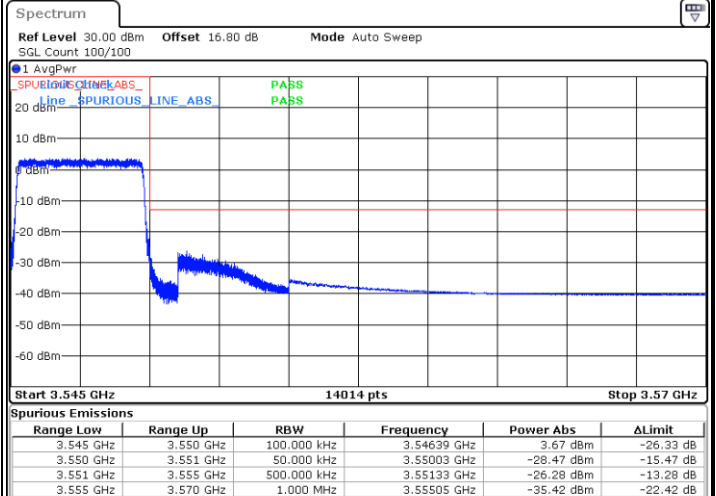

Date: 24.NOV.2022 08:26:00



LTE Band 42 / 5MHz / 64QAM

Lowest Band Edge / 1RB

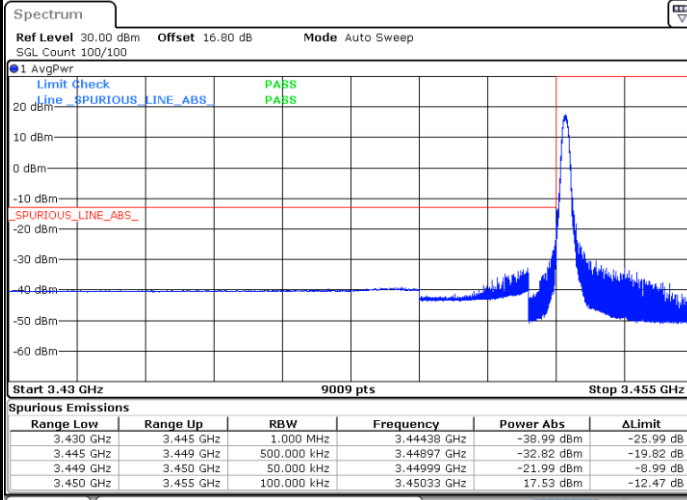

Date: 24.NOV.2022 08:13:14

Highest Band Edge / 1 RB

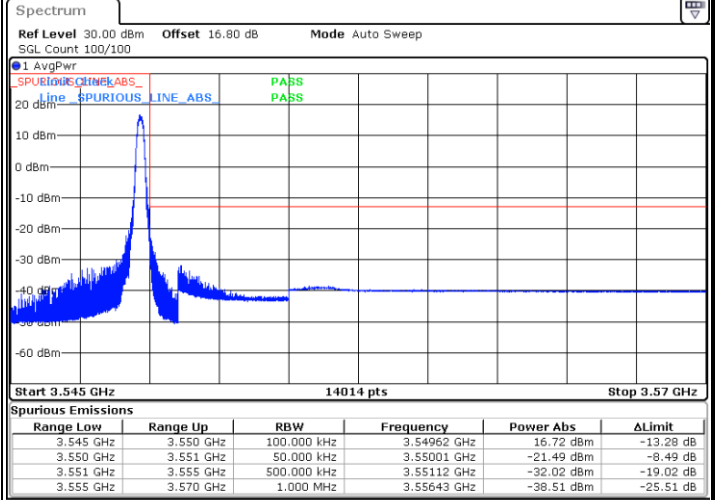

Date: 24.NOV.2022 08:22:30

Lowest Band Edge / Full RB

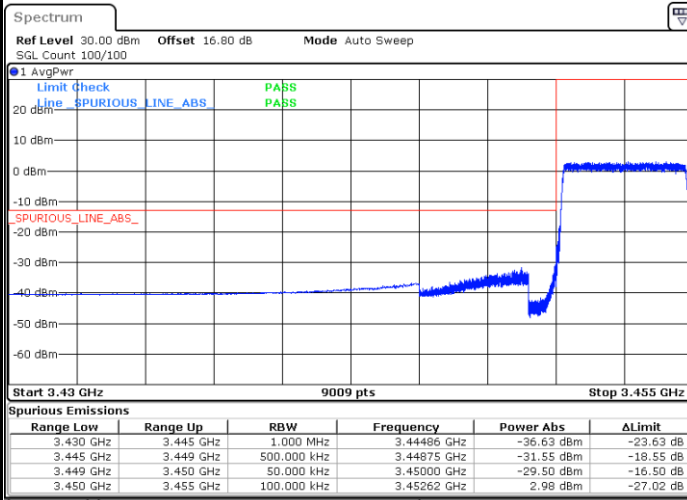

Date: 24.NOV.2022 08:17:51

Highest Band Edge / Full RB

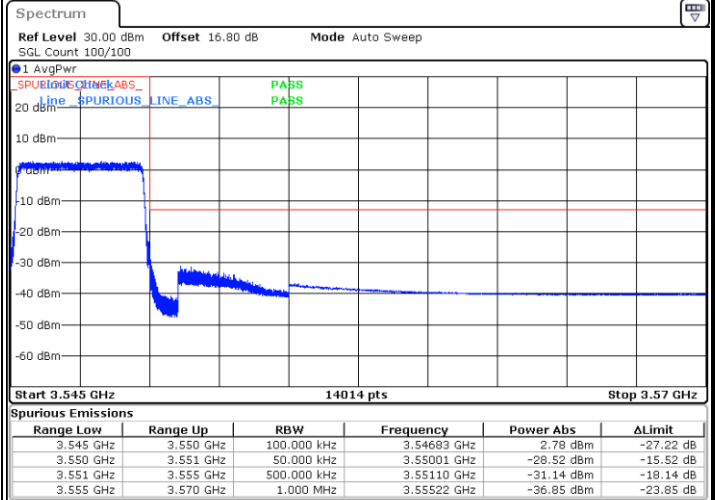

Date: 24.NOV.2022 10:41:45



LTE Band 42 / 5MHz / 256QAM

Lowest Band Edge / 1RB

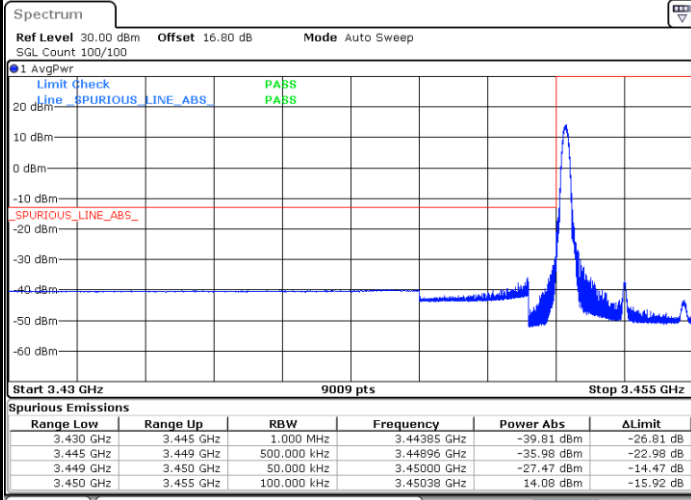

Date: 24.NOV.2022 08:14:22

Highest Band Edge / 1 RB

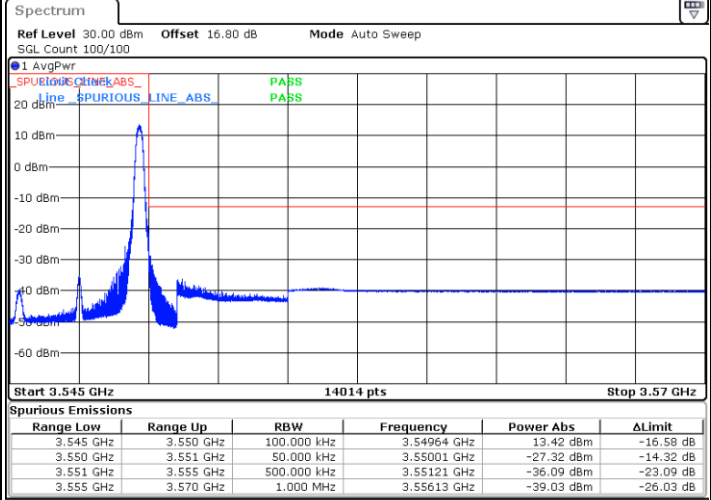

Date: 24.NOV.2022 10:38:18

Lowest Band Edge / Full RB

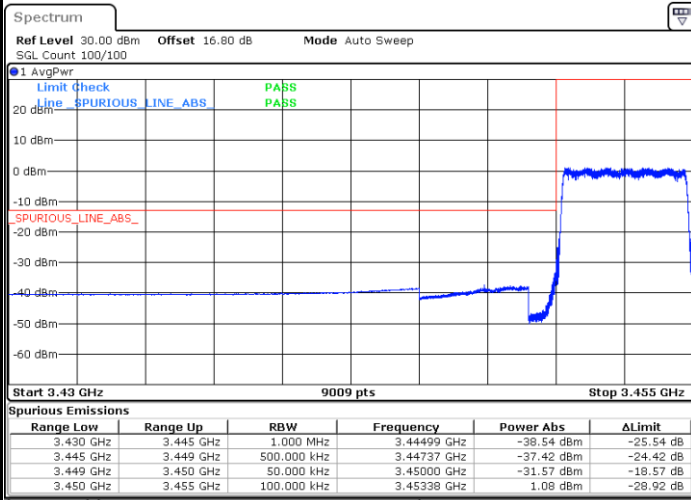

Date: 24.NOV.2022 08:19:00

Highest Band Edge / Full RB

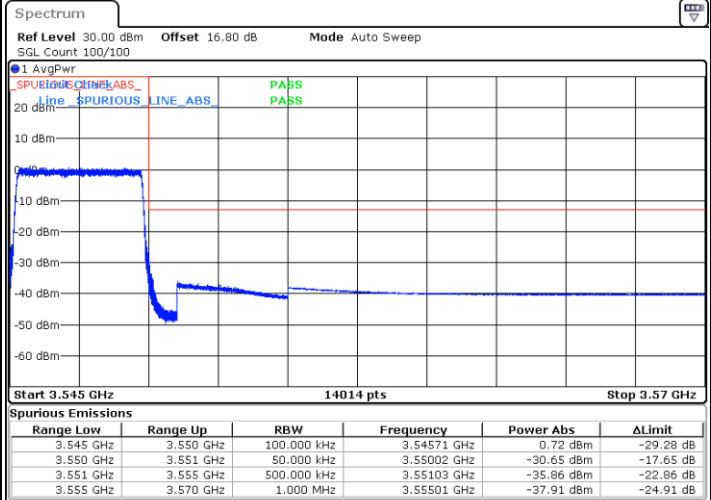

Date: 24.NOV.2022 08:28:18



LTE Band 42 / 10MHz / QPSK

Lowest Band Edge / 1 RB

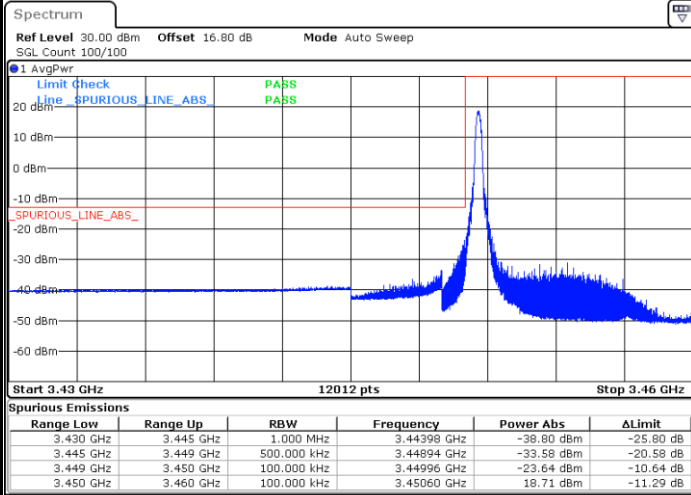

Date: 24.NOV.2022 09:12:49

Highest Band Edge / 1 RB

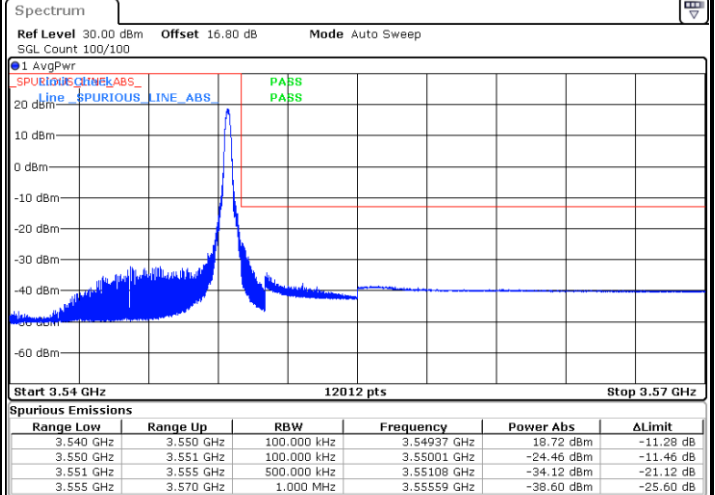

Date: 24.NOV.2022 09:26:41

Lowest Band Edge / Full RB

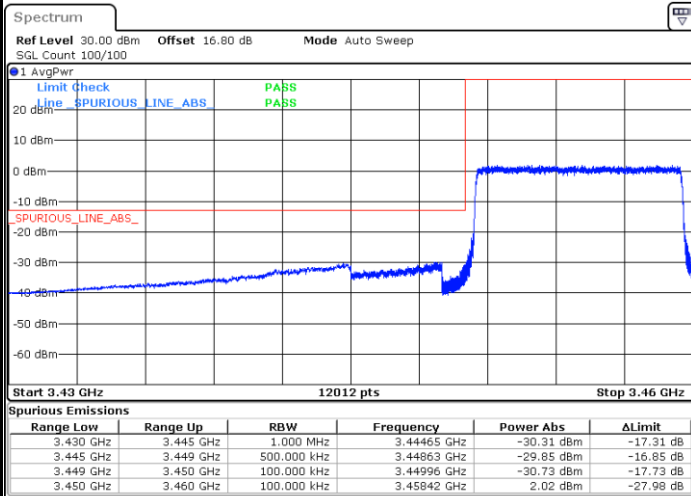

Date: 24.NOV.2022 09:17:26

Highest Band Edge / Full RB

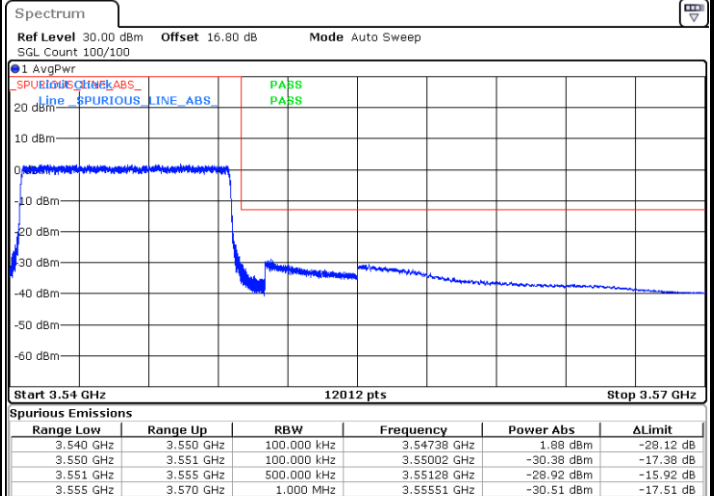

Date: 24.NOV.2022 09:22:05



LTE Band 42 / 10MHz / 16QAM

Lowest Band Edge / 1 RB

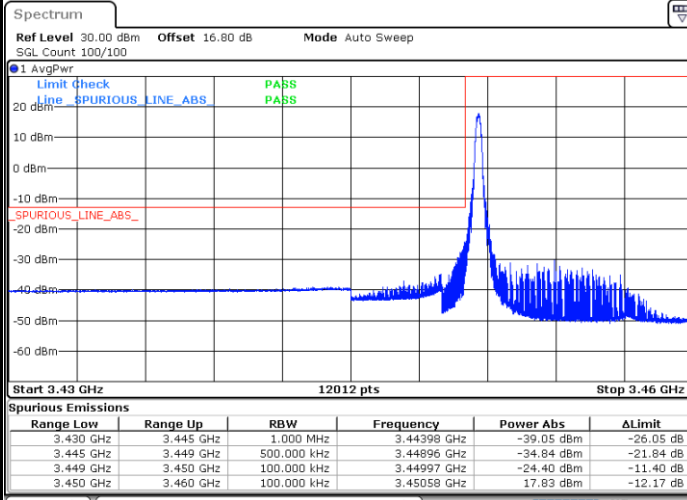

Date: 24.NOV.2022 09:13:59

Highest Band Edge / 1 RB

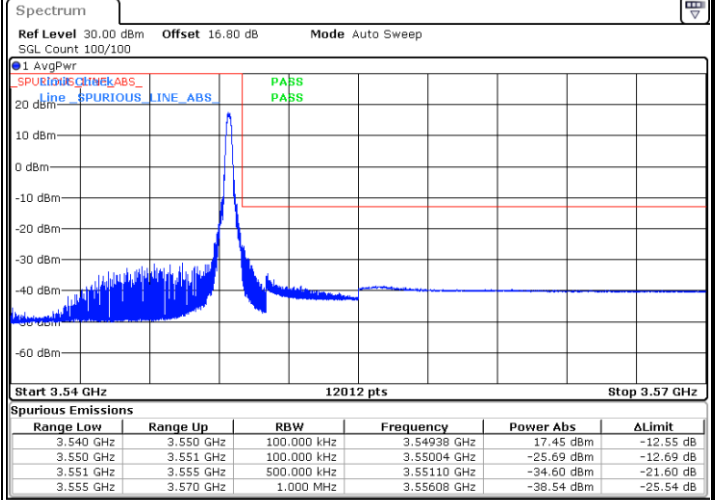

Date: 24.NOV.2022 09:27:51

Lowest Band Edge / Full RB

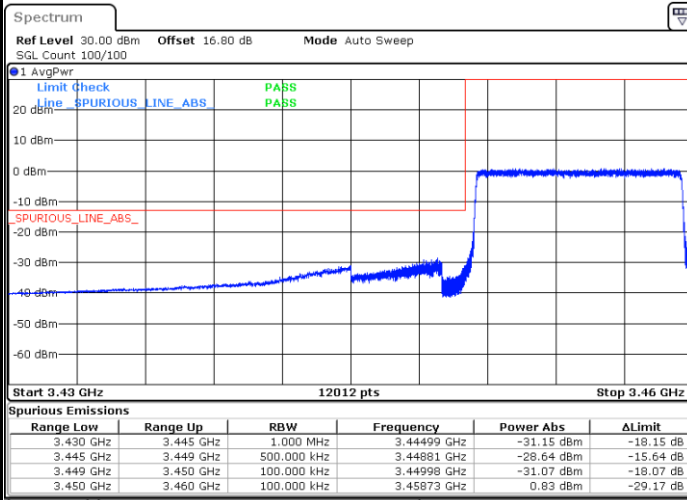

Date: 24.NOV.2022 09:18:35

Highest Band Edge / Full RB

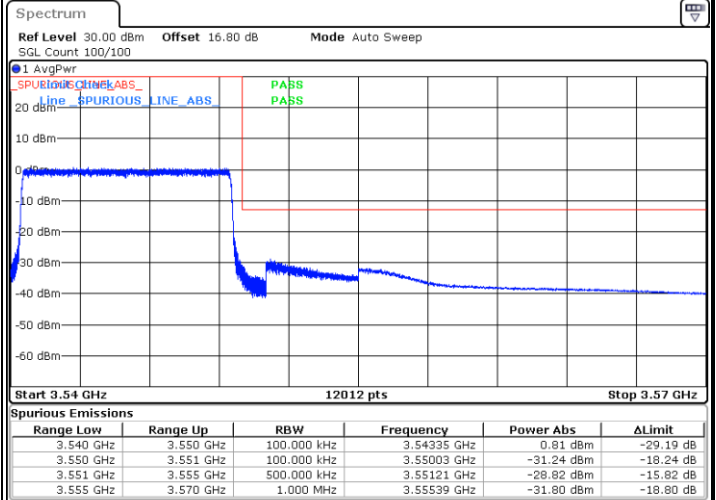

Date: 24.NOV.2022 09:23:14



LTE Band 42 / 10MHz / 64QAM

Lowest Band Edge / 1 RB

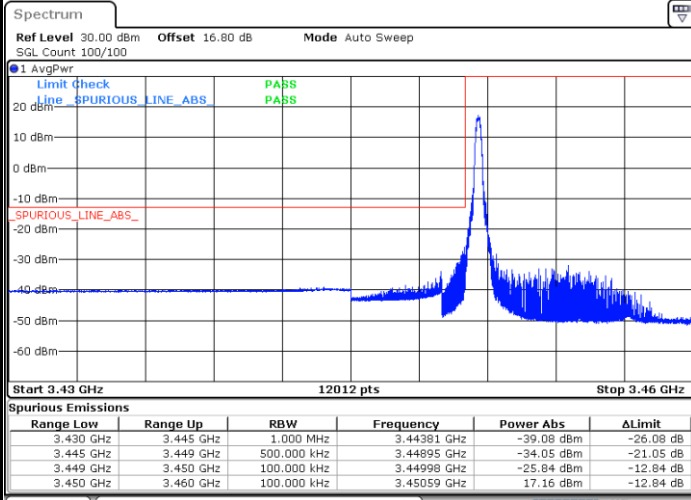

Date: 24.NOV.2022 09:15:07

Highest Band Edge / 1 RB

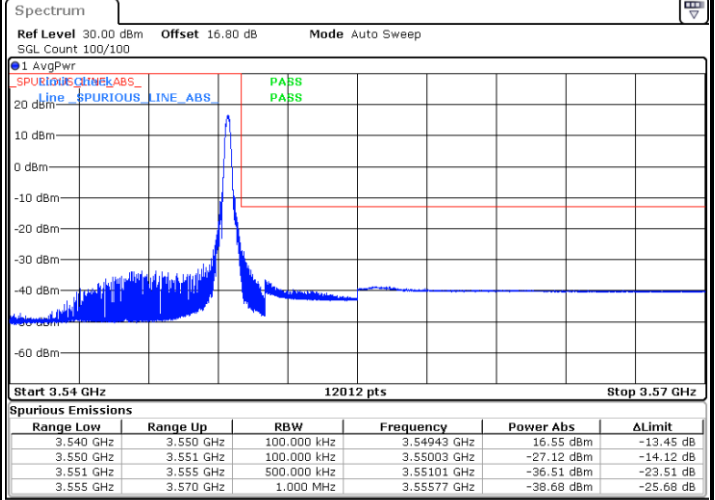

Date: 24.NOV.2022 09:28:59

Lowest Band Edge / Full RB

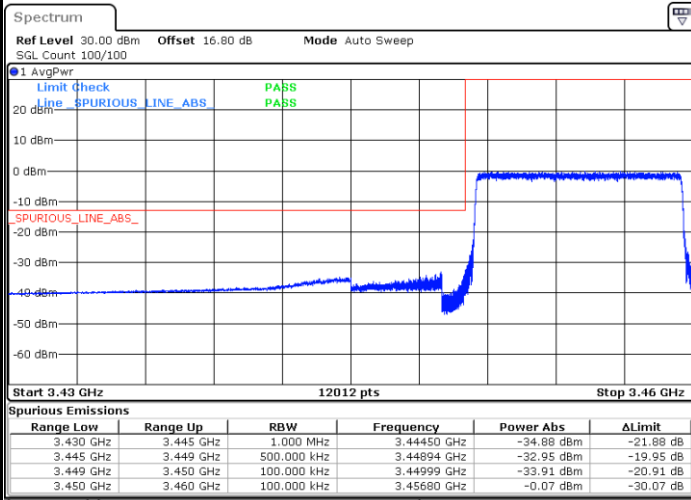

Date: 24.NOV.2022 09:19:44

Highest Band Edge / Full RB

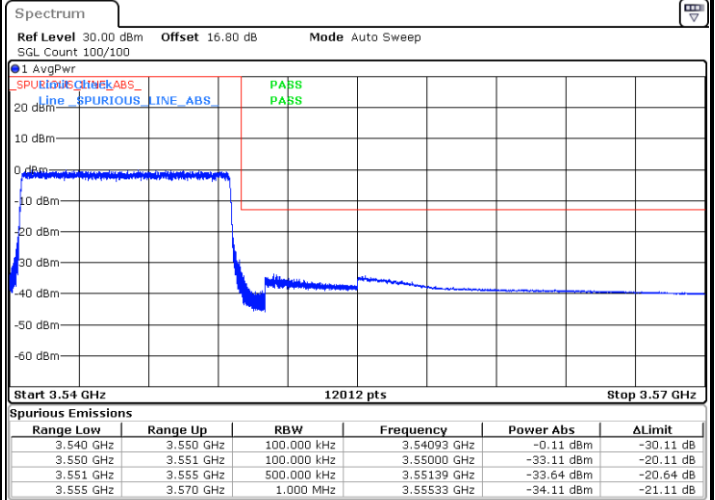

Date: 24.NOV.2022 09:24:24



LTE Band 42 / 10MHz / 256QAM

Lowest Band Edge / 1 RB

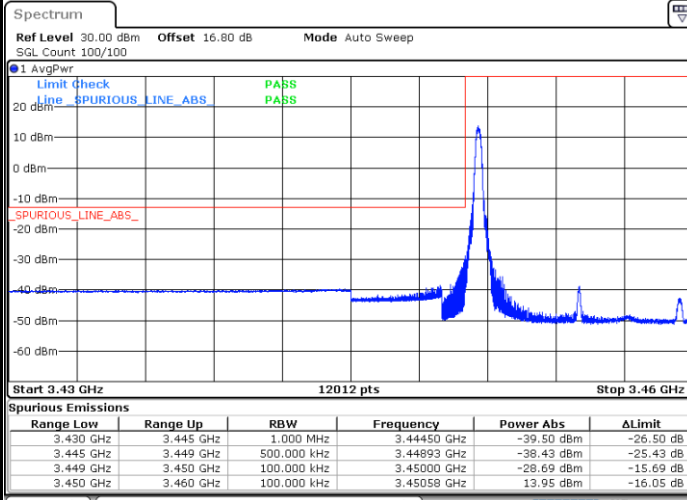

Date: 24.NOV.2022 09:16:16

Highest Band Edge / 1 RB

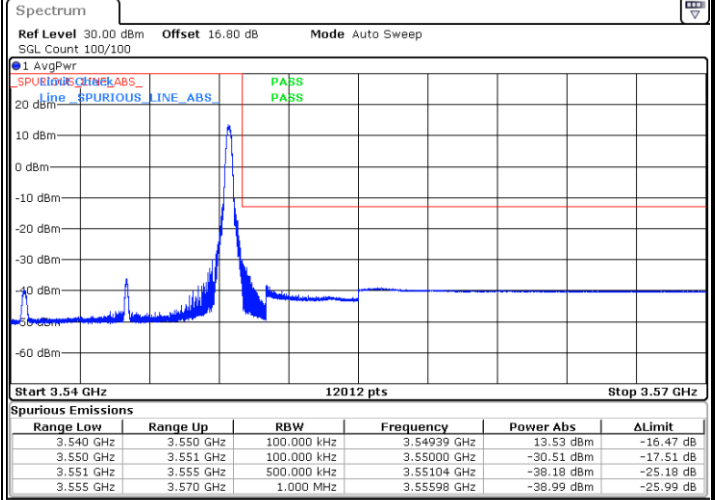

Date: 24.NOV.2022 09:30:08

Lowest Band Edge / Full RB

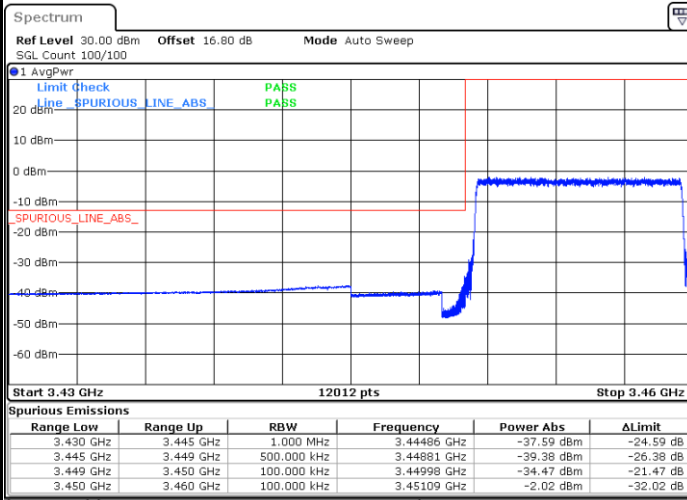

Date: 24.NOV.2022 09:20:54

Highest Band Edge / Full RB

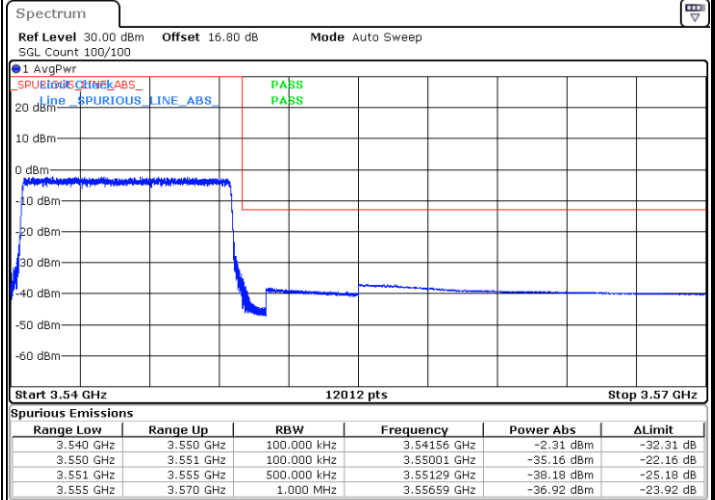

Date: 24.NOV.2022 09:25:32



LTE Band 42 / 15MHz / QPSK

Lowest Band Edge / 1 RB

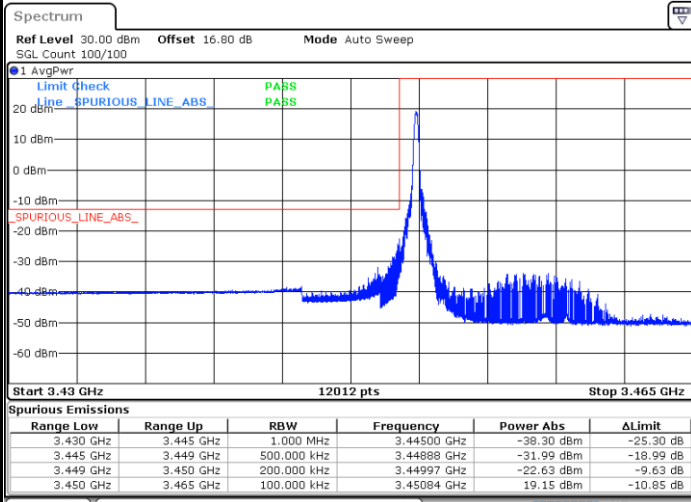

Date: 24.NOV.2022 09:36:24

Highest Band Edge / 1 RB

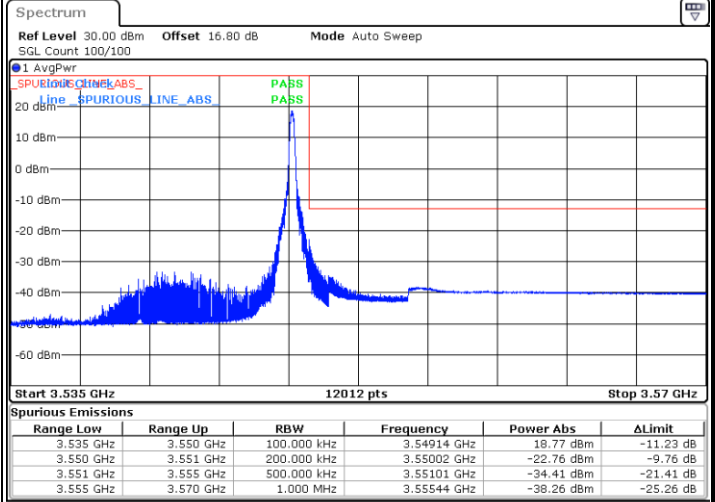

Date: 24.NOV.2022 09:51:14

Lowest Band Edge / Full RB

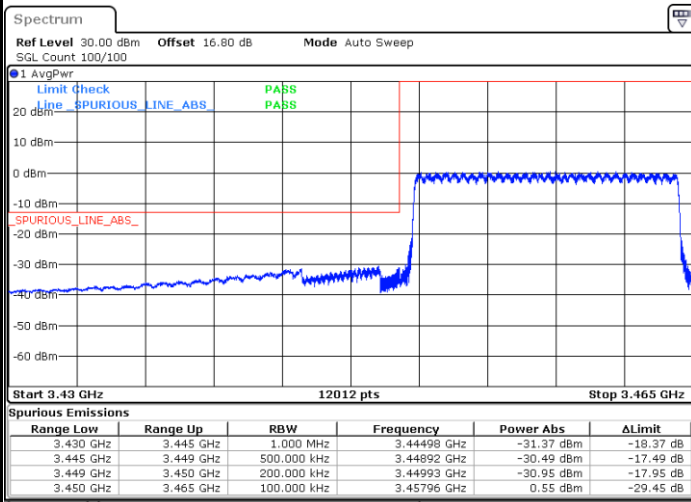

Date: 24.NOV.2022 09:41:02

Highest Band Edge / Full RB

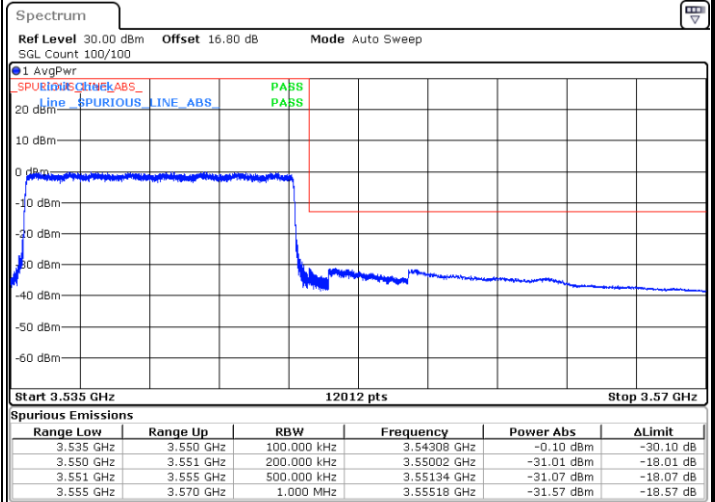

Date: 24.NOV.2022 09:45:41



LTE Band 42 / 15MHz / 16QAM

Lowest Band Edge / 1 RB

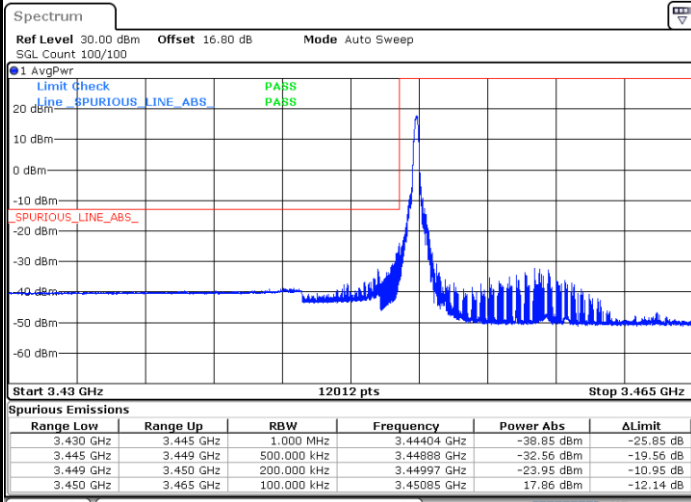

Date: 24.NOV.2022 09:37:32

Highest Band Edge / 1 RB

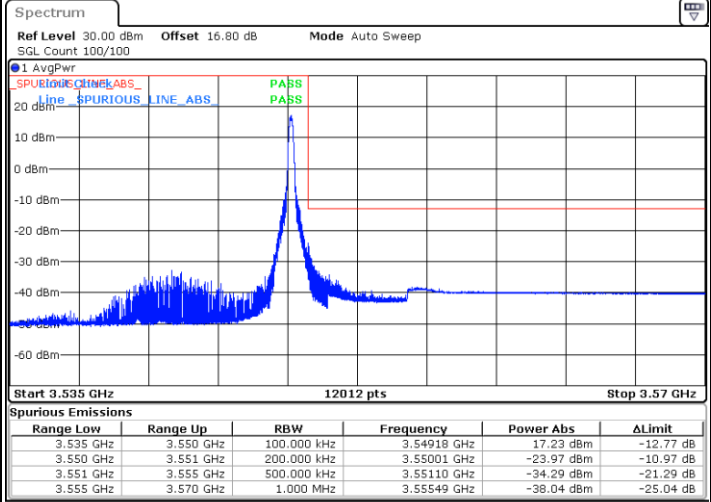

Date: 24.NOV.2022 09:52:22

Lowest Band Edge / Full RB

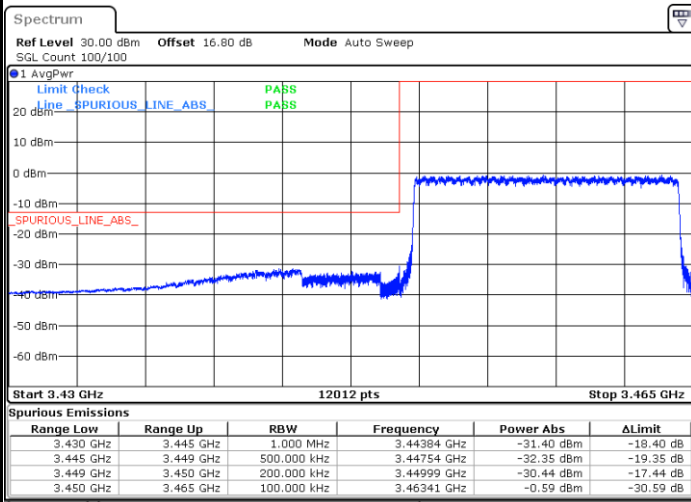

Date: 24.NOV.2022 09:42:11

Highest Band Edge / Full RB

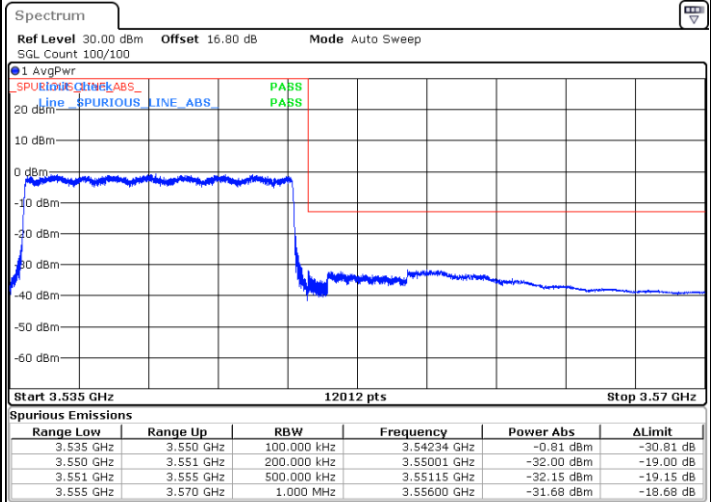

Date: 24.NOV.2022 09:46:51



LTE Band 42 / 15MHz / 64QAM

Lowest Band Edge / 1 RB

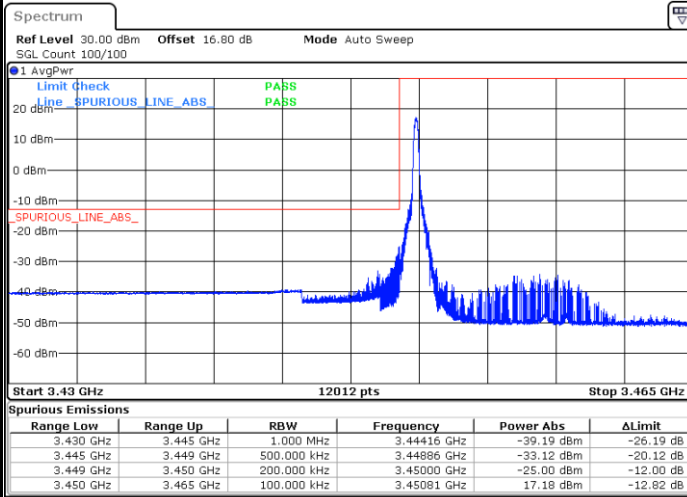

Date: 24.NOV.2022 09:38:41

Highest Band Edge / 1 RB

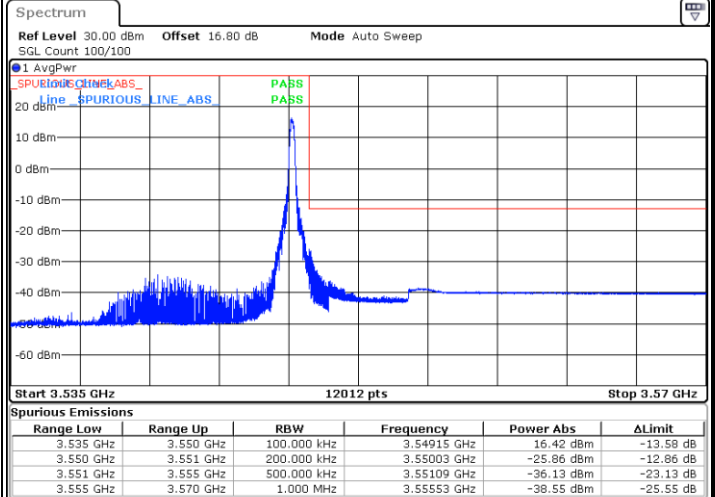

Date: 24.NOV.2022 09:53:31

Lowest Band Edge / Full RB

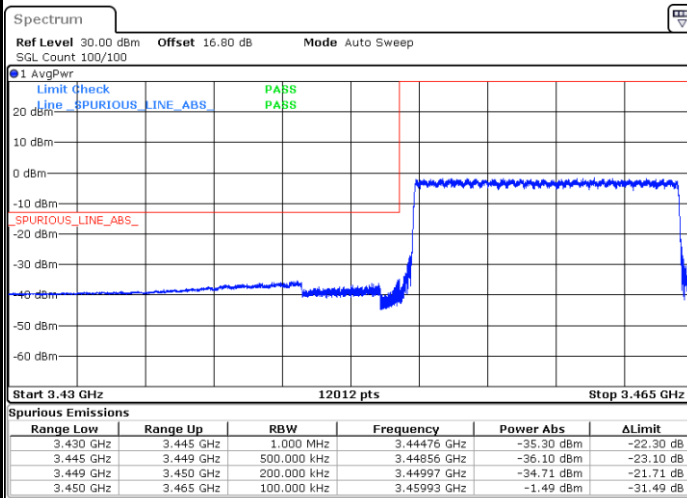

Date: 24.NOV.2022 09:43:21

Highest Band Edge / Full RB

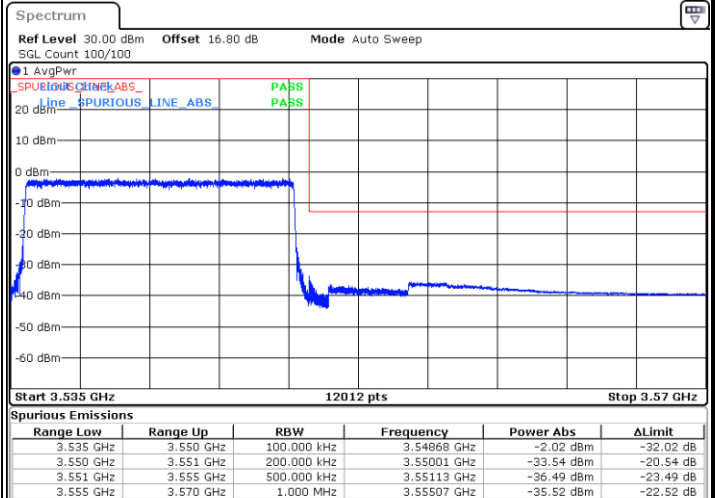

Date: 24.NOV.2022 09:47:59



LTE Band 42 / 15MHz / 256QAM

Lowest Band Edge / 1 RB

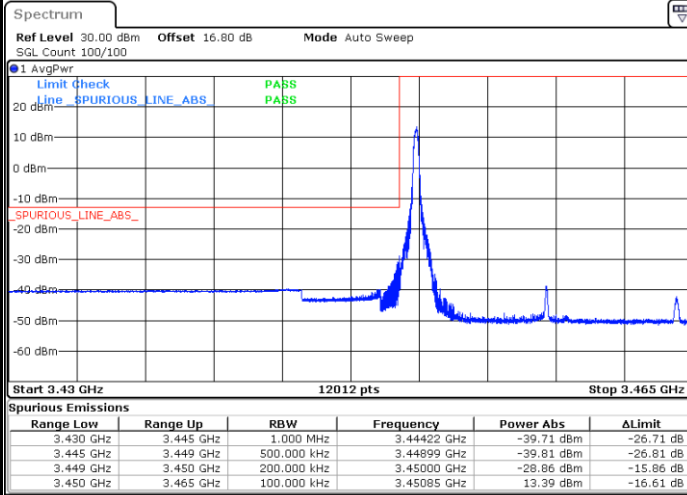

Date: 24.NOV.2022 09:39:51

Highest Band Edge / 1 RB

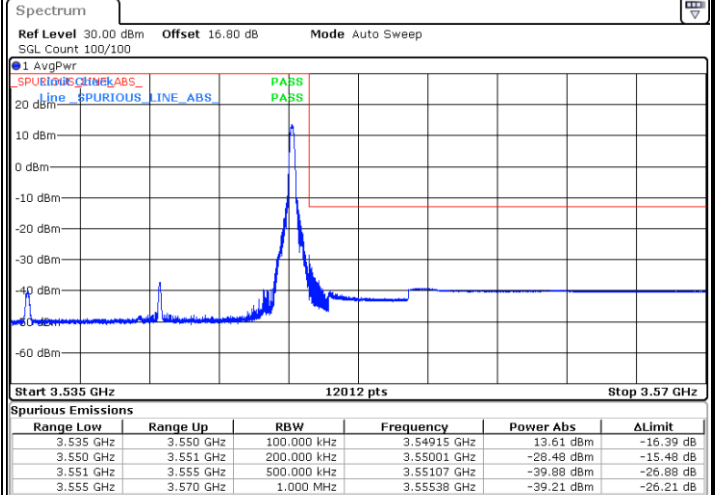

Date: 24.NOV.2022 09:54:41

Lowest Band Edge / Full RB

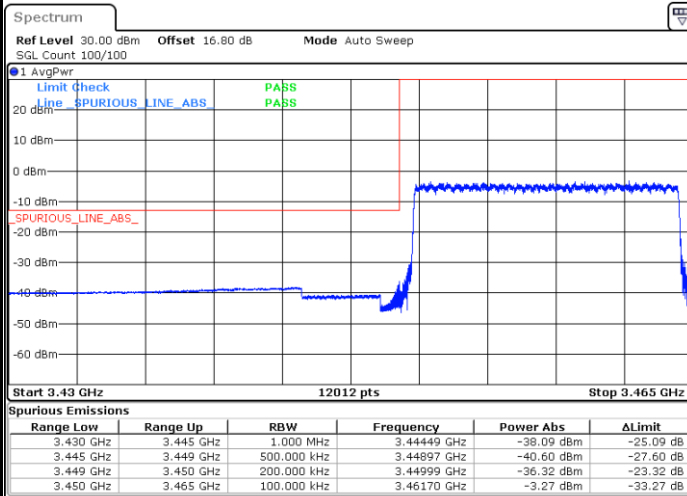

Date: 24.NOV.2022 09:44:29

Highest Band Edge / Full RB

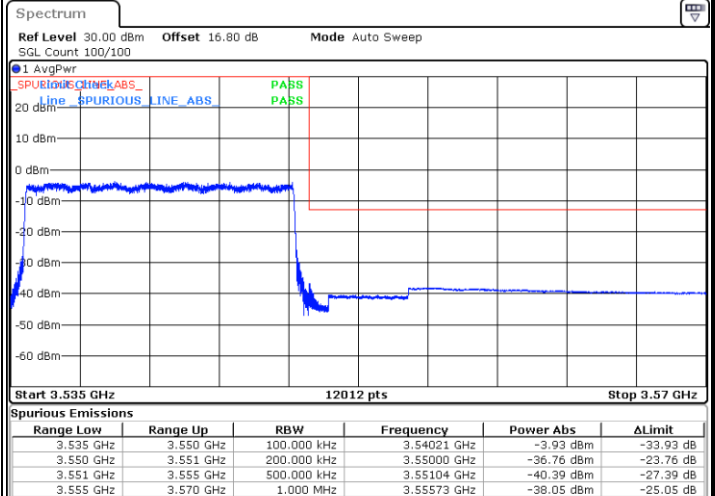

Date: 24.NOV.2022 09:49:08



LTE Band 42 / 20MHz / QPSK

Lowest Band Edge / 1 RB

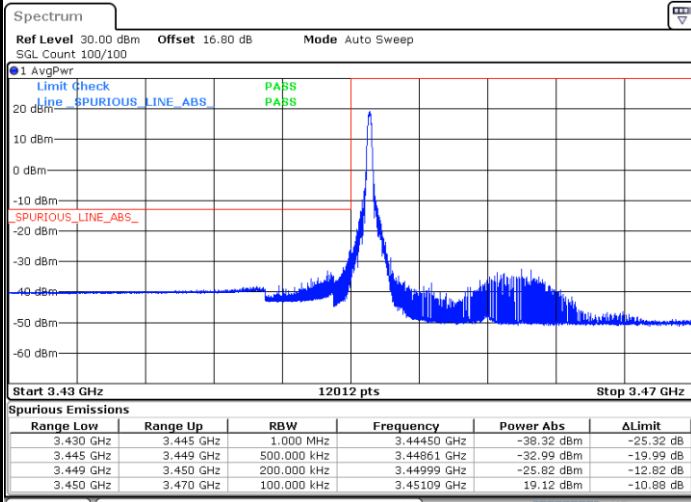

Date: 26.NOV.2022 01:35:58

Highest Band Edge / 1 RB

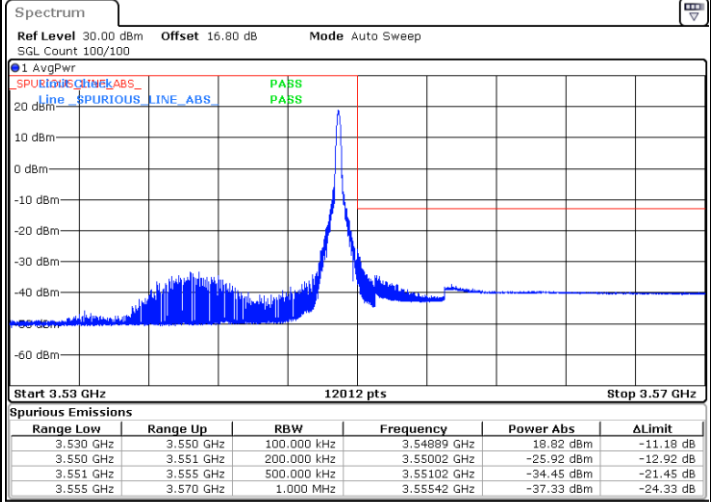

Date: 24.NOV.2022 10:15:39

Lowest Band Edge / Full RB

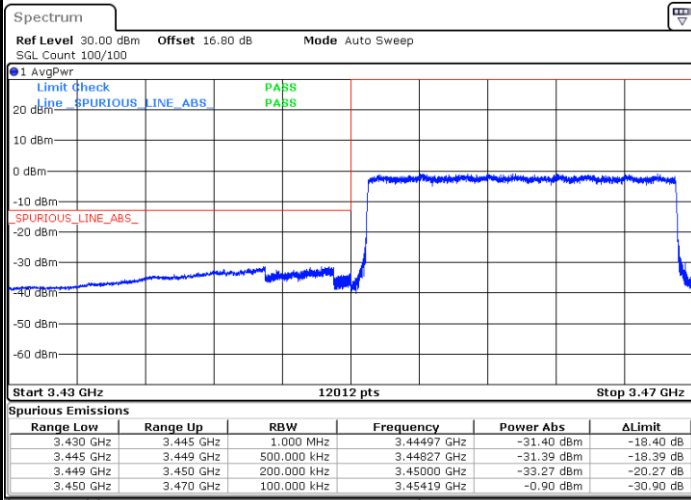

Date: 24.NOV.2022 10:06:23

Highest Band Edge / Full RB

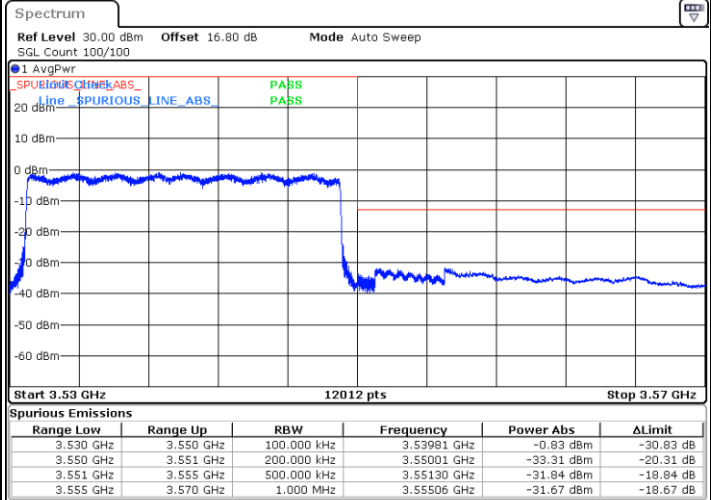

Date: 24.NOV.2022 10:11:01



LTE Band 42 / 20MHz / 16QAM

Lowest Band Edge / 1 RB

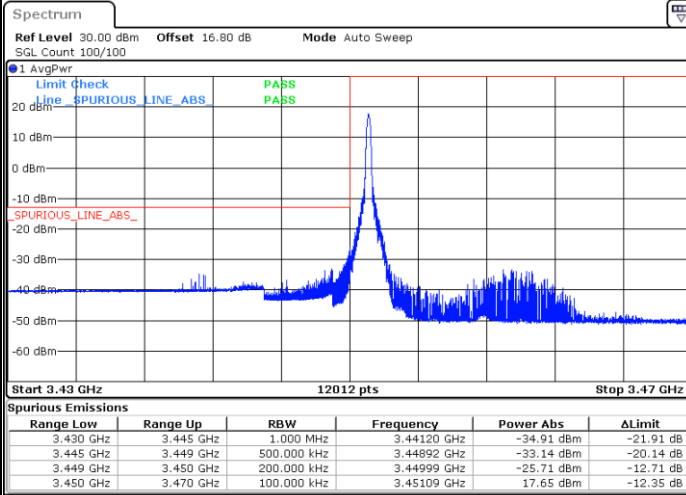

Date: 24.NOV.2022 10:02:53

Highest Band Edge / 1 RB

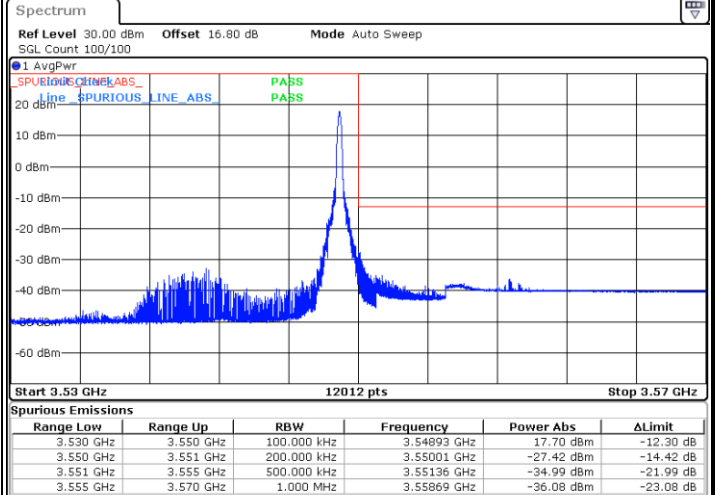

Date: 24.NOV.2022 10:16:48

Lowest Band Edge / Full RB

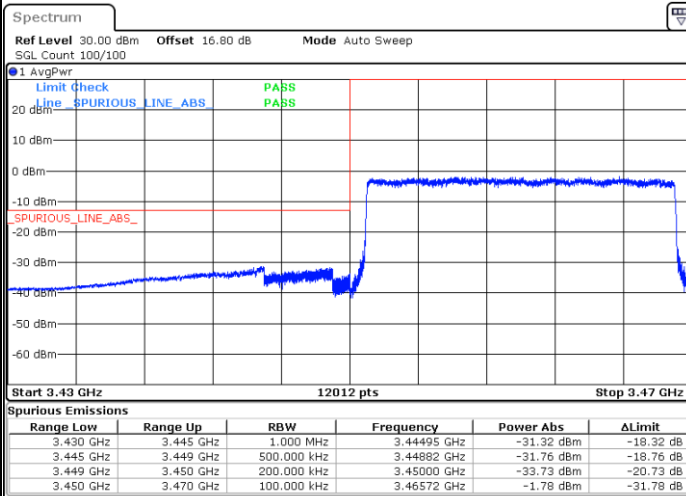

Date: 24.NOV.2022 10:07:33

Highest Band Edge / Full RB

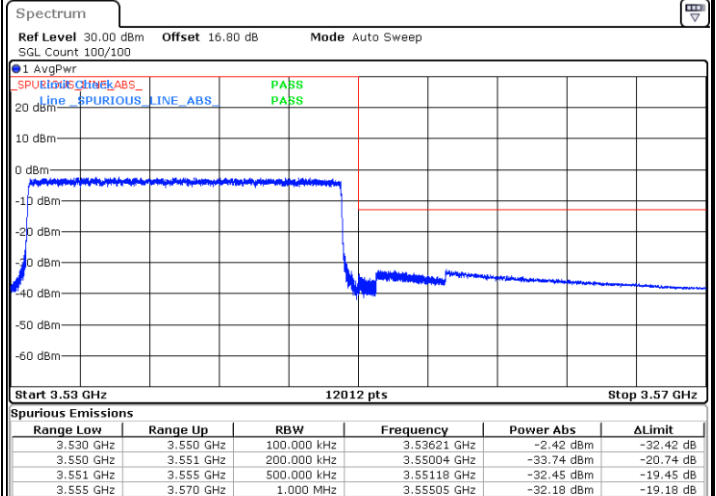

Date: 24.NOV.2022 10:12:09



LTE Band 42 / 20MHz / 64QAM

Lowest Band Edge / 1 RB

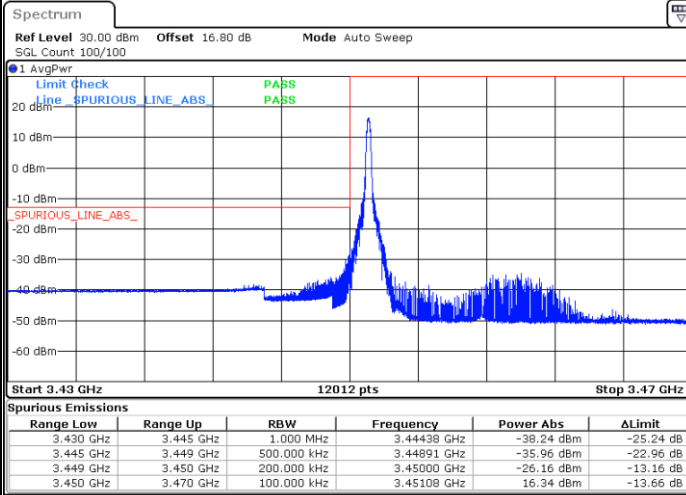

Date: 24.NOV.2022 10:04:03

Highest Band Edge / 1 RB

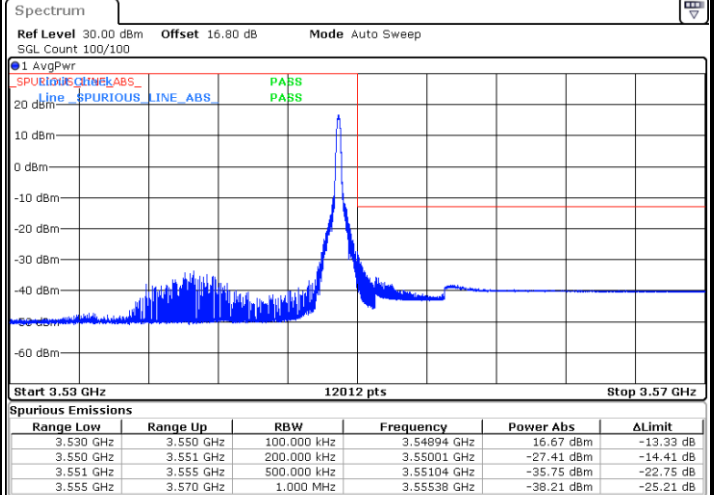

Date: 24.NOV.2022 10:17:58

Lowest Band Edge / Full RB

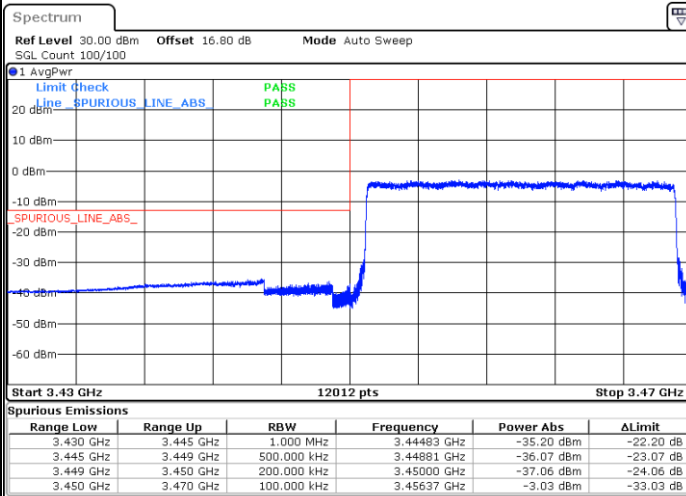

Date: 24.NOV.2022 10:08:41

Highest Band Edge / Full RB

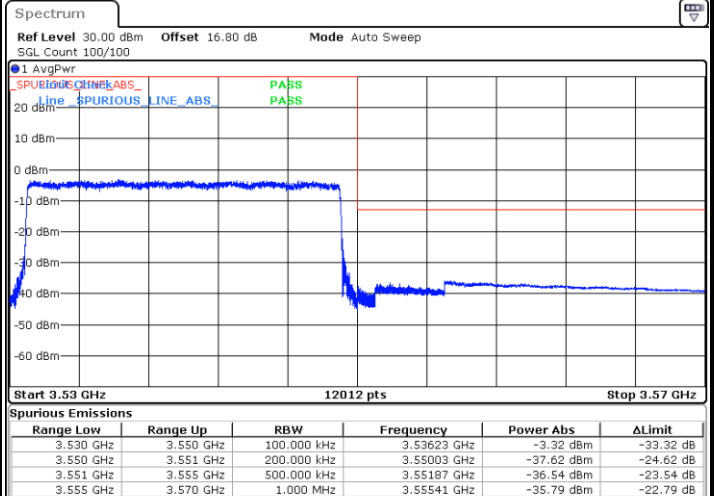

Date: 24.NOV.2022 10:13:18