



FCC RADIO TEST REPORT

FCC ID : RI7FN990A40
Equipment : 5G NR Module
Brand Name : 
Model Name : FN990A40
Marketing Name : FN990A40
Applicant : Telit Communications S.p.A.
Viale Stazione di Prosecco 5/b, Trieste 34010, Italy
Manufacturer : Telit Communications S.p.A.
Viale Stazione di Prosecco 5/b, Trieste 34010, Italy
Standard : FCC 47 CFR Part 2, 22(H), 24(E), 27

The product was received on Jul. 07, 2022 and testing was performed from Jul. 29, 2022 to Nov. 24, 2022. We, Sporton International Inc. EMC & Wireless Communications Laboratory, would like to declare that the tested sample has been evaluated in accordance with the test procedures given in ANSI / TIA-603-E and has been in compliance with the applicable technical standards.

The test results in this report apply exclusively to the tested model / sample. Without written approval from Sporton International Inc. EMC & Wireless Communications Laboratory, the test report shall not be reproduced except in full.

Louis Wu

Approved by: Louis Wu

Sporton International Inc. EMC & Wireless Communications Laboratory

No. 52, Huaya 1st Rd., Guishan Dist., Taoyuan City 333, Taiwan (R.O.C.)



Table of Contents

History of this test report..... 3

Summary of Test Result..... 4

1 General Description 6

 1.1 Product Feature of Equipment Under Test..... 6

 1.2 Modification of EUT 6

 1.3 Testing Location 7

 1.4 Applicable Standards..... 7

2 Test Configuration of Equipment Under Test 8

 2.1 Test Mode..... 8

 2.2 Connection Diagram of Test System..... 12

 2.3 Support Unit used in test configuration and system 12

 2.4 Measurement Results Explanation Example..... 12

 2.5 Frequency List of Low/Middle/High Channels 13

3 Conducted Test Items..... 17

 3.1 Measuring Instruments 17

 3.2 Conducted Output Power and ERP/EIRP 18

 3.3 Peak-to-Average Ratio 19

 3.4 Occupied Bandwidth..... 20

 3.5 Conducted Band Edge 21

 3.6 Conducted Spurious Emission 23

 3.7 Frequency Stability 24

4 Radiated Test Items 25

 4.1 Measuring Instruments 25

 4.2 Radiated Spurious Emission Measurement 27

5 List of Measuring Equipment..... 28

6 Uncertainty of Evaluation..... 30

Appendix A. Test Results of Conducted Test

Appendix B. Test Results of Radiated Test

Appendix C. Test Setup Photographs



History of this test report

Report No.	Version	Description	Issue Date
FG270608C	01	Initial issue of report	Dec. 15, 2022



Summary of Test Result

Report Clause	Ref Std. Clause	Test Items	Result (PASS/FAIL)	Remark
3.2	§2.1046	Conducted Output Power	Reporting only	-
	§22.913 (a)(5)	Effective Radiated Power (n5)	Pass	
	§27.50 (c)(10)	Effective Radiated Power (n71)		
	§24.232 (c) §27.50 (h)(2)	Equivalent Isotropic Radiated Power (n2) (n25) (n7) (n38) (n41)		
	§27.50 (d)(4)	Equivalent Isotropic Radiated Power (n66)		
3.3	§24.232 (d) §27.50 (d)(5)	Peak-to-Average Ratio	Pass	-
3.4	§2.1049	Occupied Bandwidth	Reporting only	-
3.5	§2.1051 §22.917 (a) §24.238 (a) §27.53 (g) §27.53 (h)	Conducted Band Edge Measurement (n2) (n5) (n25) (n66) (n71)	Pass	-
	§2.1051 §27.53 (m)(4)	Conducted Band Edge Measurement (n7) (n38) (n41)		
3.6	§2.1051 §22.917 (a) §24.238 (a) §27.53 (g) §27.53 (h)	Conducted Spurious Emission (n2) (n5) (n25) (n66) (n71)	Pass	-
	§2.1051 §27.53 (m)(4)	Conducted Spurious Emission (n7) (n38) (n41)		
3.7	§2.1055 §22.355 §24.235 §27.54	Frequency Stability Temperature & Voltage	Pass	-



Report Clause	Ref Std. Clause	Test Items	Result (PASS/FAIL)	Remark
4.2	§2.1053 §22.917 (a) §24.238 (a) §27.53 (g) §27.53 (h)	Radiated Spurious Emission (n2) (n5) (n25) (n66) (n71)	Pass	23.65 dB under the limit at 10332.000 MHz
	§2.1051 §27.53 (m)(4)	Radiated Spurious Emission (n7) (n38) (n41)		

Declaration of Conformity:

1. The test results (PASS/FAIL) with all measurement uncertainty excluded are presented in accordance with the regulation limits or requirements declared by manufacturers.
It's means measurement values may risk exceeding the limit of regulation standards, if measurement uncertainty is include in test results.
2. The measurement uncertainty please refer to report "Uncertainty of Evaluation".

Comments and Explanations:

The product specifications of the EUT presented in the report are declared by the manufacturer who shall take full responsibility for the authenticity.

Reviewed by: Avis Chuang

Report Producer: Michelle Chen



1 General Description

1.1 Product Feature of Equipment Under Test

WCDMA/LTE/5G NR, and GNSS

Product Feature	
Antenna Type	WWAN: Monopole Antenna GPS/Glonass/BDS/Galileo/SBAS: Monopole Antenna
Antenna Gain	5G NR n2: 5.90 dBi 5G NR n5: 3.50 dBi 5G NR n7: 3.80 dBi 5G NR n25: 5.90 dBi 5G NR n38: 3.80 dBi 5G NR n41: 3.80 dBi 5G NR n66: 5.50 dBi 5G NR n71: 2.90 dBi

Remark: The EUT's information above is declared by manufacturer. Please refer to Comments and Explanations in report summary.

1.2 Modification of EUT

No modifications made to the EUT during the testing.



1.3 Testing Location

Test Site	Sporton International Inc. EMC & Wireless Communications Laboratory	
Test Site Location	No.52, Huaya 1st Rd., Guishan Dist., Taoyuan City 333, Taiwan (R.O.C.) TEL: +886-3-327-3456 FAX: +886-3-328-4978	
Test Site No.	Sporton Site No.	
	TH03-HY	03CH07-HY
Test Engineer	Luffy Lin	Stan Hsieh and Howard Huang
Temperature (°C)	23.5~24.1	22.6~26.8
Relative Humidity (%)	48~52	56.6~64.5

Note: The test site complies with ANSI C63.4 2014 requirement.

FCC Designation No.: TW1190

1.4 Applicable Standards

According to the specifications declared by the manufacturer, the EUT must comply with the requirements of the following standards:

- ♦ ANSI C63.26-2015
- ♦ ANSI / TIA-603-E
- ♦ FCC 47 CFR Part 2, 22(H), 24(E), 27
- ♦ FCC KDB 971168 D01 Power Meas. License Digital Systems v03r01
- ♦ FCC KDB 412172 D01 Determining ERP and EIRP v01r01
- ♦ FCC KDB 414788 D01 Radiated Test Site v01r01.

Remark:

1. All the test items were validated and recorded in accordance with the standards without any modification during the testing.
2. This EUT has also been tested and complied with the requirements of FCC Part 15, Subpart B, recorded in a separate test report.
3. The TAF code is not including all the FCC KDB listed without accreditation.



2 Test Configuration of Equipment Under Test

2.1 Test Mode

Antenna port conducted and radiated test items listed below are performed according to KDB 971168 D01 Power Meas. License Digital Systems v03r01 with maximum output power.

For radiated measurement, the measured emission level of the EUT was maximized by rotating the EUT on a turntable, adjusting the orientation of the EUT and EUT antenna in two config (Ant. Horizontal and Ant. Vertical), and adjusting the measurement antenna orientation, following C63.26 exploratory test procedures and only the worst case emissions were reported in this report.

Test Items	NR Band	Bandwidth (MHz)											Modulation					RB #			Test Channel		
		5	10	15	20	30	40	50	60	80	90	100	PI/2 BPSK	QPSK	16QAM	64QAM	256QAM	1	Half	Full	L	M	H
Max. Output Power	n2	v	v	v	v	-	-	-	-	-	-	-	v	v	v	v	v	v	v	v	v	v	v
	n5	v	v	v	v	-	-	-	-	-	-	-	v	v	v	v	v	v	v	v	v	v	v
	n7	v	v	v	v	-	-	-	-	-	-	-	v	v	v	v	v	v	v	v	v	v	v
	n25	v	v	v	v	-	-	-	-	-	-	-	v	v	v	v	v	v	v	v	v	v	v
	n38	-	-	-	v	v	v	-	-	-	-	-	v	v	v	v	v	v	v	v	v	v	v
	n41	-	-	-	v	v	v	v	v	v	v	v	v	v	v	v	v	v	v	v	v	v	v
	n66	v	v	v	v	v	-	-	-	-	-	-	v	v	v	v	v	v	v	v	v	v	v
	n71	v	v	v	v	-	-	-	-	-	-	-	v	v	v	v	v	v	v	v	v	v	v
Peak-to-Average Ratio	n2	Covered by n25																					
	n5				v	-	-	-	-	-	-	-	v	v	v	v	v			v			v
	n7				v	-	-	-	-	-	-	-	v	v	v	v	v			v			v
	n25				v	-	-	-	-	-	-	-	v	v	v	v	v			v			v
	n38	Covered by n41																					
	n41	-	-	-	v								v	v	v	v	v			v			v
	n66				v			-	-	-	-	-	v	v	v	v	v			v			v
	n71				v	-	-	-	-	-	-	-	v	v	v	v	v			v			v



Test Items	NR Band	Bandwidth (MHz)											Modulation					RB #			Test Channel				
		5	10	15	20	30	40	50	60	80	90	100	PI/2 BPSK	QPSK	16QAM	64QAM	256QAM	1	Half	Full	L	M	H		
26dB and 99% Bandwidth	n2	Covered by n25																							
	n5	v	v	v	v	-	-	-	-	-	-	-	v	v	v	v	v			v		v			
	n7	v	v	v	v	-	-	-	-	-	-	-	v	v	v	v	v			v		v			
	n25	v	v	v	v	-	-	-	-	-	-	-	v	v	v	v	v			v		v			
	n38	Covered by n41																							
	n41	-	-	-	v	v	v	v	v	v	v	v	v	v	v	v	v	v			v		v		
	n66	v	v	v	v	v		-	-	-	-	-	v	v	v	v	v	v			v		v		
	n71	v	v	v	v	-	-	-	-	-	-	-	v	v	v	v	v	v			v		v		
Conducted Band Edge	n2	Covered by n25																							
	n5	v	v	v	v	-	-	-	-	-	-	-	v	v	v	v	v	v			v	v		v	
	n7	v	v	v	v	-	-	-	-	-	-	-	v	v	v	v	v	v			v	v		v	
	n25	v	v	v	v	-	-	-	-	-	-	-	v	v	v	v	v	v	v			v	v		v
	n38	Covered by n41																							
	n41	-	-	-	v	v	v	v	v	v	v	v	v	v	v	v	v	v	v			v	v		v
	n66	v	v	v	v	v		-	-	-	-	-	v	v	v	v	v	v	v			v	v		v
	n71	v	v	v	v	-	-	-	-	-	-	-	v	v	v	v	v	v	v			v	v		v



Test Items	NR Band	Bandwidth (MHz)										Modulation					RB #			Test Channel								
		5	10	15	20	30	40	50	60	80	90	100	PI/2 BPSK	QPSK	16QAM	64QAM	256QAM	1	Half	Full	L	M	H					
Conducted Spurious Emission	n2	Covered by n25																										
	n5	v				-	-	-	-	-	-	-						v					v			v	v	v
	n7	v				-	-	-	-	-	-	-						v					v			v	v	v
	n25	v				-	-	-	-	-	-	-						v					v			v	v	v
	n38	Covered by n41																										
	n41	-	-	-	v													v					v			v	v	v
	n66	v							-	-	-	-	-					v					v			v	v	v
	n71	v					-	-	-	-	-	-	-					v					v			v	v	v
Frequency Stability	n2	Covered by n25																										
	n5				v	-	-	-	-	-	-	-						v							v		v	
	n7				v	-	-	-	-	-	-	-						v							v		v	
	n25				v	-	-	-	-	-	-	-						v							v		v	
	n38	Covered by n41																										
	n41	-	-	-	v													v							v		v	
	n66				v				-	-	-	-	-					v							v		v	
	n71				v	-	-	-	-	-	-	-	-					v							v		v	



Test Items	NR Band	Bandwidth (MHz)											Modulation					RB #			Test Channel		
		5	10	15	20	30	40	50	60	80	90	100	PI/2 BPSK	QPSK	16QAM	64QAM	256QAM	1	Half	Full	L	M	H
E.R.P / E.I.R.P	n2	v	v	v	v	-	-	-	-	-	-	-	v	v	v	v	v	Max Power					
	n5	v	v	v	v	-	-	-	-	-	-	-	v	v	v	v	v						
	n7	v	v	v	v	-	-	-	-	-	-	-	v	v	v	v	v						
	n25	v	v	v	v	-	-	-	-	-	-	-	v	v	v	v	v						
	n38	-	-	-	v	v	v	-	-	-	-	-	v	v	v	v	v						
	n41	-	-	-	v	v	v	v	v	v	v	v	v	v	v	v	v						
	n66	v	v	v	v	v	-	-	-	-	-	-	v	v	v	v	v						
	n71	v	v	v	v	-	-	-	-	-	-	-	v	v	v	v	v						
Radiated Spurious Emission	n2	Covered by n25																					
	n5	Worst Case																		v	v	v	
	n7	Worst Case																		v	v	v	
	n25	Worst Case																		v	v	v	
	n38	Covered by n41																					
	n41	Worst Case																		v	v	v	
	n66	Worst Case																		v	v	v	
	n71	Worst Case																		v	v	v	
Remark	<ol style="list-style-type: none"> The mark "v" means that this configuration is chosen for testing The mark "-" means that this bandwidth is not supported. The device is investigated from 30MHz to 10 times of fundamental signal for radiated spurious emission test under different RB size/offset and modulations in exploratory test. Subsequently, only the worst case emissions are reported. Test combination are EN-DC 2A-n5A, EN-DC 7A-n5A, EN-DC 30A-n5A, EN-DC 48A-n5A, EN-DC 66A-n5A, EN-DC 48A-n25A, EN-DC 5A-n25A, EN-DC 12A-n25A, EN-DC 13A-n25A, EN-DC 26A-n25A, EN-DC 71A-n25A, EN-DC 14A-n2A, EN-DC 48A-n66A, EN-DC 5A-n66A, EN-DC 12A-n66A, EN-DC 13A-n66A, EN-DC 14A-n66A, EN-DC 71A-n66A, EN-DC 5A-n7A, EN-DC 12A-n7A, EN-DC 71A-n7A, EN-DC 2A-n41A, EN-DC 4A-n41A, EN-DC 25A-n41A, EN-DC 41A-n41A, EN-DC 66A-n41A, EN-DC 5A-n41A, EN-DC 12A-n41A, EN-DC 26A-n41A, EN-DC 71A-n41A, EN-DC 2A-n71A, EN-DC 7A-n71A, EN-DC 48A-n71A and EN-DC 66A-n71A. For radiated measurement, pre-scanned in two modes, DFT-s OFDM and CP OFDM. The worst cases (DFT-s OFDM) were recorded in this report, and the worst modes of FR1 and LTE for simultaneous transmission were verified and compliant. Wider operating range bandwidth covers narrower one when the power is higher or the same. One representative bandwidth is selected to perform PAR and frequency stability. 																						

2.2 Connection Diagram of Test System

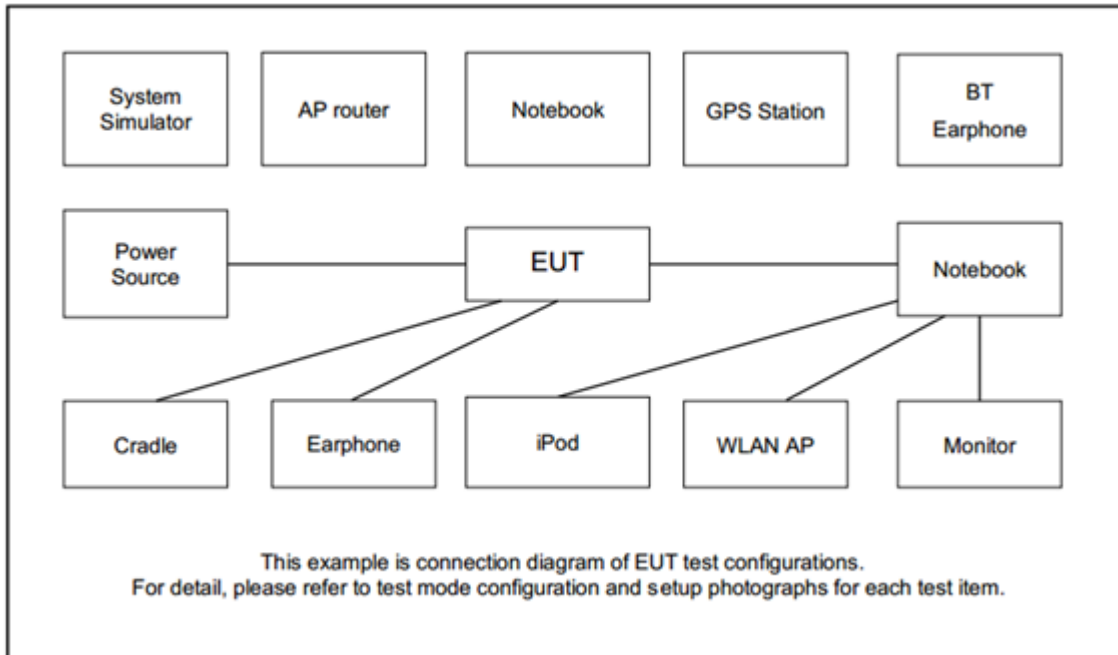

2.3 Support Unit used in test configuration and system

Item	Equipment	Brand Name	Model No.	FCC ID	Data Cable	Power Cord
1.	5G Wireless Test Platform	Anritsu	MT8000A	N/A	N/A	Unshielded, 1.8 m
2.	System Simulator	Anritsu	MT8821C	N/A	N/A	Unshielded, 1.8 m

2.4 Measurement Results Explanation Example

For all conducted test items:

The offset level is set in the spectrum analyzer to compensate the RF cable loss and attenuator factor between EUT conducted output port and spectrum analyzer. With the offset compensation, the spectrum analyzer reading level is exactly the EUT RF output level.

The spectrum analyzer offset is derived from RF cable loss and attenuator factor.

Offset = RF cable loss + attenuator factor.

Following shows an offset computation example with cable loss 4.2 dB and 10dB attenuator.

Example :

$$\begin{aligned} \text{Offset(dB)} &= \text{RF cable loss(dB)} + \text{attenuator factor(dB)}. \\ &= 4.2 + 10 = 14.2 \text{ (dB)} \end{aligned}$$



2.5 Frequency List of Low/Middle/High Channels

5G NR n2 Channel and Frequency List				
BW [MHz]	Channel/Frequency(MHz)	Lowest	Middle	Highest
20	Channel	372000	376000	380000
	Frequency	1860	1880	1900
15	Channel	371500	376000	380500
	Frequency	1857.5	1880	1902.5
10	Channel	371000	376000	381000
	Frequency	1855	1880	1905
5	Channel	370500	376000	381500
	Frequency	1852.5	1880	1907.5

5G NR n5 Channel and Frequency List				
BW [MHz]	Channel/Frequency(MHz)	Lowest	Middle	Highest
20	Channel	166800	167300	167800
	Frequency	834	836.5	839
15	Channel	166300	167300	168300
	Frequency	831.5	836.5	841.5
10	Channel	165800	167300	168800
	Frequency	829	836.5	844
5	Channel	165300	167300	169300
	Frequency	826.5	836.5	846.5

5G NR n7 Channel and Frequency List				
BW [MHz]	Channel/Frequency(MHz)	Lowest	Middle	Highest
20	Channel	502000	507000	512000
	Frequency	2510	2535	2560
15	Channel	501500	507000	512500
	Frequency	2507.5	2535	2562.5
10	Channel	501000	507000	513000
	Frequency	2505	2535	2565
5	Channel	500500	507000	513500
	Frequency	2502.5	2535	2567.5



5G NR n25 Channel and Frequency List				
BW [MHz]	Channel/Frequency(MHz)	Lowest	Middle	Highest
20	Channel	372000	376500	381000
	Frequency	1860	1882.5	1905
15	Channel	371500	376500	381500
	Frequency	1857.5	1882.5	1907.5
10	Channel	371000	376500	382000
	Frequency	1855	1882.5	1910
5	Channel	370500	376500	382500
	Frequency	1852.5	1882.5	1912.5

5G NR n38 Channel and Frequency List				
BW [MHz]	Channel/Frequency(MHz)	Lowest	Middle	Highest
40	Channel	518000	519000	520000
	Frequency	2590	2595	2600
30	Channel	517000	519000	521000
	Frequency	2585	2595	2605
20	Channel	516000	519000	522000
	Frequency	2580	2595	2610



5G NR n41 Channel and Frequency List				
BW [MHz]	Channel/Frequency(MHz)	Lowest	Middle	Highest
100	Channel	509202	518598	528000
	Frequency	2546.01	2592.99	2640
90	Channel	508200	518598	528996
	Frequency	2541	2592.99	2644.98
80	Channel	507204	518598	529998
	Frequency	2536.02	2592.99	2649.99
60	Channel	505200	518598	531996
	Frequency	2526	2592.99	2659.98
50	Channel	504204	518598	532998
	Frequency	2521.02	2592.99	2664.99
40	Channel	503202	518598	534000
	Frequency	2516.01	2592.99	2670
30	Channel	502200	518598	534996
	Frequency	2511	2592.99	2674.98
20	Channel	501204	518598	535998
	Frequency	2506.02	2592.99	2679.99

5G NR n66 Channel and Frequency List				
BW [MHz]	Channel/Frequency(MHz)	Lowest	Middle	Highest
30	Channel	345000	349000	353000
	Frequency	1725	1745	1765
20	Channel	344000	349000	354000
	Frequency	1720	1745	1770
15	Channel	343500	349000	354500
	Frequency	1717.5	1745	1772.5
10	Channel	343000	349000	355000
	Frequency	1715	1745	1775
5	Channel	342500	349000	355500
	Frequency	1712.5	1745	1777.5



5G NR n71 Channel and Frequency List				
BW [MHz]	Channel/Frequency(MHz)	Lowest	Middle	Highest
20	Channel	134600	136100	137600
	Frequency	673	680.5	688
15	Channel	134100	136100	138100
	Frequency	670.5	680.5	690.5
10	Channel	133600	136100	138600
	Frequency	668	680.5	693
5	Channel	133100	136100	139100
	Frequency	665.5	680.5	695.5

3 Conducted Test Items

3.1 Measuring Instruments

See list of measuring instruments of this test report.

3.1.1 Test Setup

3.1.2 Conducted Output Power

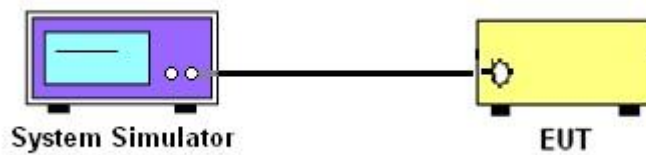

3.1.3 Peak-to-Average Ratio, Occupied Bandwidth ,Conducted Band-Edge and Conducted Spurious Emission

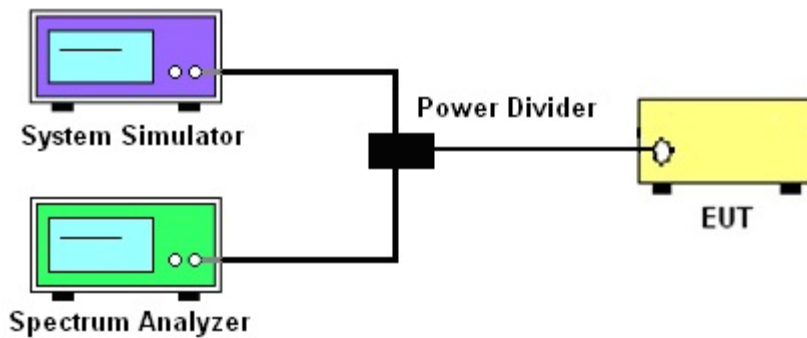

3.1.4 Frequency Stability

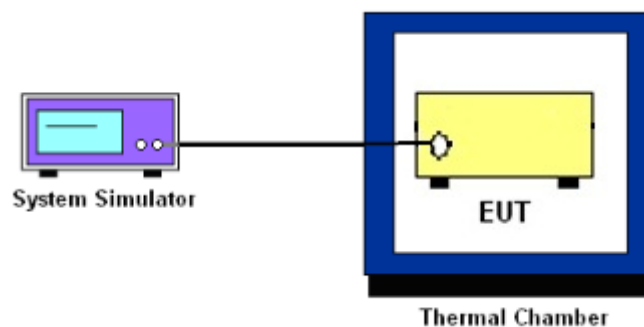

3.1.5 Test Result of Conducted Test

Please refer to Appendix A.



3.2 Conducted Output Power and ERP/EIRP

3.2.1 Description of the Conducted Output Power Measurement and ERP/EIRP Measurement

A system simulator was used to establish communication with the EUT. Its parameters were set to force the EUT transmitting at maximum output power. The measured power in the radio frequency on the transmitter output terminals shall be reported.

The ERP of mobile transmitters must not exceed 7 Watts for 5G NR n5

The ERP of mobile transmitters must not exceed 3 Watts for 5G NR n71

The EIRP of mobile transmitters must not exceed 2 Watts for 5G NR n2 and n25 and n7 and n38 and n41

The EIRP of mobile transmitters must not exceed 1 Watts for 5G NR n66

According to KDB 412172 D01 Power Approach,

$EIRP = P_T + G_T - L_C$, $ERP = EIRP - 2.15$, where

P_T = transmitter output power in dBm

G_T = gain of the transmitting antenna in dBi

L_C = signal attenuation in the connecting cable between the transmitter and antenna in dB

The MIMO mode is completely uncorrelated, so the directional gain is selected the maximum gain among all antennas.

3.2.2 Test Procedures

1. The transmitter output port was connected to the system simulator.
2. Set EUT at maximum power through the system simulator.
3. Select lowest, middle, and highest channels for each band and different modulation.
4. Measure and record the power level from the system simulator.



3.3 Peak-to-Average Ratio

3.3.1 Description of the PAR Measurement

Power Complementary Cumulative Distribution Function (CCDF) curves provide a means for characterizing the power peaks of a digitally modulated signal on a statistical basis. A CCDF curve depicts the probability of the peak signal amplitude exceeding the average power level. Most contemporary measurement instrumentation include the capability to produce CCDF curves for an input signal provided that the instrument's resolution bandwidth can be set wide enough to accommodate the entire input signal bandwidth. In measuring transmissions in this band using an average power technique, the peak-to-average ratio (PAR) of the transmission may not exceed 13 dB.

3.3.2 Test Procedures

The testing follows ANSI C63.26-2015 Section 5.2.6

1. The EUT was connected to spectrum and system simulator via a power divider.
2. Set the CCDF (Complementary Cumulative Distribution Function) option in spectrum analyzer.
3. The highest RF powers were measured and recorded the maximum PAPR level associated with a probability of 0.1 %.
4. Record the deviation as Peak to Average Ratio.



3.4 Occupied Bandwidth

3.4.1 Description of Occupied Bandwidth Measurement

The occupied bandwidth is the width of a frequency band such that, below the lower and above the upper frequency limits, the mean powers emitted are each equal to a specified percentage 0.5% of the total mean transmitted power.

The 26 dB emission bandwidth is defined as the frequency range between two points, one above and one below the carrier frequency, at which the spectral density of the emission is attenuated 26 dB below the maximum in-band spectral density of the modulated signal. Spectral density (power per unit bandwidth) is to be measured with a detector of resolution bandwidth equal to approximately 1.0% of the emission bandwidth.

3.4.2 Test Procedures

The testing follows ANSI C63.26-2015 Section 5.4.3 (26dB) and Section 5.4.4 (99OB)

1. The EUT was connected to spectrum analyzer and system simulator via a power divider.
2. The spectrum analyzer center frequency is set to the nominal EUT channel center frequency. The span range for the spectrum analyzer shall be between two and five times the anticipated OBW.
3. The nominal resolution bandwidth (RBW) shall be in the range of 1 to 5 % of the anticipated OBW, and the VBW shall be at least 3 times the RBW.
4. Set the detection mode to peak, and the trace mode to max hold.
5. Determine the reference value: Set the EUT to transmit a modulated signal. Allow the trace to stabilize. Set the spectrum analyzer marker to the highest level of the displayed trace.
(this is the reference value)
6. Determine the “-26 dB down amplitude” as equal to (Reference Value – X).
7. Place two markers, one at the lowest and the other at the highest frequency of the envelope of the spectral display such that each marker is at or slightly below the “-X dB down amplitude” determined in step 6. If a marker is below this “-X dB down amplitude” value it shall be placed as close as possible to this value. The OBW is the positive frequency difference between the two markers.
8. Use the 99 % power bandwidth function of the spectrum analyzer and report the measured bandwidth.



3.5 Conducted Band Edge

3.5.1 Description of Conducted Band Edge Measurement

22.917(a)

For operations in the 824 – 849 MHz band, the FCC limit is $43 + 10\log_{10}(P[\text{Watts}])$ dB below the transmitter power $P(\text{Watts})$ in a 100kHz bandwidth. However, in the 1MHz bands immediately outside and adjacent to the licensee's frequency block, a resolution bandwidth of at least one percent of the emission bandwidth of the fundamental emission of the transmitter may be employed.

24.238 (a)

For operations in the 1850-1910 and 1930-1990 MHz band, the FCC limit is $43 + 10\log_{10}(P[\text{Watts}])$ dB below the transmitter power $P(\text{Watts})$ in a 1MHz bandwidth. However, in the 1 MHz bands immediately outside and adjacent to the frequency block a resolution bandwidth of at least one percent of the emission bandwidth of the fundamental emission of the transmitter may be employed.

27.53 (g)

For operations in the 600MHz band and 698-746 MHz band, the FCC limit is $43 + 10\log_{10}(P[\text{Watts}])$ dB below the transmitter power $P(\text{Watts})$ in a 100 kHz bandwidth. However, in the 100 kilohertz bands immediately outside and adjacent to a licensee's frequency block, a resolution bandwidth of at least 30 kHz may be employed.

27.53 (h)

For operations in the 1710 – 1755 MHz band, 1755-1780 MHz, the FCC limit is $43 + 10\log_{10}(P[\text{Watts}])$ dB below the transmitter power $P(\text{Watts})$ in a 1 MHz bandwidth. However, in the 1MHz bands immediately outside and adjacent to the licensee's frequency block, a resolution bandwidth of at least one percent of the emission bandwidth of the fundamental emission of the transmitter may be employed.

**27.53(m)(4)**

For mobile digital stations, the attenuation factor shall be not less than $40 + 10 \log (P)$ dB on all frequencies between the channel edge and 5 megahertz from the channel edge, $43 + 10 \log (P)$ dB on all frequencies between 5 megahertz and X megahertz from the channel edge, and $55 + 10 \log (P)$ dB on all frequencies more than X megahertz from the channel edge, where X is the greater of 6 megahertz or the actual emission bandwidth as defined in paragraph (m)(6) of this section. In addition, the attenuation factor shall not be less that $43 + 10 \log (P)$ dB on all frequencies between 2490.5 MHz and 2496 MHz and $55 + 10 \log (P)$ dB at or below 2490.5 MHz. Mobile Satellite Service licensees operating on frequencies below 2495 MHz may also submit a documented interference complaint against BRS licensees operating on channel BRS Channel 1 on the same terms and conditions as adjacent channel BRS or EBS licensees.

3.5.2 Test Procedures

The testing follows FCC KDB 971168 D01 v03r01 Section 6.1.

1. The EUT was connected to spectrum analyzer and system simulator via a power divider.
2. The band edges of low and high channels for the highest RF powers were measured.
3. Set RBW \geq 1% EBW in the 1MHz band immediately outside and adjacent to the band edge.
4. Beyond the 1 MHz band from the band edge, RBW=1MHz was used.
5. Set spectrum analyzer with RMS detector.
6. The RF fundamental frequency should be excluded against the limit line in the operating frequency band.
7. Checked that all the results comply with the emission limit line.

The limit line is derived from $43 + 10\log(P)$ dB below the transmitter power P(Watts)

For 5G NR n7, n38, n41

The other 40 dB, and 55 dB have additionally applied same calculation above.

8. For MIMO mode, add additional MIMO factor $10\log(\text{NTX}=2) = 3.01\text{dB}$ into the spectrum analyzer offset.



3.6 Conducted Spurious Emission

3.6.1 Description of Conducted Spurious Emission Measurement

The power of any emission outside of the authorized operating frequency ranges must be lower than the transmitter power (P) by a factor of at least $43 + 10 \log (P)$ dB.

For 5G NR n7, n38, n41

The power of any emission outside of the authorized operating frequency ranges must be lower than the transmitter power (P) by a factor of at least $55 + 10 \log (P)$ dB.

It is measured by means of a calibrated spectrum analyzer and scanned from 30 MHz up to a frequency including its 10th harmonic.

3.6.2 Test Procedures

The testing follows FCC KDB 971168 D01 v03r01 Section 6.1.

1. The EUT was connected to spectrum analyzer and system simulator via a power divider.
2. The RF output of EUT was connected to the spectrum analyzer by RF cable and attenuator.
The path loss was compensated to the results for each measurement.
3. The middle channel for the highest RF power within the transmitting frequency was measured.
4. The conducted spurious emission for the whole frequency range was taken.
5. Make the measurement with the spectrum analyzer's RBW = 1MHz, VBW = 3MHz.
6. Set spectrum analyzer with RMS detector.
7. Taking the record of maximum spurious emission.
8. The RF fundamental frequency should be excluded against the limit line in the operating frequency band.
9. The limit line is derived from $43 + 10\log(P)$ dB below the transmitter power P(Watts)
For 5G NR n7, n38, n41
The limit line is derived from $55 + 10\log(P)$ dB below the transmitter power P(Watts)
10. For MIMO mode, add additional MIMO factor $10\log(NTX=2) = 3.01$ dB into the spectrum analyzer offset.



3.7 Frequency Stability

3.7.1 Description of Frequency Stability Measurement

22.355

The frequency stability shall be measured by variation of ambient temperature and variation of primary supply voltage to ensure that the fundamental emission stays within the authorized frequency block. The frequency stability of the transmitter shall be maintained within $\pm 0.00025\%$ ($\pm 2.5\text{ppm}$) of the center frequency.

24.235 & 27.54

The frequency stability shall be sufficient to ensure that the fundamental emission stays within the authorized frequency block.

3.7.2 Test Procedures for Temperature Variation

The testing follows FCC KDB 971168 D01 v03r01 Section 9.0.

1. The EUT was set up in the thermal chamber and connected with the system simulator.
2. With power OFF, the temperature was decreased to -30°C and the EUT was stabilized before testing. Power was applied and the maximum change in frequency was recorded within one minute.
3. With power OFF, the temperature was raised in 10°C step up to 50°C . The EUT was stabilized at each step for at least half an hour. Power was applied and the maximum frequency change was recorded within one minute.

3.7.3 Test Procedures for Voltage Variation

The testing follows FCC KDB 971168 D01 v03r01 Section 9.0.

1. The EUT was placed in a temperature chamber at $20\pm 5^{\circ}\text{C}$ and connected with the system simulator.
2. The power supply voltage to the EUT was varied from 85% to 115% of the nominal value measured at the input to the EUT.
3. The variation in frequency was measured for the worst case.

4 Radiated Test Items

4.1 Measuring Instruments

See list of measuring instruments of this test report.

4.1.1 Test Setup

For radiated test below 30MHz



For radiated test from 30MHz to 1GHz

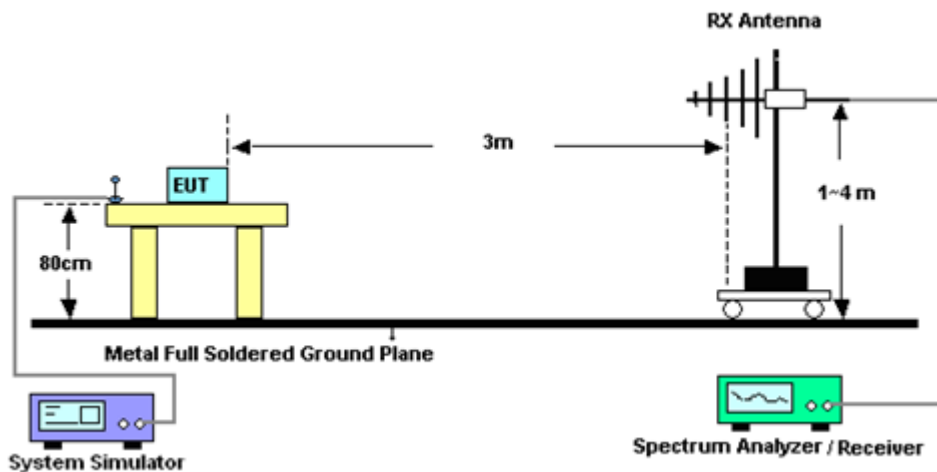

For radiated test from 1GHz to 18GHz

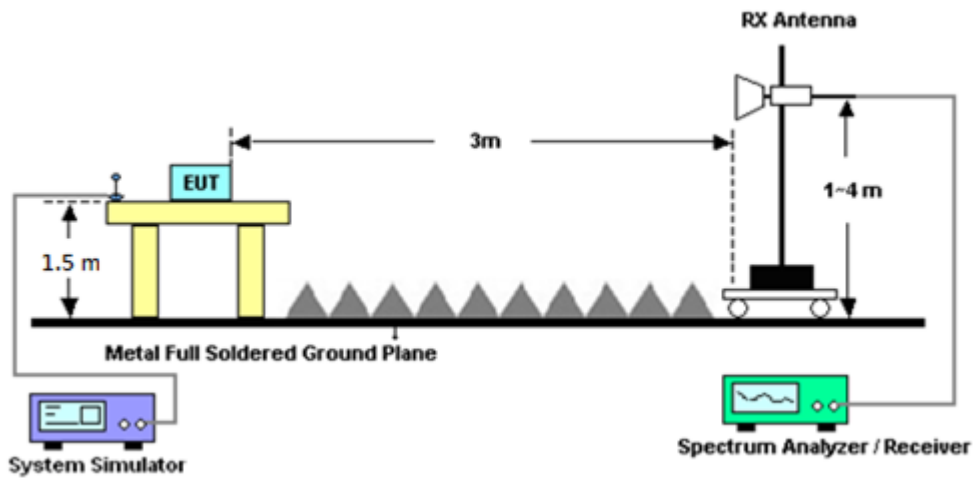

For radiated test above 18GHz

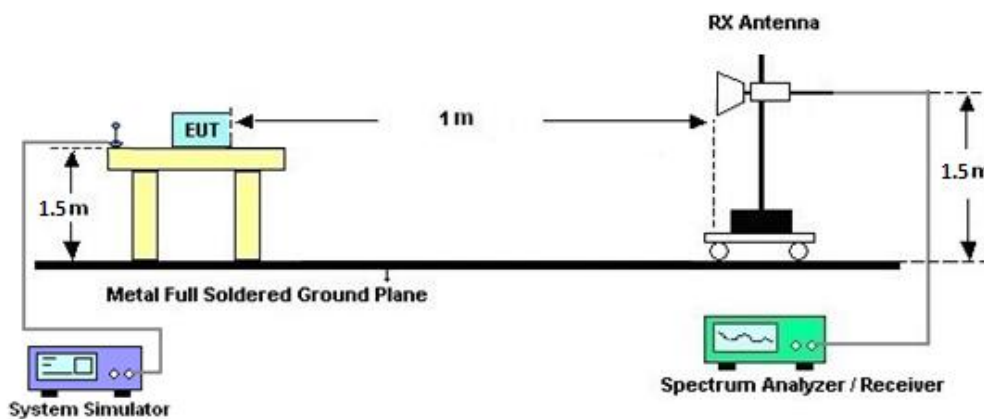

4.1.2 Test Result of Radiated Test

Please refer to Appendix B.

Note:

The low frequency, which started from 9 kHz to 30MHz, was pre-scanned and the result which was 20dB lower than the limit line was not reported.

There is adequate comparison measurement of both open-field test site and alternative test site - semi-Anechoic chamber according to 414788 D01 Radiated Test Site v01r01, and the result came out very similar.



4.2 Radiated Spurious Emission Measurement

4.2.1 Description of Radiated Spurious Emission Measurement

The radiated spurious emission was measured by substitution method according to ANSI / TIA-603-E. The power of any emission outside of the authorized operating frequency ranges must be attenuated below the transmitter power (P) by a factor of at least $43 + 10 \log (P)$ dB.

For 5G NR n7, n38, n41

The power of any emission outside of the authorized operating frequency ranges must be attenuated below the transmitter power (P) by a factor of at least $55 + 10 \log (P)$ dB.

The spectrum is scanned from 30 MHz up to a frequency including its 10th harmonic.

4.2.2 Test Procedures

The testing follows FCC KDB 971168 D01 v03r01 Section 7 and ANSI / TIA-603-E Section 2.2.12.

1. The EUT was placed on a turntable with 0.8 meter for frequency below 1GHz and 1.5 meter for frequency above 1GHz respectively above ground.
2. The EUT was set 3 meters from the receiving antenna, which was mounted on the antenna tower.
3. The table was rotated 360 degrees to determine the position of the highest spurious emission.
4. The height of the receiving antenna is varied between one meter and four meters to search the maximum spurious emission for both horizontal and vertical polarizations.
5. Make the measurement with the spectrum analyzer's RBW = 1MHz, VBW = 3MHz, taking the record of maximum spurious emission.
6. A horn antenna was substituted in place of the EUT and was driven by a signal generator.
7. Tune the output power of signal generator to the same emission level with EUT maximum spurious emission.
8. Taking the record of output power at antenna port.
9. Repeat step 7 to step 8 for another polarization.
10. The RF fundamental frequency should be excluded against the limit line in the operating frequency band.

The limit line is derived from $43 + 10\log(P)$ dB below the transmitter power P(Watts)

For 5G NR n7, n38, n41

The limit line is derived from $55 + 10\log(P)$ dB below the transmitter power P(Watts)

EIRP (dBm) = S.G. Power – Tx Cable Loss + Tx Antenna Gain

ERP (dBm) = EIRP - 2.15



5 List of Measuring Equipment

Instrument	Brand Name	Model No.	Serial No.	Characteristics	Calibration Date	Test Date	Due Date	Remark
Programmable Power Supply	GW Instek	PSS-2005	EL883644	50Hz~60Hz	Dec. 03, 2021	Aug. 01, 2022~ Nov. 24, 2022	Dec. 02, 2023	Conducted (TH03-HY)
Hygrometer	Testo	608-H11	34893241	NA	Mar. 18, 2022	Aug. 01, 2022~ Nov. 24, 2022	Mar. 17, 2023	Conducted (TH03-HY)
Signal Analyzer	Rohde & Schwarz	FSV3044	101048	10Hz~44GHz	May 05, 2022	Aug. 01 2022~ Nov. 24, 2022	May 04, 2023	Conducted (TH03-HY)
Temperature Chamber	ESPEC	SH-641	92013720	-40℃ ~90℃	Sep. 09, 2021	Aug. 01, 2022~ Sep. 07, 2022	Sep. 08, 2022	Conducted (TH03-HY)
Temperature Chamber	ESPEC	SH-641	92013720	-40℃ ~90℃	Sep. 07, 2022	Sep. 08, 2022~ Nov. 24, 2022	Sep. 06, 2023	Conducted (TH03-HY)
Base Station (Measure)	Anritsu	MT8821C	6262116730	LTE	Jun. 15, 2021	Aug. 01, 2022~ Nov. 24, 2022	Jun. 14, 2023	Conducted (TH03-HY)
Base Station (Measure)	Anritsu	MT8000A	6262134933	FR1	Jun. 13, 2022	Aug. 01, 2022~ Nov. 24, 2022	Jun. 12, 2023	Conducted (TH03-HY)
Loop Antenna	Rohde & Schwarz	HFH2-Z2	100488	9 kHz~30 MHz	May 13, 2022	Jul. 29, 2022~ Aug. 11, 2022	May 12, 2023	Radiation (03CH07-HY)
RF Cable	HUBER + SUHNER	SUCOFLEX 104	MY9837/4PE	9kHz~30MHz	Mar. 10, 2022	Jul. 29, 2022~ Aug. 11, 2022	Mar. 09, 2023	Radiation (03CH07-HY)
Bilog Antenna	TESEQ	CBL 6111D & 00800N1D01N-06	35419 & 03	30MHz~1GHz	Apr. 24, 2022	Jul. 29, 2022~ Aug. 11, 2022	Apr. 23, 2023	Radiation (03CH07-HY)
Double Ridge Horn Antenna	ESCO	3117	00075962	1GHz ~ 18GHz	Dec. 03, 2021	Jul. 29, 2022~ Aug. 11, 2022	Dec. 02, 2022	Radiation (03CH07-HY)
Preamplifier	MITEQ	AMF-7D-0010 1800-30-10P	1590075	1GHz~18GHz	Apr. 21, 2022	Jul. 29, 2022~ Aug. 11, 2022	Apr. 20, 2023	Radiation (03CH07-HY)
Preamplifier	COM-POWER	PA-103A	161241	10MHz~1GHz	Oct. 04, 2021	Jul. 29, 2022~ Aug. 11, 2022	Oct. 03, 2022	Radiation (03CH07-HY)
Preamplifier	Agilent	8449B	3008A02362	1GHz~26.5GHz	Oct. 04, 2021	Jul. 29, 2022~ Aug. 11, 2022	Oct. 03, 2022	Radiation (03CH07-HY)
Preamplifier	EMEC	EM18G40G	0600789	18-40GHz	Jul. 21, 2022	Jul. 29, 2022~ Aug. 11, 2022	Jul. 20, 2023	Radiation (03CH07-HY)
Spectrum Analyzer	Agilent	N9030A	MY52350276	3Hz~44GHz	Jul. 22, 2022	Jul. 29, 2022~ Aug. 11, 2022	Jul. 21, 2023	Radiation (03CH07-HY)
RF Cable	HUBER + SUHNER	SUCOFLEX 104	MY15682/4	30MHz to 18GHz	Feb. 23, 2022	Jul. 29, 2022~ Aug. 11, 2022	Feb. 22, 2023	Radiation (03CH07-HY)
RF Cable	HUBER + SUHNER	SUCOFLEX 104	MY24971/4	9kHz to 18GHz	Feb. 23, 2022	Jul. 29, 2022~ Aug. 11, 2022	Feb. 22, 2023	Radiation (03CH07-HY)
RF Cable	HUBER + SUHNER	SUCOFLEX 104	MY28655/4	9kHz to 18GHz	Feb. 23, 2022	Jul. 29, 2022~ Aug. 11, 2022	Feb. 22, 2023	Radiation (03CH07-HY)
RF Cable	HUBER + SUHNER	SUCOFLEX 126	532078/126E	30MHz~18GHz	Sep. 17, 2021	Jul. 29, 2022~ Aug. 11, 2022	Sep. 16, 2022	Radiation (03CH07-HY)
RF Cable	HUBER + SUHNER	SUCOFLEX 102	MY2858/2	18GHz~40GHz	Feb. 23, 2022	Jul. 29, 2022~ Aug. 11, 2022	Feb. 22, 2023	Radiation (03CH07-HY)
RF Cable	HUBER + SUHNER	SUCOFLEX 102	801606/2	9KHz ~ 40GHz	Apr. 14, 2022	Jul. 29, 2022~ Aug. 11, 2022	Apr. 13, 2023	Radiation (03CH07-HY)
Controller	EMEC	EM1000	N/A	Control Ant Mast	N/A	Jul. 29, 2022~ Aug. 11, 2022	N/A	Radiation (03CH07-HY)
Controller	MF	MF-7802	N/A	Control Turn table	N/A	Jul. 29, 2022~ Aug. 11, 2022	N/A	Radiation (03CH07-HY)
Antenna Mast	EMEC	AM-BS-4500E	N/A	Boresight mast 1M~4M	N/A	Jul. 29, 2022~ Aug. 11, 2022	N/A	Radiation (03CH07-HY)
Turn Table	ChainTek	Chaintek 3000	N/A	0~360 Degree	N/A	Jul. 29, 2022~ Aug. 11, 2022	N/A	Radiation (03CH07-HY)
Software	Audix	E3	N/A	N/A	N/A	Jul. 29, 2022~ Aug. 11, 2022	N/A	Radiation (03CH07-HY)



Instrument	Brand Name	Model No.	Serial No.	Characteristics	Calibration Date	Test Date	Due Date	Remark
USB Data Logger	TECPEL	TR-32	HE17XB2495	N/A	Mar. 07, 2022	Jul. 29, 2022~ Aug. 11, 2022	Mar. 06, 2023	Radiation (03CH07-HY)
Horn Antenna	ETS-Lindgren	3117	00143261	1GHz~18GHz	Feb. 11, 2022	Jul. 29, 2022~ Aug. 11, 2022	Feb. 10, 2023	Radiation (03CH07-HY)
SHF-EHF Horn Antenna	SCHWARZBECK	BBHA 9170	BBHA917025 1	18GHz~40GHz	Nov. 30, 2021	Jul. 29, 2022~ Aug. 11, 2022	Nov. 29, 2022	Radiation (03CH07-HY)
Signal Generator	Anritsu	MG3710A	6261943042	2G / 3G / LTE / 5G FR1	May 23, 2022	Jul. 29, 2022~ Aug. 11, 2022	May 22, 2023	Radiation (03CH07-HY)
DC Power Supply	GW Instek	GPE-2323	GEU871219	0V~64V ; 0A~6A	Dec. 21, 2021	Jul. 29, 2022~ Aug. 11, 2022	Dec. 20, 2022	Radiation (03CH07-HY)



6 Uncertainty of Evaluation

Uncertainty of Radiated Emission Measurement (30 MHz ~ 1000 MHz)

Measuring Uncertainty for a Level of Confidence of 95% ($U = 2Uc(y)$)	3.25 dB
---	---------

Uncertainty of Radiated Emission Measurement (1 GHz ~ 18 GHz)

Measuring Uncertainty for a Level of Confidence of 95% ($U = 2Uc(y)$)	3.50 dB
---	---------

Uncertainty of Radiated Emission Measurement (18 GHz ~ 40 GHz)

Measuring Uncertainty for a Level of Confidence of 95% ($U = 2Uc(y)$)	4.08 dB
---	---------



Appendix A. Test Results of Conducted Test

<SISO Mode>

Conducted Output Power(Average power) and ERP/EIRP

NR n2 Maximum Average Power [dBm] (GT - LC = 5.9 dB)								
BW [MHz]	RB Size	RB Offset	Mod	Lowest	Middle	Highest	EIRP (dBm)	EIRP(W)
5	1	1	PI/2 BPSK	23.67	23.43	23.36	29.58	0.9078
5	1	23		23.53	23.32	23.24		
5	12	6		23.62	23.41	23.29		
5	1	0		23.13	22.89	22.83		
5	1	24		23.01	22.85	22.70		
5	25	0		23.21	22.97	22.81		
5	1	1	QPSK	23.68	23.52	23.29		
5	1	23		23.56	23.36	23.26		
5	12	6		23.62	23.46	23.32		
5	1	0		22.62	22.47	23.38		
5	1	24		22.58	23.33	22.25		
5	25	0		22.69	22.43	22.26		
5	1	1	16-QAM	22.65	22.49	22.38	28.55	0.7161
5	1	1	64-QAM	21.02	21.24	21.06		
5	1	1	256-QAM	18.65	18.55	18.38		
Limit	EIRP < 2W			Result			Pass	

NR n2 Maximum Average Power [dBm] (GT - LC = 5.9 dB)								
BW [MHz]	RB Size	RB Offset	Mod	Lowest	Middle	Highest	EIRP (dBm)	EIRP(W)
10	1	1	PI/2 BPSK	23.83	23.41	23.41	29.73	0.9397
10	1	50		23.61	23.26	23.31		
10	25	12		23.72	23.38	23.31		
10	1	0		23.28	22.96	22.85		
10	1	51		23.09	22.75	22.77		
10	50	0		23.22	22.94	22.81		
10	1	1	QPSK	22.87	23.44	23.42		
10	1	50		23.71	23.26	23.25		
10	25	12		23.78	23.45	23.38		
10	1	0		22.86	22.39	22.35		
10	1	51		22.51	22.26	22.29		
10	50	0		22.87	22.45	22.32		
10	1	1	16-QAM	22.93	22.52	22.45	28.83	0.7638
10	1	1	64-QAM	21.48	20.91	21.02		
10	1	1	256-QAM	18.93	18.45	18.42		
Limit	EIRP < 2W			Result			Pass	



NR n2 Maximum Average Power [dBm] (GT - LC = 5.9 dB)										
BW [MHz]	RB Size	RB Offset	Mod	Lowest	Middle	Highest	EIRP (dBm)	EIRP(W)		
15	1	1	PI/2 BPSK	23.72	23.56	23.41	29.65	0.9226		
15	1	77		23.61	23.52	23.39				
15	36	18		23.75	23.54	23.41				
15	1	0		23.19	23.10	22.89				
15	1	78		23.07	23.03	22.94				
15	75	0		23.21	23.07	22.98				
15	1	1	QPSK	23.73	23.58	23.38			28.77	0.7534
15	1	77		23.59	23.52	23.37				
15	36	18		23.72	23.45	23.46				
15	1	0		22.66	22.64	22.42				
15	1	78		22.59	22.53	22.36				
15	75	0		22.71	22.51	22.44				
15	1	1	16-QAM	22.87	22.62	22.45	28.77	0.7534		
15	1	1	64-QAM	21.16	21.39	20.98				
15	1	1	256-QAM	18.78	18.68	18.57				
Limit	EIRP < 2W			Result			Pass			

NR n2 Maximum Average Power [dBm] (GT - LC = 5.9 dB)										
BW [MHz]	RB Size	RB Offset	Mod	Lowest	Middle	Highest	EIRP (dBm)	EIRP(W)		
20	1	1	PI/2 BPSK	23.19	23.53	23.54	29.59	0.9099		
20	1	104		23.64	23.42	23.48				
20	50	25		23.68	23.49	23.48				
20	1	0		23.22	23.01	22.95				
20	1	105		23.01	22.89	22.95				
20	100	0		23.16	23.05	22.94				
20	1	1	QPSK	23.65	23.52	23.45			28.74	0.7482
20	1	104		23.54	23.38	23.46				
20	50	25		23.69	23.49	23.47				
20	1	0		22.65	22.47	22.45				
20	1	105		22.54	22.36	22.48				
20	100	0		22.74	22.58	22.46				
20	1	1	16-QAM	22.84	22.57	22.48	28.74	0.7482		
20	1	1	64-QAM	21.21	21.11	21.25				
20	1	1	256-QAM	18.82	18.62	18.61				
Limit	EIRP < 2W			Result			Pass			



NR n5 Maximum Average Power [dBm] (GT - LC = 3.5 dB)								
BW [MHz]	RB Size	RB Offset	Mod	Lowest	Middle	Highest	ERP (dBm)	ERP(W)
5	1	1	PI/2 BPSK	22.97	23.08	23.11	24.54	0.2844
5	1	23		22.99	23.19	23.09		
5	12	6		22.98	23.09	23.13		
5	1	0		22.48	22.71	22.68		
5	1	24		22.47	22.65	22.60		
5	25	0		22.55	22.62	22.59		
5	1	1	QPSK	22.96	23.08	23.05		
5	1	23		22.94	23.09	23.09		
5	12	6		23.07	23.12	23.14		
5	1	0		21.98	22.18	22.23		
5	1	24		21.94	22.13	22.09		
5	25	0		22.02	22.13	22.12		
5	1	1	16-QAM	22.01	22.03	21.98	23.38	0.2178
5	1	1	64-QAM	20.42	20.83	20.76		
5	1	1	256-QAM	18.03	18.25	18.27		
Limit	ERP < 7W			Result			Pass	

NR n5 Maximum Average Power [dBm] (GT - LC = 3.5 dB)								
BW [MHz]	RB Size	RB Offset	Mod	Lowest	Middle	Highest	ERP (dBm)	ERP(W)
10	1	1	PI/2 BPSK	22.85	22.92	22.95	24.52	0.2831
10	1	50		22.92	23.06	22.88		
10	25	12		23.03	23.17	23.04		
10	1	0		22.45	22.57	22.55		
10	1	51		22.49	22.55	22.41		
10	50	0		22.54	22.68	22.58		
10	1	1	QPSK	22.83	23.01	22.94		
10	1	50		22.94	23.02	22.96		
10	25	12		23.01	23.14	23.05		
10	1	0		21.93	22.12	22.01		
10	1	51		21.89	22.02	21.87		
10	50	0		22.03	22.15	22.02		
10	1	1	16-QAM	21.88	22.03	21.96	23.38	0.2178
10	1	1	64-QAM	20.32	20.44	20.42		
10	1	1	256-QAM	18.01	18.12	17.89		
Limit	ERP < 7W			Result			Pass	



NR n5 Maximum Average Power [dBm] (GT - LC = 3.5 dB)								
BW [MHz]	RB Size	RB Offset	Mod	Lowest	Middle	Highest	ERP (dBm)	ERP(W)
15	1	1	PI/2 BPSK	23.54	23.68	23.65	25.12	0.3251
15	1	77		23.65	23.73	23.71		
15	36	18		23.64	23.67	23.71		
15	1	0		23.14	23.37	23.27		
15	1	78		23.19	23.22	23.25		
15	75	0		23.16	23.23	23.16		
15	1	1	QPSK	23.42	23.73	23.65		
15	1	77		23.55	23.75	23.74		
15	36	18		23.62	23.70	23.77		
15	1	0		22.56	22.93	22.76		
15	1	78		22.61	22.75	22.68		
15	75	0		22.62	22.73	22.63		
15	1	1	16-QAM	22.68	22.73	22.62	24.08	0.2559
15	1	1	64-QAM	20.83	21.36	21.45		
15	1	1	256-QAM	18.64	18.92	18.83		
Limit	ERP < 7W			Result			Pass	

NR n5 Maximum Average Power [dBm] (GT - LC = 3.5 dB)								
BW [MHz]	RB Size	RB Offset	Mod	Lowest	Middle	Highest	ERP (dBm)	ERP(W)
20	1	1	PI/2 BPSK	23.47	23.57	23.56	25.13	0.3258
20	1	104		23.64	23.63	23.65		
20	50	25		23.67	23.75	23.77		
20	1	0		23.19	23.08	23.24		
20	1	105		23.04	23.09	23.16		
20	100	0		23.16	23.24	23.19		
20	1	1	QPSK	23.43	23.65	23.58		
20	1	104		23.54	23.69	23.65		
20	50	25		23.69	23.76	23.78		
20	1	0		22.61	22.88	22.69		
20	1	105		22.59	22.69	22.58		
20	100	0		22.73	22.76	22.71		
20	1	1	16-QAM	22.56	22.61	22.64	23.99	0.2506
20	1	1	64-QAM	20.62	21.32	21.01		
20	1	1	256-QAM	18.56	18.61	18.83		
Limit	ERP < 7W			Result			Pass	



NR n7 Maximum Average Power [dBm] (GT - LC = 3.8 dB)								
BW [MHz]	RB Size	RB Offset	Mod	Lowest	Middle	Highest	EIRP (dBm)	EIRP(W)
5	1	1	PI/2 BPSK	23.19	23.15	23.25	27.24	0.5297
5	1	23		23.30	23.32	23.42		
5	12	6		23.27	23.23	23.38		
5	1	0		22.70	22.76	22.83		
5	1	24		22.77	22.79	22.91		
5	25	0		22.78	22.72	22.92		
5	1	1	QPSK	23.25	23.18	23.35		
5	1	23		23.27	23.30	23.44		
5	12	6		23.37	23.29	23.34		
5	1	0		22.16	22.28	22.32		
5	1	24		22.22	22.32	22.36		
5	25	0		22.35	22.18	22.17		
5	1	1	16-QAM	22.35	22.18	22.35	26.15	0.4121
5	1	1	64-QAM	20.76	20.86	21.06		
5	1	1	256-QAM	18.25	18.23	18.46		
Limit	EIRP < 2W			Result			Pass	

NR n7 Maximum Average Power [dBm] (GT - LC = 3.8 dB)								
BW [MHz]	RB Size	RB Offset	Mod	Lowest	Middle	Highest	EIRP (dBm)	EIRP(W)
10	1	1	PI/2 BPSK	23.08	23.13	23.17	27.14	0.5176
10	1	50		23.15	23.17	23.34		
10	25	12		23.14	23.30	23.32		
10	1	0		22.58	22.71	22.75		
10	1	51		22.67	22.72	22.76		
10	50	0		22.58	22.74	22.88		
10	1	1	QPSK	23.10	23.12	23.26		
10	1	50		23.17	23.19	23.21		
10	25	12		23.15	23.26	23.23		
10	1	0		22.11	22.09	22.14		
10	1	51		22.16	22.14	22.20		
10	50	0		22.13	22.23	22.21		
10	1	1	16-QAM	22.12	22.09	22.45	26.25	0.4217
10	1	1	64-QAM	20.76	20.52	20.45		
10	1	1	256-QAM	18.26	18.16	18.25		
Limit	EIRP < 2W			Result			Pass	



NR n7 Maximum Average Power [dBm] (GT - LC = 3.8 dB)										
BW [MHz]	RB Size	RB Offset	Mod	Lowest	Middle	Highest	EIRP (dBm)	EIRP(W)		
15	1	1	PI/2 BPSK	23.23	23.47	23.51	27.45	0.5559		
15	1	77		23.43	23.38	23.65				
15	36	18		23.25	23.42	23.54				
15	1	0		22.79	22.87	23.10				
15	1	78		22.92	22.48	23.12				
15	75	0		22.88	22.95	23.05				
15	1	1	QPSK	23.22	23.44	23.46			26.27	0.4236
15	1	77		23.35	23.37	23.61				
15	36	18		23.28	23.43	23.56				
15	1	0		22.26	22.45	22.57				
15	1	78		22.34	22.35	22.56				
15	75	0		22.24	22.35	22.49				
15	1	1	16-QAM	22.46	22.43	22.47	26.27	0.4236		
15	1	1	64-QAM	20.55	21.08	21.14				
15	1	1	256-QAM	18.48	18.57	18.61				
Limit	EIRP < 2W			Result			Pass			

NR n7 Maximum Average Power [dBm] (GT - LC = 3.8 dB)										
BW [MHz]	RB Size	RB Offset	Mod	Lowest	Middle	Highest	EIRP (dBm)	EIRP(W)		
20	1	1	PI/2 BPSK	23.32	23.37	23.32	27.34	0.542		
20	1	104		23.42	23.44	23.48				
20	50	25		23.47	23.35	23.54				
20	1	0		22.91	22.86	23.02				
20	1	105		23.01	22.81	22.97				
20	100	0		22.95	22.84	23.02				
20	1	1	QPSK	23.21	23.35	23.32			26.26	0.4227
20	1	104		23.45	23.36	23.40				
20	50	25		23.42	23.36	23.47				
20	1	0		22.32	22.34	22.43				
20	1	105		22.30	22.24	22.41				
20	100	0		22.45	22.35	22.49				
20	1	1	16-QAM	22.35	22.32	22.46	26.26	0.4227		
20	1	1	64-QAM	20.78	21.18	21.05				
20	1	1	256-QAM	18.49	18.45	18.42				
Limit	EIRP < 2W			Result			Pass			



NR n25 Maximum Average Power [dBm] (GT - LC = 5.9 dB)								
BW [MHz]	RB Size	RB Offset	Mod	Lowest	Middle	Highest	EIRP (dBm)	EIRP(W)
5	1	1	PI/2 BPSK	23.51	23.38	23.35	29.45	0.881
5	1	23		23.53	23.29	23.25		
5	12	6		23.54	23.35	23.34		
5	1	0		23.08	22.81	22.86		
5	1	24		23.03	22.78	22.75		
5	25	0		23.09	22.81	22.91		
5	1	1	QPSK	23.54	23.31	23.24		
5	1	23		23.55	23.24	23.23		
5	12	6		23.53	23.30	23.38		
5	1	0		22.54	22.29	22.36		
5	1	24		22.53	22.27	22.26		
5	25	0		22.54	22.45	22.34		
5	1	1	16-QAM	22.62	22.35	22.35	28.52	0.7112
5	1	1	64-QAM	21.29	20.87	20.70		
5	1	1	256-QAM	18.63	18.54	18.45		
Limit	EIRP < 2W			Result			Pass	

NR n25 Maximum Average Power [dBm] (GT - LC = 5.9 dB)								
BW [MHz]	RB Size	RB Offset	Mod	Lowest	Middle	Highest	EIRP (dBm)	EIRP(W)
10	1	1	PI/2 BPSK	23.51	23.27	23.38	29.53	0.8974
10	1	50		23.46	23.19	23.32		
10	25	12		23.62	23.36	23.43		
10	1	0		23.06	22.78	22.95		
10	1	51		22.96	22.69	22.76		
10	50	0		23.15	22.85	22.95		
10	1	1	QPSK	23.54	23.30	23.40		
10	1	50		23.54	23.14	23.39		
10	25	12		23.63	23.35	23.43		
10	1	0		22.49	22.24	22.45		
10	1	51		22.37	22.13	22.34		
10	50	0		22.61	22.30	22.38		
10	1	1	16-QAM	22.63	22.26	22.38	28.53	0.7129
10	1	1	64-QAM	21.01	20.76	21.15		
10	1	1	256-QAM	18.65	18.36	18.45		
Limit	EIRP < 2W			Result			Pass	



NR n25 Maximum Average Power [dBm] (GT - LC = 5.9 dB)										
BW [MHz]	RB Size	RB Offset	Mod	Lowest	Middle	Highest	EIRP (dBm)	EIRP(W)		
15	1	1	PI/2 BPSK	23.81	23.47	23.43	29.71	0.9354		
15	1	77		23.62	23.40	23.45				
15	36	18		23.75	23.46	23.55				
15	1	0		23.27	22.91	23.01				
15	1	78		23.19	22.87	22.94				
15	75	0		23.28	22.94	22.95				
15	1	1	QPSK	23.80	23.47	23.48			28.68	0.7379
15	1	77		23.66	23.41	23.37				
15	36	18		23.71	23.41	23.41				
15	1	0		22.84	22.43	22.48				
15	1	78		22.63	22.32	22.43				
15	75	0		22.71	22.45	22.43				
15	1	1	16-QAM	22.78	22.65	22.64	28.68	0.7379		
15	1	1	64-QAM	20.98	20.75	20.58				
15	1	1	256-QAM	19.15	18.42	18.54				
Limit	EIRP < 2W			Result			Pass			

NR n25 Maximum Average Power [dBm] (GT - LC = 5.9 dB)										
BW [MHz]	RB Size	RB Offset	Mod	Lowest	Middle	Highest	EIRP (dBm)	EIRP(W)		
20	1	1	PI/2 BPSK	23.62	23.47	23.45	29.53	0.8974		
20	1	104		23.46	23.43	23.48				
20	50	25		23.63	23.41	23.49				
20	1	0		23.04	22.99	22.93				
20	1	105		22.96	22.89	22.92				
20	100	0		23.10	22.94	22.95				
20	1	1	QPSK	23.57	23.49	23.36			28.65	0.7328
20	1	104		23.46	23.34	23.40				
20	50	25		23.63	23.45	23.49				
20	1	0		22.62	22.54	22.42				
20	1	105		22.43	22.45	22.38				
20	100	0		22.63	22.44	22.48				
20	1	1	16-QAM	22.75	22.57	22.51	28.65	0.7328		
20	1	1	64-QAM	21.10	21.45	20.98				
20	1	1	256-QAM	18.65	18.56	18.53				
Limit	EIRP < 2W			Result			Pass			



NR n38 Maximum Average Power [dBm] (GT - LC = 3.8 dB)								
BW [MHz]	RB Size	RB Offset	Mod	Lowest	Middle	Highest	EIRP (dBm)	EIRP(W)
20	1	1	PI/2 BPSK	23.95	23.89	23.92	27.92	0.6194
20	1	49		24.01	23.75	23.69		
20	25	12		24.12	23.98	23.96		
20	1	0		23.42	23.45	23.36		
20	1	50		23.54	23.35	23.14		
20	50	0		23.52	23.44	23.42		
20	1	1	QPSK	23.95	23.88	23.92	26.78	0.4764
20	1	49		24.01	23.80	23.65		
20	25	12		24.11	23.96	23.92		
20	1	0		22.92	22.88	22.89		
20	1	50		23.02	22.78	22.63		
20	50	0		23.05	22.91	22.93		
20	1	1	16-QAM	22.98	22.85	22.89	26.78	0.4764
20	1	1	64-QAM	21.48	21.34	21.35		
20	1	1	256-QAM	19.20	19.23	19.25		
Limit	EIRP < 2W			Result			Pass	



NR n38 Maximum Average Power [dBm] (GT - LC = 3.8 dB)								
BW [MHz]	RB Size	RB Offset	Mod	Lowest	Middle	Highest	EIRP (dBm)	EIRP(W)
30	1	1	PI/2 BPSK	23.91	23.92	23.94	27.77	0.5984
30	1	76		23.92	23.72	23.46		
30	36	18		23.97	23.91	23.75		
30	1	0		23.50	23.42	23.34		
30	1	77		23.41	23.17	22.86		
30	75	0		23.48	23.03	23.18		
30	1	1	QPSK	23.86	23.95	23.91		
30	1	76		23.96	23.69	23.47		
30	36	18		23.95	23.92	23.75		
30	1	0		22.85	22.93	22.74		
30	1	77		22.89	22.64	22.43		
30	75	0		22.98	22.51	22.68		
30	1	1	16-QAM	22.86	22.81	22.85	26.66	0.4634
30	1	1	64-QAM	21.48	21.47	21.42		
30	1	1	256-QAM	19.17	19.22	19.22		
Limit	EIRP < 2W			Result			Pass	

NR n38 Maximum Average Power [dBm] (GT - LC = 3.8 dB)								
BW [MHz]	RB Size	RB Offset	Mod	Lowest	Middle	Highest	EIRP (dBm)	EIRP(W)
40	1	1	PI/2 BPSK	23.98	23.78	24.02	27.86	0.6109
40	1	104		23.74	23.54	23.53		
40	50	25		24.06	23.59	24.01		
40	1	0		23.51	23.42	23.51		
40	1	105		23.24	22.97	23.06		
40	100	0		23.48	23.40	23.46		
40	1	1	QPSK	24.02	23.95	24.05		
40	1	104		23.75	23.54	23.57		
40	50	25		24.05	23.52	24.01		
40	1	0		22.96	22.93	23.10		
40	1	105		22.73	22.49	22.53		
40	100	0		23.02	22.91	22.94		
40	1	1	16-QAM	22.97	22.93	23.08	26.88	0.4875
40	1	1	64-QAM	21.45	21.46	21.65		
40	1	1	256-QAM	19.23	19.25	19.38		
Limit	EIRP < 2W			Result			Pass	



NR n41 HPUE Maximum Average Power [dBm] (GT - LC = 3.8 dB)								
BW [MHz]	RB Size	RB Offset	Mod	Lowest	Middle	Highest	EIRP (dBm)	EIRP(W)
20	1	1	PI/2 BPSK	26.18	26.59	26.21	30.45	1.1092
20	1	49		26.33	26.54	25.98		
20	25	12		26.38	26.65	26.23		
20	1	0		22.76	23.09	22.71		
20	1	50		22.79	22.78	22.63		
20	50	0		25.89	26.20	25.72		
20	1	1	QPSK	26.15	26.62	26.16		
20	1	49		26.29	26.49	25.87		
20	25	12		26.32	26.58	26.21		
20	1	0		22.78	23.10	22.69		
20	1	50		22.84	23.02	22.75		
20	50	0		25.39	25.65	25.23		
20	1	1	16-QAM	25.29	25.75	25.32	29.55	0.9016
20	1	1	64-QAM	23.75	24.19	23.75		
20	1	1	256-QAM	21.46	21.90	21.48		
Limit	EIRP < 2W			Result			Pass	

NR n41 HPUE Maximum Average Power [dBm] (GT - LC = 3.8 dB)								
BW [MHz]	RB Size	RB Offset	Mod	Lowest	Middle	Highest	EIRP (dBm)	EIRP(W)
30	1	1	PI/2 BPSK	26.25	26.64	26.41	30.44	1.1066
30	1	76		26.54	26.52	26.05		
30	36	18		26.39	26.54	26.38		
30	1	0		22.86	23.09	22.93		
30	1	77		23.01	23.03	22.80		
30	75	0		25.98	26.15	25.98		
30	1	1	QPSK	26.21	26.61	26.42		
30	1	76		26.46	26.54	26.01		
30	36	18		26.42	26.56	26.38		
30	1	0		22.82	23.12	22.91		
30	1	77		22.95	23.04	22.69		
30	75	0		25.44	25.62	25.43		
30	1	1	16-QAM	25.35	25.71	25.58	29.51	0.8933
30	1	1	64-QAM	23.87	24.24	24.02		
30	1	1	256-QAM	21.49	21.98	21.72		
Limit	EIRP < 2W			Result			Pass	



NR n41 HPUE Maximum Average Power [dBm] (GT - LC = 3.8 dB)								
BW [MHz]	RB Size	RB Offset	Mod	Lowest	Middle	Highest	EIRP (dBm)	EIRP(W)
40	1	1	PI/2 BPSK	26.50	26.73	26.24	30.53	1.1298
40	1	104		26.43	26.53	26.34		
40	50	25		26.29	26.64	26.33		
40	1	0		22.82	23.25	22.84		
40	1	105		22.87	23.05	22.86		
40	100	0		25.84	26.16	25.81		
40	1	1	QPSK	26.24	26.73	26.22		
40	1	104		26.38	26.51	26.35		
40	50	25		26.31	26.55	26.25		
40	1	0		22.83	23.22	22.86		
40	1	105		22.87	23.01	22.93		
40	100	0		25.30	25.64	25.34		
40	1	1	16-QAM	25.33	25.82	25.24	29.62	0.9162
40	1	1	64-QAM	23.84	24.32	23.34		
40	1	1	256-QAM	21.54	21.98	21.55		
Limit	EIRP < 2W			Result			Pass	

NR n41 HPUE Maximum Average Power [dBm] (GT - LC = 3.8 dB)								
BW [MHz]	RB Size	RB Offset	Mod	Lowest	Middle	Highest	EIRP (dBm)	EIRP(W)
50	1	1	PI/2 BPSK	26.27	26.61	26.54	30.45	1.1092
50	1	131		26.46	26.49	25.87		
50	64	32		26.43	26.63	26.41		
50	1	0		22.98	23.14	23.02		
50	1	132		22.89	22.96	22.77		
50	128	0		25.98	26.13	25.92		
50	1	1	QPSK	26.23	26.63	26.54		
50	1	131		26.46	26.44	26.02		
50	64	32		26.48	26.65	26.48		
50	1	0		22.98	23.12	23.01		
50	1	132		22.98	22.93	22.87		
50	128	0		25.49	25.62	25.46		
50	1	1	16-QAM	25.46	25.76	25.65	29.56	0.9036
50	1	1	64-QAM	23.84	24.21	24.07		
50	1	1	256-QAM	21.57	21.89	21.78		
Limit	EIRP < 2W			Result			Pass	



NR n41 HPUE Maximum Average Power [dBm] (GT - LC = 3.8 dB)								
BW [MHz]	RB Size	RB Offset	Mod	Lowest	Middle	Highest	EIRP (dBm)	EIRP(W)
60	1	1	PI/2 BPSK	26.10	26.63	26.26	30.43	1.1041
60	1	160		26.43	26.42	25.98		
60	81	40		26.43	26.55	26.34		
60	1	0		22.87	23.10	22.81		
60	1	161		22.94	22.89	22.68		
60	162	0		25.87	26.08	25.89		
60	1	1	QPSK	26.14	26.61	26.36		
60	1	160		26.38	26.37	25.90		
60	81	40		26.39	26.56	26.35		
60	1	0		22.96	23.08	22.79		
60	1	161		22.90	22.91	22.68		
60	162	0		25.37	25.57	25.36		
60	1	1	16-QAM	25.31	25.73	25.36	29.53	0.8974
60	1	1	64-QAM	23.65	24.17	23.73		
60	1	1	256-QAM	21.41	21.84	21.61		
Limit	EIRP < 2W			Result			Pass	

NR n41 HPUE Maximum Average Power [dBm] (GT - LC = 3.8 dB)								
BW [MHz]	RB Size	RB Offset	Mod	Lowest	Middle	Highest	EIRP (dBm)	EIRP(W)
80	1	1	PI/2 BPSK	25.98	26.55	26.34	30.37	1.0889
80	1	215		26.38	26.18	26.13		
80	108	54		26.22	26.52	26.19		
80	1	0		22.76	23.06	22.72		
80	1	216		22.84	22.70	22.52		
80	216	0		25.76	26.04	25.72		
80	1	1	QPSK	26.04	26.52	26.25		
80	1	215		26.32	26.16	26.01		
80	108	54		26.24	26.57	26.21		
80	1	0		22.77	23.03	22.67		
80	1	216		22.84	22.69	22.52		
80	216	0		25.23	25.57	25.19		
80	1	1	16-QAM	25.16	25.65	25.25	29.45	0.8810
80	1	1	64-QAM	23.62	24.09	23.98		
80	1	1	256-QAM	21.48	21.83	21.52		
Limit	EIRP < 2W			Result			Pass	



NR n41 HPUE Maximum Average Power [dBm] (GT - LC = 3.8 dB)								
BW [MHz]	RB Size	RB Offset	Mod	Lowest	Middle	Highest	EIRP (dBm)	EIRP(W)
90	1	1	PI/2 BPSK	26.05	26.53	26.45	30.37	1.0889
90	1	243		26.33	26.25	26.02		
90	120	60		26.28	26.57	26.32		
90	1	0		22.83	23.05	22.87		
90	1	244		22.85	22.73	22.54		
90	240	0		25.83	26.01	25.81		
90	1	1	QPSK	26.04	26.35	26.37		
90	1	243		26.28	26.16	26.01		
90	120	60		26.29	26.54	26.28		
90	1	0		22.83	23.08	22.76		
90	1	244		22.81	22.69	22.54		
90	240	0		25.31	25.54	25.28		
90	1	1	16-QAM	25.14	25.55	25.21	29.35	0.8610
90	1	1	64-QAM	23.69	24.21	23.98		
90	1	1	256-QAM	21.52	21.93	21.62		
Limit	EIRP < 2W			Result			Pass	

NR n41 HPUE Maximum Average Power [dBm] (GT - LC = 3.8 dB)								
BW [MHz]	RB Size	RB Offset	Mod	Lowest	Middle	Highest	EIRP (dBm)	EIRP(W)
100	1	1	PI/2 BPSK	26.02	26.65	26.49	30.45	1.1092
100	1	271		26.41	26.26	26.17		
100	135	67		26.19	26.62	26.26		
100	1	0		22.86	23.19	22.86		
100	1	272		22.86	22.76	22.64		
100	270	0		25.72	26.12	25.75		
100	1	1	QPSK	26.01	26.61	26.40		
100	1	271		26.32	26.27	26.08		
100	135	67		26.21	26.62	26.23		
100	1	0		22.84	23.14	22.83		
100	1	272		22.89	22.75	22.53		
100	270	0		25.23	25.58	25.23		
100	1	1	16-QAM	25.13	25.65	25.51	29.45	0.8810
100	1	1	64-QAM	23.62	24.09	23.97		
100	1	1	256-QAM	21.36	21.88	21.55		
Limit	EIRP < 2W			Result			Pass	



NR n66 Maximum Average Power [dBm] (GT - LC = 5.5 dB)								
BW [MHz]	RB Size	RB Offset	Mod	Lowest	Middle	Highest	EIRP (dBm)	EIRP(W)
5	1	1	PI/2 BPSK	22.82	23.19	23.18	28.78	0.7551
5	1	23		22.88	23.26	23.15		
5	12	6		22.82	23.25	23.28		
5	1	0		22.42	22.86	22.71		
5	1	24		22.48	22.83	22.71		
5	25	0		22.41	22.78	22.81		
5	1	1	QPSK	22.86	23.21	23.21		
5	1	23		22.92	23.26	23.19		
5	12	6		22.82	23.26	23.26		
5	1	0		21.98	22.21	22.23		
5	1	24		22.02	22.26	22.21		
5	25	0		21.95	22.31	22.36		
5	1	1	16-QAM	21.91	22.21	22.34	27.84	0.6081
5	1	1	64-QAM	20.59	20.75	20.73		
5	1	1	256-QAM	18.03	18.28	18.36		
Limit	EIRP < 1W			Result			Pass	

NR n66 Maximum Average Power [dBm] (GT - LC = 5.5 dB)								
BW [MHz]	RB Size	RB Offset	Mod	Lowest	Middle	Highest	EIRP (dBm)	EIRP(W)
10	1	1	PI/2 BPSK	22.86	23.18	23.25	28.85	0.7674
10	1	50		22.90	23.35	23.23		
10	25	12		22.98	23.26	23.31		
10	1	0		22.53	22.88	22.87		
10	1	51		22.49	22.92	22.82		
10	50	0		22.58	22.85	22.89		
10	1	1	QPSK	22.86	23.23	23.24		
10	1	50		22.86	23.31	23.23		
10	25	12		23.02	23.25	23.29		
10	1	0		22.05	22.34	22.28		
10	1	51		21.97	22.47	22.23		
10	50	0		22.12	22.36	22.35		
10	1	1	16-QAM	22.02	22.28	22.42	27.92	0.6194
10	1	1	64-QAM	20.33	21.06	20.87		
10	1	1	256-QAM	18.06	18.36	18.53		
Limit	EIRP < 1W			Result			Pass	



NR n66 Maximum Average Power [dBm] (GT - LC = 5.5 dB)								
BW [MHz]	RB Size	RB Offset	Mod	Lowest	Middle	Highest	EIRP (dBm)	EIRP(W)
15	1	1	PI/2 BPSK	22.98	23.19	23.16	28.89	0.7745
15	1	77		23.12	23.39	23.29		
15	36	18		23.03	23.38	23.14		
15	1	0		22.58	22.98	22.82		
15	1	78		22.70	22.97	22.83		
15	75	0		22.58	22.98	22.91		
15	1	1	QPSK	22.96	23.21	23.17		
15	1	77		23.11	23.35	23.18		
15	36	18		23.03	23.37	23.15		
15	1	0		22.14	22.36	22.34		
15	1	78		22.19	22.46	22.25		
15	75	0		22.17	22.51	22.35		
15	1	1	16-QAM	22.02	22.47	22.35	27.97	0.6266
15	1	1	64-QAM	20.67	20.76	20.74		
15	1	1	256-QAM	18.18	18.37	18.31		
Limit	EIRP < 1W			Result			Pass	

NR n66 Maximum Average Power [dBm] (GT - LC = 5.5 dB)								
BW [MHz]	RB Size	RB Offset	Mod	Lowest	Middle	Highest	EIRP (dBm)	EIRP(W)
20	1	1	PI/2 BPSK	22.95	23.32	23.38	28.92	0.7798
20	1	104		23.22	23.42	23.35		
20	50	25		22.98	23.34	23.23		
20	1	0		22.58	23.01	22.93		
20	1	105		22.80	23.00	22.95		
20	100	0		22.55	23.04	22.91		
20	1	1	QPSK	22.95	23.33	23.37		
20	1	104		23.24	23.36	23.29		
20	50	25		23.02	23.38	23.24		
20	1	0		22.14	22.50	22.54		
20	1	105		22.21	22.57	22.36		
20	100	0		22.13	22.51	22.39		
20	1	1	16-QAM	22.03	22.35	22.36	27.86	0.6109
20	1	1	64-QAM	20.35	20.84	21.12		
20	1	1	256-QAM	18.02	18.45	18.56		
Limit	EIRP < 1W			Result			Pass	



NR n66 Maximum Average Power [dBm] (GT - LC = 5.5 dB)								
BW [MHz]	RB Size	RB Offset	Mod	Lowest	Middle	Highest	EIRP (dBm)	EIRP(W)
30	1	1	PI/2 BPSK	23.01	23.27	23.48	29.00	0.7943
30	1	158		23.19	23.38	23.42		
30	80	40		23.13	23.41	23.49		
30	1	0		22.77	22.96	23.24		
30	1	159		22.85	23.04	23.02		
30	160	0		22.74	23.02	23.16		
30	1	1	QPSK	22.90	23.24	23.50	29.00	0.7943
30	1	158		23.21	23.44	23.45		
30	80	40		23.05	23.40	23.45		
30	1	0		22.21	22.52	22.66		
30	1	159		22.28	22.52	22.47		
30	160	0		22.28	22.49	22.61		
30	1	1	16-QAM	22.16	22.21	22.56	28.06	0.6397
30	1	1	64-QAM	20.39	20.95	21.23		
30	1	1	256-QAM	18.08	18.42	18.74		
Limit	EIRP < 1W			Result			Pass	



NR n71 Maximum Average Power [dBm] (GT - LC = 2.9 dB)								
BW [MHz]	RB Size	RB Offset	Mod	Lowest	Middle	Highest	ERP (dBm)	ERP(W)
5	1	1	PI/2 BPSK	23.11	23.25	23.32	24.16	0.2606
5	1	23		23.10	23.26	23.32		
5	12	6		23.07	23.32	23.41		
5	1	0		22.76	22.85	22.76		
5	1	24		22.65	22.75	22.79		
5	25	0		22.60	22.85	22.85		
5	1	1	QPSK	23.15	23.15	23.17		
5	1	23		23.12	23.21	23.35		
5	12	6		23.11	23.29	23.34		
5	1	0		22.39	22.29	22.28		
5	1	24		22.26	22.25	22.30		
5	25	0		22.38	22.41	22.35		
5	1	1	16-QAM	22.21	22.32	22.35	23.10	0.2042
5	1	1	64-QAM	20.98	20.75	20.72		
5	1	1	256-QAM	18.39	18.34	18.56		
Limit	ERP < 3W			Result			Pass	

NR n71 Maximum Average Power [dBm] (GT - LC = 2.9 dB)								
BW [MHz]	RB Size	RB Offset	Mod	Lowest	Middle	Highest	ERP (dBm)	ERP(W)
10	1	1	PI/2 BPSK	23.05	23.11	23.21	24.07	0.2553
10	1	50		23.14	23.24	23.17		
10	25	12		23.10	23.27	23.24		
10	1	0		22.72	22.92	22.85		
10	1	51		22.63	22.70	22.75		
10	50	0		22.62	22.73	22.70		
10	1	1	QPSK	22.96	23.08	23.19		
10	1	50		23.16	23.21	23.09		
10	25	12		23.06	23.17	23.32		
10	1	0		22.18	22.43	22.32		
10	1	51		22.10	22.19	22.21		
10	50	0		22.14	22.25	22.22		
10	1	1	16-QAM	22.11	22.25	22.41	23.16	0.2071
10	1	1	64-QAM	20.51	20.67	20.75		
10	1	1	256-QAM	18.17	18.29	18.38		
Limit	ERP < 3W			Result			Pass	



NR n71 Maximum Average Power [dBm] (GT - LC = 2.9 dB)										
BW [MHz]	RB Size	RB Offset	Mod	Lowest	Middle	Highest	ERP (dBm)	ERP(W)		
15	1	1	PI/2 BPSK	23.11	23.24	23.30	24.20	0.2630		
15	1	77		23.25	23.35	23.27				
15	36	18		23.18	23.41	23.35				
15	1	0		22.93	23.04	22.95				
15	1	78		22.73	22.83	22.74				
15	75	0		22.69	22.97	22.82				
15	1	1	QPSK	23.19	23.21	23.26			23.18	0.2080
15	1	77		23.32	23.35	23.21				
15	36	18		23.23	23.45	23.38				
15	1	0		22.41	22.54	22.39				
15	1	78		22.29	22.27	22.22				
15	75	0		22.24	22.47	22.38				
15	1	1	16-QAM	22.12	22.43	22.40	23.18	0.2080		
15	1	1	64-QAM	20.54	20.65	20.76				
15	1	1	256-QAM	18.30	18.43	18.39				
Limit	ERP < 3W			Result			Pass			

NR n71 Maximum Average Power [dBm] (GT - LC = 2.9 dB)										
BW [MHz]	RB Size	RB Offset	Mod	Lowest	Middle	Highest	ERP (dBm)	ERP(W)		
20	1	1	PI/2 BPSK	23.05	23.26	23.36	24.23	0.2649		
20	1	104		23.27	23.31	23.32				
20	50	25		23.26	23.46	23.45				
20	1	0		22.95	23.15	23.05				
20	1	105		22.77	22.83	22.82				
20	100	0		22.76	22.84	22.87				
20	1	1	QPSK	22.95	23.26	23.38			23.10	0.2042
20	1	104		23.25	23.31	23.34				
20	50	25		23.21	23.48	23.45				
20	1	0		22.29	22.74	22.61				
20	1	105		22.29	22.32	22.35				
20	100	0		22.17	22.33	22.47				
20	1	1	16-QAM	22.15	22.17	22.35	23.10	0.2042		
20	1	1	64-QAM	20.47	20.95	21.12				
20	1	1	256-QAM	18.23	18.46	18.46				
Limit	ERP < 3W			Result			Pass			



<MIMO Mode>

NR n38 UL-MIMO Maximum Average Power [dBm], DG = 3.8 dBi														
BW (MHz)	RB Size	RB Offset	Mod	Antenna 2			Antenna 0			Combine			EIRP (dBm)	EIRP (W)
				Lowest	Middle	Highest	Lowest	Middle	Highest	Lowest	Middle	Highest		
20	1	1	QPSK	19.25	19.17	19.18	19.05	18.81	19.01	22.16	22.00	22.11	26.03	0.4009
20	1	49		19.38	19.25	19.05	19.06	18.77	19.16	22.23	22.03	22.12		
20	25	12		19.31	14.13	19.08	19.03	13.96	19.18	22.18	17.06	22.14		
20	1	0		17.75	17.81	17.62	17.68	17.39	17.58	20.72	20.62	20.61		
20	1	50		17.76	17.57	17.49	17.63	17.35	17.68	20.71	20.47	20.60		
20	51	0		17.75	17.63	17.46	17.64	17.45	17.56	20.71	20.55	20.52		
20	1	1	16-QAM	18.83	18.78	18.84	18.57	18.32	18.56	21.71	21.57	21.71	25.51	0.3556
20	1	1	64-QAM	17.12	17.00	16.93	16.96	16.88	16.95	20.05	19.95	19.95		
20	1	1	256-QAM	14.35	14.25	14.25	14.16	13.99	14.19	17.27	17.13	17.23		
Limit	EIRP < 2W			Result									Pass	



NR n41 UL-MIMO Maximum Average Power [dBm], DG = 3.8 dBi														
BW (MHz)	RB Size	RB Offset	Mod	Antenna 2			Antenna 0			Combine			EIRP (dBm)	EIRP (W)
				Lowest	Middle	Highest	Lowest	Middle	Highest	Lowest	Middle	Highest		
20	1	1	QPSK	21.13	21.74	21.17	21.74	22.27	22.06	24.46	25.02	24.65	28.89	0.7745
20	1	49		21.45	21.65	21.35	21.86	22.15	21.85	24.67	24.92	24.62		
20	25	12		21.45	21.98	21.38	21.75	22.18	21.98	24.61	25.09	24.70		
20	1	0		19.35	19.86	19.37	19.68	20.26	20.15	22.53	23.07	22.79		
20	1	50		19.55	19.79	19.41	19.84	20.21	20.16	22.71	23.02	22.81		
20	51	0		20.96	20.43	19.98	20.21	20.71	20.45	23.61	23.58	23.23		
20	1	1	16-QAM	20.81	21.42	20.76	21.35	21.88	21.65	24.10	24.67	24.24	28.47	0.7031
20	1	1	64-QAM	19.35	19.98	19.25	19.56	20.09	19.78	22.47	23.05	22.53		
20	1	1	256-QAM	16.31	16.97	16.36	16.81	17.25	17.10	19.58	20.12	19.76		
Limit	EIRP < 2W			Result									Pass	

NR n41 UL-MIMO Maximum Average Power [dBm], DG = 3.8 dBi														
BW (MHz)	RB Size	RB Offset	Mod	Antenna 2			Antenna 0			Combine			EIRP (dBm)	EIRP (W)
				Lowest	Middle	Highest	Lowest	Middle	Highest	Lowest	Middle	Highest		
30	1	1	QPSK	21.45	22.21	21.24	21.85	22.26	21.89	24.66	25.25	24.59	29.06	0.8054
30	1	76		21.78	22.15	21.44	22.37	22.35	21.84	25.10	25.26	24.65		
30	39	19		21.58	22.03	21.36	21.91	22.18	21.82	24.76	25.12	24.61		
30	1	0		19.54	20.02	19.25	19.95	20.23	19.89	22.76	23.14	22.59		
30	1	77		19.83	19.85	19.52	20.01	20.32	19.95	22.93	23.10	22.75		
30	78	0		20.25	20.56	19.92	20.46	20.75	20.35	23.37	23.67	23.15		
30	1	1	16-QAM	20.85	21.54	20.68	21.52	21.96	21.52	24.21	24.77	24.13	28.57	0.7194
30	1	1	64-QAM	19.36	20.01	19.25	19.68	20.03	19.72	22.53	23.03	22.50		
30	1	1	256-QAM	16.54	17.18	16.45	17.02	17.32	16.95	19.80	20.26	19.72		
Limit	EIRP < 2W			Result									Pass	



NR n41 UL-MIMO Maximum Average Power [dBm], DG = 3.8 dBi														
BW (MHz)	RB Size	RB Offset	Mod	Antenna 2			Antenna 0			Combine			EIRP (dBm)	EIRP (W)
				Lowest	Middle	Highest	Lowest	Middle	Highest	Lowest	Middle	Highest		
40	1	1	QPSK	22.17	22.10	21.30	22.44	22.32	22.15	25.32	25.22	24.76	29.12	0.8166
40	1	104		21.86	21.88	21.56	22.32	22.35	22.04	25.10	25.13	24.82		
40	53	26		22.02	22.01	21.37	22.18	22.23	21.98	25.11	25.13	24.70		
40	1	0		20.19	20.17	19.56	20.38	20.36	20.14	23.30	23.28	22.87		
40	1	105		19.88	19.90	19.68	20.25	20.25	20.07	23.08	23.09	22.89		
40	106	0		20.62	20.63	20.01	20.85	20.83	20.55	23.75	23.74	23.30		
40	1	1	16-QAM	21.65	21.62	21.22	21.99	21.96	21.87	24.83	24.80	24.57	28.63	0.7295
40	1	1	64-QAM	20.17	20.19	19.46	20.18	20.25	19.54	23.19	23.23	22.51		
40	1	1	256-QAM	17.27	17.27	16.56	17.45	17.54	17.23	20.37	20.42	19.92		
Limit	EIRP < 2W			Result									Pass	

NR n41 UL-MIMO Maximum Average Power [dBm], DG = 3.8 dBi														
BW (MHz)	RB Size	RB Offset	Mod	Antenna 2			Antenna 0			Combine			EIRP (dBm)	EIRP (W)
				Lowest	Middle	Highest	Lowest	Middle	Highest	Lowest	Middle	Highest		
50	1	1	QPSK	21.37	21.92	21.42	21.64	22.12	22.16	24.52	25.03	24.82	28.83	0.7638
50	1	131		21.79	21.56	21.32	21.98	22.12	21.98	24.90	24.86	24.67		
50	67	33		21.96	21.85	21.30	21.75	22.15	22.06	24.87	25.01	24.71		
50	1	0		19.87	19.88	19.45	19.92	20.21	20.24	22.91	23.06	22.87		
50	1	132		19.90	19.65	19.48	20.02	20.15	19.98	22.97	22.92	22.75		
50	133	0		20.46	20.43	20.05	20.35	20.65	20.63	23.42	23.55	23.36		
50	1	1	16-QAM	21.03	21.31	21.05	21.45	21.87	21.84	24.26	24.61	24.47	28.41	0.6934
50	1	1	64-QAM	19.54	19.95	19.46	19.65	20.11	19.98	22.61	23.04	22.74		
50	1	1	256-QAM	16.52	16.91	16.58	16.87	17.26	17.32	19.71	20.10	19.98		
Limit	EIRP < 2W			Result									Pass	



NR n41 UL-MIMO Maximum Average Power [dBm], DG = 3.8 dBi														
BW (MHz)	RB Size	RB Offset	Mod	Antenna 2			Antenna 0			Combine			EIRP (dBm)	EIRP (W)
				Lowest	Middle	Highest	Lowest	Middle	Highest	Lowest	Middle	Highest		
60	1	1	QPSK	21.27	21.84	21.21	21.65	22.16	21.98	24.47	25.01	24.62	28.88	0.7727
60	1	160		21.92	21.35	21.35	21.88	21.91	21.72	24.91	24.65	24.55		
60	81	40		21.82	21.97	21.32	21.89	22.16	22.01	24.87	25.08	24.69		
60	1	0		19.58	19.95	19.35	19.76	20.23	20.02	22.68	23.10	22.71		
60	1	161		19.92	19.95	19.34	20.01	20.19	19.92	22.98	23.08	22.65		
60	162	0		20.21	20.35	19.35	20.26	20.63	20.54	23.25	23.50	23.00		
60	1	1	16-QAM	20.85	21.35	20.95	21.29	21.75	21.69	24.09	24.56	24.35	28.36	0.6855
60	1	1	64-QAM	19.35	19.98	19.58	19.46	19.99	19.93	22.42	23.00	22.77		
60	1	1	256-QAM	16.39	17.09	16.53	16.75	17.24	17.14	19.58	20.18	19.86		
Limit	EIRP < 2W			Result									Pass	

NR n41 UL-MIMO Maximum Average Power [dBm], DG = 3.8 dBi														
BW (MHz)	RB Size	RB Offset	Mod	Antenna 2			Antenna 0			Combine			EIRP (dBm)	EIRP (W)
				Lowest	Middle	Highest	Lowest	Middle	Highest	Lowest	Middle	Highest		
80	1	1	QPSK	21.04	21.79	21.57	21.42	21.96	21.84	24.24	24.89	24.72	28.69	0.7396
80	1	215		21.87	21.49	21.49	21.85	21.92	21.68	24.87	24.72	24.60		
80	109	54		21.50	21.72	21.29	21.48	21.97	21.81	24.50	24.85	24.57		
80	1	0		19.45	19.81	19.21	19.72	20.01	19.98	22.60	22.92	22.62		
80	1	216		19.76	19.24	19.41	19.85	19.92	19.74	22.82	22.60	22.59		
80	217	0		20.07	20.28	19.92	20.14	20.48	20.42	23.12	23.39	23.19		
80	1	1	16-QAM	20.48	21.38	20.81	21.10	21.62	21.45	23.81	24.51	24.15	28.31	0.6776
80	1	1	64-QAM	18.99	19.86	19.54	19.28	19.81	19.67	22.15	22.85	22.62		
80	1	1	256-QAM	16.15	16.93	16.67	16.65	17.09	16.92	19.42	20.02	19.81		
Limit	EIRP < 2W			Result									Pass	



NR n41 UL-MIMO Maximum Average Power [dBm], DG = 3.8 dBi														
BW	RB	RB	Mod	Antenna 2			Antenna 0			Combine			EIRP	EIRP
(MHz)	Size	Offset		Lowest	Middle	Highest	Lowest	Middle	Highest	Lowest	Middle	Highest	(dBm)	(W)
90	1	1	QPSK	21.12	21.73	21.51	21.47	22.01	21.78	24.31	24.88	24.66	28.74	0.7482
90	1	243		21.49	21.25	21.47	21.92	21.98	21.65	24.72	24.64	24.57		
90	123	61		21.79	21.85	21.18	21.71	22.01	21.76	24.76	24.94	24.49		
90	1	0		19.63	19.92	19.18	19.79	20.03	19.97	22.72	22.99	22.60		
90	1	244		19.68	19.33	19.43	19.84	19.92	19.70	22.77	22.65	22.58		
90	245	0		20.17	20.37	19.93	20.22	20.47	20.26	23.21	23.43	23.11		
90	1	1	16-QAM	20.82	21.38	20.95	21.15	21.67	21.42	24.00	24.54	24.20	28.34	0.6823
90	1	1	64-QAM	19.21	19.86	19.54	19.36	19.78	19.55	22.30	22.83	22.56		
90	1	1	256-QAM	16.35	17.05	16.51	16.56	17.13	16.87	19.47	20.10	19.70		
Limit	EIRP < 2W			Result									Pass	

NR n41 UL-MIMO Maximum Average Power [dBm], DG = 3.8 dBi														
BW	RB	RB	Mod	Antenna 2			Antenna 0			Combine			EIRP	EIRP
(MHz)	Size	Offset		Lowest	Middle	Highest	Lowest	Middle	Highest	Lowest	Middle	Highest	(dBm)	(W)
100	1	1	QPSK	20.97	21.68	21.57	21.45	21.97	21.85	24.23	24.84	24.72	28.65	0.7328
100	1	271		21.46	21.11	21.33	21.92	21.85	21.75	24.71	24.51	24.56		
100	137	68		21.54	21.71	21.43	21.62	21.96	21.88	24.59	24.85	24.67		
100	1	0		19.61	19.83	19.56	19.92	20.10	20.03	22.78	22.98	22.81		
100	1	272		19.41	19.29	19.57	19.95	19.91	19.68	22.70	22.62	22.64		
100	273	0		20.14	20.35	19.92	20.21	20.47	20.42	23.19	23.42	23.19		
100	1	1	16-QAM	20.54	21.28	21.16	21.07	21.68	21.49	23.82	24.49	24.34	28.29	0.6745
100	1	1	64-QAM	19.06	19.87	19.69	19.32	19.81	19.75	22.20	22.85	22.73		
100	1	1	256-QAM	16.12	16.93	16.61	16.60	17.15	17.05	19.38	20.05	19.85		
Limit	EIRP < 2W			Result									Pass	



FR1 n5

Peak-to-Average Ratio

Mode	FR1 n5 / 20MHz / DFT-S OFDM				
Mod.	PI/2 BPSK	QPSK	16QAM	64QAM	Limit: 13dB
RB Size	Full RB	Full RB	Full RB	Full RB	Result
Middle CH	4.54	5.66	6.48	6.52	PASS
Mode	FR1 n5 / 20MHz / DFT-S OFDM				
Mod.	256QAM				Limit: 13dB
RB Size	Full RB				Result
Middle CH	6.74				PASS



FR1 n5 / 20MHz / DFT-S OFDM / Middle Channel / Full RB

PI/2 BPSK

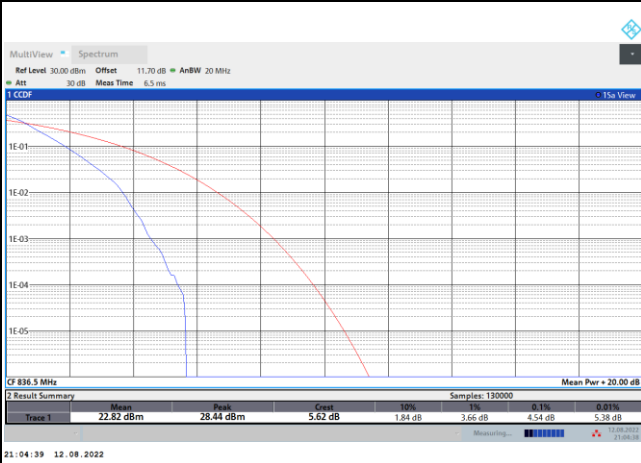

QPSK

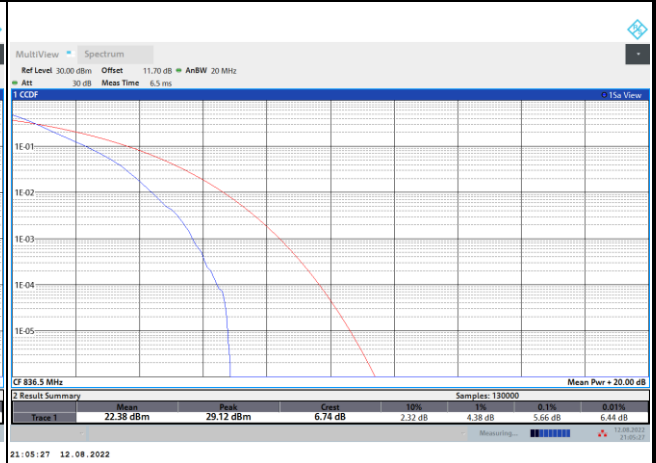

16QAM

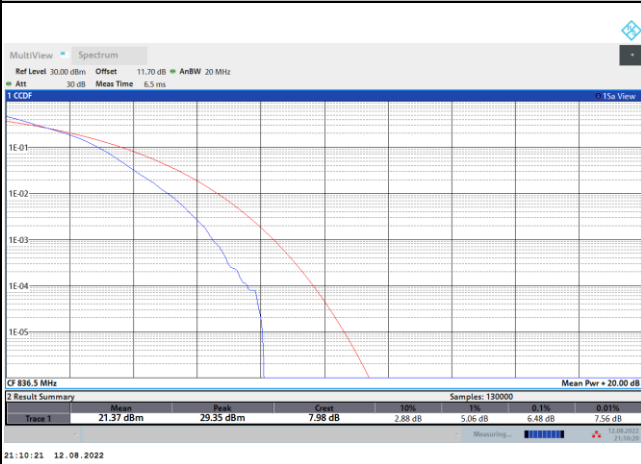

64QAM

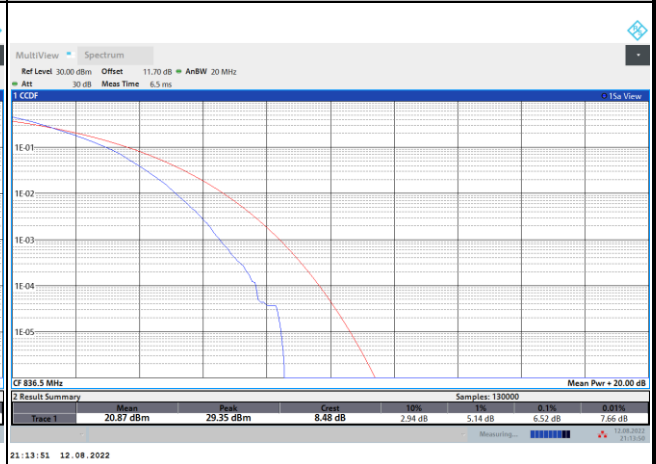

256QAM

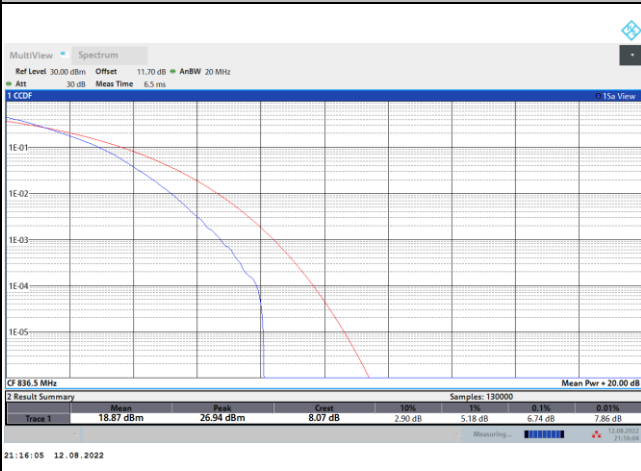



26dB Bandwidth

Mode	FR1 n5 : 26dB BW(MHz) / DFT-S OFDM							
BW	5MHz		10MHz		15MHz		20MHz	
Mod.	PI/2 BPSK		PI/2 BPSK		PI/2 BPSK		PI/2 BPSK	
Middle CH	4.97		9.57		14.33		18.82	

Mode	FR1 n5 : 26dB BW(MHz) / CP OFDM							
BW	5MHz		10MHz		15MHz		20MHz	
Mod.	QPSK	16QAM	QPSK	16QAM	QPSK	16QAM	QPSK	16QAM
Middle CH	5.01	5.09	9.87	9.89	14.93	14.99	19.94	19.90
Mod.	64QAM	256QAM	64QAM	256QAM	64QAM	256QAM	64QAM	256QAM
Middle CH	5.13	5.14	9.83	9.93	14.99	15.11	19.90	19.94



FR1 n5 / 5MHz / DFT-S OFDM / Middle Channel / Full RB

PI/2 BPSK

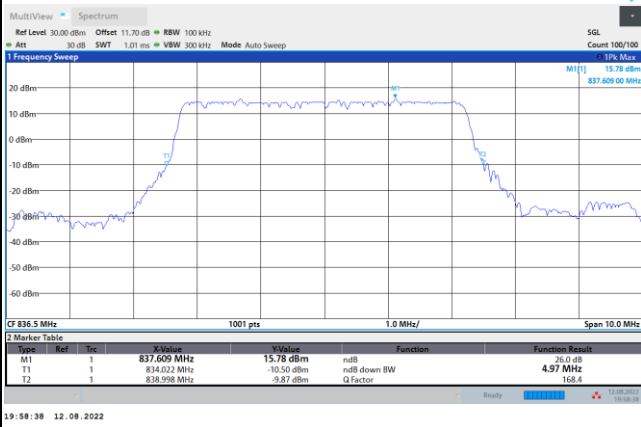

FR1 n5 / 5MHz / CP OFDM / Middle Channel / Full RB

QPSK

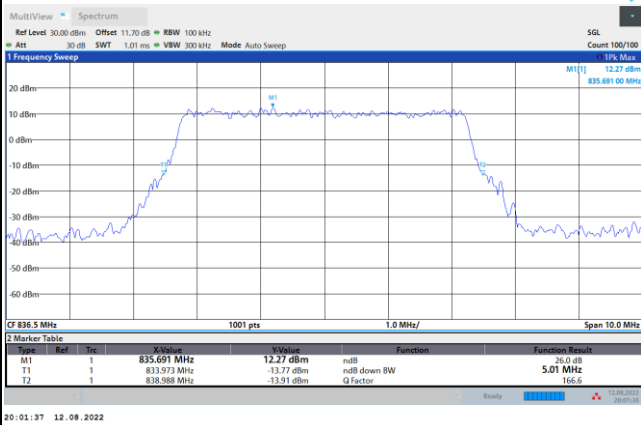

16QAM

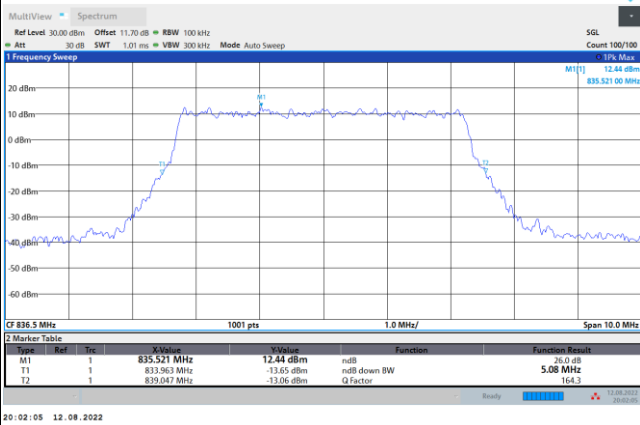

64QAM

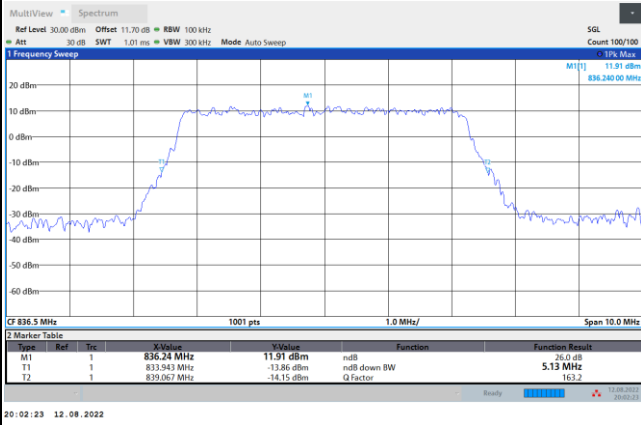

256QAM

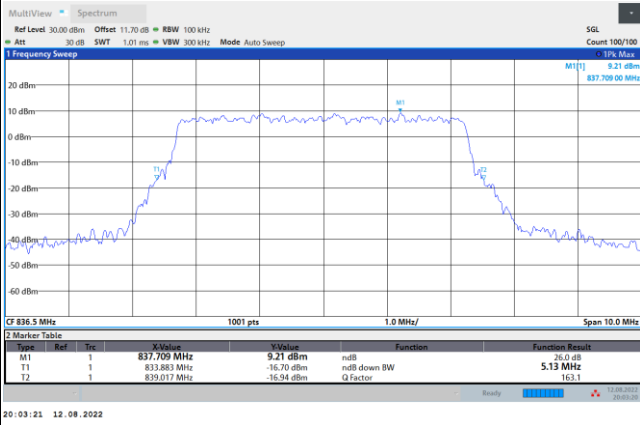



FR1 n5 / 10MHz / DFT-S OFDM / Middle Channel / Full RB

PI/2 BPSK

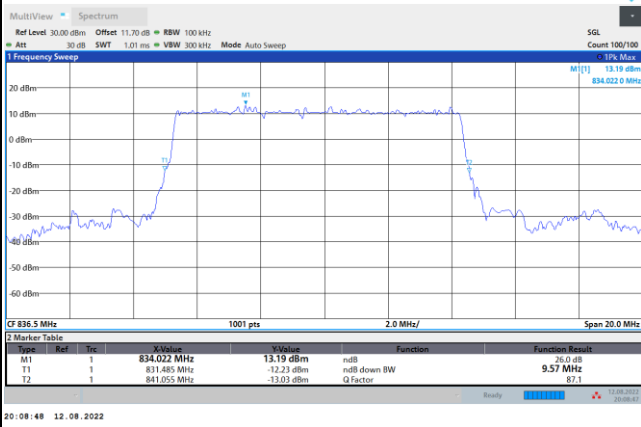

FR1 n5 / 10MHz / CP OFDM / Middle Channel / Full RB

QPSK

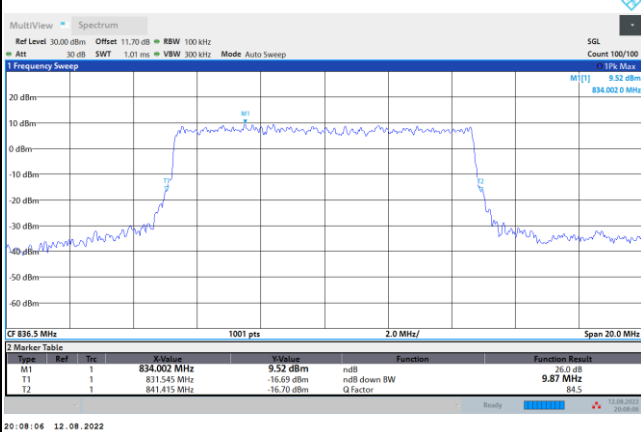

16QAM

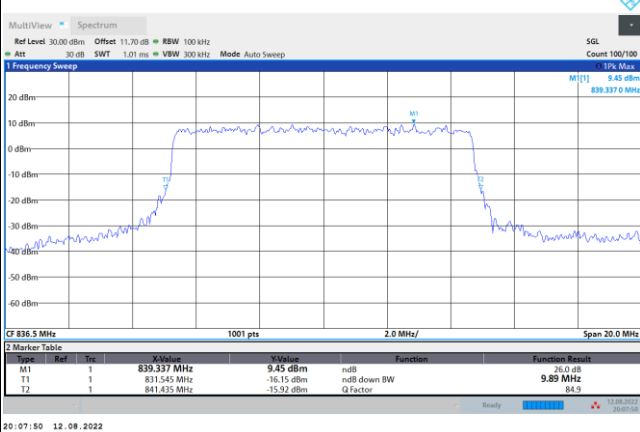

64QAM

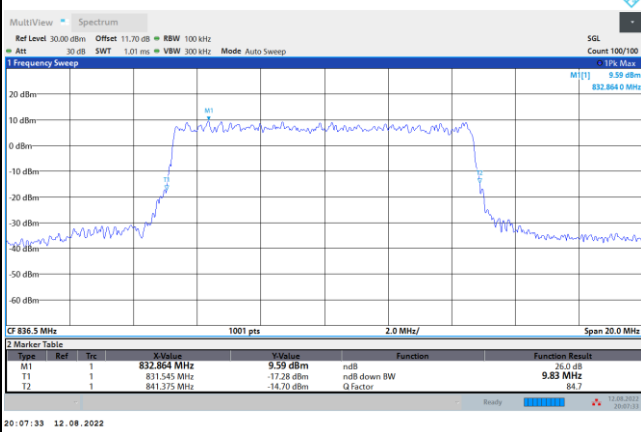

256QAM

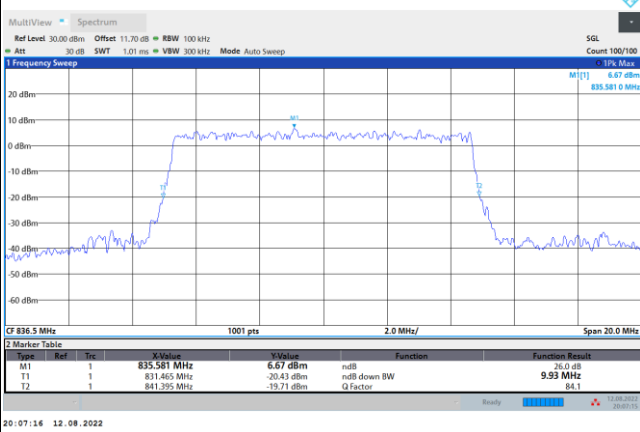



FR1 n5 / 15MHz / DFT-S OFDM / Middle Channel / Full RB

PI/2 BPSK

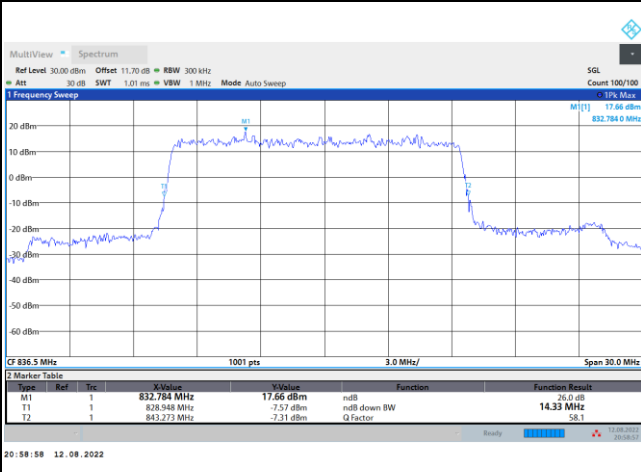

FR1 n5 / 15MHz / CP OFDM / Middle Channel / Full RB

QPSK

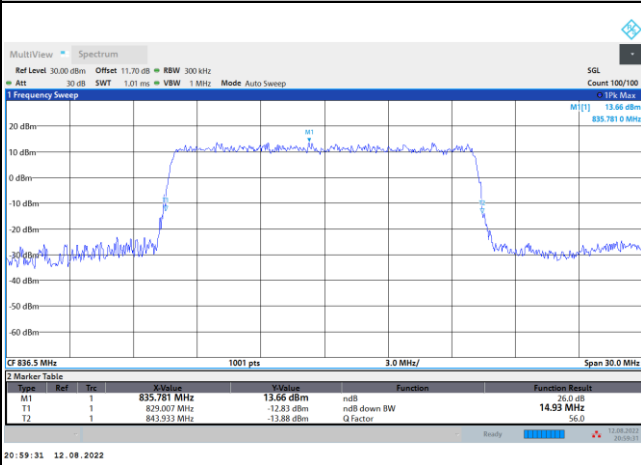

16QAM

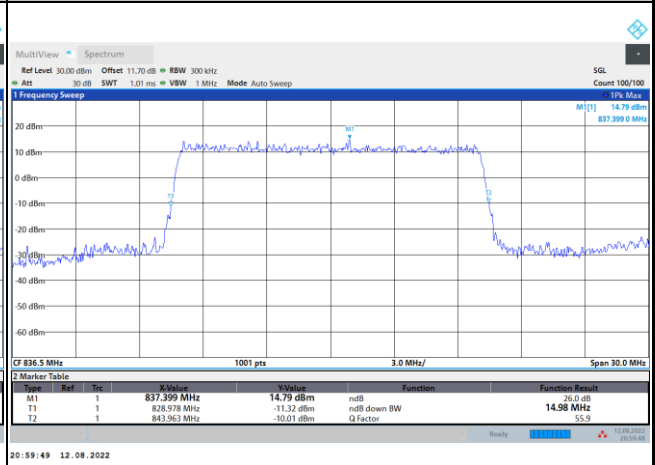

64QAM

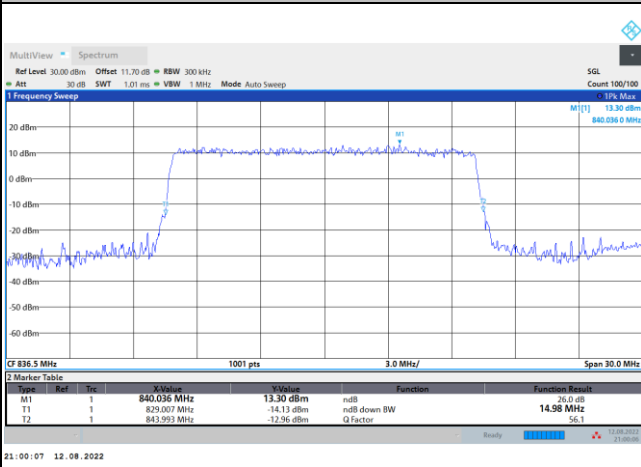

256QAM

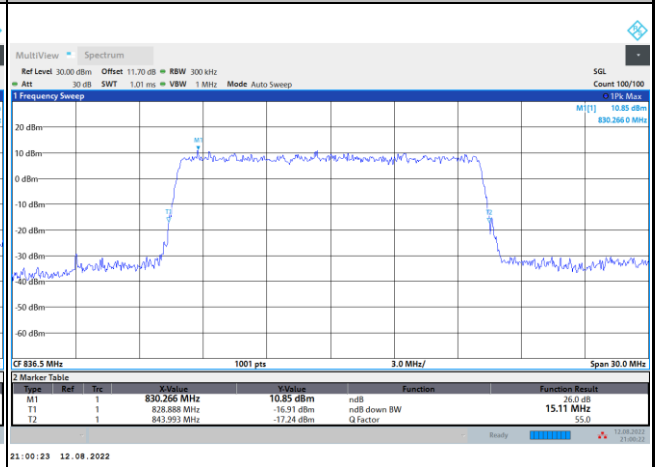



FR1 n5 / 20MHz / DFT-S OFDM / Middle Channel / Full RB

PI/2 BPSK

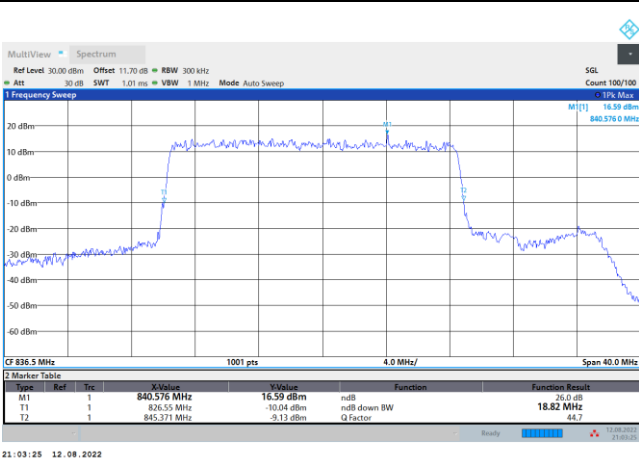

FR1 n5 / 20MHz / CP OFDM / Middle Channel / Full RB

QPSK

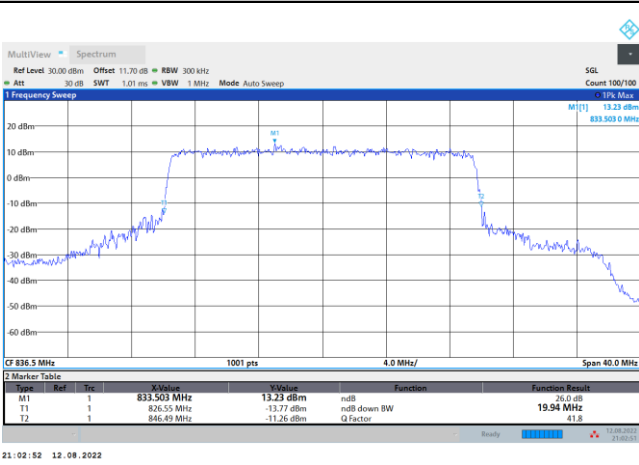

16QAM

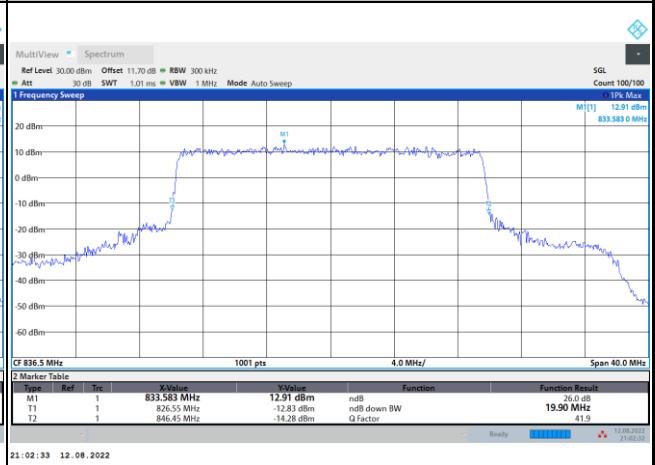

64QAM

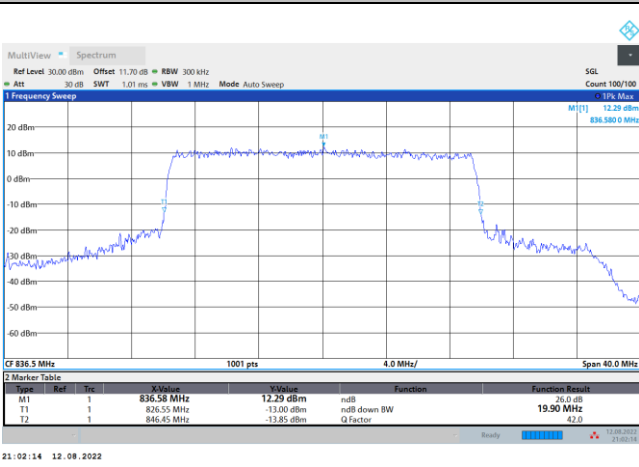

256QAM

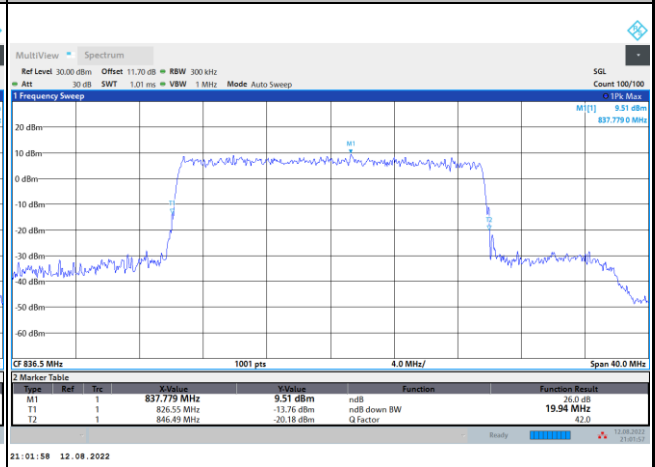



Occupied Bandwidth

Mode	FR1 n5 : 99%OBW(MHz) / DFT-S OFDM							
BW	5MHz		10MHz		15MHz		20MHz	
Mod.	PI/2 BPSK		PI/2 BPSK		PI/2 BPSK		PI/2 BPSK	
Middle CH	4.47		8.93		13.46		17.86	

Mode	FR1 n5 : 99%OBW (MHz) / CP OFDM							
BW	5MHz		10MHz		15MHz		20MHz	
Mod.	QPSK	16QAM	QPSK	16QAM	QPSK	16QAM	QPSK	16QAM
Middle CH	4.48	4.49	9.26	9.28	14.11	14.12	18.88	18.91
Mod.	64QAM	256QAM	64QAM	256QAM	64QAM	256QAM	64QAM	256QAM
Middle CH	4.49	4.52	9.27	9.28	14.12	14.13	18.90	18.90



FR1 n5 / 5MHz / DFT-S OFDM / Middle Channel / Full RB

PI/2 BPSK

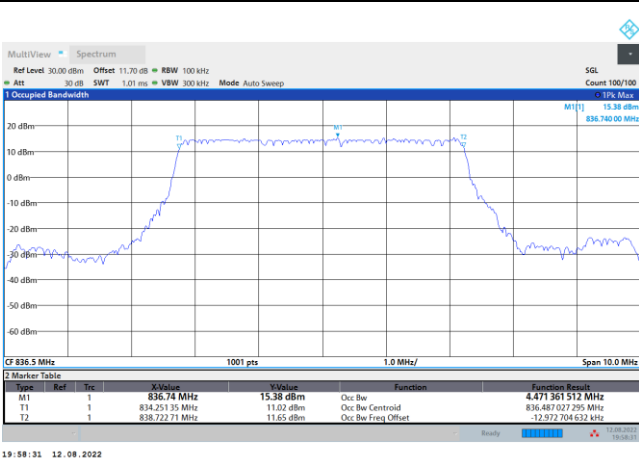

FR1 n5 / 5MHz / CP OFDM / Middle Channel / Full RB

QPSK

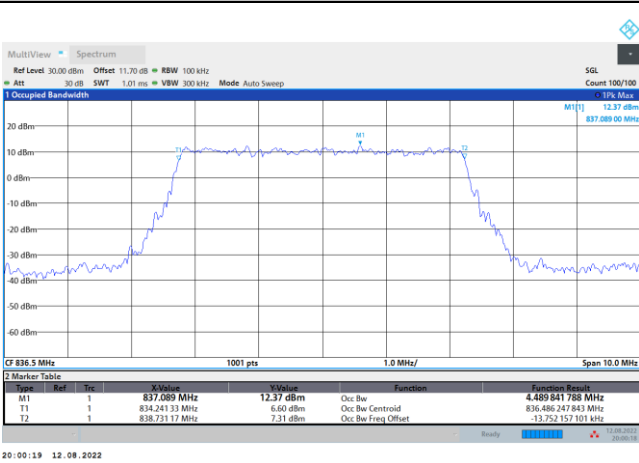

16QAM

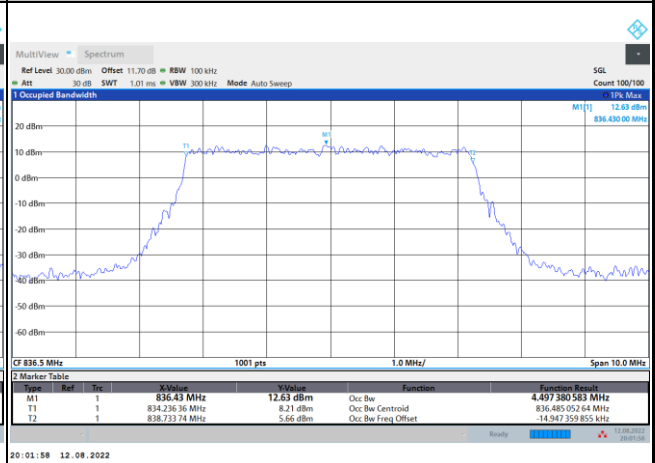

64QAM

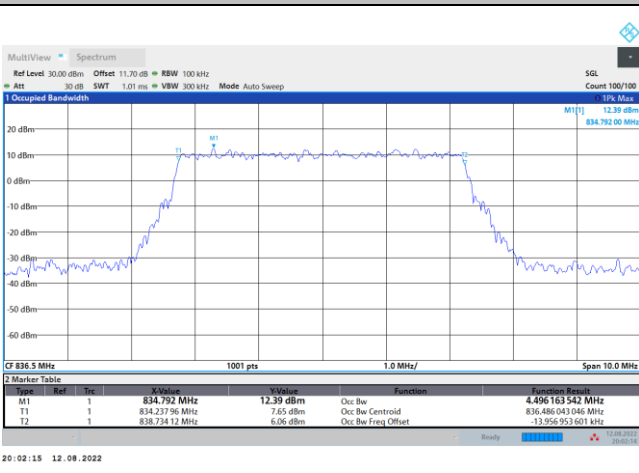

256QAM

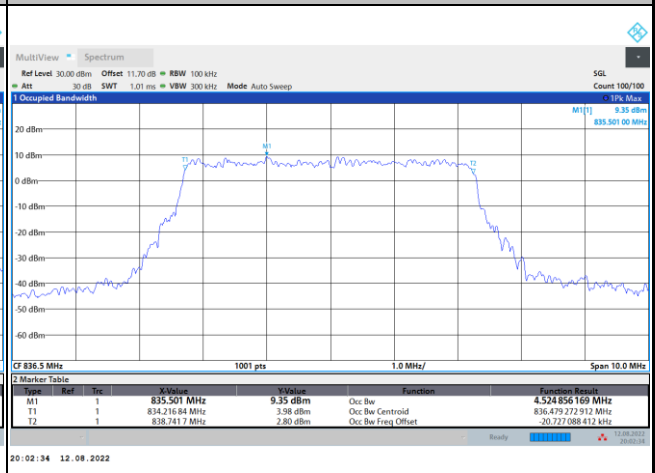



FR1 n5 / 10MHz / DFT-S OFDM / Middle Channel / Full RB

PI/2 BPSK

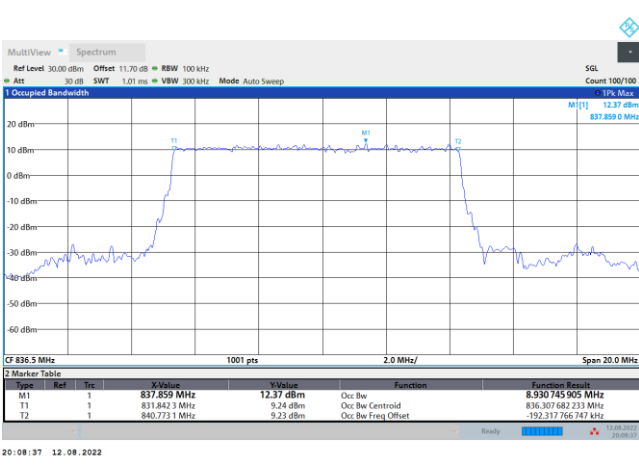

FR1 n5 / 10MHz / CP OFDM / Middle Channel / Full RB

QPSK

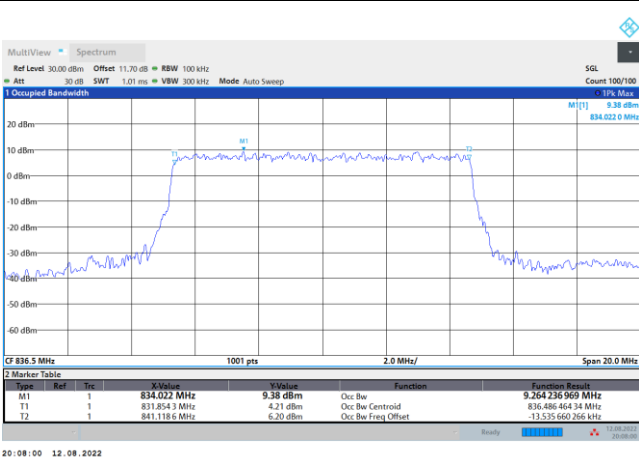

16QAM

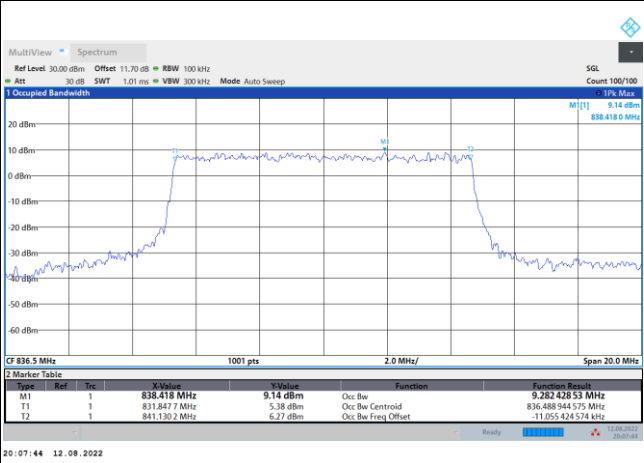

64QAM

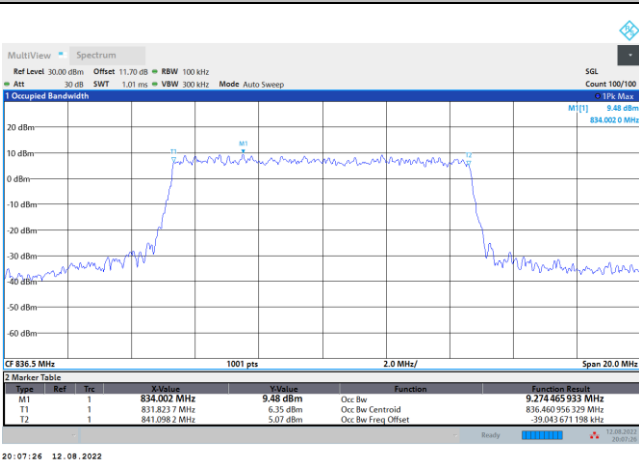

256QAM

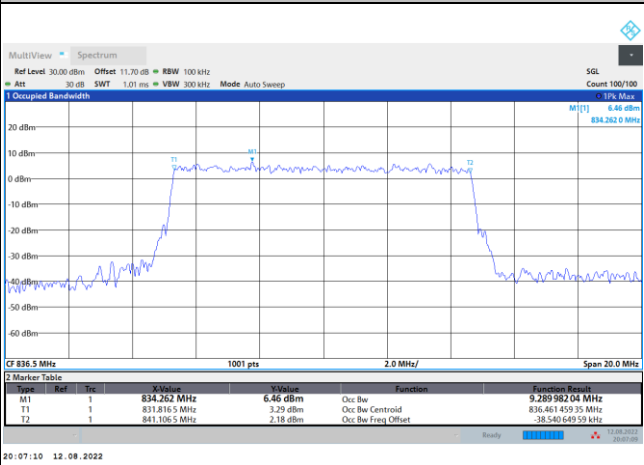



FR1 n5 / 15MHz / DFT-S OFDM / Middle Channel / Full RB

PI/2 BPSK

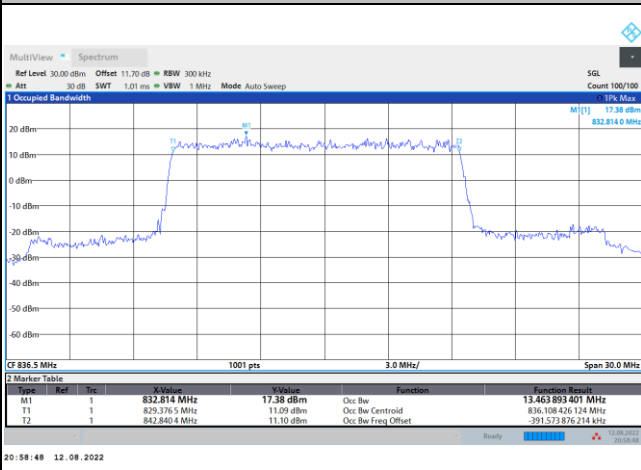

FR1 n5 / 15MHz / CP OFDM / Middle Channel / Full RB

QPSK

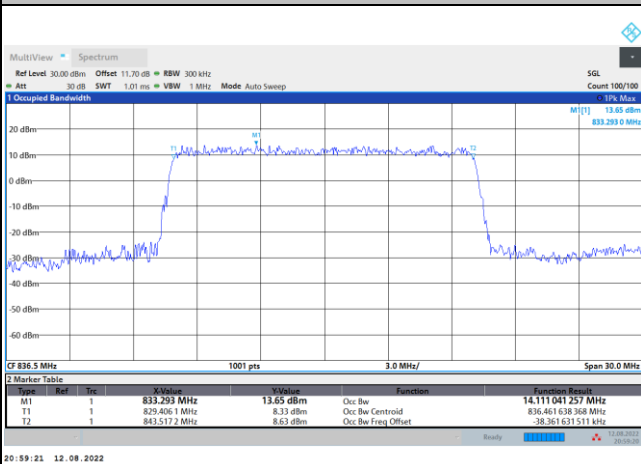

16QAM

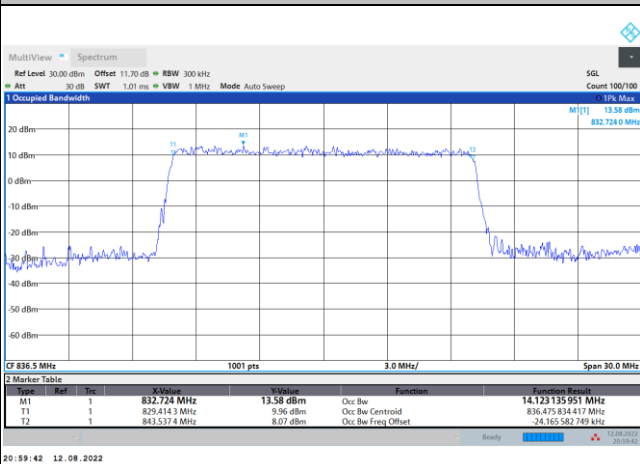

64QAM

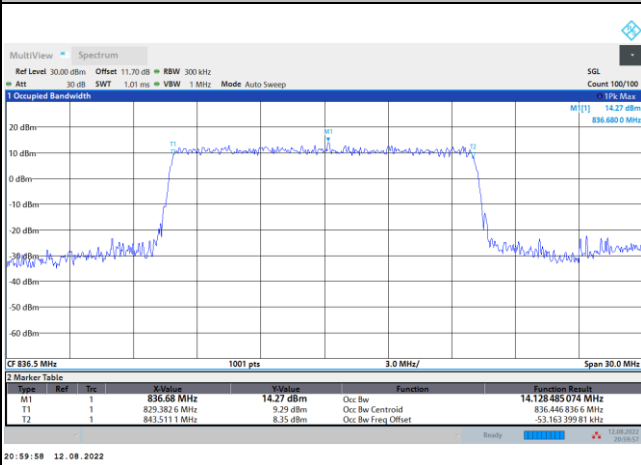

256QAM

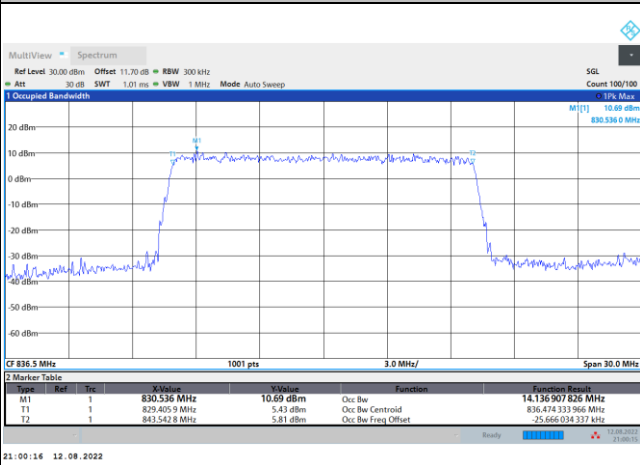



FR1 n5 / 20MHz / DFT-S OFDM / Middle Channel / Full RB

PI/2 BPSK

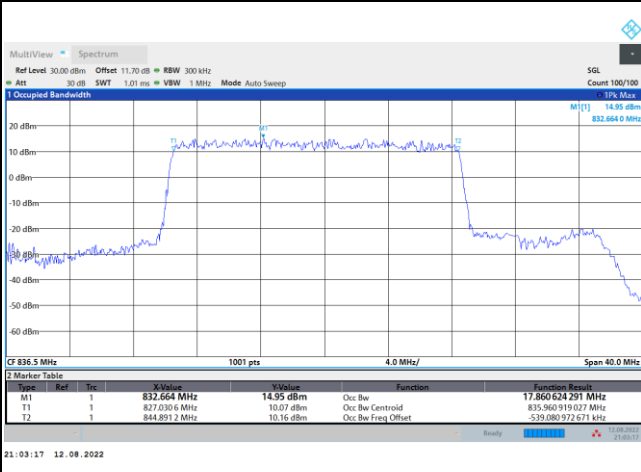

FR1 n5 / 20MHz / CP OFDM / Middle Channel / Full RB

QPSK

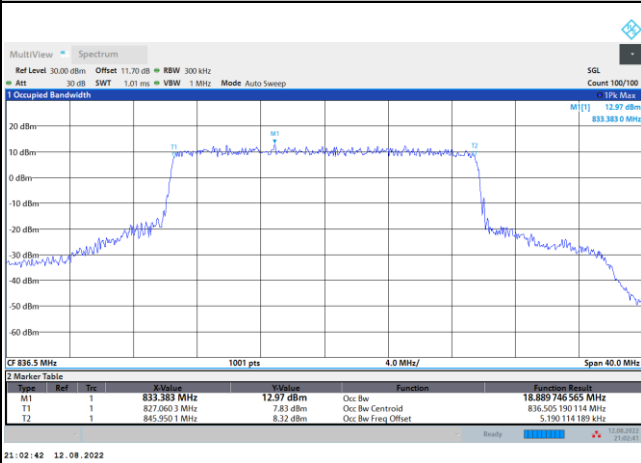

16QAM

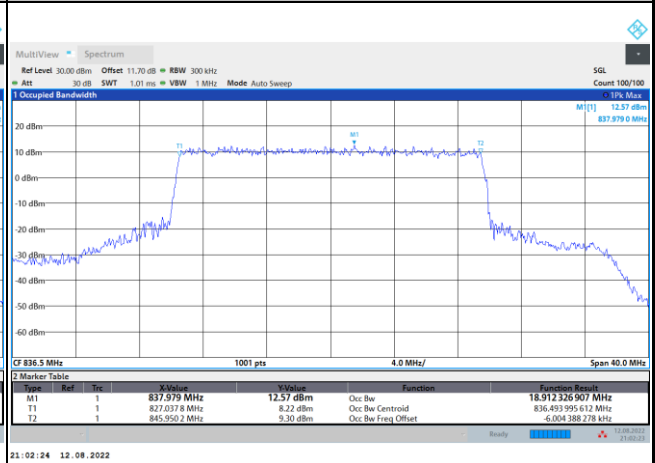

64QAM

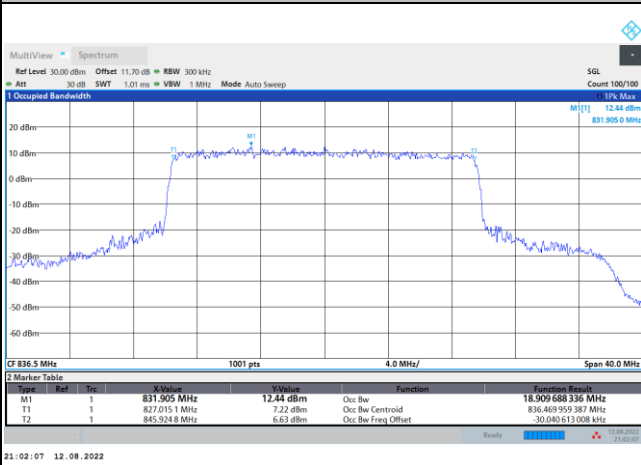

256QAM

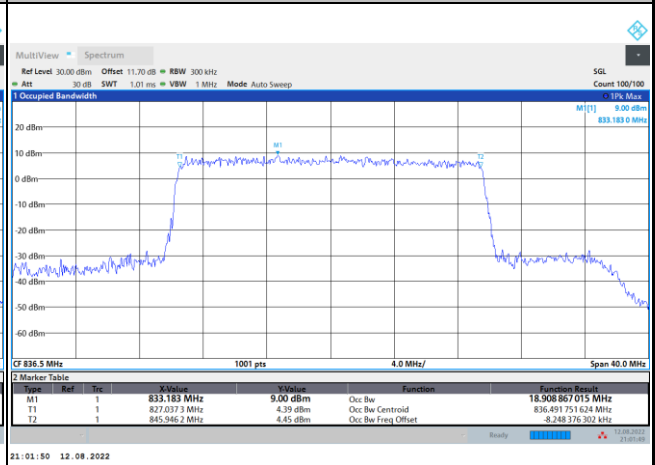



Conducted Band Edge

FR1 n5 / 5MHz / DFT-S OFDM / PI/2 BPSK

Lowest Band Edge / 1RB0

Highest Band Edge / 1RBmax

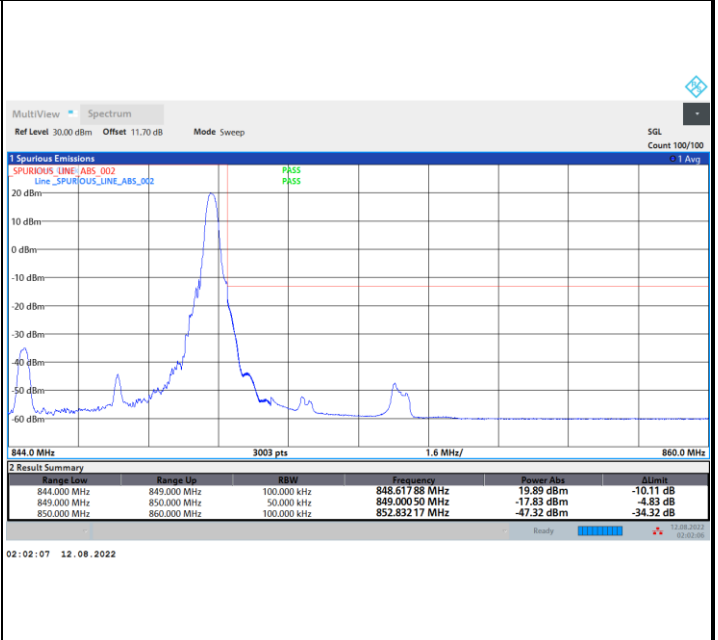
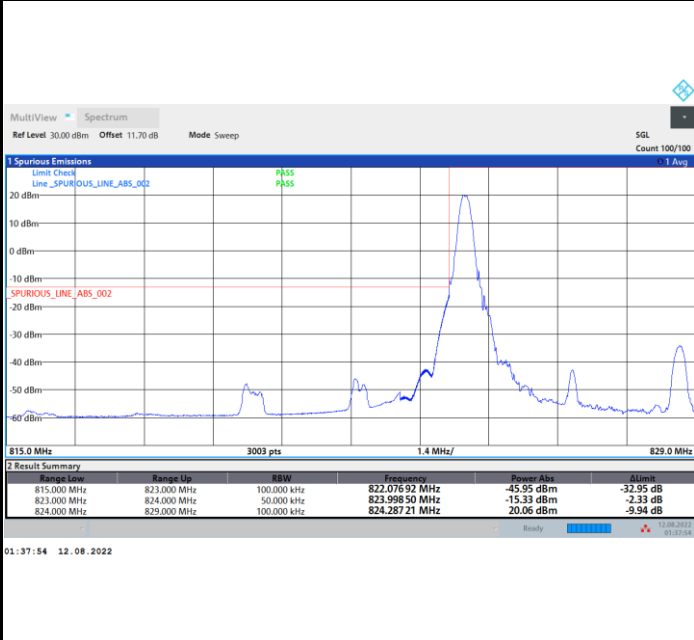

Lowest Band Edge / Full RB

Highest Band Edge / Full RB

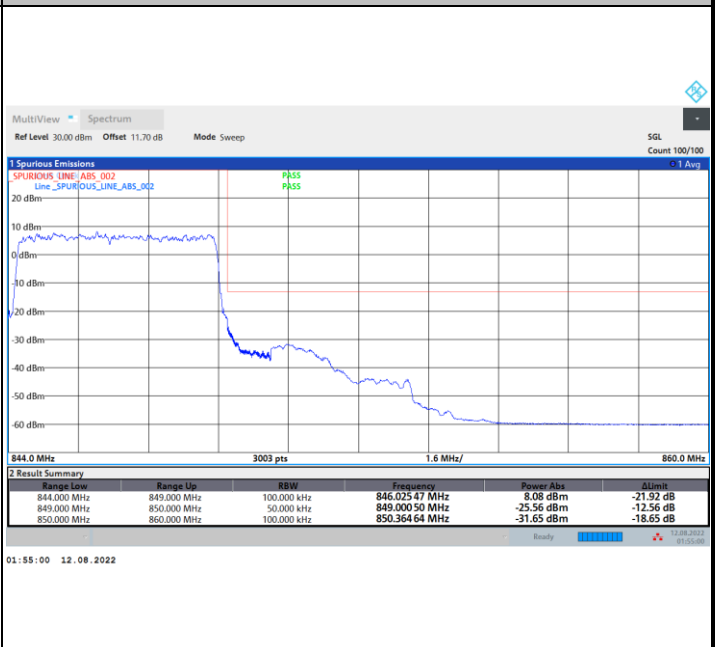
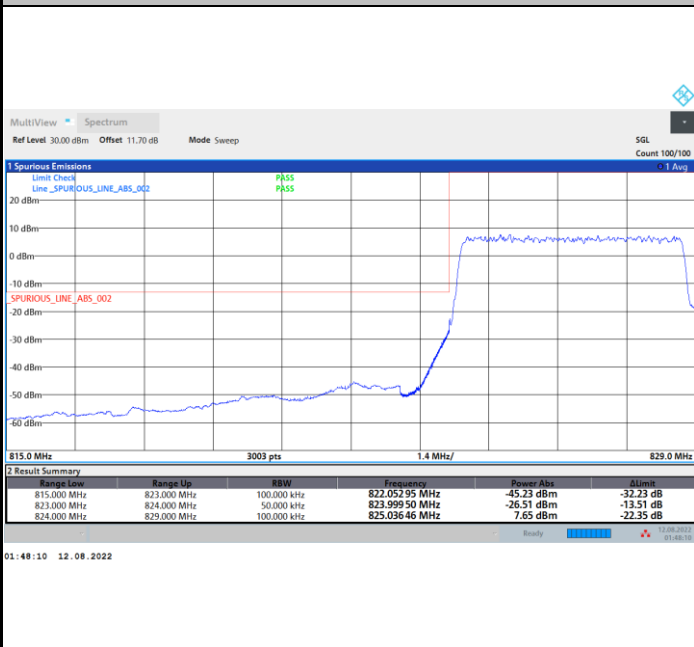



FR1 n5 / 5MHz / DFT-S OFDM / QPSK

Lowest Band Edge / 1RB0

Highest Band Edge / 1RBmax

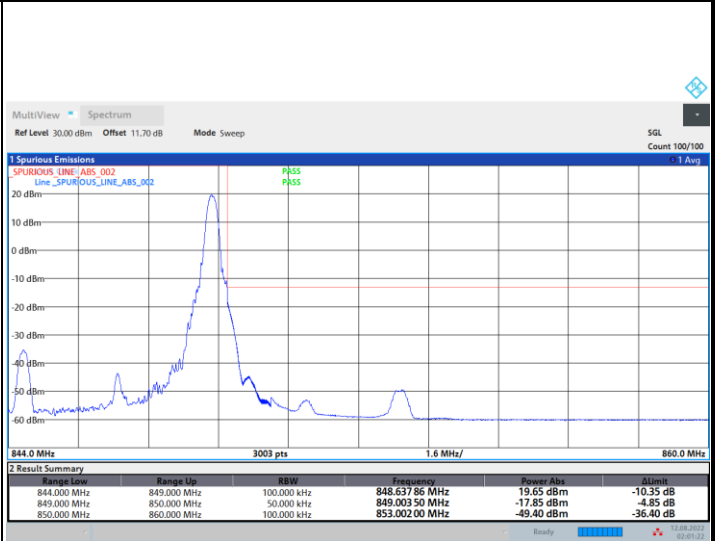
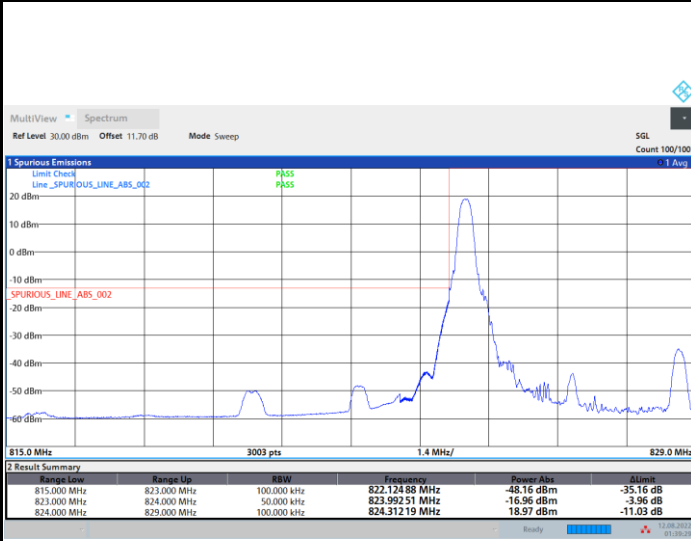

01:39:30 12.08.2022

02:01:23 12.08.2022

Lowest Band Edge / Full RB

Highest Band Edge / Full RB

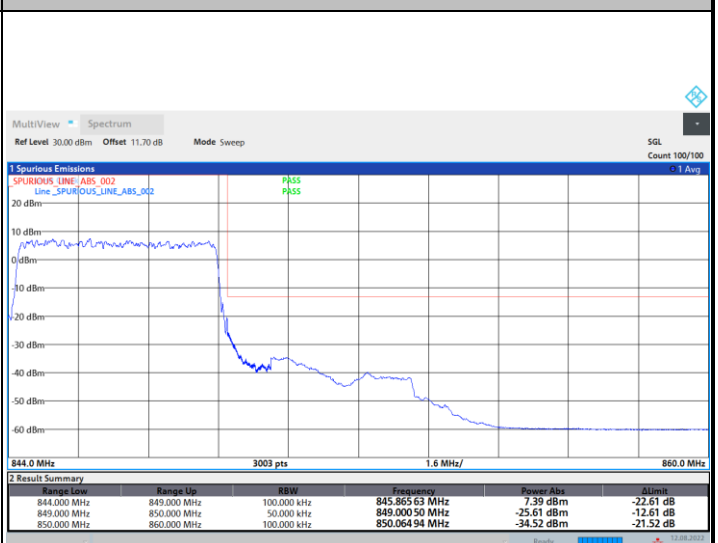
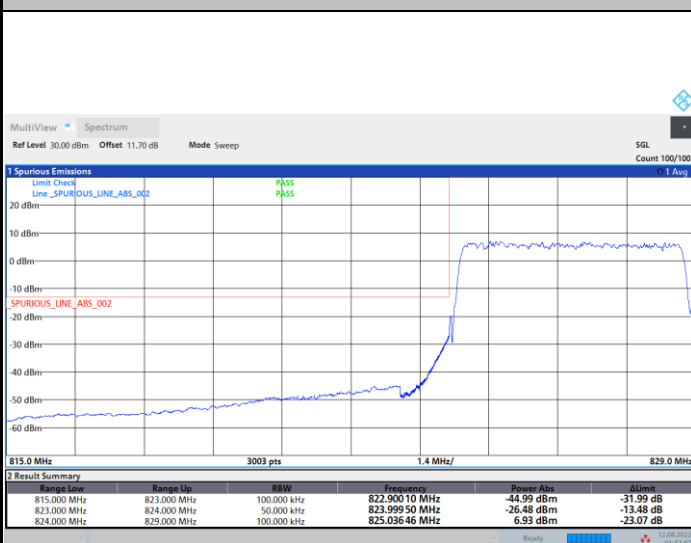

01:47:08 12.08.2022

01:54:03 12.08.2022



FR1 n5 / 5MHz / DFT-S OFDM / 16QAM

Lowest Band Edge / 1RB0

Highest Band Edge / 1RBmax

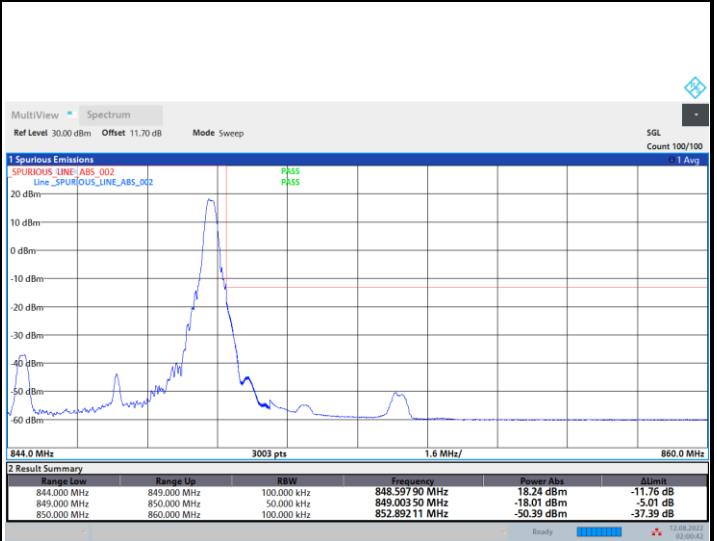
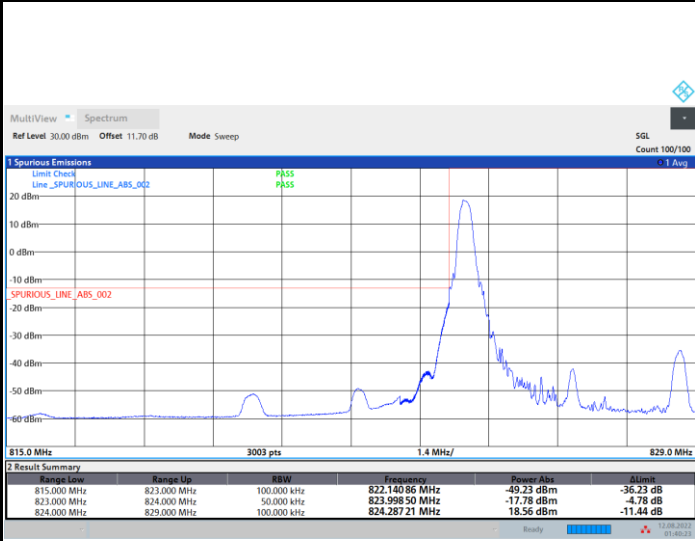

01:40:23 12.08.2022

02:00:42 12.08.2022

Lowest Band Edge / Full RB

Highest Band Edge / Full RB

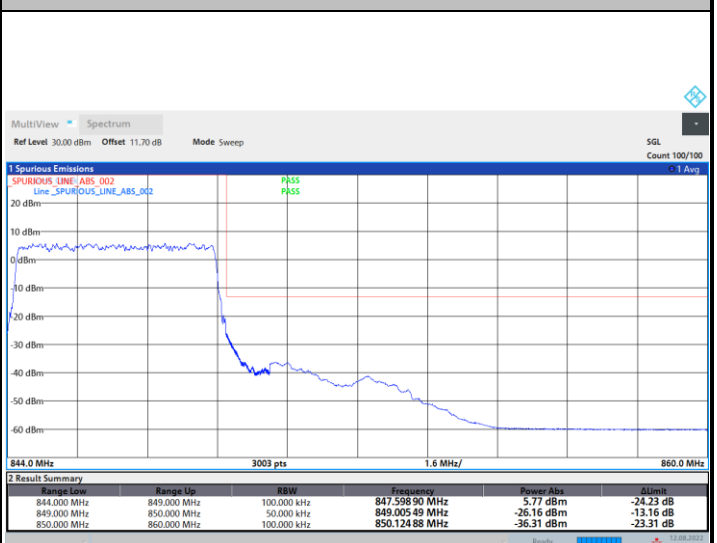
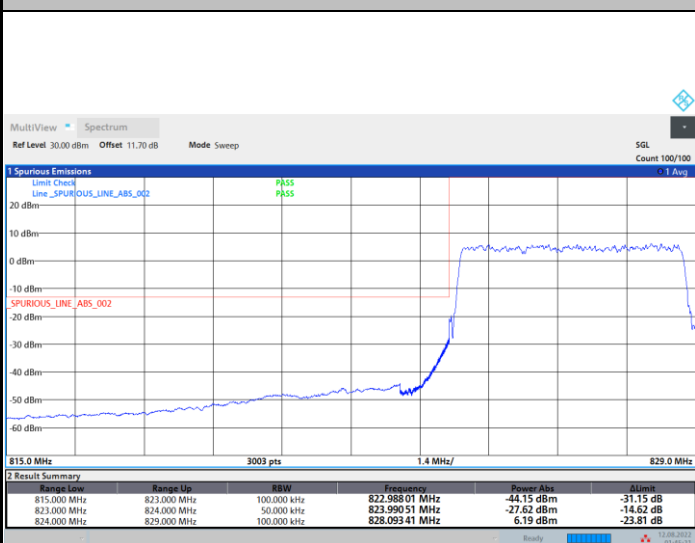

01:45:22 12.08.2022

01:56:23 12.08.2022



FR1 n5 / 5MHz / DFT-S OFDM / 64QAM

Lowest Band Edge / 1RB0

Highest Band Edge / 1RBmax

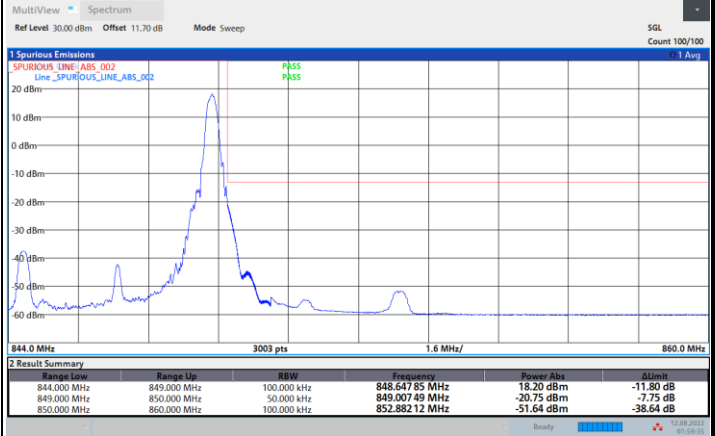
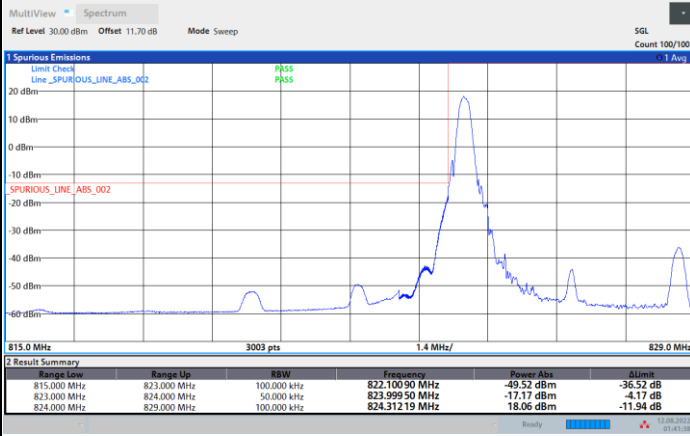

Lowest Band Edge / Full RB

Highest Band Edge / Full RB

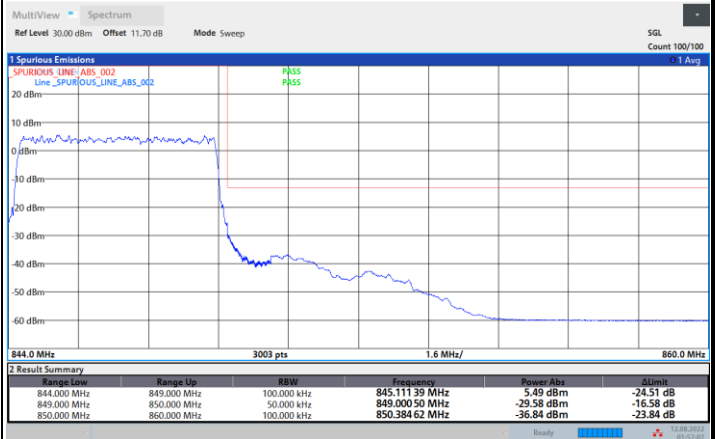
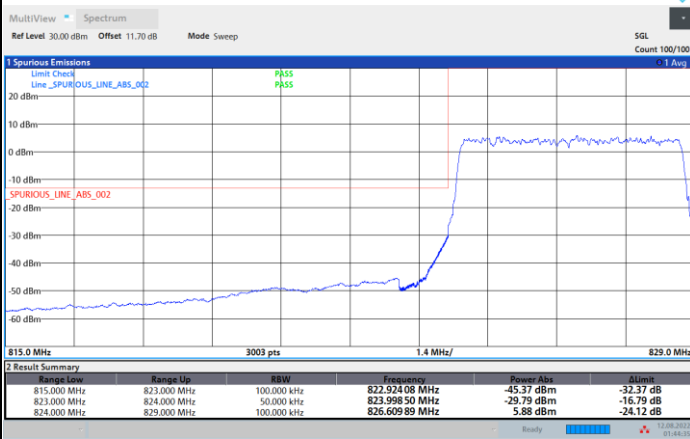



FR1 n5 / 5MHz / DFT-S OFDM / 256QAM

Lowest Band Edge / 1RB0

Highest Band Edge / 1RBmax

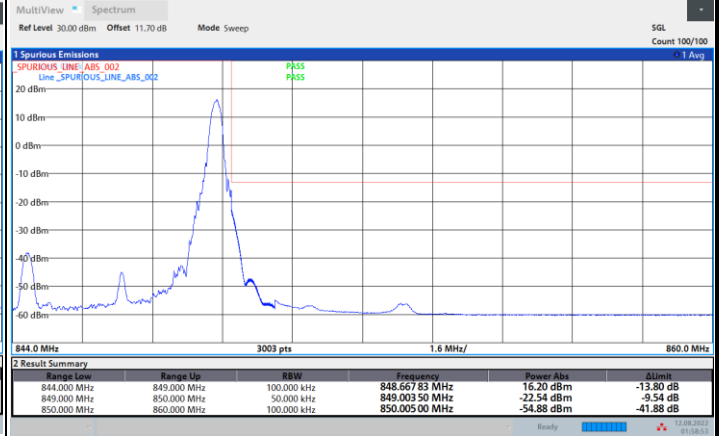
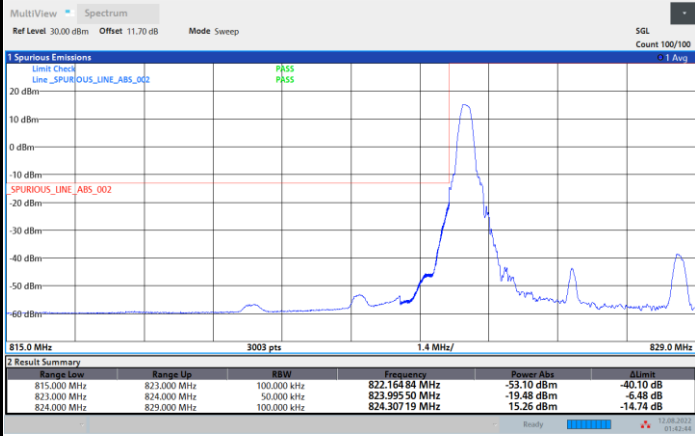

Lowest Band Edge / Full RB

Highest Band Edge / Full RB

