



FCC RADIO TEST REPORT

FCC ID : RI7FN980M
Equipment : 5G/ LTE M.2 Data Card
Brand Name : Telit
Model Name : FN980m
Marketing Name : FN980m
Applicant : TELIT COMMUNICATIONS S.P.A.
VIA STAZIONE DI PROSECCO 5B - SGONICO
-TRIESTE - ITALY
Manufacturer : TELIT COMMUNICATIONS S.P.A.
VIA STAZIONE DI PROSECCO 5B - SGONICO
-TRIESTE - ITALY
Standard : FCC 47 CFR Part 2, 27

The product was received on Feb. 23, 2022 and testing was performed from Mar. 21, 2022 to May 26, 2022. We, Sporton International Inc. EMC & Wireless Communications Laboratory, would like to declare that the tested sample has been evaluated in accordance with the test procedures given in ANSI / TIA-603-E and has been in compliance with the applicable technical standards.

The test results in this variant report apply exclusively to the tested model / sample. Without written approval of Sporton International Inc. EMC & Wireless Communications Laboratory, the test report shall not be reproduced except in full.

Louis Wu

Approved by: Louis Wu

Sporton International Inc. EMC & Wireless Communications Laboratory

No. 52, Huaya 1st Rd., Guishan Dist., Taoyuan City 333, Taiwan (R.O.C.)



Table of Contents

History of this test report.....	3
Summary of Test Result.....	4
1 General Description	5
1.1 Product Feature of Equipment Under Test.....	5
1.2 Modification of EUT	5
1.3 Testing Location	6
1.4 Applicable Standards.....	6
2 Test Configuration of Equipment Under Test	7
2.1 Test Mode.....	7
2.2 Connection Diagram of Test System.....	8
2.3 Support Unit used in test configuration and system	8
2.4 Measurement Results Explanation Example.....	8
2.5 Frequency List of Low/Middle/High Channels	9
3 Conducted Test Items.....	10
3.1 Measuring Instruments	10
3.2 Conducted Output Power and EIRP.....	11
3.3 Peak-to-Average Ratio	12
3.4 Occupied Bandwidth.....	13
3.5 Conducted Band Edge	14
3.6 Conducted Spurious Emission	15
3.7 Frequency Stability	16
4 Radiated Test Items	17
4.1 Measuring Instruments	17
4.2 Radiated Spurious Emission Measurement	19
5 List of Measuring Equipment.....	20
6 Uncertainty of Evaluation.....	22
Appendix A. Test Results of Conducted Test	
Appendix B. Test Results of Radiated Test	
Appendix C. Test Setup Photographs	



History of this test report

Report No.	Version	Description	Issued Date
FG031715-16A	01	Initial issue of report	Jun. 08, 2022



Summary of Test Result

Report Clause	Ref Std. Clause	Test Items	Result (PASS/FAIL)	Remark
3.2	§2.1046	Conducted Output Power	Reporting only	-
	§27.50 (j)(3)	Equivalent Isotropic Radiated Power (n77) (n78)	Pass	
3.3	§27.50 (j)(4)	Peak-to-Average Ratio	Reporting only	-
3.4	§2.1049	Occupied Bandwidth	Reporting only	-
3.5	§2.1051	Conducted Band Edge Measurement (n77) (n78)	Pass	-
	§27.53 (l)(2)			
3.6	§2.1051	Conducted Spurious Emission (n77) (n78)	Pass	-
	§27.53 (l)(2)			
3.7	§2.1055	Frequency Stability Temperature & Voltage	Pass	-
	§27.54			
4.2	§2.1051 §27.53 (l)(2)	Radiated Spurious Emission (n77) (n78)	Pass	Under limit 14.56 dB at 14808.000 MHz

Note: This is a variant report by adding 5G NR n77, n78 via software. All the test cases were performed on original report which can be referred to Sporton Report Number FG031715-09C. Based on the original report, the test cases were verified.

Declaration of Conformity:
1. The test results (PASS/FAIL) with all measurement uncertainty excluded are presented in accordance with the regulation limits or requirements declared by manufacturers. It's means measurement values may risk exceeding the limit of regulation standards, if measurement uncertainty is include in test results.
2. The measurement uncertainty please refer to this report "Uncertainty of Evaluation".
Comments and Explanations:
The product specifications of the EUT presented in the report are declared by the manufacturer who shall take full responsibility for the authenticity.

Reviewed by: Avis Chuang

Report Producer: Cindy Liu



1 General Description

1.1 Product Feature of Equipment Under Test

Product Feature	
Antenna Type	WWAN: <Ant. 0> Dipole Antenna <Ant. 1> Dipole Antenna <Ant. 2> Dipole Antenna <Ant. 3> Dipole Antenna GNSS : <1559 MHz ~ 1610 MHz>: <Ant. 3> Dipole Antenna <Ant. 4> Dipole Antenna <1164 MHz ~ 1215 MHz>: <Ant. 2> Dipole Antenna

Remark: The above EUT's information was declared by manufacturer. Please refer to Comments and Explanations in report summary.

1.2 Modification of EUT

No modifications are made to the EUT during all test items.



1.3 Testing Location

Test Site	Sporton International Inc. EMC & Wireless Communications Laboratory
Test Site Location	No.52, Huaya 1st Rd., Guishan Dist., Taoyuan City 333, Taiwan (R.O.C.) TEL: +886-3-327-3456 FAX: +886-3-328-4978
Test Site No.	Sporton Site No.
	TH03-HY
Test Engineer	Luffy Lin
Temperature (°C)	23.5~24.1
Relative Humidity (%)	48~52

Test Site	Sporton International Inc. Wensan Laboratory
Test Site Location	No.58, Aly. 75, Ln. 564, Wenhua 3rd, Rd., Guishan Dist., Taoyuan City 333010, Taiwan (R.O.C.) TEL: +886-3-327-0868 FAX: +886-3-327-0855
Test Site No.	Sporton Site No.
	03CH12-HY (TAF Code: 3786)
Test Engineer	Jack Cheng and Wilson Wu
Temperature (°C)	21.6~26.2
Relative Humidity (%)	56~68
Remark	The Radiated Spurious Emission test item subcontracted to Sporton International Inc. Wensan Laboratory

Note: The test site complies with ANSI C63.4 2014 requirement.

FCC Designation No.: TW1190 and TW3786

1.4 Applicable Standards

According to the specifications of the manufacturer, the EUT must comply with the requirements of the following standards:

- ♦ ANSI C63.26-2015
- ♦ ANSI / TIA-603-E
- ♦ FCC 47 CFR Part 2, 27
- ♦ FCC KDB 971168 D01 Power Meas. License Digital Systems v03r01
- ♦ FCC KDB 412172 D01 Determining ERP and EIRP v01r01
- ♦ FCC KDB 414788 D01 Radiated Test Site v01r01.

Remark:

1. All test items were verified and recorded according to the standards and without any deviation during the test.
2. The TAF code is not including all the FCC KDB listed without accreditation.



2 Test Configuration of Equipment Under Test

2.1 Test Mode

Antenna port conducted and radiated test items listed below are performed according to KDB 971168 D01 Power Meas. License Digital Systems v03r01 with maximum output power.

For radiated emission level of the EUT was maximized by rotating the EUT on a turntable, adjusting the orientation of the EUT and EUT antenna in two config (Horizontal and Vertical), and adjusting the measurement antenna orientation, following C63.26 exploratory test procedures and find (Ant. Horizontal) as worst plane.

Test Items	NR Band	Bandwidth (MHz)									Modulation					RB #			Test Channel		
		20	30	40	50	60	70	80	90	100	PI/2 BPSK	QPSK	16QAM	64QAM	256QAM	1	Half	Full	L	M	H
Max. Output Power	n77	v	v	v	-	v	-	v	-	v	v	v	v	v	v	v	v	v	v	v	v
	n78	v	v	v	v	v	v	v	v	v	v	v	v	v	v	v	v	v	v	v	v
Peak-to-Average Ratio	n77	v			-		-		-		v	v	v	v	v			v		v	
	n78	v									v	v	v	v	v			v		v	
26dB and 99% Bandwidth	n77	v	v	v	-	v	-	v	-	v	v	v	v	v	v			v		v	
	n78	v	v	v	v	v	v	v	v	v	v	v	v	v	v			v		v	
Conducted Band Edge	n77	v	v	v	-	v	-	v	-	v	v	v	v	v	v	v		v	v		v
	n78	v	v	v	v	v	v	v	v	v	v	v	v	v	v	v		v	v		v
Conducted Spurious Emission	n77	v			-		-		-			v				v			v	v	v
	n78	v										v				v			v	v	v
Frequency Stability	n77	v			-		-		-		v							v		v	
	n78	v									v							v		v	
E.I.R.P	n77	v	v	v	-	v	-	v	-	v	v	v	v	v	v	Max. Power					
	n78	v	v	v	v	v	v	v	v	v	v	v	v	v	v						
Radiated Spurious Emission	n77	Worst Case																v	v	v	
	n78	Covered by n77																			
Remark	<ol style="list-style-type: none"> The mark "v" means that this configuration is chosen for testing The mark "-" means that this bandwidth is not supported. The device is investigated from 30MHz to 10 times of fundamental signal for radiated spurious emission test under different RB size/offset and modulations in exploratory test. Subsequently, only the worst case emissions are reported. For radiated measurement, pre-scanned in two modes, DFT-s OFDM and CP OFDM. The worst cases (DFT-s OFDM) were recorded in this report, and the worst modes of FR1 and LTE for simultaneous transmission were verified and compliant. Test combination are EN-DC 2A_n77A, 5A_n77A, 7A_n77A, 12A_n77A, 13A_n77A, 14A_n77A, 30A_n77A, 66A_n77A. 																				

2.2 Connection Diagram of Test System

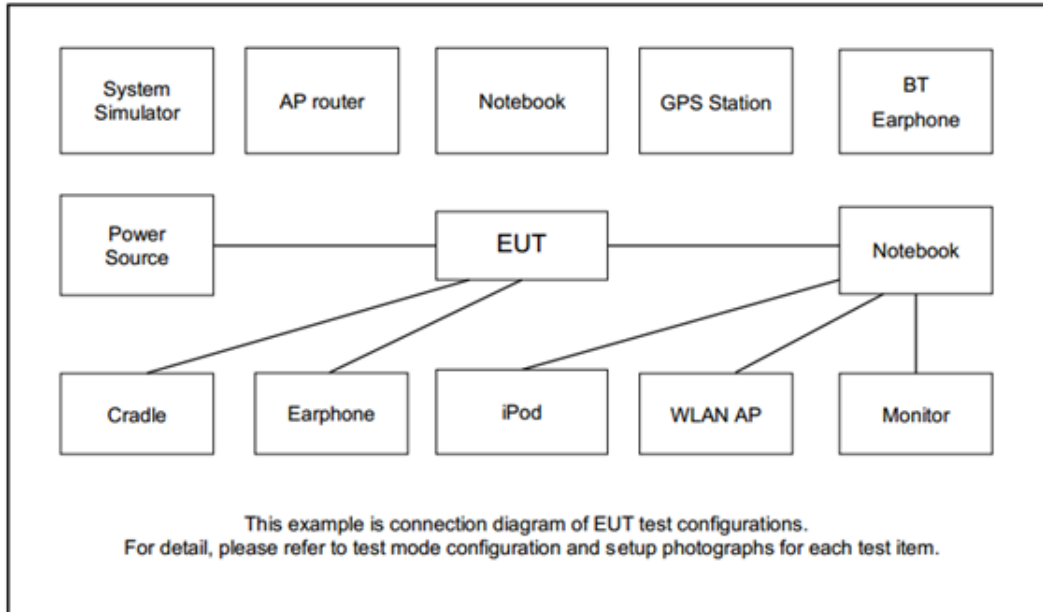

2.3 Support Unit used in test configuration and system

Item	Equipment	Brand Name	Model No.	FCC ID	Data Cable	Power Cord
1.	System Simulator	Anritsu	MT8000A	N/A	N/A	Unshielded, 1.8 m
2.	System Simulator	Anritsu	MT8821C	N/A	N/A	Unshielded, 1.8 m
3.	DC Power Supply	GW Instek	SPS-606	N/A	N/A	Unshielded, 1.8m

2.4 Measurement Results Explanation Example

For all conducted test items:

The offset level is set in the spectrum analyzer to compensate the RF cable loss and attenuator factor between EUT conducted output port and spectrum analyzer. With the offset compensation, the spectrum analyzer reading level is exactly the EUT RF output level.

The spectrum analyzer offset is derived from RF cable loss and attenuator factor.

$$\text{Offset} = \text{RF cable loss} + \text{attenuator factor}.$$

Following shows an offset computation example with cable loss 4.2 dB and 10dB attenuator.

Example :

$$\begin{aligned} \text{Offset(dB)} &= \text{RF cable loss(dB)} + \text{attenuator factor(dB)}. \\ &= 4.2 + 10 = 14.2 \text{ (dB)} \end{aligned}$$



2.5 Frequency List of Low/Middle/High Channels

5G NR n77 Channel and Frequency List				
BW [MHz]	Channel/Frequency(MHz)	Lowest	Middle	Highest
100	Channel	650000	656000	662000
	Frequency	3750	3840	3930
80	Channel	649334	656000	662666
	Frequency	3740.01	3840	3939.99
60	Channel	648668	656000	663332
	Frequency	3730.02	3840	3949.98
40	Channel	648000	656000	664000
	Frequency	3720	3840	3960
30	Channel	647668	656000	664332
	Frequency	3715.02	3840	3965
20	Channel	647334	656000	664666
	Frequency	3710.01	3840	3969.99

5G NR n78 Channel and Frequency List				
BW [MHz]	Channel/Frequency(MHz)	Lowest	Middle	Highest
100	Channel	-	650000	-
	Frequency	-	3750	-
90	Channel	649668	650000	650332
	Frequency	3745.02	3750	3754.98
80	Channel	649334	650000	650666
	Frequency	3740.01	3750	3759.99
70	Channel	649000	650000	651000
	Frequency	3735	6750	3765
60	Channel	648668	650000	651332
	Frequency	3730.02	3750	3769.98
50	Channel	648334	650000	651666
	Frequency	3725.01	3750	3774.99
40	Channel	648000	650000	652000
	Frequency	3720	3750	3780
30	Channel	647668	650000	652332
	Frequency	3715.02	3750	3784.98
20	Channel	647334	650000	652666
	Frequency	3710.01	3750	3789.99

3 Conducted Test Items

3.1 Measuring Instruments

See list of measuring instruments of this test report.

3.1.1 Test Setup

3.1.2 Conducted Output Power

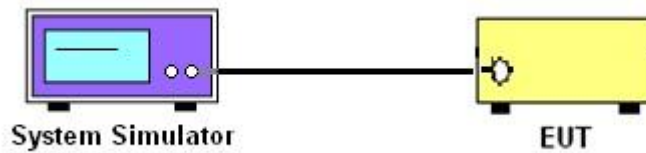

3.1.3 Peak-to-Average Ratio, Occupied Bandwidth ,Conducted Band-Edge and Conducted Spurious Emission

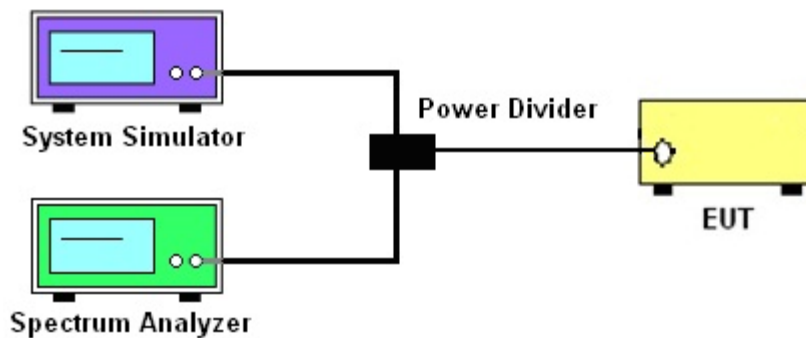

3.1.4 Frequency Stability

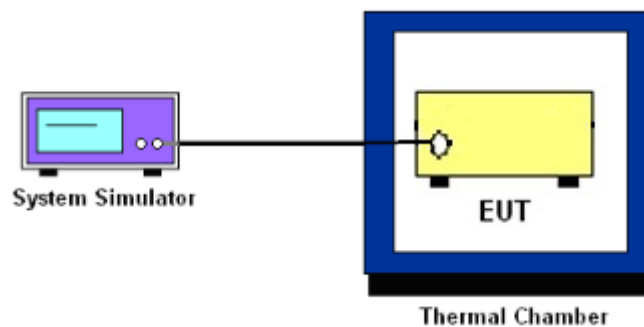

3.1.5 Test Result of Conducted Test

Please refer to Appendix A.



3.2 Conducted Output Power and EIRP

3.2.1 Description of the Conducted Output Power Measurement and EIRP Measurement

A system simulator was used to establish communication with the EUT. Its parameters were set to force the EUT transmitting at maximum output power. The measured power in the radio frequency on the transmitter output terminals shall be reported.

The EIRP of mobile transmitters must not exceed 1 Watts for 5G NR n77 and n78

According to KDB 412172 D01 Power Approach,

$EIRP = P_T + G_T - L_C$, $ERP = EIRP - 2.15$, where

P_T = transmitter output power in dBm

G_T = gain of the transmitting antenna in dBi

L_C = signal attenuation in the connecting cable between the transmitter and antenna in dB

3.2.2 Test Procedures

1. The transmitter output port was connected to the system simulator.
2. Set EUT at maximum power through the system simulator.
3. Select lowest, middle, and highest channels for each band and different modulation.
4. Measure and record the power level from the system simulator.



3.3 Peak-to-Average Ratio

3.3.1 Description of the PAR Measurement

Power Complementary Cumulative Distribution Function (CCDF) curves provide a means for characterizing the power peaks of a digitally modulated signal on a statistical basis. A CCDF curve depicts the probability of the peak signal amplitude exceeding the average power level. Most contemporary measurement instrumentation include the capability to produce CCDF curves for an input signal provided that the instrument's resolution bandwidth can be set wide enough to accommodate the entire input signal bandwidth. In measuring transmissions in this band using an average power technique, the peak-to-average ratio (PAR) of the transmission may not exceed 13 dB.

3.3.2 Test Procedures

The testing follows ANSI C63.26-2015 Section 5.2.6

1. The EUT was connected to spectrum and system simulator via a power divider.
2. Set the CCDF (Complementary Cumulative Distribution Function) option in spectrum analyzer.
3. The highest RF powers were measured and recorded the maximum PAPR level associated with a probability of 0.1 %.
4. Record the deviation as Peak to Average Ratio.



3.4 Occupied Bandwidth

3.4.1 Description of Occupied Bandwidth Measurement

The occupied bandwidth is the width of a frequency band such that, below the lower and above the upper frequency limits, the mean powers emitted are each equal to a specified percentage 0.5% of the total mean transmitted power.

The 26 dB emission bandwidth is defined as the frequency range between two points, one above and one below the carrier frequency, at which the spectral density of the emission is attenuated 26 dB below the maximum in-band spectral density of the modulated signal. Spectral density (power per unit bandwidth) is to be measured with a detector of resolution bandwidth equal to approximately 1.0% of the emission bandwidth.

3.4.2 Test Procedures

The testing follows ANSI C63.26-2015 Section 5.4.3 (26dB) and Section 5.4.4 (99OB)

1. The EUT was connected to spectrum analyzer and system simulator via a power divider.
2. The spectrum analyzer center frequency is set to the nominal EUT channel center frequency. The span range for the spectrum analyzer shall be between two and five times the anticipated OBW.
3. The nominal resolution bandwidth (RBW) shall be in the range of 1 to 5 % of the anticipated OBW, and the VBW shall be at least 3 times the RBW.
4. Set the detection mode to peak, and the trace mode to max hold.
5. Determine the reference value: Set the EUT to transmit a modulated signal. Allow the trace to stabilize. Set the spectrum analyzer marker to the highest level of the displayed trace.
(this is the reference value)
6. Determine the “-26 dB down amplitude” as equal to (Reference Value – X).
7. Place two markers, one at the lowest and the other at the highest frequency of the envelope of the spectral display such that each marker is at or slightly below the “-X dB down amplitude” determined in step 6. If a marker is below this “-X dB down amplitude” value it shall be placed as close as possible to this value. The OBW is the positive frequency difference between the two markers.
8. Use the 99 % power bandwidth function of the spectrum analyzer and report the measured bandwidth.



3.5 Conducted Band Edge

3.5.1 Description of Conducted Band Edge Measurement

27.53 (l)(2)

For mobile operations in the 3700-3980 MHz band, the conducted power of any emission outside the licensee's authorized bandwidth shall not exceed -13 dBm/MHz. Compliance with this paragraph (l)(2) is based on the use of measurement instrumentation employing a resolution bandwidth of 1 megahertz or greater. However, in the 1 megahertz bands immediately outside and adjacent to the licensee's frequency block, the minimum resolution bandwidth for the measurement shall be either one percent of the emission bandwidth of the fundamental emission of the transmitter or 350 kHz. In the bands between 1 and 5 MHz removed from the licensee's frequency block, the minimum resolution bandwidth for the measurement shall be 500 kHz. The emission bandwidth is defined as the width of the signal between two points, one below the carrier center frequency and one above the carrier center frequency, outside of which all emissions are attenuated at least 26 dB below the transmitter power.

3.5.2 Test Procedures

The testing follows FCC KDB 971168 D01 v03r01 Section 6.1.

1. The EUT was connected to spectrum analyzer and system simulator via a power divider.
2. The band edges of low and high channels for the highest RF powers were measured.
3. Set RBW $\geq 1\%$ EBW in the 1MHz band immediately outside and adjacent to the band edge.
4. Beyond the 1 MHz band from the band edge, RBW=1MHz was used.
5. Set spectrum analyzer with RMS detector.
6. The RF fundamental frequency should be excluded against the limit line in the operating frequency band.
7. Checked that all the results comply with the emission limit line.

The limit line is derived from $43 + 10\log(P)$ dB below the transmitter power P(Watts)



3.6 Conducted Spurious Emission

3.6.1 Description of Conducted Spurious Emission Measurement

The power of any emission outside of the authorized operating frequency ranges must be lower than the transmitter power (P) by a factor of at least $43 + 10 \log (P)$ dB.

3.6.2 Test Procedures

The testing follows FCC KDB 971168 D01 v03r01 Section 6.1.

1. The EUT was connected to spectrum analyzer and system simulator via a power divider.
2. The RF output of EUT was connected to the spectrum analyzer by RF cable and attenuator. The path loss was compensated to the results for each measurement.
3. The middle channel for the highest RF power within the transmitting frequency was measured.
4. The conducted spurious emission for the whole frequency range was taken.
5. Make the measurement with the spectrum analyzer's RBW = 1MHz, VBW = 3MHz.
6. Set spectrum analyzer with RMS detector.
7. Taking the record of maximum spurious emission.
8. The RF fundamental frequency should be excluded against the limit line in the operating frequency band.
9. The limit line is derived from $43 + 10\log(P)$ dB below the transmitter power P(Watts)



3.7 Frequency Stability

3.7.1 Description of Frequency Stability Measurement

27.54

The frequency stability shall be sufficient to ensure that the fundamental emission stays within the authorized frequency block.

3.7.2 Test Procedures for Temperature Variation

The testing follows FCC KDB 971168 D01 v03r01 Section 9.0.

1. The EUT was set up in the thermal chamber and connected with the system simulator.
2. With power OFF, the temperature was decreased to -30°C and the EUT was stabilized before testing. Power was applied and the maximum change in frequency was recorded within one minute.
3. With power OFF, the temperature was raised in 10°C step up to 50°C . The EUT was stabilized at each step for at least half an hour. Power was applied and the maximum frequency change was recorded within one minute.

3.7.3 Test Procedures for Voltage Variation

The testing follows FCC KDB 971168 D01 v03r01 Section 9.0.

1. The EUT was placed in a temperature chamber at $20\pm 5^{\circ}\text{C}$ and connected with the system simulator.
2. The power supply voltage to the EUT was varied from 85% to 115% of the nominal value measured at the input to the EUT.
3. The variation in frequency was measured for the worst case.

4 Radiated Test Items

4.1 Measuring Instruments

See list of measuring instruments of this test report.

4.1.1 Test Setup

For radiated emissions below 30MHz



For radiated test from 30MHz to 1GHz

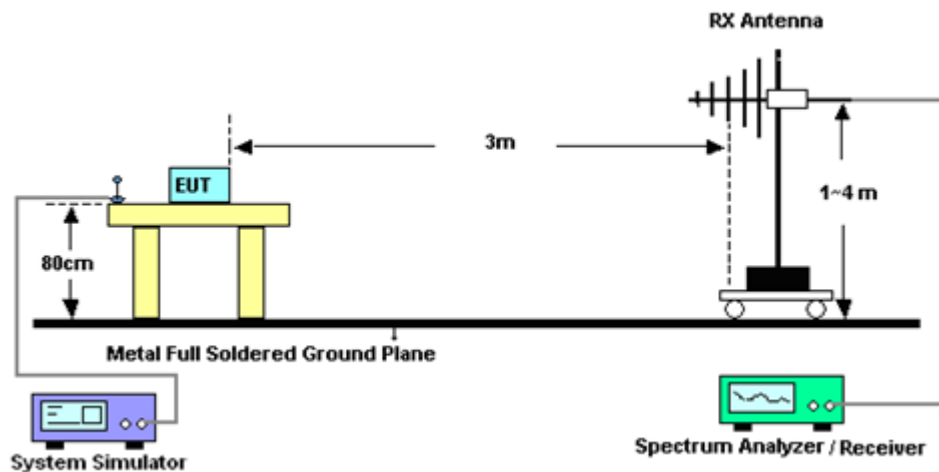

For radiated test from 1GHz to 18GHz

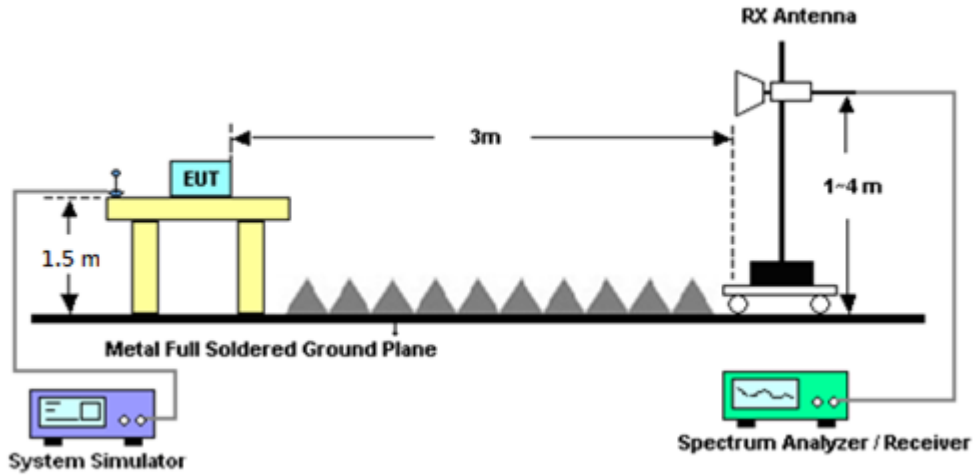

For radiated test above 18GHz

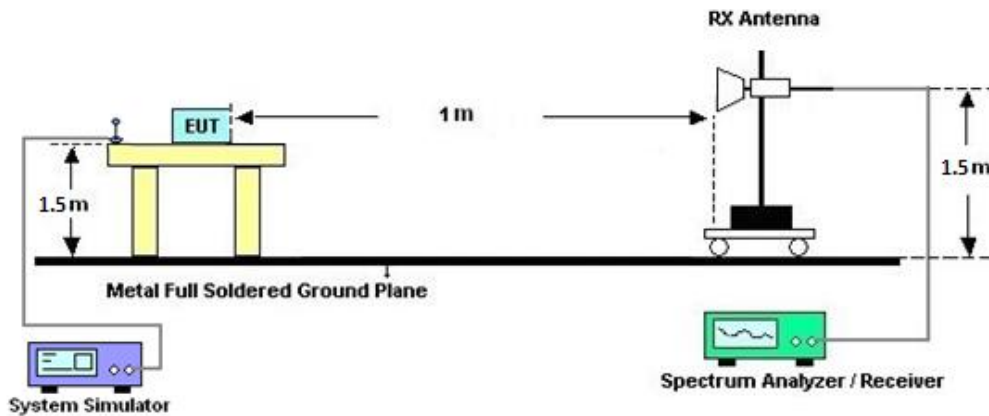

4.1.2 Test Result of Radiated Test

Please refer to Appendix B.

Note:

The low frequency, which started from 9 kHz to 30MHz, was pre-scanned and the result which was 20dB lower than the limit line was not reported.

There is adequate comparison measurement of both open-field test site and alternative test site - semi-Anechoic chamber according to 414788 D01 Radiated Test Site v01r01, and the result came out very similar.



4.2 Radiated Spurious Emission Measurement

4.2.1 Description of Radiated Spurious Emission Measurement

The radiated spurious emission was measured by substitution method according to ANSI / TIA-603-E. The power of any emission outside of the authorized operating frequency ranges must be attenuated below the transmitter power (P) by a factor of at least $43 + 10 \log (P)$ dB.

4.2.2 Test Procedures

The testing follows FCC KDB 971168 D01 v03r01 Section 7 and ANSI / TIA-603-E Section 2.2.12.

1. The EUT was placed on a turntable with 0.8 meter for frequency below 1GHz and 1.5 meter for frequency above 1GHz respectively above ground.
2. The EUT was set 3 meters from the receiving antenna, which was mounted on the antenna tower.
3. The table was rotated 360 degrees to determine the position of the highest spurious emission.
4. The height of the receiving antenna is varied between one meter and four meters to search the maximum spurious emission for both horizontal and vertical polarizations.
5. Make the measurement with the spectrum analyzer's RBW = 1MHz, VBW = 3MHz, taking the record of maximum spurious emission.
6. A horn antenna was substituted in place of the EUT and was driven by a signal generator.
7. Tune the output power of signal generator to the same emission level with EUT maximum spurious emission.
8. Taking the record of output power at antenna port.
9. Repeat step 7 to step 8 for another polarization.
10. The RF fundamental frequency should be excluded against the limit line in the operating frequency band.



5 List of Measuring Equipment

Instrument	Brand Name	Model No.	Serial No.	Characteristics	Calibration Date	Test Date	Due Date	Remark
Loop Antenna	Rohde & Schwarz	HFH2-Z2	100488	9 kHz~30 MHz	Sep. 07, 2021	May 07, 2022~ May 10, 2022	Sep. 06, 2022	Radiation (03CH12-HY)
Bilog Antenna	TESEQ	CBL 6111D & 00800N1D01N -06	37059 & 01	30MHz~1GHz	Oct. 09, 2021	May 07, 2022~ May 10, 2022	Oct. 08, 2022	Radiation (03CH12-HY)
Bilog Antenna	TESEQ	CBL 6111D & N-6-06	35414 & AT-N0602	30MHz~1GHz	Oct. 09, 2021	May 07, 2022~ May 10, 2022	Oct. 08, 2022	Radiation (03CH12-HY)
Horn Antenna	SCHWARZBE CK	BBHA 9120 D	9120D-1328	1GHz~18GHz	Dec. 03, 2021	May 07, 2022~ May 10, 2022	Dec. 02, 2022	Radiation (03CH12-HY)
Horn Antenna	SCHWARZBE CK	BBHA 9120 D	9120D-1212	1GHz~18GHz	May 18, 2021	May 07, 2022~ May 10, 2022	May 17, 2022	Radiation (03CH12-HY)
SHF-EHF Horn Antenna	SCHWARZBE CK	BBHA 9170	BBHA917025 1	18GHz~40GHz	Nov. 30, 2021	May 07, 2022~ May 10, 2022	Nov. 29, 2022	Radiation (03CH12-HY)
SHF-EHF Horn Antenna	SCHWARZBE CK	BBHA 9170	BBHA917057 6	18GHz~40GHz	May 21, 2021	May 07, 2022~ May 10, 2022	May 20, 2022	Radiation (03CH12-HY)
Preamplifier	COM-POWER	PA-103	161075	10MHz~1GHz	Mar. 23, 2022	May 07, 2022~ May 10, 2022	Mar. 22, 2023	Radiation (03CH12-HY)
Preamplifier	Aglient	8449B	3008A02375	1GHz~26.5GHz	May 25, 2021	May 07, 2022~ May 10, 2022	May 24, 2022	Radiation (03CH12-HY)
Preamplifier	E-INSTRUME NT TECH LTD.	ERA-100M-18 G-56-01-A70	EC1900270	1GHz-18GHz	Dec. 27, 2021	May 07, 2022~ May 10, 2022	Dec. 26, 2022	Radiation (03CH12-HY)
Preamplifier	EMEC	EM18G40G	060715	18GHz~40GHz	Dec. 24, 2021	May 07, 2022~ May 10, 2022	Dec. 23, 2022	Radiation (03CH12-HY)
Spectrum Analyzer	Keysight	N9010A	MY53470118	10Hz~44GHz	Jan. 12, 2022	May 07, 2022~ May 10, 2022	Jan. 11, 2023	Radiation (03CH12-HY)
RF Cable	HUBER + SUHNER	SUCOFLEX 104	MY9837/4PE	9kHz~30MHz	Mar. 10, 2022	May 07, 2022~ May 10, 2022	Mar. 09, 2023	Radiation (03CH12-HY)
RF Cable	HUBER + SUHNER	SUCOFLEX 126E	0058/126E	30MHz~18GHz	Dec. 10, 2021	May 07, 2022~ May 10, 2022	Dec. 09, 2022	Radiation (03CH12-HY)
RF Cable	HUBER + SUHNER	SUCOFLEX 102	505134/2	30MHz~40GHz	Feb. 21, 2022	May 07, 2022~ May 10, 2022	Feb. 20, 2023	Radiation (03CH12-HY)
RF Cable	HUBER + SUHNER	SUCOFLEX 102	803953/2	30MHz~40GHz	Mar. 08, 2022	May 07, 2022~ May 10, 2022	Mar. 07, 2023	Radiation (03CH12-HY)
Filter	Wainwright	WLKS1200-12 SS	SN2	1.2GHz Low Pass Filter	Mar. 16, 2022	May 07, 2022~ May 10, 2022	Mar. 15, 2023	Radiation (03CH12-HY)
Filter	Wainwright	WHKX8-5872. 5-6750-18000- 40ST	SN2	6.75GHz High Pass Filter	Mar. 16, 2022	May 07, 2022~ May 10, 2022	Mar. 15, 2023	Radiation (03CH12-HY)
Hygrometer	TECPEL	DTM-303B	TP140349	N/A	Sep. 30, 2021	May 07, 2022~ May 10, 2022	Sep. 29, 2022	Radiation (03CH12-HY)
Controller	EMEC	EM1000	N/A	Control Turn table & Ant Mast	N/A	May 07, 2022~ May 10, 2022	N/A	Radiation (03CH12-HY)
Antenna Mast	EMEC	AM-BS-4500-B	N/A	1m~4m	N/A	May 07, 2022~ May 10, 2022	N/A	Radiation (03CH12-HY)
Turn Table	EMEC	TT2000	N/A	0~360 Degree	N/A	May 07, 2022~ May 10, 2022	N/A	Radiation (03CH12-HY)
Software	Audix	E3 6.2009-8-24	RK-000989	N/A	N/A	May 07, 2022~ May 10, 2022	N/A	Radiation (03CH12-HY)
Signal Generator	Rohde & Schwarz	SMF100A	101107	100kHz~40GHz	Dec. 08, 2021	May 07, 2022~ May 10, 2022	Dec. 07, 2022	Radiation (03CH12-HY)



Instrument	Brand Name	Model No.	Serial No.	Characteristics	Calibration Date	Test Date	Due Date	Remark
Programmable Power Supply	GW Instek	PSS-2005	EL890001	50Hz~60Hz	Oct. 06, 2021	Mar. 21, 2022~ May 26, 2022	Oct. 05, 2022	Conducted (TH03-HY)
Hygrometer	Testo	608-H11	34893240	NA	Nov. 17, 2021	Mar. 21, 2022~ May 26, 2022	Nov. 16, 2022	Conducted (TH03-HY)
Temperature Chamber	ESPEC	SH-641	92013720	-40°C ~90°C	Sep. 09, 2021	Mar. 21, 2022~ May 26, 2022	Sep. 08, 2022	Conducted (TH03-HY)
Temperature Chamber	ESPEC	LHU-113	1012005860	-20°C ~85°C	Dec. 09, 2021	Mar. 21, 2022~ May 26, 2022	Dec. 08, 2022	Conducted (TH03-HY)
Base Station (Measure)	Anritsu	MT8821C	6261849015	LTE	Oct. 06, 2021	Mar. 21, 2022~ May 26, 2022	Oct. 05, 2022	Conducted (TH03-HY)
Base Station (Measure)	Anritsu	MT8000A	6261940327	FR1	Oct. 29, 2021	Mar. 21, 2022~ May 26, 2022	Oct. 28, 2022	Conducted (TH03-HY)



6 Uncertainty of Evaluation

Uncertainty of Radiated Emission Measurement (30 MHz ~ 1000 MHz)

Measuring Uncertainty for a Level of Confidence of 95% ($U = 2Uc(y)$)	3.10 dB
---	---------

Uncertainty of Radiated Emission Measurement (1 GHz ~ 18 GHz)

Measuring Uncertainty for a Level of Confidence of 95% ($U = 2Uc(y)$)	3.39 dB
---	---------

Uncertainty of Radiated Emission Measurement (18 GHz ~ 40 GHz)

Measuring Uncertainty for a Level of Confidence of 95% ($U = 2Uc(y)$)	4.34 dB
---	---------



Appendix A. Test Results of Conducted Test

Conducted Output Power(Average power) and ERP/EIRP

NR n77 Maximum Average Power [dBm] (GT - LC = 3.5 dB)								
BW [MHz]	RB Size	RB Offset	Mod	Lowest	Middle	Highest	EIRP (dBm)	EIRP(W)
20	1	1	PI/2 BPSK	26.01	25.56	25.79	29.54	0.8995
20	1	49		26.02	25.63	25.67		
20	25	12		25.92	25.62	25.82		
20	1	0		22.56	22.18	22.43		
20	1	50		22.66	22.22	22.32		
20	50	0		25.59	25.22	25.43		
20	1	1	QPSK	25.95	25.62	25.72		
20	1	49		26.04	25.64	25.46		
20	25	12		25.93	25.54	25.45		
20	1	0		22.63	22.21	22.25		
20	1	50		22.63	22.21	22.09		
20	50	0		25.07	24.73	24.75		
20	1	1	16-QAM	25.96	24.54	24.84	29.46	0.8831
20	1	1	64-QAM	23.62	23.08	23.45		
20	1	1	256-QAM	21.52	21.22	21.35		
Limit	EIRP < 1W			Result			Pass	

NR n77 Maximum Average Power [dBm] (GT - LC = 3.5 dB)								
BW [MHz]	RB Size	RB Offset	Mod	Lowest	Middle	Highest	EIRP (dBm)	EIRP(W)
30	1	1	PI/2 BPSK	26.07	25.70	26.02	29.71	0.9354
30	1	76		26.21	25.96	26.02		
30	36	18		26.02	25.88	26.01		
30	1	0		22.68	22.33	22.65		
30	1	77		22.81	22.51	22.63		
30	75	0		25.71	25.44	25.63		
30	1	1	QPSK	26.01	25.67	25.98		
30	1	76		26.15	25.87	26.01		
30	36	18		26.05	25.75	25.95		
30	1	0		22.67	22.32	22.61		
30	1	77		22.81	22.49	22.64		
30	75	0		25.28	24.86	25.11		
30	1	1	16-QAM	25.22	25.42	25.13	28.92	0.7798
30	1	1	64-QAM	23.72	23.25	23.72		
30	1	1	256-QAM	21.68	21.42	21.65		
30	1	1	256-QAM	21.68	21.42	21.65		
Limit	EIRP < 1W			Result			Pass	



NR n77 Maximum Average Power [dBm] (GT - LC = 3.5 dB)								
BW [MHz]	RB Size	RB Offset	Mod	Lowest	Middle	Highest	EIRP (dBm)	EIRP(W)
40	1	1	PI/2 BPSK	26.13	25.72	25.81	29.83	0.9616
40	1	104		26.33	25.84	25.98		
40	50	25		26.21	25.78	25.96		
40	1	0		22.76	22.43	22.46		
40	1	105		22.98	22.49	22.60		
40	100	0		25.84	25.41	25.54		
40	1	1	QPSK	26.16	25.78	25.88		
40	1	104		26.21	25.87	25.96		
40	50	25		26.19	25.81	25.92		
40	1	0		22.81	22.45	22.54		
40	1	105		22.85	22.48	22.56		
40	100	0		25.32	24.95	25.08		
40	1	1	16-QAM	25.19	24.95	24.89	28.69	0.7396
40	1	1	64-QAM	23.84	23.54	23.51		
40	1	1	256-QAM	21.83	21.51	21.46		
Limit	EIRP < 1W			Result			Pass	

NR n77 Maximum Average Power [dBm] (GT - LC = 3.5 dB)								
BW [MHz]	RB Size	RB Offset	Mod	Lowest	Middle	Highest	EIRP (dBm)	EIRP(W)
60	1	1	PI/2 BPSK	25.89	25.58	25.64	29.62	0.9162
60	1	160		25.94	25.57	25.56		
60	81	40		26.12	25.62	25.66		
60	1	0		22.54	22.37	22.27		
60	1	161		22.51	22.23	22.21		
60	162	0		25.66	25.12	25.27		
60	1	1	QPSK	25.95	25.58	25.49		
60	1	160		25.99	25.62	25.57		
60	81	40		26.10	25.64	25.65		
60	1	0		22.55	22.26	22.16		
60	1	161		22.53	22.16	22.21		
60	162	0		25.15	24.65	24.64		
60	1	1	16-QAM	24.95	24.74	24.51	28.45	0.6998
60	1	1	64-QAM	23.62	23.23	23.16		
60	1	1	256-QAM	21.57	21.35	21.21		
Limit	EIRP < 1W			Result			Pass	



NR n77 Maximum Average Power [dBm] (GT - LC = 3.5 dB)								
BW [MHz]	RB Size	RB Offset	Mod	Lowest	Middle	Highest	EIRP (dBm)	EIRP(W)
80	1	1	PI/2 BPSK	26.05	25.83	25.76	29.64	0.9204
80	1	215		25.89	25.53	25.56		
80	108	54		26.14	25.67	25.58		
80	1	0		22.68	22.58	22.35		
80	1	216		22.56	22.16	22.19		
80	216	0		25.63	25.18	25.26		
80	1	1	QPSK	26.06	25.87	25.71		
80	1	215		25.92	25.51	25.71		
80	108	54		26.11	25.63	25.63		
80	1	0		22.71	22.41	22.35		
80	1	216		22.54	22.09	22.23		
80	216	0		25.19	24.71	24.78		
80	1	1	16-QAM	25.10	24.99	24.98	28.60	0.7244
80	1	1	64-QAM	23.58	23.47	23.32		
80	1	1	256-QAM	21.64	21.49	21.48		
Limit	EIRP < 1W			Result			Pass	

NR n77 Maximum Average Power [dBm] (GT - LC = 3.5 dB)								
BW [MHz]	RB Size	RB Offset	Mod	Lowest	Middle	Highest	EIRP (dBm)	EIRP(W)
100	1	1	PI/2 BPSK	26.02	25.89	25.52	29.54	0.8995
100	1	271		25.96	25.66	25.65		
100	135	67		25.96	25.62	25.64		
100	1	0		22.64	22.51	22.16		
100	1	272		22.54	22.29	22.26		
100	270	0		25.54	25.21	25.18		
100	1	1	QPSK	26.04	25.81	25.59		
100	1	271		26.02	25.59	25.65		
100	135	67		25.96	25.65	25.65		
100	1	0		22.65	22.54	22.25		
100	1	272		22.53	22.24	22.26		
100	270	0		25.01	24.74	24.72		
100	1	1	16-QAM	24.98	24.85	24.65	28.48	0.7047
100	1	1	64-QAM	23.69	23.43	23.15		
100	1	1	256-QAM	21.63	21.44	21.14		
Limit	EIRP < 1W			Result			Pass	



NR n78 Maximum Average Power [dBm] (GT - LC = 3.5 dB)										
BW [MHz]	RB Size	RB Offset	Mod	Lowest	Middle	Highest	EIRP (dBm)	EIRP(W)		
20	1	1	PI/2 BPSK	22.96	23.17	23.16	26.665	0.4640		
20	1	49		22.63	23.04	23.05				
20	25	12		22.78	23.02	23.09				
20	1	0		22.58	22.76	22.74				
20	1	50		22.25	22.61	22.72				
20	50	0		22.36	22.51	22.65				
20	1	1	QPSK	22.65	23.02	23.01			26.665	0.4640
20	1	49		22.65	22.88	23.09				
20	25	12		22.78	22.95	23.03				
20	1	0		21.87	22.06	22.03				
20	1	50		21.86	21.95	22.09				
20	50	0		21.82	22.04	22.17				
20	1	1	16-QAM	22.06	22.09	22.03	25.59	0.3622		
20	1	1	64-QAM	20.54	20.51	20.64				
20	1	1	256-QAM	18.43	18.57	18.65				
Limit	EIRP < 1W			Result			Pass			

NR n78 Maximum Average Power [dBm] (GT - LC = 3.5 dB)										
BW [MHz]	RB Size	RB Offset	Mod	Lowest	Middle	Highest	EIRP (dBm)	EIRP(W)		
30	1	1	PI/2 BPSK	23.12	23.57	23.54	27.07	0.5093		
30	1	76		23.25	23.25	23.45				
30	36	18		23.12	23.28	23.45				
30	1	0		22.65	23.05	23.07				
30	1	77		22.78	22.85	23.05				
30	75	0		22.51	22.74	22.85				
30	1	1	QPSK	22.95	23.25	23.31			27.07	0.5093
30	1	76		23.11	23.15	23.32				
30	36	18		22.94	23.17	23.24				
30	1	0		21.98	22.35	22.45				
30	1	77		22.23	22.21	22.41				
30	75	0		22.04	22.28	22.31				
30	1	1	16-QAM	22.21	22.35	22.44	25.94	0.3926		
30	1	1	64-QAM	20.76	20.86	20.83				
30	1	1	256-QAM	18.69	18.75	18.82				
Limit	EIRP < 1W			Result			Pass			



NR n78 Maximum Average Power [dBm] (GT - LC = 3.5 dB)										
BW [MHz]	RB Size	RB Offset	Mod	Lowest	Middle	Highest	EIRP (dBm)	EIRP(W)		
40	1	1	PI/2 BPSK	23.16	23.56	23.47	27.06	0.5082		
40	1	104		23.47	23.38	23.49				
40	50	25		23.23	23.25	23.41				
40	1	0		22.66	22.98	22.95				
40	1	105		22.98	22.87	23.01				
40	100	0		22.63	22.81	22.75				
40	1	1	QPSK	22.94	23.34	23.15			27.06	0.5082
40	1	104		23.26	23.21	23.35				
40	50	25		23.04	23.18	23.15				
40	1	0		22.04	22.35	22.22				
40	1	105		22.29	22.28	22.41				
40	100	0		22.13	22.28	22.25				
40	1	1	16-QAM	22.25	22.26	22.35	25.85	0.3846		
40	1	1	64-QAM	20.76	20.79	20.84				
40	1	1	256-QAM	18.74	18.75	18.78				
Limit	EIRP < 1W			Result			Pass			

NR n78 Maximum Average Power [dBm] (GT - LC = 3.5 dB)										
BW [MHz]	RB Size	RB Offset	Mod	Lowest	Middle	Highest	EIRP (dBm)	EIRP(W)		
50	1	1	PI/2 BPSK	22.78	23.21	23.18	26.75	0.4732		
50	1	131		23.05	23.01	23.25				
50	64	32		23.02	23.10	23.14				
50	1	0		22.35	22.68	22.72				
50	1	132		22.50	22.49	22.68				
50	128	0		22.36	22.43	22.48				
50	1	1	QPSK	22.64	22.92	22.89			26.75	0.4732
50	1	131		22.85	22.78	22.95				
50	64	32		22.74	22.89	22.93				
50	1	0		21.70	21.99	21.92				
50	1	132		21.92	21.85	22.03				
50	128	0		21.78	21.93	21.98				
50	1	1	16-QAM	21.95	21.98	22.06	25.56	0.3597		
50	1	1	64-QAM	20.36	20.43	20.64				
50	1	1	256-QAM	18.42	18.45	18.55				
Limit	EIRP < 1W			Result			Pass			



NR n78 Maximum Average Power [dBm] (GT - LC = 3.5 dB)										
BW [MHz]	RB Size	RB Offset	Mod	Lowest	Middle	Highest	EIRP (dBm)	EIRP(W)		
60	1	1	PI/2 BPSK	22.95	23.18	23.24	26.78	0.4764		
60	1	160		23.15	23.21	23.15				
60	81	40		23.19	23.25	23.19				
60	1	0		22.54	22.62	22.68				
60	1	161		22.85	22.74	23.28				
60	162	0		22.45	22.54	22.55				
60	1	1	QPSK	22.63	22.95	22.93			26.78	0.4764
60	1	160		22.84	22.93	22.89				
60	81	40		22.93	22.97	22.94				
60	1	0		21.79	21.98	22.11				
60	1	161		21.93	22.05	21.98				
60	162	0		21.95	22.03	22.01				
60	1	1	16-QAM	21.95	21.98	21.98	25.48	0.3532		
60	1	1	64-QAM	20.48	20.56	20.48				
60	1	1	256-QAM	18.35	18.54	18.59				
Limit	EIRP < 1W			Result			Pass			

NR n78 Maximum Average Power [dBm] (GT - LC = 3.5 dB)										
BW [MHz]	RB Size	RB Offset	Mod	Lowest	Middle	Highest	EIRP (dBm)	EIRP(W)		
70	1	1	PI/2 BPSK	22.89	23.05	23.15	26.83	0.4819		
70	1	187		23.16	23.33	23.18				
70	90	45		23.09	23.26	23.01				
70	1	0		22.46	22.54	22.75				
70	1	188		22.72	22.77	22.71				
70	180	0		22.41	22.51	22.42				
70	1	1	QPSK	22.67	22.75	22.92			26.83	0.4819
70	1	187		22.92	23.02	22.98				
70	90	45		22.92	22.97	22.84				
70	1	0		21.66	21.82	21.95				
70	1	188		21.94	22.13	21.98				
70	180	0		21.86	22.04	21.90				
70	1	1	16-QAM	21.98	21.95	21.95	25.48	0.3532		
70	1	1	64-QAM	20.54	20.39	20.44				
70	1	1	256-QAM	18.45	18.35	18.56				
Limit	EIRP < 1W			Result			Pass			



NR n78 Maximum Average Power [dBm] (GT - LC = 3.5 dB)										
BW [MHz]	RB Size	RB Offset	Mod	Lowest	Middle	Highest	EIRP (dBm)	EIRP(W)		
80	1	1	PI/2 BPSK	22.96	23.05	23.10	26.93	0.4932		
80	1	215		23.28	23.43	23.26				
80	108	54		23.21	23.22	23.14				
80	1	0		22.49	22.53	22.60				
80	1	216		22.78	22.77	22.76				
80	216	0		22.48	22.55	22.45				
80	1	1	QPSK	22.65	22.76	22.78			25.54	0.3581
80	1	215		22.98	23.02	22.98				
80	108	54		23.01	23.06	22.89				
80	1	0		21.84	21.83	21.96				
80	1	216		22.07	22.11	22.06				
80	216	0		21.93	22.09	21.97				
80	1	1	16-QAM	22.04	21.98	21.85	25.54	0.3581		
80	1	1	64-QAM	20.52	20.54	20.45				
80	1	1	256-QAM	18.51	18.54	18.45				
Limit	EIRP < 1W			Result			Pass			

NR n78 Maximum Average Power [dBm] (GT - LC = 3.5 dB)										
BW [MHz]	RB Size	RB Offset	Mod	Lowest	Middle	Highest	EIRP (dBm)	EIRP(W)		
90	1	1	PI/2 BPSK	23.05	23.01	23.08	26.81	0.4797		
90	1	243		23.27	23.31	23.28				
90	120	60		23.07	23.27	23.28				
90	1	0		22.56	22.52	22.57				
90	1	244		22.81	22.79	22.77				
90	243	0		22.53	22.53	22.57				
90	1	1	QPSK	22.78	22.84	22.87			25.63	0.3656
90	1	243		23.03	23.02	22.99				
90	120	60		22.96	22.99	23.01				
90	1	0		21.76	21.93	21.95				
90	1	244		22.12	22.13	22.03				
90	243	0		21.99	22.01	22.08				
90	1	1	16-QAM	22.11	22.13	22.08	25.63	0.3656		
90	1	1	64-QAM	20.51	20.54	20.53				
90	1	1	256-QAM	18.54	18.65	18.56				
Limit	EIRP < 1W			Result			Pass			



NR n78 Maximum Average Power [dBm] (GT - LC = 3.5 dB)								
BW [MHz]	RB Size	RB Offset	Mod	Lowest	Middle	Highest	EIRP (dBm)	EIRP(W)
100	1	1	PI/2 BPSK	-	23.04	-	26.74	0.4721
100	1	271		-	23.24	-		
100	135	67		-	23.09	-		
100	1	0		-	22.66	-		
100	1	272		-	22.83	-		
100	270	0		-	22.56	-		
100	1	1	QPSK	-	22.83	-	26.74	0.4721
100	1	271		-	23.01	-		
100	135	67		-	22.99	-		
100	1	0		-	21.92	-		
100	1	272		-	22.12	-		
100	270	0		-	22.01	-		
100	1	1	16-QAM	-	22.15	-	25.65	0.3673
100	1	1	64-QAM	-	20.49	-		
100	1	1	256-QAM	-	18.65	-		
Limit	EIRP < 1W			Result			Pass	



FR1 n77

Peak-to-Average Ratio

Mode	FR1 n77 / 20MHz / DFT-S OFDM				
Mod.	PI/2 BPSK	QPSK	16QAM	64QAM	Limit: 13dB
RB Size	Full RB	Full RB	Full RB	Full RB	Result
Middle CH	4.40	5.70	6.32	6.58	PASS
Mode	FR1 n77 / 20MHz / DFT-S OFDM				
Mod.	256QAM				Limit: 13dB
RB Size	Full RB				Result
Middle CH	6.66				PASS



FR1 n77 / 20MHz / DFT-S OFDM / Middle Channel / Full RB

PI/2 BPSK

QPSK

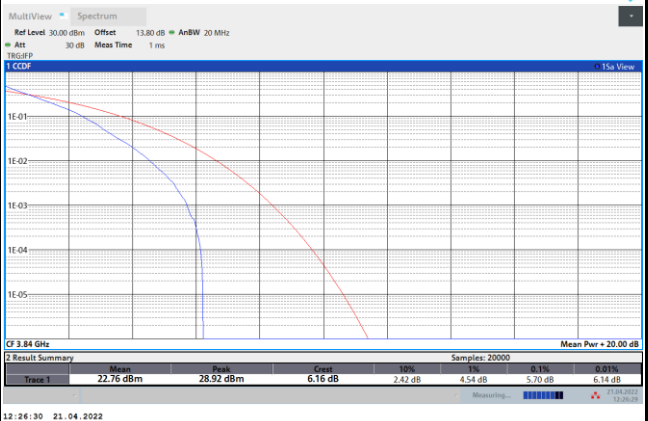
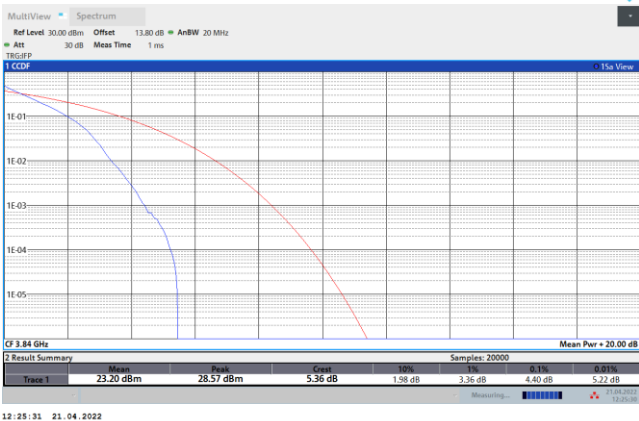

16QAM

64QAM

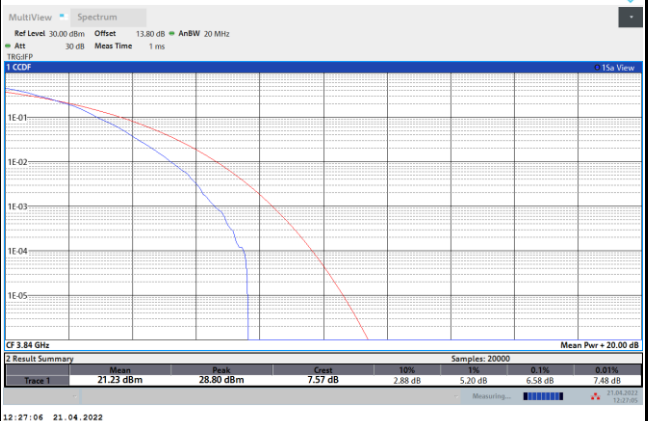
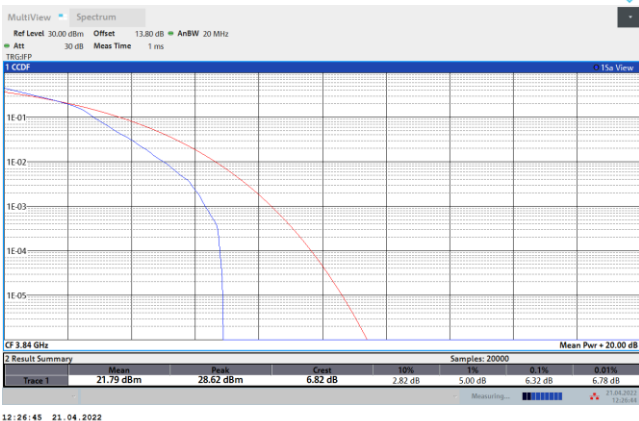

256QAM

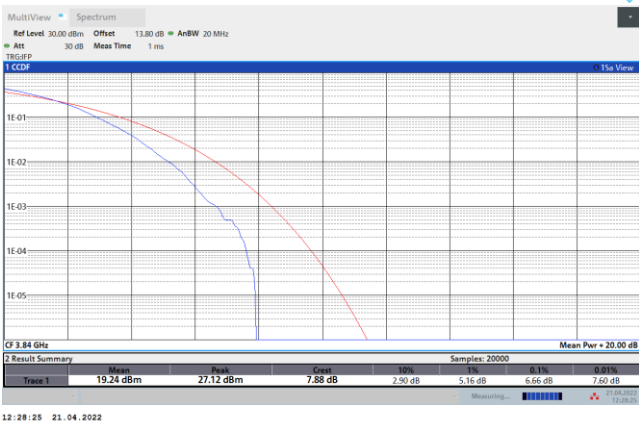



26dB Bandwidth

Mode	FR1 n77 : 26dB BW(MHz) / DFT-S OFDM							
BW	20MHz	30MHz	40MHz	50MHz	60MHz	70MHz	80MHz	90MHz
Mod.	PI/2 BPSK	PI/2 BPSK	PI/2 BPSK	PI/2 BPSK	PI/2 BPSK	PI/2 BPSK	PI/2 BPSK	PI/2 BPSK
Middle CH	18.86	27.99	38.28	-	60.54	-	79.92	-
BW	100MHz							
Mod.	PI/2 BPSK							
Middle CH	99.30							

Mode	FR1 n77 : 26dB BW(MHz) / CP OFDM							
BW	20MHz		30MHz		40MHz		50MHz	
Mod.	QPSK	16QAM	QPSK	16QAM	QPSK	16QAM	QPSK	16QAM
Middle CH	19.30	19.06	29.19	28.95	40.28	40.28	-	-
Mod.	64QAM	256QAM	64QAM	256QAM	64QAM	256QAM	64QAM	256QAM
Middle CH	19.06	19.22	28.95	28.89	40.36	40.28	-	-
BW	60MHz		70MHz		80MHz		90MHz	
Mod.	QPSK	16QAM	QPSK	16QAM	QPSK	16QAM	QPSK	16QAM
Middle CH	60.54	60.54	-	-	80.40	80.56	-	-
Mod.	64QAM	256QAM	64QAM	256QAM	64QAM	256QAM	64QAM	256QAM
Middle CH	60.66	60.42	-	-	80.24	80.24	-	-
BW	100MHz							
Mod.	QPSK	16QAM						
Middle CH	100.30	100.50						
Mod.	64QAM	256QAM						
Middle CH	100.50	100.50						



FR1 n77 / 20MHz / DFT-S OFDM / Middle Channel / Full RB

PI/2 BPSK

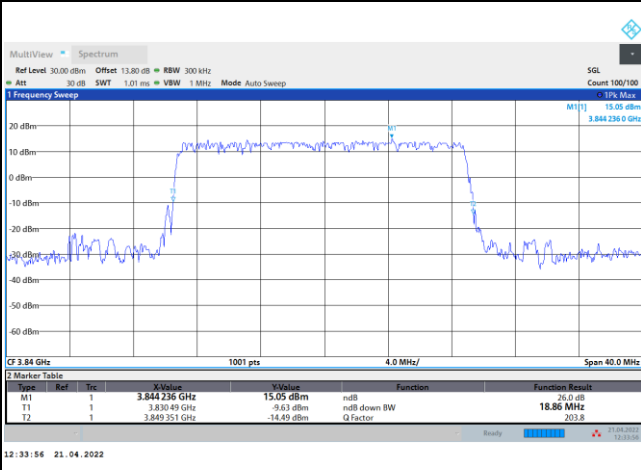

FR1 n77 / 20MHz / CP OFDM / Middle Channel / Full RB

QPSK

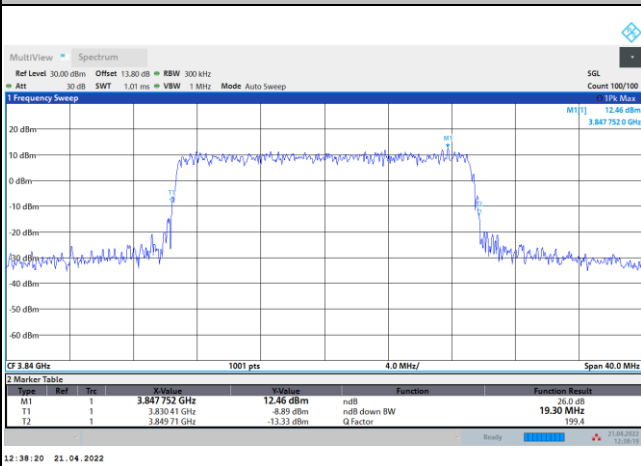

16QAM

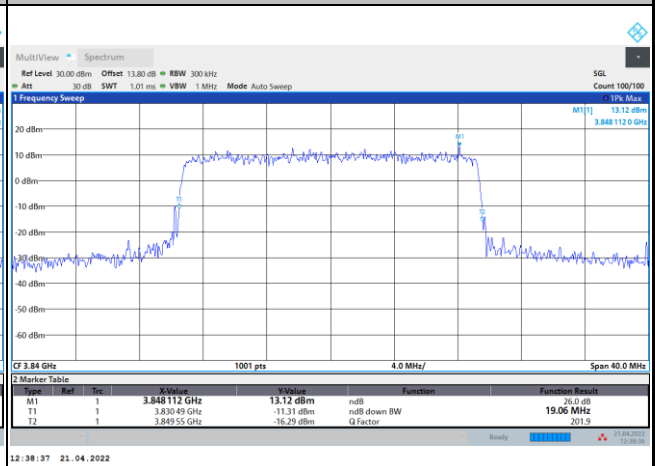

64QAM

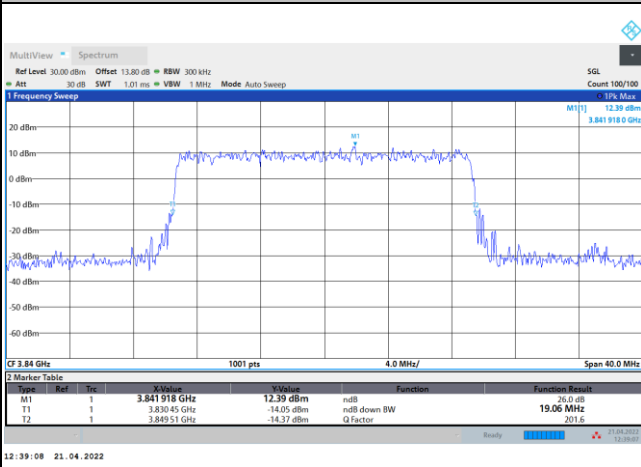

256QAM

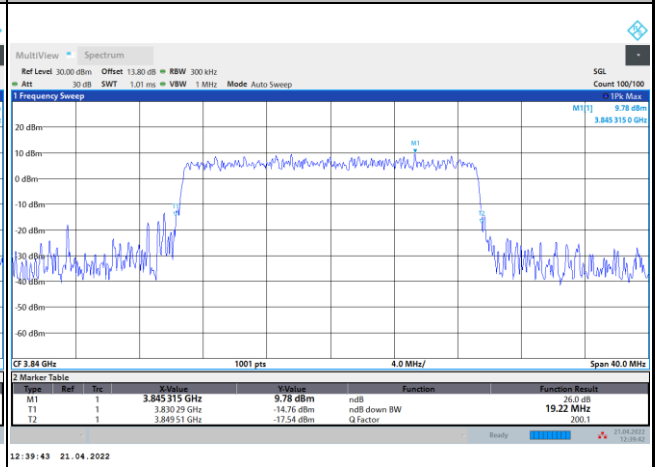



FR1 n77 / 30MHz / DFT-S OFDM / Middle Channel / Full RB

PI/2 BPSK

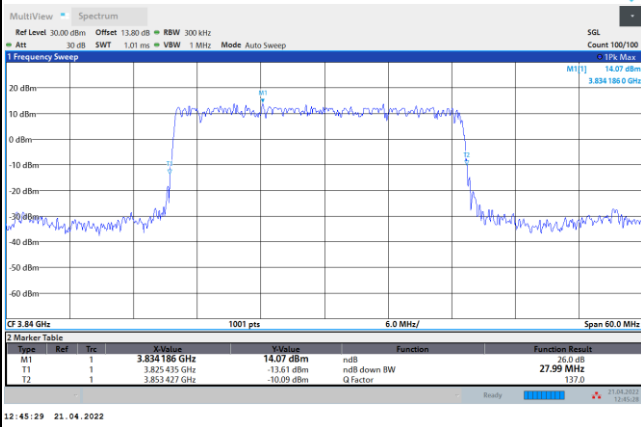

FR1 n77 / 30MHz / CP OFDM / Middle Channel / Full RB

QPSK

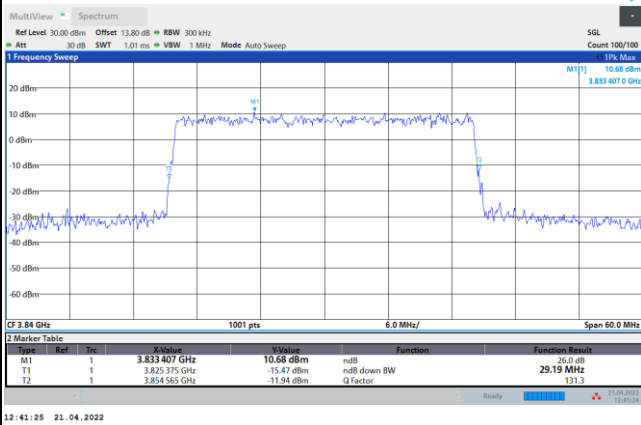

16QAM

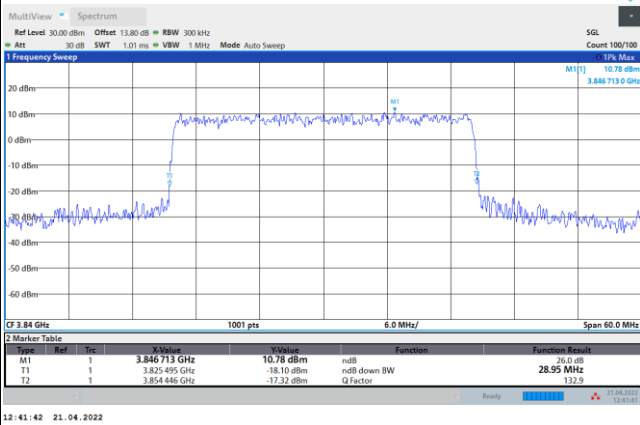

64QAM

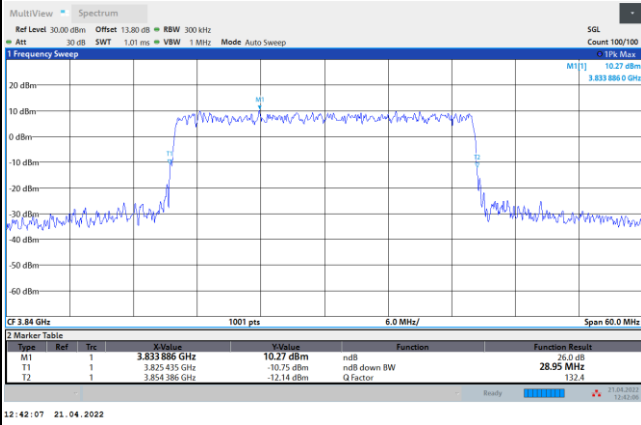

256QAM

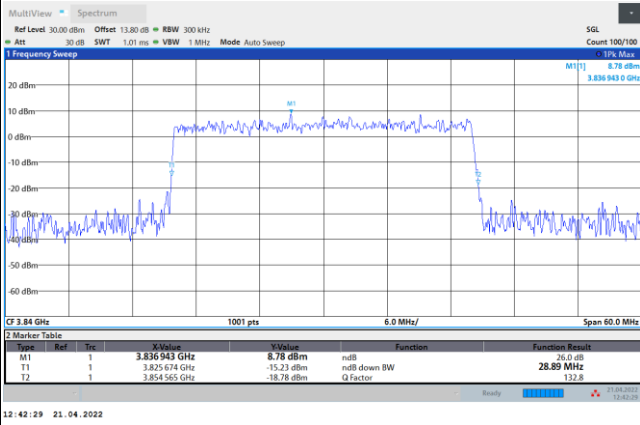



FR1 n77 / 40MHz / DFT-S OFDM / Middle Channel / Full RB

PI/2 BPSK



FR1 n77 / 40MHz / CP OFDM / Middle Channel / Full RB

QPSK

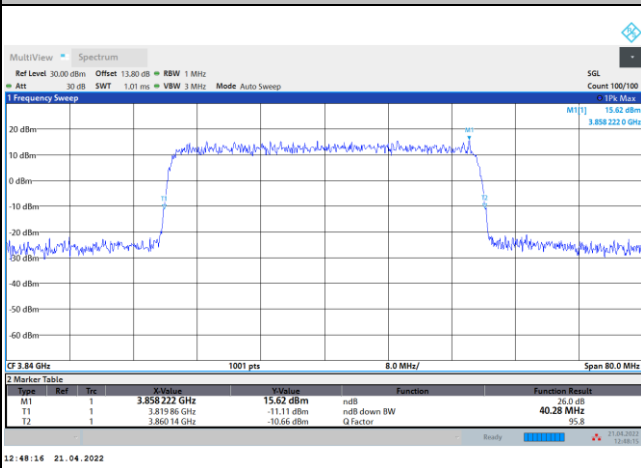

16QAM

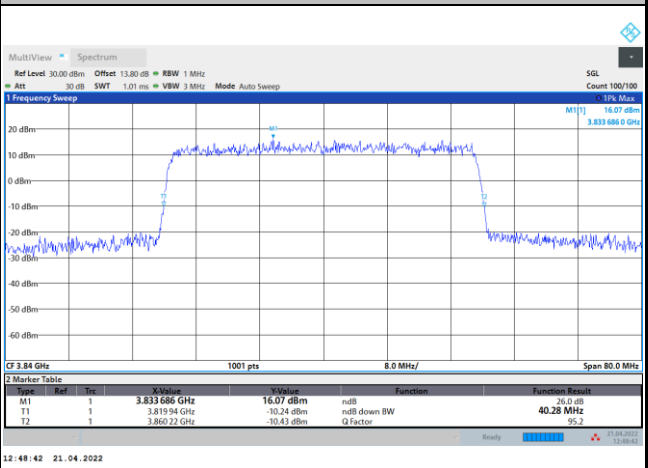

64QAM

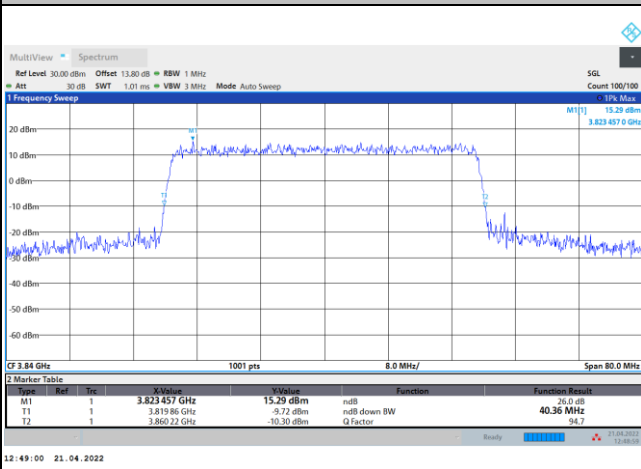

256QAM

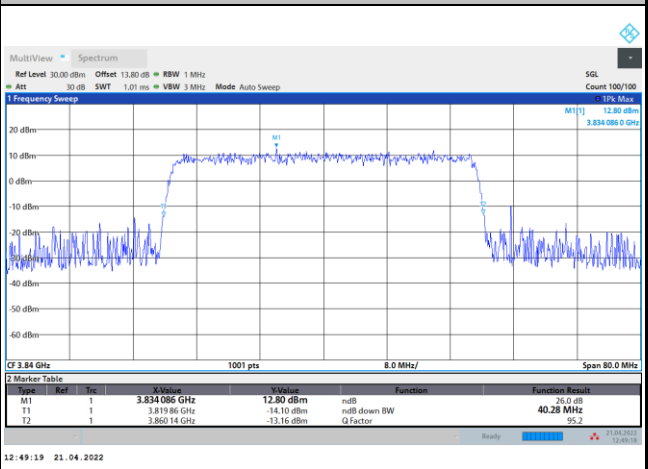



FR1 n77 / 60MHz / DFT-S OFDM / Middle Channel / Full RB

PI/2 BPSK

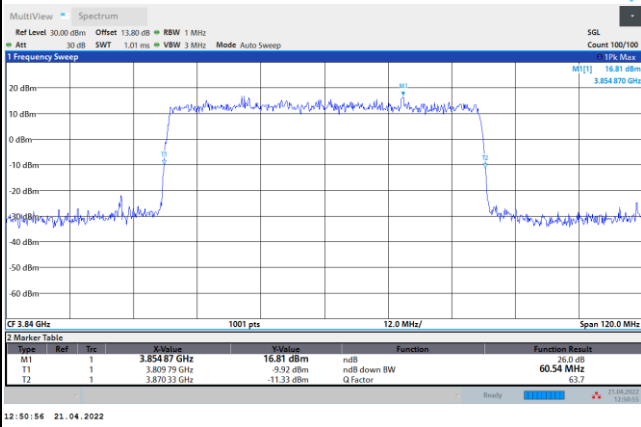

FR1 n77 / 60MHz / CP OFDM / Middle Channel / Full RB

QPSK

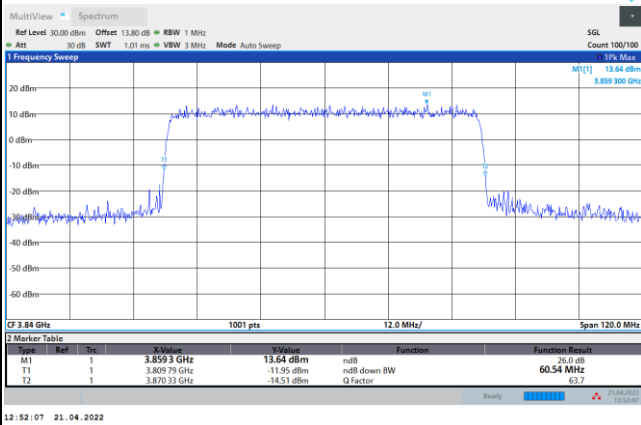

16QAM

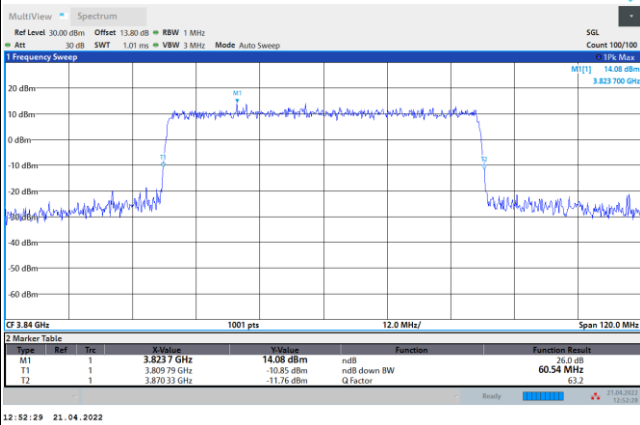

64QAM

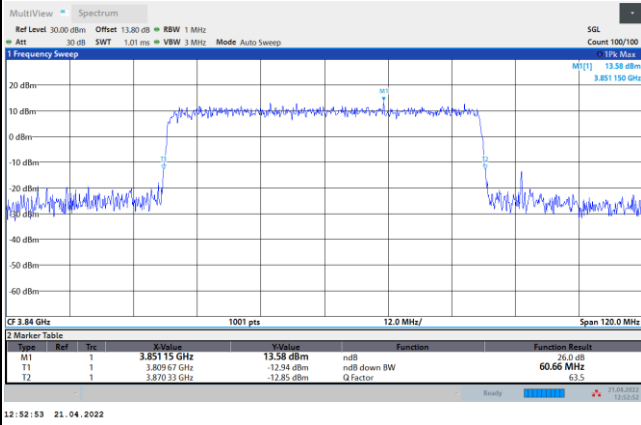

256QAM

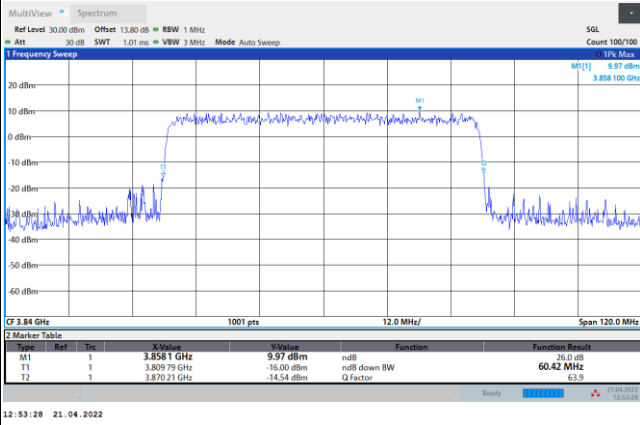



FR1 n77 / 80MHz / DFT-S OFDM / Middle Channel / Full RB

PI/2 BPSK

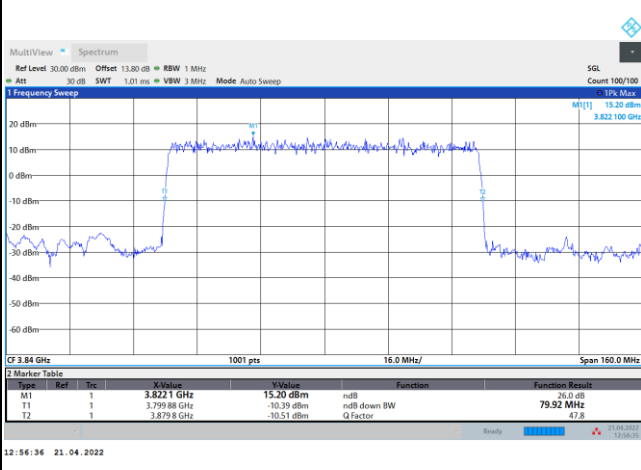

FR1 n77 / 80MHz / CP OFDM / Middle Channel / Full RB

QPSK

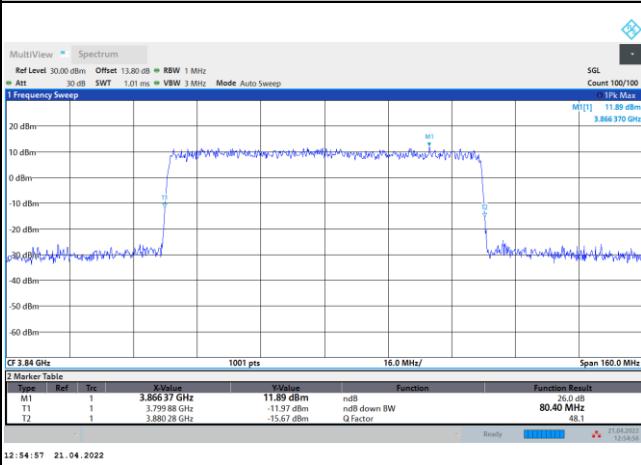

16QAM

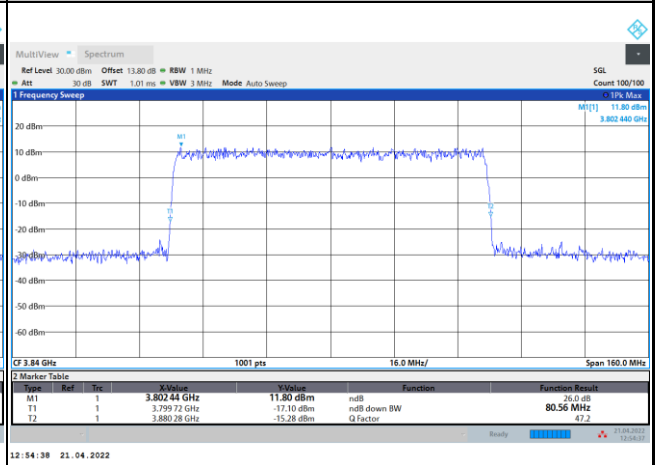

64QAM

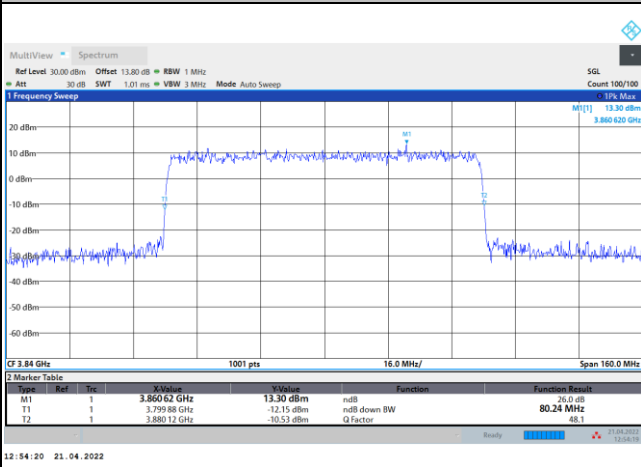

256QAM

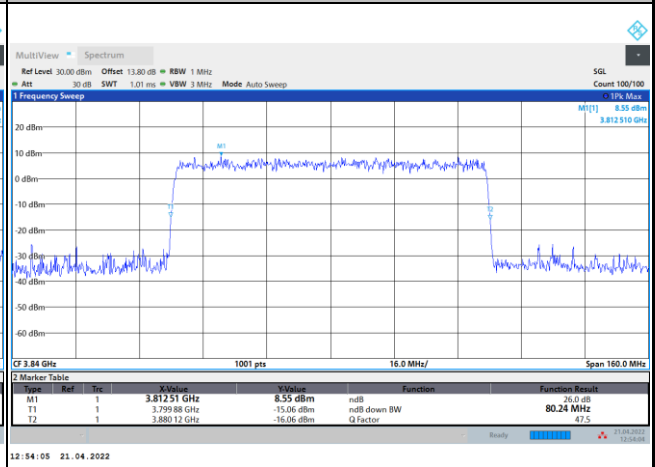



FR1 n77 / 100MHz / DFT-S OFDM / Middle Channel / Full RB

PI/2 BPSK

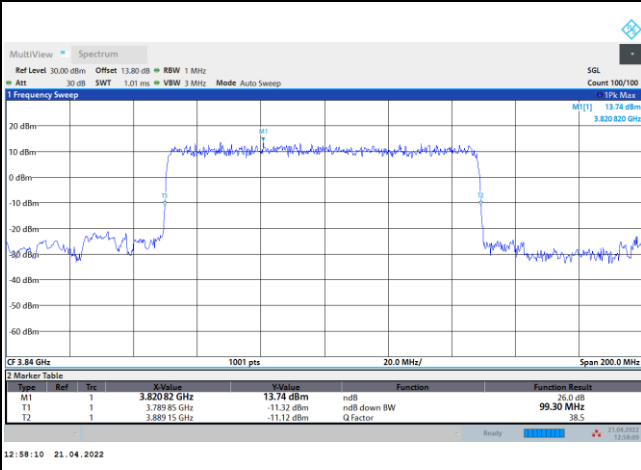

FR1 n77 / 100MHz / CP OFDM / Middle Channel / Full RB

QPSK

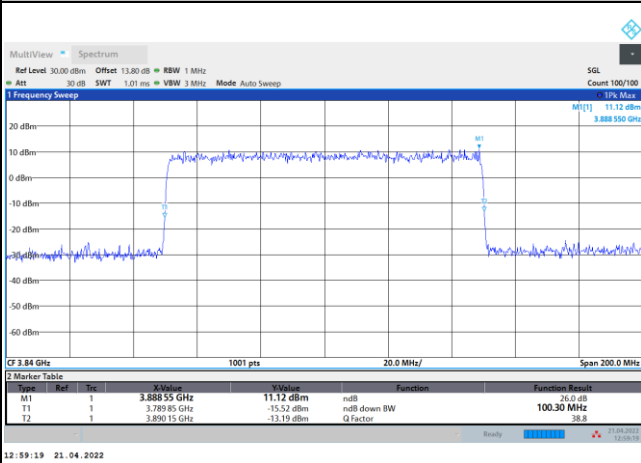

16QAM

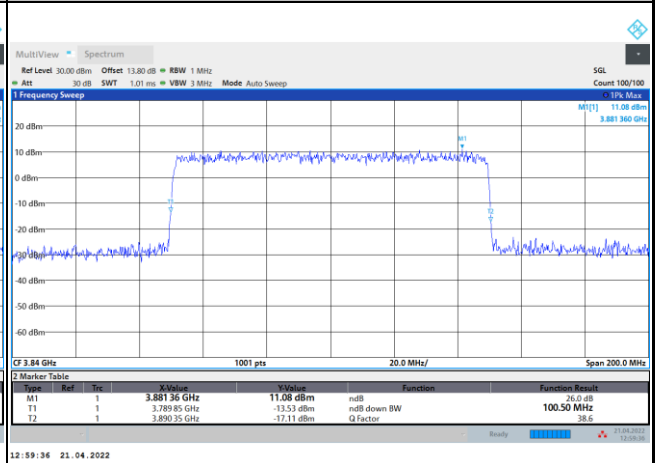

64QAM

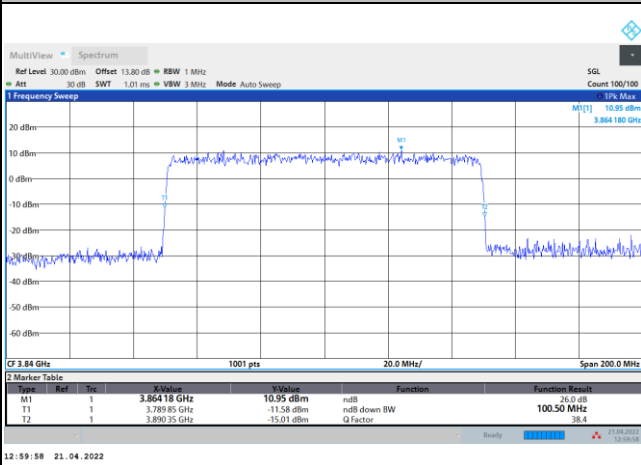

256QAM

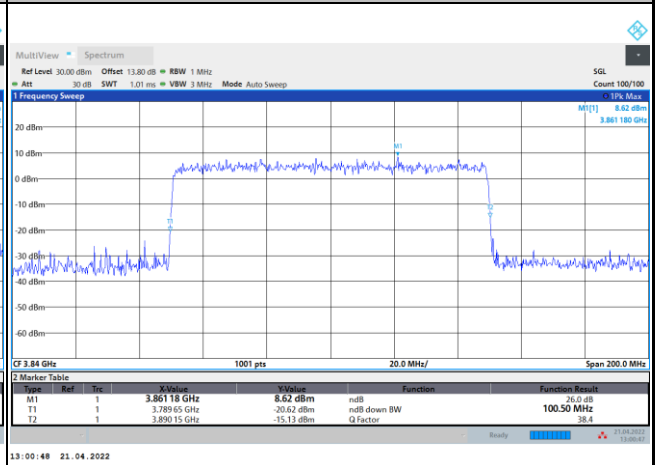



Occupied Bandwidth

Mode	FR1 n77 : OB BW(MHz) / DFT-S OFDM							
BW	20MHz	30MHz	40MHz	50MHz	60MHz	70MHz	80MHz	90MHz
Mod.	PI/2 BPSK	PI/2 BPSK	PI/2 BPSK	PI/2 BPSK	PI/2 BPSK	PI/2 BPSK	PI/2 BPSK	PI/2 BPSK
Middle CH	17.89	26.71	35.90	-	57.81	-	76.83	-
BW	100MHz							
Mod.	PI/2 BPSK							
Middle CH	95.99							

Mode	FR1 n77 : OB BW(MHz) / CP OFDM							
BW	20MHz		30MHz		40MHz		50MHz	
Mod.	QPSK	16QAM	QPSK	16QAM	QPSK	16QAM	QPSK	16QAM
Middle CH	18.20	18.17	27.78	27.86	37.92	37.95	-	-
Mod.	64QAM	256QAM	64QAM	256QAM	64QAM	256QAM	64QAM	256QAM
Middle CH	18.23	18.24	27.82	27.71	37.94	37.96	-	-
BW	60MHz		70MHz		80MHz		90MHz	
Mod.	QPSK	16QAM	QPSK	16QAM	QPSK	16QAM	QPSK	16QAM
Middle CH	57.89	57.83	-	-	77.25	77.28	-	-
Mod.	64QAM	256QAM	64QAM	256QAM	64QAM	256QAM	64QAM	256QAM
Middle CH	57.81	57.74	-	-	77.44	77.49	-	-
BW	100MHz							
Mod.	QPSK	16QAM						
Middle CH	96.99	97.20						
Mod.	64QAM	256QAM						
Middle CH	97.31	97.40						



FR1 n77 / 20MHz / DFT-S OFDM / Middle Channel / Full RB

PI/2 BPSK

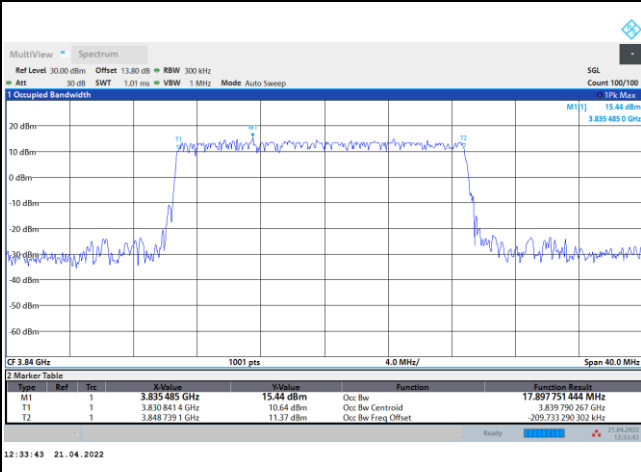

FR1 n77 / 20MHz / CP OFDM / Middle Channel / Full RB

QPSK

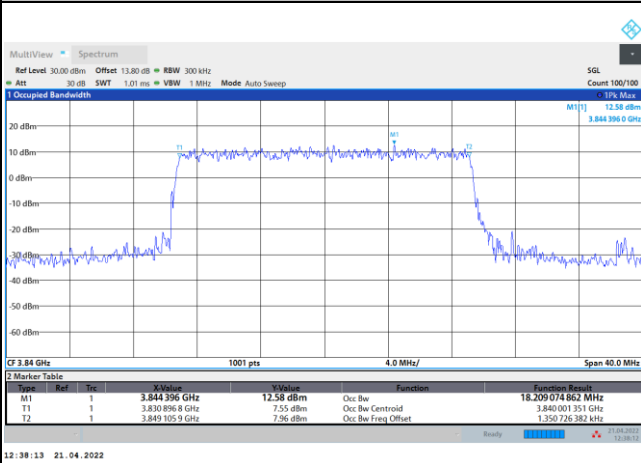

16QAM

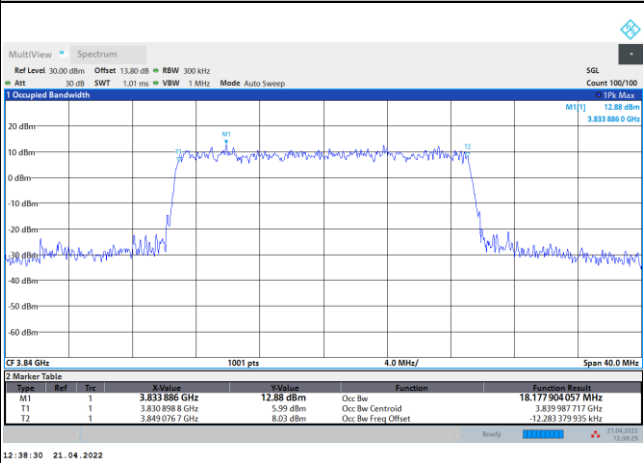

64QAM

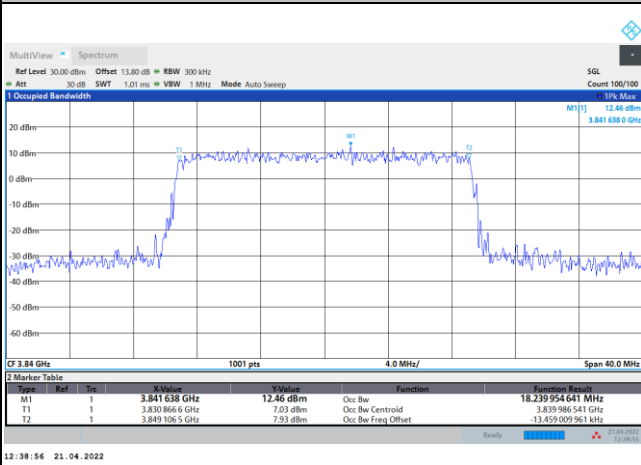

256QAM

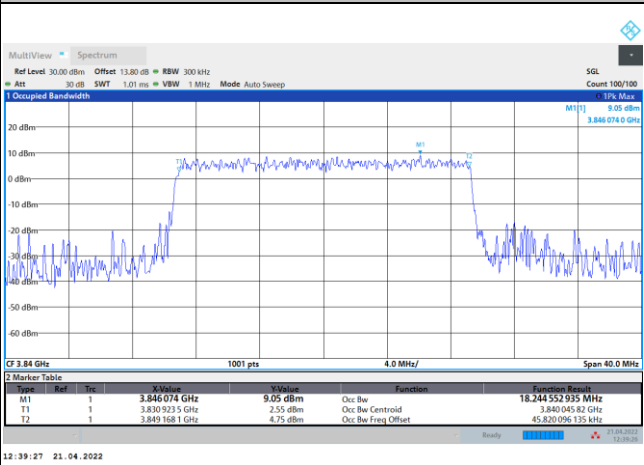



FR1 n77 / 30MHz / DFT-S OFDM / Middle Channel / Full RB

PI/2 BPSK

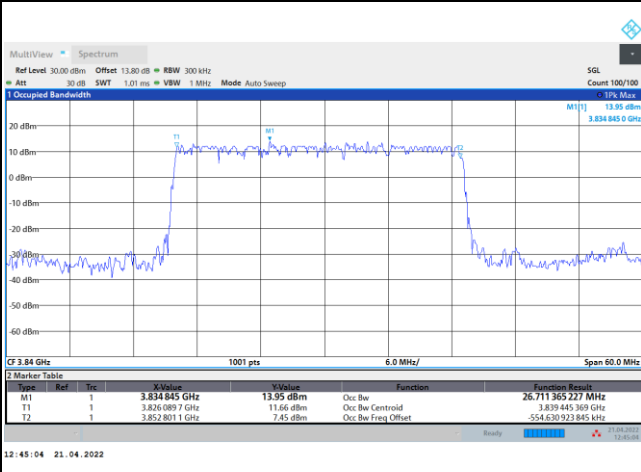

FR1 n77 / 30MHz / CP OFDM / Middle Channel / Full RB

QPSK

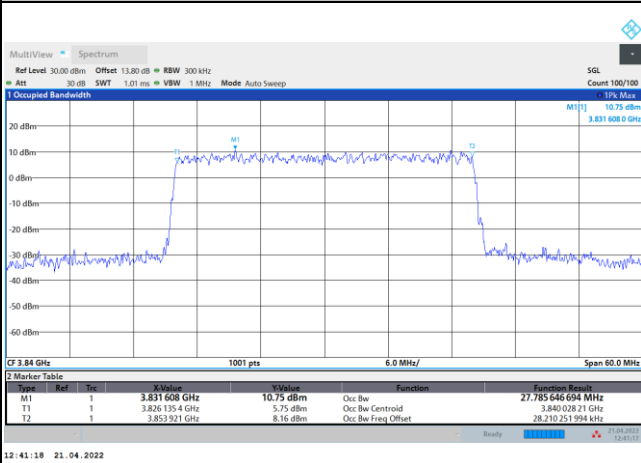

16QAM

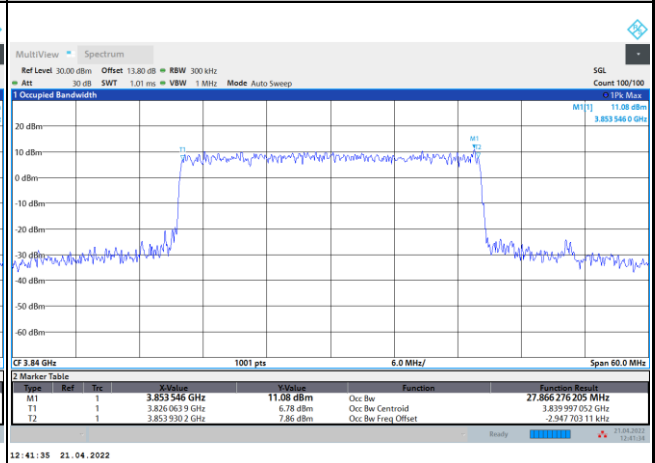

64QAM

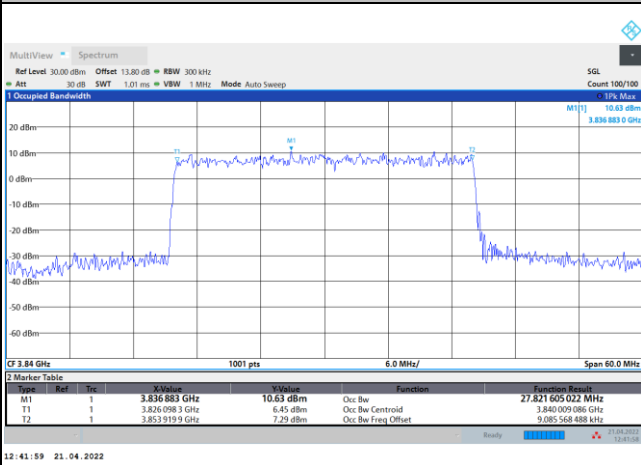

256QAM

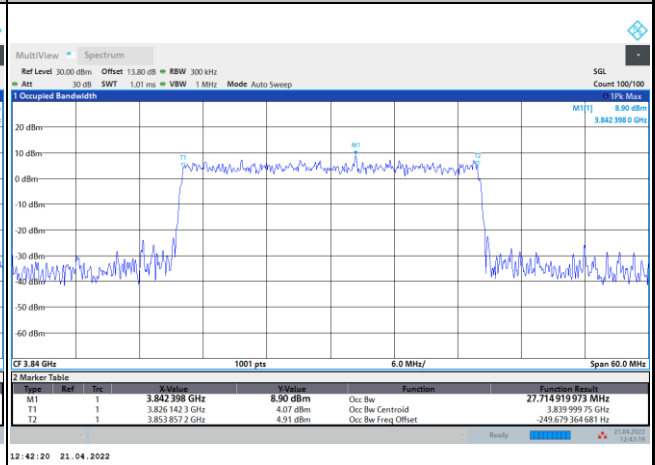



FR1 n77 / 40MHz / DFT-S OFDM / Middle Channel / Full RB

PI/2 BPSK

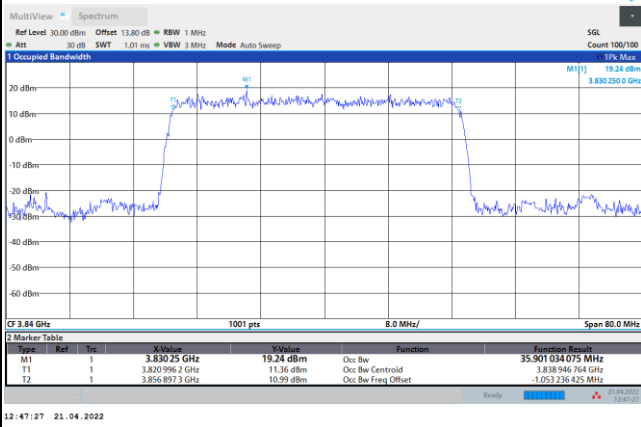

FR1 n77 / 40MHz / CP OFDM / Middle Channel / Full RB

QPSK

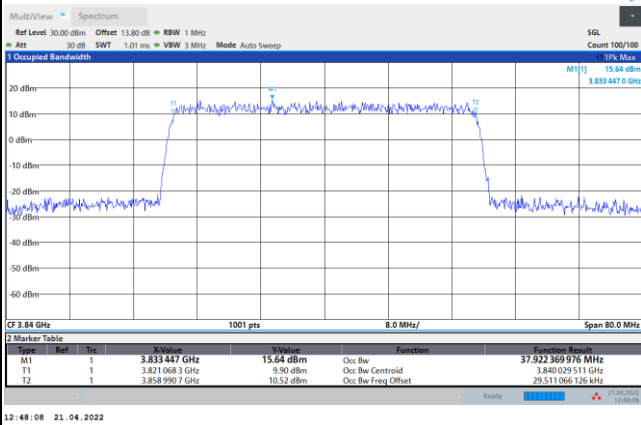

16QAM

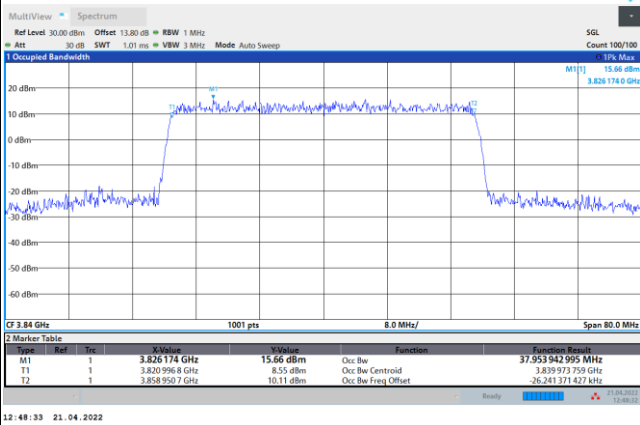

64QAM

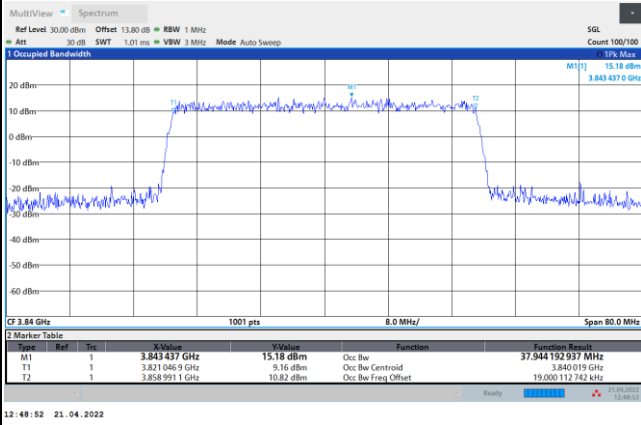

256QAM

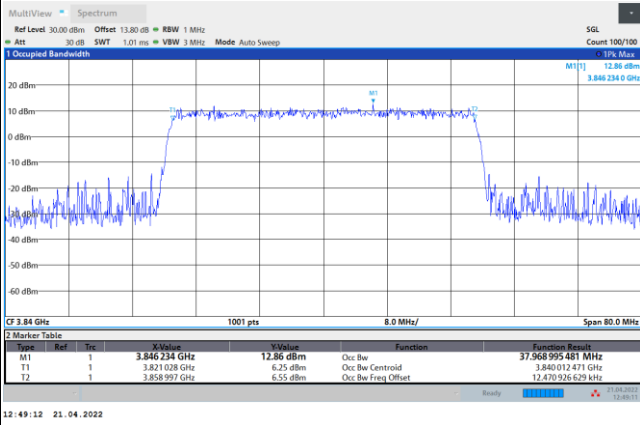



FR1 n77 / 60MHz / DFT-S OFDM / Middle Channel / Full RB

PI/2 BPSK

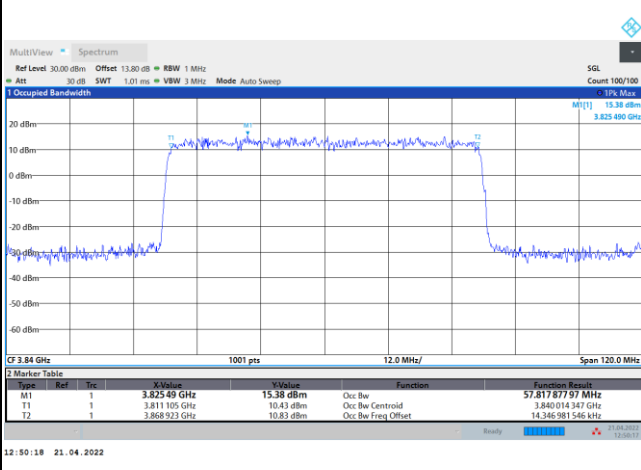

FR1 n77 / 60MHz / CP OFDM / Middle Channel / Full RB

QPSK

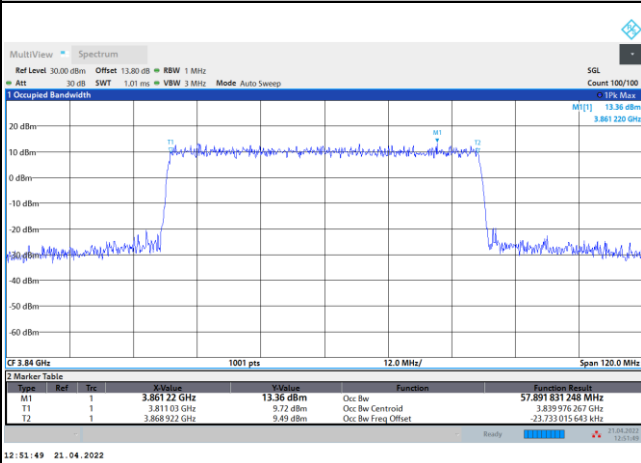

16QAM

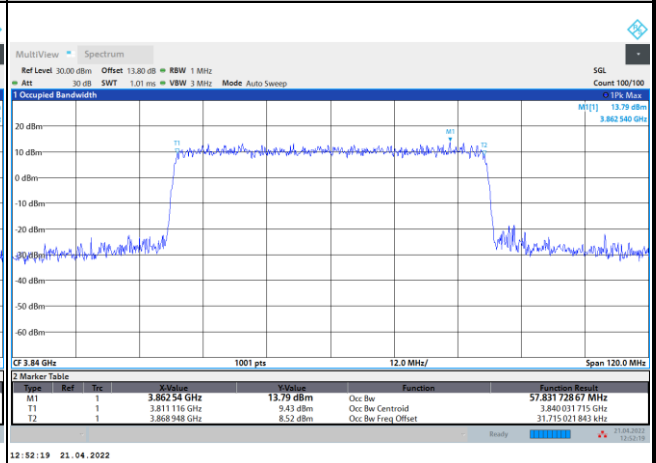

64QAM

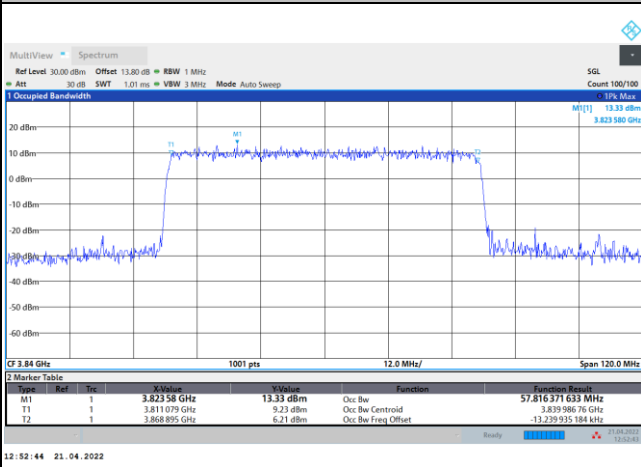

256QAM

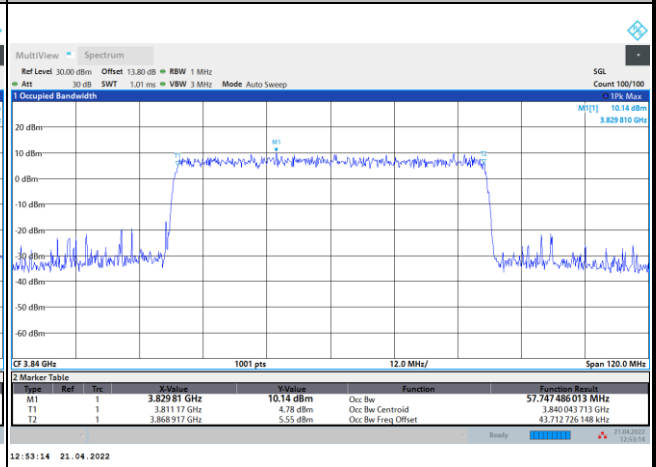



FR1 n77 / 80MHz / DFT-S OFDM / Middle Channel / Full RB

PI/2 BPSK

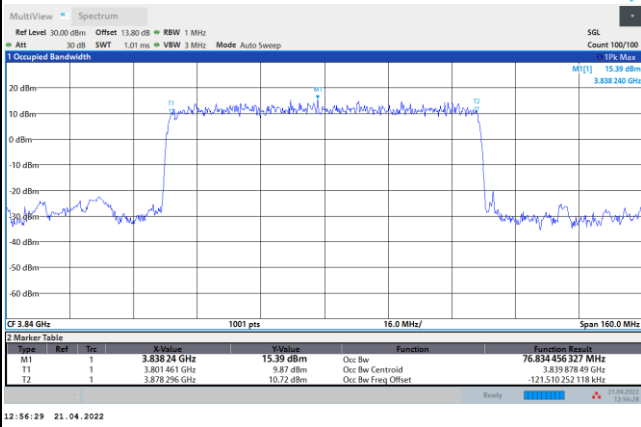

FR1 n77 / 80MHz / CP OFDM / Middle Channel / Full RB

QPSK

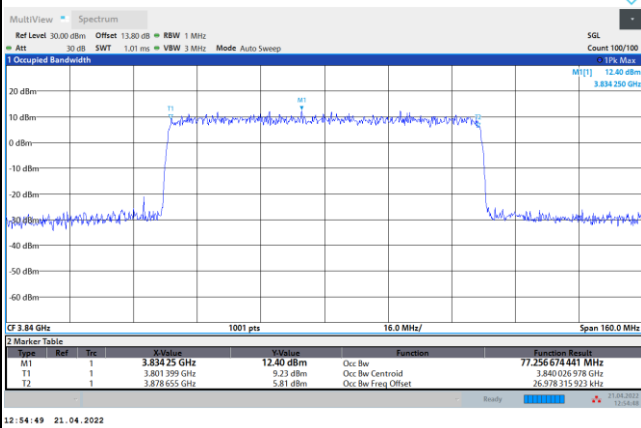

16QAM

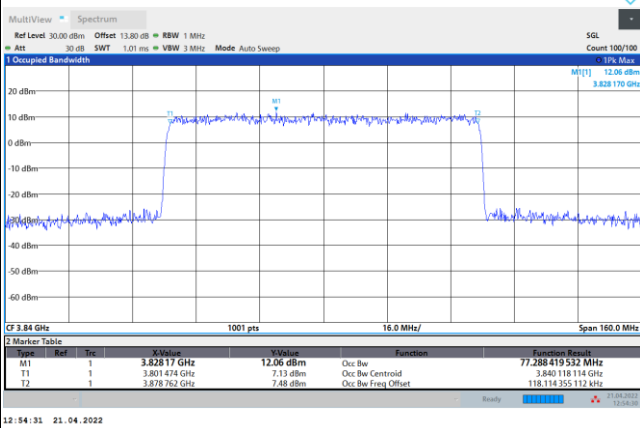

64QAM

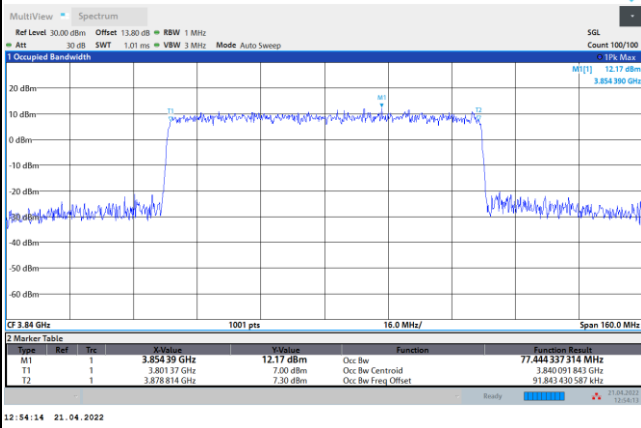

256QAM

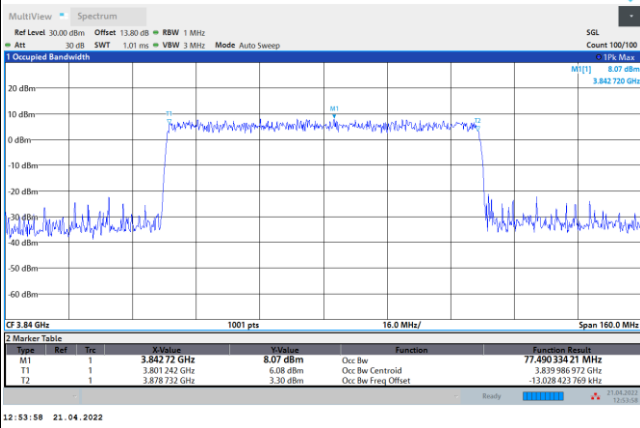



FR1 n77 / 100MHz / DFT-S OFDM / Middle Channel / Full RB

PI/2 BPSK

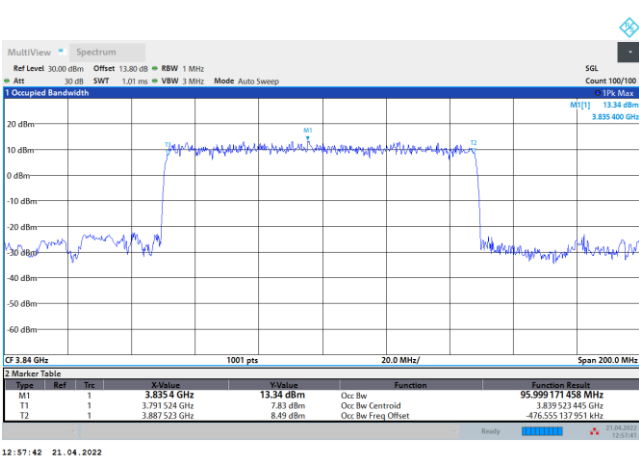

FR1 n77 / 100MHz / CP OFDM / Middle Channel / Full RB

QPSK

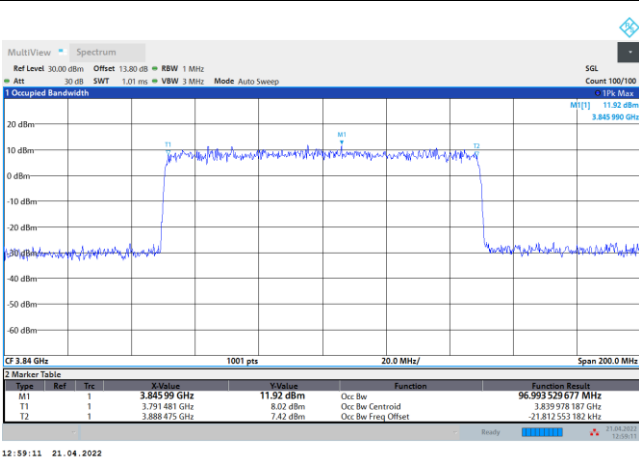

16QAM

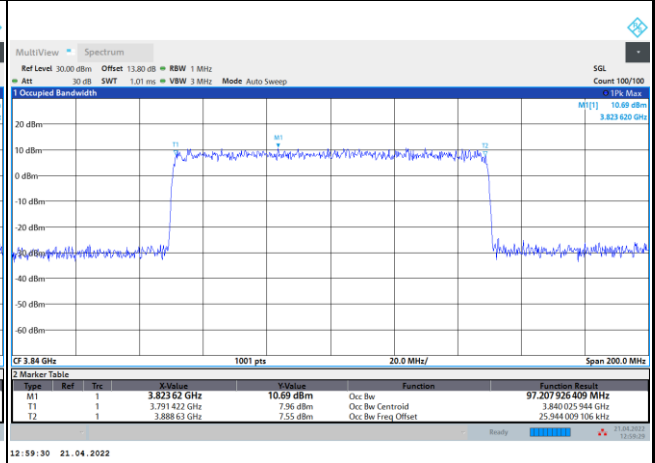

64QAM

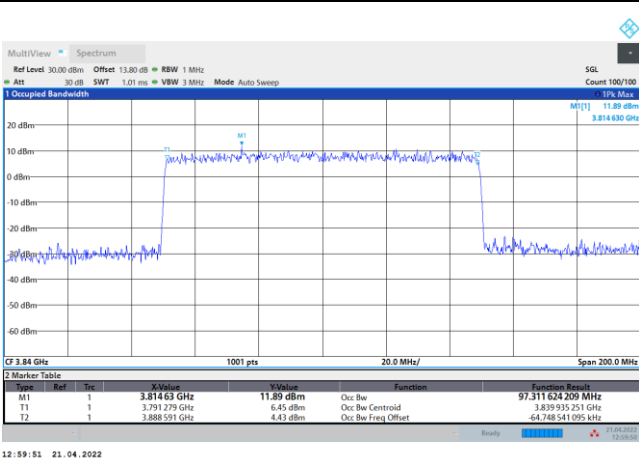

256QAM

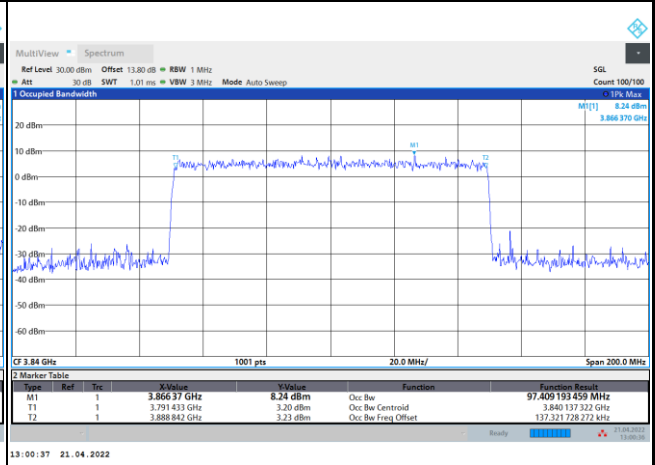



Conducted Band Edge

FR1 n77 / 20MHz / DFT-S OFDM / PI/2 BPSK

Lowest Band Edge / 1RB0

Highest Band Edge / 1RBmax

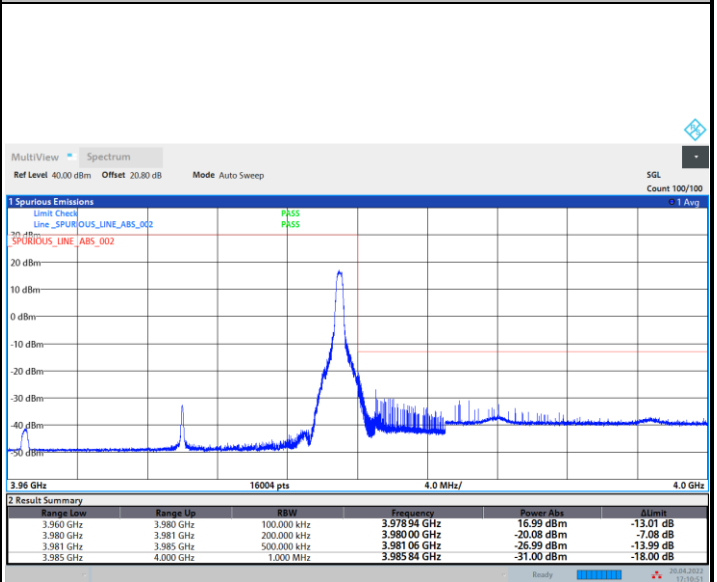
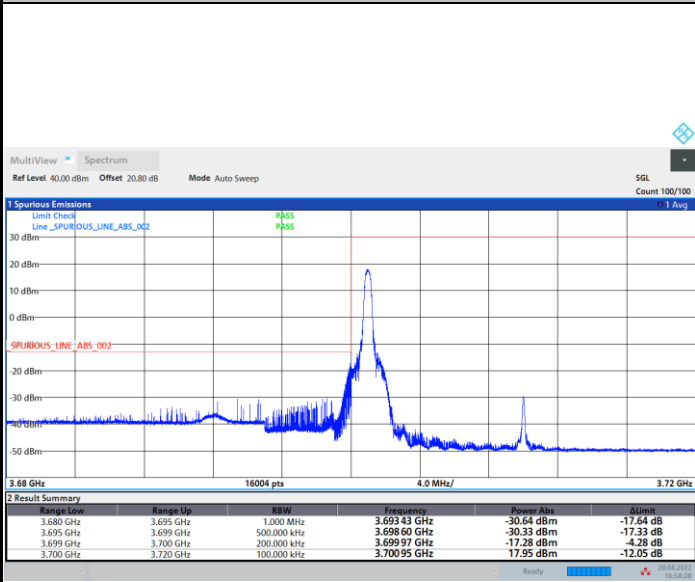

16:54:29 20.04.2022

17:10:51 20.04.2022

Lowest Band Edge / Full RB

Highest Band Edge / Full RB

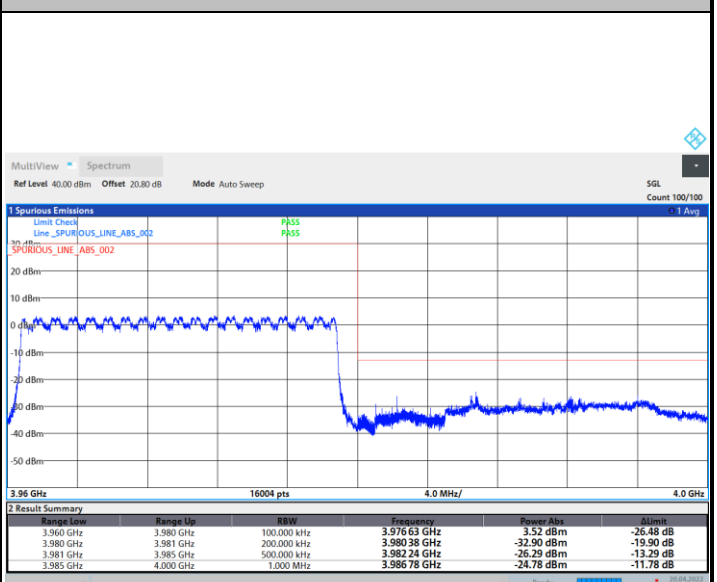
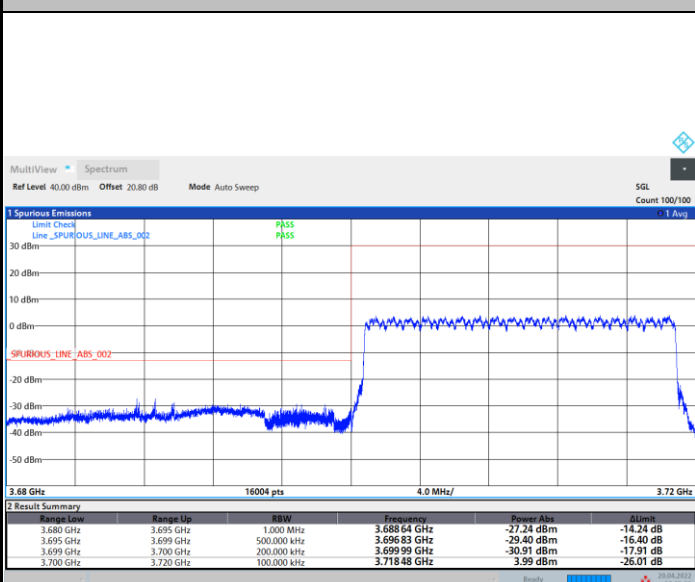

17:05:22 20.04.2022

17:09:22 20.04.2022



FR1 n77 / 20MHz / DFT-S OFDM / QPSK

Lowest Band Edge / 1RB0

Highest Band Edge / 1RBmax

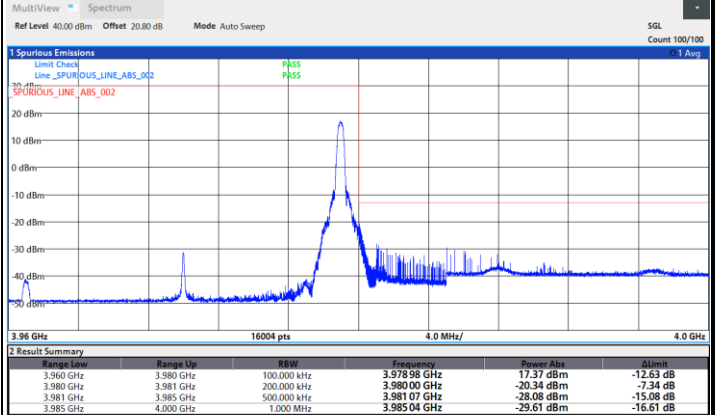
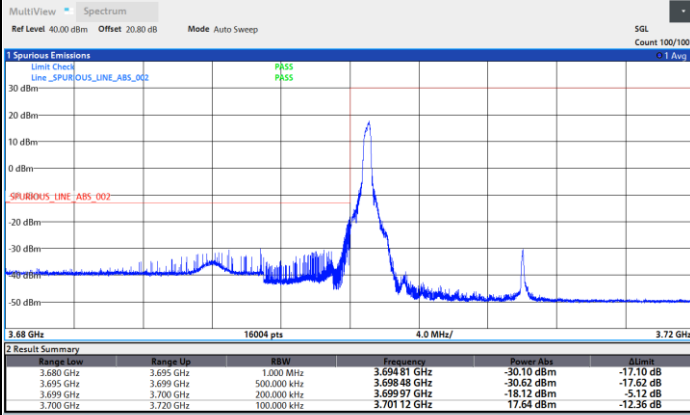

16:17:19 20.04.2022

17:11:33 20.04.2022

Lowest Band Edge / Full RB

Highest Band Edge / Full RB

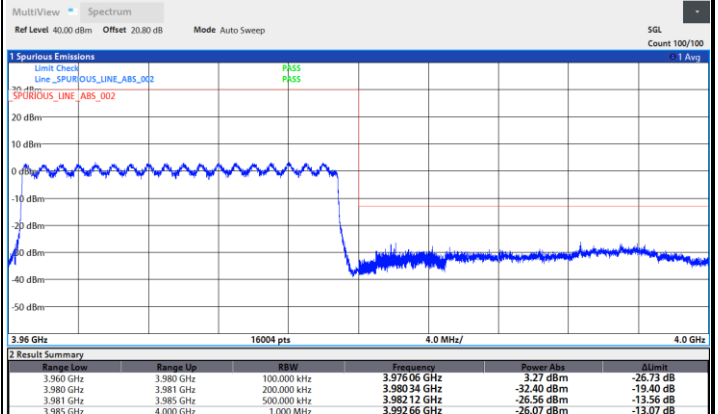
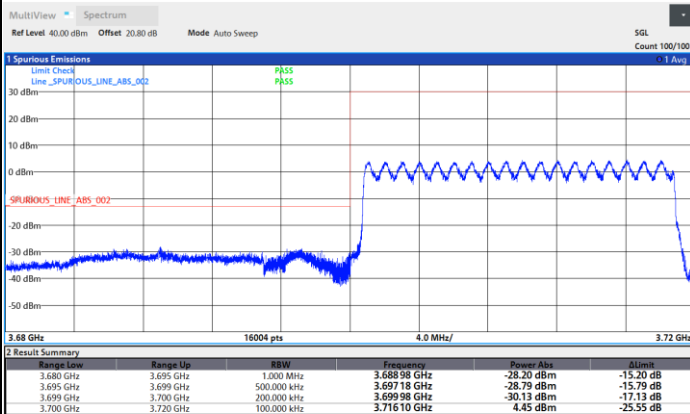

17:03:48 20.04.2022

17:28:11 20.04.2022



FR1 n77 / 20MHz / DFT-S OFDM / 16QAM

Lowest Band Edge / 1RB0

Highest Band Edge / 1RBmax

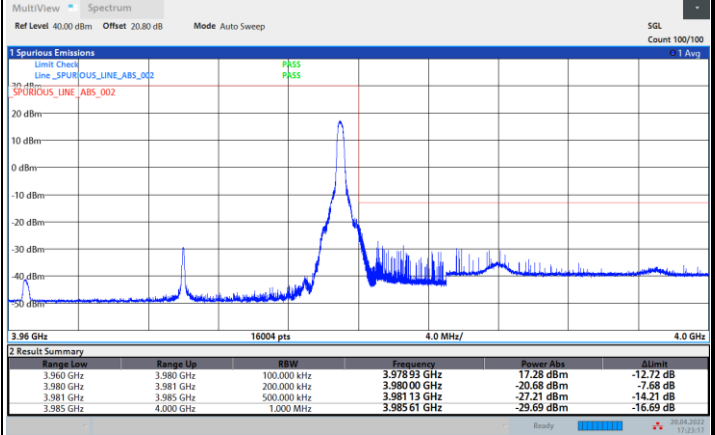
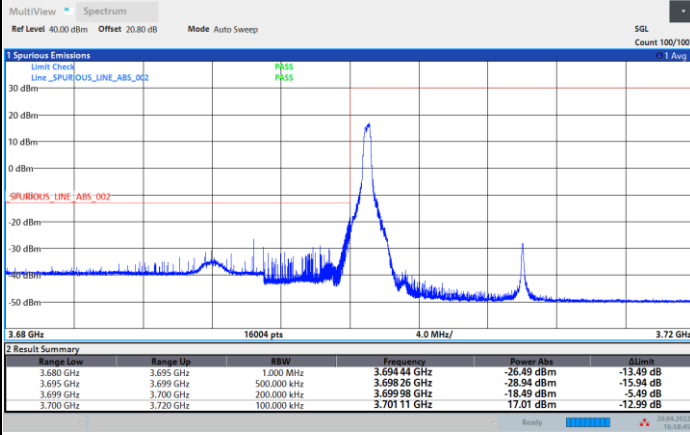

Lowest Band Edge / Full RB

Highest Band Edge / Full RB

