



FCC RADIO TEST REPORT

FCC ID : RI7FN980
Equipment : 5G/ LTE M.2 Data Card
Brand Name : Telit
Model Name : FN980
Marketing Name : FN980
Applicant : TELIT COMMUNICATIONS S.P.A.
VIA STAZIONE DI PROSECCO 5B -
SGONICO -TRIESTE - ITALY
Manufacturer : TELIT COMMUNICATIONS S.P.A.
VIA STAZIONE DI PROSECCO 5B -
SGONICO -TRIESTE - ITALY
Standard : FCC 47 CFR Part 2, 22(H), 24(E), 27

The product was received on Oct. 16, 2020. We, SPORTON INTERNATIONAL INC. EMC & Wireless Communications Laboratory, would like to declare that the tested sample has been evaluated in accordance with the test procedures given in ANSI / TIA-603-E and has been in compliance with the applicable technical standards.

The test results in this variant report apply exclusively to the tested model / sample. Without written approval of SPORTON INTERNATIONAL INC. EMC & Wireless Communications Laboratory, the test report shall not be reproduced except in full.

Louis Wu

Approved by: Louis Wu

SPORTON INTERNATIONAL INC. EMC & Wireless Communications Laboratory

No. 52, Huaya 1st Rd., Guishan Dist., Taoyuan City, Taiwan (R.O.C.)



Table of Contents

History of this test report.....	3
1 General Description	4
1.1 Product Feature of Equipment Under Test.....	4
1.2 Modification of EUT	4
Appendix A. Test Report	



History of this test report

Report No.	Version	Description	Issued Date
FG031715-02A	01	Initial issue of report	Oct. 26, 2020
FG031715-02A	02	Revise appendix A	Nov. 06, 2020
FG031715-02A	03	Revise appendix A	Nov. 09, 2020

Declaration of Conformity:
The test results with all measurement uncertainty excluded are presented in accordance with the regulation limits or requirements declared by manufacturers.

Comments and Explanations:
The declared of product specification for EUT presented in the report are provided by the manufacturer, and the manufacturer takes all the responsibilities for the accuracy of product specification.

Reviewed by: Wii Chang
Report Producer: Yimin Ho



1 General Description

1.1 Product Feature of Equipment Under Test

WCDMA/LTE/5G NR and GNSS.

Product Specification subjective to this standard	
Antenna Type	WWAN: <Ant. 0> Dipole Antenna <Ant. 1> Dipole Antenna <Ant. 2> Dipole Antenna <Ant. 3> Dipole Antenna GNSS : <1559 MHz ~ 1610 MHz>: <Ant. 3> Dipole Antenna <Ant. 4> Dipole Antenna <1164 MHz ~ 1215 MHz>: <Ant. 2> Dipole Antenna

Remark:

1. This is a variant report which can be referred Product Equality Declaration, All the test cases were performed on original report which can be referred to Sporton Report Number FG031715G.
2. The RF design is the electrically identical across all two models FN980 and FN980m except that FN980 does not support mmWave functions, please find the product equality letter as provided by manufacturer. The test has been performed with the selected model FN980m. Besides, the model FN980 has been verified consistency. Hence, the test data of FN980m can represent among all the two models in this test report. All the test cases were performed on test report which can be referred to Sporton Report Number FG031715-03A as Appendix A.

1.2 Modification of EUT

No modifications are made to the EUT during all test items.



Appendix A. Test Report

Please refer to Sporton report number FG031715-03A as below.



FCC RADIO TEST REPORT

FCC ID : RI7FN980M
Equipment : 5G/ LTE M.2 Data Card
Brand Name : Telit
Model Name : FN980m
Marketing Name : FN980m
Applicant : TELIT COMMUNICATIONS S.P.A.
VIA STAZIONE DI PROSECCO 5B -
SGONICO -TRIESTE - ITALY
Manufacturer : TELIT COMMUNICATIONS S.P.A.
VIA STAZIONE DI PROSECCO 5B -
SGONICO -TRIESTE - ITALY
Standard : FCC 47 CFR Part 2, 22(H), 24(E), 27

The product was received on Jul. 02, 2020 and testing was started from Aug. 10, 2020 and completed on Nov. 05, 2020. We, SPORTON INTERNATIONAL INC. EMC & Wireless Communications Laboratory, would like to declare that the tested sample has been evaluated in accordance with the test procedures given in ANSI / TIA-603-E and has been in compliance with the applicable technical standards.

The test results in this variant report apply exclusively to the tested model / sample. Without written approval of SPORTON INTERNATIONAL INC. EMC & Wireless Communications Laboratory, the test report shall not be reproduced except in full.

Louis Wu

Approved by: Louis Wu

SPORTON INTERNATIONAL INC. EMC & Wireless Communications Laboratory

No. 52, Huaya 1st Rd., Guishan Dist., Taoyuan City, Taiwan (R.O.C.)



Table of Contents

History of this test report.....	3
Summary of Test Result.....	4
1 General Description	6
1.1 Product Feature of Equipment Under Test.....	6
1.2 Modification of EUT	6
1.3 Testing Location	7
1.4 Applicable Standards.....	7
2 Test Configuration of Equipment Under Test	8
2.1 Test Mode.....	8
2.2 Connection Diagram of Test System.....	9
2.3 Support Unit used in test configuration and system	9
2.4 Measurement Results Explanation Example.....	9
2.5 Frequency List of Low/Middle/High Channels	10
3 Conducted Test Items.....	11
3.1 Measuring Instruments	11
3.2 Conducted Output Power and EIRP	12
3.3 Peak-to-Average Ratio	13
3.4 Occupied Bandwidth.....	14
3.5 Conducted Band Edge	15
3.6 Conducted Spurious Emission	16
3.7 Frequency Stability	17
4 Radiated Test Items	18
4.1 Measuring Instruments	18
4.2 Radiated Spurious Emission Measurement	20
5 List of Measuring Equipment.....	21
6 Uncertainty of Evaluation.....	22
Appendix A. Test Results of Conducted Test	
Appendix B. Test Results of EIRP and Radiated Test	
Appendix C. Test Setup Photographs	



History of this test report

Report No.	Version	Description	Issued Date
FG031715-03A	01	Initial issue of report	Oct. 23, 2020
FG031715-03A	02	Add test data	Nov. 06, 2020
FG031715-03A	03	Revise test data	Nov. 09, 2020



Summary of Test Result

Report Clause	Ref Std. Clause	Test Items	Result (PASS/FAIL)	Remark
3.2	§2.1046	Conducted Output Power	Reporting only	-
	§22.913 (a)(2)	Effective Radiated Power (n5)	Pass	
	§27.50 (c)(10)	Effective Radiated Power (n12) (n71)		
	§24.232 (c) §27.50 (h)(2)	Equivalent Isotropic Radiated Power (n2) (n25) (n7) (n41)		
	§27.50 (d)(4)	Equivalent Isotropic Radiated Power (n66)		
3.3	§24.232 (d) §27.50 (d)(5)	Peak-to-Average Ratio	Pass	-
3.4	§2.1049	Occupied Bandwidth	Reporting only	-
3.5	§2.1051 §22.917 (a) §24.238 (a) §27.53 (g) §27.53 (h)	Conducted Band Edge Measurement (n2) (n5) (n12) (n25) (n66) (n71)	Pass	-
	§2.1051 §27.53 (m)(4)	Conducted Band Edge Measurement (n7) (n41)		
3.6	§2.1051 §22.917 (a) §24.238 (a) §27.53 (g) §27.53 (h)	Conducted Spurious Emission (n2) (n5) (n12) (n25) (n66) (n71)	Pass	-
	§2.1051 §27.53 (m)(4)	Conducted Spurious Emission (n7) (n41)		
3.7	§2.1055 §22.355 §24.235 §27.54	Frequency Stability Temperature & Voltage	Pass	-



Report Clause	Ref Std. Clause	Test Items	Result (PASS/FAIL)	Remark
4.2	§2.1053 §22.917 (a) §24.238 (a) §27.53 (g) §27.53 (h)	Radiated Spurious Emission (n2) (n5) (n12) (n25) (n66) (n71)	Pass	Under limit 23.32 dB at 10368.000 MHz
	§2.1051 §27.53 (m)(4)	Radiated Spurious Emission (n7) (n41)		

Remark: This is a variant report which can be referred Product Equality Declaration. All the test cases were performed on original report which can be referred to Sporton Report Number FG031715-01C.

Declaration of Conformity:
The test results with all measurement uncertainty excluded are presented in accordance with the regulation limits or requirements declared by manufacturers.
Comments and Explanations:
The declared of product specification for EUT presented in the report are provided by the manufacturer, and the manufacturer takes all the responsibilities for the accuracy of product specification.

Reviewed by: Wii Chang

Report Producer: Cindy Liu



1 General Description

1.1 Product Feature of Equipment Under Test

WCDMA/LTE/5G NR and GNSS.

Product Specification subjective to this standard	
Antenna Type	WWAN: <Ant. 0> Dipole Antenna <Ant. 1> Dipole Antenna <Ant. 2> Dipole Antenna <Ant. 3> Dipole Antenna GNSS : <1559 MHz ~ 1610 MHz>: <Ant. 3> Dipole Antenna <Ant. 4> Dipole Antenna <1164 MHz ~ 1215 MHz>: <Ant. 2> Dipole Antenna

1.2 Modification of EUT

No modifications are made to the EUT during all test items.



1.3 Testing Location

Test Site	SPORTON INTERNATIONAL INC. EMC & Wireless Communications Laboratory	
Test Site Location	No.52, Huaya 1st Rd., Guishan Dist., Taoyuan City, Taiwan (R.O.C.) TEL: +886-3-327-3456 FAX: +886-3-328-4978	
Test Site No.	Sporton Site No.	
	TH05-HY	03CH07-HY
Test Engineer	Steve Chen	Stan Hsieh
Temperature	22.1~25.3°C	23~25°C
Relative Humidity	48.9~56.4%	50~56%

Note: The test site complies with ANSI C63.4 2014 requirement.

FCC Designation No.: TW1190

1.4 Applicable Standards

According to the specifications of the manufacturer, the EUT must comply with the requirements of the following standards:

- ♦ ANSI C63.26-2015
- ♦ ANSI / TIA-603-E
- ♦ FCC 47 CFR Part 2, 22(H), 24(E), 27
- ♦ FCC KDB 971168 D01 Power Meas. License Digital Systems v03r01
- ♦ FCC KDB 412172 D01 Determining ERP and EIRP v01r01
- ♦ FCC KDB 414788 D01 Radiated Test Site v01r01.

Remark:

1. All test items were verified and recorded according to the standards and without any deviation during the test.
2. This EUT has also been tested and complied with the requirements of FCC Part 15, Subpart B, recorded in a separate test report.
3. The TAF code is not including all the FCC KDB listed without accreditation.



2 Test Configuration of Equipment Under Test

2.1 Test Mode

Antenna port conducted and radiated test items listed below are performed according to KDB 971168 D01 Power Meas. License Digital Systems v03r01 with maximum output power.

For radiated measurement, pre-scanned in two setup, Ant. Horizontal and Ant. Vertical. The worst cases (Ant. Vertical for 5G NR n41) were recorded in this report.

Test Items	NR Band	Bandwidth (MHz)									Modulation					RB #			Test Channel			
		10	15	20	40	50	60	80	90	100	PI/2 BPSK	QPSK	16QAM	64QAM	256QAM	1	Half	Full	L	M	H	
Max. Output Power	n41			v	v	v	v	v	v	v	v	v	v	v	v	v	v	v	v	v	v	v
Peak-to-Average Ratio	n41			v							v	v	v	v	v			v		v		
26dB and 99% Bandwidth	n41			v	v	v	v	v	v	v	v	v	v	v	v			v		v		
Conducted Band Edge	n41			v	v	v	v	v	v	v	v	v	v	v	v	v		v	v		v	
Conducted Spurious Emission	n41			v	v	v	v	v	v	v		v				v				v	v	v
Frequency Stability	n41			v								v						v		v		
E.R.P / E.I.R.P	n41			v	v	v	v	v	v	v	v	v	v	v	v	v	v	v	v	v	v	v
Radiated Spurious Emission	n41	Worst Case																	v	v	v	
Remark	<ol style="list-style-type: none"> The mark "v" means that this configuration is chosen for testing The mark "-" means that this bandwidth is not supported. The device is investigated from 30MHz to 10 times of fundamental signal for radiated spurious emission test under different RB size/offset and modulations in exploratory test. Subsequently, only the worst case emissions are reported. Test combination is EN-DC 41A-n41, EN-DC 2A-n41, EN-DC 25A-n41, EN-DC 26A-n41, EN-DC 66A-n41 For radiated measurement, pre-scanned in two modes, DFT-s OFDM and CP OFDM. The worst cases (DFT-s OFDM) were recorded in this report. 																					

2.2 Connection Diagram of Test System

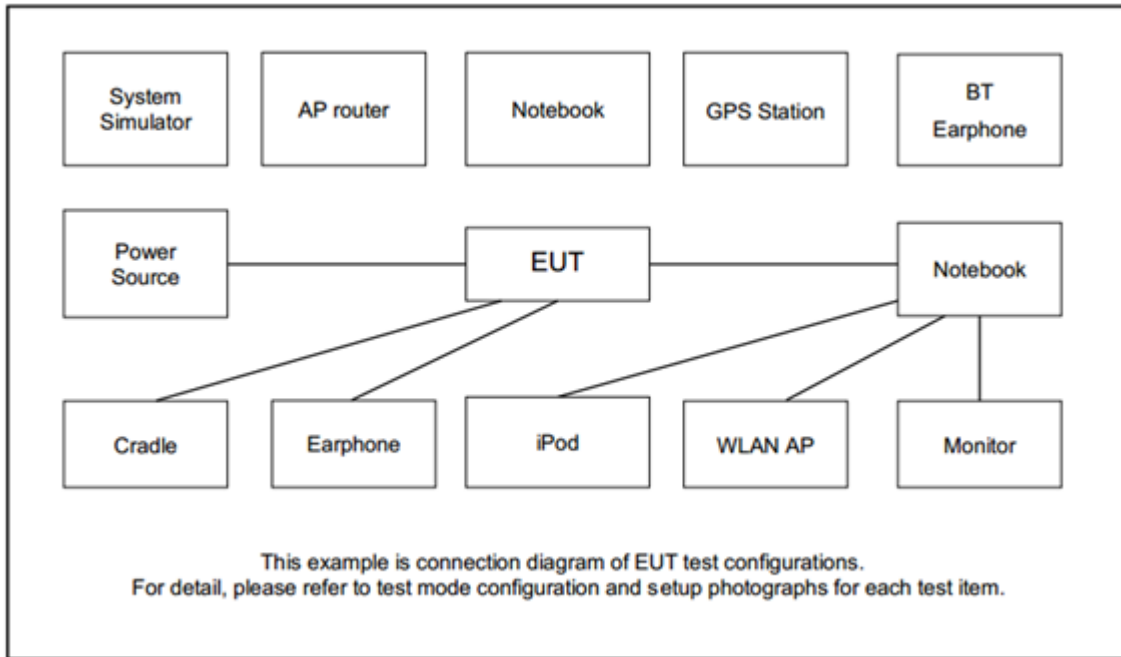

2.3 Support Unit used in test configuration and system

Item	Equipment	Brand Name	Model No.	FCC ID	Data Cable	Power Cord
1.	DC power Supply	Agilent	E3610A	N/A	N/A	Unshielded, 1.8 m
2.	System Simulator	Keysight	UXM 7515	N/A	N/A	Unshielded, 1.8 m

2.4 Measurement Results Explanation Example

For all conducted test items:

The offset level is set in the spectrum analyzer to compensate the RF cable loss and attenuator factor between EUT conducted output port and spectrum analyzer. With the offset compensation, the spectrum analyzer reading level is exactly the EUT RF output level.

The spectrum analyzer offset is derived from RF cable loss and attenuator factor.

Offset = RF cable loss + attenuator factor.

Following shows an offset computation example with cable loss 4.2 dB and 10dB attenuator.

Example :

$$\begin{aligned} \text{Offset(dB)} &= \text{RF cable loss(dB)} + \text{attenuator factor(dB)}. \\ &= 4.2 + 10 = 14.2 \text{ (dB)} \end{aligned}$$



2.5 Frequency List of Low/Middle/High Channels

5G NR Band n41 Channel and Frequency List				
BW [MHz]	Channel/Frequency(MHz)	Lowest	Middle	Highest
100	Channel	509202	518598	528000
	Frequency	2546.01	2592.99	2640
90	Channel	508200	518598	528996
	Frequency	2541	2592.99	2644.98
80	Channel	507204	518598	529998
	Frequency	2536.02	2592.99	2649.99
60	Channel	505200	518598	531996
	Frequency	2526	2592.99	2659.98
50	Channel	504204	518598	532998
	Frequency	2521.02	2592.99	2664.99
40	Channel	503202	518598	534000
	Frequency	2516.01	2592.99	2670
20	Channel	501204	518598	535998
	Frequency	2506.02	2592.99	2679.99

3 Conducted Test Items

3.1 Measuring Instruments

See list of measuring instruments of this test report.

3.1.1 Test Setup

3.1.2 Conducted Output Power

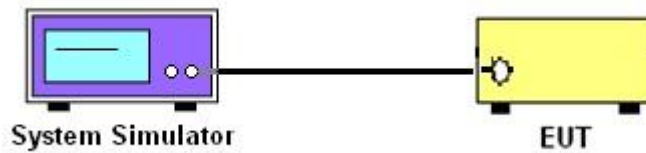

3.1.3 Peak-to-Average Ratio, Occupied Bandwidth ,Conducted Band-Edge and Conducted Spurious Emission

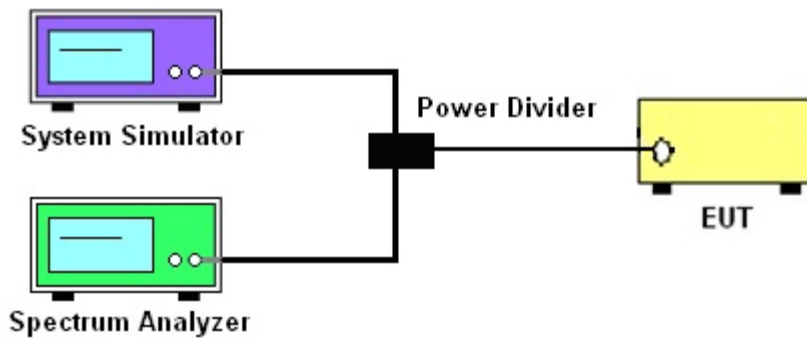

3.1.4 Frequency Stability

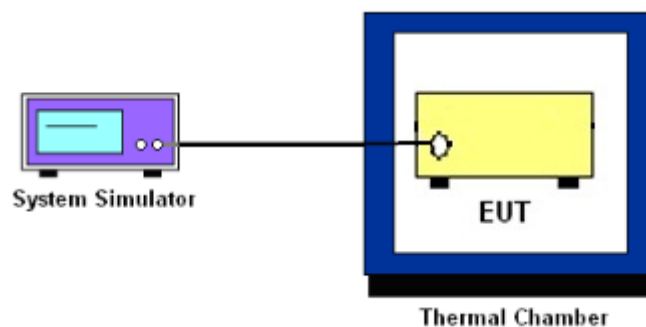

3.1.5 Test Result of Conducted Test

Please refer to Appendix A.



3.2 Conducted Output Power and EIRP

3.2.1 Description of the Conducted Output Power Measurement and EIRP Measurement

A system simulator was used to establish communication with the EUT. Its parameters were set to force the EUT transmitting at maximum output power. The measured power in the radio frequency on the transmitter output terminals shall be reported.

Test Mode The EIRP of mobile transmitters must not exceed 2 Watts for 5G NR and n41

According to KDB 412172 D01 Power Approach,

$EIRP = P_T + G_T - L_C$, $ERP = EIRP - 2.15$, where

P_T = transmitter output power in dBm

G_T = gain of the transmitting antenna in dBi

L_C = signal attenuation in the connecting cable between the transmitter and antenna in dB

3.2.2 Test Procedures

1. The transmitter output port was connected to the system simulator.
2. Set EUT at maximum power through the system simulator.
3. Select lowest, middle, and highest channels for each band and different modulation.
4. Measure and record the power level from the system simulator.



3.3 Peak-to-Average Ratio

3.3.1 Description of the PAR Measurement

Power Complementary Cumulative Distribution Function (CCDF) curves provide a means for characterizing the power peaks of a digitally modulated signal on a statistical basis. A CCDF curve depicts the probability of the peak signal amplitude exceeding the average power level. Most contemporary measurement instrumentation include the capability to produce CCDF curves for an input signal provided that the instrument's resolution bandwidth can be set wide enough to accommodate the entire input signal bandwidth. In measuring transmissions in this band using an average power technique, the peak-to-average ratio (PAR) of the transmission may not exceed 13 dB.

3.3.2 Test Procedures

The testing follows ANSI C63.26-2015 Section 5.2.6

1. The EUT was connected to spectrum and system simulator via a power divider.
2. Set the CCDF (Complementary Cumulative Distribution Function) option in spectrum analyzer.
3. The highest RF powers were measured and recorded the maximum PAPR level associated with a probability of 0.1 %.
4. Record the deviation as Peak to Average Ratio.



3.4 Occupied Bandwidth

3.4.1 Description of Occupied Bandwidth Measurement

The occupied bandwidth is the width of a frequency band such that, below the lower and above the upper frequency limits, the mean powers emitted are each equal to a specified percentage 0.5% of the total mean transmitted power.

The 26 dB emission bandwidth is defined as the frequency range between two points, one above and one below the carrier frequency, at which the spectral density of the emission is attenuated 26 dB below the maximum in-band spectral density of the modulated signal. Spectral density (power per unit bandwidth) is to be measured with a detector of resolution bandwidth equal to approximately 1.0% of the emission bandwidth.

3.4.2 Test Procedures

The testing follows ANSI C63.26-2015 Section 5.4.3 (26dB) and Section 5.4.4 (99OB)

1. The EUT was connected to spectrum analyzer and system simulator via a power divider.
2. The spectrum analyzer center frequency is set to the nominal EUT channel center frequency. The span range for the spectrum analyzer shall be between two and five times the anticipated OBW.
3. The nominal resolution bandwidth (RBW) shall be in the range of 1 to 5 % of the anticipated OBW, and the VBW shall be at least 3 times the RBW.
4. Set the detection mode to peak, and the trace mode to max hold.
5. Determine the reference value: Set the EUT to transmit a modulated signal. Allow the trace to stabilize. Set the spectrum analyzer marker to the highest level of the displayed trace.
(this is the reference value)
6. Determine the “-26 dB down amplitude” as equal to (Reference Value – X).
7. Place two markers, one at the lowest and the other at the highest frequency of the envelope of the spectral display such that each marker is at or slightly below the “-X dB down amplitude” determined in step 6. If a marker is below this “-X dB down amplitude” value it shall be placed as close as possible to this value. The OBW is the positive frequency difference between the two markers.
8. Use the 99 % power bandwidth function of the spectrum analyzer and report the measured bandwidth.



3.5 Conducted Band Edge

3.5.1 Description of Conducted Band Edge Measurement

27.53(m)(4)

For mobile digital stations, the attenuation factor shall be not less than $40 + 10 \log (P)$ dB on all frequencies between the channel edge and 5 megahertz from the channel edge, $43 + 10 \log (P)$ dB on all frequencies between 5 megahertz and X megahertz from the channel edge, and $55 + 10 \log (P)$ dB on all frequencies more than X megahertz from the channel edge, where X is the greater of 6 megahertz or the actual emission bandwidth as defined in paragraph (m)(6) of this section. In addition, the attenuation factor shall not be less that $43 + 10 \log (P)$ dB on all frequencies between 2490.5 MHz and 2496 MHz and $55 + 10 \log (P)$ dB at or below 2490.5 MHz. Mobile Satellite Service licensees operating on frequencies below 2495 MHz may also submit a documented interference complaint against BRS licensees operating on channel BRS Channel 1 on the same terms and conditions as adjacent channel BRS or EBS licensees.

3.5.2 Test Procedures

The testing follows FCC KDB 971168 D01 v03r01 Section 6.1.

1. The EUT was connected to spectrum analyzer and system simulator via a power divider.
2. The band edges of low and high channels for the highest RF powers were measured.
3. Set RBW \geq 1% EBW in the 1MHz band immediately outside and adjacent to the band edge.
4. Beyond the 1 MHz band from the band edge, RBW=1MHz was used.
5. Set spectrum analyzer with RMS detector.
6. The RF fundamental frequency should be excluded against the limit line in the operating frequency band.
7. Checked that all the results comply with the emission limit line.

The limit line is derived from $43 + 10\log(P)$ dB below the transmitter power P(Watts)

For 5G NR n41

The other 40 dB, and 55 dB have additionally applied same calculation above.



3.6 Conducted Spurious Emission

3.6.1 Description of Conducted Spurious Emission Measurement

The power of any emission outside of the authorized operating frequency ranges must be lower than the transmitter power (P) by a factor of at least $43 + 10 \log (P)$ dB.

For 5G NR n41

The power of any emission outside of the authorized operating frequency ranges must be lower than the transmitter power (P) by a factor of at least $55 + 10 \log (P)$ dB.

It is measured by means of a calibrated spectrum analyzer and scanned from 30 MHz up to a frequency including its 10th harmonic.

3.6.2 Test Procedures

The testing follows FCC KDB 971168 D01 v03r01 Section 6.1.

1. The EUT was connected to spectrum analyzer and system simulator via a power divider.
2. The RF output of EUT was connected to the spectrum analyzer by RF cable and attenuator.
The path loss was compensated to the results for each measurement.
3. The middle channel for the highest RF power within the transmitting frequency was measured.
4. The conducted spurious emission for the whole frequency range was taken.
5. Make the measurement with the spectrum analyzer's RBW = 1MHz, VBW = 3MHz.
6. Set spectrum analyzer with RMS detector.
7. Taking the record of maximum spurious emission.
8. The RF fundamental frequency should be excluded against the limit line in the operating frequency band.
9. The limit line is derived from $43 + 10\log(P)$ dB below the transmitter power P(Watts)
For 5G NR n41
The limit line is derived from $55 + 10\log(P)$ dB below the transmitter power P(Watts)



3.7 Frequency Stability

3.7.1 Description of Frequency Stability Measurement

27.54

The frequency stability shall be sufficient to ensure that the fundamental emission stays within the authorized frequency block.

3.7.2 Test Procedures for Temperature Variation

The testing follows FCC KDB 971168 D01 v03r01 Section 9.0.

1. The EUT was set up in the thermal chamber and connected with the system simulator.
2. With power OFF, the temperature was decreased to -30°C and the EUT was stabilized before testing. Power was applied and the maximum change in frequency was recorded within one minute.
3. With power OFF, the temperature was raised in 10°C step up to 50°C . The EUT was stabilized at each step for at least half an hour. Power was applied and the maximum frequency change was recorded within one minute.

3.7.3 Test Procedures for Voltage Variation

The testing follows FCC KDB 971168 D01 v03r01 Section 9.0.

1. The EUT was placed in a temperature chamber at $20\pm 5^{\circ}\text{C}$ and connected with the system simulator.
2. The power supply voltage to the EUT was varied from 85% to 115% of the nominal value measured at the input to the EUT.
3. The variation in frequency was measured for the worst case.

4 Radiated Test Items

4.1 Measuring Instruments

See list of measuring instruments of this test report.

4.1.1 Test Setup

For radiated emissions below 30MHz

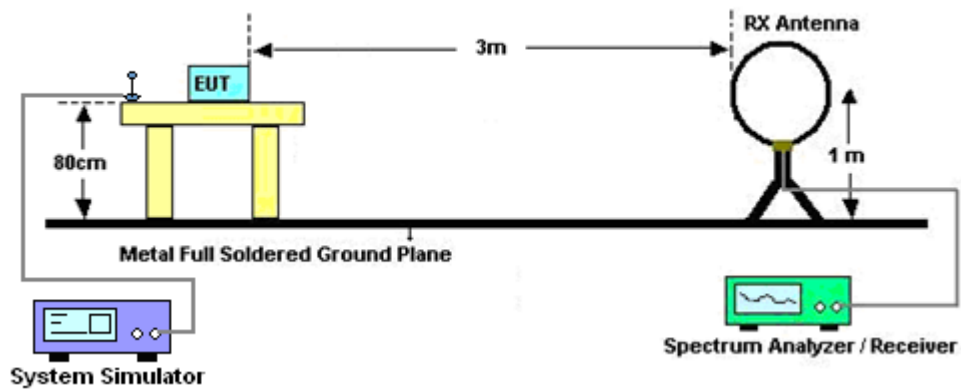

For radiated test from 30MHz to 1GHz

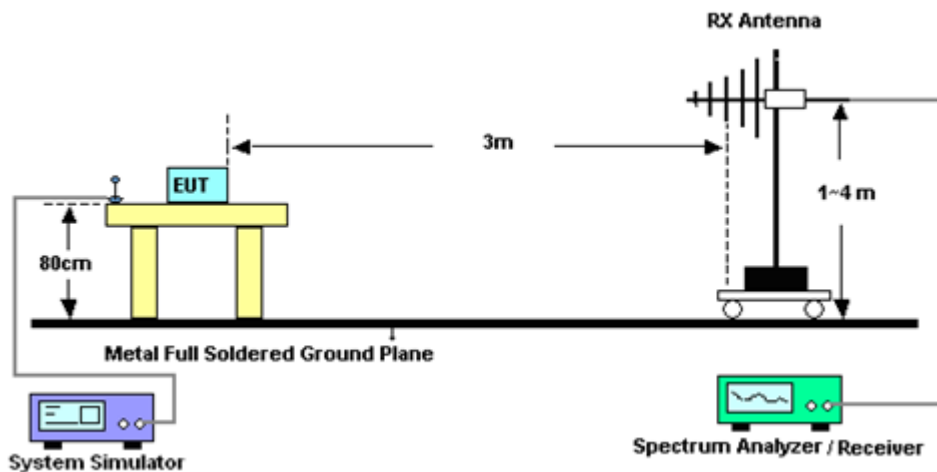

For radiated test above 1GHz

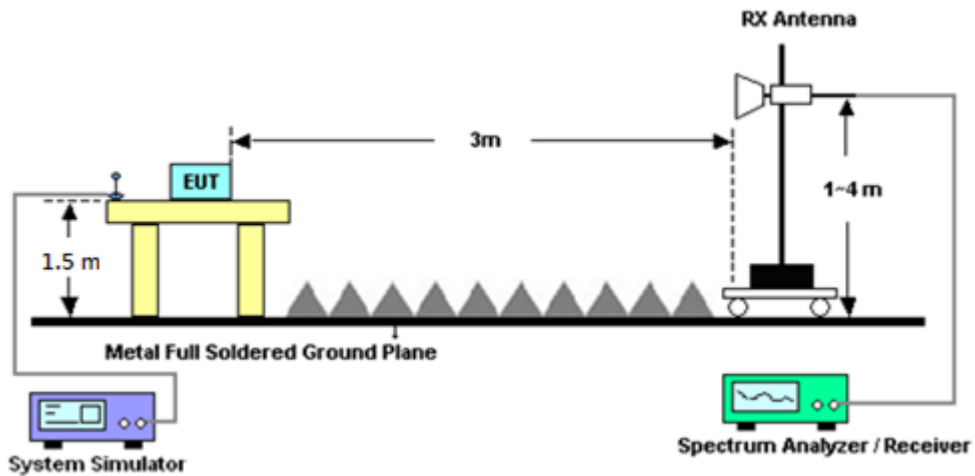

4.1.2 Test Result of Radiated Test

Please refer to Appendix B.

Note:

The low frequency, which started from 9 kHz to 30MHz, was pre-scanned and the result which was 20dB lower than the limit line was not reported.

There is a comparison data of both open-field test site and alternative test site - semi-Anechoic chamber according to 414788 D01 Radiated Test Site v01r01, and the result came out very similar.



4.2 Radiated Spurious Emission Measurement

4.2.1 Description of Radiated Spurious Emission Measurement

The radiated spurious emission was measured by substitution method according to ANSI / TIA-603-E. The power of any emission outside of the authorized operating frequency ranges must be attenuated below the transmitter power (P) by a factor of at least $43 + 10 \log (P)$ dB.

For 5G NR n41

The power of any emission outside of the authorized operating frequency ranges must be attenuated below the transmitter power (P) by a factor of at least $55 + 10 \log (P)$ dB.

The spectrum is scanned from 30 MHz up to a frequency including its 10th harmonic.

4.2.2 Test Procedures

The testing follows FCC KDB 971168 D01 v03r01 Section 7 and ANSI / TIA-603-E Section 2.2.12.

1. The EUT was placed on a turntable with 0.8 meter for frequency below 1GHz and 1.5 meter for frequency above 1GHz respectively above ground.
2. The EUT was set 3 meters from the receiving antenna, which was mounted on the antenna tower.
3. The table was rotated 360 degrees to determine the position of the highest spurious emission.
4. The height of the receiving antenna is varied between one meter and four meters to search the maximum spurious emission for both horizontal and vertical polarizations.
5. Make the measurement with the spectrum analyzer's RBW = 1MHz, VBW = 3MHz, taking the record of maximum spurious emission.
6. A horn antenna was substituted in place of the EUT and was driven by a signal generator.
7. Tune the output power of signal generator to the same emission level with EUT maximum spurious emission.
8. Taking the record of output power at antenna port.
9. Repeat step 7 to step 8 for another polarization.
10. The RF fundamental frequency should be excluded against the limit line in the operating frequency band.

The limit line is derived from $43 + 10\log(P)$ dB below the transmitter power P(Watts)

For 5G NR n41

The limit line is derived from $55 + 10\log(P)$ dB below the transmitter power P(Watts)

EIRP (dBm) = S.G. Power – Tx Cable Loss + Tx Antenna Gain

ERP (dBm) = EIRP - 2.15



5 List of Measuring Equipment

Instrument	Brand Name	Model No.	Serial No.	Characteristics	Calibration Date	Test Date	Due Date	Remark
DC Power Supply	GW Instek	GPE-2323	GEU810968	Voltage:0V~64V ;Current: 0A~6A	Jul. 30, 2020	Aug. 10, 2020~ Nov. 05, 2020	Jul. 29, 2021	Conducted (TH05-HY)
Spectrum Analyzer	Rohde & Schwarz	FSV40	101907	10Hz~40GHz	May 05, 2020	Aug. 10, 2020~ Nov. 05, 2020	May 04, 2021	Conducted (TH05-HY)
Temperature Chamber	ESPEC	SU-241	92003713	-30℃ ~95℃	May 14, 2020	Aug. 10, 2020~ Nov. 05, 2020	May 13, 2021	Conducted (TH05-HY)
5G Wireless Test Platform	Keysight	E7515B	MY59321826	FR1 + FR2	Feb. 14, 2020	Aug. 10, 2020~ Nov. 05, 2020	Feb. 13, 2021	Conducted (TH05-HY)
Bilog Antenna	TESEQ	CBL 6111D & 00800N1D01N -06	35419 & 03	30MHz~1GHz	Apr. 29, 2020	Aug. 18, 2020	Apr. 28, 2021	Radiation (03CH07-HY)
Double Ridge Horn Antenna	ESCO	3117	00075962	1GHz ~ 18GHz	Dec. 06, 2019	Aug. 18, 2020	Dec. 05, 2020	Radiation (03CH07-HY)
EMI Test Receiver	Agilent	N9038A(MXE)	MY53290053	20Hz~26.5GHz	May 21, 2020	Aug. 18, 2020	May 20, 2021	Radiation (03CH07-HY)
Preamplifier	COM-POWER	PA-103A	161241	10MHz~1GHz	May 19, 2020	Aug. 18, 2020	May 18, 2021	Radiation (03CH07-HY)
Preamplifier	Agilent	8449B	3008A02362	1GHz~26.5GHz	Nov. 01, 2019	Aug. 18, 2020	Oct. 31, 2020	Radiation (03CH07-HY)
RF Cable	HUBER + SUHNER	SUCOFLEX 102	MY2858/2,80 1606/2	18GHz~40GHz	Feb. 25, 2020	Aug. 18, 2020	Feb. 24, 2021	Radiation (03CH07-HY)
RF Cable	HUBER + SUHNER	SUCOFLEX 104	MY28655/4, MY24971/4, MY15682/4	30MHz~1GHz	Feb. 25, 2020	Aug. 18, 2020	Feb. 24, 2021	Radiation (03CH07-HY)
RF Cable	HUBER + SUHNER	SUCOFLEX 104	MY28655/4, MY24971/4, MY15682/4	1GHz~18GHz	Feb. 25, 2020	Aug. 18, 2020	Feb. 24, 2021	Radiation (03CH07-HY)
Controller	ChainTek	Chaintek 3000	N/A	Control Turn table	N/A	Aug. 18, 2020	N/A	Radiation (03CH07-HY)
Controller	Max-Full	MF7802	MF78020836 8	Control Ant Mast	N/A	Aug. 18, 2020	N/A	Radiation (03CH07-HY)
Antenna Mast	Max-Full	MFA520BS	N/A	1m~4m	N/A	Aug. 18, 2020	N/A	Radiation (03CH07-HY)
Turn Table	ChainTek	Chaintek 3000	N/A	0~360 Degree	N/A	Aug. 18, 2020	N/A	Radiation (03CH07-HY)
USB Data Logger	TECPEL	TR-32	HE17XB2495	N/A	N/A	Aug. 18, 2020	N/A	Radiation (03CH07-HY)
Spectrum Analyzer	Keysight	N9010A	MY54200485	10Hz~44GHz	Feb. 10, 2020	Aug. 18, 2020	Feb. 09, 2021	Radiation (03CH07-HY)
Horn Antenna	EMCO	3117	00143261	1GHz~18GHz	Jan. 10, 2020	Aug. 18, 2020	Jan. 09, 2021	Radiation (03CH07-HY)
SHF-EHF Horn Antenna	SCHWARZBE CK	BBHA 9170	BBHA917025 1	18GHz~40GHz	Nov. 26, 2019	Aug. 18, 2020	Nov. 25, 2020	Radiation (03CH07-HY)
Preamplifier	EMEC	EM18G40G	060801	18GHz~40GHz	N/A	Aug. 18, 2020	N/A	Radiation (03CH07-HY)
Software	Audix	E3 6.2009-8-24	N/A	N/A	N/A	Aug. 18, 2020	N/A	Radiation (03CH07-HY)
Signal Generator	Rohde & Schwarz	SMF100A	101107	100kHz~40GHz	Aug. 27, 2019	Aug. 18, 2020	Aug. 26, 2020	Radiation (03CH07-HY)



6 Uncertainty of Evaluation

Uncertainty of Radiated Emission Measurement (30 MHz ~ 1000 MHz)

Measuring Uncertainty for a Level of Confidence of 95% ($U = 2Uc(y)$)	3.35
---	------

Uncertainty of Radiated Emission Measurement (1 GHz ~ 18 GHz)

Measuring Uncertainty for a Level of Confidence of 95% ($U = 2Uc(y)$)	3.81
---	------

Uncertainty of Radiated Emission Measurement (18 GHz ~ 40 GHz)

Measuring Uncertainty for a Level of Confidence of 95% ($U = 2Uc(y)$)	4.85
---	------



Appendix A. Test Results of Conducted Test

<DFT-s-OFDM>

Conducted Output Power(Average power)

LTE Band 41 Maximum Average Power [dBm]				
BW [MHz]	RB Size	RB Offset	Mod	Middle
10	50	0	QPSK	20.42

BW [MHz]	Mod	EN-DC 41A-n41A Maximum Average Power [dBm]
20	QPSK	26.20
20	QAM	25.20
40	QPSK	26.13
40	QAM	25.28
50	QPSK	26.39
50	QAM	25.69
60	QPSK	26.45
60	QAM	25.52
80	QPSK	26.32
80	QAM	25.51
90	QPSK	26.18
90	QAM	25.59
100	QPSK	26.14
100	QAM	25.53

Remark: This EUT supports EN - DC and the LTE is anchor for simultaneous transmission, and only maximum combined power is reported.

NR n41(HPUE) Maximum Average Power [dBm]						
BW [MHz]	RB Size	RB Offset	Mod	Lowest	Middle	Highest
20	1	1	PI/2 BPSK	23.51	23.58	23.88
20	1	49		23.58	23.75	23.72
20	25	12		24.63	24.07	24.50
20	1	0		21.12	22.19	21.67
20	1	50		21.35	22.10	21.66
20	50	0		23.84	23.45	23.87
20	1	1	QPSK	24.62	24.43	24.10
20	1	49		24.87	24.46	23.84
20	25	12		24.60	24.60	24.55
20	1	0		21.11	22.22	21.65
20	1	50		21.41	22.13	21.69
20	50	0		23.75	23.40	23.64
20	1	1	16-QAM	23.35	23.45	23.13
20	1	1	64-QAM	22.30	22.95	22.59
20	1	1	256-QAM	19.79	20.82	20.30



NR n41(HPUE) Maximum Average Power [dBm]						
BW [MHz]	RB Size	RB Offset	Mod	Lowest	Middle	Highest
40	1	1	PI/2 BPSK	22.43	22.71	23.39
40	1	104		22.19	23.04	22.52
40	50	25		23.79	24.29	24.77
40	1	0		21.06	22.10	21.95
40	1	105		21.66	22.19	21.74
40	100	0		22.95	23.33	23.35
40	1	1	QPSK	24.52	24.23	24.43
40	1	104		24.20	24.15	23.63
40	50	25		24.19	24.46	24.72
40	1	0		21.08	22.12	21.96
40	1	105		21.64	22.20	21.79
40	100	0		22.86	23.46	23.63
40	1	1	16-QAM	23.57	23.29	23.49
40	1	1	64-QAM	22.11	22.80	22.79
40	1	1	256-QAM	19.84	20.36	20.35

NR n41(HPUE) Maximum Average Power [dBm]						
BW [MHz]	RB Size	RB Offset	Mod	Lowest	Middle	Highest
50	1	1	PI/2 BPSK	24.59	23.86	24.42
50	1	131		24.21	23.69	23.97
50	64	32		24.32	24.30	24.71
50	1	0		21.17	22.29	22.04
50	1	132		21.92	22.14	21.75
50	128	0		24.23	23.80	24.31
50	1	1	QPSK	24.67	24.38	25.01
50	1	131		25.12	24.49	24.48
50	64	32		24.23	24.23	24.63
50	1	0		21.14	22.33	22.00
50	1	132		21.88	22.19	21.76
50	128	0		23.74	23.67	23.91
50	1	1	16-QAM	23.61	24.16	24.03
50	1	1	64-QAM	22.17	23.21	22.94
50	1	1	256-QAM	19.68	20.84	20.59



NR n41(HPUE) Maximum Average Power [dBm]						
BW [MHz]	RB Size	RB Offset	Mod	Lowest	Middle	Highest
60	1	1	PI/2 BPSK	24.57	23.63	23.39
60	1	160		24.36	23.45	22.93
60	81	40		24.23	24.22	24.82
60	1	0		21.04	22.10	21.90
60	1	161		22.03	21.97	21.66
60	162	0		24.34	23.85	23.67
60	1	1	QPSK	24.60	24.92	24.51
60	1	160		25.20	24.24	24.24
60	81	40		24.23	24.28	24.58
60	1	0		21.09	22.13	21.88
60	1	161		22.04	21.96	21.67
60	162	0		23.95	23.63	23.64
60	1	1	16-QAM	23.53	23.92	23.55
60	1	1	64-QAM	22.04	22.85	22.52
60	1	1	256-QAM	19.66	20.66	20.50

NR n41(HPUE) Maximum Average Power [dBm]						
BW [MHz]	RB Size	RB Offset	Mod	Lowest	Middle	Highest
80	1	1	PI/2 BPSK	24.78	23.68	23.85
80	1	215		24.29	23.70	23.58
80	108	54		24.36	24.31	24.51
80	1	0		21.26	22.48	22.22
80	1	216		22.06	21.99	21.81
80	216	0		24.40	23.88	24.22
80	1	1	QPSK	24.79	24.91	24.33
80	1	215		25.03	24.61	24.13
80	108	54		24.38	24.14	24.37
80	1	0		21.23	22.48	22.19
80	1	216		22.04	21.98	21.77
80	216	0		23.71	23.70	23.41
80	1	1	16-QAM	23.76	23.90	23.32
80	1	1	64-QAM	22.23	22.79	22.28
80	1	1	256-QAM	19.91	20.90	20.57



NR n41(HPUE) Maximum Average Power [dBm]						
BW [MHz]	RB Size	RB Offset	Mod	Lowest	Middle	Highest
90	1	1	PI/2 BPSK	24.40	23.54	23.90
90	1	243		24.09	23.89	23.42
90	120	60		24.54	24.21	24.32
90	1	0		21.21	22.39	22.20
90	1	244		22.16	21.97	21.80
90	240	0		24.33	24.61	23.26
90	1	1	QPSK	24.84	24.59	24.39
90	1	243		24.80	24.69	24.04
90	120	60		24.50	24.14	24.22
90	1	0		21.25	22.40	22.23
90	1	244		22.15	21.94	21.80
90	240	0		24.12	23.46	23.62
90	1	1	16-QAM	24.02	23.56	23.40
90	1	1	64-QAM	22.38	22.14	22.01
90	1	1	256-QAM	19.97	20.10	20.11

NR n41(HPUE) Maximum Average Power [dBm]						
BW [MHz]	RB Size	RB Offset	Mod	Lowest	Middle	Highest
100	1	1	PI/2 BPSK	24.61	23.53	24.05
100	1	271		23.96	23.98	23.66
100	135	67		24.55	23.97	24.28
100	1	0		21.04	22.40	22.06
100	1	272		22.06	22.03	21.69
100	270	0		24.29	24.11	24.21
100	1	1	QPSK	24.75	24.47	24.36
100	1	271		24.57	24.78	23.97
100	135	67		24.58	24.18	24.04
100	1	0		21.08	22.45	22.10
100	1	272		22.03	21.99	21.66
100	270	0		23.80	23.10	23.52
100	1	1	16-QAM	23.93	23.44	23.36
100	1	1	64-QAM	22.26	21.87	21.96
100	1	1	256-QAM	20.01	20.44	20.62



<CP-OFDM>

LTE Band 41 Maximum Average Power [dBm]				
BW [MHz]	RB Size	RB Offset	Mod	Middle
10	50	0	QPSK	20.42

EN-DC 41A-n41A Maximum Average Power [dBm]	
25.39	

Remark:

This EUT supports EN - DC and the LTE is anchor for simultaneous transmission, and only maximum combined power is reported.

NR n41(HPUE) Maximum Average Power [dBm]						
BW [MHz]	RB Size	RB Offset	Mod	Lowest	Middle	Highest
20	1	1	QPSK	23.29	22.96	22.15
20	1	1	16-QAM	22.40	22.62	22.30
20	1	1	64-QAM	21.31	21.69	21.39
20	1	1	256-QAM	18.29	19.23	18.83

NR n41(HPUE) Maximum Average Power [dBm]						
BW [MHz]	RB Size	RB Offset	Mod	Lowest	Middle	Highest
40	1	1	QPSK	23.19	22.70	22.89
40	1	1	16-QAM	22.62	22.25	22.55
40	1	1	64-QAM	21.02	21.25	21.69
40	1	1	256-QAM	18.25	19.24	19.01

NR n41(HPUE) Maximum Average Power [dBm]						
BW [MHz]	RB Size	RB Offset	Mod	Lowest	Middle	Highest
50	1	1	QPSK	23.25	23.72	23.52
50	1	1	16-QAM	22.74	23.35	23.23
50	1	1	64-QAM	21.32	22.35	22.13
50	1	1	256-QAM	18.27	19.34	18.97



NR n41(HPUE) Maximum Average Power [dBm]						
BW [MHz]	RB Size	RB Offset	Mod	Lowest	Middle	Highest
60	1	1	QPSK	23.22	23.46	23.01
60	1	1	16-QAM	22.54	23.07	22.71
60	1	1	64-QAM	21.05	22.19	21.81
60	1	1	256-QAM	18.21	19.05	18.84

NR n41(HPUE) Maximum Average Power [dBm]						
BW [MHz]	RB Size	RB Offset	Mod	Lowest	Middle	Highest
80	1	1	QPSK	23.38	23.43	22.83
80	1	1	16-QAM	22.86	23.04	22.50
80	1	1	64-QAM	21.36	22.15	21.56
80	1	1	256-QAM	18.45	19.48	19.15

NR n41(HPUE) Maximum Average Power [dBm]						
BW [MHz]	RB Size	RB Offset	Mod	Lowest	Middle	Highest
90	1	1	QPSK	23.44	23.12	22.89
90	1	1	16-QAM	22.80	22.68	22.53
90	1	1	64-QAM	21.29	21.60	21.50
90	1	1	256-QAM	18.60	19.43	19.32

NR n41(HPUE) Maximum Average Power [dBm]						
BW [MHz]	RB Size	RB Offset	Mod	Lowest	Middle	Highest
100	1	1	QPSK	23.39	22.98	22.81
100	1	1	16-QAM	22.85	22.51	22.39
100	1	1	64-QAM	21.18	20.96	21.03
100	1	1	256-QAM	18.63	19.63	19.33



FR1 n41

Peak-to-Average Ratio

Mode	FR1 n41 / 20MHz / DFT-S OFDM				
Mod.	PI/2 BPSK	QPSK	16QAM	64QAM	Limit: 13dB
RB Size	Full RB	Full RB	Full RB	Full RB	Result
Middle CH	3.13	3.80	4.93	5.28	PASS
Mode	FR1 n41 / 20MHz / DFT-S OFDM				
Mod.	256QAM				Limit: 13dB
RB Size	Full RB				Result
Middle CH	6.38				PASS



FR1 n41 / 20MHz / DFT-S OFDM / Middle Channel / Full RB

PI/2 BPSK

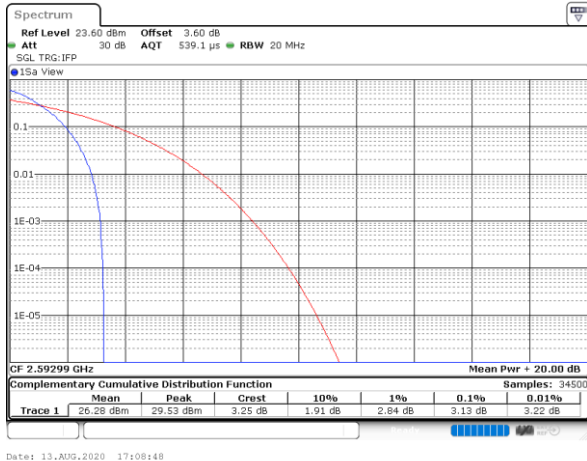

Date: 13.AUG.2020 17:08:48

QPSK

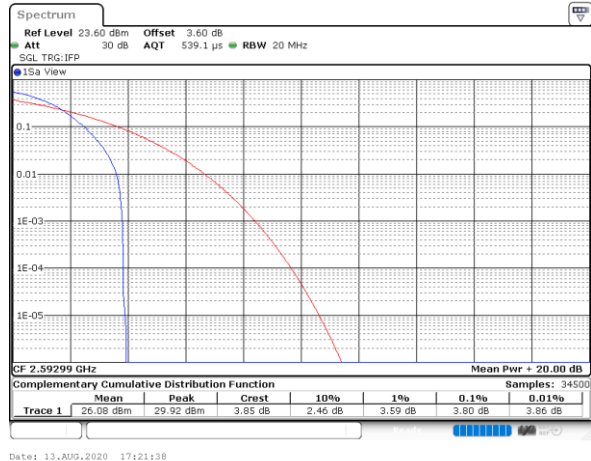

Date: 13.AUG.2020 17:21:38

16QAM

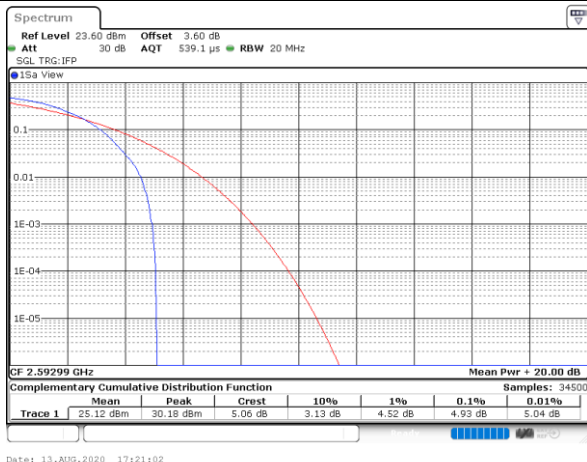

Date: 13.AUG.2020 17:21:02

64QAM

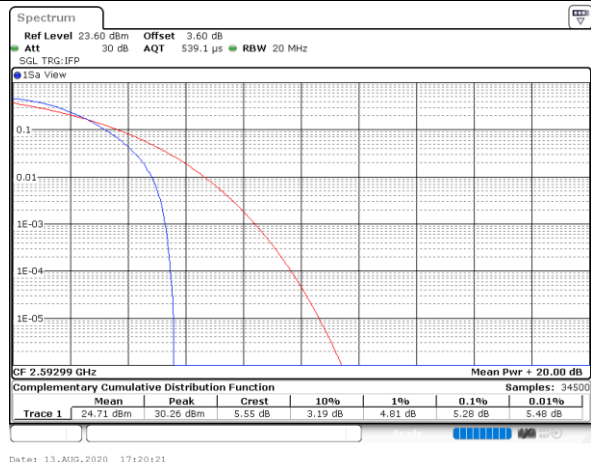

Date: 13.AUG.2020 17:20:21

256QAM

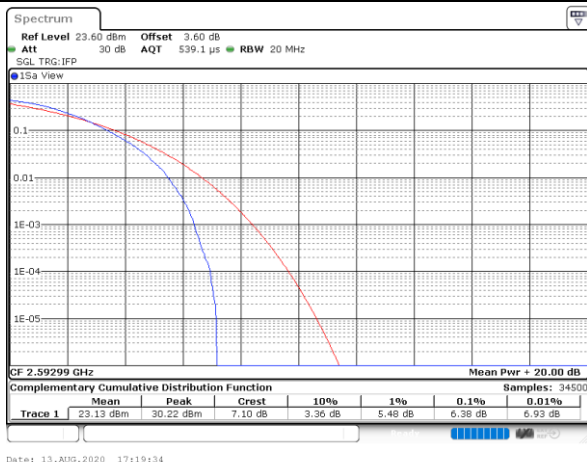

Date: 13.AUG.2020 17:19:34



26dB Bandwidth

Mode		FR1 n41 : 26dB BW(MHz) / DFT-S OFDM							
LTE BW		20MHz	20MHz	20MHz	20MHz	20MHz	20MHz	20MHz	
NR BW		20MHz	40MHz	50MHz	60MHz	80MHz	90MHz	100MHz	
Mod.		PI/2 BPSK	PI/2 BPSK	PI/2 BPSK	PI/2 BPSK	PI/2 BPSK	PI/2 BPSK	PI/2 BPSK	
Middle CH	LTE	19.14	19.14	19.14	19.14	19.14	19.14	19.14	
	NR	19.14	38.04	48.05	60.54	80.08	88.29	99.50	
	LTE+NR	38.28	57.18	67.19	79.68	99.22	107.43	118.64	

Mode		FR1 n41 : 26dB BW(MHz) / CP OFDM							
LTE BW		20MHz		20MHz		20MHz		20MHz	
NR BW		20MHz		40MHz		50MHz		60MHz	
Mod.		QPSK	16QAM	QPSK	16QAM	QPSK	16QAM	QPSK	16QAM
Middle CH	LTE	19.14	19.14	19.14	19.14	19.14	19.14	19.14	19.14
	NR	19.58	18.94	40.44	40.28	48.25	49.65	60.30	60.54
	LTE+NR	38.72	38.08	59.58	59.42	67.39	68.79	79.44	79.68
Mod.		64QAM	256QAM	64QAM	256QAM	64QAM	256QAM	64QAM	256QAM
Middle CH	LTE	19.14	19.14	19.14	19.14	19.14	19.14	19.14	19.14
	NR	19.66	19.06	40.44	40.12	50.05	50.35	60.42	60.42
	LTE+NR	38.80	38.20	59.58	59.26	69.19	69.49	79.56	79.56
LTE BW		20MHz		20MHz		20MHz			
NR BW		80MHz		90MHz		100MHz			
Mod.		QPSK	16QAM	QPSK	16QAM	QPSK	16QAM		
Middle CH	LTE	19.14	19.14	19.14	19.14	19.14	19.14		
	NR	79.60	79.76	90.09	90.27	100.90	100.50		
	LTE+NR	98.74	98.90	109.23	109.41	120.04	119.64		
Mod.		64QAM	256QAM	64QAM	256QAM	64QAM	256QAM		
Middle CH	LTE	19.14	19.14	19.14	19.14	19.14	19.14		
	NR	79.92	79.76	90.09	90.27	100.30	100.50		
	LTE+NR	99.06	98.90	109.23	109.41	119.44	119.64		



FR1 n41 / 20MHz / DFT-S OFDM / Middle Channel

PI/2 BPSK

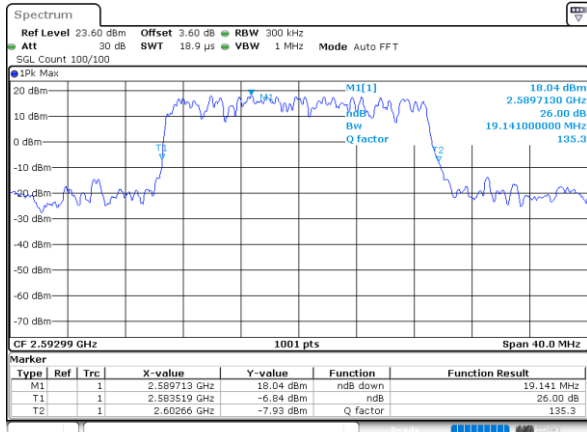

Date: 13_AUG_2020 15:29:07

FR1 n41 / 20MHz / CP OFDM

QPSK

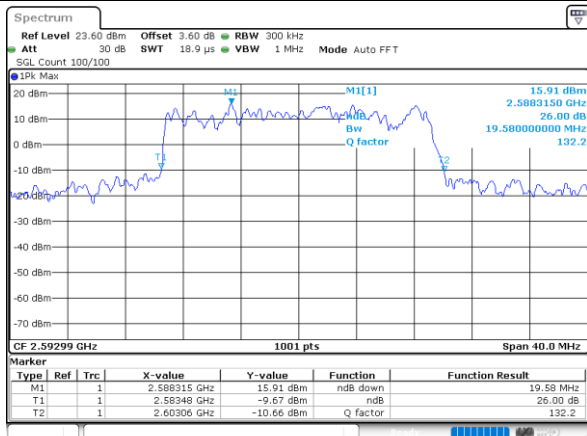

Date: 13_AUG_2020 15:35:50

16QAM

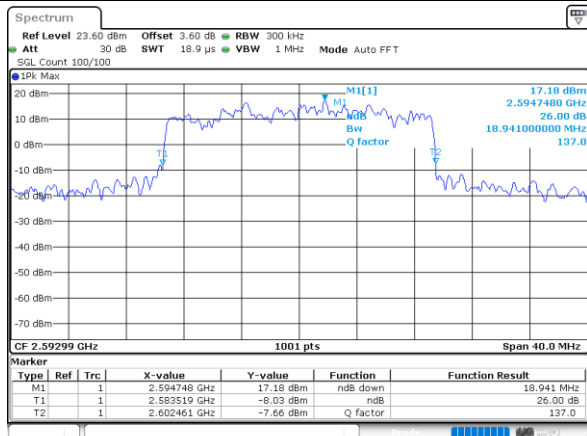

Date: 13_AUG_2020 15:36:04

64QAM

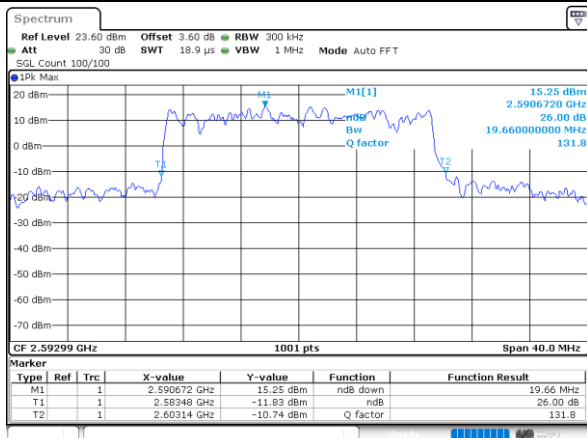

Date: 13_AUG_2020 15:36:36

256QAM

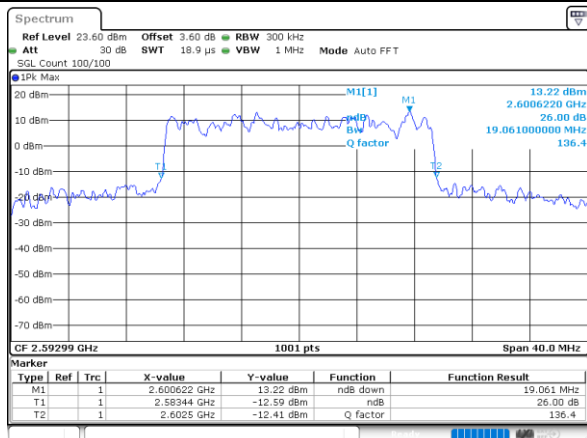

Date: 13_AUG_2020 15:37:17



FR1 n41 / 40MHz / DFT-S OFDM / Middle Channel

PI/2 BPSK

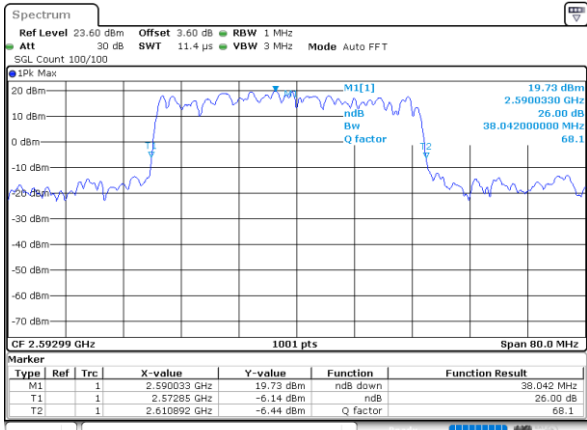

Date: 13_AUG_2020 15:21:20

QPSK

Middle Channel

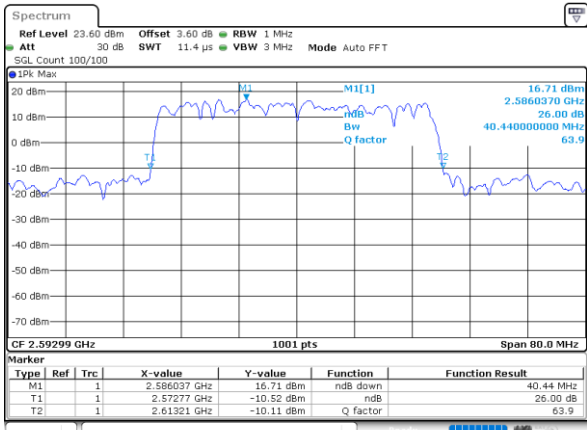

Date: 13_AUG_2020 15:19:29

16QAM

Middle Channel

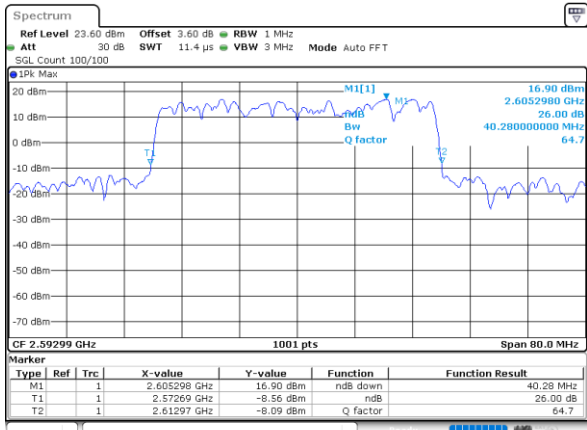

Date: 13_AUG_2020 15:18:48

64QAM

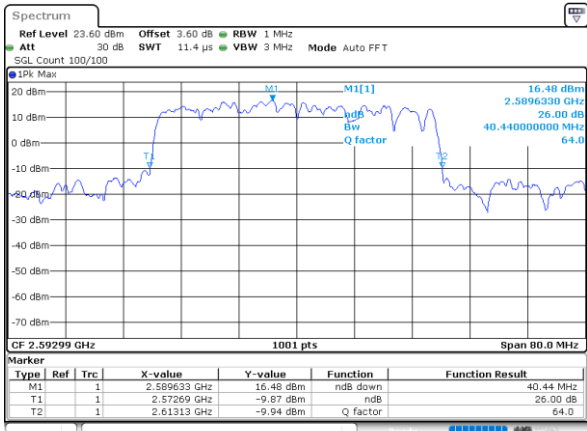

Date: 13_AUG_2020 15:18:21

256QAM

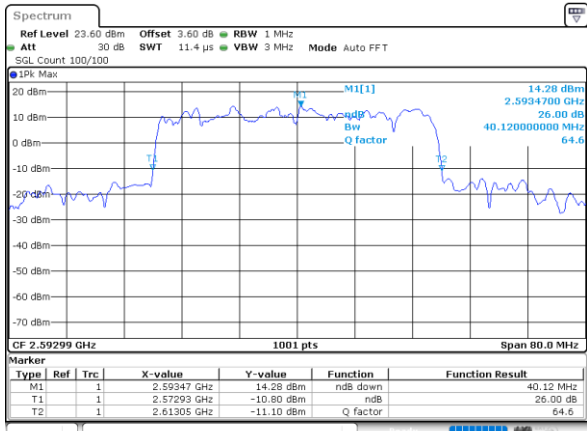

Date: 13_AUG_2020 15:17:46



FR1 n41 / 50MHz / DFT-S OFDM / Middle Channel

PI/2 BPSK

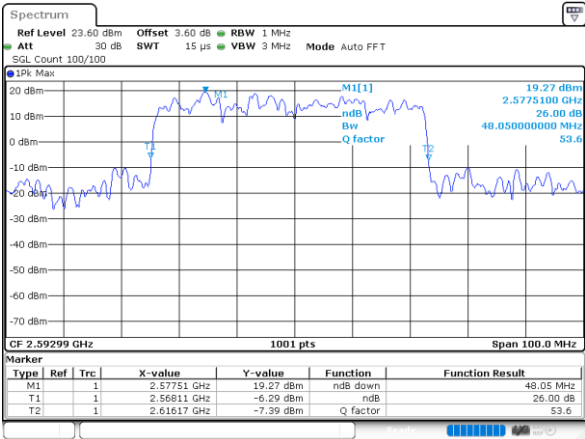

Date: 13.AUG.2020 15:06:02

QPSK

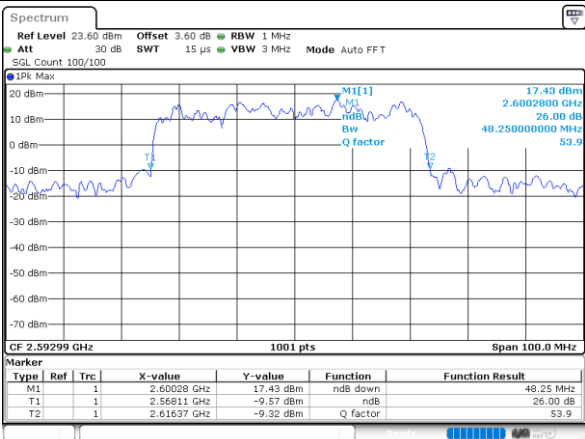

Date: 13.AUG.2020 15:08:40

16QAM

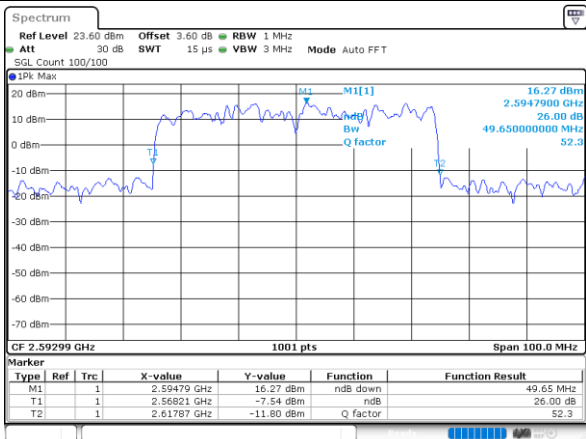

Date: 13.AUG.2020 15:10:08

64QAM

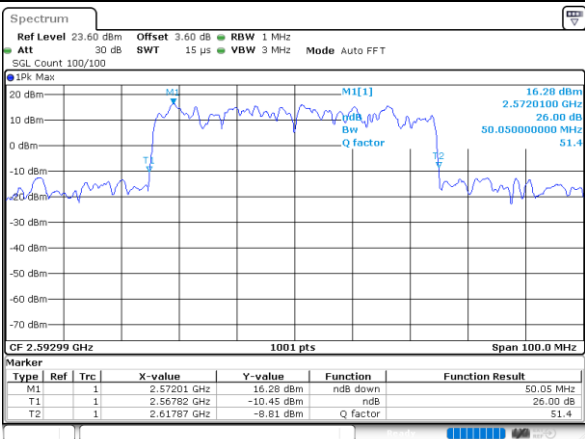

Date: 13.AUG.2020 15:09:37

256QAM

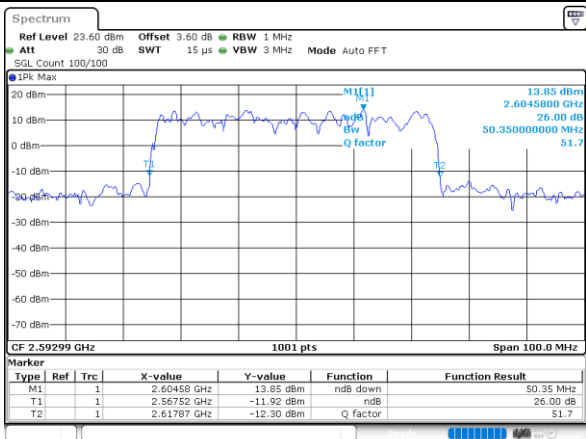

Date: 13.AUG.2020 15:10:16



FR1 n41 / 60MHz / DFT-S OFDM / Middle Channel

PI/2 BPSK

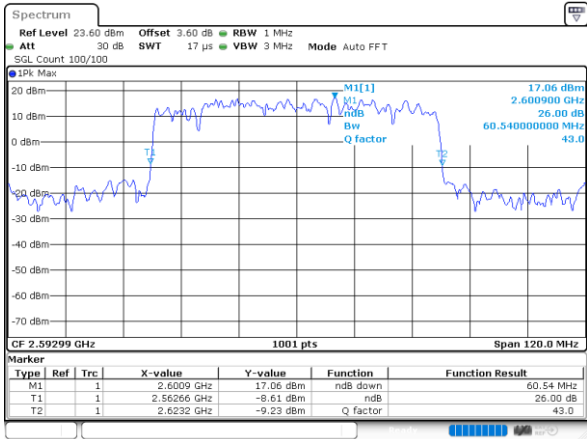

Date: 13.AUG.2020 15:02:31

FR1 n41 / 60MHz / CP OFDM

QPSK

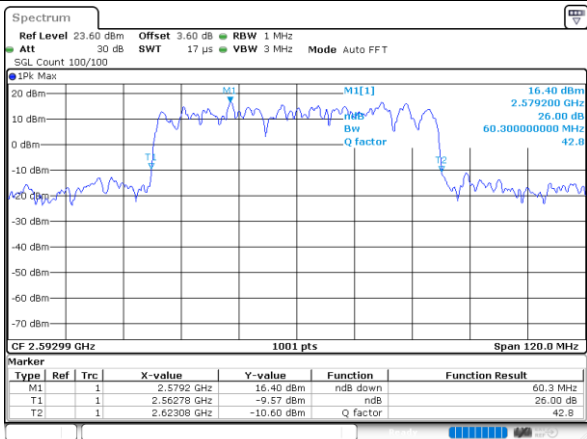

Date: 13.AUG.2020 15:01:18

16QAM

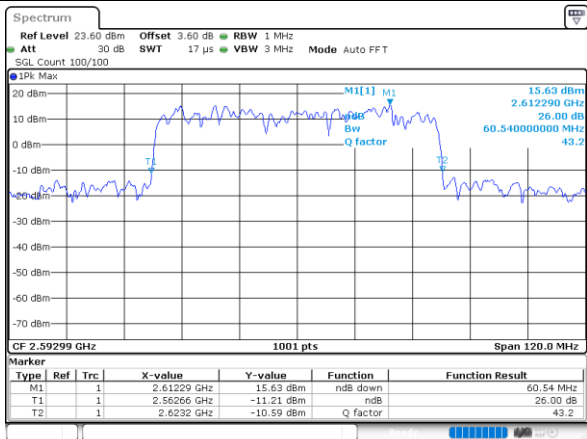

Date: 13.AUG.2020 15:00:34

64QAM

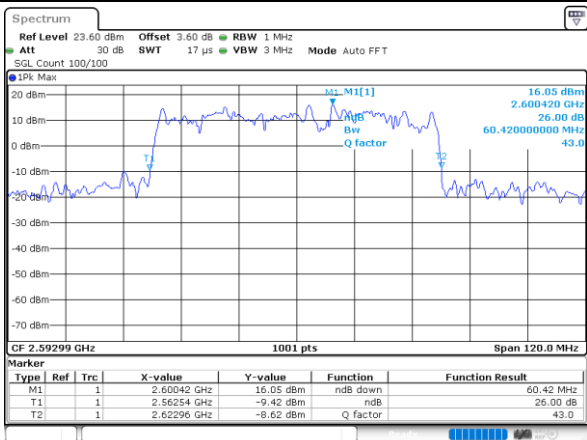

Date: 13.AUG.2020 14:59:52

256QAM

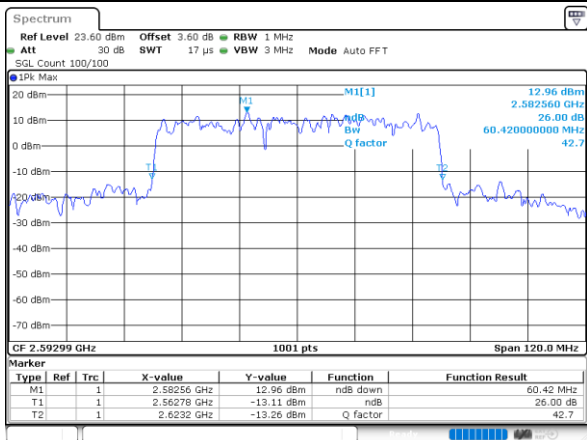

Date: 13.AUG.2020 14:59:11



FR1 n41 / 80MHz / DFT-S OFDM / Middle Channel

PI/2 BPSK



Date: 13.AUG.2020 14:36:07

QPSK

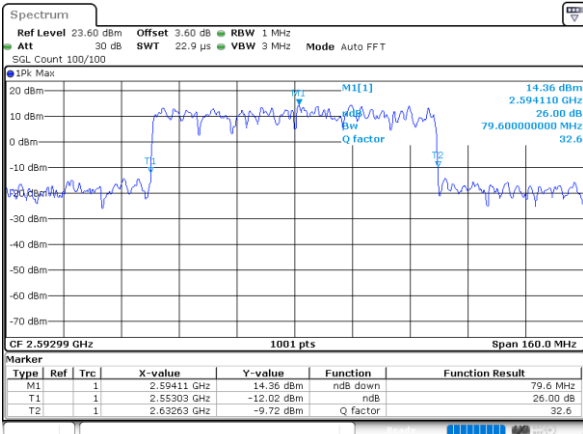

Date: 13.AUG.2020 14:37:13

16QAM

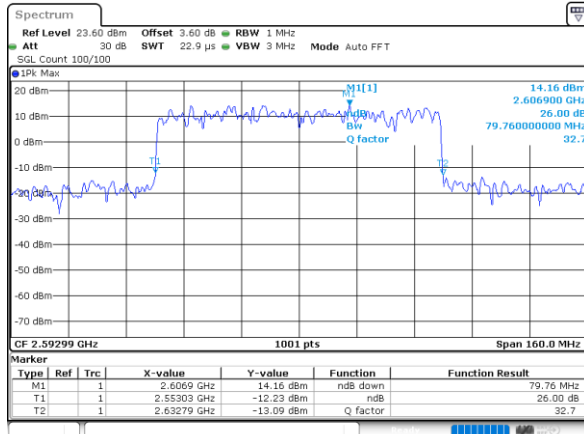

Date: 13.AUG.2020 14:38:04

64QAM



Date: 13.AUG.2020 14:38:42

256QAM

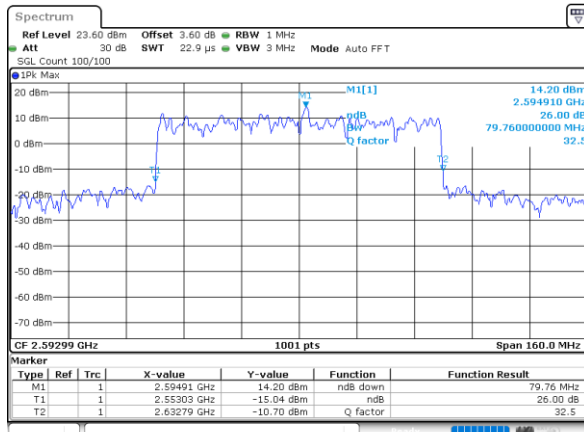

Date: 13.AUG.2020 14:40:20



FR1 n41 / 90MHz / DFT-S OFDM / Middle Channel

PI/2 BPSK

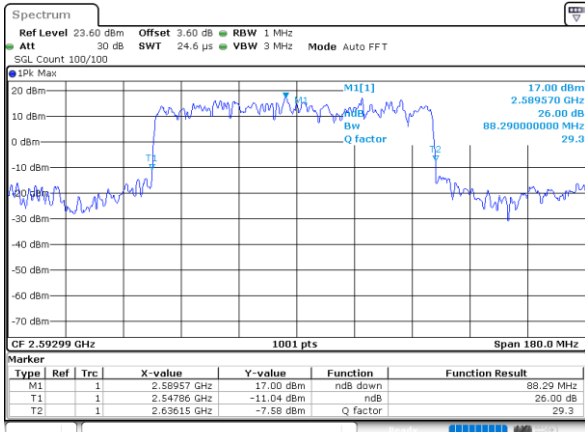

Date: 13.AUG.2020 14:31:44

QPSK

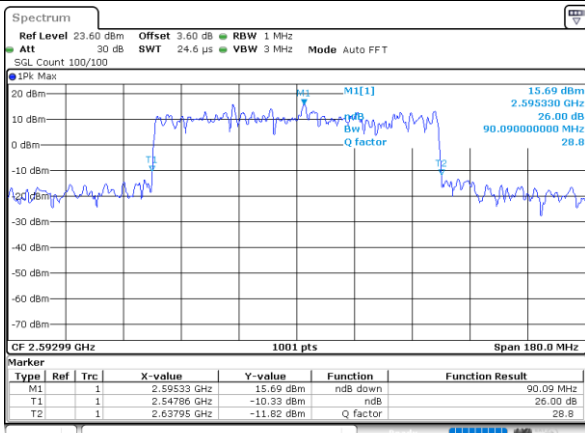

Date: 13.AUG.2020 14:30:23

16QAM

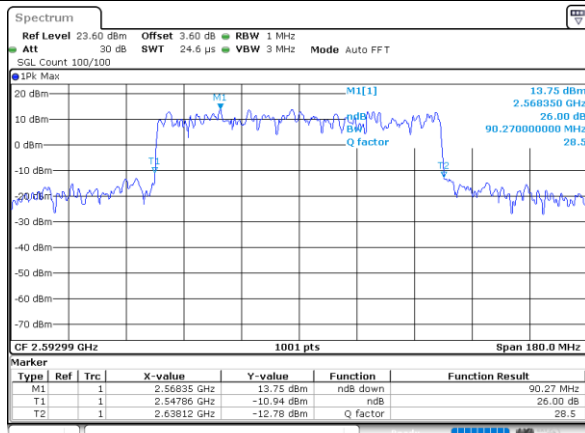

Date: 13.AUG.2020 14:29:28

64QAM

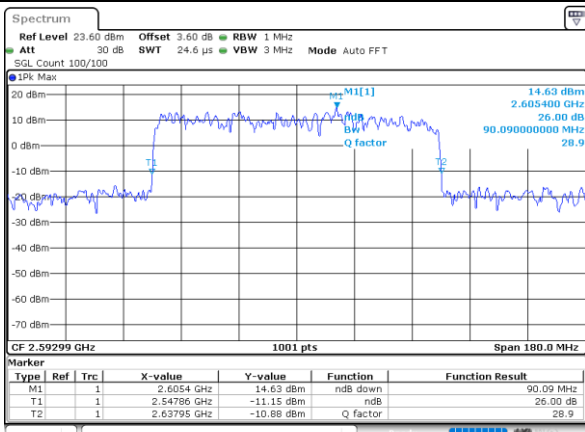

Date: 13.AUG.2020 14:28:56

256QAM

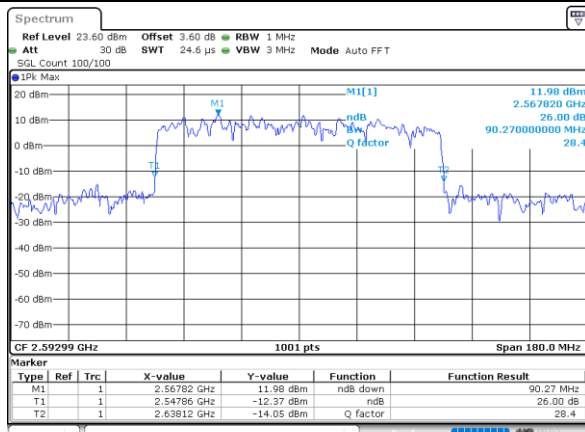

Date: 13.AUG.2020 14:28:05



FR1 n41 / 100MHz / DFT-S OFDM / Middle Channel

PI/2 BPSK

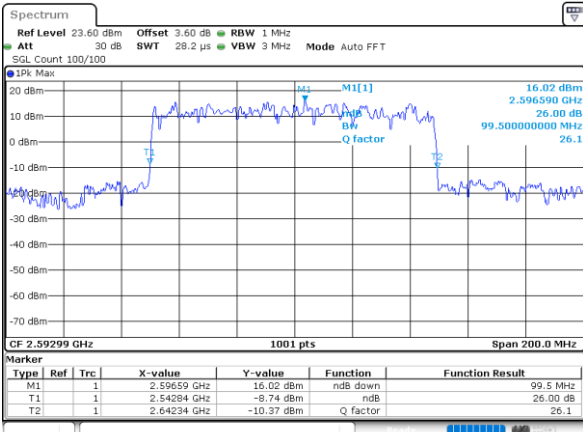

Date: 13.AUG.2020 14:21:12

QPSK

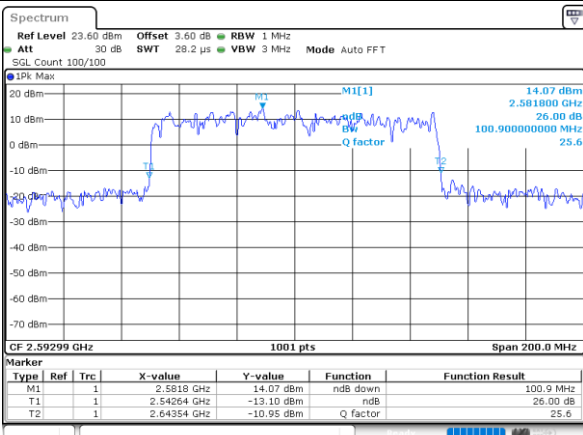

Date: 13.AUG.2020 14:23:47

16QAM

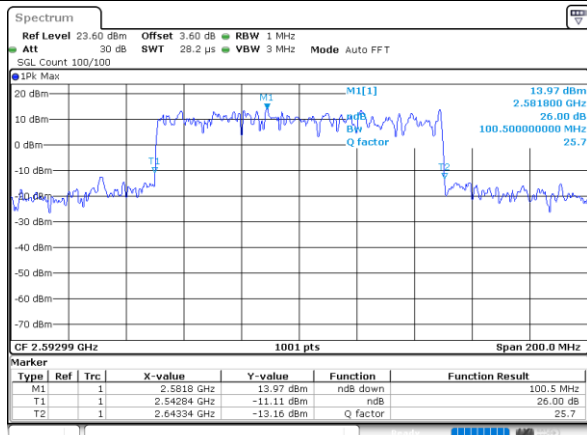

Date: 13.AUG.2020 14:24:26

64QAM

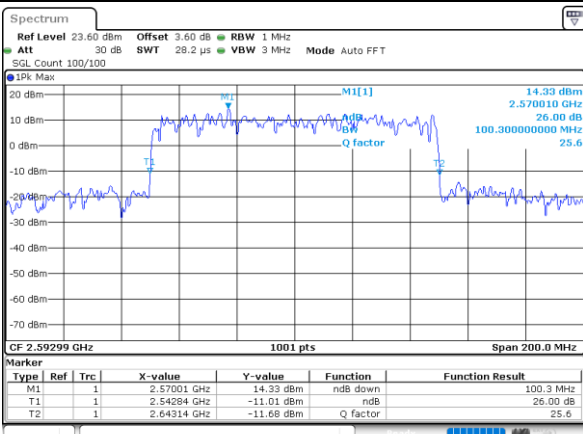

Date: 13.AUG.2020 14:25:32

256QAM

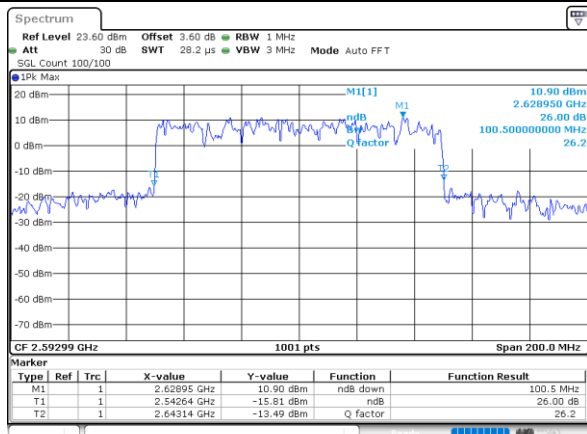

Date: 13.AUG.2020 14:26:17



Occupied Bandwidth

Mode		FR1 n41 : OB BW(MHz) / DFT-S OFDM						
LTE BW		20MHz	20MHz	20MHz	20MHz	20MHz	20MHz	20MHz
NR BW		20MHz	40MHz	50MHz	60MHz	80MHz	90MHz	100MHz
Mod.		PI/2 BPSK	PI/2 BPSK	PI/2 BPSK	PI/2 BPSK	PI/2 BPSK	PI/2 BPSK	PI/2 BPSK
Middle CH	LTE	17.82	17.82	17.82	17.82	17.82	17.82	17.82
	NR	17.90	35.88	45.85	57.66	77.36	85.77	96.50
	LTE+NR	35.72	53.7	63.67	75.48	95.18	103.59	114.32

Mode		FR1 n41 : OB BW(MHz) / CP OFDM							
LTE BW		20MHz		20MHz		20MHz		20MHz	
NR BW		20MHz		40MHz		50MHz		60MHz	
Mod.		QPSK	16QAM	QPSK	16QAM	QPSK	16QAM	QPSK	16QAM
Middle CH	LTE	17.82	17.82	17.82	17.82	17.82	17.82	17.82	17.82
	NR	18.22	18.10	38.12	38.12	45.85	47.95	57.78	57.78
	LTE+NR	36.04	35.92	55.94	55.94	63.67	65.77	75.60	75.60
Mod.		64QAM	256QAM	64QAM	256QAM	64QAM	256QAM	64QAM	256QAM
Middle CH	LTE	17.82	17.82	17.82	17.82	17.82	17.82	17.82	17.82
	NR	18.22	18.34	38.12	38.44	47.65	47.65	57.90	57.90
	LTE+NR	36.04	36.16	55.94	56.26	65.47	65.47	75.72	75.72
LTE BW		20MHz		20MHz		20MHz			
NR BW		80MHz		90MHz		100MHz			
Mod.		QPSK	16QAM	QPSK	16QAM	QPSK	16QAM		
Middle CH	LTE	17.82	17.82	17.82	17.82	17.82	17.82		
	NR	76.72	77.68	87.21	87.39	97.70	97.10		
	LTE+NR	94.54	95.50	105.03	105.21	115.52	114.92		
Mod.		64QAM	256QAM	64QAM	256QAM	64QAM	256QAM		
Middle CH	LTE	17.82	17.82	17.82	17.82	17.82	17.82		
	NR	77.20	77.52	87.57	87.57	97.50	97.30		
	LTE+NR	95.02	95.34	105.39	105.39	115.32	115.12		



FR1 n41 / 20MHz / DFT-S OFDM / Middle Channel

PI/2 BPSK

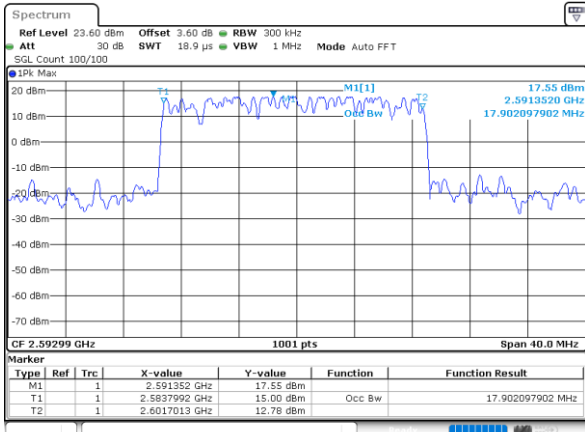

Date: 13.AUG.2020 15:28:54

QPSK

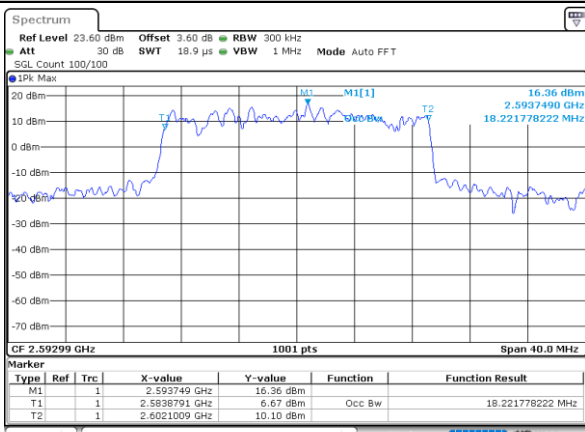

Date: 13.AUG.2020 15:35:19

16QAM

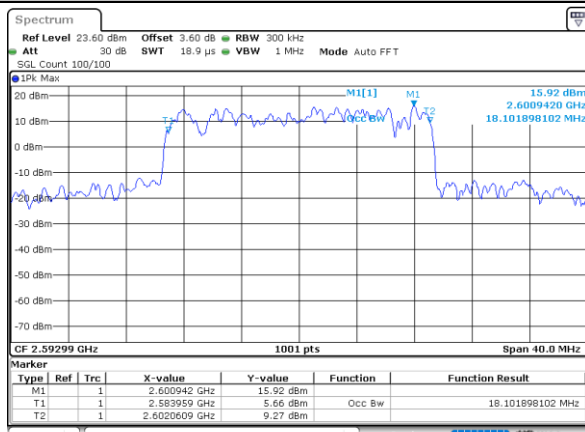

Date: 13.AUG.2020 15:35:54

64QAM

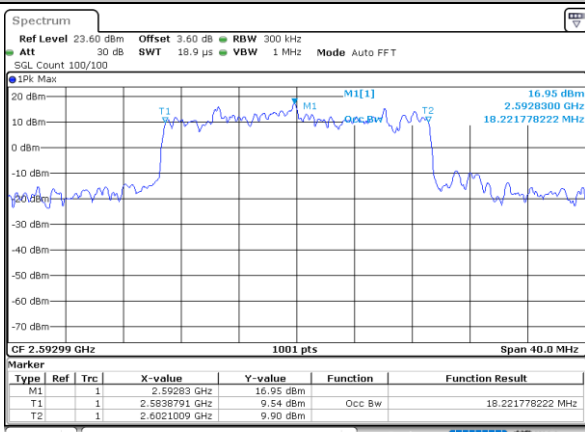

Date: 13.AUG.2020 15:36:24

256QAM

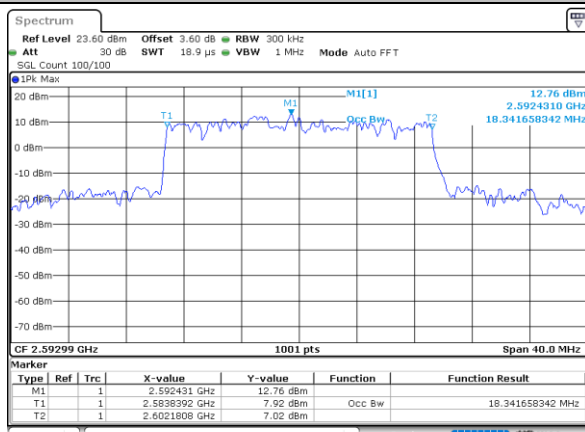

Date: 13.AUG.2020 15:37:05



FR1 n41 / 40MHz / DFT-S OFDM / Middle Channel

PI/2 BPSK

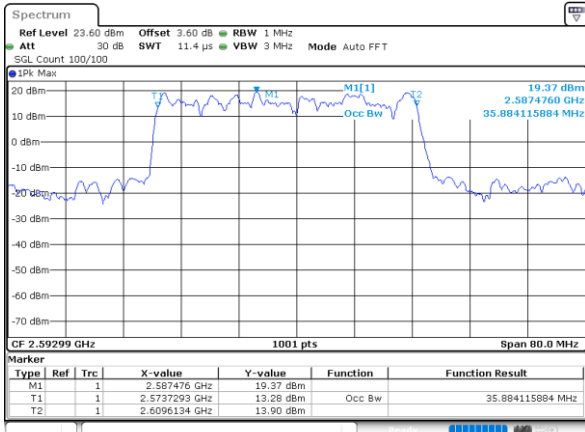

Date: 13.AUG.2020 15:20:54

QPSK

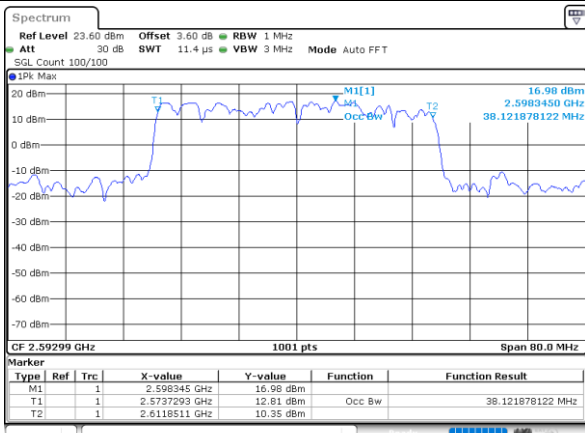

Date: 13.AUG.2020 15:19:09

16QAM

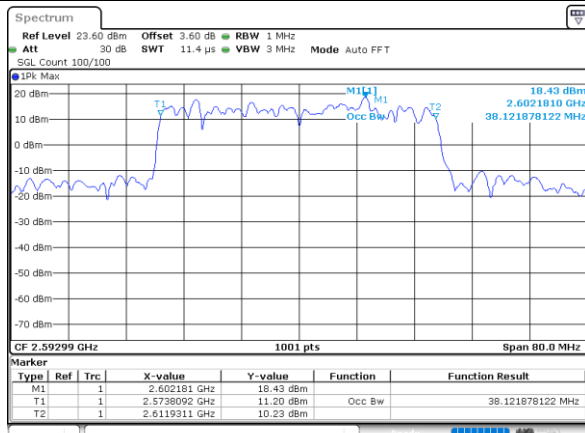

Date: 13.AUG.2020 15:18:37

64QAM

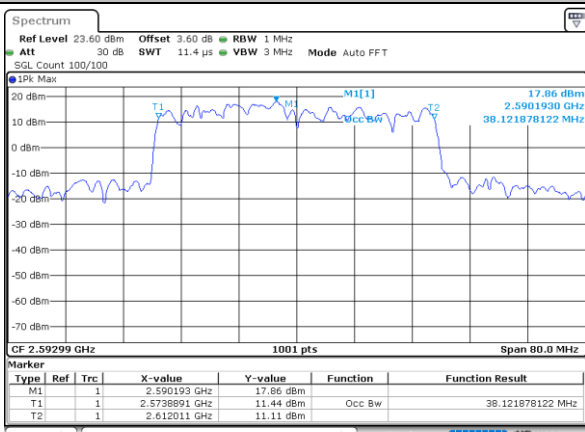

Date: 13.AUG.2020 15:18:09

256QAM

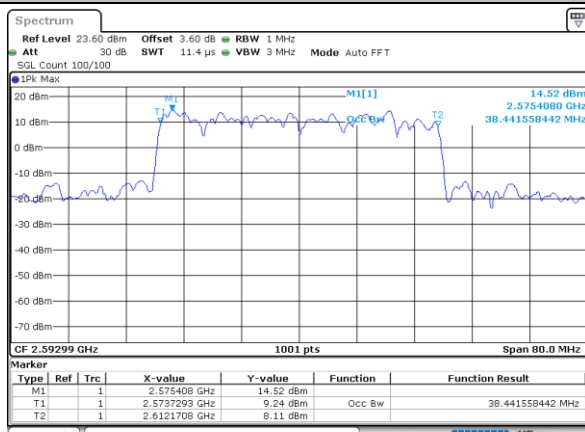

Date: 13.AUG.2020 15:17:24



FR1 n41 / 50MHz / DFT-S OFDM / Middle Channel

PI/2 BPSK

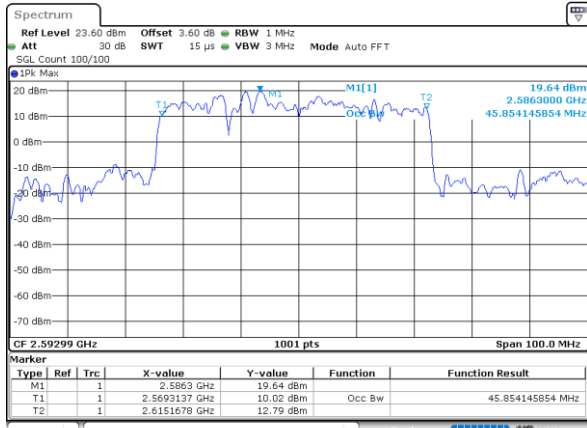

QPSK

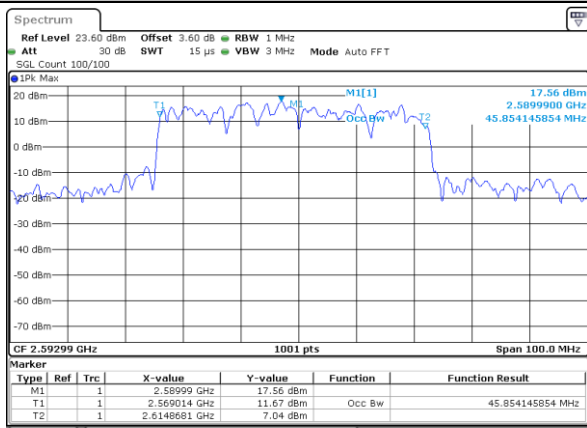

16QAM

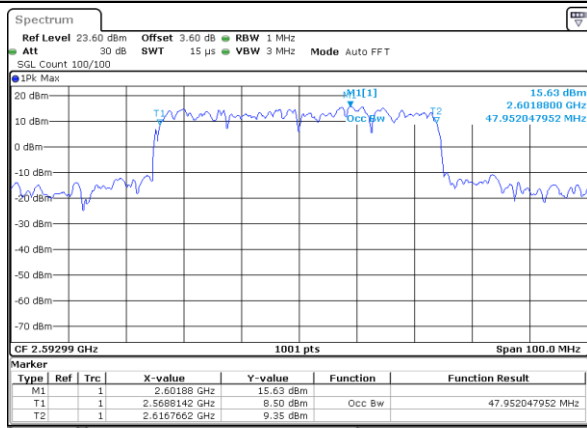

64QAM

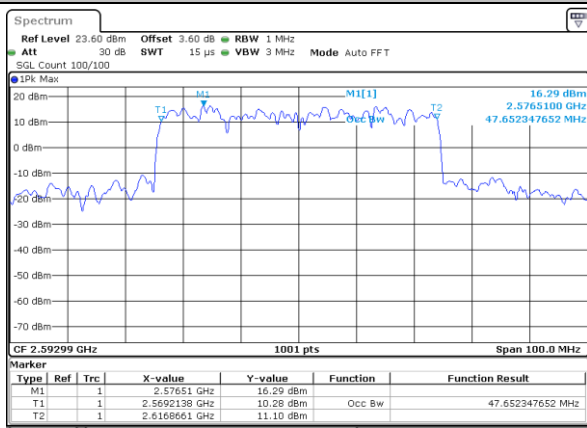

256QAM

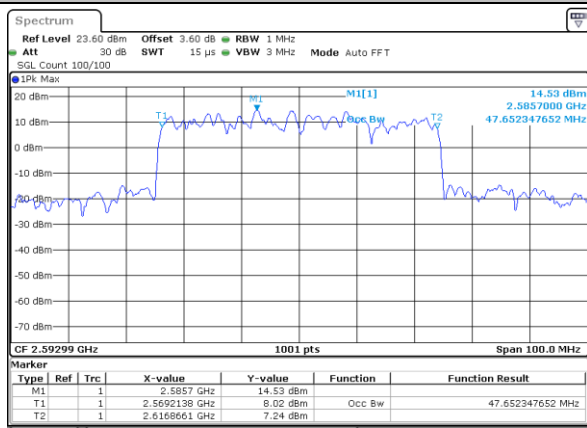



FR1 n41 / 60MHz / DFT-S OFDM / Middle Channel

PI/2 BPSK

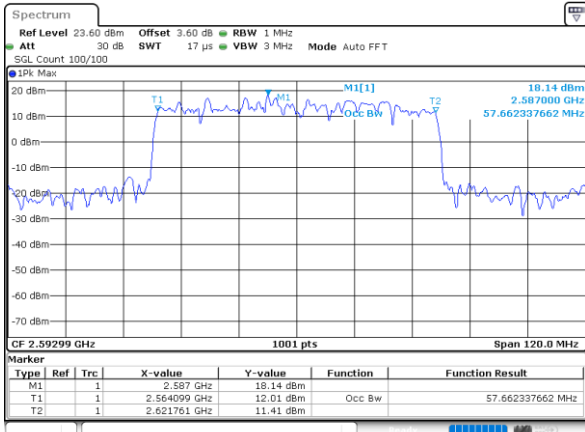

Date: 13.AUG.2020 15:02:14

QPSK

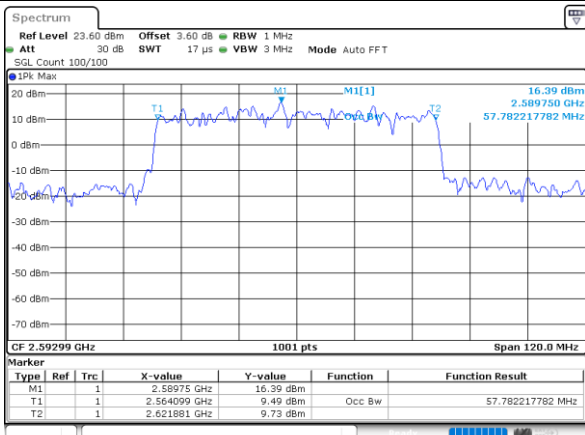

Date: 13.AUG.2020 15:01:08

16QAM

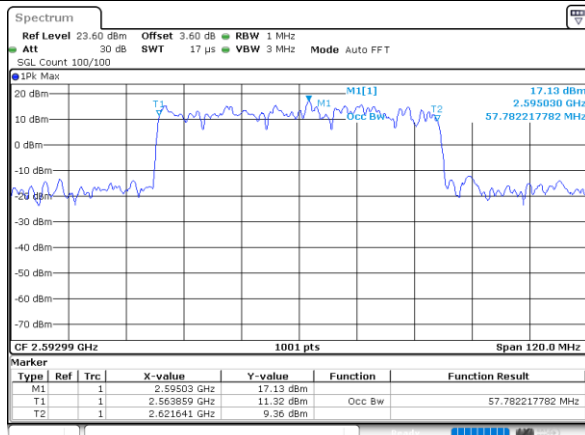

Date: 13.AUG.2020 15:00:15

64QAM

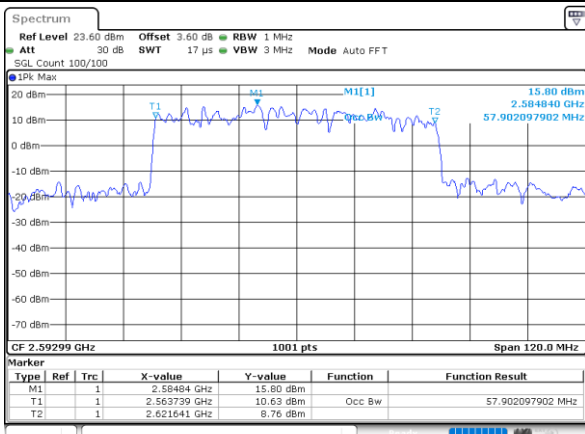

Date: 13.AUG.2020 14:59:40

256QAM

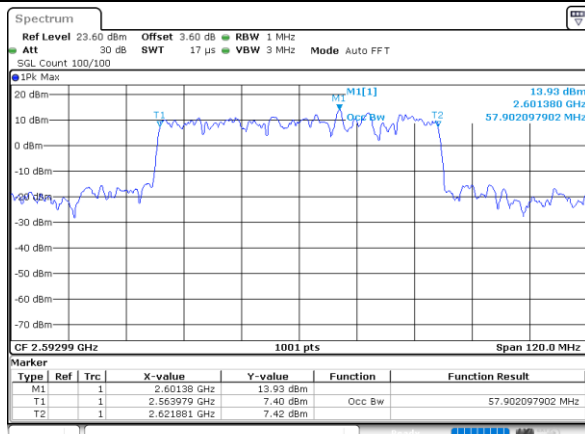

Date: 13.AUG.2020 14:59:00



FR1 n41 / 80MHz / DFT-S OFDM / Middle Channel

PI/2 BPSK

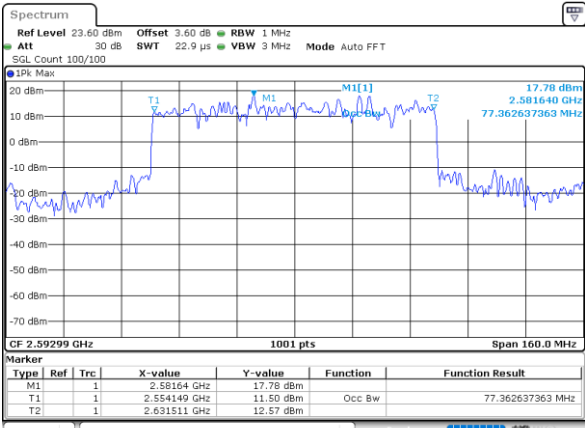

Date: 13.AUG.2020 14:35:56

QPSK

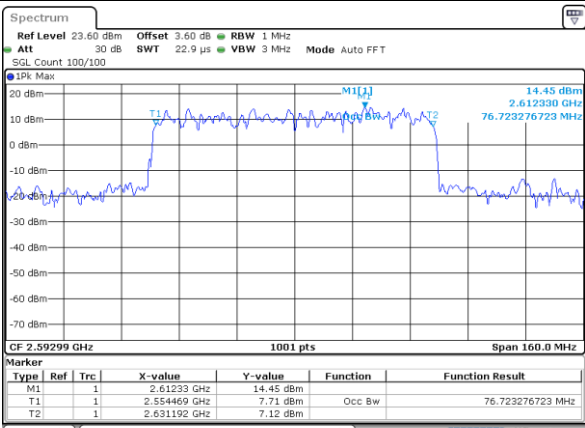

Date: 13.AUG.2020 14:37:02

16QAM

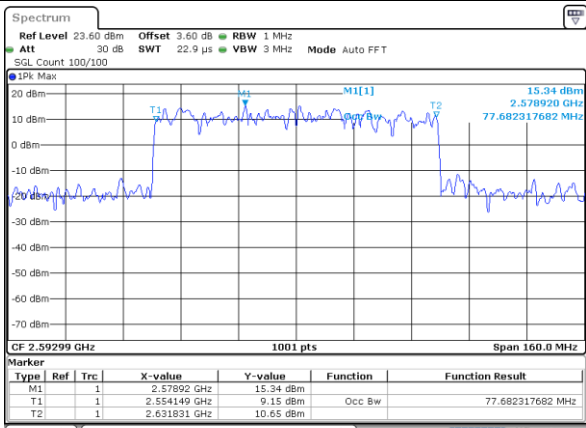

Date: 13.AUG.2020 14:37:50

64QAM

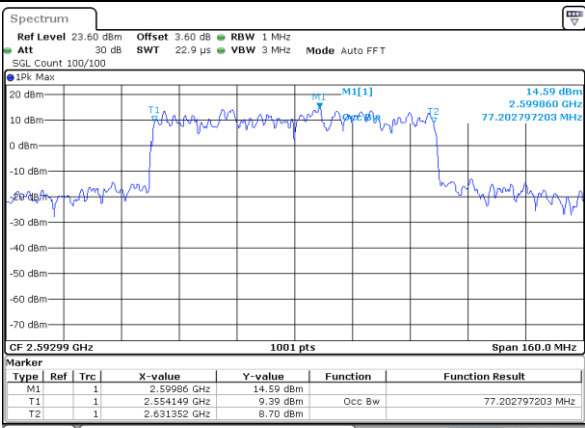

Date: 13.AUG.2020 14:38:20

256QAM

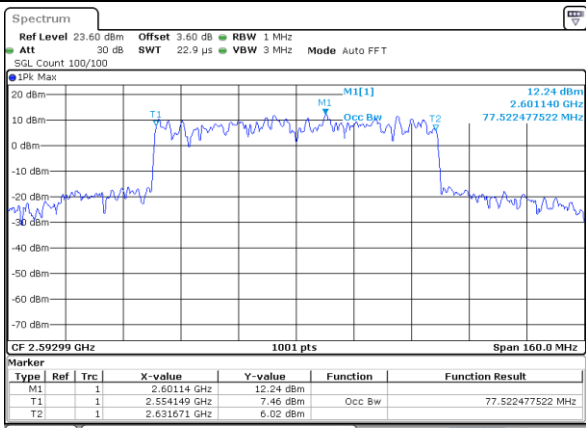

Date: 13.AUG.2020 14:40:07



FR1 n41 / 90MHz / DFT-S OFDM / Middle Channel

PI/2 BPSK

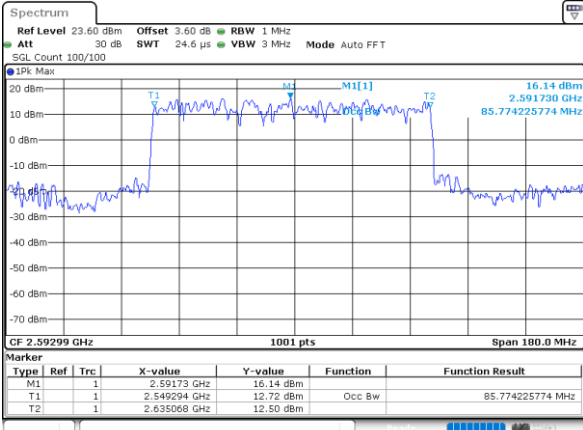

Date: 13.AUG.2020 14:31:32

QPSK

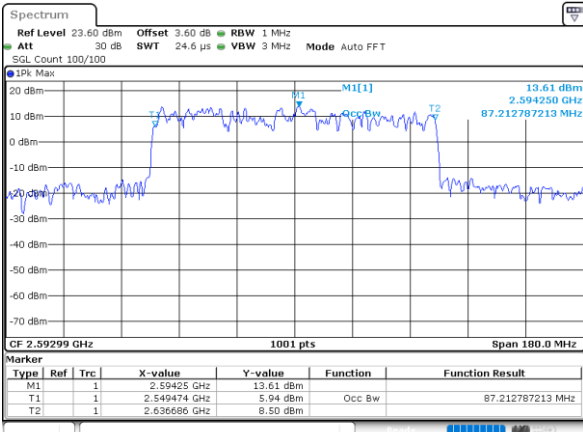

Date: 13.AUG.2020 14:30:11

16QAM

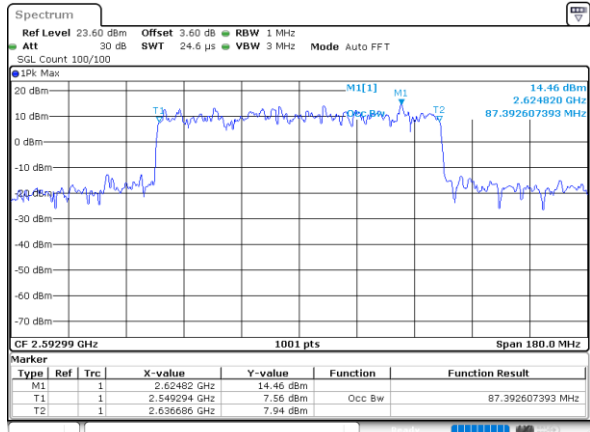

Date: 13.AUG.2020 14:29:16

64QAM

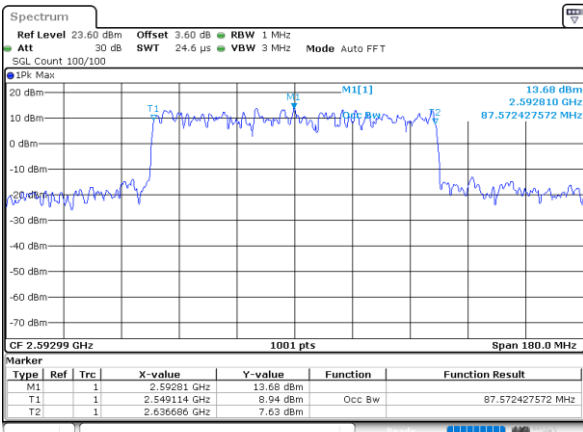

Date: 13.AUG.2020 14:28:45

256QAM

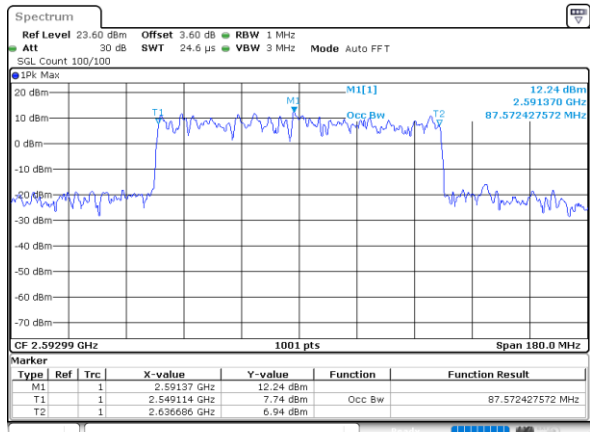

Date: 13.AUG.2020 14:27:52



FR1 n41 / 100MHz / DFT-S OFDM / Middle Channel

PI/2 BPSK

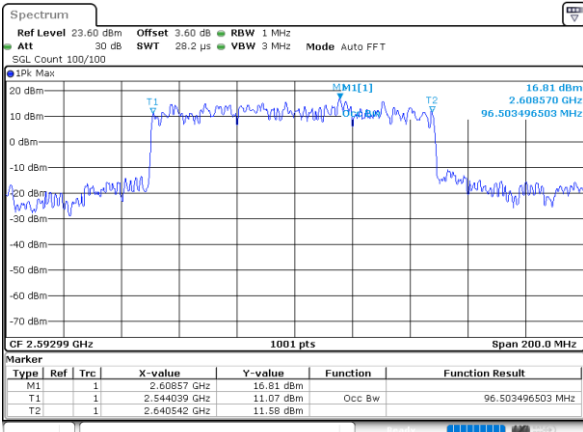

Date: 13.AUG.2020 14:20:58

QPSK

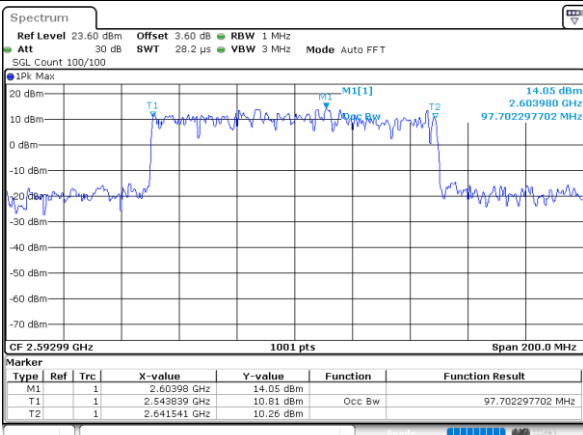

Date: 13.AUG.2020 14:23:01

16QAM

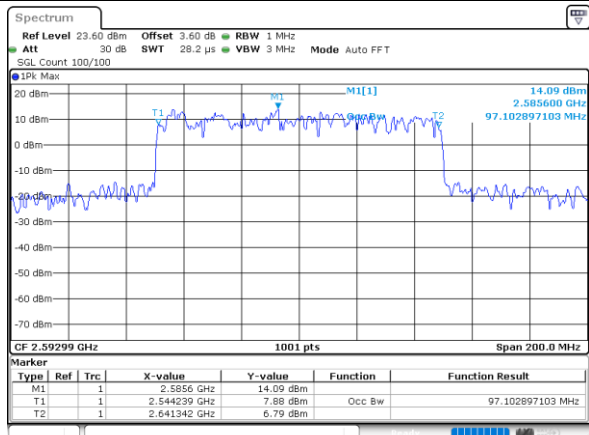

Date: 13.AUG.2020 14:24:14

64QAM

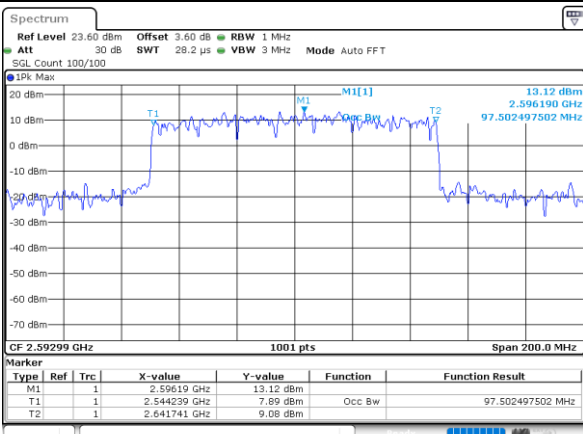

Date: 13.AUG.2020 14:25:20

256QAM

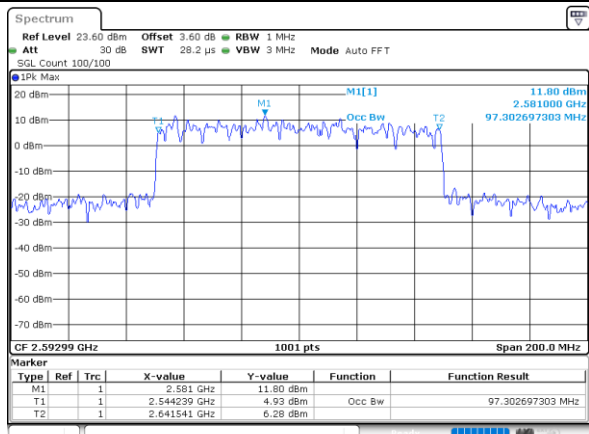

Date: 13.AUG.2020 14:26:06



Conducted Band Edge

FR1 n41 / 20MHz / DFT-S OFDM / PI/2 BPSK

Lowest Band Edge / 1RB0

Highest Band Edge / 1RBmax

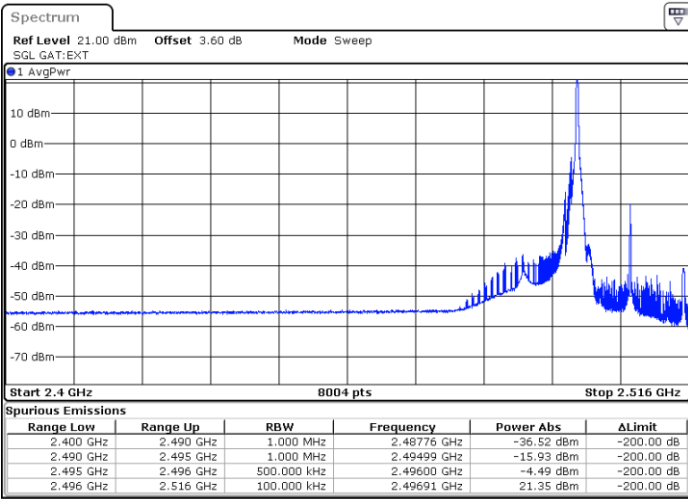

Date: 16.AUG.2020 14:27:45

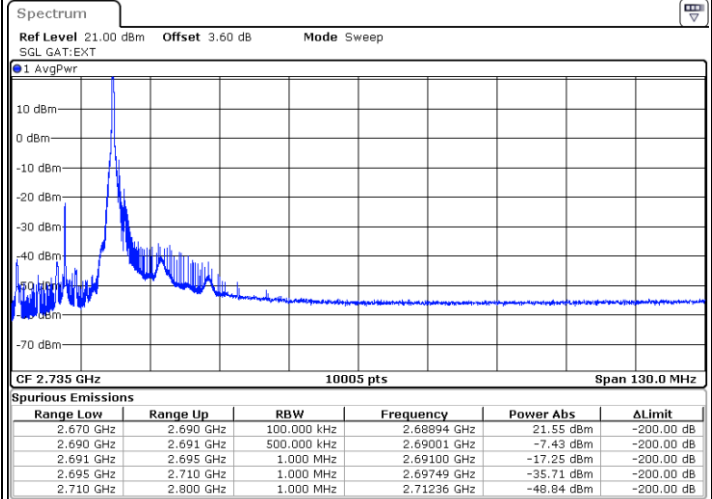

Date: 16.AUG.2020 15:09:17

Lowest Band Edge / Full RB

Highest Band Edge / Full RB

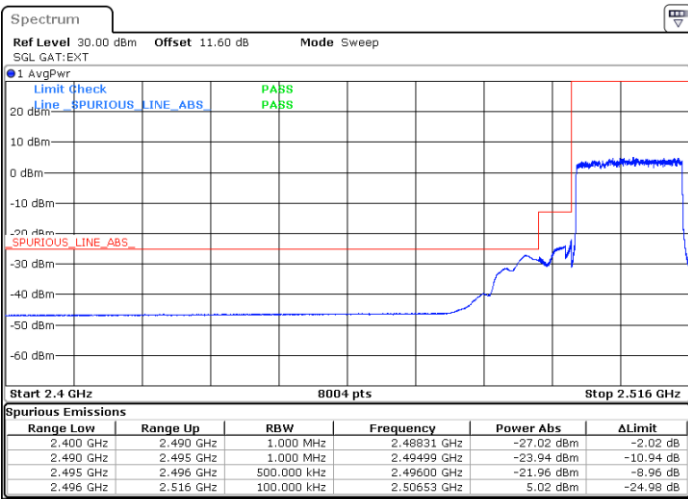

Date: 29.SEP.2020 17:59:05

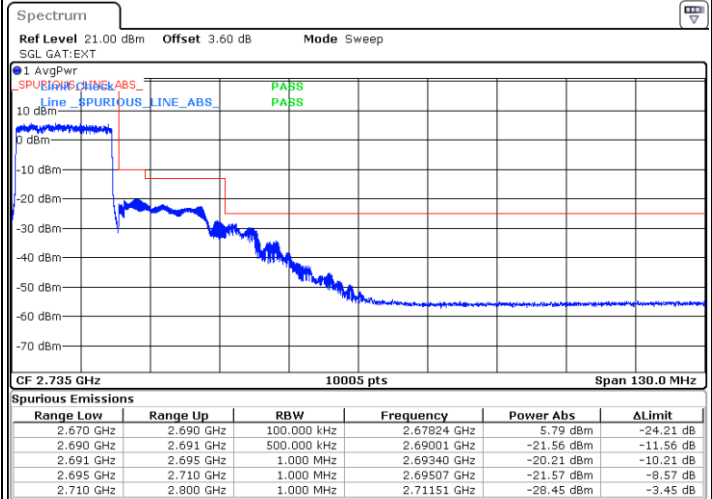

Date: 17.AUG.2020 15:16:36



FR1 n41 / 20MHz / DFT-S OFDM / QPSK

Lowest Band Edge / 1RB0

Highest Band Edge / 1RBmax

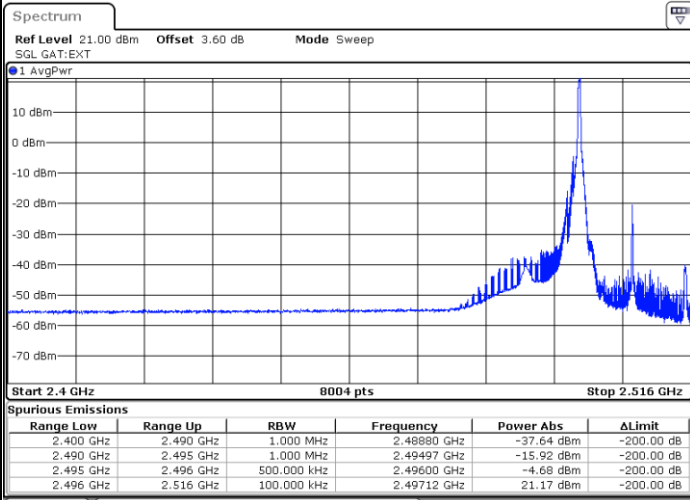

Date: 16.AUG.2020 14:33:01

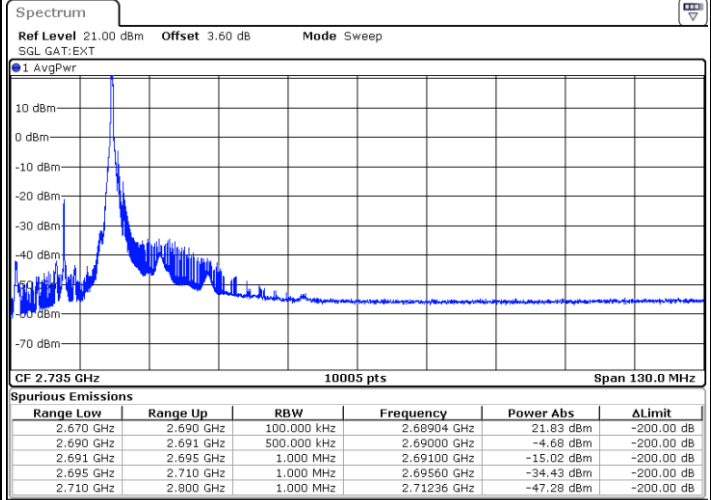

Date: 16.AUG.2020 15:16:10

Lowest Band Edge / Full RB

Highest Band Edge / Full RB

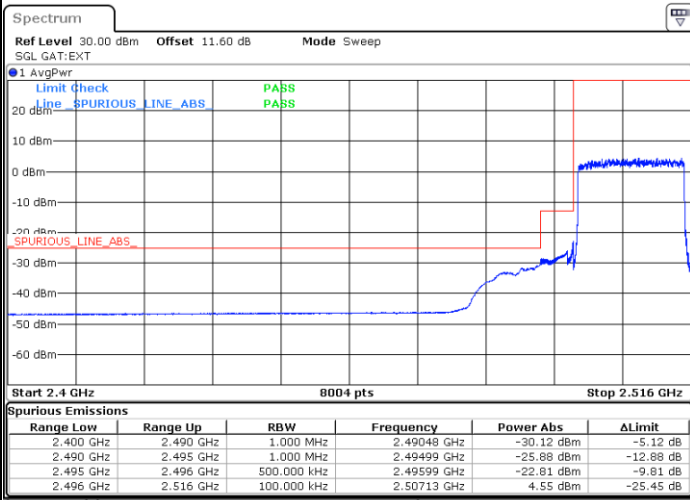

Date: 29.SEP.2020 18:01:46

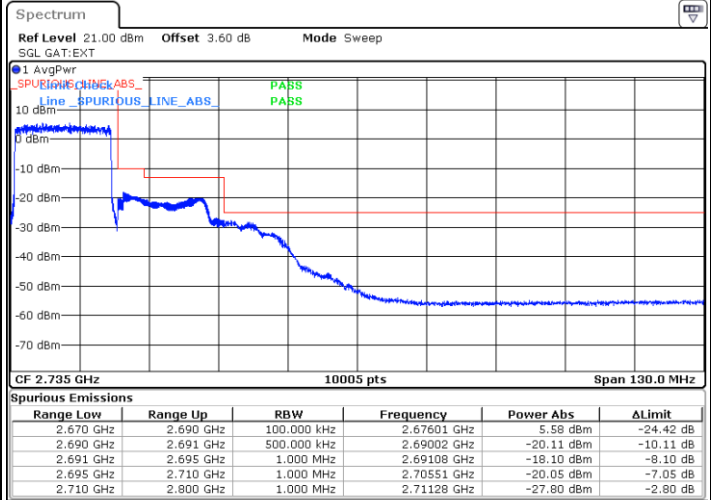

Date: 17.AUG.2020 15:14:19



FR1 n41 / 20MHz / DFT-S OFDM / 16QAM

Lowest Band Edge / 1RB0

Highest Band Edge / 1RBmax

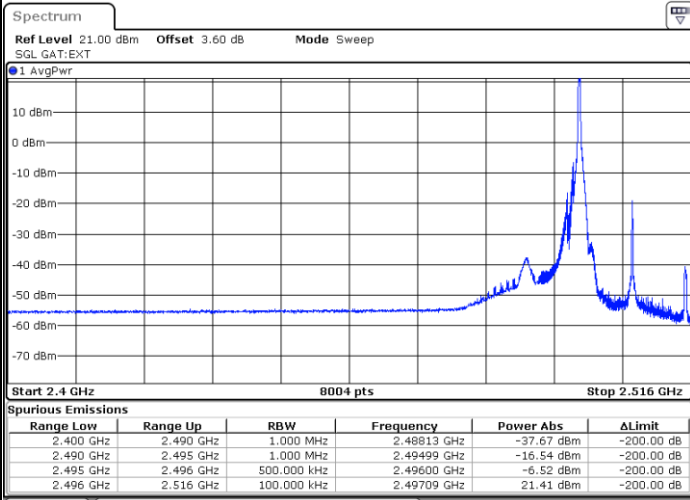

Date: 16.AUG.2020 14:37:14

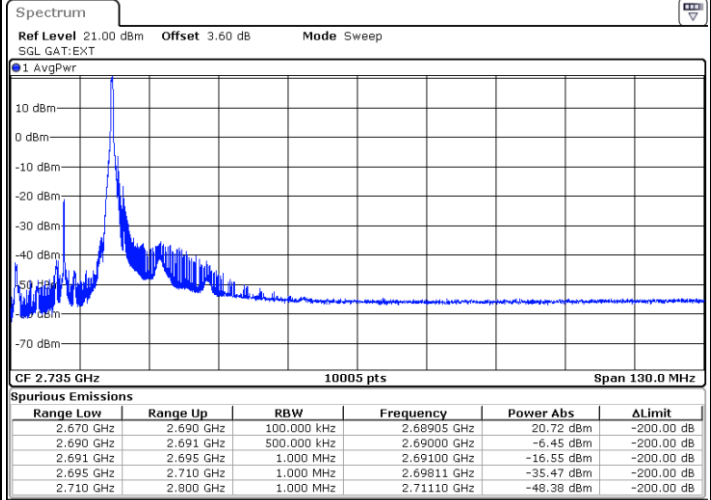

Date: 16.AUG.2020 15:22:55

Lowest Band Edge / Full RB

Highest Band Edge / Full RB

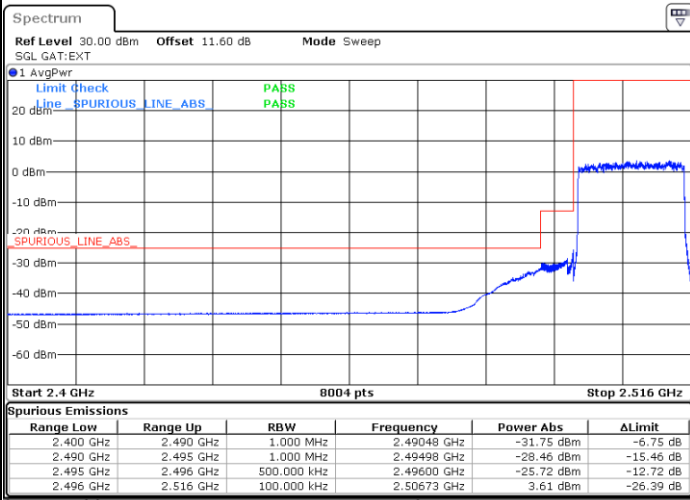

Date: 29.SEP.2020 18:04:33

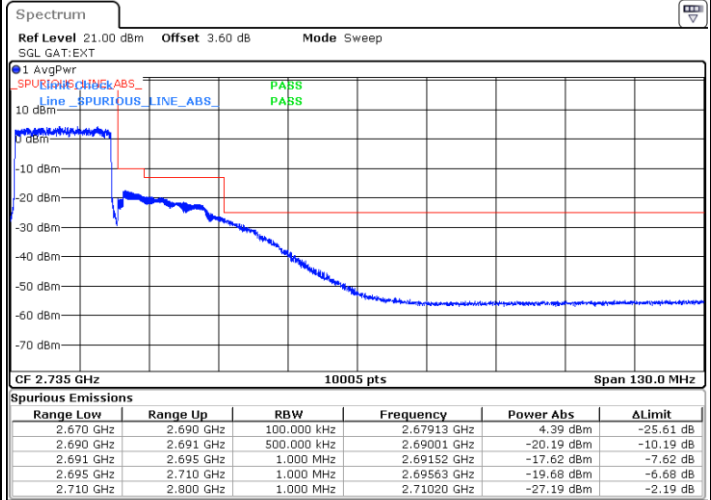

Date: 17.AUG.2020 15:13:27



FR1 n41 / 20MHz / DFT-S OFDM / 64QAM

Lowest Band Edge / 1RB0

Highest Band Edge / 1RBmax

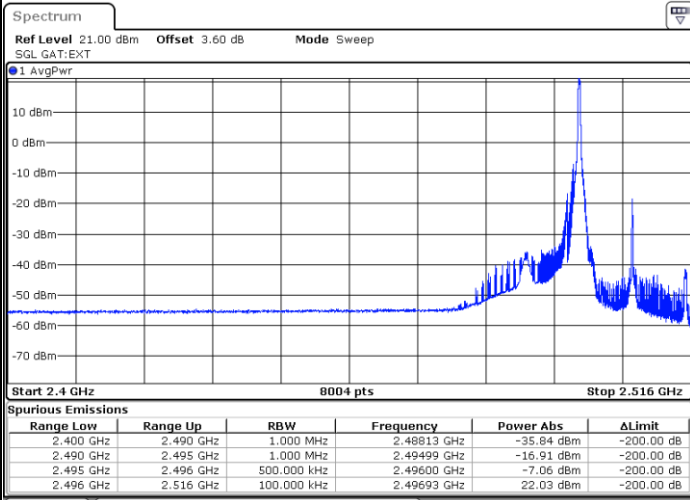

Date: 16.AUG.2020 14:46:55

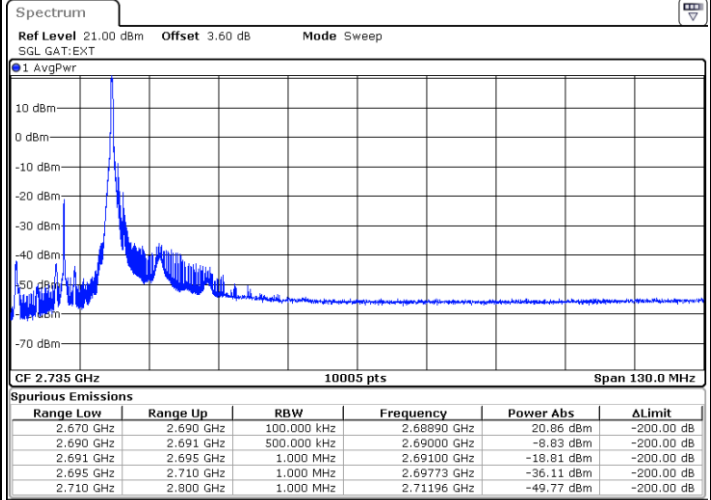

Date: 16.AUG.2020 15:26:35

Lowest Band Edge / Full RB

Highest Band Edge / Full RB

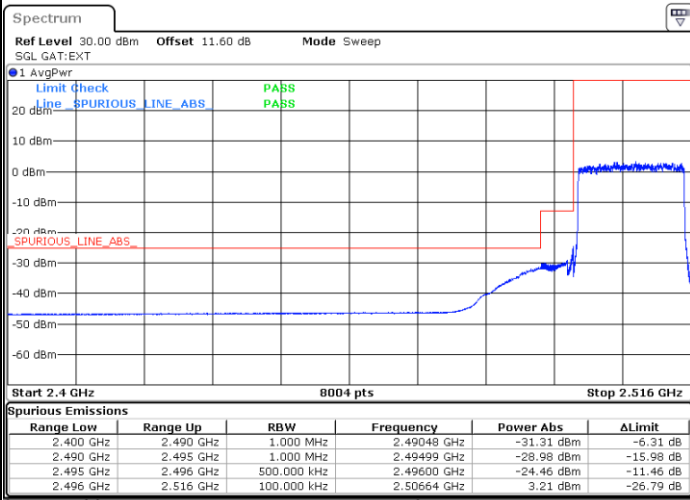

Date: 29.SEP.2020 18:07:08

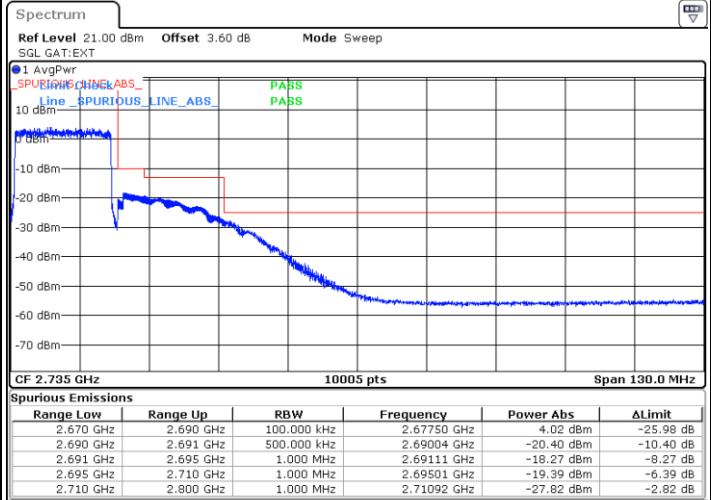

Date: 17.AUG.2020 15:12:26