



HCT.CO., LTD.

Product Compliance Division

TEL : +82 31 639 8518 FAX : +82 31 639 8525

CERTIFICATE OF COMPLIANCE

FCC Part 24 & 22 Permissive change Class II

Applicant Name: Telit Communications S.p.A.	Date of Testing: July. 4, 2008
Address: Viale Stazione di Prosecco 5/b Trieste, 34010 Italy	Test Site/Location: HCT.CO., LTD., San 136-1 Ami-ri, Bubal-eup, Icheon-si, Kyungki-do, Korea
	Test Report No.: HCT-R08-075
	HCT FRN: 0005866421

FCC ID : RI7CC864-DUAL

APPLICANT : Telit Communications S.p.A.

Application Type:	Permissive change Class II
Change of contents	Additional GPS LNA/Filter
FCC Classification:	PCS Licensed Transmitter worn on body(PCT)
FCC Rule Part(s):	§22, §24, §2
IC Standard(s)	RSS-132 - Issue 2, September 2005, RSS-133 - Issue 4, February 2008
EUT Type:	Dual-Band CDMA Module/GPS
Model(s):	CC864-DUAL
Tx Frequency:	824.70 — 848.31 MHz (CDMA) 1 851.25 — 1 908.75 MHz (PCS CDMA)
Rx Frequency:	869.70 — 893.31 MHz (CDMA) 1 931.25 — 1 988.75 MHz (PCS CDMA)
Max. RF Output Power:	0.303 W ERP CDMA (24.82 dBm) / 0.151 W EIRP PCS CDMA (21.80 dBm)
Emission Designator(s):	1M28F9W (CDMA), 1M28F9W (PCS CDMA)

The measurements shown in this report were made in accordance with the procedures specified in §2.947. I assume full responsibility for the accuracy and completeness of these measurements, and for the qualifications of all persons taking them.

HCT.CO., LTD. Certifies that no party to this application has been denied FCC benefits pursuant to section 5301 of the Anti-Drug Abuse Act of 1998,21 U.S. C.853(a)

Report prepared by
: Youn Seok Jung
Test engineer of RF Part

Approved by
: Sang Jun Lee
Manager of RF Part

This report only responds to the tested sample and may not be reproduced, except in full, without written approval of the HCT Co., Ltd.

FCC Permissive change Class II				www.hct.co.kr
Test Report No. HCT-R08-075	Test Dates: July 04, 2008	EUT Type: Dual-Band CDMA Module/GPS	FCC ID: RI7CC864-DUAL	Page 1 of 27



Table of Contents

1. GENERAL INFORMATION	3
2. INTRODUCTION	4
2.1. EUT DESCRIPTION.....	4
2.2. MEASURING INSTRUMENT CALIBRATION.....	4
2.3. TEST FACILITY	4
3. DESCRIPTION OF TESTS	5
3.1 Effective Radiated Power/Equivalent Isotropic Radiated Power.....	5
3.2 Occupied bandwidth.	6
3.3 Spurious and Harmonic Emissions at Antenna Terminal.....	6
3.4 Radiated Spurious and Harmonic Emissions	7
3.5 Frequency stability / variation of ambient temperature	8
5. SUMMARY OF TEST RESULTS	1 0
6. SAMPLE CALCULATION.....	1 1
7. TEST DATA	1 2
7.1 Conducted Output Power	1 2
7.2 Effective Radiated Power Output(CDMA)	1 3
7.3 Equivalent Isotropic Radiated Power (E.I.R.P.) (PCS CDMA)	1 4
7.4 Radiated Spurious Emissions(CDMA Mode).....	1 5
7.5 Radiated Spurious Emissions(PCS CDMA Mode)	1 6
7.6 Frequency stability / variation of ambient temperature	1 7
7.6.1 FREQUENCY STABILITY (CDMA).....	1 7
7.6.2 FREQUENCY STABILITY (PCS CDMA)	1 8
8. TEST PLOTS.....	1 9



MEASUREMENT REPORT

1. GENERAL INFORMATION

Applicant Name: Telit Communications S.p.A.

Address: Viale Stazione di Prosecco 5/b Trieste, 34010 Italy

Contact: Ho Gyun Shin
Tel. / Fax : +82-2-368-4642 / +82-2-368-4666
E-Mail : Hogyun.Shin@telit.com

FCC ID: RI7CC864-DUAL

Application Type: Permissive change Class II

FCC Classification: PCS Licensed Transmitter worn on body(PCT)

FCC Rule Part(s): §22, §24, §2

IC Standard(s) RSS-132 - Issue 2, September 2005, RSS-133 - Issue 4, February 2008

EUT Type: Dual-Band CDMA Module/GPS

Model(s): CCC864-DUAL

Tx Frequency: 824.70 — 848.31 MHz (CDMA)
1 851.25 — 1 908.75 MHz (PCS CDMA)

Rx Frequency: 869.70 — 893.31 MHz (CDMA)
1 931.25 — 1 988.75 MHz (PCS CDMA)

Max. RF Output Power: 0.303 W ERP CDMA (24.82 dBm) / 0.151 W EIRP PCS CDMA (21.80 dBm)

Emission Designator(s): 1M28F9W (CDMA), 1M28F9W (PCS CDMA)

Antenna Specification Manufacturer: HANWOOL TECHNOLOGY
Model: HW -3BM - SMA (Length = 85.0 ± 2.0 mm)
Antenna type: OMNI - DIRECTIONAL

Date(s) of Tests: July. 04, 2008

Place of Tests: HCT.CO., LTD.
San 136-1 Ami-ri, Bubal-eup, Icheon-si,

Report Serial No HCT-R08-075

FCC Permissive change Class II				www.hct.co.kr
Test Report No. HCT-R08-075	Test Dates: July 04.2008	EUT Type: Dual-Band CDMA Module/GPS	FCC ID: RI7CC864-DUAL	Page 3 of 27



2. INTRODUCTION

2.1. EUT DESCRIPTION

The Telit CC864-DUAL, Dual-Band CDMA Module/GPS consists of CDMA (Tx: 824.70 MHz ~ 848.31 MHz, Rx: 869.70 MHz ~ 893.31 MHz) and PCS CDMA (Tx: 1 851.25 MHz ~ 1 908.75 MHz, Rx: 1 931.25 MHz ~ 1 988.75 MHz)

2.2. MEASURING INSTRUMENT CALIBRATION

The measuring equipment, which was utilized in performing the tests documented herein, has been calibrated in accordance with the manufacturer's recommendations for utilizing calibration equipment, which is traceable to recognized national standards.

2.3. TEST FACILITY

The open area test site and conducted measurement facility used to collect the radiated data are located at the 254-1, Maekok-Ri, Hobup-Myun, Ichon-Si, Kyoungki-Do, 467-701, KOREA. The site is constructed in conformance with the requirements of ANSI C63.4 and CISPR Publication 22. Detailed description of test facility was submitted to the Commission and accepted dated July 6, 2006(Registration Number: 90661)

FCC Permissive change Class II				www.hct.co.kr
Test Report No. HCT-R08-075	Test Dates: July 04.2008	EUT Type: Dual-Band CDMA Module/GPS	FCC ID: R17CC864-DUAL	Page 4 of 27

3. DESCRIPTION OF TESTS

3.1 Effective Radiated Power/Equivalent Isotropic Radiated Power

Test Set-up

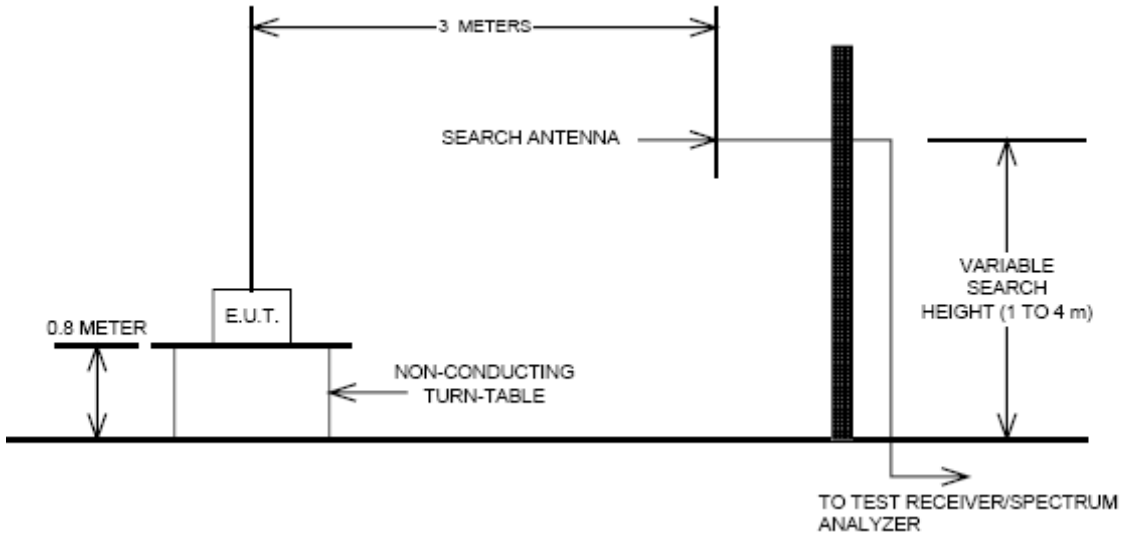

Test Procedure

Radiated emission measurements were performed at an open Site.

The equipment under test is placed on a wooden turntable 3-meters from the receive antenna.

A wooden turntable was rotated 360° and the receiving antenna scanned from 1-4m in order to capture the maximum emission. A half wave dipole was substituted in place of the EUT. This dipole antenna was driven by a signal generator and the previously recorded signal was duplicated.

The maximum EIRP was calculated by adding the forward power to the calibrated source plus its appropriate gain value. These steps were carried out with the receiving antenna in both vertical and horizontal polarization. For readings above 1GHz, the above procedure is repeated using horn antennas and the difference between the gain of the horn and an isotropic antenna are taken into consideration.

3.2 Occupied bandwidth.

Test set-up

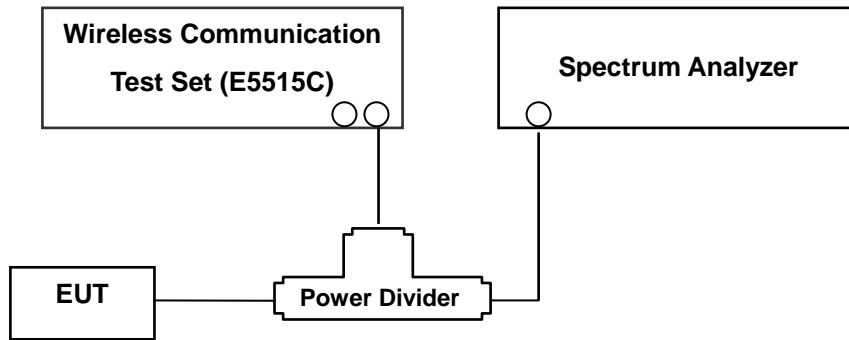

(Configuration of conducted Emission measurement)
Test Procedure

The EUT was setup to maximum output power at its lowest channel. The occupied bandwidth was measured using a spectrum analyzer. The measurements are repeated for the highest and a middle channel. The EUT's occupied bandwidth is measured as the width of the signal between two points, one below the carrier center frequency and one above the carrier frequency, outside of which all emissions are attenuated at least 26 dB below the transmitter power. Plots of the EUT's occupied bandwidth are shown herein.

3.3 Spurious and Harmonic Emissions at Antenna Terminal.

Test Procedure

The level of the carrier and the various conducted spurious and harmonic frequencies is measured by means of a calibrated spectrum analyzer.

The EUT was setup to maximum output power at its lowest channel. The Resolution BW of the analyzer is set to 1 % of the emission bandwidth to show compliance with the – 13 dBm limit, in the 1 MHz bands immediately outside and adjacent to the edge of the frequency block. The 1 MHz RBW was used to scan from 30 MHz to 10 GHz. (PCS CDMA Mode: 30 MHz to 20 GHz). A display line was placed at – 13 dBm to show compliance. The high, lowest and a middle channel were tested for out of band measurements.

3.4 Radiated Spurious and Harmonic Emissions

Test Set-up

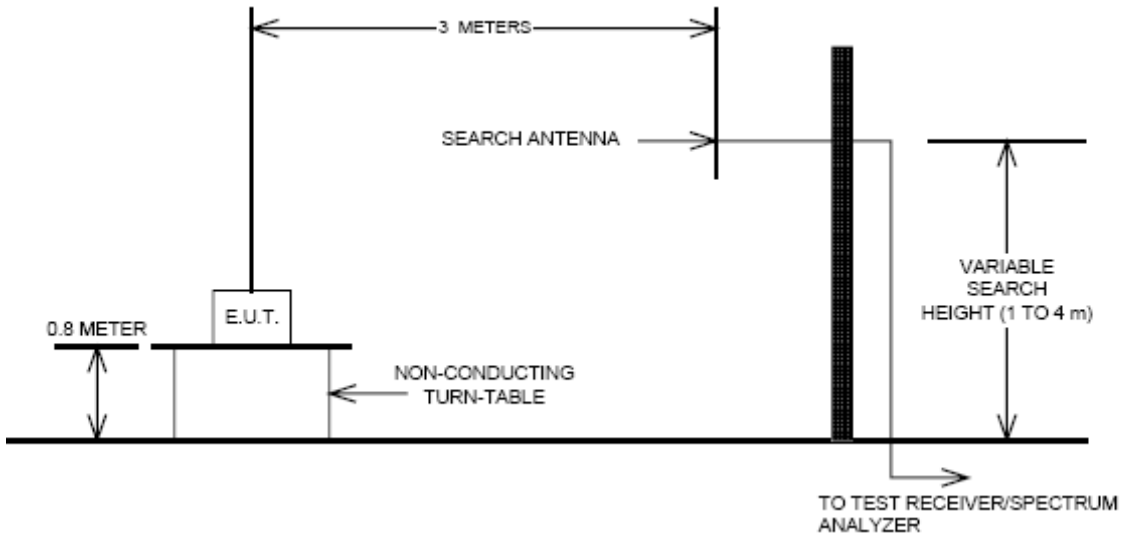

The measurement facilities used for this test have been documented in previous filings with the commission pursuant to section § 2.948. The open field test site is situated in open field with ground screen whose site attenuation characteristics meet ANSI C63.4 –2003. A mast capable of lifting the receiving antenna from a height of one to four meters is used together with a rotatable wooden platform mounted at three from the antenna mast.

- 1) The unit mounted on a wooden table 1.5 m × 1.0 m × 0.80 m is 0.8 meter above test site ground level.
- 2) During the emission test, the turntable is rotated and the EUT is manipulated to find the configuration resulting in maximum emission under normal condition of installation and operation.
- 3) The antenna height and polarization are also varied from 1 to 4 meters until the maximum signal is found.
- 4) The spectrum shall be scanned up to the 10th harmonic of the fundamental frequency.

Test Procedure

The equipment under test is placed on a wooden turntable 3-meters from the receive antenna.

A wooden turntable was rotated 360° and the receiving antenna scanned from 1-4m in order to capture the maximum emission. A half wave dipole was substituted in place of the EUT. This dipole antenna was driven by a signal generator and the previously recorded signal was duplicated.

The maximum EIRP was calculated by adding the forward power to the calibrated source plus its appropriate gain value. These steps were carried out with the receiving antenna in both vertical and horizontal polarization. For readings above 1GHz, the above procedure is repeated using horn antennas and the difference between the gain of the horn and an isotropic antenna are taken into consideration.

3.5 Frequency stability / variation of ambient temperature

Test Set-up

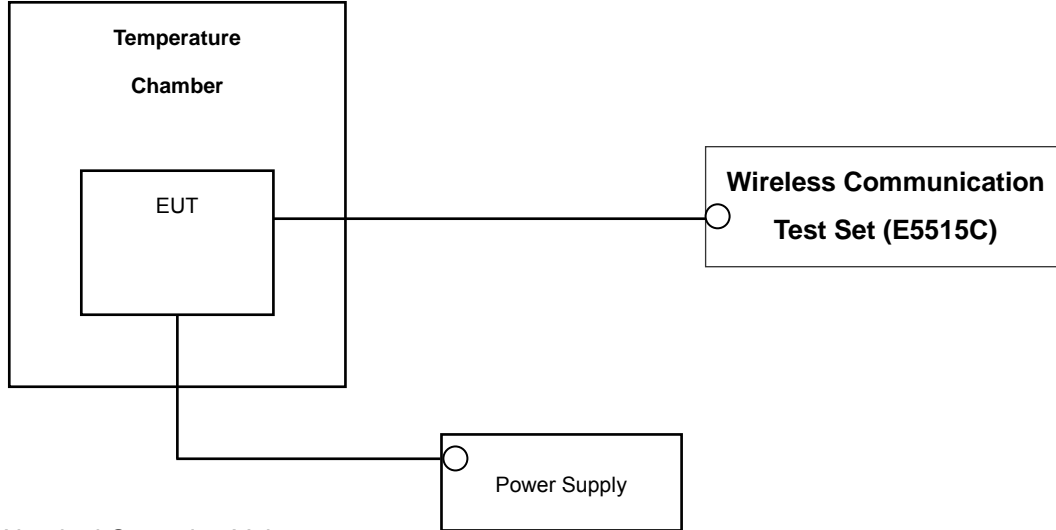

* Nominal Operating Voltage

Test Procedure

The frequency stability of the transmitter is measured by:

- a.) **Temperature:** The temperature is varied from - 30 °C to + 50 °C using an environmental chamber.
- b.) **Primary Supply Voltage:** The primary supply voltage is varied from battery end point to 115 % of the voltage normally at the input to the device or at the power supply terminals if cables are not normally supplied.

Specification — the frequency stability shall be sufficient to ensure that the fundamental emission stays within the authorized frequency block. The frequency stability of the transmitter shall be maintained within $\pm 0.00025\%$ (± 2.5 ppm) of the center frequency.

Time Period and Procedure:

The carrier frequency of the transmitter is measured at room temperature (20°C to provide a reference).

1. The equipment is turned on in a “standby” condition for one minute before applying power to the transmitter. Measurement of the carrier frequency of the transmitter is made within one minute after applying power to the transmitter.
2. Frequency measurements are made at 10°C intervals ranging from -30°C to +50°C. A period of at least one half-hour is provided to allow stabilization of the equipment at each temperature level.



4. LIST OF TEST EQUIPMENT

Manufacture	Model/ Equipment	Serial Number	Calibration Interval	Calibration Due
R&S	ESI40/ Spectrum Analyzer	831564/003	Annual	11/06/2008
Agilent	E4419B/ Power Meter	MY41291386	Annual	11/05/2008
Agilent	8481A/ Power Sensor	MY41090870	Annual	11/05/2008
Agilent	HP8901B/ Modulation Analyzer	3438A05231	Annual	08/04/2008
Agilent	8903A/ Audio Analyzer	2433A04322	Annual	08/04/2008
R&S	CMU200/ Base Station	110740	Annual	07/26/2008
Agilent	8960 (E5515C)/ Base Station	GB4444400269	Annual	02/11/2009
Tescom	TC-3000/ Bluetooth Simulator	3000A4900112	Annual	01/11/2009
MITEQ	AMF-60-0010 1800-35-20P / AMP	1200937	Annual	01/15/2009
Wainwright	WHK1.2/15G-10EF/H.P.F	2	Annual	07/28/2008
Wainwright	WHK3.3/18G-10EF/H.P.F	1	Annual	07/28/2008
Agilent	778D/ Dual Directional Coupler	16072	Annual	11/09/2008
Agilent	1506A/ Power Divider	99441	Annual	11/10/2008
Digital	EP-3010/ Power Supply	3110117	Annual	12/29/2008
Schwarzbeck	UHAP/ Dipole Antenna	630	Annual	11/13/2008
Schwarzbeck	UHAP/ Dipole Antenna	605	Annual	11/13/2008
R&S	HFH2-Z2/ Loop Antenna	881056/070	Annual	12/11/2008
Korea Engineering	KR-1005L / Chamber	KRAB07063-2CH	Annual	01/05/2009
Schwarzbeck	VULB9160/ TRILOG Antenna	3150	Biennial	04/20/2009
Schwarzbeck	VULB9160/ TRILOG Antenna	3125	Biennial	05/16/2009
Schwarzbeck	BBHA 9120D/ Horn Antenna	147	Biennial	03/26/2010
Schwarzbeck	BBHA 9120D/ Horn Antenna	1201	Biennial	05/02/2009
Agilent	E4440A/Spectrum Analyzer	US45303008	Annual	01/08/2009



5. SUMMARY OF TEST RESULTS

FCC Part Section(s)	Test Description	Test Limit	Test Condition	Test Result
2.1049, 22.917(a), 24.238(a) RSS 132, Section 4.2 RSS 133, Section 6.5	Occupied Bandwidth	N/A	CONDUCTED	PASS
2.1051, 22.917(a), 24.238(a) RSS 132, Section 6.5 RSS 132, Section 4.5 and 6.5 RSS 133, Section 4.4 RSS 133, Section 6.5	Band Edge / Spurious and Harmonic Emissions at Antenna Terminal.	$< 43 + \log_{10}(P[\text{Watts}])$ at Band Edge and for all out-of-band emissions		PASS
2.1046 RSS 132, Section 4.4 and 6.4 RSS 133, Section 4.3	Conducted Output Power	N/A		PASS
2.1055, 22.355, 24.235 RSS 132, Section 4.3 and 6.3 RSS 133, Section 4.2	Frequency stability / variation of ambient temperature	< 2.5 ppm		PASS
22.913(a)(2) 24.232(c) RSS 132, Section 4.4 and 6.4 RSS 133, Section 4.3	Effective Radiated Power	< 7 Watts max. ERP	RADIATED	PASS
	Equivalent Isotropic Radiated Power	< 2 Watts max. EIRP		PASS
2.1053, 22.917(a), 24.238(a) RSS 132, Section 4.5 and 6.5 RSS 133, Section 4.4	Radiated Spurious and Harmonic Emissions	$< 43 + \log_{10}(P[\text{Watts}])$ for all out-of band emissions		PASS



6. SAMPLE CALCULATION

A. ERP Sample Calculation

Mode	Ch./ Freq.		Measured Level(dBm)	Substitute LEVEL(dBm)	Ant. Gain	C.L	Pol.	ERP	
	channel	Freq.(MHz)						W	dBm
CDMA	384	836.52	-13.03	22.74	2.50	1.19	H	0.25	24.05

ERP = SubstituteLEVEL(dBm) + Ant. Gain – CL(Cable Loss)

- 1) The EUT mounted on a wooden tripod is 0.8 meter above test site ground level.
- 2) During the test , the turn table is rotated and the antenna height is also varied from 1 to 4 meters until the maximum signal is found.
- 3) Record the field strength meter's level.
- 4) Replace the EUT with dipole/Horn antenna that is connected to a calibrated signal generator.
- 5) Increase the signal generator output till the field strength meter's level is equal to the item (3).
- 6) The signal generator output level with Ant. Gain and cable loss are the rating of effective radiated power (ERP).

B. Emission Designator

CDMA Emission Designator

Emission Designator = 1M29F9W

CDMA BW = 1.29 MHz

F = Frequency Modulation

9 = Composite Digital Info

W = Combination (Audio/Data)

(Measured at the 99% power bandwidth)

7. TEST DATA

7.1 Conducted Output Power

A base station simulator was used to establish communication with the EUT. The base station simulator parameters were set to produce the maximum power from the EUT. This device was tested under all configurations and the highest power is reported. Conducted Output Powers of EUT are reported below.

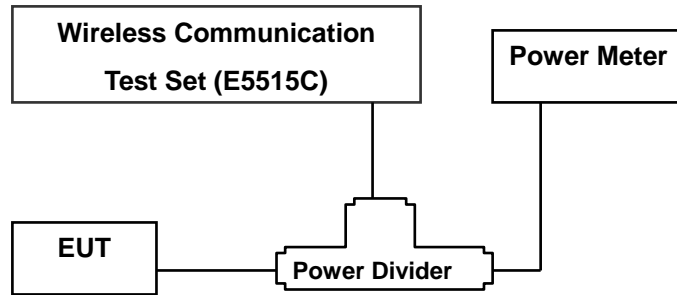

Band	Channel	SO2	SO2	SO55	SO55	TDSO
		RC1/1 (dBm)	RC3/3 (dBm)	RC1/1 (dBm)	RC3/3 (dBm)	RC3/3 (dBm)
CDMA	1013	24.49	24.57	24.54	24.60	24.67
	384	24.62	24.82	24.60	24.66	24.75
	777	24.28	24.28	24.22	24.35	24.45
PCS	25	24.75	24.77	24.69	24.74	24.85
	600	24.41	24.50	24.46	24.43	24.71
	1175	24.37	24.51	24.42	24.39	24.59

(Maximum Conducted Output Powers)



7.2 Effective Radiated Power Output(CDMA)

(CDMA Mode)

Ch./ Freq.		Measured Level(dBm)	Substitute LEVEL (dBm)	Ant. Gain	C.L	Pol.	ERP	
channel	Freq.(MHz)						W	dBm
1013	824.70	-11.75	23.58	2.19	1.17	H	0.29	24.60
384	836.52	-13.03	22.74	2.50	1.19	H	0.25	24.05
777	848.31	-12.98	23.19	2.83	1.20	H	0.30	24.82

NOTES: Effective Radiated Power Output Measurements by Substitution Method
according to ANSI/TIA/EIA-603-C-2004, Aug. 17, 2004:

The EUT was placed on a wooden turn table 3-meters from the receive antenna. The receive antenna height and turntable rotation was adjusted for the highest reading on the receive spectrum analyzer. For CDMA signals, a peak detector is used, with RBW = VBW = 3 MHz. For WCDMA signals, a peak detector is used, with RBW = VBW = 5MHz. For AMPS, GSM, and NADC TDMA signals, a peak detector is used, with RBW = VBW = 1 MHz. A half-wave dipole was substituted in place of the EUT. This dipole antenna was driven by a signal generator and the level of the signal generator was adjusted to obtain the same receive spectrum analyzer reading. The conducted power at the terminals of the dipole is measured and the ERP is recorded. This device was tested under all configurations and the highest power is reported.



7.3 Equivalent Isotropic Radiated Power (E.I.R.P.) (PCS CDMA)

(PCS CDMA Mode)

Ch./ Freq.		Measured Level(dBm)	Substitute LEVEL (dBm)	Ant. Gain	C.L	Pol.	EIRP	
channel	Freq.(MHz)						W	dBm
25	1,851.25	-18.23	13.38	10.05	1.91	H	0.14	21.51
600	1,880.00	-18.89	12.93	10.05	1.95	H	0.13	21.03
1175	1,908.75	-18.19	13.71	10.06	1.97	H	0.15	21.80

NOTES: Equivalent Isotropic Radiated Power Measurements by Substitution Method according to ANSI/TIA/EIA-603-C-2004, Aug. 17, 2004:

The EUT was placed on a wooden turn table 3-meters from the receive antenna. The receive antenna height and turntable rotation was adjusted for the highest reading on the receive spectrum analyzer. For CDMA signals, a peak detector is used, with RBW = VBW = 3 MHz. For WCDMA signals, a peak detector is used, with RBW = VBW = 5MHz. For AMPS, GSM, and NADC TDMA signals, a peak detector is used, with RBW = VBW = 1 MHz. A Horn antenna was substituted in place of the EUT. This Horn antenna was driven by a signal generator and the level of the signal generator was adjusted to obtain the same receive spectrum analyzer reading. The conducted power at the terminals of the Horn antenna is measured. The difference between the gain of the horn and an isotropic antenna is taken into consideration and the EIRP is recorded.

This device was tested under all configurations and the highest power is reported.



7.4 Radiated Spurious Emissions(CDMA Mode)

- MEASURED OUTPUT POWER: 24.82 dBm = 0.303 W
- MODULATION SIGNAL: CDMA
- DISTANCE: 3 meters
- LIMIT: - (43 + 10 log₁₀ (W)) = -37.82 dBc

Ch.	Freq.(MHz)	Measured Level [dBm]	Ant. Gain	Substitute Level [dBm]	C.L	Pol.	ERP (dBm)	dBc
1013	1,649.40	-32.79	7.09	-43.32	1.73	H	-37.96	-62.78
	2,474.10	-44.91	8.12	-52.02	2.28	H	-46.18	-71.00
	3,298.80	-43.28	9.72	-50.86	2.57	H	-43.71	-68.53
384	1,673.04	-33.81	7.23	-44.57	1.79	H	-39.13	-63.95
	2,509.56	-43.21	8.14	-50.34	2.33	H	-44.53	-69.35
	3,346.08	-40.91	9.99	-48.94	2.66	H	-41.61	-66.43
777	1,696.62	-34.60	7.41	-45.21	1.83	H	-39.63	-64.45
	2,544.93	-45.43	8.21	-52.71	2.34	H	-46.84	-71.66
	3,393.24	-42.39	9.91	-50.02	2.85	H	-42.96	-67.78

NOTES: Radiated Spurious Emission Measurements at 3 meters by Substitution Method
according to ANSI/TIA/EIA-603-C-2004, Aug. 17, 2004:



7.5 Radiated Spurious Emissions(PCS CDMA Mode)

- MEASURED OUTPUT POWER: 21.80 dBm = 0.151 W
- MODULATION SIGNAL: PCS CDMA
- DISTANCE: 3 meters
- LIMIT: - (43 + 10 log₁₀(W)) = - 34.80 dBc

Ch.	Freq.(MHz)	Measured Level [dBm]	Ant. Gain	Substitute Level [dBm]	C.L	Pol.	ERP (dBm)	dBc
25	3,702.50	-38.67	10.31	-44.94	2.73	H	-37.36	-59.16
	5,553.75	-43.34	10.55	-44.92	3.60	H	-37.97	-59.77
	7,405.00	-37.80	9.21	-28.92	3.88	H	-23.59	-45.39
600	3,760.00	-38.50	10.32	-44.47	2.73	H	-36.88	-58.68
	5,640.00	-41.96	10.60	-43.61	3.60	H	-36.61	-58.41
	7,520.00	-36.76	9.18	-27.66	3.88	H	-22.36	-44.16
1175	3,817.50	-30.62	10.34	-36.50	2.73	H	-28.89	-50.69
	5,726.25	-42.91	10.65	-44.22	3.60	H	-37.17	-58.97
	7,635.00	-34.96	9.15	-25.63	3.88	H	-20.36	-42.16

NOTES: Radiated Spurious Emission Measurements at 3 meters by Substitution Method
according to ANSI/TIA/EIA-603-C-2004, Aug. 17, 2004:



7.6 Frequency stability / variation of ambient temperature

7.6.1 FREQUENCY STABILITY (CDMA)

OPERATING FREQUENCY: 836,520,000 Hz
 CHANNEL: 384
 REFERENCE VOLTAGE: 3.8 VDC
 DEVIATION LIM IT: ± 0.000 25 % or 2.5 ppm

Voltage (%)	Power (VDC)	Temp. (°C)	Frequency (Hz)	Frequency Error (Hz)	Deviation (%)	ppm
100%	3.800	+20(Ref)	836 520 037	37	0.000 004	0.044
100%		-30	836 520 025	25	0.000 003	0.030
100%		-20	836 519 982	-18	-0.000 002	-0.022
100%		-10	836 519 979	-21	-0.000 003	-0.025
100%		0	836 520 026	26	0.000 003	0.031
100%		+10	836 520 019	19	0.000 002	0.023
100%		+20	836 520 034	34	0.000 004	0.041
100%		+30	836 520 042	42	0.000 005	0.050
100%		+40	836 519 969	-31	-0.000 004	-0.037
100%		+50	836 520 029	29	0.000 003	0.035
115%	4.370	+20	836 519 975	-25	-0.000 003	-0.030
85%	3.230	+20	836 519 977	-23	-0.000 003	-0.027

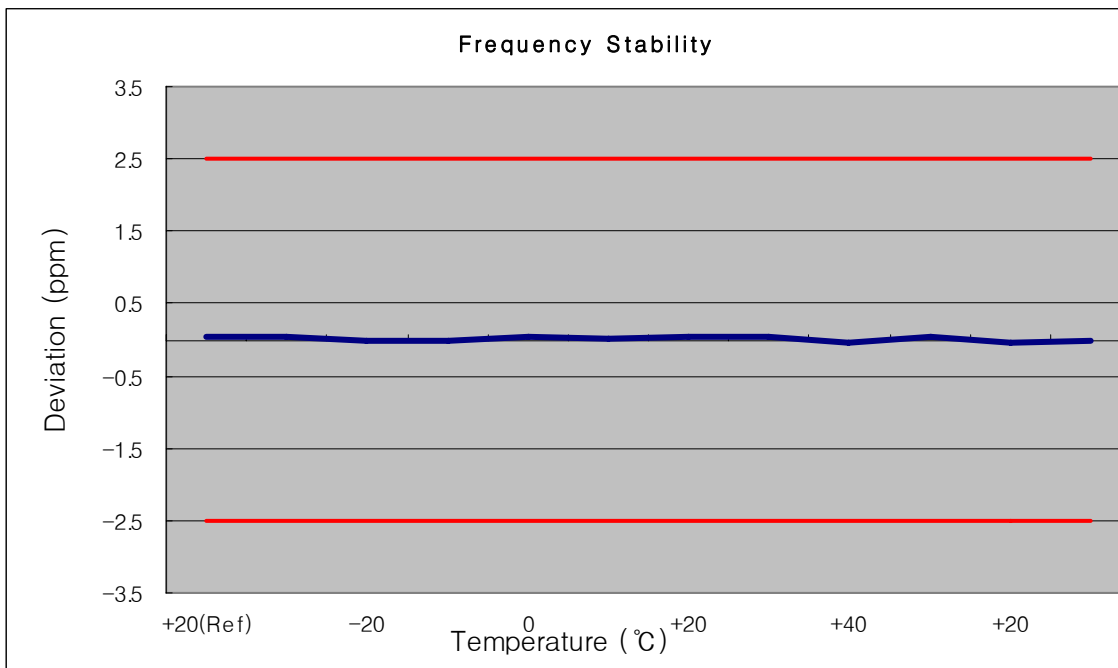



7.6.2 FREQUENCY STABILITY (PCS CDMA)

OPERATING FREQUENCY: 1880,000,000 Hz
 CHANNEL: 600
 REFERENCE VOLTAGE: 3.8 VDC
 DEVIATION LIM IT: ± 0.000 25 % or 2.5 ppm

Voltage (%)	Power (VDC)	Temp. (°C)	Frequency (Hz)	Frequency Error (Hz)	Deviation (%)	ppm
100%	3.800	+20(Ref)	1880 000 044	44	0.000 002	0.023
100%		-30	1879 999 975	-25	-0.000 001	-0.013
100%		-20	1880 000 037	37	0.000 002	0.020
100%		-10	1880 000 032	32	0.000 002	0.017
100%		0	1880 000 036	36	0.000 002	0.019
100%		+10	1880 000 041	41	0.000 002	0.022
100%		+20	1880 000 029	29	0.000 002	0.015
100%		+30	1880 000 024	24	0.000 001	0.013
100%		+40	1879 999 981	-19	-0.000 001	-0.010
100%		+50	1879 999 982	-18	-0.000 001	-0.010
115%	4.370	+20	1880 000 023	23	0.000 001	0.012
85%	3.230	+20	1879 999 973	-27	-0.000 001	-0.014

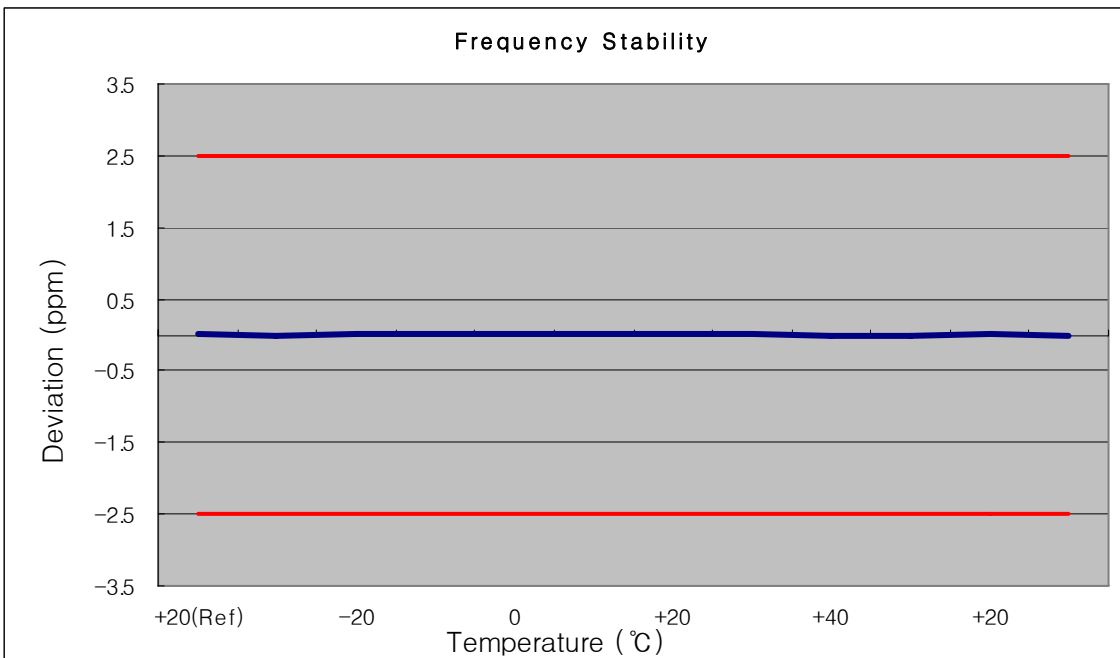



8. TEST PLOTS

FCC Permissive change Class II				www.hct.co.kr
Test Report No. HCT-R08-075	Test Dates: July 04.2008	EUT Type: Dual-Band CDMA Module/GPS	FCC ID: R17CC864-DUAL	Page 19 of 27



■ CDMA MODE (1013 CH.) Occupied Bandwidth

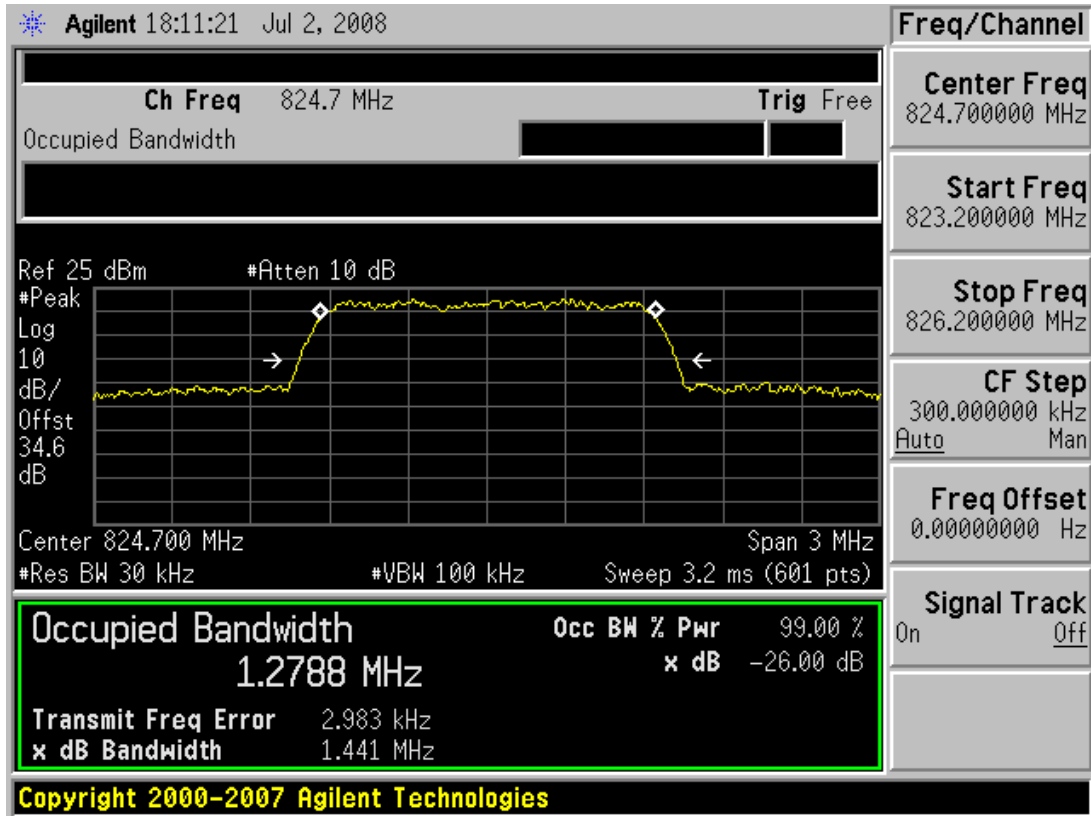

■ CDMA MODE (384 CH.) Occupied Bandwidth

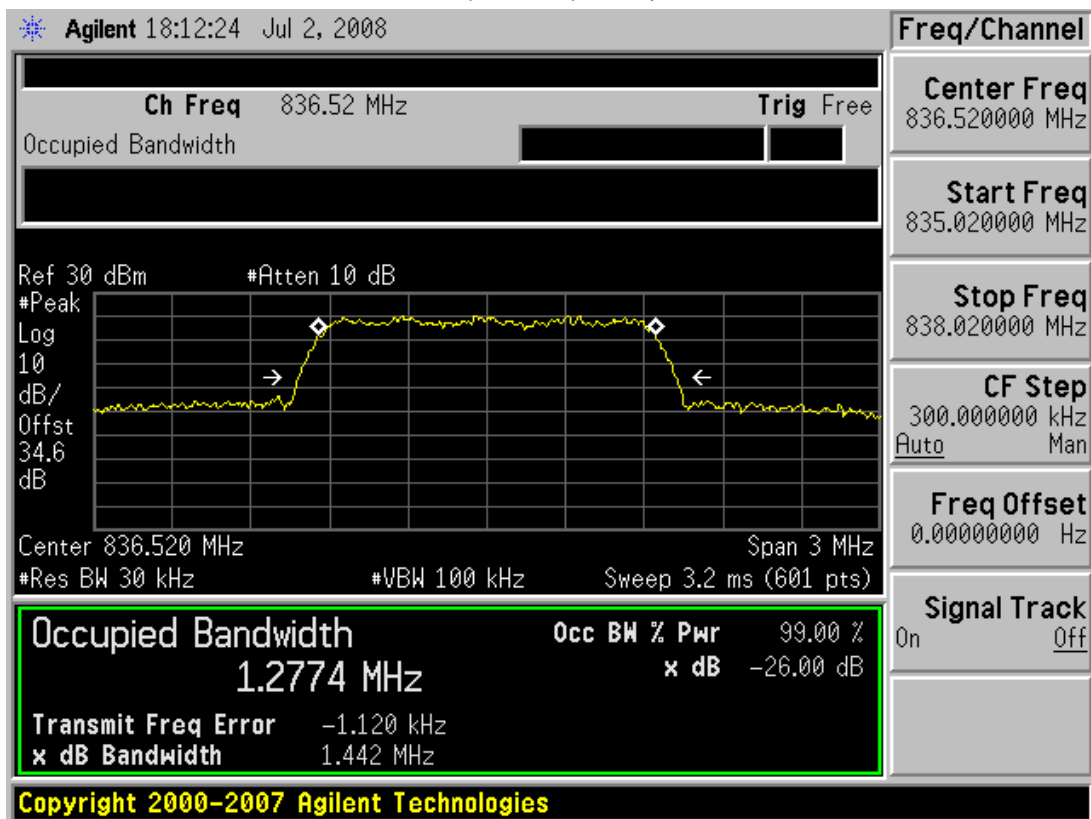



■ CDMA MODE (777 CH.) Occupied Bandwidth

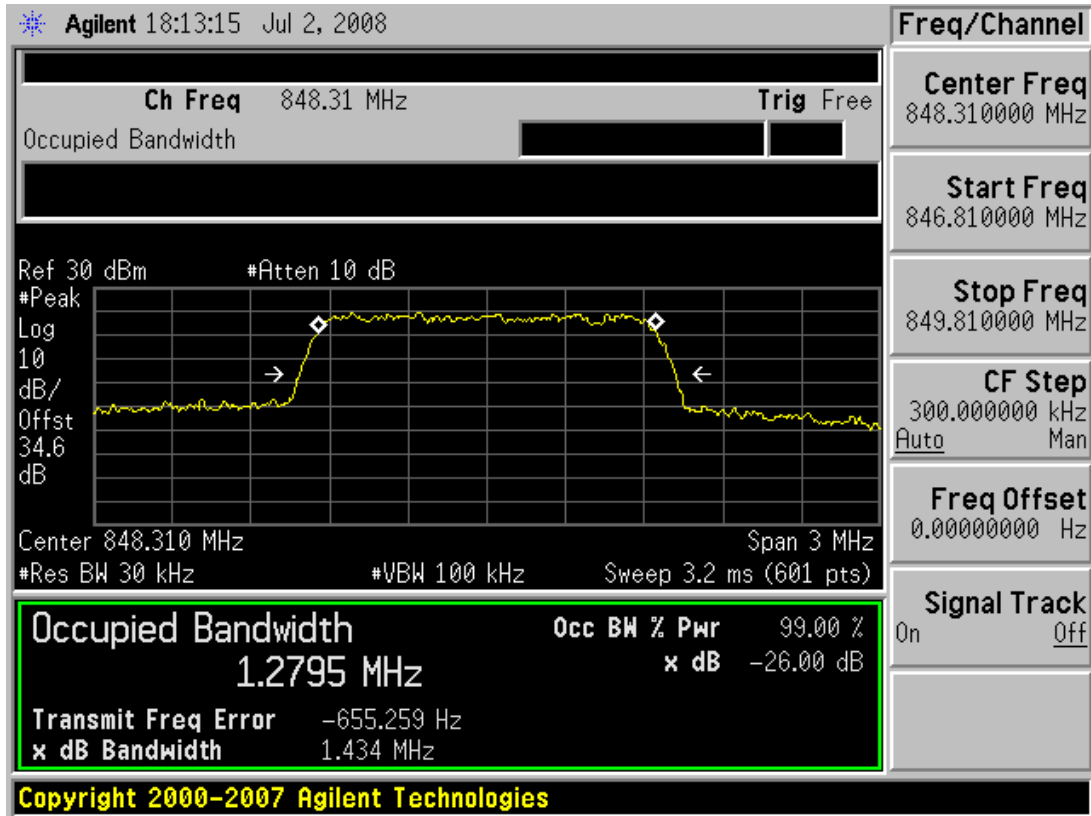

■ PCS CDMA MODE (25 CH.) Occupied Bandwidth

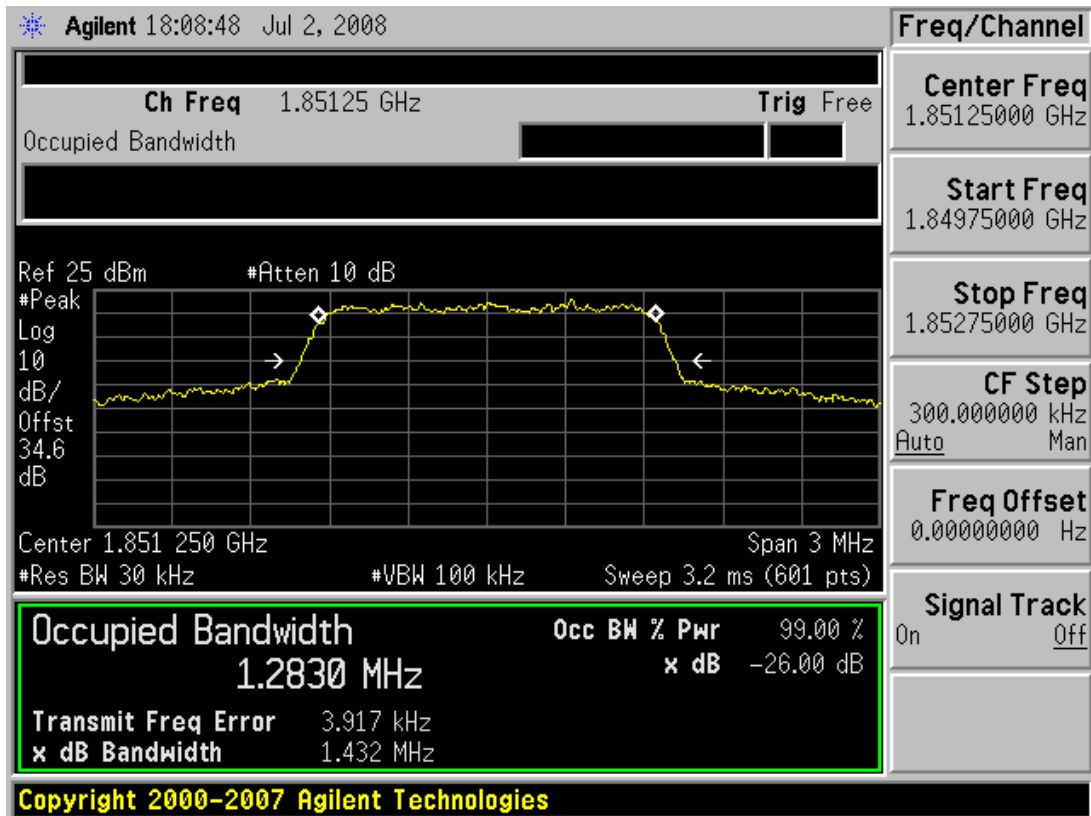

■ PCS CDMA MODE (600 CH.) Occupied Bandwidth

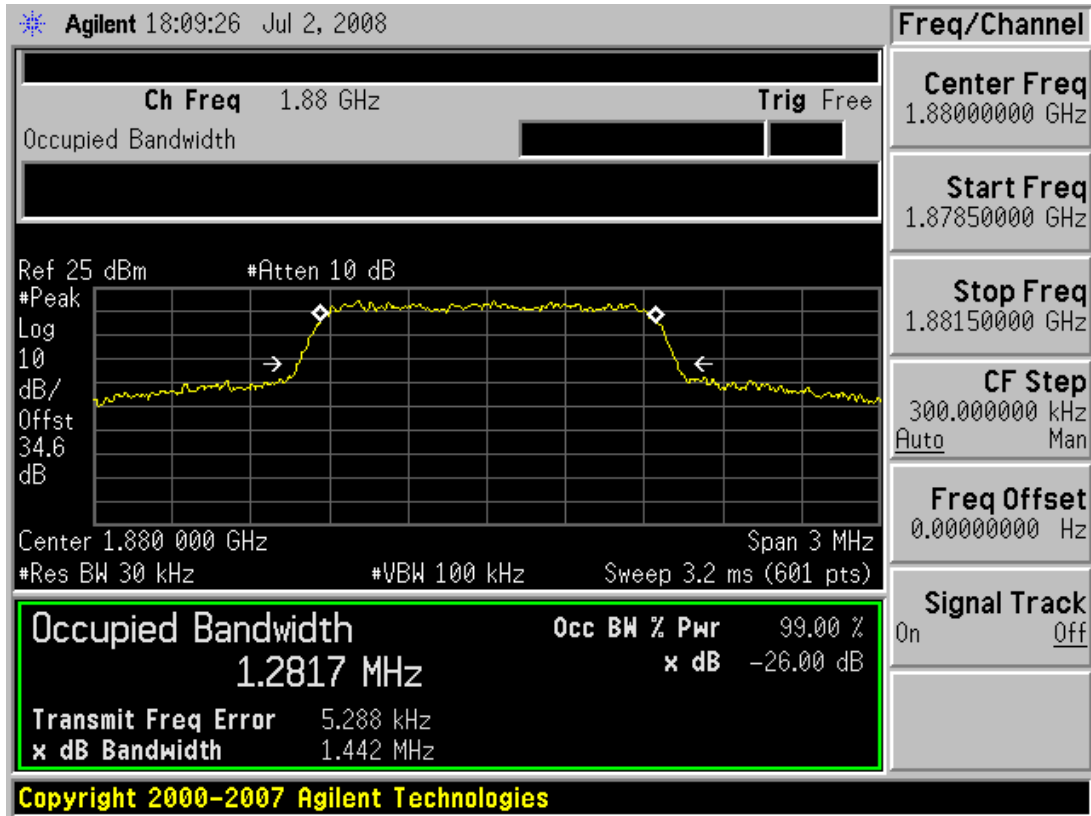

■ PCS CDMA MODE (1175 CH.) Occupied Bandwidth

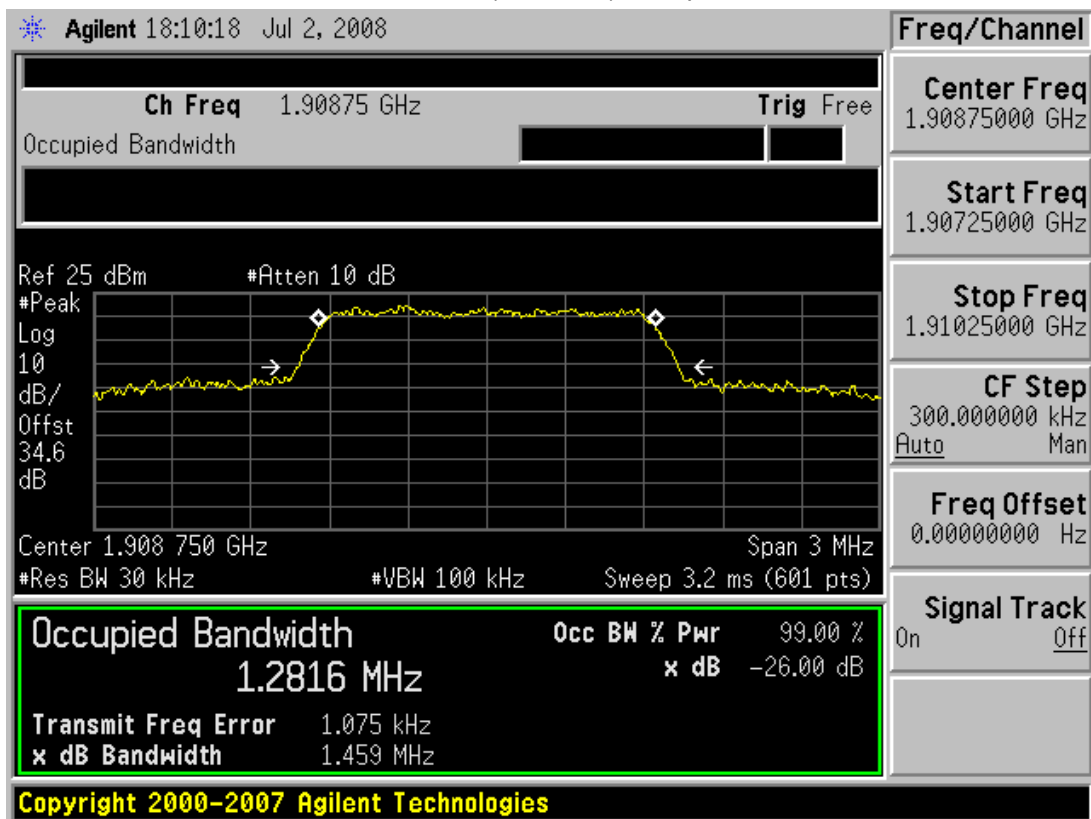

■ CDMA MODE (1013 CH.) Block Edge

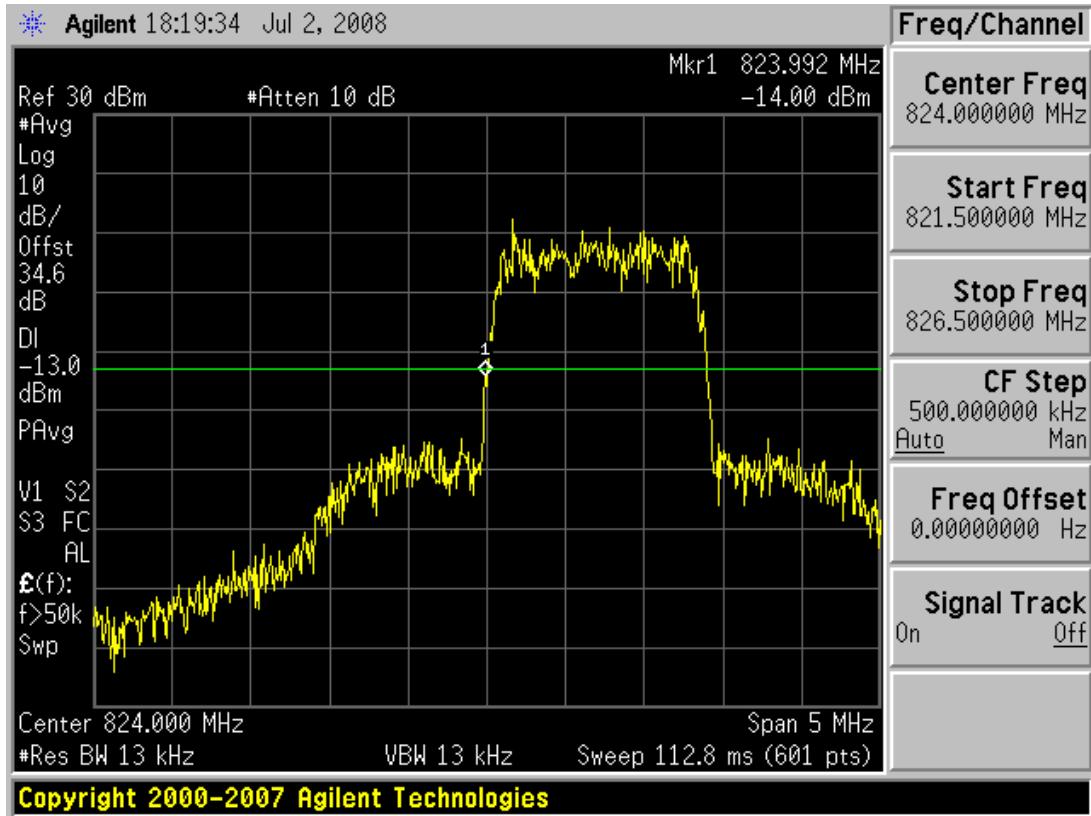

■ CDMA MODE (777 CH.) Block Edge

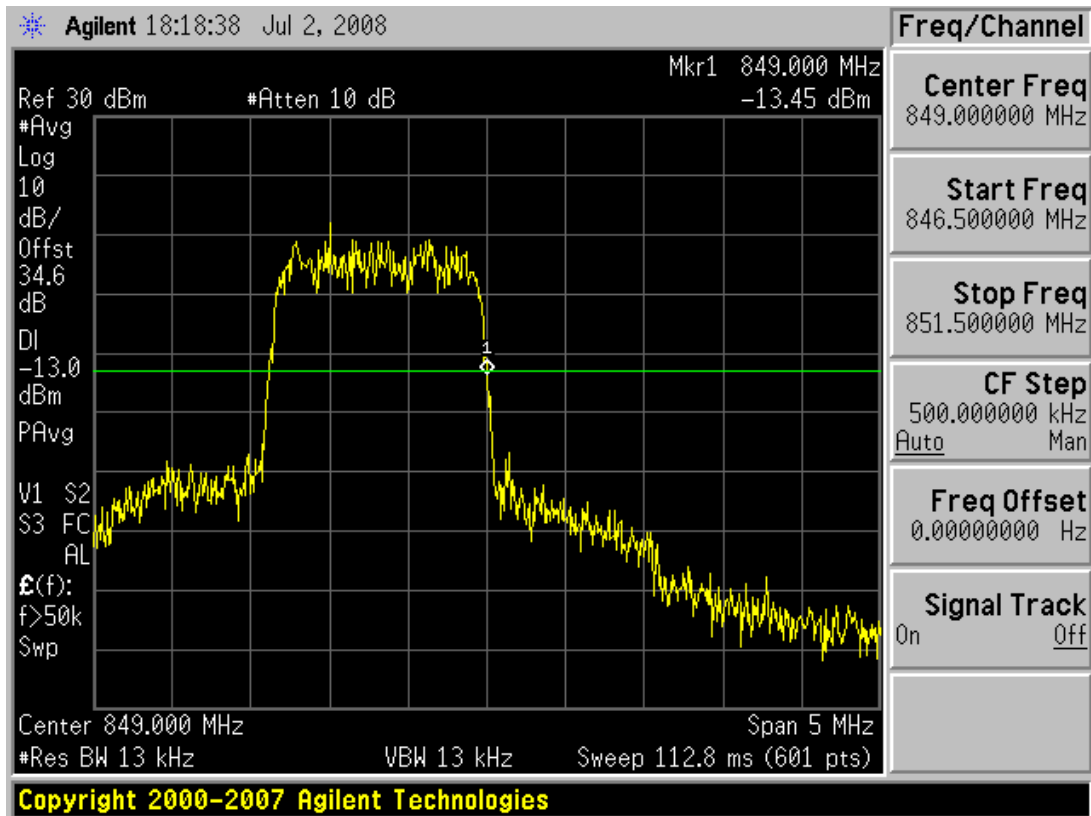

■ PCS CDMA MODE (25 CH.) Block Edge

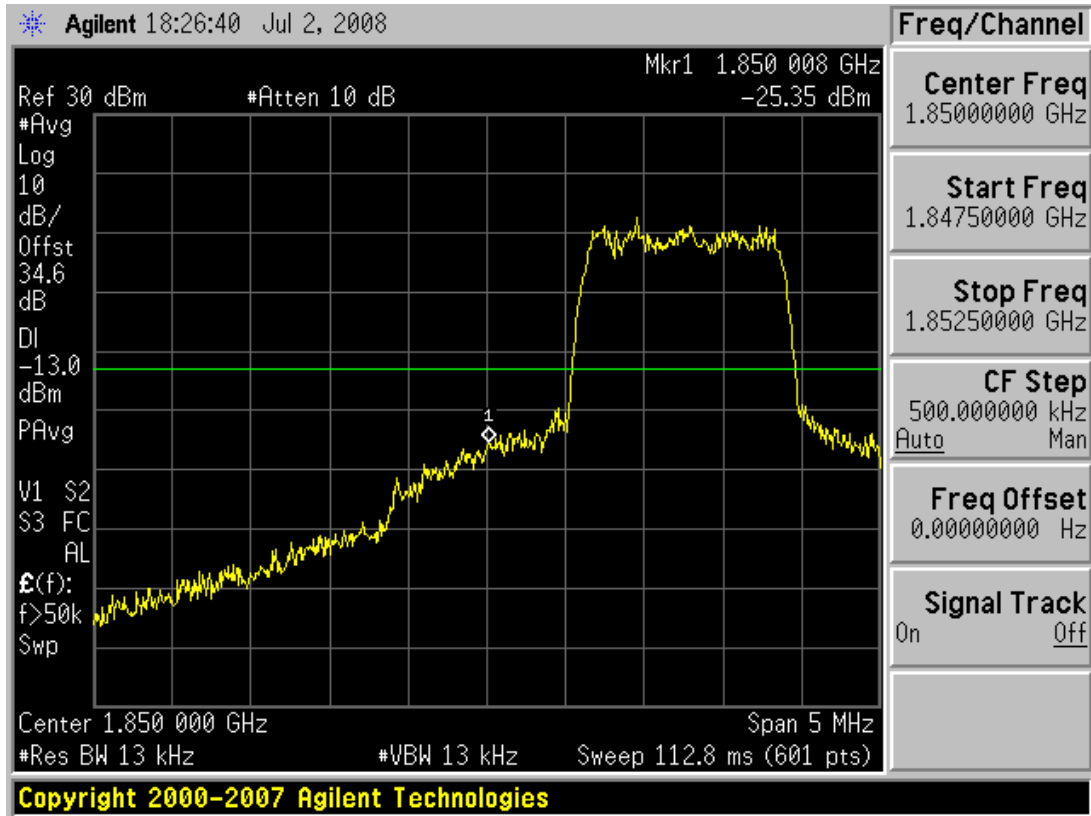

■ PCS CDMA MODE (1175 CH.) Block Edge





■ CDMA MODE (1013 CH.) Conducted Spurious Emissions

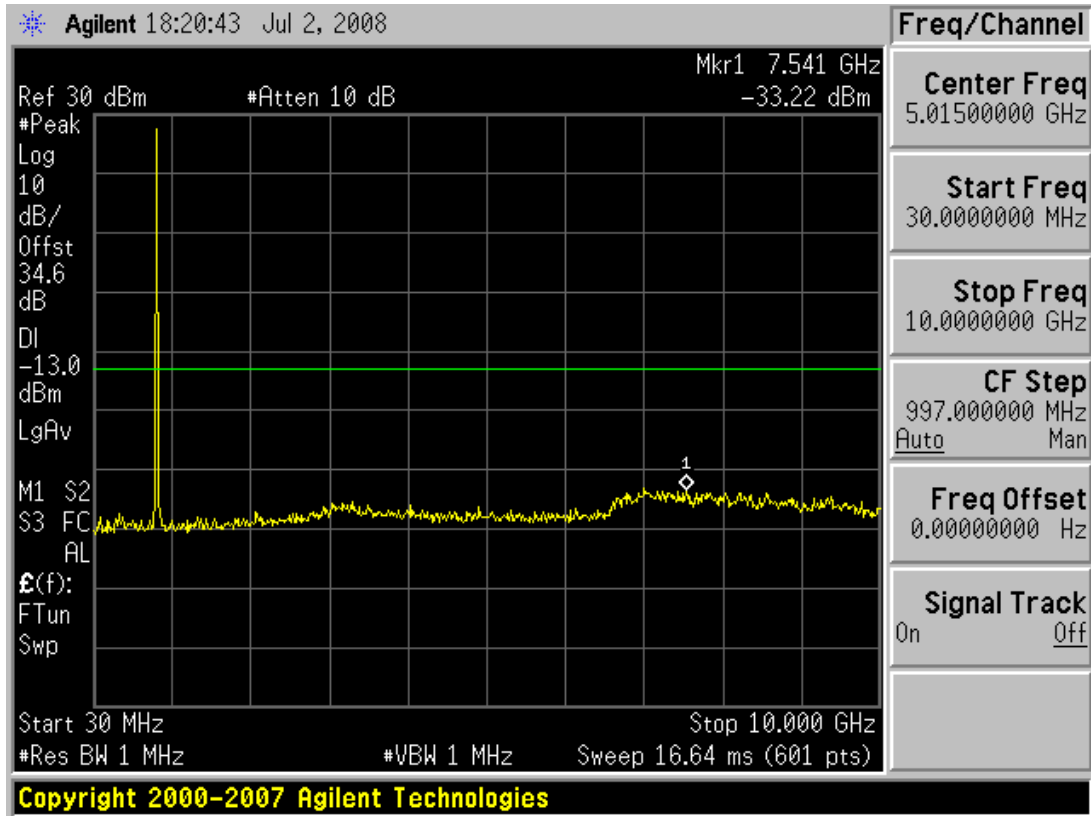

■ CDMA MODE (384 CH.) Conducted Spurious Emissions

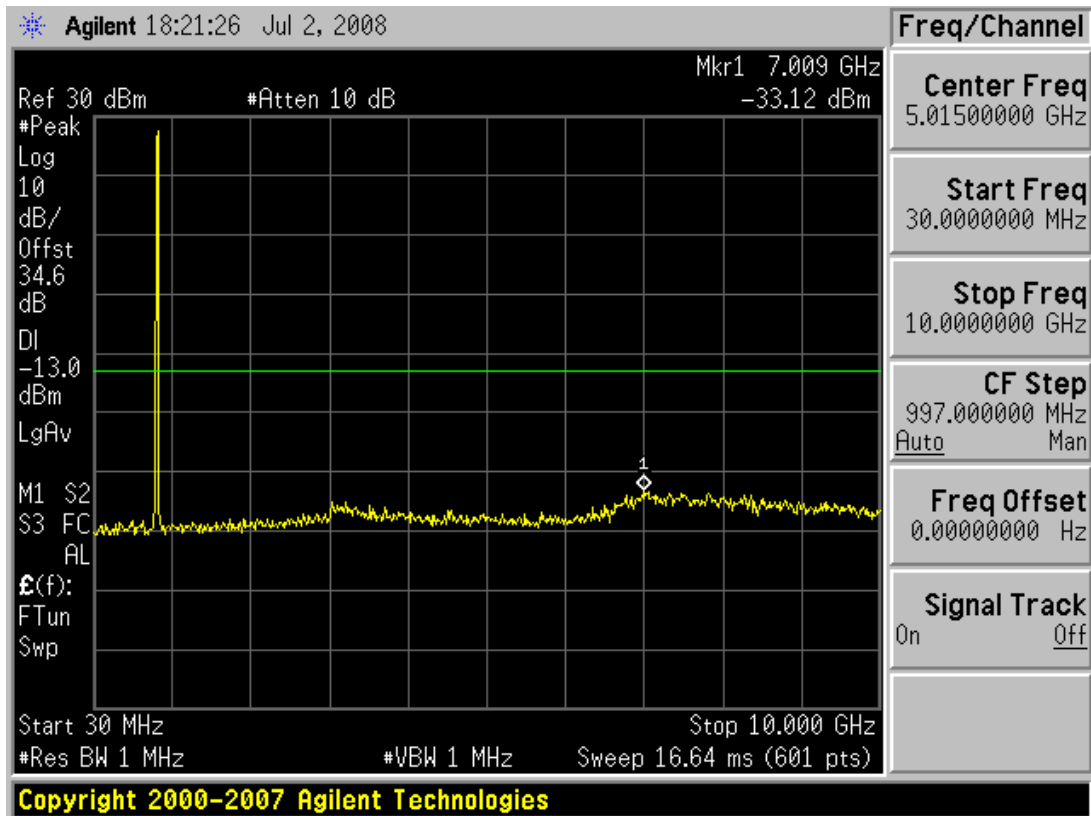



■ CDMA MODE (777 CH.) Conducted Spurious Emissions

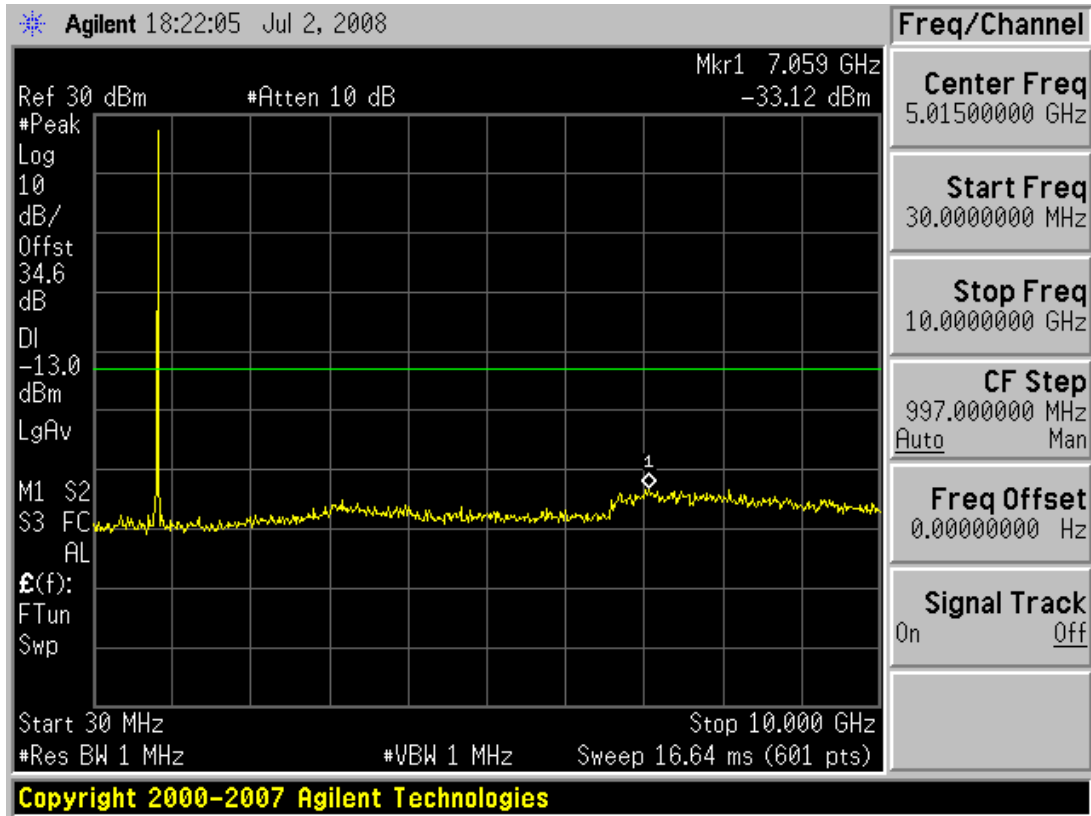

■ PCS CDMA MODE (25 CH.) Conducted Spurious Emissions

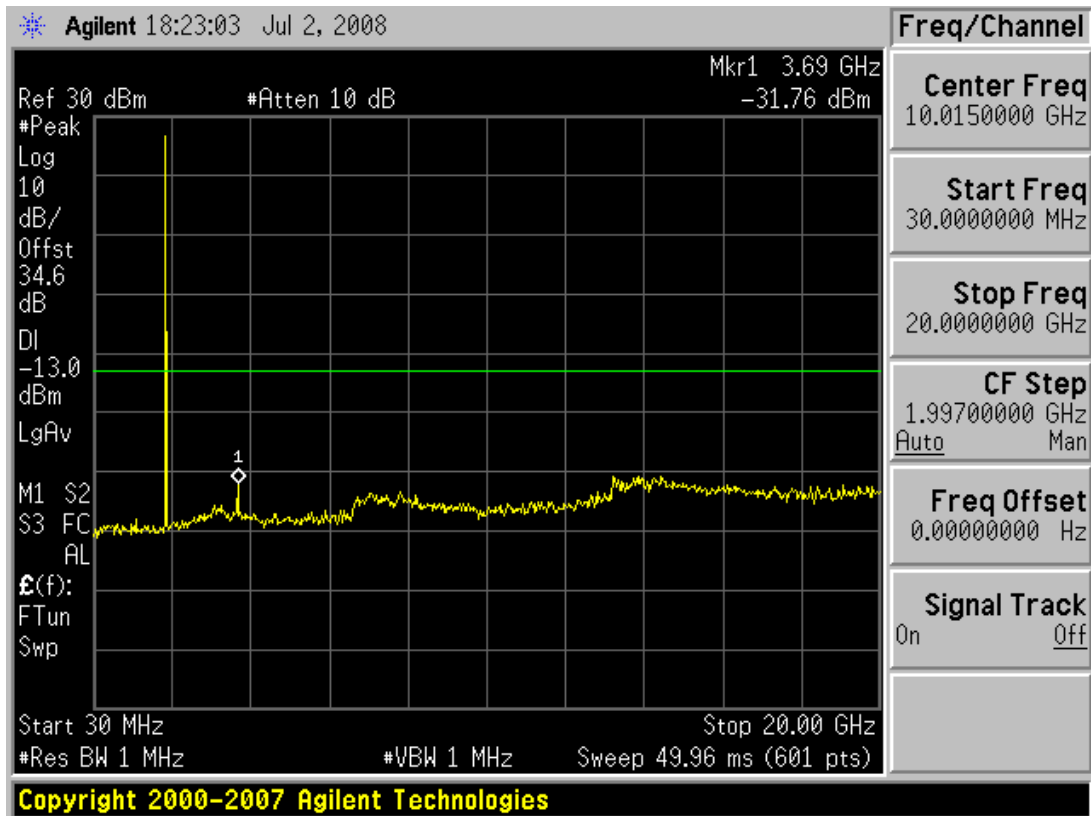



■ PCS CDMA MODE (600 CH.) Conducted Spurious Emissions

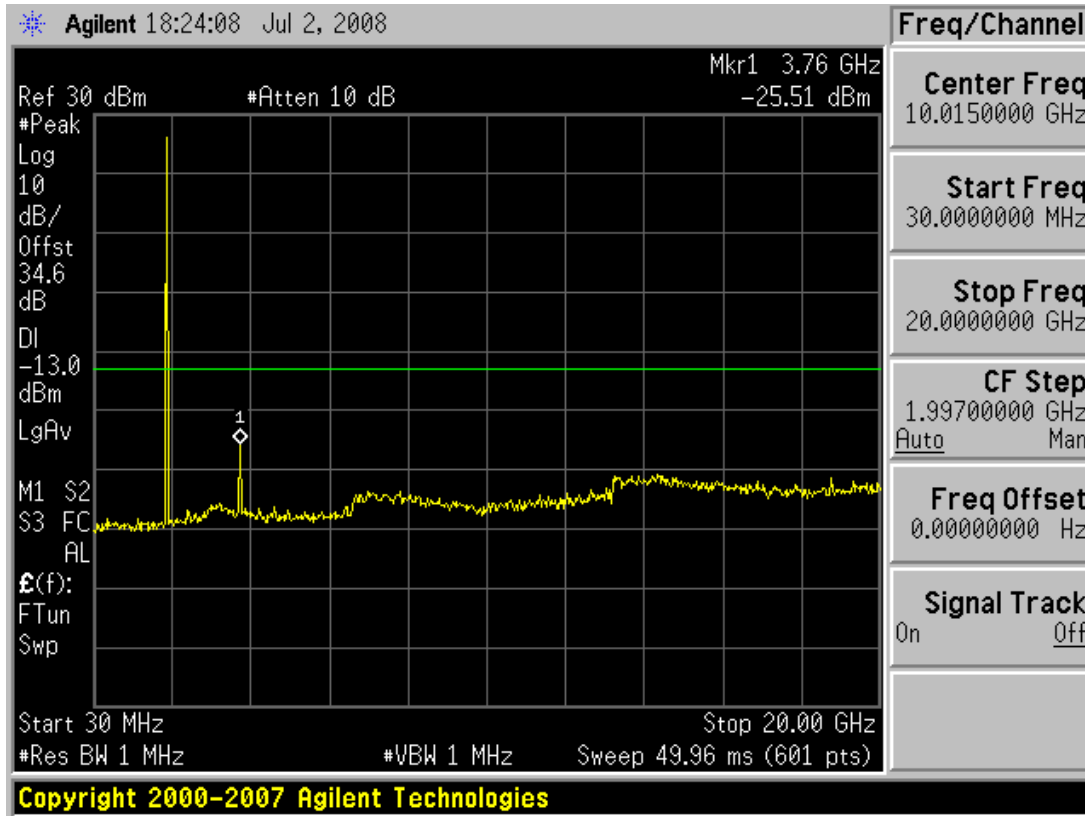

■ PCS CDMA MODE (1175 CH.) Conducted Spurious Emissions

