



# Part No. 1004795 / 1004796

## Universal Broadband FR4 Embedded LTE / LPWA Antenna

600 / 700 / 750 / 850 / 900 / 1800 / 1900 / 2100 / 2700 MHz

Supports: Broadband LTE (OCTA-BAND), LTE CAT-M, NB-IoT, SigFox, LoRa, Cellular LPWA, RPMA



\*Mirrored version offered as 1004796

### Universal Broadband FR4 Embedded LTE Antenna

Low Band 600 – 1000 MHz  
High Band 1700 - 2200 MHz  
High High Band 2500 - 2700 MHz

#### KEY BENEFITS

##### Reduced Costs and Time-to-Market

Standard antenna eliminates design fees and cycle time associated with a custom solution; getting products to market faster.

##### Greater Flexibility with Unique Form Factors

Ethertronics' technology helps you deliver more advanced ergonomic designs without adverse impact on product performance.

##### Reliability

Comply with latest RoHS requirements

#### APPLICATIONS

- Medical applications
- Wearables
- Smart metering
- M2M, Industrial devices
- IoT
- Firstnet
- Automotive
- Healthcare Point of Sale
- Tracking
- NB-IoT
- Sigfox
- LoRa
- Cellular LPWA
- RPMA
- LTE CAT-M

Ethertronics' Universal Broadband Embedded LTE/LPWA antennas utilize IMD technology, which offers a reduced electrical footprint on any circuit board and independent tuning capabilities for performance optimization. This low profile FR4 antenna encapsulates IMD's high performance and isolation characteristics offering better connectivity and minimal interference

#### High Performance LTE in Small form factor

The 1004795/1004796 LTE antenna is designed to support CAT-M and Narrowband-IoT applications. This antenna is the perfect solution CAT-M and NB-IoT enabled devices, offering high efficiency and peak gain in a miniature form factor, and with a reduced ground plane size requirement. The 1004795/1004796 LTE CAT-M and NB-IoT antenna allows wideband coverage, supporting all US and Worldwide major carriers and offers multiple tuning features for optimum results in any application.

#### Electrical Specifications

Typical 1004795 performance 125 x 45 mm PCB

Frequency (MHz)	600-698	698-960	1710-2200	2500-2700
Peak Gain	Refer to Appendix 1	1.6 dBi	3.1 dBi	1.7 dBi
Average Efficiency		64%	55%	53%
VSWR Match		< 2.5:1		< 3.0:1
Polarization	Linear			
Power Consumption	2 Watt CW			
Feed Point Impedance	50 Ω unbalanced			

#### Mechanical Specifications & Ordering Part Number

Ordering Part #	1004795	1004796
Dimensions (mm)	36.0 x 9.0 x 3.2	36.0 x 9.0 x 3.2
Mounting Type	SMT (P&P)	
Variant	1004796 : Mirrored version of 1004795	
Weight (grams)	2.1	
Packaging	Tape and Reel	
Demo Board	1004795-01 (1004795)	1004796-01 (1004796)



1004795 / 1004796 Universal Broadband Embedded LTE Antenna Specifications.  
Ethertronics produces a wide variety of standard and custom antennas to meet user needs.

**Antenna Dimensions (1004795)**

Typical antenna dimensions (mm)

Part Number	A (mm)	B (mm)	C (mm)
1004795	36.0 ± 0.3	9.0 ± 0.2	3.2 ± 0.3

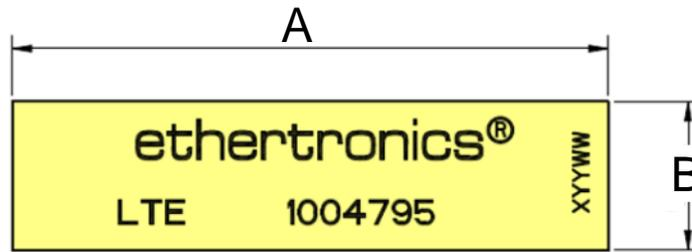
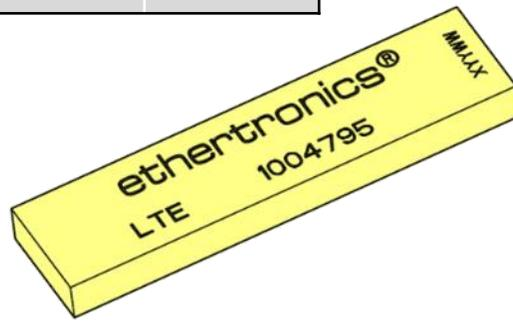

**Top View**

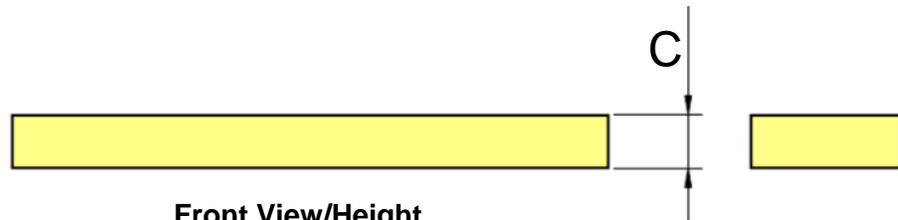

**Front View/Height**

Pin#	Description
1	Feed
2	Antenna Tuning
3	Dummy Pad
4	Dummy Pad
5	Antenna Tuning
6	Dummy Pad
7	Dummy Pad
8	Dummy Pad

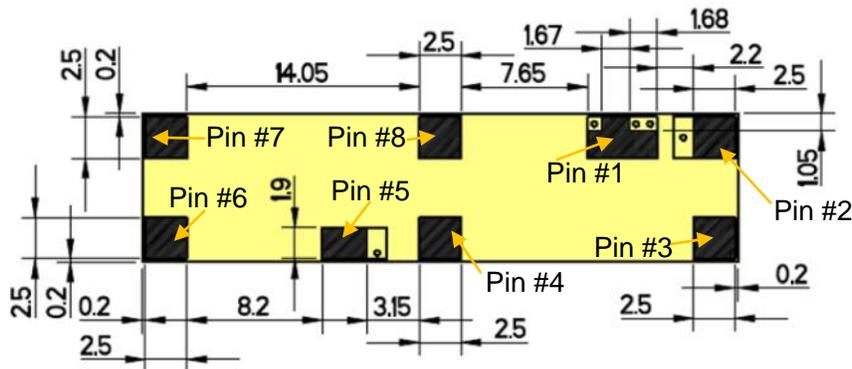

**Bottom View**



1004795 / 1004796 Universal Broadband Embedded LTE Antenna Specifications.  
Ethertronics produces a wide variety of standard and custom antennas to meet user needs.

**Antenna Dimensions (1004796)**

Typical antenna dimensions (mm)

Part Number	A (mm)	B (mm)	C (mm)
1004796	36.0 ± 0.3	9.0 ± 0.2	3.2 ± 0.3

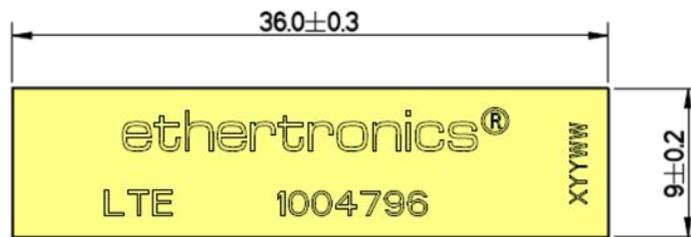
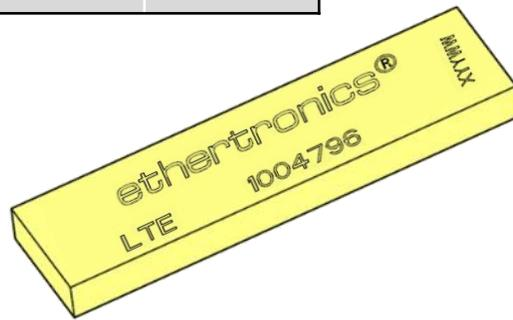

**Top View**

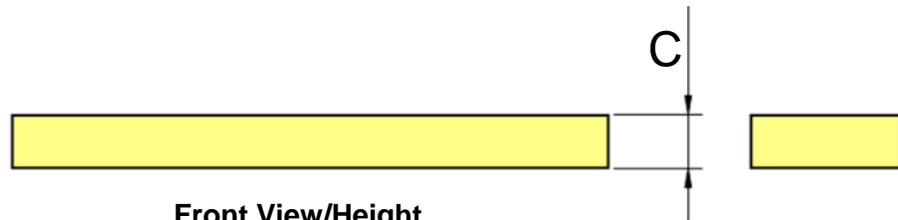

**Front View/Height**

Pin#	Description
1	Feed
2	Antenna Tuning
3	Dummy Pad
4	Dummy Pad
5	Antenna Tuning
6	Dummy Pad
7	Dummy Pad
8	Dummy Pad

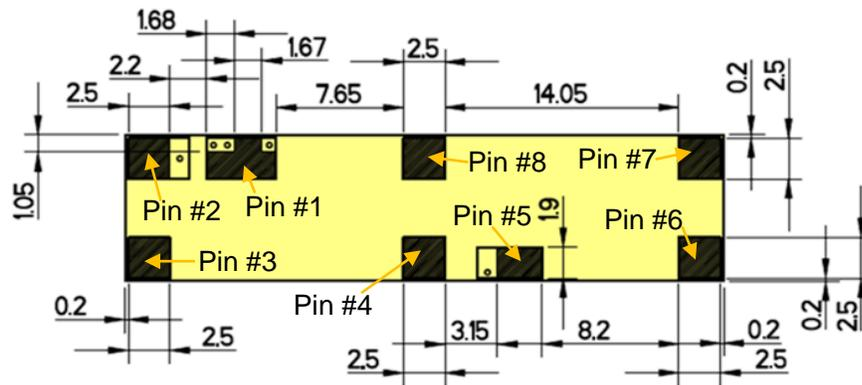

**Bottom View**



1004795 / 1004796 Universal Broadband Embedded LTE Antenna Specifications.  
Ethertronics produces a wide variety of standard and custom antennas to meet user needs.

### VSWR and Efficiency Plots

Typical 1004795/1004796 performance 125 x 45 mm PCB

#### Low Band VSWR

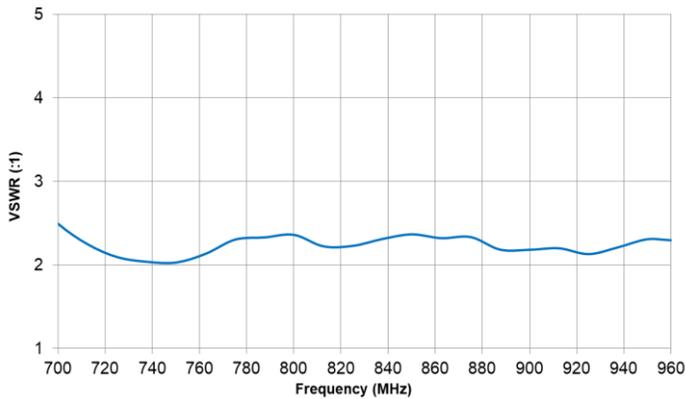

#### Low Band Efficiency

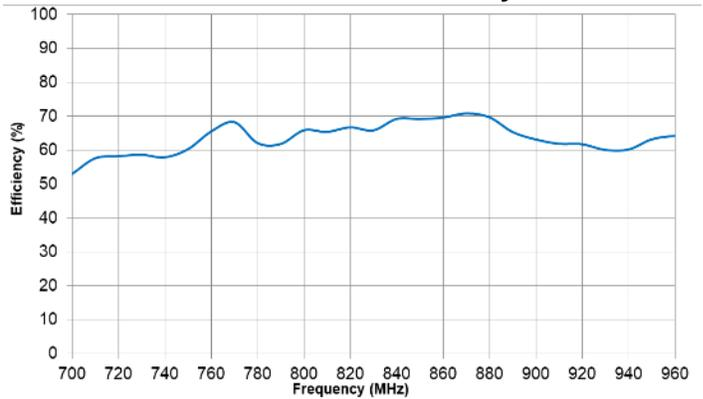

#### High Band VSWR

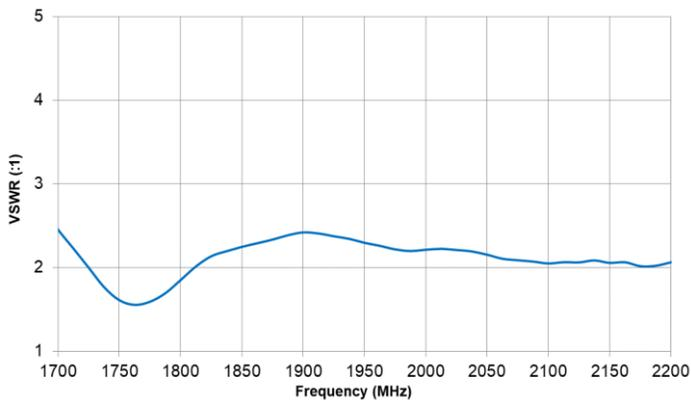

#### High Band Efficiency

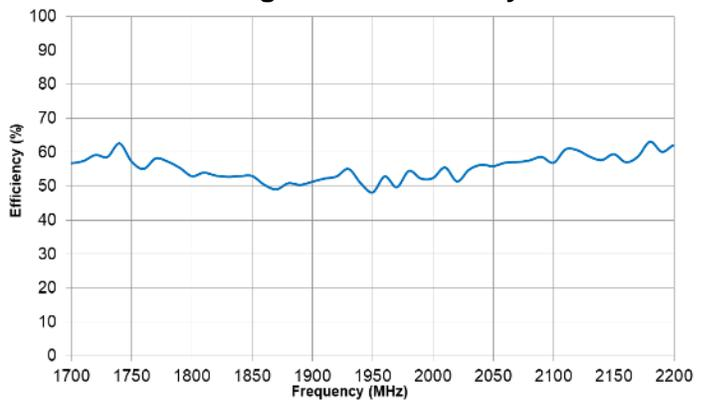

#### High High Band VSWR

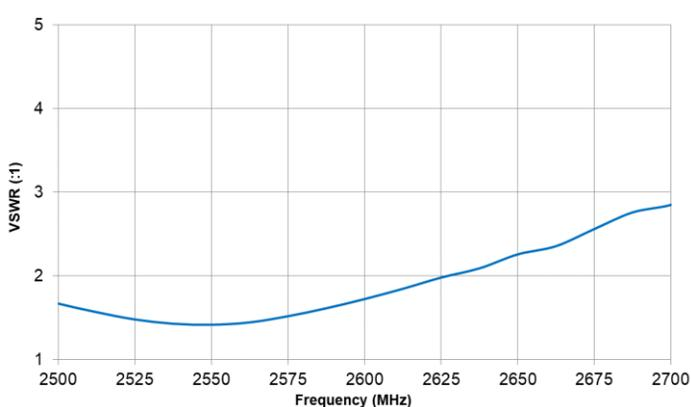

#### High High Band Efficiency

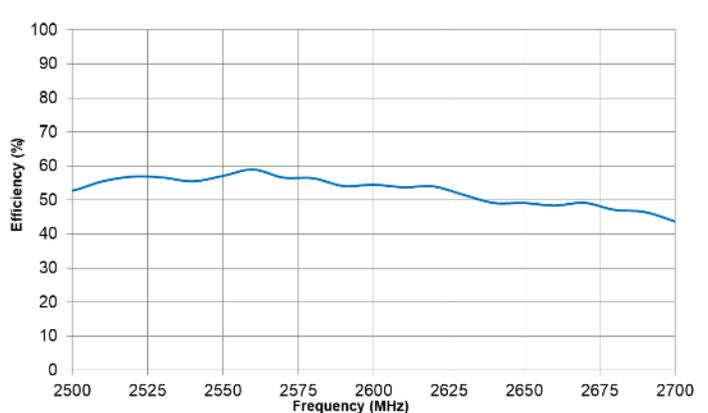



1004795 / 1004796 Universal Broadband Embedded LTE Antenna Specifications.  
Ethertronics produces a wide variety of standard and custom antennas to meet user needs.

Antenna Radiation Patterns – Low / High Band

Typical 1004795/1004796 performance 125 x 45 mm PCB

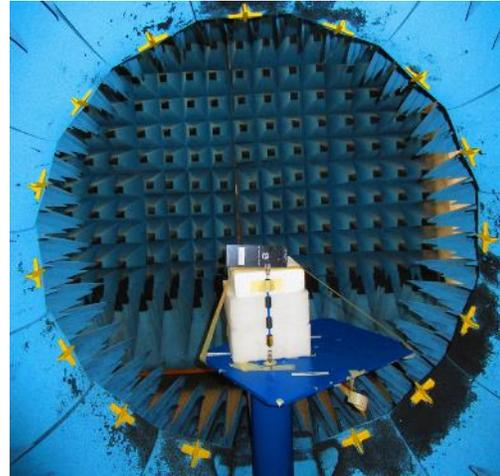
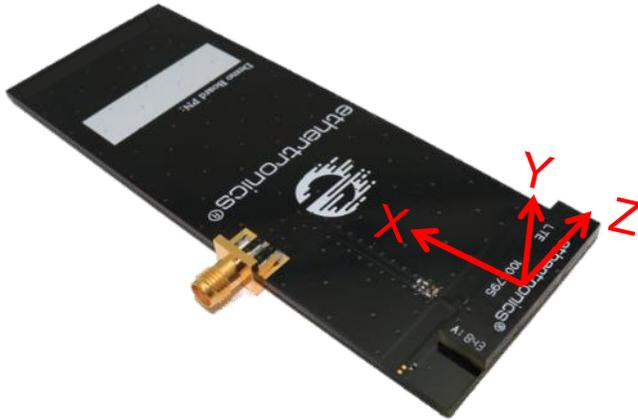

Low Band measured at  
700, 750, 850, 900 MHz

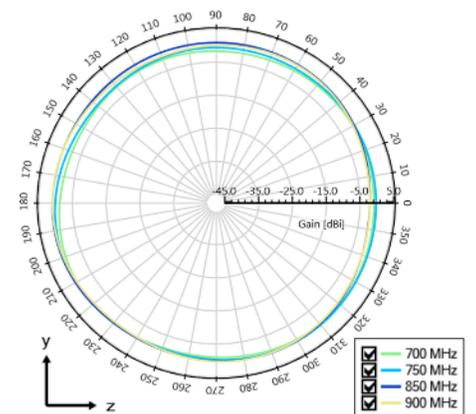
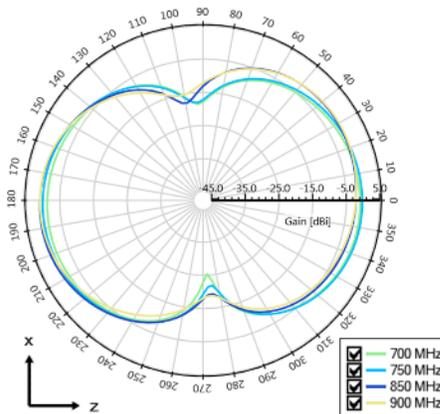
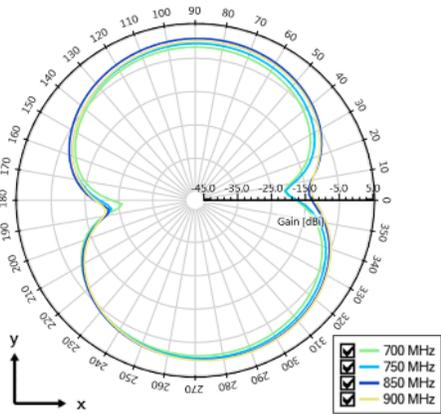

High Band measured at  
1800, 1900, 2100 MHz

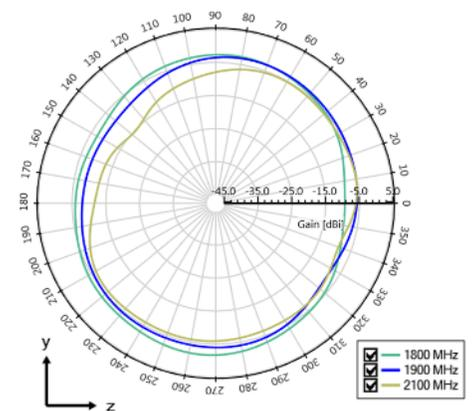
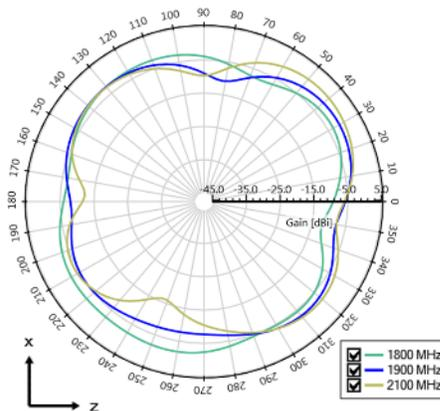
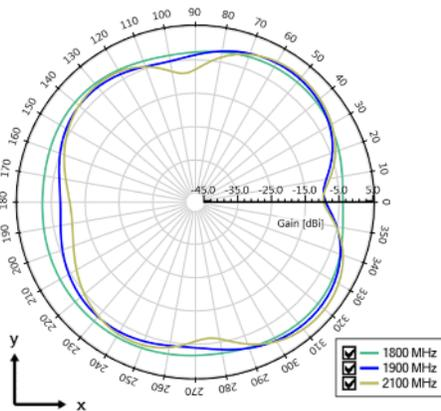



1004795 / 1004796 Universal Broadband Embedded LTE Antenna Specifications.  
Ethertronics produces a wide variety of standard and custom antennas to meet user needs.

### Antenna Radiation Patterns – High High Band

Typical 1004795/1004796 performance 125 x 45 mm PCB

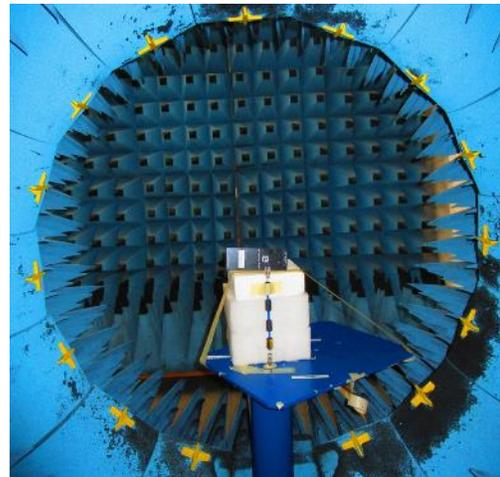
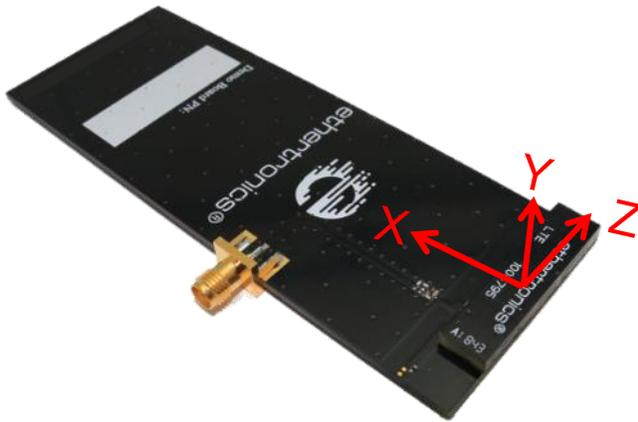

High High Band measured at  
2600 MHz

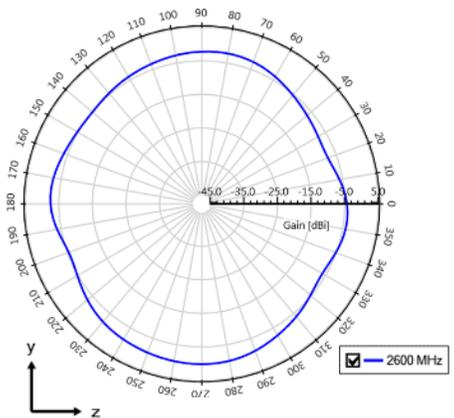
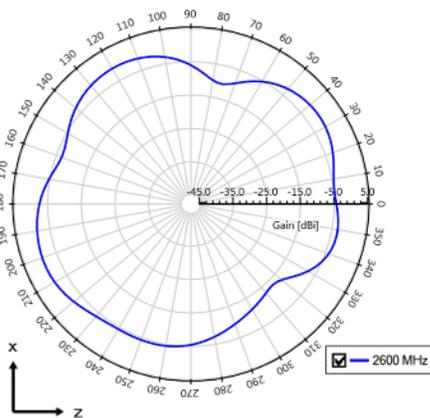
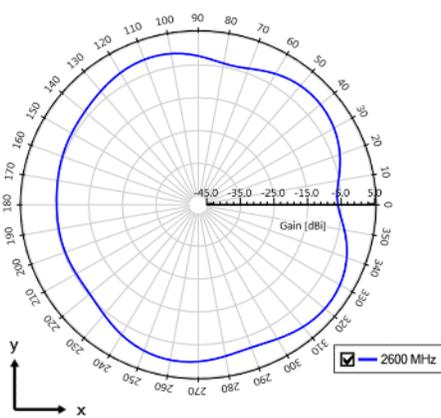



1004795 / 1004796 Universal Broadband Embedded LTE Antenna Specifications.  
Ethertronics produces a wide variety of standard and custom antennas to meet user needs.

### Antenna Layout (1004795)

Typical layout dimensions (mm)

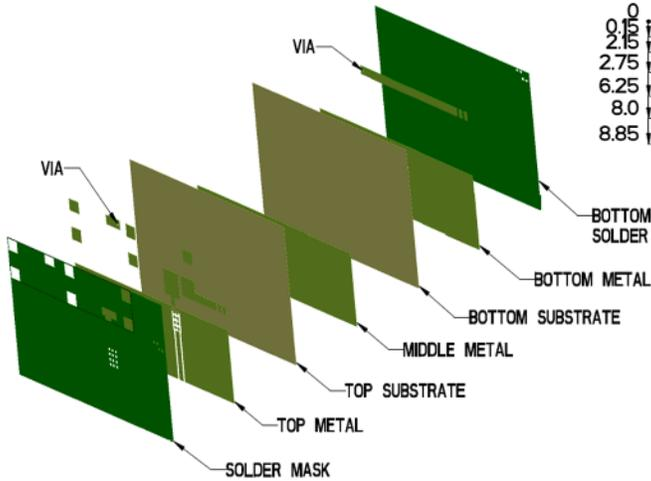

- Additional VIAS: Diam. 0.4mm to be placed around antenna, (no vias on transmission lines).
- Via holes must be covered by solder mask

### Pin Descriptions

Pin#	Description
1	Feed
2	Antenna Tuning
3	Dummy Pad
4	Dummy Pad
5	Antenna Tuning
6	Dummy Pad
7	Dummy Pad
8	Dummy Pad

\*1004796 uses the same layout but mirrored.

Default Pi Matching Network values with instructions can be found under Antenna Matching Network.

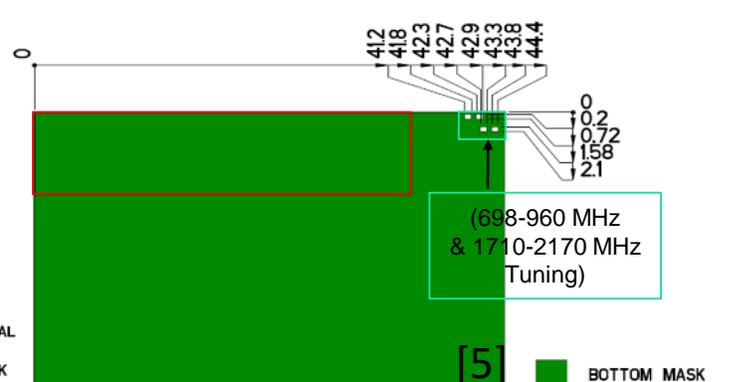
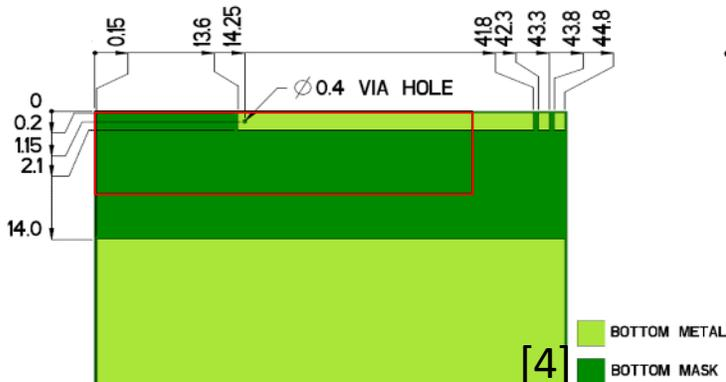
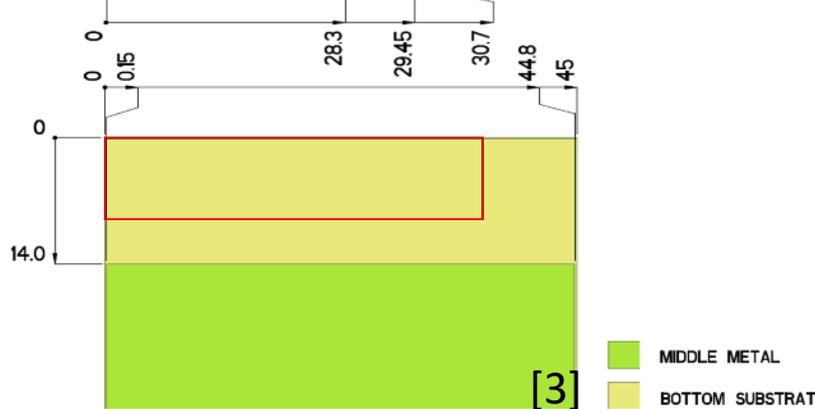
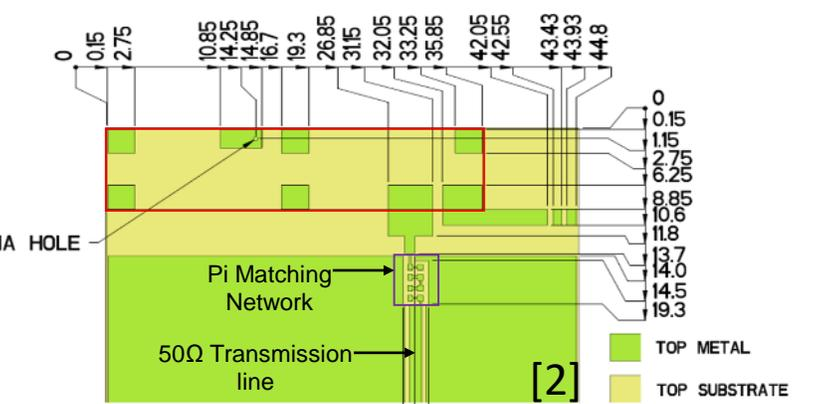
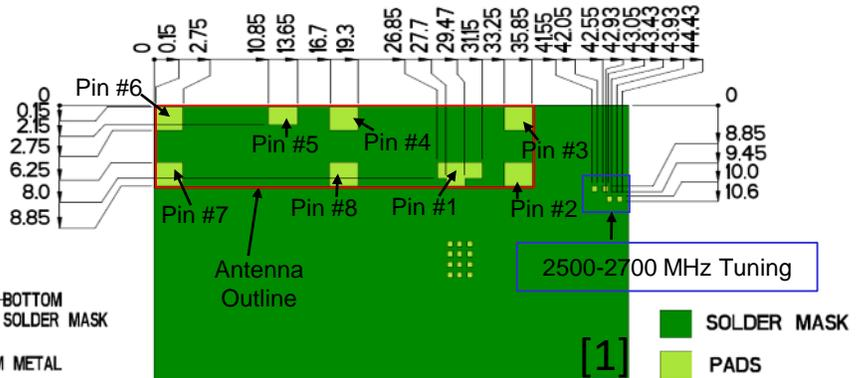



1004795 / 1004796 Universal Broadband Embedded LTE Antenna Specifications.  
Ethertronics produces a wide variety of standard and custom antennas to meet user needs.

### Antenna Layout (1004796)

Typical layout dimensions (mm)

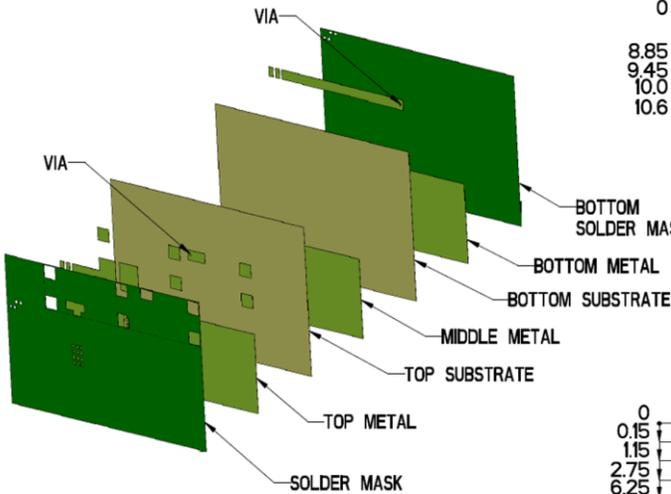

- Additional VIAS: Diam. 0.4mm to be placed around antenna, (no vias on transmission lines).
- Via holes must be covered by solder mask

### Pin Descriptions

Pin#	Description
1	Feed
2	Antenna Tuning
3	Dummy Pad
4	Dummy Pad
5	Antenna Tuning
6	Dummy Pad
7	Dummy Pad
8	Dummy Pad

\*1004795 uses the same layout but mirrored.

Default Pi Matching Network values with instructions can be found under Antenna Matching Network.

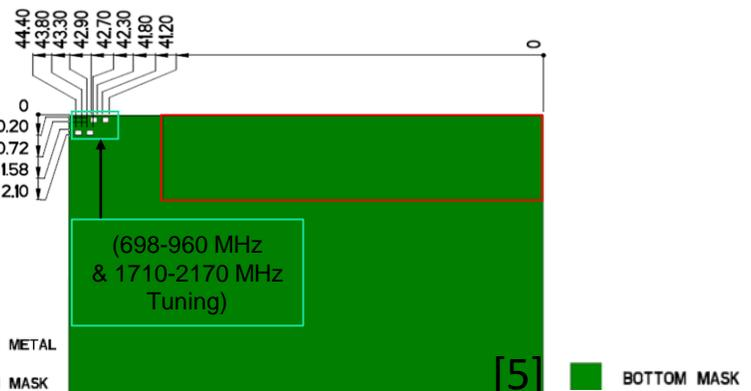
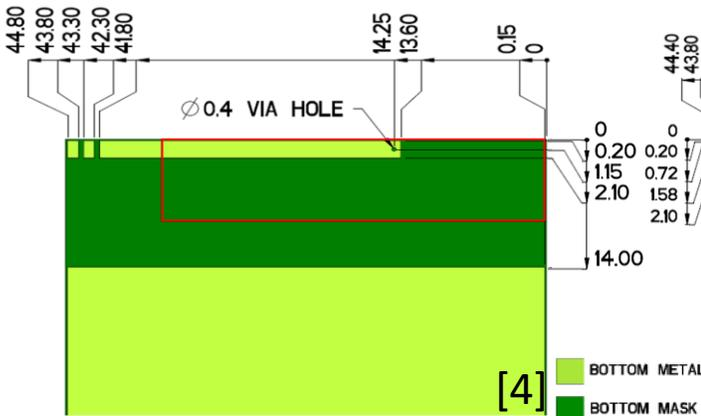
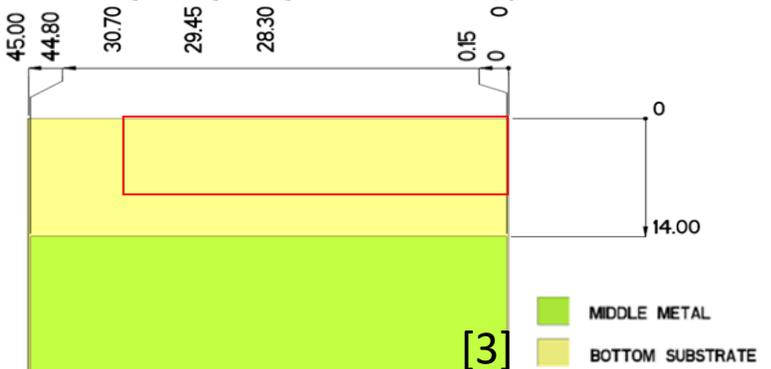
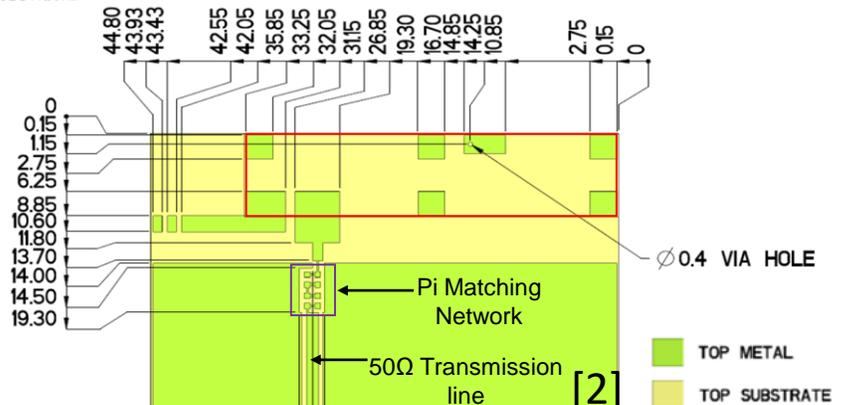
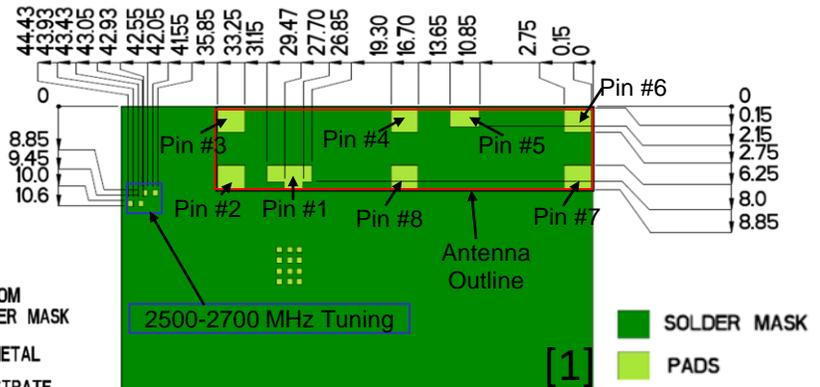



1004795 / 1004796 Universal Broadband Embedded LTE Antenna Specifications.  
Ethertronics produces a wide variety of standard and custom antennas to meet user needs.

### Antenna Matching Structure (1004795)

Typical matching values on 125 x 45 mm PCB

\*Also applies to mirrored layout 1004796

Demo Board Front View

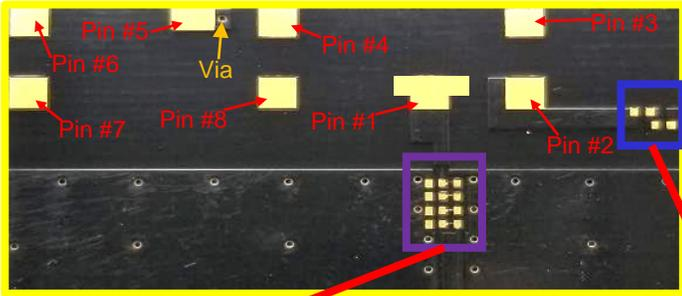

Demo Board Back View

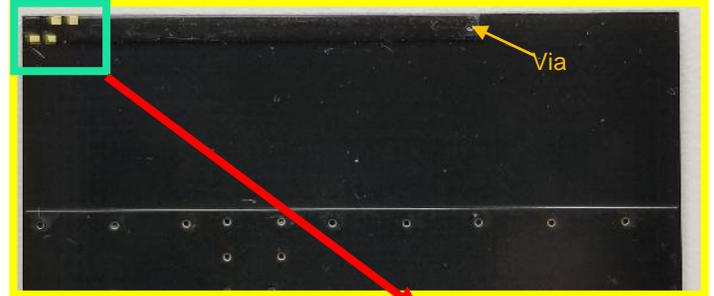

Antenna Matching

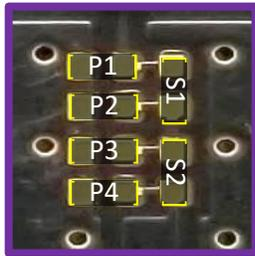

(Antenna Matching): pads are directly inline with the antenna feed trace.

2500-2700 MHz Tuning

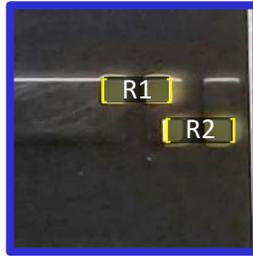

698-960 MHz & 1710-2170 MHz Tuning

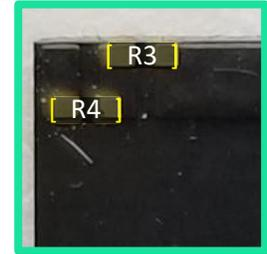

### Pin Descriptions

Pin#	Description
1	Feed
2	Antenna Tuning
3	Dummy Pad
4	Dummy Pad
5	Antenna Tuning
6	Dummy Pad
7	Dummy Pad
8	Dummy Pad

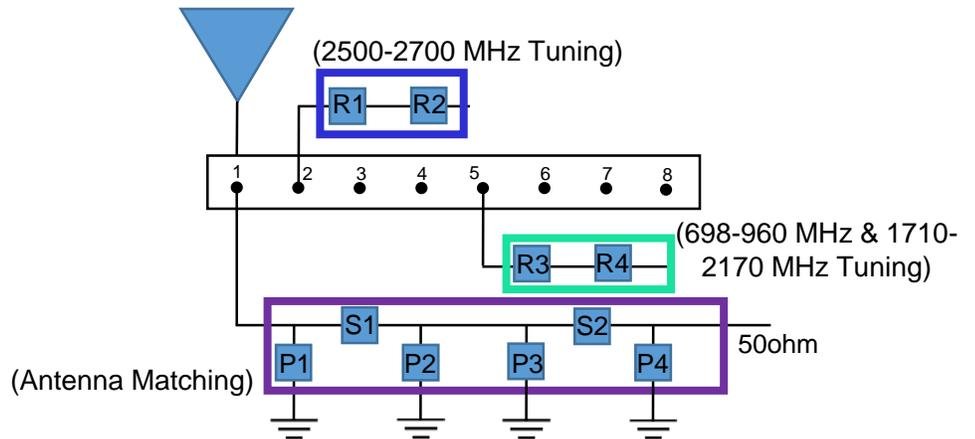

	P1	S1	P2	P3	S2	P4	R1	R2	R3-R4
<b>Default Matching</b>	8.2nH	4.7pF	0.3pF	DNI	0 Ohm	0.5pF	0 Ohm	DNI	0 Ohm
<b>Tolerance</b>	± 0.1nH	± 0.05pF	± 0.05pF	N/A		± 0.05pF		N/A	



1004795 / 1004796 Universal Broadband Embedded LTE Antenna Specifications.  
Ethertronics produces a wide variety of standard and custom antennas to meet user needs.

**Antenna Tuning Options (1004795)**

Typical matching values on 125 x 45 mm PCB

\*Also applies to mirrored layout 1004796

Demo Board Front View

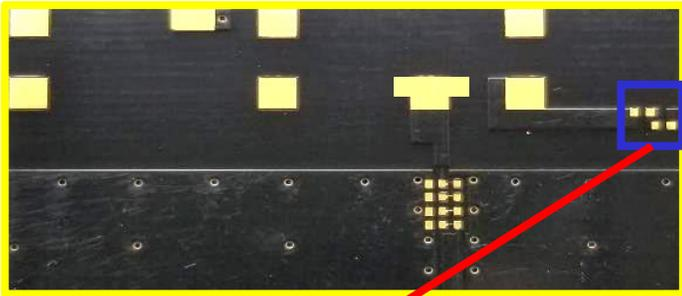

Demo Board Back View

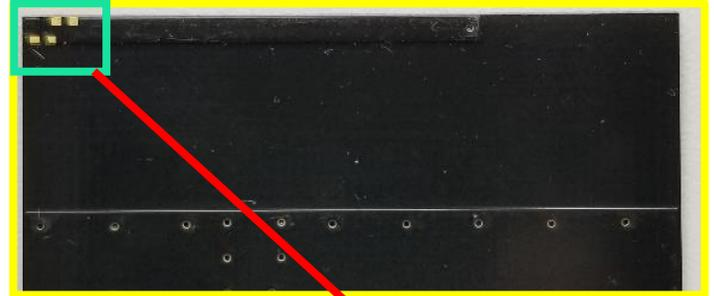

2500-2700 MHz Tuning

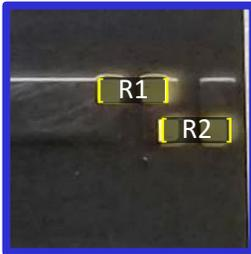

698-960 MHz & 1710-2170 MHz Tuning

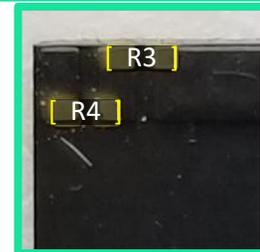

Options for Tuning: "698-960 MHz & 1710-2170 MHz"

MODE	T1	T2		T3	
PADS	Connect: R3 & R4	Remove: R4		Remove: R4 & R3	
Outcome: (Ref: Baseline)	BASELINE	(698-960 MHz) ~20 MHz shift high	(1710-2170 MHz) ~20 MHz shift high	(698-960 MHz) ~30 MHz shift high	(1710-2170 MHz) ~35 MHz shift high

\*R= 0 Ohm

Options for Tuning: "2500-2700 MHz"

MODE	T4	T5	T6
PADS	Connect: R1	Connect: R1 & R2	Remove: R1 & R2
Outcome: (Ref: Baseline)	BASELINE	~60 MHz shift low	~70 MHz shift high

\*R= 0 Ohm



1004795 / 1004796 Universal Broadband Embedded LTE Antenna Specifications.  
Ethertronics produces a wide variety of standard and custom antennas to meet user needs.

**Antenna Demo Board (1004795)**

Demo Board Front/Back View (mm)





1004795 / 1004796 Universal Broadband Embedded LTE Antenna Specifications.  
Ethertronics produces a wide variety of standard and custom antennas to meet user needs.

# Appendix 1

Appendix 1 gives instructions on how to achieve increased bandwidth to cover 600-960 MHz through impedance matching network.

(600-960 MHz)  
(1710-2170 MHz)  
(2500-2700 MHz)

Frequency (MHz)	600-698	698-960	1710-2200	2500-2700
Peak Gain	1.5 dBi	1.2 dBi	2.4 dBi	0.9 dBi
Average Efficiency	61%	55%	52%	48%
VSWR Match	< 5.5:1	< 3.7:1	< 2.5:1	< 3.0:1
Polarization	Linear			
Power Consumption	2 Watt CW			
Feed Point Impedance	50 Ω unbalanced			

\*Data shown above has Appendix 1 matching applied on 125 x 45 mm pcb.



1004795 / 1004796 Universal Broadband Embedded LTE Antenna Specifications.  
Ethertronics produces a wide variety of standard and custom antennas to meet user needs.

**Appendix 1: Antenna Matching Structure (1004795)**

Typical matching values on 125 x 45 mm PCB

\*Also applies to mirrored layout 1004796

Demo Board Front View

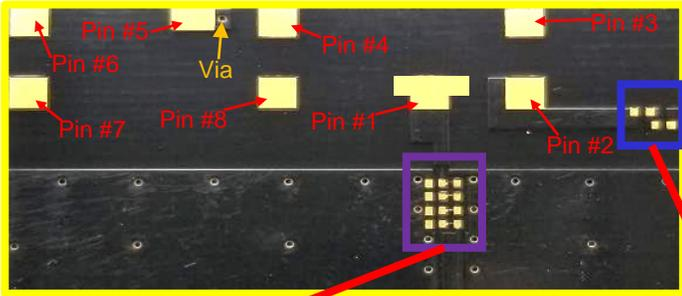

Demo Board Back View

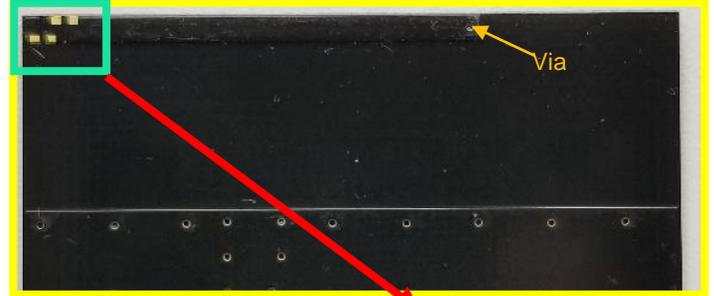

Antenna Matching

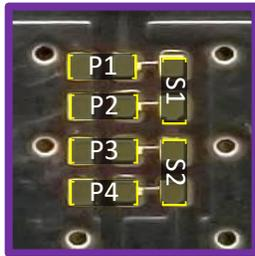

(Antenna Matching): pads are directly inline with the antenna feed trace.

2500-2700 MHz Tuning

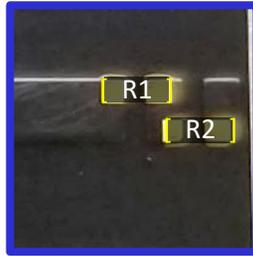

600-960 MHz & 1710-2170 MHz Tuning

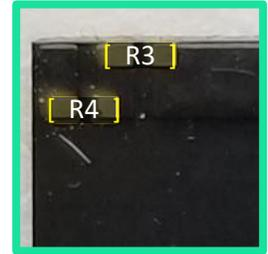

Pin Descriptions

Pin#	Description
1	Feed
2	Antenna Tuning
3	Dummy Pad
4	Dummy Pad
5	Antenna Tuning
6	Dummy Pad
7	Dummy Pad
8	Dummy Pad

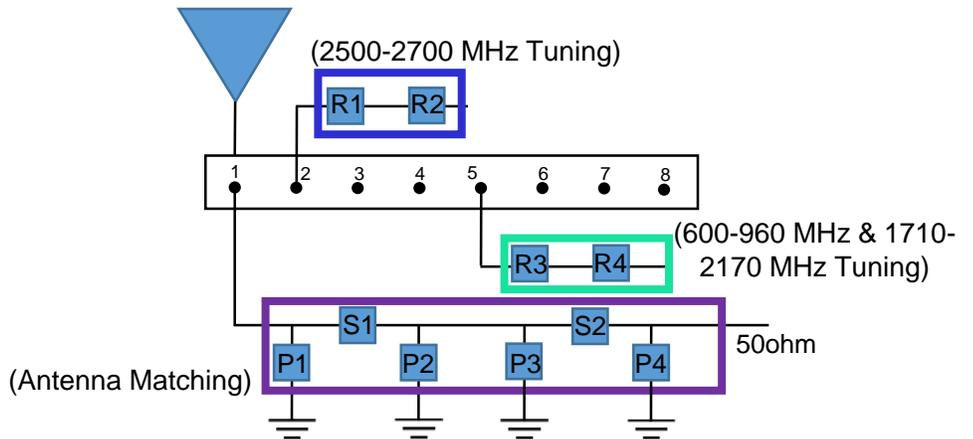

	P1	S1	P2	P3	S2	P4	R1	R2	R3-R4
<b>Default Matching</b>	10nH	3.3pF	DNI	DNI	0 Ohm	DNI	0 Ohm	DNI	0 Ohm
<b>Tolerance</b>	± 0.1nH	± 0.1pF	N/A	N/A		N/A		N/A	



1004795 / 1004796 Universal Broadband Embedded LTE Antenna Specifications.  
Ethertronics produces a wide variety of standard and custom antennas to meet user needs.

**Appendix 1: Antenna Tuning Options (1004795)**

Typical matching values on 125 x 45 mm PCB

\*Also applies to mirrored layout 1004796

Demo Board Front View

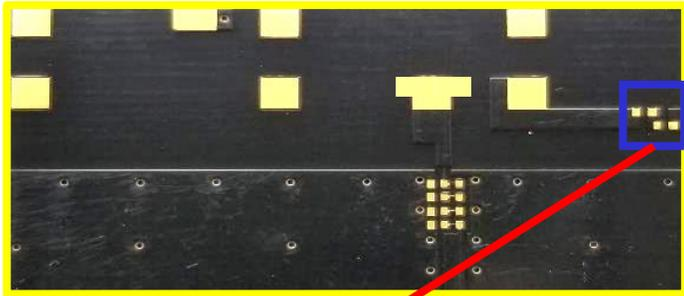

Demo Board Back View

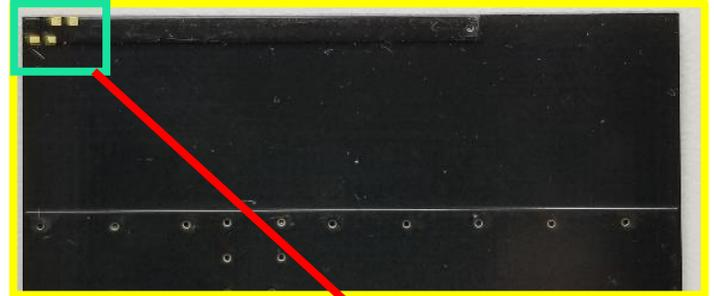

2500-2700 MHz Tuning

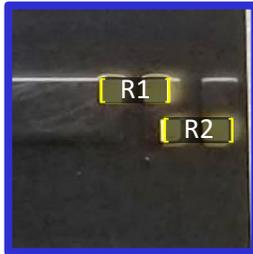

600-960 MHz & 1710-2170 MHz Tuning

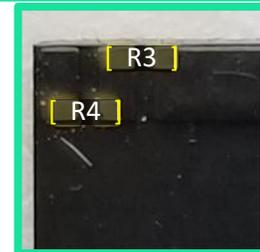

Options for Tuning: "600-960 MHz & 1710-2170 MHz"

MODE	T1	T2		T3	
PADS	Connect: R3 & R4	Remove: R4		Remove: R4 & R3	
Outcome: (Ref: Baseline)	BASELINE	(600-960 MHz) ~20 MHz shift high	(1710-2170 MHz) ~20 MHz shift high	(600-960 MHz) ~30 MHz shift high	(1710-2170 MHz) ~35 MHz shift high

\*R= 0 Ohm

Options for Tuning: "2500-2700 MHz"

MODE	T4	T5	T6
PADS	Connect: R1	Connect: R1 & R2	Remove: R1 & R2
Outcome: (Ref: Baseline)	BASELINE	~60 MHz shift low	~70 MHz shift high

\*R= 0 Ohm



1004795 / 1004796 Universal Broadband Embedded LTE Antenna Specifications.  
Ethertronics produces a wide variety of standard and custom antennas to meet user needs.

### Appendix 1: VSWR and Efficiency Plots

Typical 1004795/1004796 performance 125 x 45 mm PCB

#### Low Band VSWR

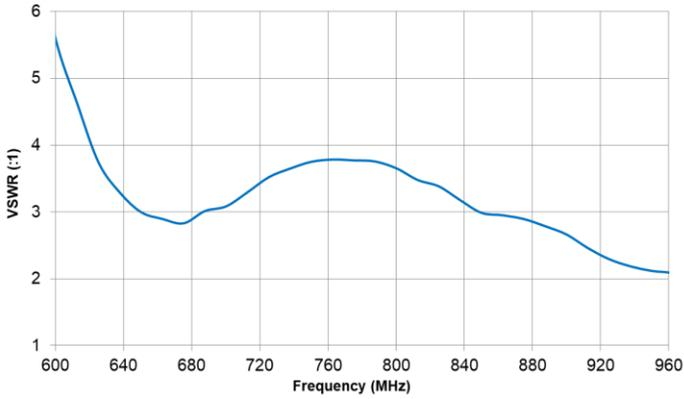

#### Low Band Efficiency

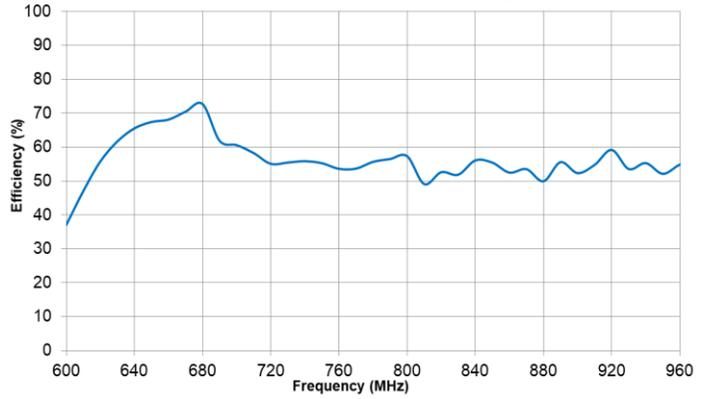

#### High Band VSWR

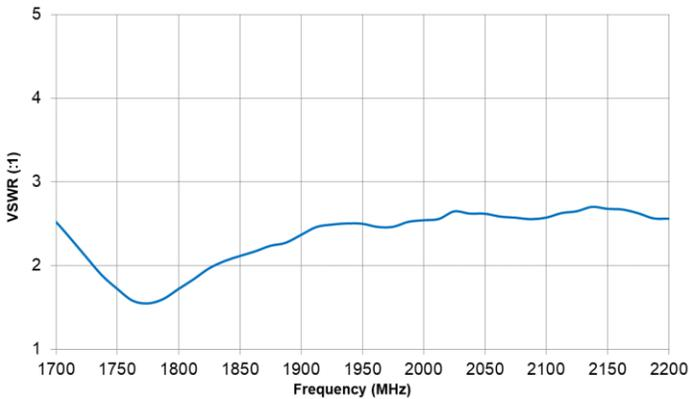

#### High Band Efficiency

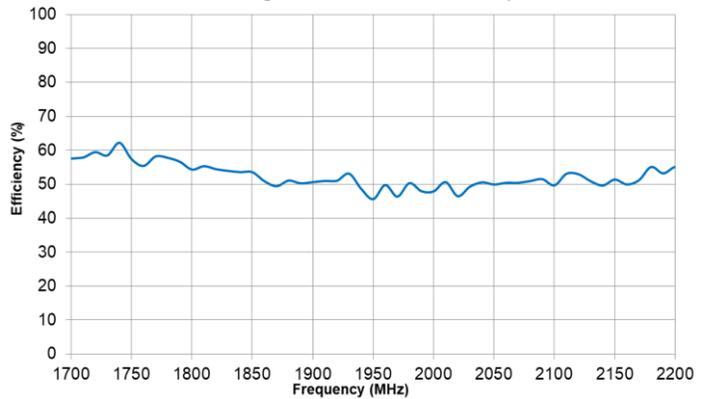

#### High High Band VSWR

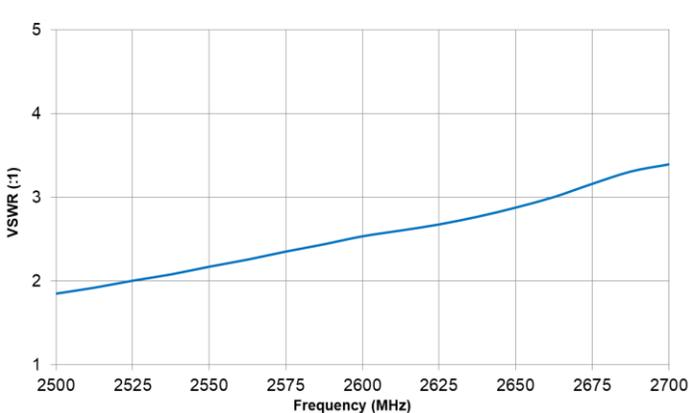

#### High High Band Efficiency

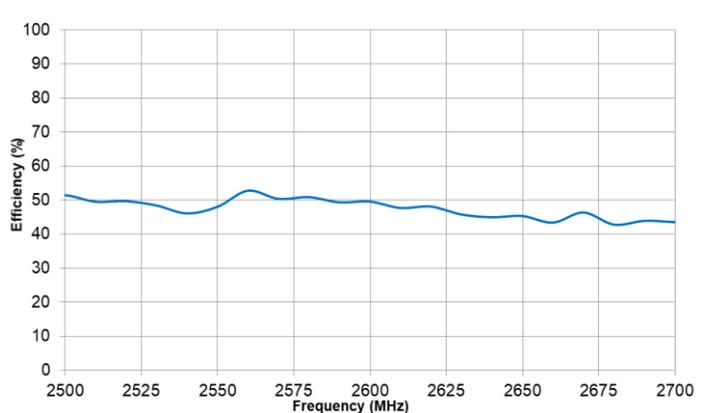



1004795 / 1004796 Universal Broadband Embedded LTE Antenna Specifications.  
Ethertronics produces a wide variety of standard and custom antennas to meet user needs.

**Appendix 1: Antenna Radiation Patterns – Low / High Band**

Typical 1004795/1004796 performance 125 x 45 mm PCB

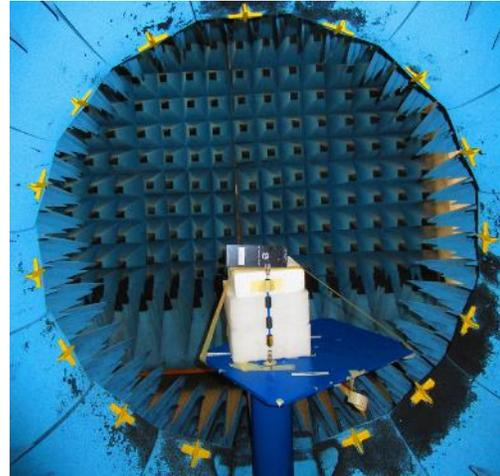
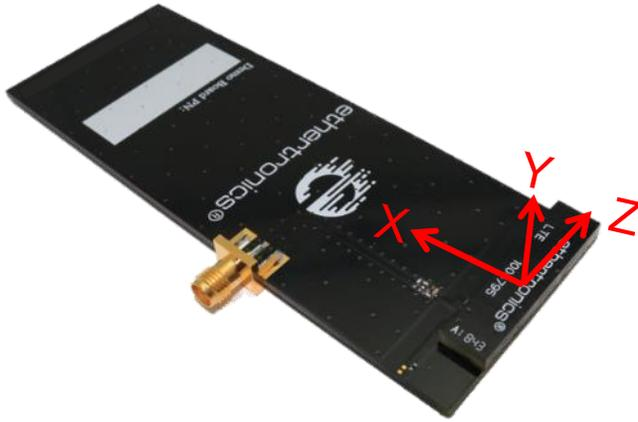

Low Band measured at  
600, 700 800, 900 MHz

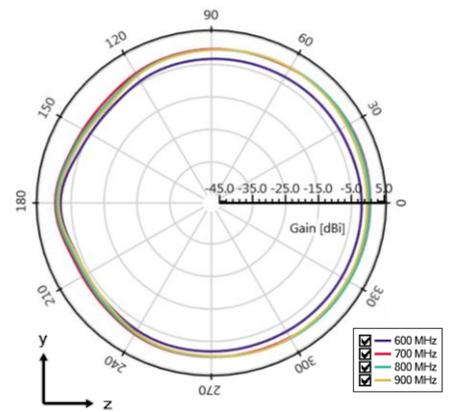
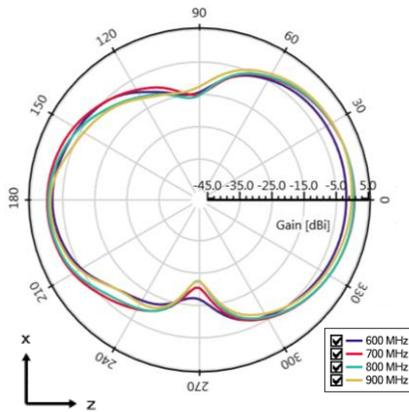
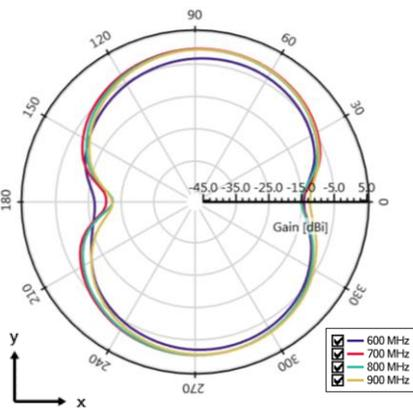

High Band measured at  
1800, 1900, 2100 MHz

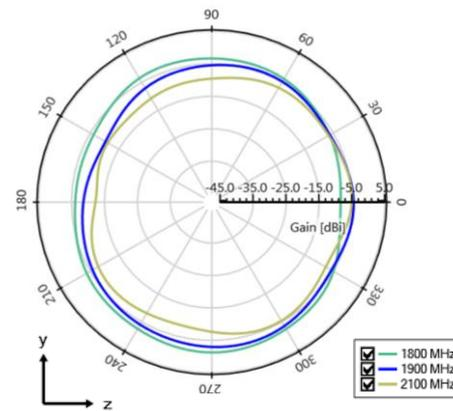
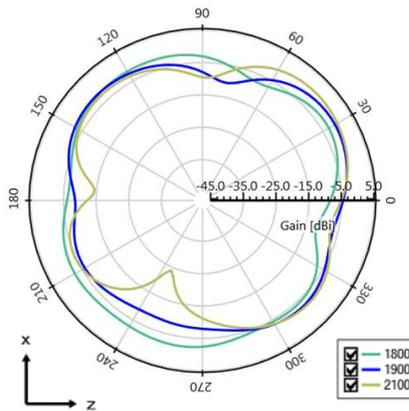
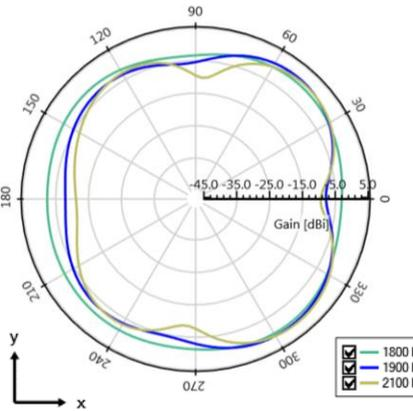



1004795 / 1004796 Universal Broadband Embedded LTE Antenna Specifications.  
Ethertronics produces a wide variety of standard and custom antennas to meet user needs.

**Appendix 1: Antenna Radiation Patterns – High High Band**

Typical 1004795/1004796 performance 125 x 45 mm PCB

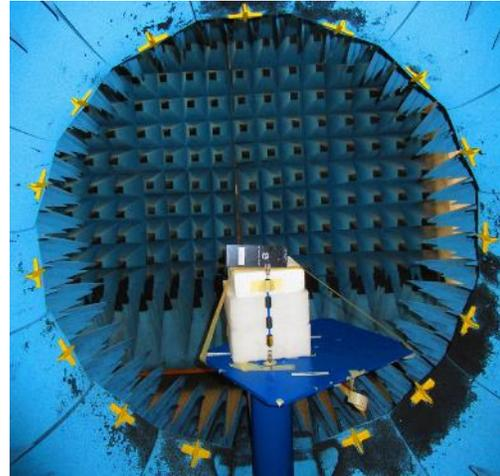
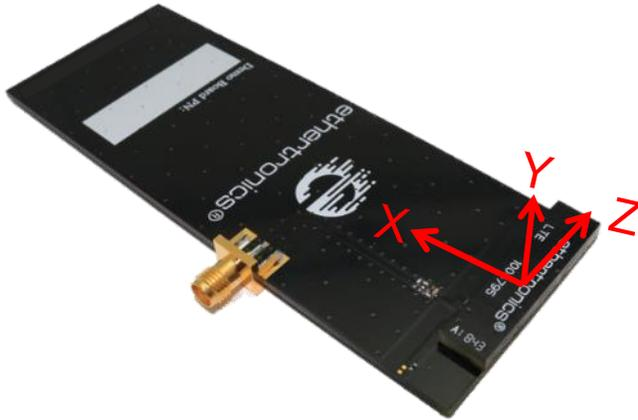

High High Band measured at  
2600 MHz

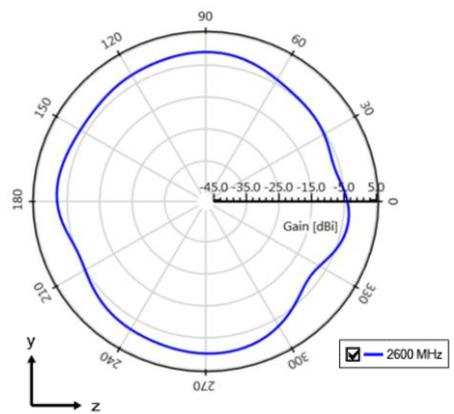
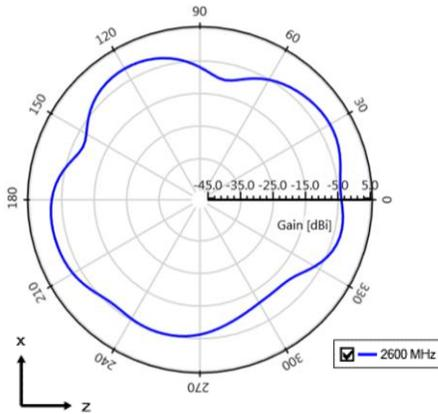
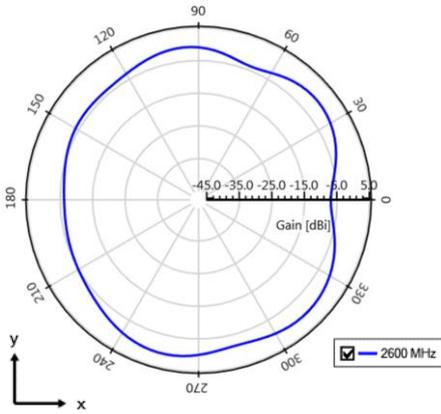



1004795 / 1004796 Universal Broadband Embedded LTE Antenna Specifications.  
Ethertronics produces a wide variety of standard and custom antennas to meet user needs.

### Recommended Reflow Soldering Profile

The recommended method for soldering the antenna to the board is forced convection reflow soldering. The following suggestions provide information on how to optimize the reflow process for the FR4 antenna:

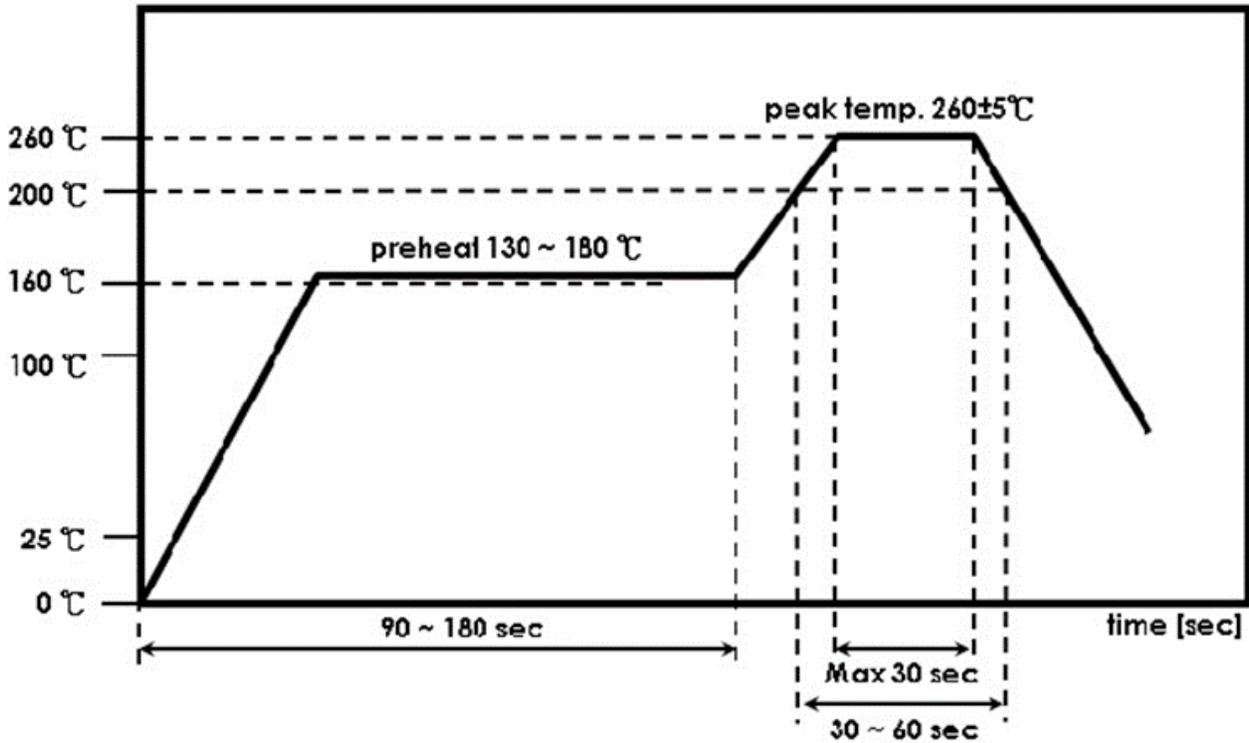

\*Adjust the reflow duration to create good solder joints without raising the antenna temperature beyond the allowed maximum of 260° C.