



FCC TEST REPORT

REPORT NO.: RF920819R02A

MODEL NO.: G1REL100

RECEIVED: Sept. 5, 2003

TESTED: Sept. 5 ~ Sept. 10, 2003

APPLICANT: Digital Path Networks

ADDRESS: 275 Airpark Boulevard, Suite 500, Chico, CA
95973, U.S.A.

ISSUED BY: Advance Data Technology Corporation

LAB LOCATION: 47 14th Lin, Chiapau Tsun, Linko, Taipei,
Taiwan, R.O.C.

This test report consists of 50 pages in total. It may be duplicated completely for legal use with the approval of the applicant. It should not be reproduced except in full, without the written approval of our laboratory. The client should not use it to claim product endorsement by CNLA, NVLAP or any government agencies. The test results in the report only apply to the tested sample.



0528
ILAC MRA



Lab Code: 200102-0



Table of Contents

1	CERTIFICATION	4
2	SUMMARY OF TEST RESULTS	5
3	GENERAL INFORMATION	6
3.1	GENERAL DESCRIPTION OF EUT	6
3.2	DESCRIPTION OF TEST MODES	7
3.3	GENERAL DESCRIPTION OF APPLIED STANDARDS	7
3.4	DESCRIPTION OF SUPPORT UNITS	8
3.5	CONFIGURATION OF SYSTEM UNDER TEST	9
4	TEST TYPES AND RESULTS	10
4.1	CONDUCTED EMISSION MEASUREMENT	10
4.1.1	LIMITS OF CONDUCTED EMISSION MEASUREMENT	10
4.1.2	TEST INSTRUMENTS	10
4.1.3	TEST PROCEDURES	11
4.1.4	DEVIATION FROM TEST STANDARD	11
4.1.5	TEST SETUP	12
4.1.6	EUT OPERATING CONDITIONS	12
4.1.7	TEST RESULTS	13
4.2	RADIATED EMISSION MEASUREMENT	19
4.2.1	LIMITS OF RADIATED EMISSION MEASUREMENT	19
4.2.2	TEST INSTRUMENTS	20
4.2.3	TEST PROCEDURES	21
4.2.4	DEVIATION FROM TEST STANDARD	21
4.2.5	TEST SETUP	22
4.2.6	EUT OPERATING CONDITIONS	22
4.2.7	TEST RESULTS	23
4.3	6dB BANDWIDTH MEASUREMENT	28
4.3.1	LIMITS OF 6dB BANDWIDTH MEASUREMENT	28
4.3.2	TEST INSTRUMENTS	28
4.3.3	TEST PROCEDURE	28
4.3.4	DEVIATION FROM TEST STANDARD	28
4.3.5	TEST SETUP	29



4.3.6	EUT OPERATING CONDITIONS.....	29
4.3.7	TEST RESULTS.....	30
4.4	MAXIMUM PEAK OUTPUT POWER	34
4.4.1	LIMITS OF MAXIMUM PEAK OUTPUT POWER MEASUREMENT	34
4.4.2	TEST INSTRUMENTS	34
4.4.3	TEST PROCEDURES.....	35
4.4.4	DEVIATION FROM TEST STANDARD	35
4.4.5	TEST SETUP	35
4.4.6	EUT OPERATING CONDITIONS.....	35
4.4.7	TEST RESULTS.....	36
4.5	POWER SPECTRAL DENSITY MEASUREMENT	37
4.5.1	LIMITS OF POWER SPECTRAL DENSITY MEASUREMENT	37
4.5.2	TEST INSTRUMENTS	37
4.5.3	TEST PROCEDURE	38
4.5.4	DEVIATION FROM TEST STANDARD	38
4.5.5	TEST SETUP.....	38
4.5.6	EUT OPERATING CONDITIONS.....	38
4.5.7	TEST RESULTS.....	39
4.6	BAND EDGES MEASUREMENT	43
4.6.1	LIMITS OF BAND EDGES MEASUREMENT	43
4.6.2	TEST INSTRUMENTS	43
4.6.3	TEST PROCEDURE	43
4.6.4	DEVIATION FROM TEST STANDARD	43
4.6.5	EUT OPERATING CONDITION	44
4.6.6	TEST RESULTS.....	44
4.7	ANTENNA REQUIREMENT	47
4.7.1	STANDARD APPLICABLE	47
4.7.2	ANTENNA CONNECTED CONSTRUCTION.....	47
5	PHOTOGRAPHS OF THE TEST CONFIGURATION.....	48
6	INFORMATION ON THE TESTING LABORATORIES	50



1 CERTIFICATION

PRODUCT : Relay Omni
MODEL NO.: G1REL100
BRAND NAME : Digital Path Networks
APPLICANT : Digital Path Networks
TEST ITEM : Engineering Sample
STANDARDS : FCC 47 CFR Part 15, Subpart C (Section 15.247), ANSI C63.4-1992

We, **Advance Data Technology Corporation**, hereby certify that one sample of the designation has been tested in our facility from Sept. 5 ~ Sept. 10, 2003. The test record, data evaluation and Equipment Under Test (EUT) configurations represented herein are true and accurate accounts of the measurements of the sample's EMC characteristics under the conditions herein specified.

PREPARED BY: Rennie Wang, **DATE:** December 19, 2003
Rennie Wang

APPROVED BY: Ellis Wu, **DATE:** December 19, 2003
Ellis Wu, Manager



2 SUMMARY OF TEST RESULTS

The EUT has been tested according to the following specifications:

APPLIED STANDARD: 47 CFR Part 15, Subpart C			
Standard Section	Test Type and Limit	Result	REMARK
15.207	AC Power Conducted Emission	PASS	Meet the requirement of limit Minimum passing margin is -10.87dB at 4.615MHz
15.247(a)(2)	Spectrum Bandwidth of a Direct Sequence Spread Spectrum System. Limit: min. 500kHz	PASS	Meet the requirement of limit
15.247(b)	Maximum Peak Output Power Limit: max. 30dBm	PASS	Meet the requirement of limit
15.247(c)	Transmitter Radiated Emissions Limit: Table 15.209	PASS	Meet the requirement of limit Minimum passing margin is -2.20dB at 4176.00MHz
15.247(d)	Power Spectral Density Limit: max. 8dBm	PASS	Meet the requirement of limit
15.247(c)	Band Edge Measurement Limit: 20dB less than the peak value of fundamental frequency	PASS	Meet the requirement of limit

NOTE: The information of measurement uncertainty is available upon the customer's request.



3 GENERAL INFORMATION

3.1 GENERAL DESCRIPTION OF EUT

PRODUCT	Relay Omni
MODEL NO.	G1REL100
POWER SUPPLY	9Vdc from AC adapter
MODULATION TYPE	BPSK, QPSK, CCK
RADIO TECHNOLOGY	DSSS
TRANSFER RATE	1/2/5.5/11Mbps
FREQUENCY RANGE	2412MHz ~ 2462MHz
NUMBER OF CHANNEL	11
OUTPUT POWER	15.32dBm
ANTENNA TYPE	Omni-directional antenna
ANTENNA GAIN	14.2dBi
DATA CABLE	RJ 0.95m UTP cable, w/o core
I/O PORTS	RJ45
ASSOCIATED DEVICES	NA

NOTE:

1. The following AC adapter powered the EUT.

BRAND	HIGH POWER
MODEL	HPW-1009U
INPUT	100-240Vac, 1.0A Max 50-60Hz
OUTPUT	+9Vdc, 1.11A

2. For more detailed features description, please refer to the manufacturer's specifications or User's Manual.



3.2 DESCRIPTION OF TEST MODES

Eleven channels are provided to this EUT.

Channel	Frequency	Channel	Frequency
1	2412 MHz	7	2442 MHz
2	2417 MHz	8	2447 MHz
3	2422 MHz	9	2452 MHz
4	2427 MHz	10	2457 MHz
5	2432 MHz	11	2462 MHz
6	2437 MHz		

NOTE:

1. Below 1GHz, the channel 1, 6, and 11 were pre-tested in chamber. The channel 11, worst case one, was chosen for final test.
2. Above 1GHz, the channel 1, 6, and 11 were tested individually.
3. Data rate 11Mbps, the worst case, was chosen for final test.

3.3 GENERAL DESCRIPTION OF APPLIED STANDARDS

The EUT is a Relay Omni. According to the specifications of the manufacturer, it must comply with the requirements of the following standards:

FCC 47 CFR Part 15, Subpart C. (15.247)

ANSI C63.4: 1992

All test items have been performed and recorded as per the above standards.

NOTE: The EUT is also considered as a kind of computer peripheral, because the connection to computer is necessary for typical use. It has been verified to comply with the requirements of FCC Part 15, Subpart B, Class B (DoC). The test report has been issued separately.



3.4 DESCRIPTION OF SUPPORT UNITS

The EUT has been tested as an independent unit together with other necessary accessories or support units. The following support units or accessories were used to form a representative test configuration during the tests.

NO.	PRODUCT	BRAND	MODEL NO.	SERIAL NO.	FCC ID
1	NOTEBOOK	Compaq	N800C	470048-515	FCC DoC Approved

NO.	SIGNAL CABLE DESCRIPTION OF THE ABOVE SUPPORT UNITS
1	NA

NOTE: All power cords of the above support units are non shielded (1.8m).



3.5 CONFIGURATION OF SYSTEM UNDER TEST

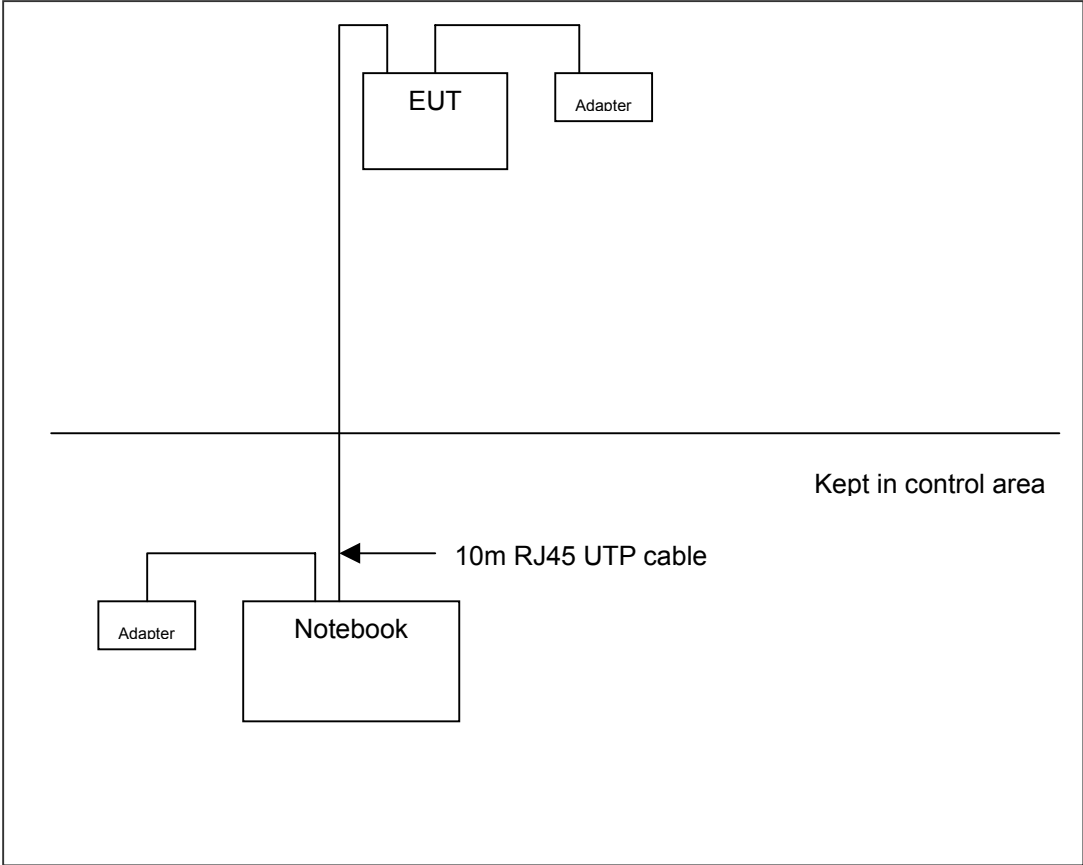



4 TEST TYPES AND RESULTS

4.1 CONDUCTED EMISSION MEASUREMENT

4.1.1 LIMITS OF CONDUCTED EMISSION MEASUREMENT

FREQUENCY OF EMISSION (MHz)	CONDUCTED LIMIT (dB μ V)	
	Quasi-peak	Average
0.15-0.5	66 to 56	56 to 46
0.5-5	56	46
5-30	60	50

- NOTE:**
1. The lower limit shall apply at the transition frequencies.
 2. The limit decreases in line with the logarithm of the frequency in the range of 0.15 to 0.50 MHz.
 3. All emanations from a class A/B digital device or system, including any network of conductors and apparatus connected thereto, shall not exceed the level of field strengths specified above.

4.1.2 TEST INSTRUMENTS

DESCRIPTION & MANUFACTURER	MODEL NO.	SERIAL NO.	CALIBRATED UNTIL
ROHDE & SCHWARZ Test Receiver	ESHS 30	828765/002	July 15, 2004
ROHDE & SCHWARZ Artificial Mains Network (for EUT)	ESH3-Z5	835239/001	Apr. 28, 2004
ROHDE & SCHWARZ Artificial Mains Network (for peripherals)	ESH3-Z5	835239/002	Apr. 28, 2004
*ROHDE & SCHWARZ 4-wire ISN	ENY41	935154/007	Apr. 30, 2004
*ROHDE & SCHWARZ 2-wire ISN	ENY22	833823/026	Apr. 30, 2004
Software	Cond-V2M3	NA	NA
RF cable (JYEBAO)	5D-FB	Cable-C09.01	May 23, 2004
SUHNTER Terminator (For ROHDE & SCHWARZ LISN)	65BNC-5001	E1-010789	Jun. 04, 2004

- NOTE:**
1. The calibration interval of the above test instruments is 12 months and the calibrations are traceable to NML/ROC and NIST/USA.
 2. "*": These equipment are used for conducted telecom port test only (if tested).
 3. The test was performed in ADT Shielded Room No. 9.
 4. The VCCI Site Registration No. is C-1312.



4.1.3 TEST PROCEDURES

- a. The EUT was placed 0.4 meters from the conducting wall of the shielded room with EUT being connected to the power mains through a line impedance stabilization network (LISN). Other support units were connected to the power mains through another LISN. The two LISNs provide 50 ohm/ 50uH of coupling impedance for the measuring instrument.
- b. Both lines of the power mains connected to the EUT were checked for maximum conducted interference.
- c. The frequency range from 150kHz to 30MHz was searched. Emission levels over 10dB under the prescribed limits could not be reported

4.1.4 DEVIATION FROM TEST STANDARD

No deviation

4.1.5 TEST SETUP

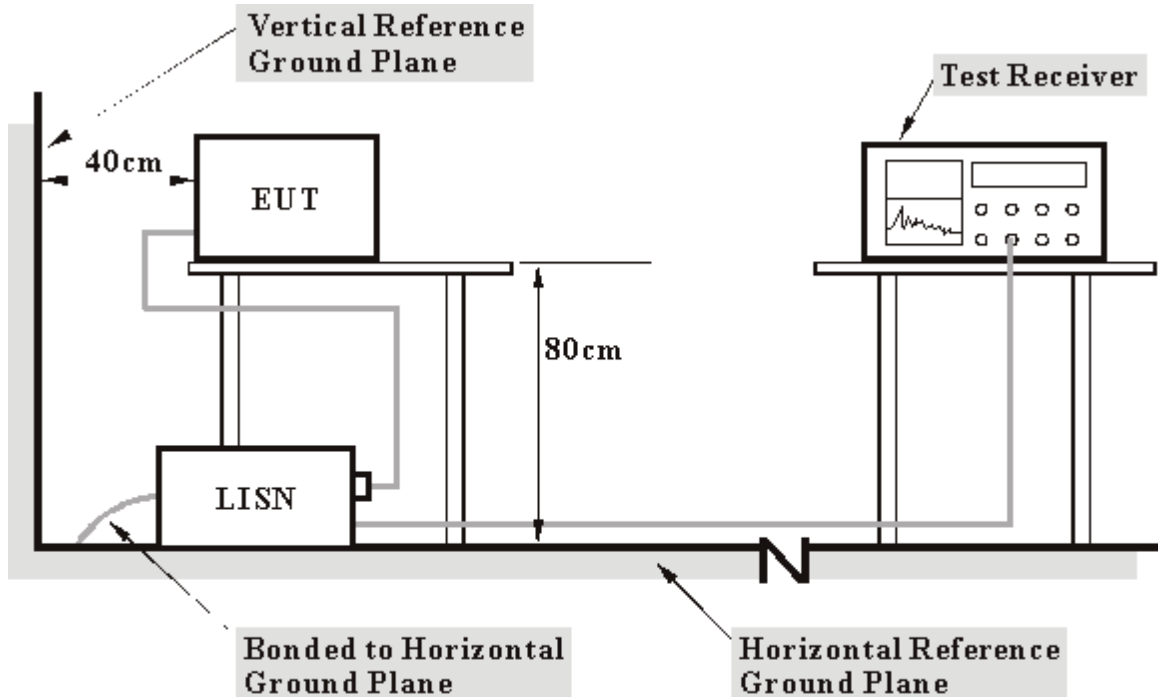

- Note:**
1. Support units were connected to second LISN.
 2. Both of LISNs (AMN) 80 cm from EUT and at the least 80 cm from other units and other metal planes support units.

For the actual test configuration, please refer to the related item – Photographs of the Test Configuration.

4.1.6 EUT OPERATING CONDITIONS

- a. Placed the EUT on the testing table.
- b. Prepared another computer system to act as a communication partner and placed it outside of testing area.
- c. The communication partner ran a test program to enable EUT under transmission/receiving condition continuously at specific channel frequency via an RJ45 cable.
- d. The communication partner sent data to EUT by command "PING".



4.1.7 TEST RESULTS

EUT	Relay Omni	MODEL	G1REL100
CHANNEL	Channel 1	6dB BANDWIDTH	9kHz
INPUT POWER (SYSTEM)	120Vac, 60 Hz	PHASE	Line (L)
ENVIRONMENTAL CONDITIONS	32deg.C, 50%RH, 991hPa	TESTED BY: Steven Lu	

No	Freq. [MHz]	Corr. Factor (dB)	Reading Value		Emission Level		Limit		Margin	
			[dB (uV)]		[dB (uV)]		[dB (uV)]		(dB)	
			Q.P.	AV.	Q.P.	AV.	Q.P.	AV.	Q.P.	AV.
1	0.159	0.10	39.58	-	39.68	-	65.52	55.52	-25.84	-
2	0.318	0.16	40.29	-	40.45	-	59.75	49.75	-19.30	-
3	0.560	0.20	42.50	-	42.70	-	56.00	46.00	-13.30	-
4	0.804	0.20	42.56	-	42.76	-	56.00	46.00	-13.24	-
5	1.891	0.20	39.34	-	39.54	-	56.00	46.00	-16.46	-
6	4.651	0.33	44.32	-	44.65	-	56.00	46.00	-11.35	-

- REMARKS:**
1. Q.P. and AV. are abbreviations of quasi-peak and average individually.
 2. "-": The Quasi-peak reading value also meets average limit and measurement with the average detector is unnecessary.
 3. The emission levels of other frequencies were very low against the limit.
 4. Margin value = Emission level - Limit value
 5. Correction factor = Insertion loss + Cable loss
 6. Emission Level = Correction Factor + Reading Value.

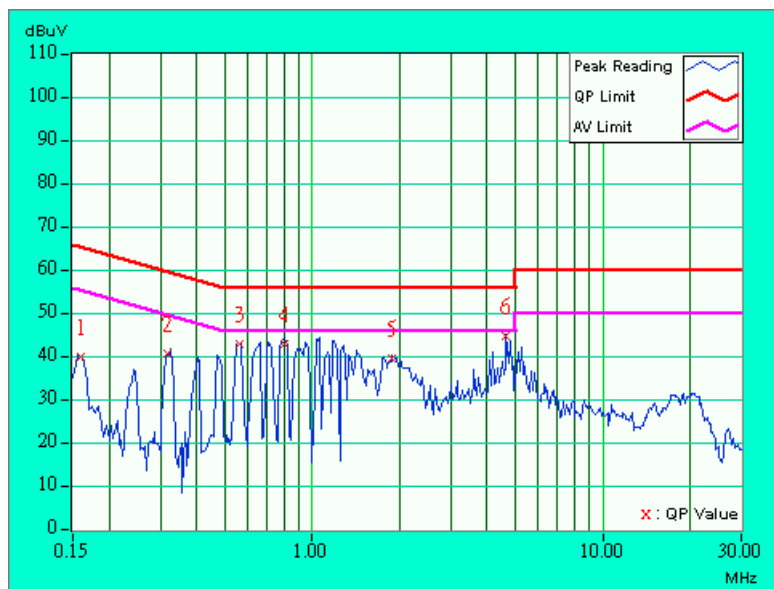



EUT	Relay Omni	MODEL	G1REL100
CHANNEL	Channel 1	6dB BANDWIDTH	9kHz
INPUT POWER (SYSTEM)	120Vac, 60 Hz	PHASE	Neutral (N)
ENVIRONMENTAL CONDITIONS	32deg.C, 50%RH, 991hPa	TESTED BY: Steven Lu	

No	Freq. [MHz]	Corr. Factor (dB)	Reading Value		Emission Level		Limit		Margin	
			[dB (uV)]		[dB (uV)]		[dB (uV)]		(dB)	
			Q.P.	AV.	Q.P.	AV.	Q.P.	AV.	Q.P.	AV.
1	0.159	0.10	40.38	-	40.48	-	65.52	55.52	-25.04	-
2	0.321	0.16	40.53	-	40.69	-	59.69	49.69	-19.00	-
3	0.564	0.20	41.98	-	42.18	-	56.00	46.00	-13.82	-
4	0.807	0.20	42.82	-	43.02	-	56.00	46.00	-12.98	-
5	1.768	0.20	37.90	-	38.10	-	56.00	46.00	-17.90	-
6	4.662	0.23	44.17	-	44.40	-	56.00	46.00	-11.60	-

- REMARKS:**
1. Q.P. and AV. are abbreviations of quasi-peak and average individually.
 2. "-": The Quasi-peak reading value also meets average limit and measurement with the average detector is unnecessary.
 3. The emission levels of other frequencies were very low against the limit.
 4. Margin value = Emission level - Limit value
 5. Correction factor = Insertion loss + Cable loss
 6. Emission Level = Correction Factor + Reading Value.

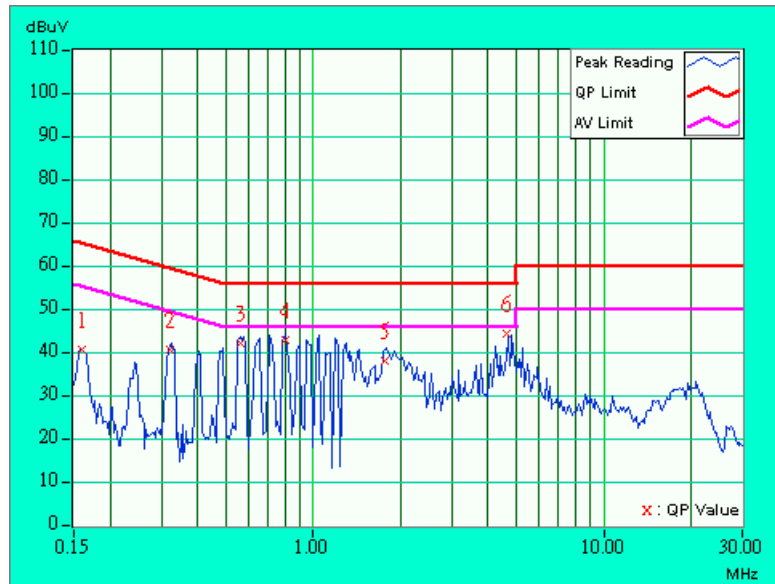



EUT	Relay Omni	MODEL	G1REL100
CHANNEL	Channel 6	6dB BANDWIDTH	9kHz
INPUT POWER (SYSTEM)	120Vac, 60 Hz	PHASE	Line (L)
ENVIRONMENTAL CONDITIONS	32deg.C, 50%RH, 991hPa	TESTED BY: Steven Lu	

No	Freq. [MHz]	Corr. Factor (dB)	Reading Value [dB (uV)]		Emission Level [dB (uV)]		Limit [dB (uV)]		Margin (dB)	
			Q.P.	AV.	Q.P.	AV.	Q.P.	AV.	Q.P.	AV.
			1	0.156	0.10	39.94	-	40.04	-	65.67
2	0.320	0.16	39.89	-	40.05	-	59.71	49.71	-19.66	-
3	0.559	0.20	41.78	-	41.98	-	56.00	46.00	-14.02	-
4	0.795	0.20	42.67	-	42.87	-	56.00	46.00	-13.13	-
5	1.171	0.20	42.66	-	42.86	-	56.00	46.00	-13.14	-
6	4.637	0.33	43.86	-	44.19	-	56.00	46.00	-11.81	-

- REMARKS:**
1. Q.P. and AV. are abbreviations of quasi-peak and average individually.
 2. "-": The Quasi-peak reading value also meets average limit and measurement with the average detector is unnecessary.
 3. The emission levels of other frequencies were very low against the limit.
 4. Margin value = Emission level - Limit value
 5. Correction factor = Insertion loss + Cable loss
 6. Emission Level = Correction Factor + Reading Value.

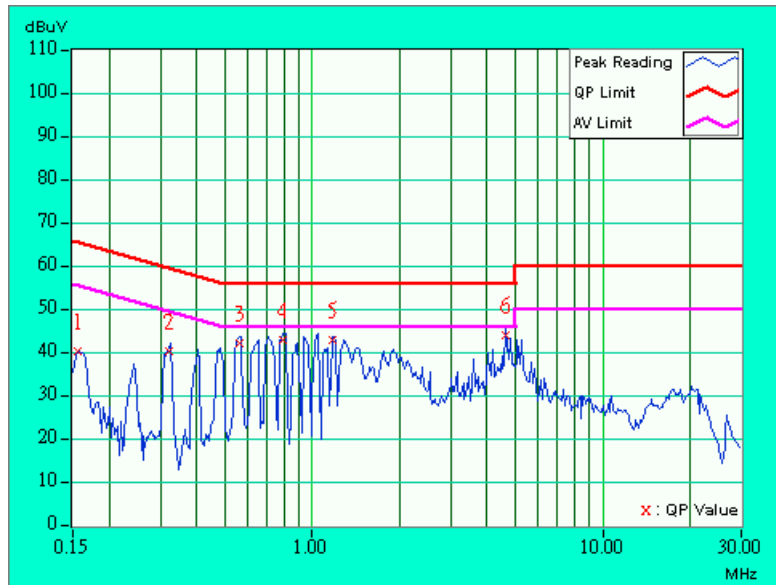



EUT	Relay Omni	MODEL	G1REL100
CHANNEL	Channel 6	6dB BANDWIDTH	9kHz
INPUT POWER (SYSTEM)	120Vac, 60 Hz	PHASE	Neutral (N)
ENVIRONMENTAL CONDITIONS	32deg.C, 50%RH, 991hPa	TESTED BY: Steven Lu	

No	Freq. [MHz]	Corr. Factor (dB)	Reading Value [dB (uV)]		Emission Level [dB (uV)]		Limit [dB (uV)]		Margin (dB)	
			Q.P.	AV.	Q.P.	AV.	Q.P.	AV.	Q.P.	AV.
			1	0.162	0.10	40.18	-	40.28	-	65.36
2	0.324	0.16	40.77	-	40.93	-	59.60	49.60	-18.67	-
3	0.555	0.20	42.72	-	42.92	-	56.00	46.00	-13.08	-
4	0.796	0.20	42.81	-	43.01	-	56.00	46.00	-12.99	-
5	4.627	0.23	44.50	-	44.73	-	56.00	46.00	-11.27	-
6	5.075	0.25	41.75	-	42.00	-	60.00	50.00	-18.00	-

- REMARKS:**
1. Q.P. and AV. are abbreviations of quasi-peak and average individually.
 2. "-": The Quasi-peak reading value also meets average limit and measurement with the average detector is unnecessary.
 3. The emission levels of other frequencies were very low against the limit.
 4. Margin value = Emission level - Limit value
 5. Correction factor = Insertion loss + Cable loss
 6. Emission Level = Correction Factor + Reading Value.

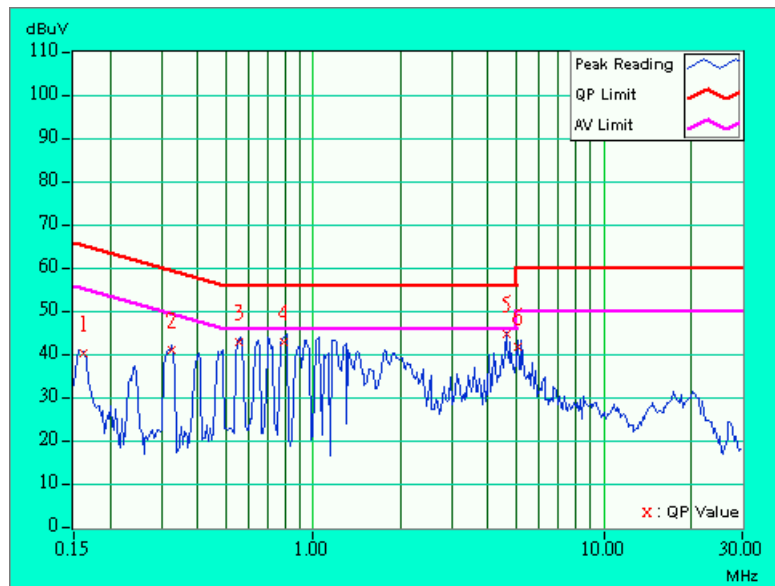



EUT	Relay Omni	MODEL	G1REL100
CHANNEL	Channel 11	6dB BANDWIDTH	9kHz
INPUT POWER (SYSTEM)	120Vac, 60 Hz	PHASE	Line (L)
ENVIRONMENTAL CONDITIONS	32deg.C, 50%RH, 991hPa	TESTED BY: Steven Lu	

No	Freq. [MHz]	Corr. Factor (dB)	Reading Value		Emission Level		Limit		Margin	
			[dB (uV)]		[dB (uV)]		[dB (uV)]		(dB)	
			Q.P.	AV.	Q.P.	AV.	Q.P.	AV.	Q.P.	AV.
1	0.156	0.10	39.60	-	39.70	-	65.67	55.67	-25.97	-
2	0.318	0.16	40.11	-	40.27	-	59.76	49.76	-19.49	-
3	0.555	0.20	42.52	-	42.72	-	56.00	46.00	-13.28	-
4	0.795	0.20	43.03	-	43.23	-	56.00	46.00	-12.77	-
5	1.174	0.20	42.92	-	43.12	-	56.00	46.00	-12.88	-
6	4.615	0.33	44.80	-	45.13	-	56.00	46.00	-10.87	-

- REMARKS:**
1. Q.P. and AV. are abbreviations of quasi-peak and average individually.
 2. "-": The Quasi-peak reading value also meets average limit and measurement with the average detector is unnecessary.
 3. The emission levels of other frequencies were very low against the limit.
 4. Margin value = Emission level - Limit value
 5. Correction factor = Insertion loss + Cable loss
 6. Emission Level = Correction Factor + Reading Value.

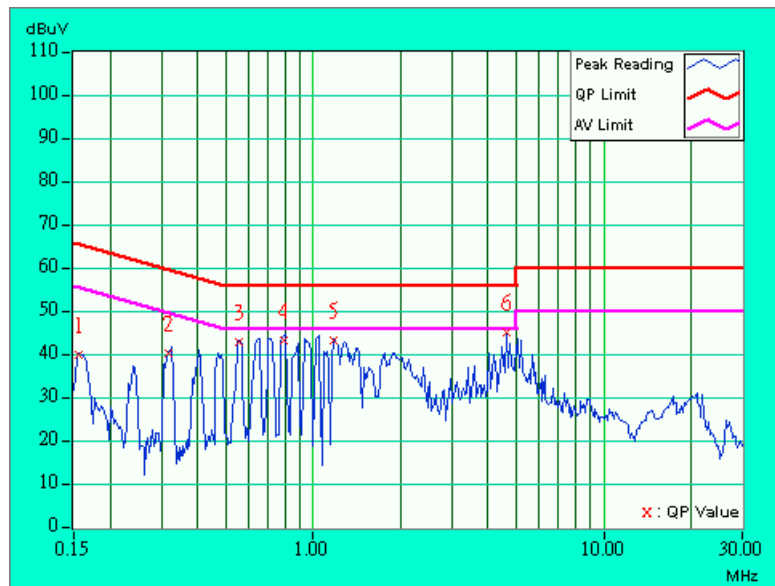



EUT	Relay Omni	MODEL	G1REL100
CHANNEL	Channel 11	6dB BANDWIDTH	9kHz
INPUT POWER (SYSTEM)	120Vac, 60 Hz	PHASE	Neutral (N)
ENVIRONMENTAL CONDITIONS	32deg.C, 50%RH, 991hPa	TESTED BY: Steven Lu	

No	Freq. [MHz]	Corr. Factor (dB)	Reading Value		Emission Level		Limit		Margin	
			[dB (uV)]		[dB (uV)]		[dB (uV)]		(dB)	
			Q.P.	AV.	Q.P.	AV.	Q.P.	AV.	Q.P.	AV.
1	0.162	0.10	40.20	-	40.30	-	65.36	55.36	-25.06	-
2	0.321	0.16	40.53	-	40.69	-	59.68	49.68	-18.99	-
3	0.555	0.20	42.80	-	43.00	-	56.00	46.00	-13.00	-
4	1.048	0.20	42.92	-	43.12	-	56.00	46.00	-12.88	-
5	4.622	0.23	44.40	-	44.63	-	56.00	46.00	-11.37	-
6	5.017	0.25	35.56	-	35.81	-	60.00	50.00	-24.19	-

- REMARKS:**
1. Q.P. and AV. are abbreviations of quasi-peak and average individually.
 2. "-": The Quasi-peak reading value also meets average limit and measurement with the average detector is unnecessary.
 3. The emission levels of other frequencies were very low against the limit.
 4. Margin value = Emission level - Limit value
 5. Correction factor = Insertion loss + Cable loss
 6. Emission Level = Correction Factor + Reading Value.

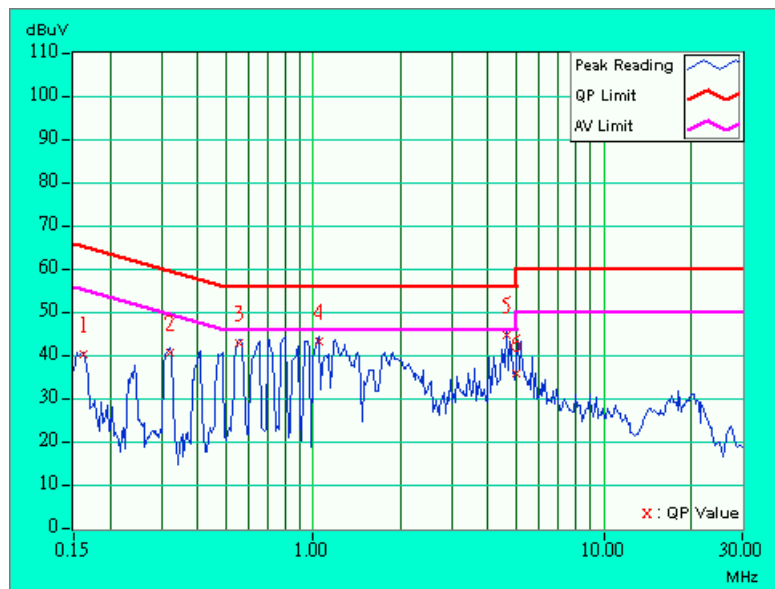



4.2 RADIATED EMISSION MEASUREMENT

4.2.1 LIMITS OF RADIATED EMISSION MEASUREMENT

Emissions radiated outside of the specified bands, shall be according to the general radiated limits in 15.209 as following:

Frequencies (MHz)	Field strength (microvolts/meter)	Measurement distance (meters)
0.009-0.490	2400/F(kHz)	300
0.490-1.705	24000/F(kHz)	30
1.705-30.0	30	30
30-88	100	3
88-216	150	3
216-960	200	3
Above 960	500	3

NOTE:

1. The lower limit shall apply at the transition frequencies.
2. Emission level (dBuV/m) = 20 log Emission level (uV/m).
3. As shown in 15.35(b), for frequencies above 1000MHz, the field strength limits are based on average detector, however, the peak field strength of any emission shall not exceed the maximum permitted average limits, specified above by more than 20dB under any condition of modulation.



4.2.2 TEST INSTRUMENTS

DESCRIPTION & MANUFACTURER	MODEL NO.	SERIAL NO.	CALIBRATED UNTIL
* HP Spectrum Analyzer	8593E	3911A07465	July 07, 2004
* HP Preamplifier	8447D	2432A03504	June 10, 2004
HP Preamplifier	8449B	3008A01201	Dec. 11, 2004
* HP Preamplifier	8449B	3008A01292	Aug. 11, 2004
SCHAFFNER Tunable Dipole Antenna	VHBA 9123	459	Jun. 26, 2004
SCHWARZBECK Tunable Dipole Antenna	UHA 9105	977	
* ROHDE & SCHWARZ TEST RECEIVER	ESMI	839013/007 839379/002	Feb. 13, 2004
*Schwarzbeck Antenna	VULB9168	137	Apr. 03, 2004
* SCHWARZBECK Horn Antenna	BBHA9120-D1	D130	June 30, 2004
*ADT. Turn Table	TT100	0306	NA
*ADT. Tower	AT100	0306	NA
*Software	ADT_Radiated_V 5.14	NA	NA
*TIMES RF cable	LL142	CABLE-CH6-01	Apr. 30, 2004

- NOTE:**
1. The calibration interval of the above test instruments is 12 months. And the calibrations are traceable to NML/ROC and NIST/USA.
 2. "*" = These equipment are used for the final measurement.
 3. The horn antenna and HP preamplifier (model: 8449B) are used only for the measurement of emission frequency above 1GHz if tested.
 4. The test was performed in ADT Chamber No. 6.



4.2.3 TEST PROCEDURES

- a. The EUT was placed on the top of a rotating table 0.8 meters above the ground at a 10 meter open area test site. The table was rotated 360 degrees to determine the position of the highest radiation.
- b. The EUT was set 3 meters away from the interference-receiving antenna, which was mounted on the top of a variable-height antenna tower.
- c. The antenna is a broadband antenna, and its height is varied from one meter to four meters above the ground to determine the maximum value of the field strength. Both horizontal and vertical polarizations of the antenna are set to make the measurement.
- d. For each suspected emission, the EUT was arranged to its worst case and then the antenna was tuned to heights from 1 meter to 4 meters and the rotatable table was turned from 0 degrees to 360 degrees to find the maximum reading.
- e. The test-receiver system was set to Peak Detect Function and Specified Bandwidth with Maximum Hold Mode.
- f. If the emission level of the EUT in peak mode was 10 dB lower than the limit specified, then testing could be stopped and the peak values of the EUT would be reported. Otherwise the emissions that did not have 10 dB margin would be re-tested one by one using peak, quasi-peak or average method as specified and then reported in a data sheet.

NOTE:

1. The resolution bandwidth and video bandwidth of test receiver/spectrum analyzer is 120kHz for Peak detection (PK) and Quasi-peak detection (QP) at frequency below 1GHz.
2. The resolution bandwidth and video bandwidth of test receiver/spectrum analyzer is 1 MHz for Peak detection at frequency above 1GHz.
3. The resolution bandwidth of test receiver/spectrum analyzer is 1 MHz and the video bandwidth is 300 Hz for Average detection (AV) at frequency above 1GHz.

4.2.4 DEVIATION FROM TEST STANDARD

No deviation

4.2.5 TEST SETUP

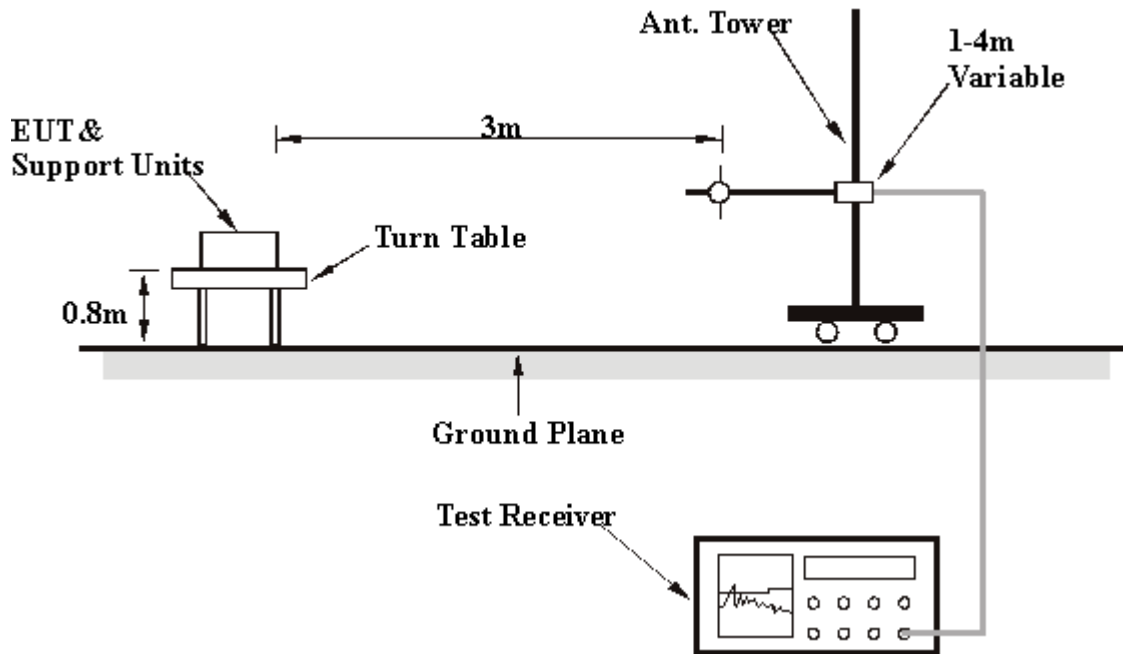

For the actual test configuration, please refer to the related item – Photographs of the Test Configuration.

4.2.6 EUT OPERATING CONDITIONS

Same as 4.1.6



4.2.7 TEST RESULTS

EUT	Relay Omni	MODEL	G1REL100
CHANNEL	Channel 11	FREQUENCY RANGE	Below 1000MHz
INPUT POWER (SYSTEM)	120Vac, 60 Hz	DETECTOR FUNCTION	Quasi-Peak
ENVIRONMENTAL CONDITIONS	25deg. C, 55%RH, 991hPa	TESTED BY: Steven Lu	

ANTENNA POLARITY & TEST DISTANCE: HORIZONTAL AT 3 M								
No.	Freq. (MHz)	Emission Level (dBuV/m)	Limit (dBuV/m)	Margin (dB)	Antenna Height (m)	Table Angle (Degree)	Raw Value (dBuV)	Correction Factor (dB/m)
1	55.27	25.30 QP	40.00	-14.70	4.00 H	16	11.70	13.60
2	500.42	32.70 QP	46.00	-13.30	1.25 H	94	12.70	20.00
3	782.28	26.40 QP	46.00	-19.60	1.50 H	199	0.90	25.50
4	873.65	26.40 QP	46.00	-19.60	1.25 H	349	-0.20	26.60
5	914.47	28.50 QP	46.00	-17.50	1.50 H	181	1.20	27.30
6	951.40	27.90 QP	46.00	-18.10	2.00 H	184	0.20	27.70

- REMARKS:**
1. Emission level(dBuV/m)=Raw Value(dBuV) + Correction Factor(dB/m)
 2. Correction Factor(dB/m) = Antenna Factor (dB/m) + Cable Factor (dB)
 3. The other emission levels were very low against the limit.
 4. Margin value = Emission level – Limit value.



EUT	Relay Omni	MODEL	G1REL100
CHANNEL	Channel 11	FREQUENCY RANGE	Below 1000MHz
INPUT POWER (SYSTEM)	120Vac, 60 Hz	DETECTOR FUNCTION	Quasi-Peak
ENVIRONMENTAL CONDITIONS	25deg. C, 55%RH, 991hPa	TESTED BY: Steven Lu	

ANTENNA POLARITY & TEST DISTANCE: VERTICAL AT 3 M

No.	Freq. (MHz)	Emission Level (dBuV/m)	Limit (dBuV/m)	Margin (dB)	Antenna Height (m)	Table Angle (Degree)	Raw Value (dBuV)	Correction Factor (dB/m)
1	66.93	28.70 QP	40.00	-11.30	1.00 V	163	16.40	12.30
2	125.25	33.00 QP	43.50	-10.50	1.25 V	94	20.30	12.70
3	158.30	36.30 QP	43.50	-7.20	1.25 V	208	22.10	14.20
4	197.17	37.30 QP	43.50	-6.20	3.00 V	49	25.90	11.40
5	218.56	34.30 QP	46.00	-11.70	3.00 V	49	22.20	12.10
6	337.13	36.50 QP	46.00	-9.50	1.25 V	124	20.40	16.10
7	368.24	36.90 QP	46.00	-9.10	1.00 V	52	20.00	16.90
8	477.09	37.70 QP	46.00	-8.30	1.50 V	49	18.00	19.70
9	498.48	40.50 QP	46.00	-5.50	2.00 V	49	20.50	20.00
10	584.01	32.80 QP	46.00	-13.20	3.00 V	19	10.60	22.10
11	605.39	31.20 QP	46.00	-14.80	1.00 V	109	8.50	22.70
12	634.55	33.10 QP	46.00	-12.90	1.00 V	52	10.10	23.00
13	685.09	34.40 QP	46.00	-11.60	1.00 V	139	10.60	23.80
14	720.08	32.50 QP	46.00	-13.50	1.25 V	295	8.00	24.50
15	758.96	35.20 QP	46.00	-10.80	1.25 V	34	9.80	25.40
16	792.00	39.40 QP	46.00	-6.60	1.75 V	175	13.80	25.60

- REMARKS:**
1. Emission level(dBuV/m)=Raw Value(dBuV) + Correction Factor(dB/m)
 2. Correction Factor(dB/m) = Antenna Factor (dB/m) + Cable Factor (dB)
 3. The other emission levels were very low against the limit.
 4. Margin value = Emission level – Limit value.



EUT	Relay Omni	MODEL	G1REL100
CHANNEL	Channel 1	FREQUENCY RANGE	Above 1000MHz
INPUT POWER (SYSTEM)	120Vac, 60 Hz	DETECTOR FUNCTION	Peak (PK) Average (AV)
ENVIRONMENTAL CONDITIONS	25deg. C, 60%RH, 991hPa	TESTED BY: Steven Lu	

ANTENNA POLARITY & TEST DISTANCE: HORIZONTAL AT 3 M								
No.	Freq. (MHz)	Emission Level (dBuV/m)	Limit (dBuV/m)	Margin (dB)	Antenna Height (m)	Table Angle (Degree)	Raw Value (dBuV)	Correction Factor (dB/m)
1	2038.00	42.10 PK	74.00	-31.90	1.47 H	204	11.10	31.00
2	*2412.00	100.10 PK			1.28 H	204	68.60	31.50
2	*2412.00	90.80 AV			1.28 H	204	59.30	31.50
3	4076.00	48.90 PK	74.00	-25.10	1.77 H	175	11.50	37.40
4	4824.00	52.90 PK	74.00	-21.10	1.24 H	184	15.10	37.90
4	4824.00	39.60 AV	54.00	-14.40	1.24 H	184	1.70	37.90
5	6114.00	48.20 PK	74.00	-25.80	2.09 H	175	8.40	39.80
6	8152.00	51.90 PK	74.00	-22.10	1.67 H	207	8.60	43.30

ANTENNA POLARITY & TEST DISTANCE: VERTICAL AT 3 M								
No.	Freq. (MHz)	Emission Level (dBuV/m)	Limit (dBuV/m)	Margin (dB)	Antenna Height (m)	Table Angle (Degree)	Raw Value (dBuV)	Correction Factor (dB/m)
1	2038.00	48.30 PK	74.00	-25.70	1.43 V	170	17.30	31.00
2	2390.00	52.90 PK	74.00	-21.10	1.13 V	202	21.40	31.50
2	2390.00	41.80 AV	54.00	-12.20	1.13 V	202	10.30	31.50
3	*2412.00	117.10 PK			1.13 V	202	85.60	31.50
3	*2412.00	106.00 AV			1.13 V	202	74.50	31.50
4	4076.00	48.10 PK	74.00	-25.90	1.03 V	173	10.60	37.40
5	4824.00	48.00 PK	74.00	-26.00	1.48 V	148	10.20	37.90
6	6114.00	49.60 PK	74.00	-24.40	1.00 V	168	9.80	39.80
7	8152.00	51.80 PK	74.00	-22.20	1.10 V	172	8.50	43.30
7	8152.00	41.50 AV	54.00	-12.50	1.10 V	172	-1.70	43.30

- REMARKS:**
1. Emission level (dBuV/m)=Raw Value (dBuV) + Correction Factor (dB)
 2. Correction Factor (dB/m) = Antenna Factor (dB/m) + Cable Factor (dB)
 3. The other emission levels were very low against the limit.
 4. Margin value = Emission level – Limit value.
 5. “ * “: Fundamental frequency.



EUT	Relay Omni	MODEL	G1REL100
CHANNEL	Channel 6	FREQUENCY RANGE	Above 1000MHz
INPUT POWER (SYSTEM)	120Vac, 60 Hz	DETECTOR FUNCTION	Peak (PK) Average (AV)
ENVIRONMENTAL CONDITIONS	25deg. C, 60%RH, 991hPa	TESTED BY: Steven Lu	

ANTENNA POLARITY & TEST DISTANCE: HORIZONTAL AT 3M								
No.	Freq. (MHz)	Emission Level (dBuV/m)	Limit (dBuV/m)	Margin (dB)	Antenna Height (m)	Table Angle (Degree)	Raw Value (dBuV)	Correction Factor (dB/m)
1	2063.00	44.50 PK	74.00	-29.50	1.49 H	126	13.50	31.00
2	*2437.00	101.00 PK			1.43 H	352	69.50	31.50
2	*2437.00	93.40 AV			1.43 H	352	61.80	31.50
3	4126.00	51.30 PK	74.00	-22.70	1.38 H	93	14.00	37.40
3	4126.00	46.00 AV	54.00	-8.00	1.38 H	93	8.60	37.40
4	4874.00	54.50 PK	74.00	-19.50	1.00 H	193	16.50	37.90
4	4874.00	42.70 AV	54.00	-11.30	1.00 H	193	4.70	37.90
5	6188.00	48.90 PK	74.00	-25.10	1.26 H	124	9.00	40.00
6	8252.00	52.40 PK	74.00	-21.60	1.00 H	203	8.90	43.50
6	8252.00	40.70 AV	54.00	-13.30	1.00 H	203	-2.70	43.50

ANTENNA POLARITY & TEST DISTANCE: VERTICAL AT 3M								
No.	Freq. (MHz)	Emission Level (dBuV/m)	Limit (dBuV/m)	Margin (dB)	Antenna Height (m)	Table Angle (Degree)	Raw Value (dBuV)	Correction Factor (dB/m)
1	2063.00	47.20 PK	74.00	-26.80	1.59 V	184	16.20	31.00
2	*2437.00	115.10 PK			1.04 V	204	83.60	31.50
2	*2437.00	106.70 AV			1.04 V	204	75.20	31.50
3	4126.00	52.00 PK	74.00	-22.00	1.06 V	178	14.60	37.40
3	4126.00	47.00 AV	54.00	-7.00	1.06 V	178	9.60	37.40
4	4874.00	51.40 PK	74.00	-22.60	1.20 V	118	13.50	37.90
4	4874.00	39.00 AV	54.00	-15.00	1.20 V	118	1.10	37.90
5	6189.00	48.30 PK	74.00	-25.70	1.03 V	184	8.40	40.00
6	8252.00	51.10 PK	74.00	-22.90	1.06 V	154	7.60	43.50
6	8252.00	40.90 AV	54.00	-13.10	1.06 V	154	-2.60	43.50

- REMARKS:**
1. Emission level (dBuV/m)=Raw Value (dBuV) + Correction Factor (dB)
 2. Correction Factor (dB/m) = Antenna Factor (dB/m) + Cable Factor (dB)
 3. The other emission levels were very low against the limit.
 4. Margin value = Emission level – Limit value.
 5. “ * “: Fundamental frequency.



EUT	Relay Omni	MODEL	G1REL100
CHANNEL	Channel 11	FREQUENCY RANGE	Above 1000MHz
INPUT POWER (SYSTEM)	120Vac, 60 Hz	DETECTOR FUNCTION	Peak (PK) Average (AV)
ENVIRONMENTAL CONDITIONS	25deg. C, 60%RH, 991hPa	TESTED BY: Steven Lu	

ANTENNA POLARITY & TEST DISTANCE: HORIZONTAL AT 3M								
No.	Freq. (MHz)	Emission Level (dBuV/m)	Limit (dBuV/m)	Margin (dB)	Antenna Height (m)	Table Angle (Degree)	Raw Value (dBuV)	Correction Factor (dB/m)
1	2088.00	45.70 PK	74.00	-28.30	1.18 H	217	14.60	31.10
2	*2462.00	99.40 PK			1.27 H	220	67.80	31.60
2	*2462.00	90.50 AV			1.27 H	220	59.00	31.60
3	4176.00	52.60 PK	74.00	-21.40	1.06 H	86	15.20	37.40
3	4176.00	49.00 AV	54.00	-5.00	1.06 H	86	11.60	37.40
4	4924.00	50.90 PK	74.00	-23.10	1.32 H	190	12.90	38.00
5	6264.00	48.40 PK	74.00	-25.60	1.07 H	175	8.30	40.00
6	8352.00	51.20 PK	74.00	-22.80	1.07 H	202	7.30	44.00

ANTENNA POLARITY & TEST DISTANCE: VERTICAL AT 3M								
No.	Freq. (MHz)	Emission Level (dBuV/m)	Limit (dBuV/m)	Margin (dB)	Antenna Height (m)	Table Angle (Degree)	Raw Value (dBuV)	Correction Factor (dB/m)
1	2088.00	47.90 PK	74.00	-26.10	1.00 V	136	16.80	31.10
2	*2462.00	115.10 PK			1.35 V	215	83.50	31.60
2	*2462.00	106.70 AV			1.35 V	215	75.20	31.60
3	2483.50	52.10 PK	74.00	-21.90	1.35 V	215	20.50	31.60
3	2483.50	43.70 AV	54.00	-10.30	1.35 V	215	12.10	31.60
4	4176.00	55.30 PK	74.00	-18.70	1.04 V	172	17.90	37.40
4	4176.00	51.80 AV	54.00	-2.20	1.04 V	172	14.50	37.40
5	4924.00	47.90 PK	74.00	-26.10	1.03 V	193	9.90	38.00
6	6263.96	49.10 PK	74.00	-24.90	1.00 V	185	9.10	40.00
7	8352.00	53.30 PK	74.00	-20.70	1.00 V	174	9.30	44.00
7	8352.00	42.60 AV	54.00	-11.40	1.00 V	174	-1.30	44.00

- REMARKS:**
1. Emission level (dBuV/m)=Raw Value (dBuV) + Correction Factor (dB)
 2. Correction Factor (dB/m) = Antenna Factor (dB/m) + Cable Factor (dB)
 3. The other emission levels were very low against the limit.
 4. Margin value = Emission level – Limit value.
 5. “ * “: Fundamental frequency.



4.3 6dB BANDWIDTH MEASUREMENT

4.3.1 LIMITS OF 6dB BANDWIDTH MEASUREMENT

The minimum of 6dB Bandwidth Measurement is 0.5 MHz.

4.3.2 TEST INSTRUMENTS

Description & Manufacturer	Model No.	Serial No.	Calibrated Until
R&S SPECTRUM ANALYZER	FSEK30	100049	Aug. 12, 2004

NOTE: The calibration interval of the above test instruments is 12 months and the calibrations are traceable to NML/ROC and NIST/USA.

4.3.3 TEST PROCEDURE

The transmitter output was connected to the spectrum analyzer through an attenuator. The bandwidth of the fundamental frequency was measured by spectrum analyzer with 100kHz RBW and 100kHz VBW. The 6dB bandwidth is defined as the total spectrum the power of which is higher than peak power minus 6dB.

4.3.4 DEVIATION FROM TEST STANDARD

No deviation

4.3.5 TEST SETUP

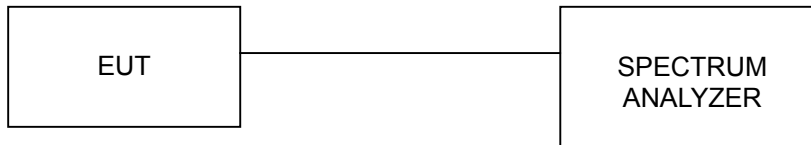

For the actual test configuration, please refer to the related Item – Photographs of the Test Configuration.

4.3.6 EUT OPERATING CONDITIONS

The software provided by client to enable the EUT under transmission condition continuously at lowest, middle and highest channel frequencies individually.



4.3.7 TEST RESULTS

EUT	Relay Omni	MODEL	G1REL100
ENVIRONMENTAL CONDITIONS	26deg. C, 63%RH, 991hPa	INPUT POWER (SYSTEM)	120Vac, 60 Hz
TESTED BY	Ansen Lei		

CHANNEL	CHANNEL FREQUENCY (MHz)	6dB BANDWIDTH (MHz)	MINIMUM LIMIT (MHz)	PASS/FAIL
1	2412	9.96	0.5	PASS
6	2437	10.64	0.5	PASS
11	2462	10.64	0.5	PASS



CH1

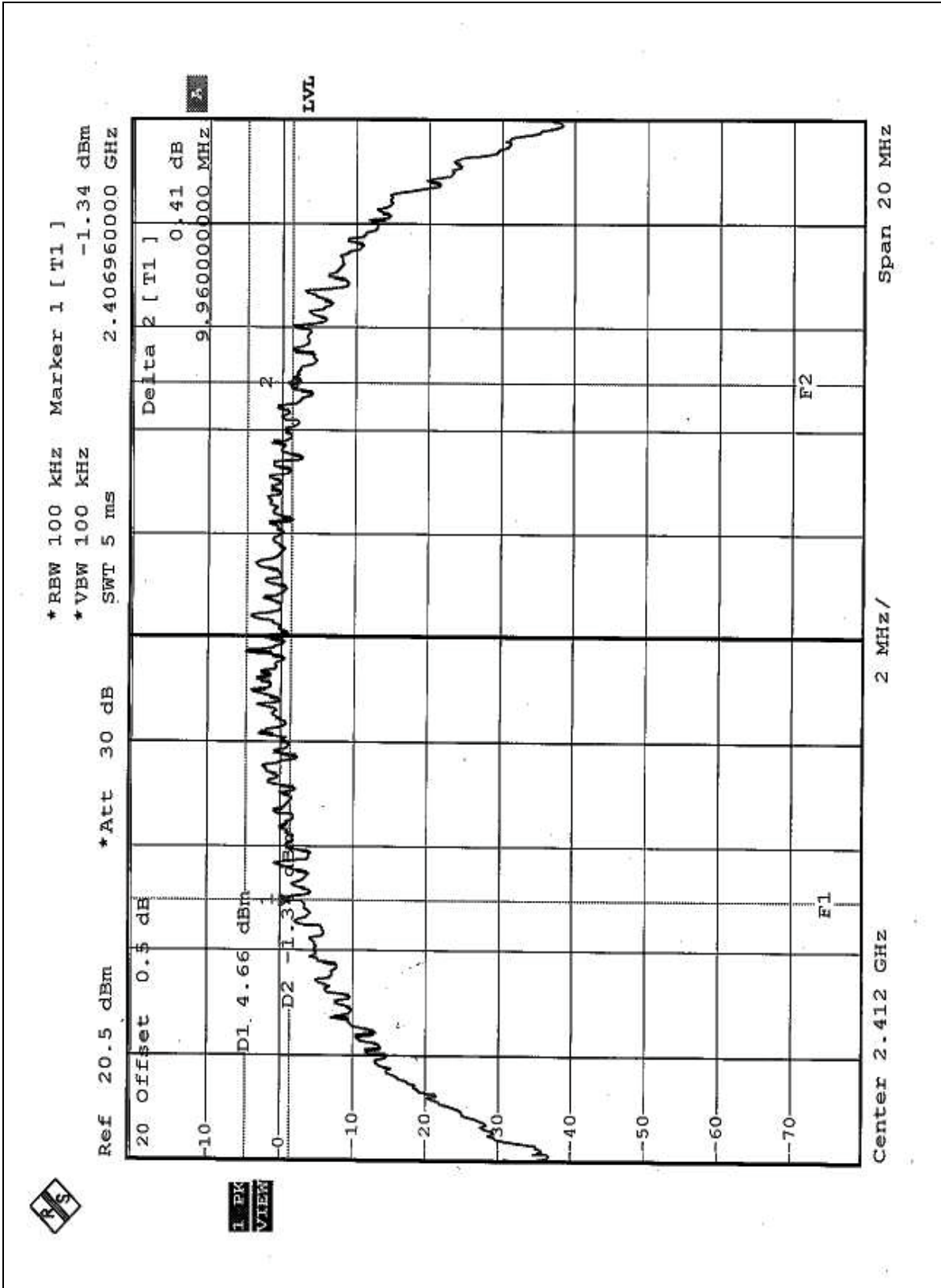



CH6

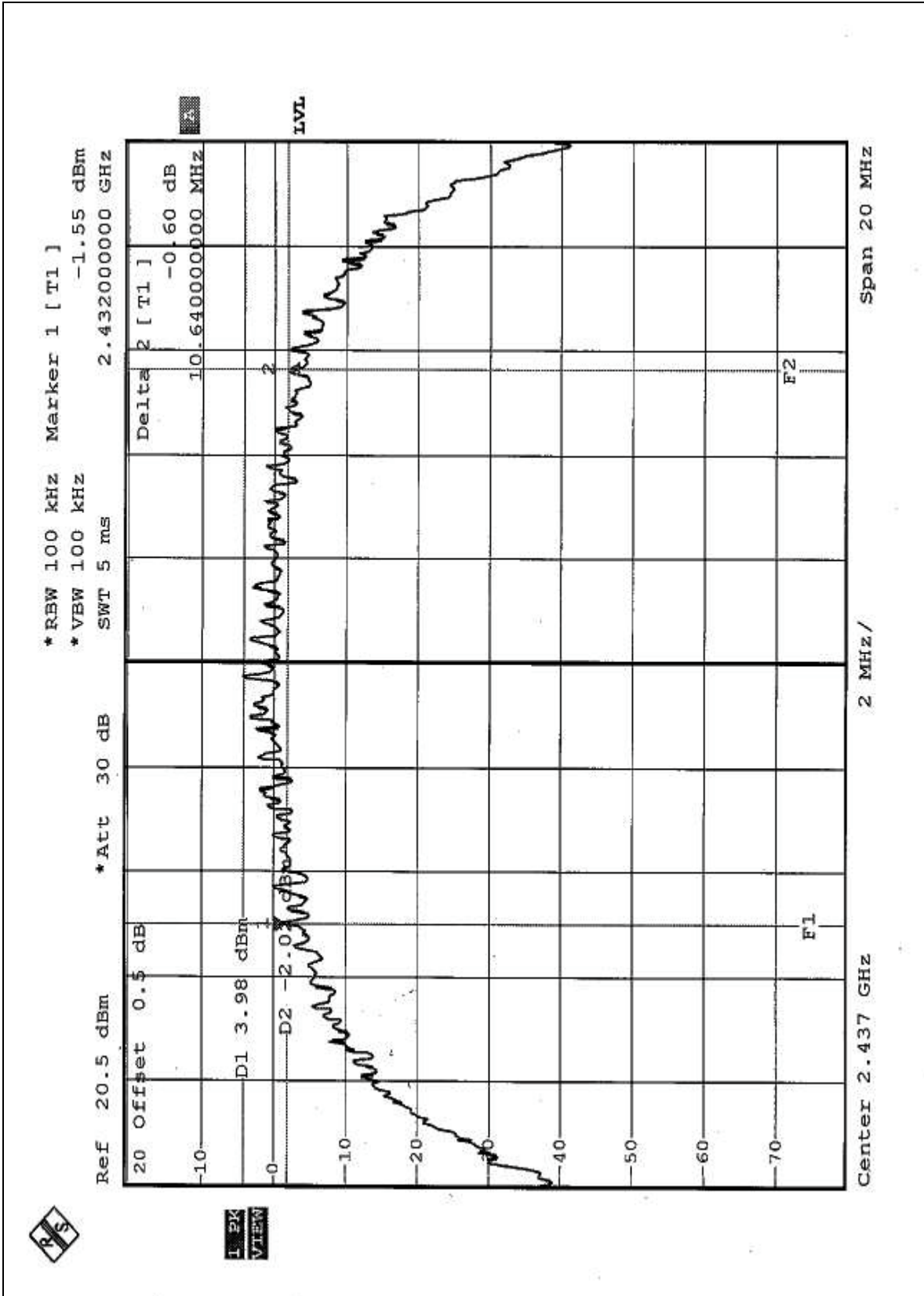



CH11

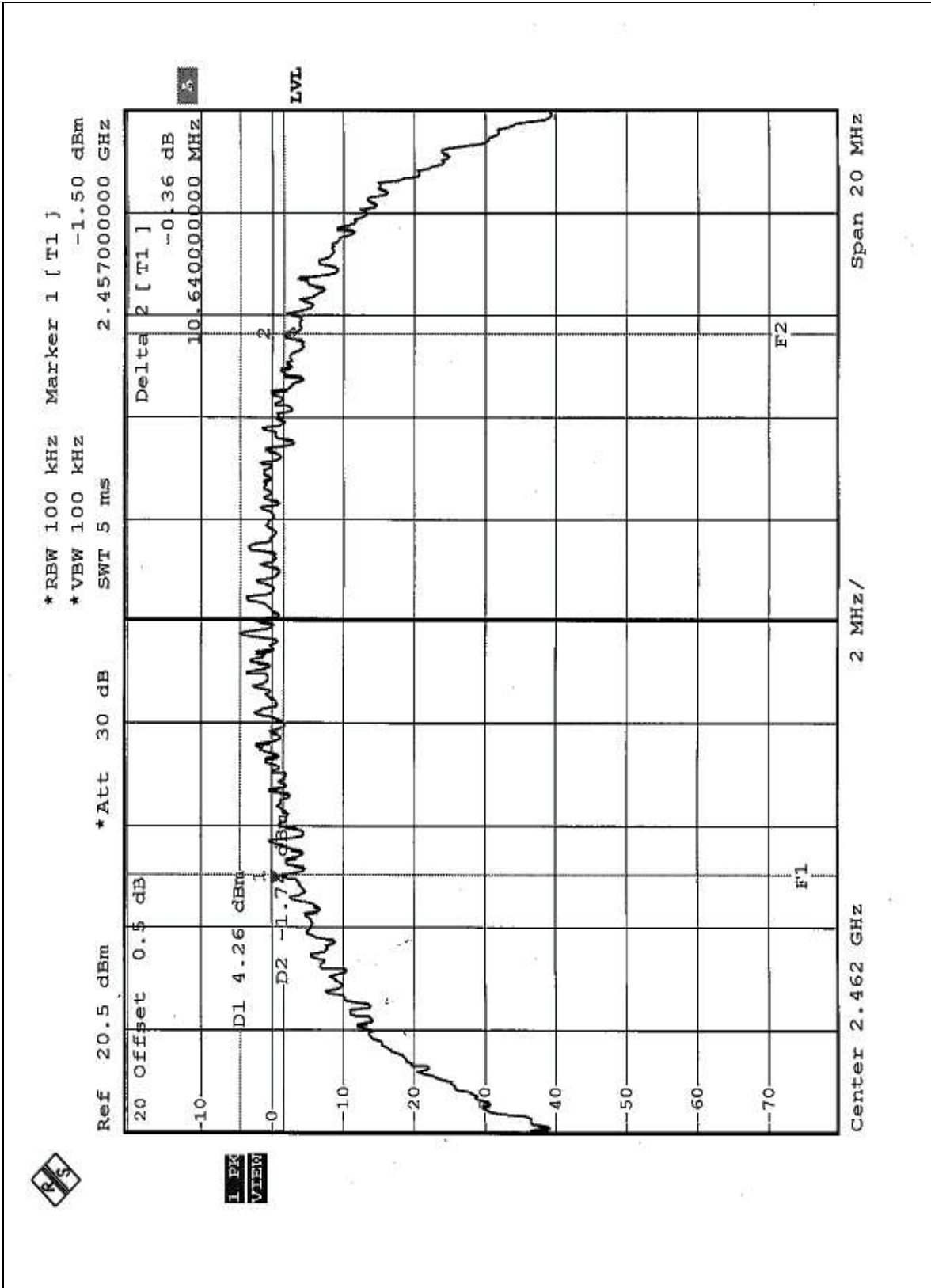



4.4 MAXIMUM PEAK OUTPUT POWER

4.4.1 LIMITS OF MAXIMUM PEAK OUTPUT POWER MEASUREMENT

The Maximum Peak Output Power Measurement is 30dBm.

4.4.2 TEST INSTRUMENTS

Description & Manufacturer	Model No.	Serial No.	Calibrated Until
R&S SPECTRUM ANALYZER	FSEK30	100049	Aug. 12, 2004
R&S SIGNAL GENERATOR	SMP04	100011	May 28, 2004
TEKTRONIX OSCILLOSCOPE	TDS 220	B048470	Mar. 05, 2004
NARDA DETECTOR	4503A	FSCM99899	NA

NOTE: The calibration interval of the above test instruments is 12 months and the calibrations are traceable to NML/ROC and NIST/USA.



4.4.3 TEST PROCEDURES

1. A detector was used on the output port of the EUT. An oscilloscope was used to read the response of the detector.
2. Replaced the EUT by the signal generator. The center frequency of the S.G was adjusted to the center frequency of the measured channel.
3. Adjusted the power to have the same reading on oscilloscope. Record the power level.

4.4.4 DEVIATION FROM TEST STANDARD

No deviation

4.4.5 TEST SETUP



4.4.6 EUT OPERATING CONDITIONS

Same as Item 4.3.6



4.4.7 TEST RESULTS

EUT	Relay Omni	MODEL	G1REL100
ENVIRONMENTAL CONDITIONS	26deg. C, 63%RH, 991hPa	INPUT POWER (SYSTEM)	120Vac, 60 Hz
TESTED BY	Ansen Lei		

CHANNEL	CHANNEL FREQUENCY (MHz)	PEAK POWER OUTPUT (dBm)	PEAK POWER LIMIT (dBm)	PASS/FAIL
1	2412	15.23	27	PASS
6	2437	15.32	27	PASS
11	2462	15.18	27	PASS

NOTE: According to 15.247 (b) (3), the maximum antenna gain 14.2dBi is higher than 6dBi, so the limit of peak power shall be reduced by 3dB.



4.5 POWER SPECTRAL DENSITY MEASUREMENT

4.5.1 LIMITS OF POWER SPECTRAL DENSITY MEASUREMENT

The Maximum of Power Spectral Density Measurement is 8dBm.

4.5.2 TEST INSTRUMENTS

Description & Manufacturer	Model No.	Serial No.	Calibrated Until
R&S SPECTRUM ANALYZER	FSEK30	100049	Aug. 12, 2004

NOTE: The calibration interval of the above test instruments is 12 months and the calibrations are traceable to NML/ROC and NIST/USA.

4.5.3 TEST PROCEDURE

The transmitter output was connected to the spectrum analyzer through an attenuator, the bandwidth of the fundamental frequency was measured with the spectrum analyzer using 3kHz RBW and 30kHz VBW, set sweep time=span/3kHz. The power spectral density was measured and recorded. The sweep time is allowed to be longer than span/3KHz for a full response of the mixer in the spectrum analyzer.

4.5.4 DEVIATION FROM TEST STANDARD

No deviation

4.5.5 TEST SETUP

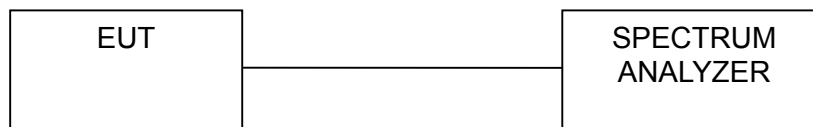

4.5.6 EUT OPERATING CONDITIONS

Same as 4.3.6



4.5.7 TEST RESULTS

EUT	Relay Omni	MODEL	G1REL100
ENVIRONMENTAL CONDITIONS	26deg. C, 63%RH, 991hPa	INPUT POWER (SYSTEM)	120Vac, 60 Hz
TESTED BY	Ansen Lei		

CHANNEL	CHANNEL FREQUENCY (MHz)	RF POWER LEVEL IN 3 kHz BW (dBm)	MAXIMUM LIMIT (dBm)	PASS/FAIL
1	2412	-11.03	8	PASS
6	2437	-11.59	8	PASS
11	2462	-11.52	8	PASS



CH1

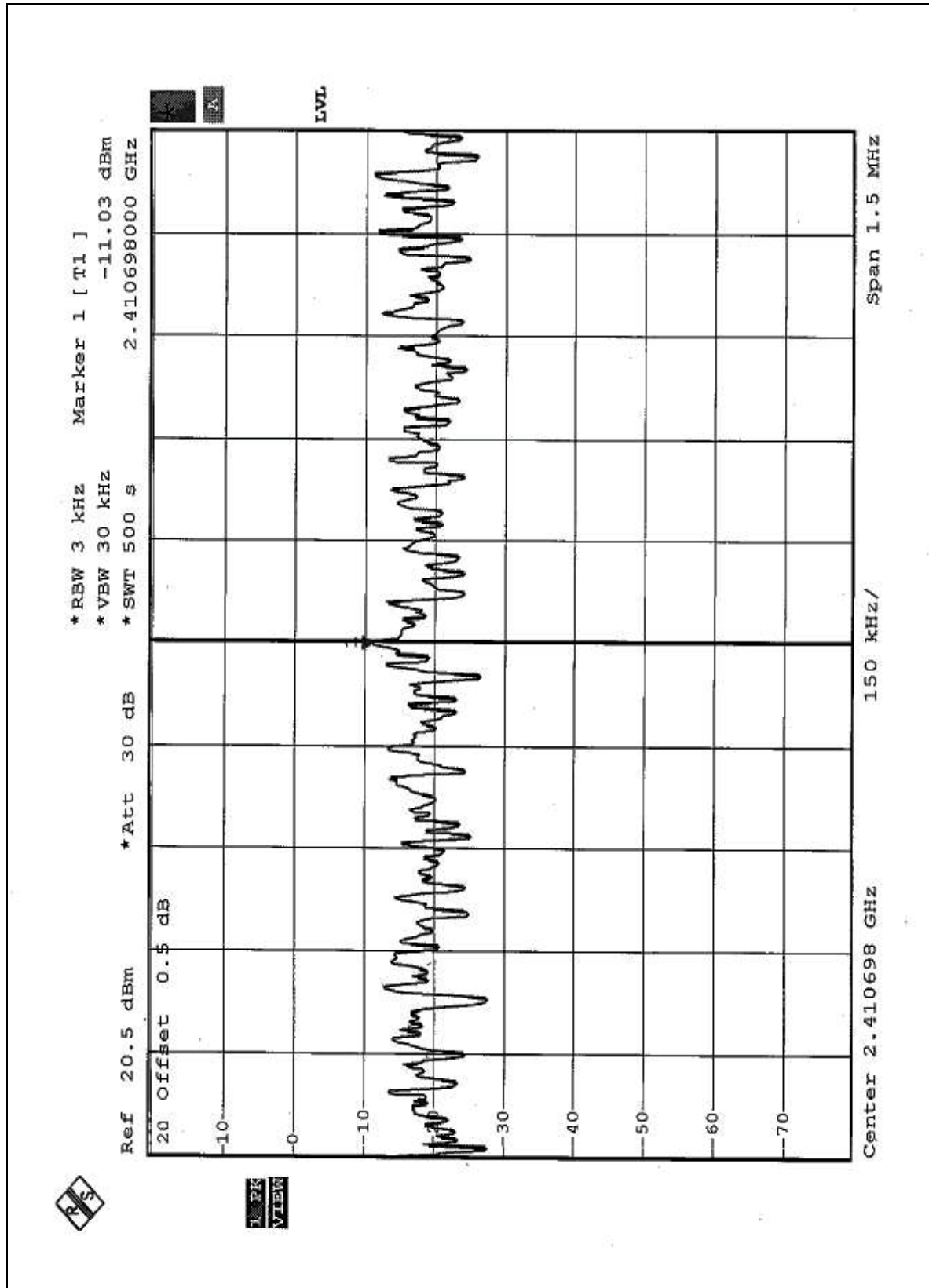



CH6

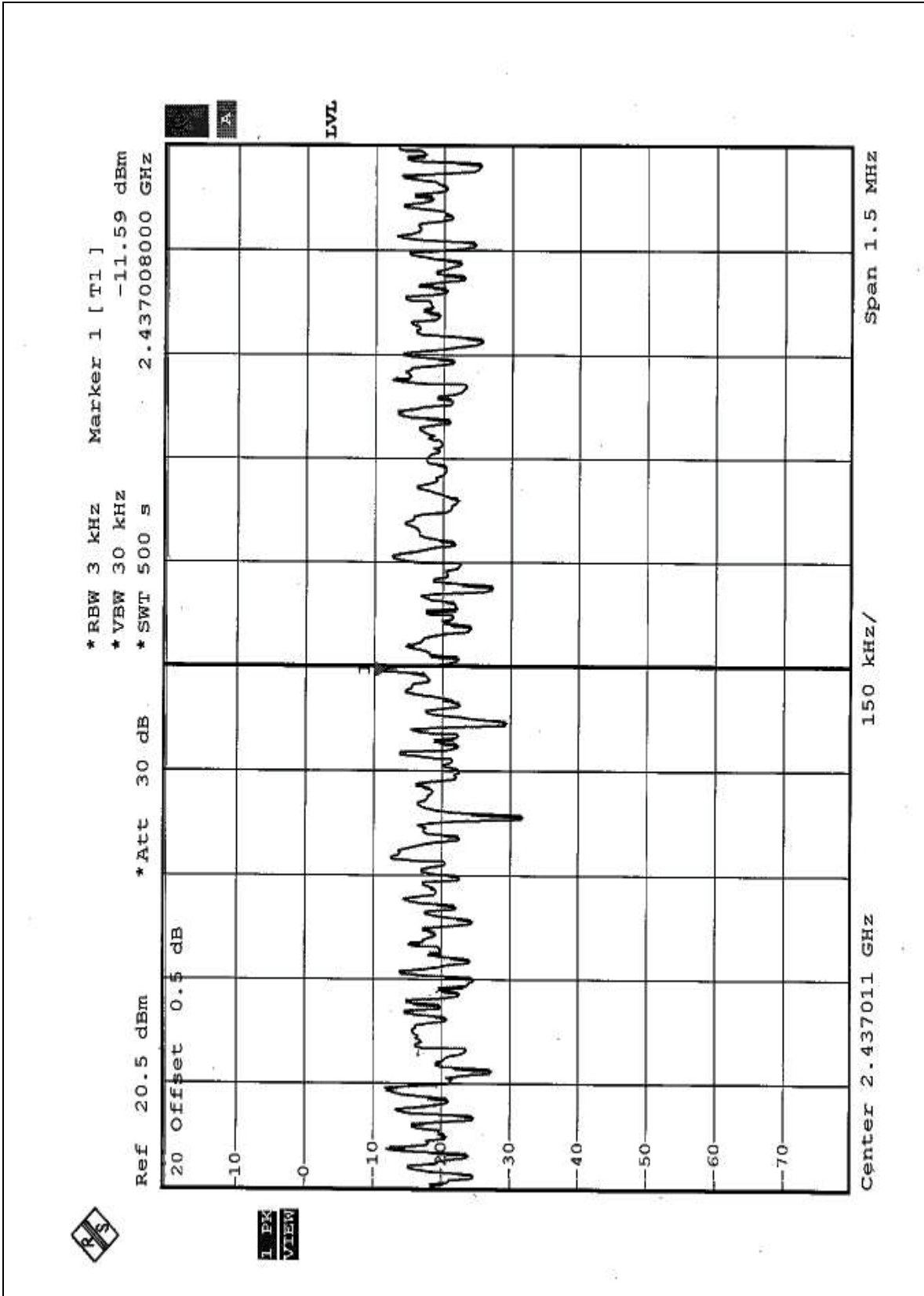



CH11

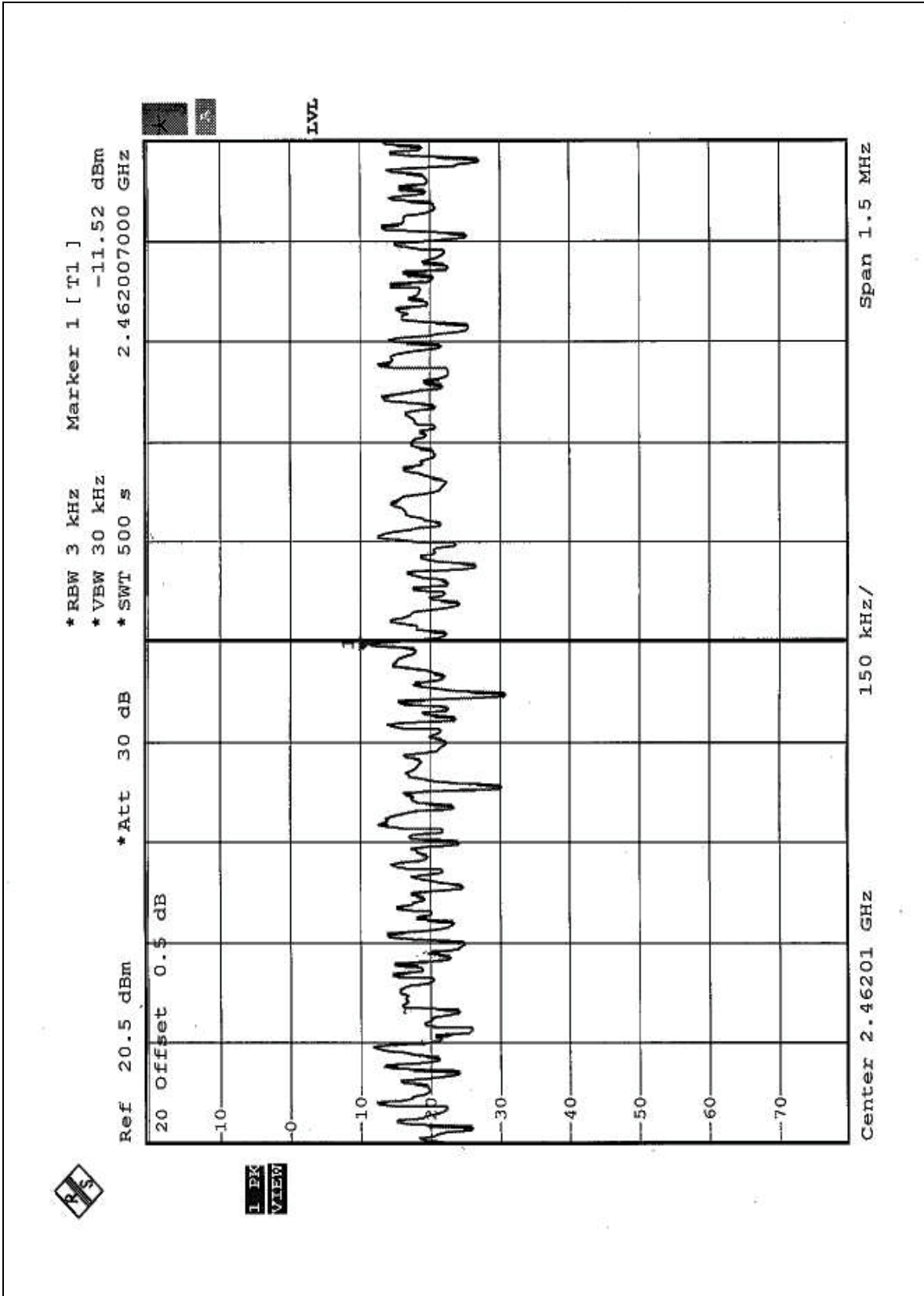



4.6 BAND EDGES MEASUREMENT

4.6.1 LIMITS OF BAND EDGES MEASUREMENT

Below -20dB of the highest emission level of operating band (in 100KHz Resolution Bandwidth).

4.6.2 TEST INSTRUMENTS

Description & Manufacturer	Model No.	Serial No.	Calibrated Until
R&S SPECTRUM ANALYZER	FSEK30	100049	Aug. 12, 2004

NOTE: The calibration interval of the above test instruments is 12 months and the calibrations are traceable to NML/ROC and NIST/USA.

4.6.3 TEST PROCEDURE

The transmitter output was connected to the spectrum analyzer via a low lose cable. Set both RBW and VBW of spectrum analyzer to 1MHz and 300Hz with suitable frequency span including 100MHz bandwidth from band edge. The band edges was measured and recorded.

4.6.4 DEVIATION FROM TEST STANDARD

No deviation



4.6.5 EUT OPERATING CONDITION

Same as Item 4.3.6

4.6.6 TEST RESULTS

The spectrum plots are attached on the following 2 pages. D2 line indicates the highest level, D1 line indicates the 20dB offset below D2. It shows compliance with the requirement in part 15.247(C).

NOTE1: The band edge emission plot of the on the following first page shows 62.33dB delta between carrier maximum power and local maximum emission in restrict band (2.3900GHz). The emission of carrier strength list in the test result of channel 1 at the item 4.2.7 is 106.00dBuV/m, so the maximum field strength in restrict band is $106.00-62.33=43.67$ dBuV/m which is under 54dBuV/m limit.

NOTE2: The band edge emission plot of the on the following second page shows 60.98dB delta between carrier maximum power and local maximum emission in restrict band (2.4835GHz). The emission of carrier strength list in the test result of channel 11 at the item 4.2.7 is 106.70dBuV/m, so the maximum field strength in restrict band is $106.70-60.98=45.72$ dBuV/m which is under 54dBuV/m limit.

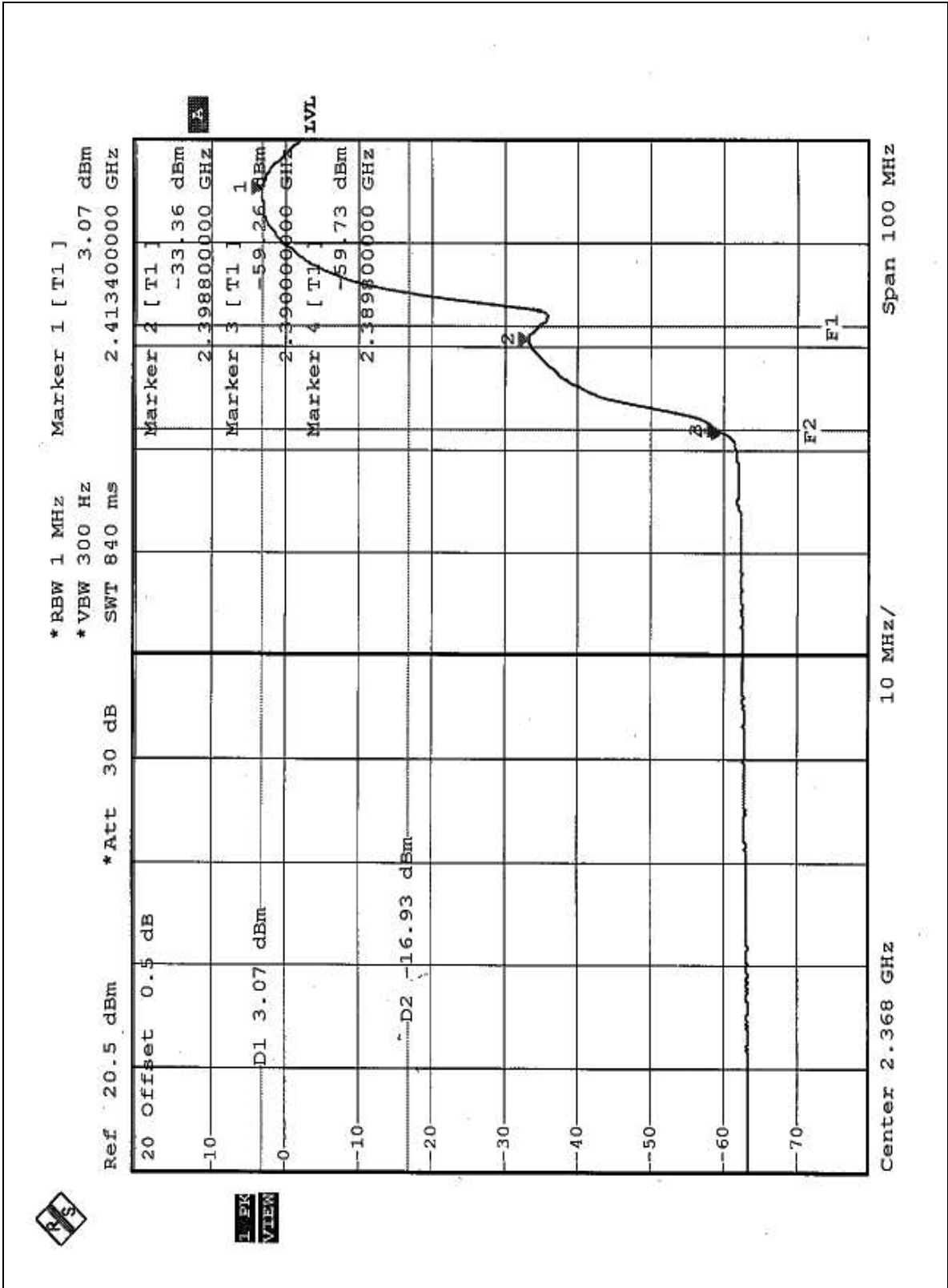

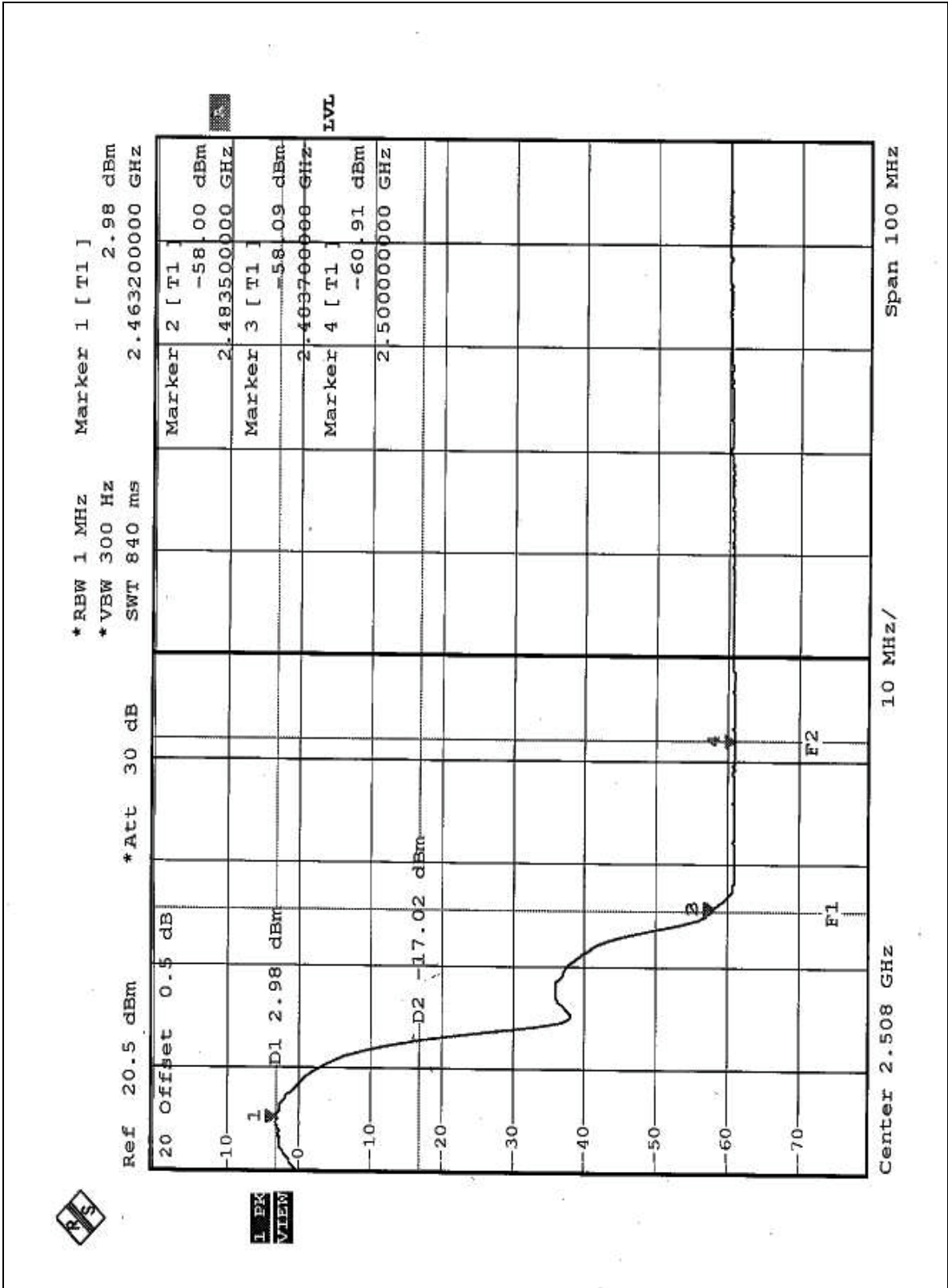



4.7 ANTENNA REQUIREMENT

4.7.1 STANDARD APPLICABLE

For intentional device, according to FCC 47 CFR Section 15.203, an intentional radiator shall be designed to ensure that no antenna other than that furnished by the responsible party shall be used with the device.

And according to FCC 47 CFR Section 15.247 (b), if transmitting antennas of directional gain greater than 6dBi are used, the power shall be reduced by the amount in dB that the directional gain of the antenna exceeds 6dBi.

4.7.2 ANTENNA CONNECTED CONSTRUCTION

The antenna type used in this product is Omni-directional antenna with MCX antenna connector. The maximum Gain of this antenna is 14.2dBi.

5 PHOTOGRAPHS OF THE TEST CONFIGURATION

CONDUCTED EMISSION TEST



RADIATED EMISSION TEST





6 INFORMATION ON THE TESTING LABORATORIES

We, ADT Corp., were founded in 1988 to provide our best service in EMC and Safety consultation. Our laboratories are accredited and approved by the following approval agencies according to ISO/IEC 17025, Guide 25 or EN 45001:

USA	FCC, NVLAP
Germany	TUV Rheinland
Japan	VCCI
New Zealand	MoC
Norway	NEMKO
R.O.C.	BSMI, DGT, CNLA

Copies of accreditation certificates of our laboratories obtained from approval agencies can be downloaded from our web site:

www.adt.com.tw/index.5/phtml.

If you have any comments, please feel free to contact us at the following:

Lin Kou EMC Lab:

Tel: 886-2-26052180

Fax: 886-2-26052943

Hsin Chu EMC Lab:

Tel: 886-35-935343

Fax: 886-35-935342

Lin Kou Safety Lab:

Tel: 886-2-26093195

Fax: 886-2-26093184

Lin Kou RF&Telecom Lab

Tel: 886-3-3270910

Fax: 886-3-3270892

Email: service@mail.adt.com.tw

Web Site: www.adt.com.tw

The address and road map of all our labs can be found in our web site also.