

FCC Part 15, Subpart C Test Report

FCC ID: RGR-KTWS2

Applicant: Stillwater Designs and Audio Inc.

Address: 3100 N Husband St. Stillwater, OK

Manufacturer: Dongguan Siyoto Electronics Co., Ltd.

Address: No.10, North 7th Street, Qiaotou Qiaodong Road, Qiaotou Town, Dongguan City, Guangdong Province, P.R.China

Product(s): Kicker TWS2 True Wireless Earbuds

Brand(s): KICKER

Test Model(s): 50KTWS2

Series Model(s): N/A

Test Date: Aug. 10, 2023 ~ Aug. 22, 2023

Issued Date: Aug. 30, 2023

Issued By: Hwa-Hsing (Dongguan) Testing Co., Ltd.

Address: No. 101, Building N1, Yuyuan 2 Road, Yuyuan Industrial Park, HuangJiang Town, Dongguan City, People's Republic of China

Test Firm Registration No.: 915896

Designation No.: CN1255

Standards: 47 CFR FCC Part 15, Subpart C (Section 15.247)
ANSI C63.10:2013

The above equipment has been tested by **Hwa-Hsing (Dongguan) Testing Co., Ltd.**, and found compliance with the requirement of the above standards. The test record, data evaluation & Equipment Under Test (EUT) configurations represented herein are true and accurate accounts of the measurements of the sample's EMC characteristics under the conditions specified in this report.

Prepared by :

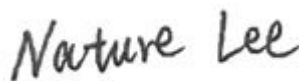

Nature Lee

Reviewed by :



Andy Yeh

Approved by :



Scott He

"This report is for your exclusive use. Any copying or replication of this report to or for any other person or entity, or use of our name or trademark, is permitted only with our prior written permission. This report sets forth our findings solely with respect to the test samples identified herein. Our report includes all the tests requested by you and the results thereof based upon the information that you provided to us. The report would be invalid without specific stamp of test institute and the signatures of tester and approver."

Lab: [Hwa-Hsing \(Dongguan\) Testing Co., Ltd.](#)

Address: [No. 101, Building N1, Yuyuan 2 Road, Yuyuan Industrial Park, HuangJiang Town, Dongguan City, People's Republic of China](#)

Tel: [0769-83078199](tel:0769-83078199)

Web.: www.hwa-hsing.com

E-Mail: customerservice.dg@hwa-hsing.com

Release

[Ver. 1.5](#)



Table of Contents

Release Control Record	4
1 Summary of Test Results.....	5
1.1 Measurement Uncertainty.....	5
1.2 Modification Record	5
2 General Information	6
2.1 General Description of EUT.....	6
2.2 Description of Test Modes.....	7
2.3 Test Mode Applicability and Tested Channel Detail	8
2.4 Description of Support Units.....	10
2.4.1 Configuration of System under Test	10
3 Test Types and Results	11
3.1 Radiated Emission and Band-edge Measurement.....	11
3.1.1 Limits of Radiated Emission and Band-edge Measurement	11
3.1.2 Test Instruments	12
3.1.3 Test Procedures.....	13
3.1.4 Deviation from Test Standard	14
3.1.5 Test Setup.....	15
3.1.6 EUT Operating Conditions.....	16
3.1.7 Test Results	17
3.2 Number of Hopping Frequency Used	29
3.2.1 Limits of Hopping Frequency Used Measurement	29
3.2.2 Test Setup.....	29
3.2.3 Test Instruments	29
3.2.4 Test Procedure	29
3.2.5 Deviation from Test Standard	29
3.2.6 Test Results	30
3.3 Dwell Time on Each Channel.....	31
3.3.1 Limits of Dwell Time on Each Channel Measurement.....	31
3.3.2 Test Setup.....	31
3.3.3 Test Instruments	31
3.3.4 Test Procedures.....	31
3.3.5 Deviation from Test Standard	31
3.3.6 Test Results	32
3.4 Channel Bandwidth.....	35
3.4.1 Limits of Channel Bandwidth Measurement.....	35
3.4.2 Test Setup.....	35
3.4.3 Test Instruments	35
3.4.4 Test Procedure	35
3.4.5 Deviation from Test Standard	35
3.4.6 EUT Operating Condition	35
3.4.7 Test Results	36
3.5 Occupied Bandwidth Measurement.....	38
3.5.1 Test Setup.....	38
3.5.2 Test Instruments	38
3.5.3 Test Procedure	38
3.5.4 Deviation from Test Standard	38
3.5.5 EUT Operating Conditions.....	38
3.5.6 Test Results	39

Lab: [Hwa-Hsing \(Dongguan\) Testing Co., Ltd.](#)

Address: [No. 101, Building N1, Yuyuan 2 Road, Yuyuan Industrial Park, Huangjiang Town, Dongguan City, People's Republic of China](#)

Tel: [0769-83078199](tel:0769-83078199)

Web.: www.hwa-hsing.com

E-Mail: customerservice.dg@hwa-hsing.com

Release

[Ver. 1.5](#)



- 3.6 Hopping Channel Separation..... 41
 - 3.6.1 Limits of Hopping Channel Separation Measurement..... 41
 - 3.6.2 Test Setup..... 41
 - 3.6.3 Test Instruments 41
 - 3.6.4 Test Procedure 41
 - 3.6.5 Deviation from Test Standard 41
 - 3.6.6 Test Results 42
- 3.7 Maximum Output Power 44
 - 3.7.1 Limits of Maximum Output Power Measurement 44
 - 3.7.2 Test Setup..... 44
 - 3.7.3 Test Instruments 44
 - 3.7.4 Test Procedure 44
 - 3.7.5 Deviation from Test Standard 45
 - 3.7.6 EUT Operating Condition 45
 - 3.7.7 Test Results 46
- 3.8 Conducted Out of Band Emission Measurement 49
 - 3.8.1 Limits of Conducted Out of Band Emission Measurement..... 49
 - 3.8.2 Test Setup..... 49
 - 3.8.3 Test Instruments 49
 - 3.8.4 Test Procedure 50
 - 3.8.5 Deviation from Test Standard 50
 - 3.8.6 EUT Operating Condition 50
 - 3.8.7 Test Results 51
- 4 Pictures of Test Arrangements 56**
- 5 Test Instruments 57**
- Appendix – Information on the Testing Laboratories 58**



Release Control Record

Issue No.	Description	Date Issued
23080202-RF-US-01	Original Release	Aug. 30, 2023

**1 Summary of Test Results**

47 CFR FCC Part 15, Subpart C (Section 15.247) KDB 558074 D01 15.247 Meas Guidance v05r02 ANSI C63.10:2013;			
FCC Clause	Test Item	Result	Remarks
15.247(a)(1) (iii)	Number of Hopping Frequency Used	Pass	Meet the requirement of limit.
15.247(a)(1) (iii)	Dwell Time on Each Channel	Pass	Meet the requirement of limit.
15.247(a)(1)	1. Hopping Channel Separation 2. Spectrum Bandwidth of a Frequency Hopping Sequence Spread Spectrum System	Pass	Meet the requirement of limit.
15.247(b)	Maximum Peak Output Power	Pass	Meet the requirement of limit.
---	Occupied Bandwidth Measurement	Pass	Reference only
15.205 & 209	Radiated Emissions	Pass	Meet the requirement of limit.
15.247(d)	Band Edge Measurement	Pass	Meet the requirement of limit.
15.247(d)	Antenna Port Emission	Pass	Meet the requirement of limit.
15.203	Antenna Requirement	Pass	No antenna connector is used.

Note1: If the Frequency Hopping System operating in 2400-2483.5MHz band and the output power less than 125mW. The hopping channel carrier frequencies separated by a minimum of 25kHz or two-thirds of the 20dB bandwidth of hopping channel whichever is greater.

Note2: The EUT has been verified to comply with the requirements of FCC Part 15, Subpart B, Class B (sDoC). The test report has been issued separately.

1.1 Measurement Uncertainty

Where relevant, the following measurement uncertainty levels have been estimated for tests performed on the EUTas specified in CISPR 16-4-2:

The listed uncertainties are the worst-case uncertainty for the entire range of measurement. Please note that the uncertainty values are provided for informational purposes only and are not used in determining the PASS/FAIL results.

Measurement	Frequency	Expanded Uncertainty (k=2) (\pm)
Radiated Emissions up to 1 GHz	9KHz ~ 30MHz	2.16 dB
	30MHz ~ 1000MHz	3.47 dB
Radiated Emissions above 1 GHz	1GHz ~ 18GHz	4.84 dB
	18GHz ~ 40GHz	4.67 dB

Note: This uncertainty represents an expanded uncertainty expressed at approximately the 95% confidence level using a coverage factor of k = 2.

1.2 Modification Record

There were no modifications required for compliance.

Lab: [Hwa-Hsing \(Dongguan\) Testing Co., Ltd.](#)

Address: [No. 101, Building N1, Yuyuan 2 Road, Yuyuan Industrial Park, HuangJiang Town, Dongguan City, People's Republic of China](#)

Tel: [0769-83078199](tel:0769-83078199)

Web.: www.hwa-hsing.com

E-Mail: customerservice.dg@hwa-hsing.com

Release

[Ver. 1.5](#)



2 General Information

2.1 General Description of EUT

Product(s)	Kicker TWS2 True Wireless Earbuds
Test Model(s)	50KTWS2
Sample No.	HS2308100001
Series Model(s)	N/A
Status of EUT	Engineering Prototype
Power Supply Rating	Charge case: Input: DC 5V from USB or DC 3.7V, 400mAh, 1.48Wh from battery; Output: DC 5V, 0.5A Each Headphones: Input: DC 5V from Charge case or DC 3.7V, 45mAh, 0.167Wh from battery
Modulation Type	GFSK, $\pi/4$ DQPSK, 8DPSK for FHSS
Transfer Rate	1Mbps, 2Mbps, 3Mbps
Operating Frequency	2402 ~ 2480MHz
Number of Channel	79
Output Power (Peak)	-0.395dBm
Antenna Type	Chip Antenna
Antenna Gain	2.58dBi
Antenna Connector	N/A
Accessory Device	N/A

Note:

1. Please refer to the EUT photo document (Reference No.:23080202-01&-02) for detailed product photo.
2. The above EUT information is declared by manufacturer and for more detailed features description, please refer to the manufacturer's specifications or User's Manual.
3. This product has two Bluetooth Chips (distribute left earbud and right earbud), they are identical in RF circuitry and antenna except the Layout of partial components; Both in-ear headphones are tested on all items, and the report only shows the worst data.



2.2 Description of Test Modes

79 channels are provided to this EUT:

Channel	Freq. (MHz)	Channel	Freq. (MHz)	Channel	Freq. (MHz)	Channel	Freq. (MHz)
0	2402	20	2422	40	2442	60	2462
1	2403	21	2423	41	2443	61	2463
2	2404	22	2424	42	2444	62	2464
3	2405	23	2425	43	2445	63	2465
4	2406	24	2426	44	2446	64	2466
5	2407	25	2427	45	2447	65	2467
6	2408	26	2428	46	2448	66	2468
7	2409	27	2429	47	2449	67	2469
8	2410	28	2430	48	2450	68	2470
9	2411	29	2431	49	2451	69	2471
10	2412	30	2432	50	2452	70	2472
11	2413	31	2433	51	2453	71	2473
12	2414	32	2434	52	2454	72	2474
13	2415	33	2435	53	2455	73	2475
14	2416	34	2436	54	2456	74	2476
15	2417	35	2437	55	2457	75	2477
16	2418	36	2438	56	2458	76	2478
17	2419	37	2439	57	2459	77	2479
18	2420	38	2440	58	2460	78	2480
19	2421	39	2441	59	2461	-	-

2.3 Test Mode Applicability and Tested Channel Detail

EUT Configure Mode	Applicable test items	X-Axis	Y-Axis	Z-Axis	Voltage Supply
Conducted	AC Power Conducted Emission	N/A	N/A	N/A	AC120V/60Hz
Radiated	Radiated Emissions	√	√	√	DC 3.7V from battery
Antenna Port Conducted Measurement	Number of Hopping Frequency Used	N/A	N/A	N/A	
	Dwell Time on Each Channel	N/A	N/A	N/A	
	Band Edge Measurement	N/A	N/A	N/A	
	Antenna Port Emission	N/A	N/A	N/A	
	Conducted power	N/A	N/A	N/A	
	Hopping Channel Separation	N/A	N/A	N/A	
	Spectrum Bandwidth of a Frequency Hopping Sequence Spread Spectrum System	N/A	N/A	N/A	

1. *: The EUT had been pre-tested on the positioned of each 3 Axis. The worst case was found when positioned on **X-plane**.

2. "N/A" means no effect.

Evaluation of difference data rate:

Applicable test items	Modulation Type			The Worst-case modes recording in report
	GFSK	$\pi/4$ DQPSK	8DPSK	
Radiated Emissions	√	√	√	GFSK& 8DPSK
Antenna Port Conducted Measurement	√	√	√	GFSK& 8DPSK

Test Condition:

Applicable test items	Environmental Conditions	Test Date	Tested by
Radiated Emissions	21.5deg. C, 54%RH	Aug. 17, 2023	Hua
Antenna Port Conducted Measurement	20.1deg. C, 52%RH	Aug. 19, 2023	Dragon Long

- Pre-Scan has been conducted to determine the worst-case mode from all possible combinations between available modulations, data rates and antenna ports (if EUT with antenna diversity architecture). Following channel(s) was (were) selected for the final test as listed below.



Radiated Emission Test (Above 1 GHz):

EUT Configure Mode	Available Channel	Tested Channel	Modulation Technology	Modulation Type	Packet Type
-	0 to 78	0, 39, 78	FHSS	GFSK	DH5
-	0 to 78	0, 39, 78	FHSS	8DPSK	3DH5

Radiated Emission Test (Below 1 GHz):

EUT Configure Mode	Available Channel	Tested Channel	Modulation Technology	Modulation Type	Packet Type
-	0 to 78	0	FHSS	GFSK	DH5
-	0 to 78	0	FHSS	8DPSK	3DH5

Power Line Conducted Emission Test:

EUT Configure Mode	Available Channel	Tested Channel	Modulation Technology	Modulation Type	Packet Type
-	0 to 78	39	FHSS	GFSK	DH5

Antenna Port Conducted Measurement:

This item includes all test value of each mode, but only includes spectrum plot of worst value of each mode.

EUT Configure Mode	Available Channel	Tested Channel	Modulation Technology	Modulation Type	Packet Type
-	0 to 78	0, 39, 78	FHSS	GFSK	DH5
-	0 to 78	0, 39, 78	FHSS	8DPSK	3DH5

2.4 Description of Support Units

The EUT has been tested as an independent unit together with other necessary accessories or support units. The following support units or accessories were used to form a representative test configuration during the tests.

No.	Product	Brand	Model No.	Serial No.	FCC ID
1.	Notebook	DELL	Latitude 5300	N/A	N/A

No.	Signal Cable Description of The Above Support Units
1.	USB serial cable Un-shielded1.2m
2.	/

2.4.1 Configuration of System under Test

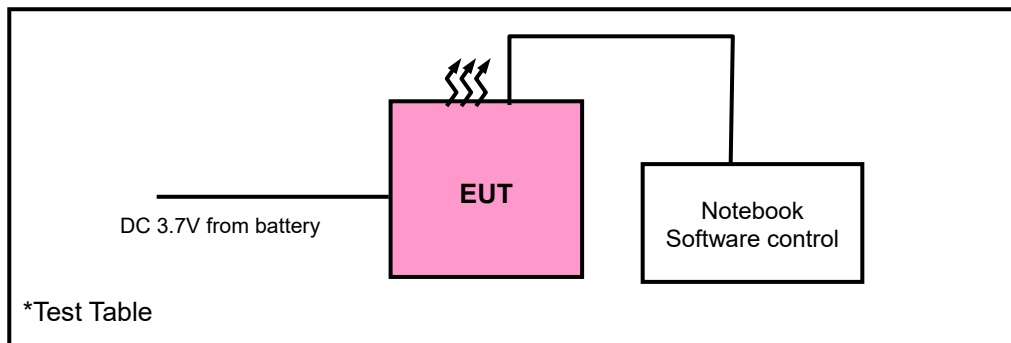



3 Test Types and Results

3.1 Radiated Emission and Band-edge Measurement

3.1.1 Limits of Radiated Emission and Band-edge Measurement

Radiated emissions which fall in the restricted bands must comply with the radiated emission limits specified as below table. Other emissions shall be at least 20 dB below the highest level of the desired power:

Frequencies (MHz)	Field Strength (microvolts/meter)	Measurement Distance (meters)
0.009 ~ 0.490	2400/F(kHz)	300
0.490 ~ 1.705	24000/F(kHz)	30
1.705 ~ 30.0	30	30
30 ~ 88	100	3
88 ~ 216	150	3
216 ~ 960	200	3
Above 960	500	3

* DTS emissions in non-restricted frequency bands Subclause 11.11 of ANSI C63.10 is applicable.

* DTS emissions in restricted frequency bands Subclause 11.12 of ANSI C63.10 is applicable

Note:

1. The lower limit shall apply at the transition frequencies.
2. Emission level (dBuV/m) = 20 log Emission level (uV/m).
3. For frequencies above 1000 MHz, the field strength limits are based on average detector, however, the peak field strength of any emission shall not exceed the maximum permitted average limits, specified above by more than 20 dB under any condition of modulation.



3.1.2 Test Instruments

Radiated emission below 30MHz:

Equipment	Manufacturer	Model No.	Serial No.	Next Cal.
EMI Test Receiver	Rohde&Schwarz	ESR7	100962	2023-12-27
3m Semi-anechoic Chamber	MAORUI	9m*6m*6m	NSEMC003	2026-03-14**
Test software	FARAD	FARAD	EZ EMCV1.1.4.2	N/A
Loop Antenna	EMCI	HLA 6121	56735	2024-05-04*
Antenna Tower	MF	MFA-440H	NA	NA
Turn Table	MF	MFT-201SS	NA	NA
Antenna Tower&Turn Table Controller	MF	MF-7802	NA	NA

Frequency Range below 1GHz:

Equipment	Manufacturer	Model No.	Serial No.	Next Cal.
3m Semi-anechoic Chamber	MAORUI	9m*6m*6m	NSEMC003	2026-03-14**
EMI Test Receiver	Rohde&Schwarz	ESR7	100962	2023-12-27
Broadband antenna	Schwarzbeck	VULB 9168	00937	2023-08-18
Broadband antenna	Schwarzbeck	VULB 9168	00937	2024-08-18
Signal Amplifier	Com-power	PAM-103	18020051	2023-08-25
Attenuator	Rohde&Schwarz	TS2GA-6dB	18101101	N/A
Test software	FARAD	FARAD	EZ EMCV1.1.4.2	N/A

Frequency Range above 1GHz:

Equipment	Manufacturer	Model No.	Serial No.	Next Cal.
3m Semi-anechoic Chamber	MAORUI	9m*6m*6m	NSEMC003	2026-03-14**
Horn Antenna	Schwarzbeck	BBHA 9120D	01959	2023-08-15
Horn Antenna	Schwarzbeck	BBHA 9120D	01959	2024-08-15
Broadband Coaxial Preamplifier	Com-power	PAM-118A	1804003	2023-08-25
Spectrum	Keysight	N9020A	MY51240612	2023-08-25
Antenna Tower	MF	MFA-440H	NA	NA
Turn Table	MF	MFT-201SS	NA	NA
Antenna Tower&Turn Table Controller	MF	MF-7802	NA	NA

Note:

1. The calibration interval of the above test instruments is 12 months or 24 months (*) or 36 months (**).
2. The test was performed in 966.



3.1.3 Test Procedures

a. **Peak emission levels are measured by setting the instrument as follow:**

1) RBW&VBWsetting as a function of frequency:

Frequency	RBW	VBW
9kHz~150kHz	200Hz	600Hz
0.15MHz~30MHz	9kHz	30kHz
30MHz~1000MHz	120kHz	300kHz
>1000MHz	1MHz	3MHz

- 2) Detector = peak.
- 3) Sweep time = auto.
- 4) Trace mode = max hold.
- 5) Allow sweeps to continue until the trace stabilizes. (Note that the required measurement time may be lengthened for low-duty-cycle applications.)

Note: If the peak-detected amplitude can be shown to comply with the average limit, then it is not necessary to perform a separate average measurement

b. **Average emission levels are measured by setting the instrument as follow:**

● **Trace averaging with continuous EUT transmission at full power**

If the EUT can be configured or modified to transmit continuously ($D \geq 98\%$), then the average emission levels shall be measured using the following method (with EUT transmitting continuously):

- 1) RBW=1 MHz (unless otherwise specified).
- 2) $VBW \geq 3 * RBW$.
- 3) Detector =RMS
- 4) Sweep time = auto.
- 5) Perform a trace average of at least 100 traces.

● **Trace averaging across ON and OFF times of the EUT transmissions followed by duty cycle correction**

If continuous transmission of the EUT ($D \geq 98\%$) cannot be achieved and the duty cycle is constant (duty cycle variations are less than $\pm 2\%$), then the following procedure shall be used

- 1) The EUT shall be configured to operate at the maximum achievable duty cycle.
- 2) Measure the duty cycle D of the transmitter output signal as described in 11.6.
- 3) RBW=1 MHz (unless otherwise specified).
- 4) $VBW \geq 3 * RBW$.
- 5) Detector =RMS
- 6) Sweep time = auto.
- 7) Perform a trace average of at least 100 traces.

A correction factor shall be added to the measurement results prior to comparing with the emission limit to compute the emission level that would have been measured had the test been performed at 100% duty cycle. The correction factor is computed as follows:

*If power averaging (rms) mode was used in step 5), then the applicable correction factor is $[10 \log(1/D)]$, where D is the duty cycle.

**If linear voltage averaging mode was used in step f), then the applicable correction factor is $[20 \log(1/D)]$, where D is the duty cycle.

***If a specific emission is demonstrated to be continuous ($D > 98\%$) rather than turning ON and

OFF with the transmit cycle, then no duty cycle correction is required for that

● **Reduced VBW Averaging across ON and OFF times of the EUT transmissions with max hold**

If continuous transmission of the EUT ($D > 98\%$) cannot be achieved and the duty cycle is not constant (duty cycle variations exceed $\pm 2\%$), then the following procedure shall be used:

- 1) RBW = 1 MHz.
 - 2) $VBW \geq 1/T$.
 - 3) Detector = peak
 - 4) Sweep time = auto.
 - 5) Trace mode = max hold.
 - 6) Allow max hold to run for at least $[50 \times (1/D)]$ traces
- c. The EUT was placed on the top of a rotating table 0.8 meters (below 1GHz) / 1.5 meters (Above 1GHz) above the reference ground. The table was rotated 360 degrees to determine the position of the highest radiation.
- d. The EUT was set 3 meters away from the interference-receiving antenna (Below 1GHz) & (Above 1GHz), which was mounted on the top of a variable-height antenna tower.
- e. The height of antenna is varied from one meter to four meters above the ground to determine the maximum value of the field strength. Both horizontal and vertical polarizations of the antenna are set to make the measurement.
- f. For each suspected emission, the EUT was arranged to its worst case and then the antenna was tuned to heights from 1 meter to 4 meters and the rotatable table was turned from 0 degrees to 360 degrees to find the maximum reading.
- g. The test-receiver system was set to quasi-peak detect function and specified bandwidth with maximum hold mode when the test frequency is below 1 GHz.

The test-receiver system was set to peak and average detected function and specified bandwidth with maximum hold mode when the test frequency is above 1 GHz. If the peak reading value also meets average limit, measurement with the average detector is unnecessary.

Note:

1. Test procedures for measuring FHSS device: The use of a duty cycle correction factor (DCCF) is permitted for calculating average radiated field strength emission levels for an FHSS device in 15.247. This DCCF can be applied when the unwanted emission limit is subject to an average field strength limit (e.g., within a Government Restricted band) and the conditions specified in Section 15.35(c) can be satisfied. The average radiated field strength is calculated by subtracting the DCCF from the maximum radiated field strength level as determined through measurement. The maximum radiated field strength level represents the worst-case (maximum amplitude) RMS measurement of the emission(s) during continuous transmission (i.e., not including any time intervals during which the transmitter is off or is transmitting at a reduced power level). It is also acceptable to apply the DCCF to a measurement performed with a peak detector instead of the specified RMS power averaging detector. Note that Section 15.35(c) specifies that the DCCF shall represent the worst-case (greatest duty cycle) over any 100 msec transmission period. Subclause 7.5 of ANSI C63.10 provides additional measurement guidance applicable to determination of the DCCF.
2. All modes of operation were investigated and the worst-case emissions are reported.

3.1.4 Deviation from Test Standard

No deviation.

Lab: [Hwa-Hsing \(Dongguan\) Testing Co., Ltd.](#)

Address: [No. 101, Building N1, Yuyuan 2 Road, Yuyuan Industrial Park, HuangJiang Town, Dongguan City, People's Republic of China](#)

Tel: [0769-83078199](tel:0769-83078199)

Web.: www.hwa-hsing.com

E-Mail: customerservice.dg@hwa-hsing.com

Release

[Ver. 1.5](#)

3.1.5 Test Setup

Radiated emission below 30MHz:

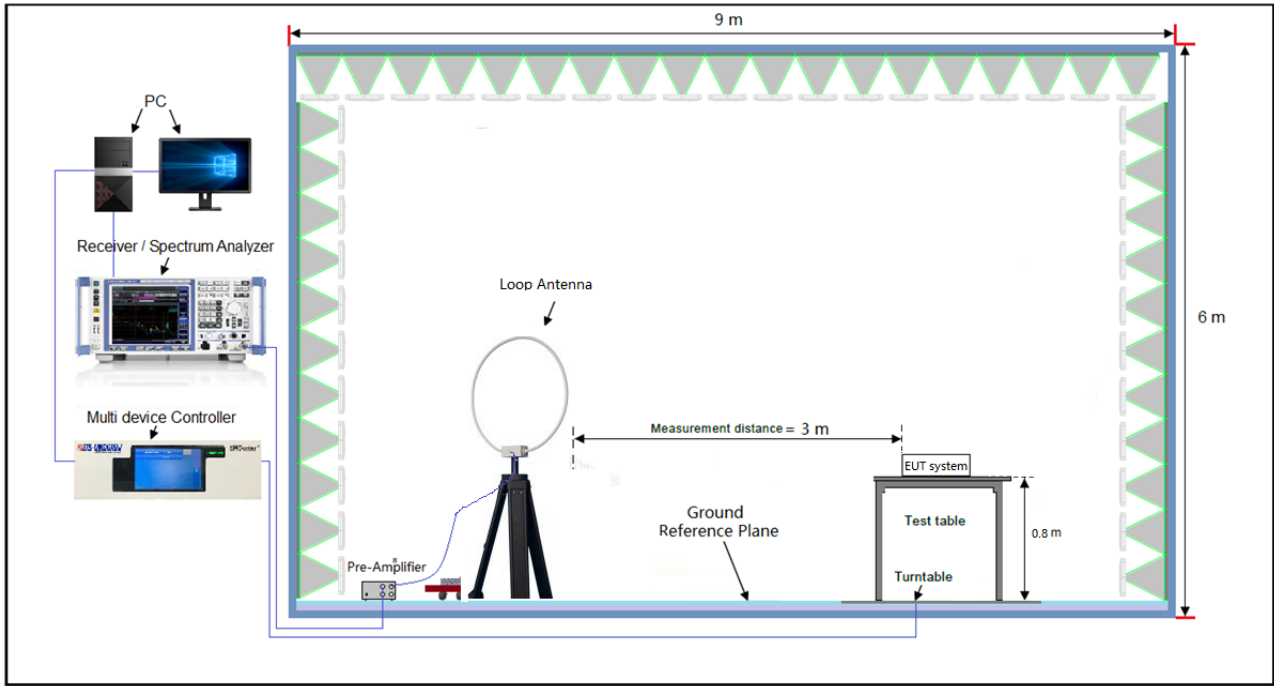

Frequency Range below 1GHz:

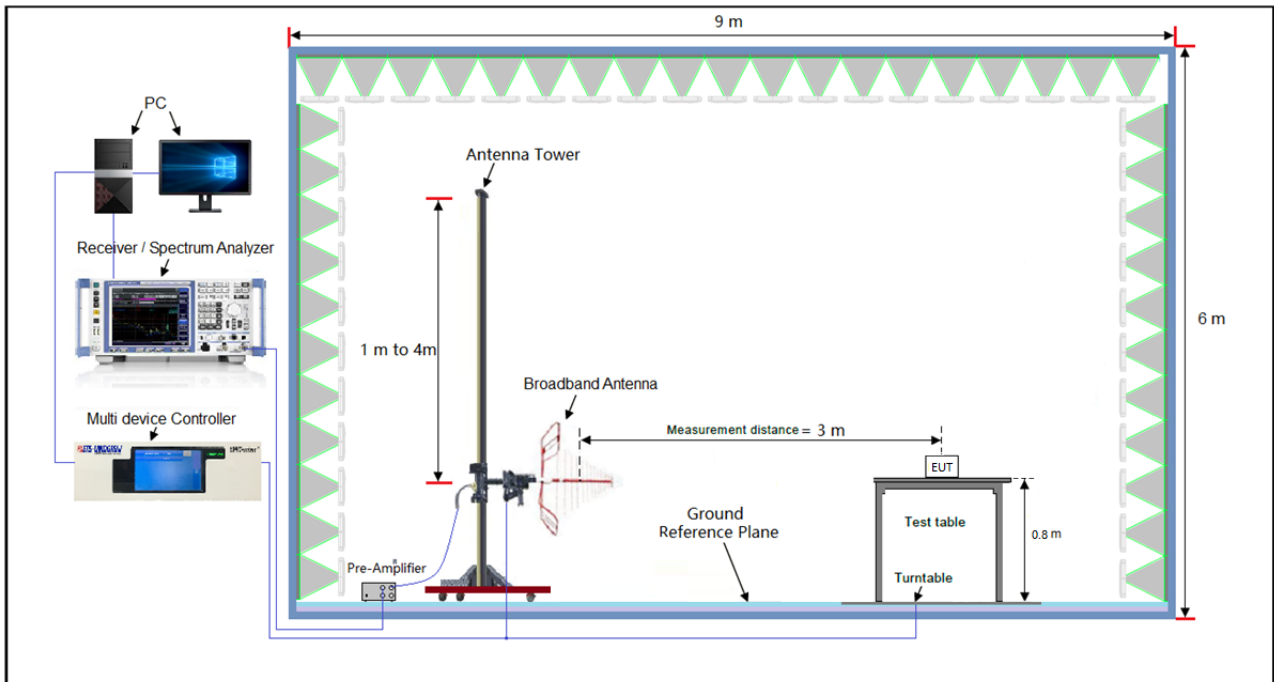

Frequency Range above 1GHz:

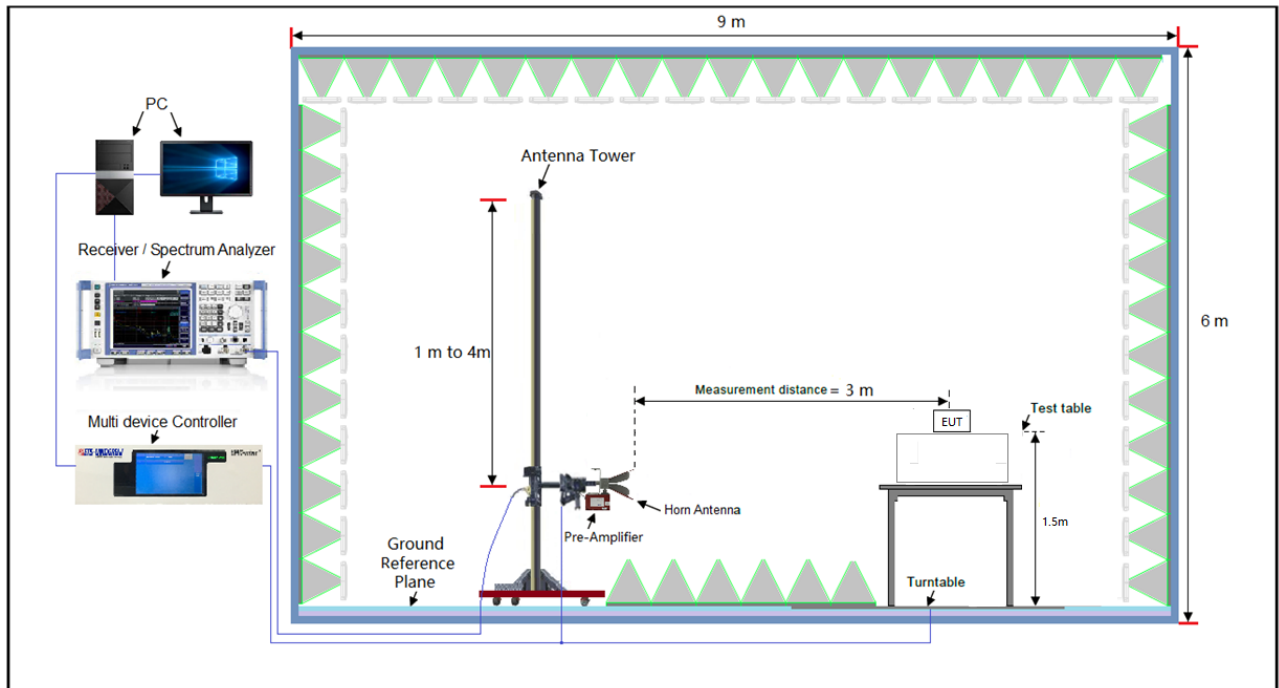

*For the actual test configuration, please refer to the attached file (Test Setup Photo).

3.1.6 EUT Operating Conditions

Set the EUT under transmission condition continuously at specific channel frequency.



3.1.7 Test Results

9 kHz ~ 30 MHz Data:

The amplitude of spurious emissions attenuated more than 20 dB below the permissible value is not required to be report.

30 MHz ~ 1GHz Worst-Case Data:

Frequency Range	30MHz ~ 1GHz	Detector Function	Peak (PK) Quasi-peak (QP)
Test Channel	Channel 0		

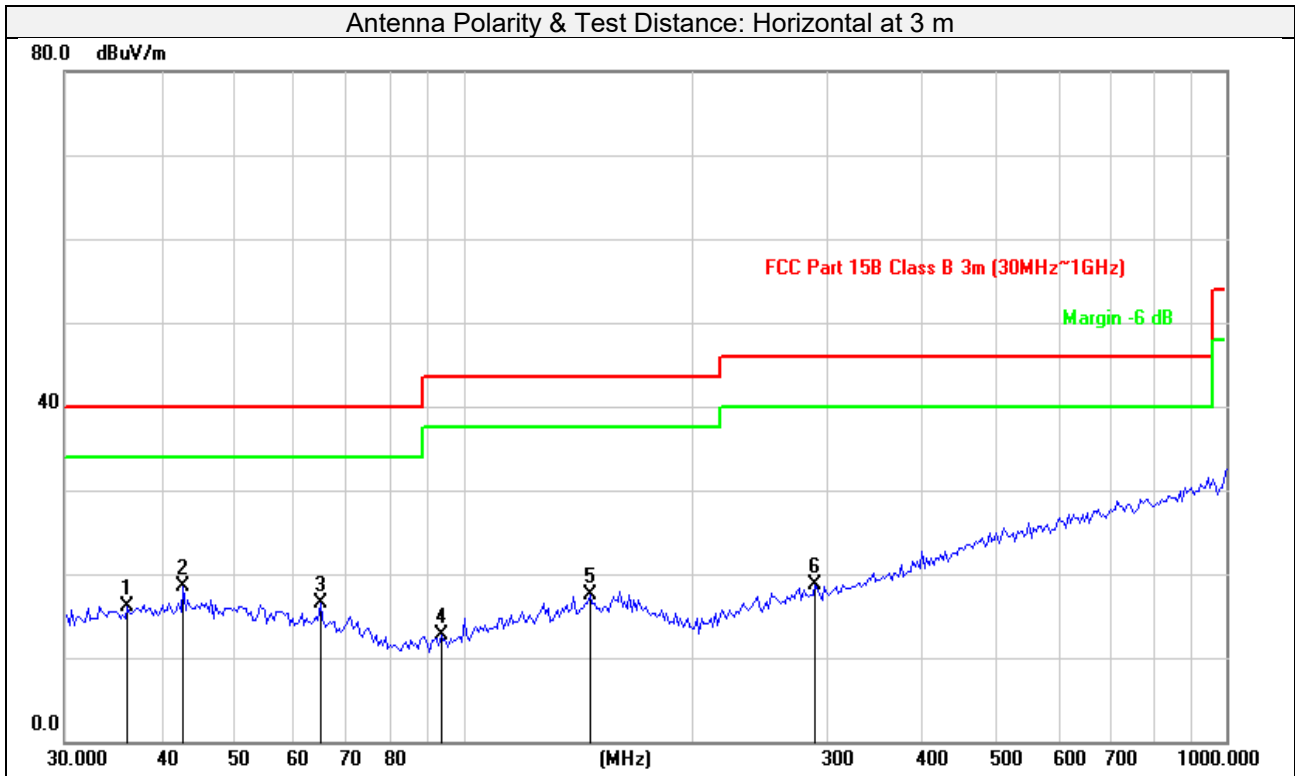

No.	Frequency (MHz)	Reading (dBuV)	Factor (dB)	Emission Level (dBuV/m)	Limit (dBuV/m)	Margin (dB)	Detector	Antenna Height (cm)	Table Angle (Degree)
1	36.2541	32.01	-15.82	16.19	40.00	-23.81	peak	185	136
2	42.8998	33.96	-15.38	18.58	40.00	-21.42	peak	152	120
3	64.8865	33.77	-17.30	16.47	40.00	-23.53	peak	201	25
4	93.4402	32.28	-19.51	12.77	43.50	-30.73	peak	220	288
5	146.3735	32.70	-15.29	17.41	43.50	-26.09	peak	256	256
6	289.0021	32.64	-13.91	18.73	46.00	-27.27	peak	145	236

Remarks:

- 1.Emission Level = Read Level + Factor (Antenna Factor + Cable Loss - Preamp Factor)
- 2.Margin value = Emission level – Limit value

Lab: [Hwa-Hsing \(Dongguan\) Testing Co., Ltd.](#)

Address: [No. 101, Building N1, Yuyuan 2 Road, Yuyuan Industrial Park, HuangJiang Town, Dongguan City, People's Republic of China](#)

Tel: [0769-83078199](tel:0769-83078199)

Web.: www.hwa-hsing.com

E-Mail: customerservice.dg@hwa-hsing.com

Release

[Ver. 1.5](#)



Frequency Range	30MHz ~ 1GHz	Detector Function	Peak (PK) Quasi-peak (QP)
Test Channel	Channel 0		

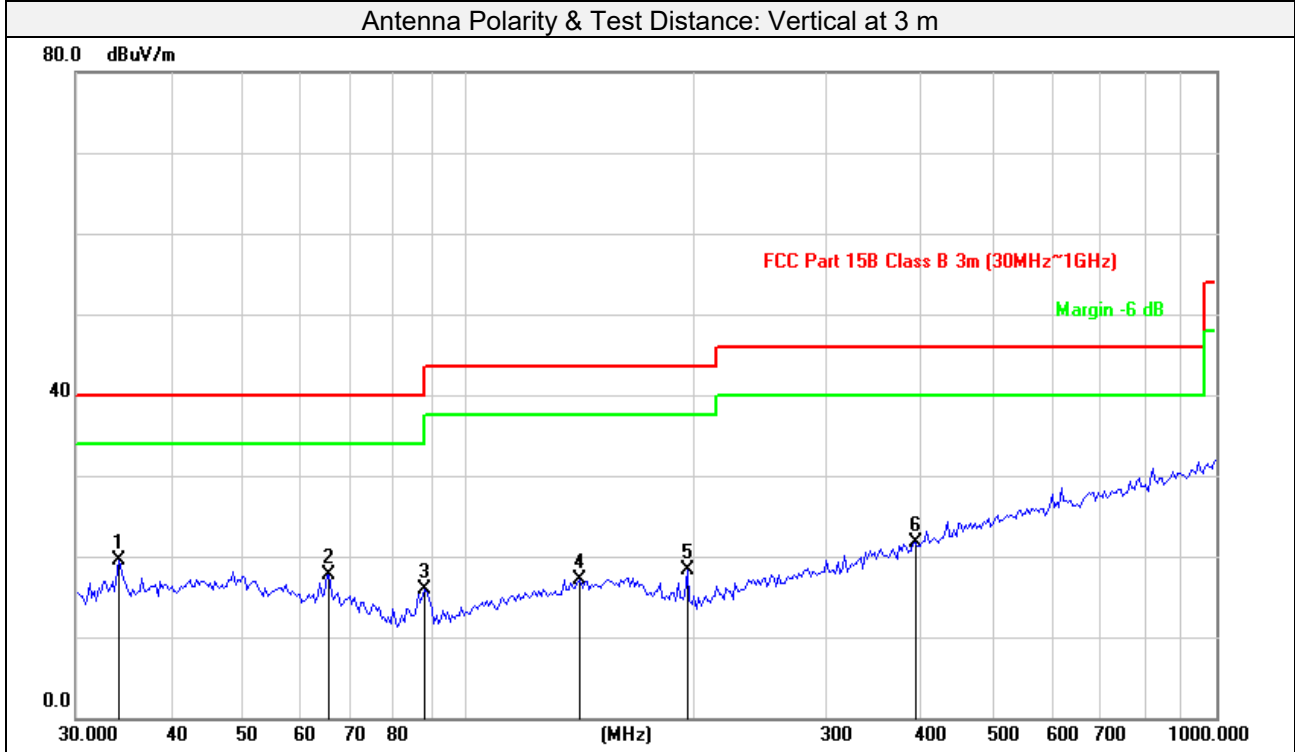

No.	Frequency (MHz)	Reading (dBuV)	Factor (dB)	Emission Level (dBuV/m)	Limit (dBuV/m)	Margin (dB)	Detector	Antenna Height (cm)	Table Angle (Degree)
1	34.2760	35.60	-16.13	19.47	40.00	-20.53	peak	122	260
2	65.3432	35.08	-17.33	17.75	40.00	-22.25	peak	125	352
3	87.7248	35.95	-19.97	15.98	40.00	-24.02	peak	163	215
4	141.3298	32.66	-15.51	17.15	43.50	-26.35	peak	163	156
5	196.5098	35.72	-17.48	18.24	43.50	-25.26	peak	215	145
6	396.2415	32.09	-10.40	21.69	46.00	-24.31	peak	202	178

Remarks:

1. Emission Level = Read Level + Factor (Antenna Factor + Cable Loss - Preamp Factor)
2. Margin value = Emission level – Limit value



Above 1GHz Data:

GFSK

Frequency Range	1GHz ~ 25GHz	Detector Function	Peak (PK) Average (AVG)
Test Channel	Channel 0		

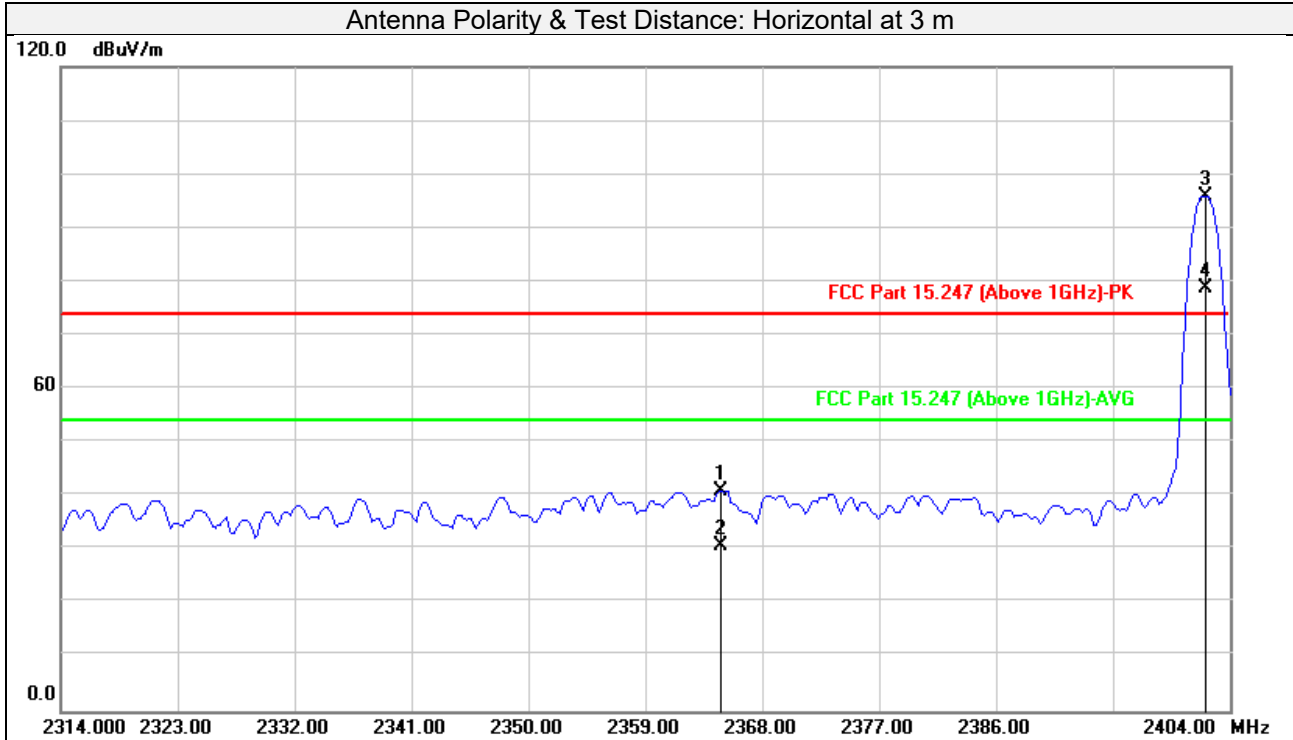

No.	Frequency (MHz)	Reading (dBuV)	Factor (dB)	Emission Level (dBuV/m)	Limit (dBuV/m)	Margin (dB)	Detector	Antenna Height (cm)	Table Angle (Degree)
1	2364.862	40.12	0.81	40.93	74.00	-33.07	peak	144	54
2	2364.862	29.98	0.81	30.79	54.00	-23.21	AVG	144	54
3#	2402.196	95.06	0.83	95.89			peak	144	54
4#	2402.196	78.06	0.83	78.89			AVG	144	54
5	4804.000	47.93	6.60	54.53	74.00	-19.47	peak	122	318
6	4804.000	40.98	6.60	47.58	54.00	-6.42	AVG	122	318
7	7206.000	39.72	10.08	49.80	74.00	-24.20	peak	210	215
8	7206.000	28.48	10.08	38.56	54.00	-15.44	AVG	210	215

Remarks:

- Emission Level = Read Level + Factor (Antenna Factor + Cable Loss - Preamp Factor)
Margin value = Emission level – Limit value
- #2402MHz: Fundamental frequency.
- The amplitude of spurious emissions attenuated more than 20 dB below the permissible value is not required to be report.

Lab: [Hwa-Hsing \(Dongguan\) Testing Co., Ltd.](#)

Address: [No. 101, Building N1, Yuyuan 2 Road, Yuyuan Industrial Park, HuangJiang Town, Dongguan City, People's Republic of China](#)

Tel: [0769-83078199](tel:0769-83078199)

Web.: www.hwa-hsing.com

E-Mail: customerservice.dg@hwa-hsing.com

Release

[Ver. 1.5](#)

Frequency Range	1GHz ~ 25GHz	Detector Function	Peak (PK) Average (AVG)
Test Channel	Channel 0		

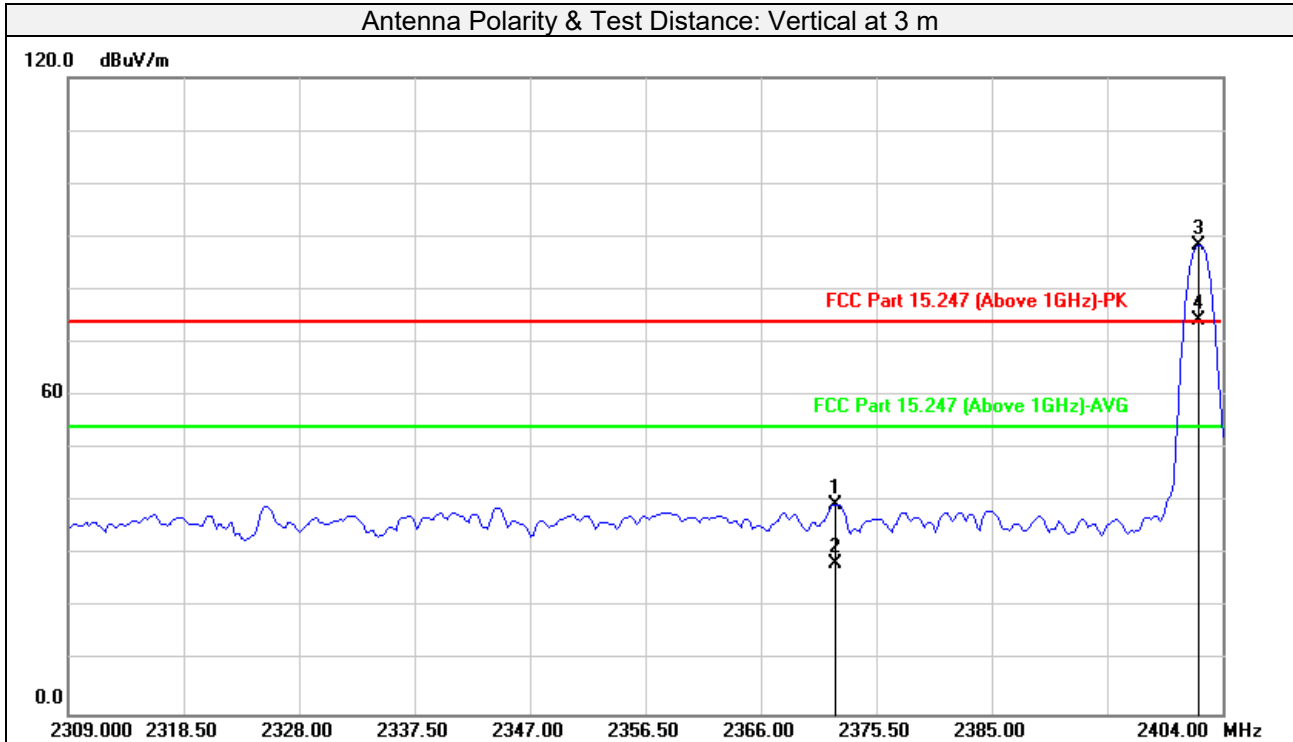

No.	Frequency (MHz)	Reading (dBuV)	Factor (dB)	Emission Level (dBuV/m)	Limit (dBuV/m)	Margin (dB)	Detector	Antenna Height (cm)	Table Angle (Degree)
1	2372.206	38.73	0.81	39.54	74.00	-34.46	peak	102	104
2	2372.206	27.54	0.81	28.35	54.00	-25.65	AVG	102	104
3#	2402.096	87.51	0.83	88.34			peak	102	104
4#	2402.096	73.31	0.83	74.14			AVG	102	104
5	4804.000	46.23	6.60	52.83	74.00	-21.17	peak	237	171
6	4804.000	39.04	6.60	45.64	54.00	-8.36	AVG	237	171
7	7206.000	41.07	10.08	51.15	74.00	-22.85	peak	260	109
8	7206.000	28.52	10.08	38.60	54.00	-15.40	AVG	260	109

Remarks:

- Emission Level = Read Level + Factor (Antenna Factor + Cable Loss - Preamp Factor)
Margin value = Emission level – Limit value
- #2402MHz: Fundamental frequency.
- The amplitude of spurious emissions attenuated more than 20 dB below the permissible value is not required to be report.

Frequency Range	1GHz ~ 25GHz	Detector Function	Peak (PK) Average (AVG)
Test Channel	Channel 39		

Antenna Polarity & Test Distance: Horizontal at 3 m									
No.	Frequency (MHz)	Reading (dBuV)	Factor (dB)	Emission Level (dBuV/m)	Limit (dBuV/m)	Margin (dB)	Detector	Antenna Height (cm)	Table Angle (Degree)
1 #	2441.000	93.22	0.69	93.91			peak	200	211
2 #	2441.000	71.48	0.69	72.17			AVG	200	211
3	4882.000	47.33	6.77	54.10	74.00	-19.90	peak	121	315
4	4882.000	40.50	6.77	47.27	54.00	-6.73	AVG	121	315
5	7323.000	41.38	10.37	51.75	74.00	-22.25	peak	152	290
6	7323.000	28.31	10.37	38.68	54.00	-15.32	AVG	152	290
Antenna Polarity & Test Distance: Vertical at 3 m									
No.	Frequency (MHz)	Reading (dBuV)	Factor (dB)	Emission Level (dBuV/m)	Limit (dBuV/m)	Margin (dB)	Detector	Antenna Height (cm)	Table Angle (Degree)
1 #	2441.000	89.61	0.69	90.30			peak	224	194
2 #	2441.000	70.52	0.69	71.21			AVG	224	194
3	4882.000	46.09	6.77	52.86	74.00	-21.14	peak	236	265
4	4882.000	38.67	6.77	45.44	54.00	-8.56	AVG	236	265
5	7323.000	41.41	10.37	51.78	74.00	-22.22	peak	125	230
6	7323.000	28.36	10.37	38.73	54.00	-15.27	AVG	125	230

Remarks:

- Emission Level = Read Level + Factor (Antenna Factor + Cable Loss - Preamp Factor)
Margin value = Emission level – Limit value
- #2441MHz: Fundamental frequency.
- The amplitude of spurious emissions attenuated more than 20 dB below the permissible value is not required to be report.

Frequency Range	1GHz ~ 25GHz	Detector Function	Peak (PK) Average (AVG)
Test Channel	Channel 78		

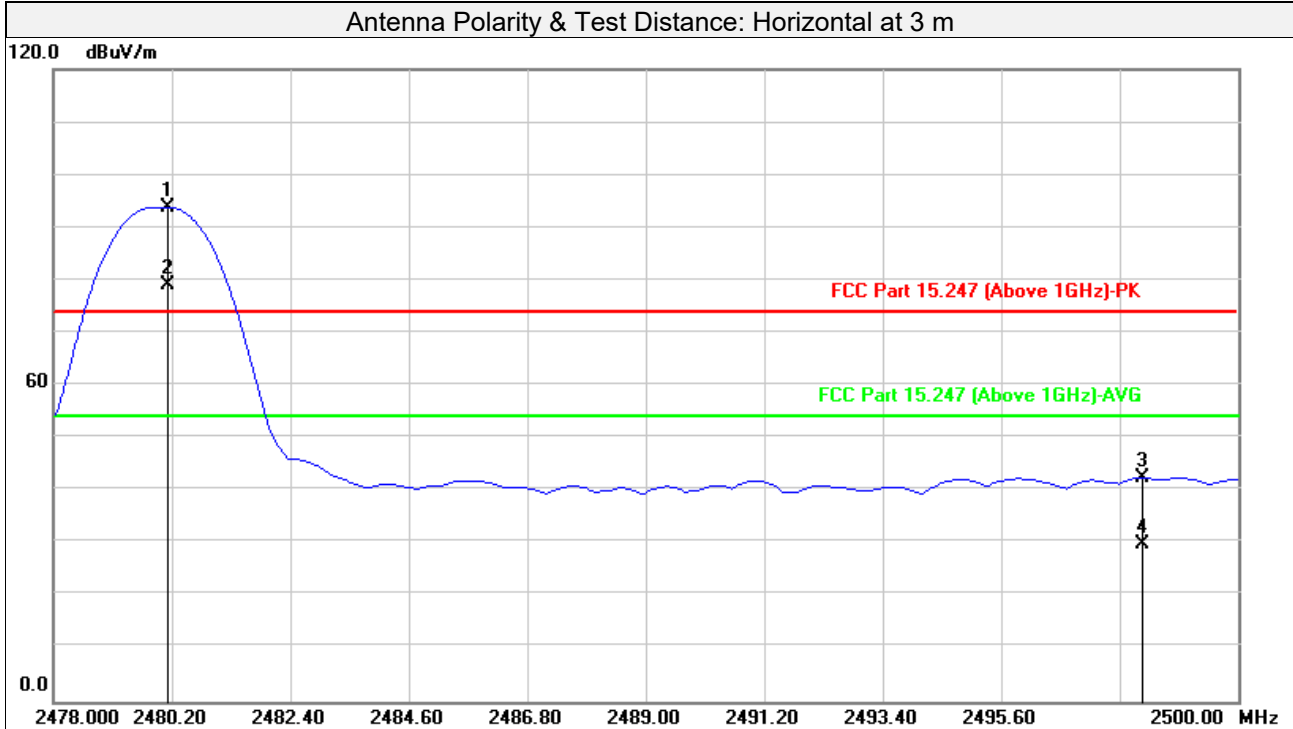

No.	Frequency (MHz)	Reading (dBuV)	Factor (dB)	Emission Level (dBuV/m)	Limit (dBuV/m)	Margin (dB)	Detector	Antenna Height (cm)	Table Angle (Degree)
1#	2480.116	92.96	0.85	93.81			peak	307	217
2#	2480.116	78.05	0.85	78.90			AVG	307	217
3	2498.236	41.62	0.86	42.48	74.00	-31.52	peak	307	217
4	2498.236	28.97	0.86	29.83	54.00	-24.17	AVG	307	217
5	4960.000	47.73	6.93	54.66	74.00	-19.34	peak	133	317
6	4960.000	40.47	6.93	47.40	54.00	-6.60	AVG	133	317
7	7440.000	40.29	10.67	50.96	74.00	-23.04	peak	215	101
8	7440.000	28.16	10.67	38.83	54.00	-15.17	AVG	215	101

Remarks:

- Emission Level = Read Level + Factor (Antenna Factor + Cable Loss - Preamp Factor)
Margin value = Emission level – Limit value
- #2480MHz: Fundamental frequency.
- The amplitude of spurious emissions attenuated more than 20 dB below the permissible value is not required to be report.

Lab: [Hwa-Hsing \(Dongguan\) Testing Co., Ltd.](#)

Address: [No. 101, Building N1, Yuyuan 2 Road, Yuyuan Industrial Park, HuangJiang Town, Dongguan City, People's Republic of China](#)

Tel: [0769-83078199](tel:0769-83078199)

Web.: www.hwa-hsing.com

E-Mail: customerservice.dg@hwa-hsing.com

Release

[Ver. 1.5](#)

Frequency Range	1GHz ~ 25GHz	Detector Function	Peak (PK) Average (AVG)
Test Channel	Channel 78		

Antenna Polarity & Test Distance: Vertical at 3 m

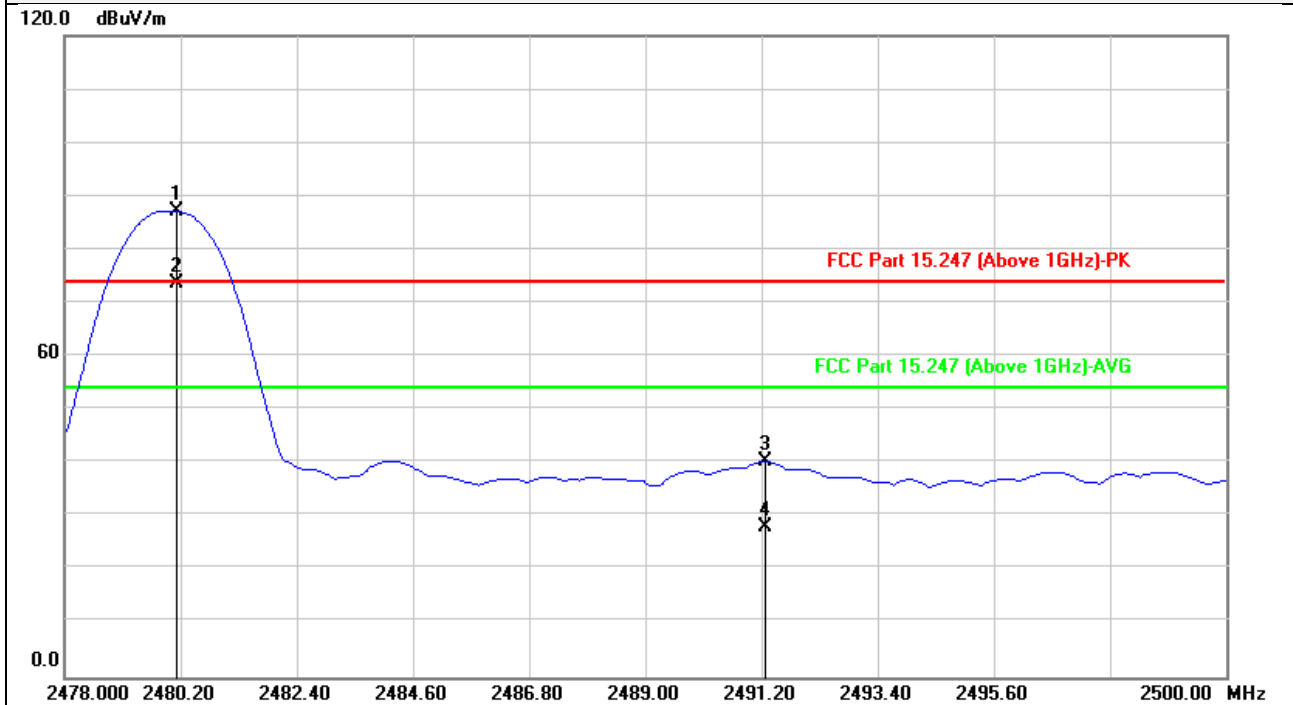

No.	Frequency (MHz)	Reading (dBuV)	Factor (dB)	Emission Level (dBuV/m)	Limit (dBuV/m)	Margin (dB)	Detector	Antenna Height (cm)	Table Angle (Degree)
1#	2480.116	86.28	0.85	87.13			peak	100	109
2#	2480.116	72.83	0.85	73.68			AVG	100	109
3	2491.271	39.48	0.86	40.34	74.00	-33.66	peak	100	109
4	2491.271	27.19	0.86	28.05	54.00	-25.95	AVG	100	109
5	4960.000	46.03	6.93	52.96	74.00	-21.04	peak	237	265
6	4960.000	39.11	6.93	46.04	54.00	-7.96	AVG	237	265
7	7440.000	40.56	10.67	51.23	74.00	-22.77	peak	185	233
8	7440.000	28.17	10.67	38.84	54.00	-15.16	AVG	185	233

Remarks:

- Emission Level = Read Level + Factor (Antenna Factor + Cable Loss - Preamp Factor)
Margin value = Emission level – Limit value
- #2480MHz: Fundamental frequency.
- The amplitude of spurious emissions attenuated more than 20 dB below the permissible value is not required to be report.



8DPSK

Frequency Range	1GHz ~ 25GHz	Detector Function	Peak (PK) Average (AVG)
Test Channel	Channel 0		

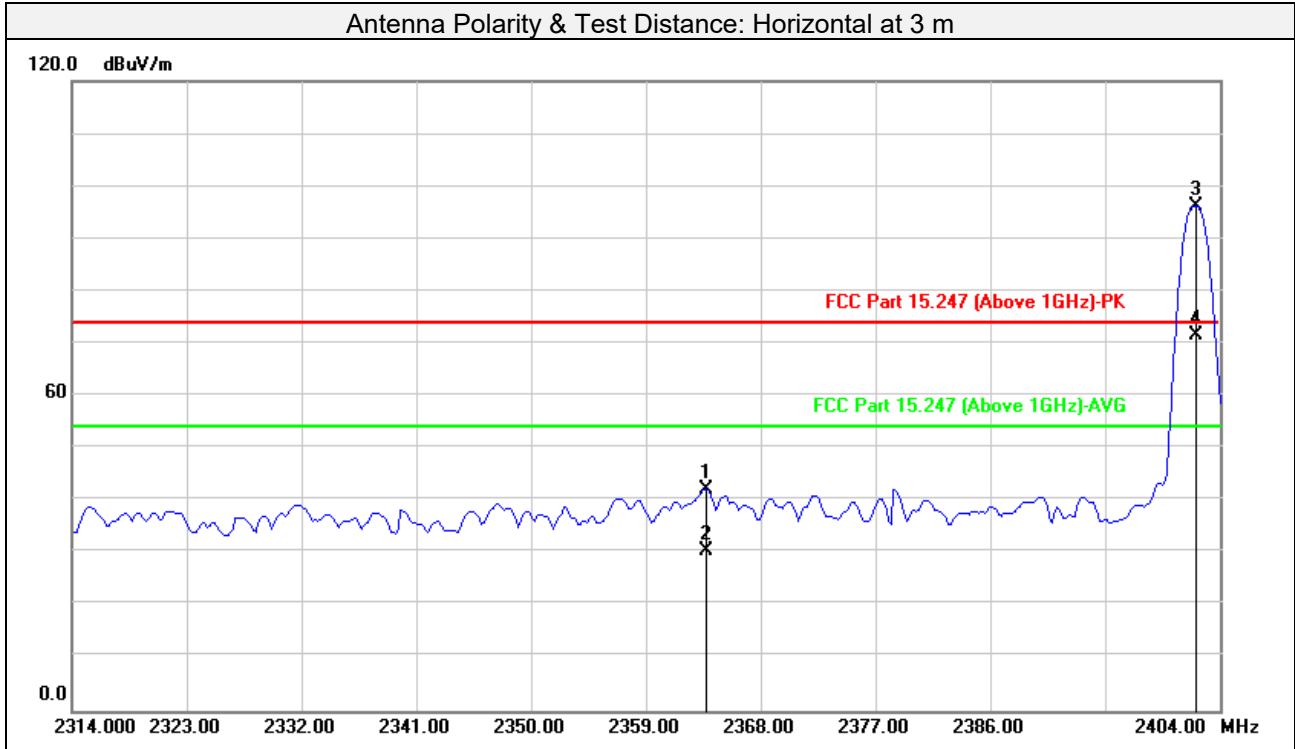

No.	Frequency (MHz)	Reading (dBuV)	Factor (dB)	Emission Level (dBuV/m)	Limit (dBuV/m)	Margin (dB)	Detector	Antenna Height (cm)	Table Angle (Degree)
1	2363.780	41.34	0.81	42.15	74.00	-31.85	peak	333	215
2	2363.780	29.60	0.81	30.41	54.00	-23.59	AVG	333	215
3#	2402.196	95.42	0.83	96.25			peak	333	215
4#	2402.196	70.80	0.83	71.63			AVG	333	215
5	4804.000	47.23	6.60	53.83	74.00	-20.17	peak	161	209
6	4804.000	38.62	6.60	45.22	54.00	-8.78	AVG	161	209
7	7206.000	41.43	10.08	51.51	74.00	-22.49	peak	186	315
8	7206.000	28.35	10.08	38.43	54.00	-15.57	AVG	186	315

Remarks:

- Emission Level = Read Level + Factor (Antenna Factor + Cable Loss - Preamp Factor)
Margin value = Emission level – Limit value
- #2402MHz: Fundamental frequency.
- The amplitude of spurious emissions attenuated more than 20 dB below the permissible value is not required to be report.

Lab: [Hwa-Hsing \(Dongguan\) Testing Co., Ltd.](#)

Address: [No. 101, Building N1, Yuyuan 2 Road, Yuyuan Industrial Park, HuangJiang Town, Dongguan City, People's Republic of China](#)

Tel: [0769-83078199](tel:0769-83078199)

Web.: www.hwa-hsing.com

E-Mail: customerservice.dg@hwa-hsing.com

Release

[Ver. 1.5](#)



Frequency Range	1GHz ~ 25GHz	Detector Function	Peak (PK) Average (AVG)
Test Channel	Channel 0		

Antenna Polarity & Test Distance: Vertical at 3 m

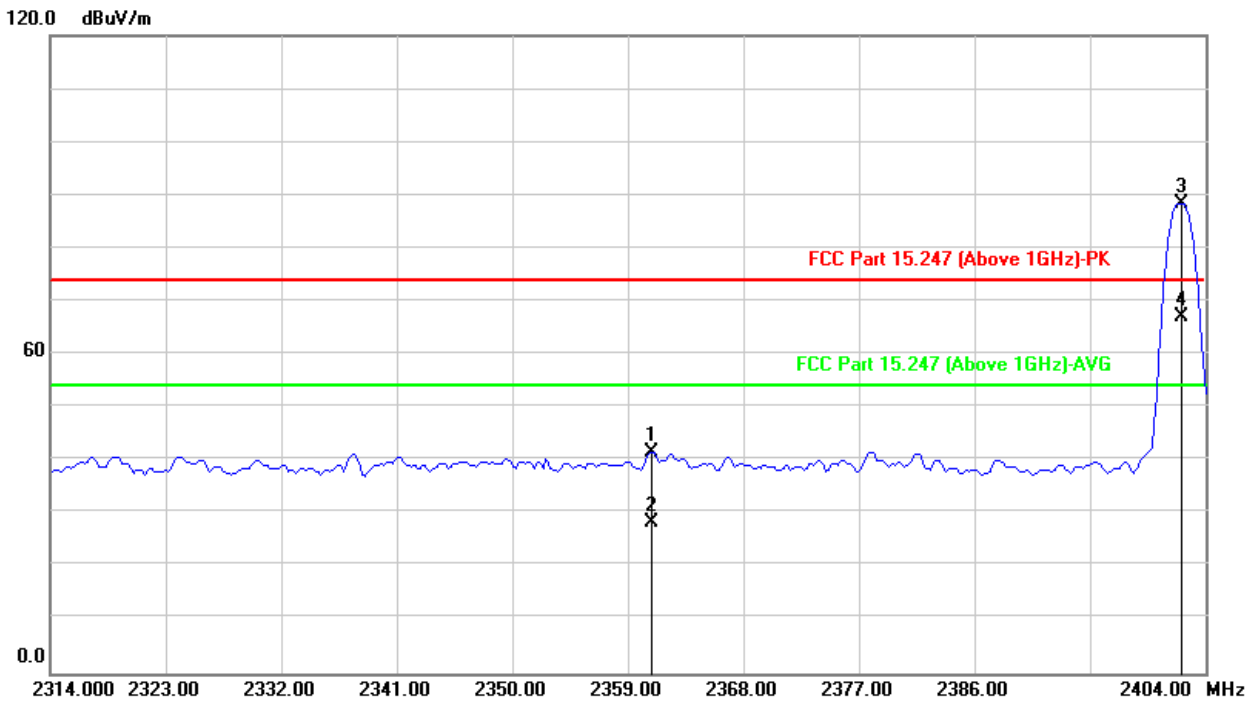

No.	Frequency (MHz)	Reading (dBuV)	Factor (dB)	Emission Level (dBuV/m)	Limit (dBuV/m)	Margin (dB)	Detector	Antenna Height (cm)	Table Angle (Degree)
1	2360.894	40.85	0.81	41.66	74.00	-32.34	peak	101	105
2	2360.894	27.62	0.81	28.43	54.00	-25.57	AVG	101	105
3#	2402.196	87.53	0.83	88.36			peak	101	105
4#	2402.196	66.18	0.83	67.01			AVG	101	105
5	4804.000	46.92	6.60	53.52	74.00	-20.48	peak	245	265
6	4804.000	38.23	6.60	44.83	54.00	-9.17	AVG	245	265
7	7206.000	41.61	10.08	51.69	74.00	-22.31	peak	235	290
8	7206.000	28.52	10.08	38.60	54.00	-15.40	AVG	235	290

Remarks:

- Emission Level = Read Level + Factor (Antenna Factor + Cable Loss - Preamp Factor)
Margin value = Emission level – Limit value
- #2402MHz: Fundamental frequency.
- The amplitude of spurious emissions attenuated more than 20 dB below the permissible value is not required to be report.

Lab: [Hwa-Hsing \(Dongguan\) Testing Co., Ltd.](#)

Address: [No. 101, Building N1, Yuyuan 2 Road, Yuyuan Industrial Park, HuangJiang Town, Dongguan City, People's Republic of China](#)

Tel: [0769-83078199](tel:0769-83078199)

Web.: www.hwa-hsing.com

E-Mail: customerservice.dg@hwa-hsing.com

Release

[Ver. 1.5](#)



Frequency Range	1GHz ~ 25GHz	Detector Function	Peak (PK) Average (AVG)
Test Channel	Channel 39		

Antenna Polarity & Test Distance: Horizontal at 3 m									
No.	Frequency (MHz)	Reading (dBuV)	Factor (dB)	Emission Level (dBuV/m)	Limit (dBuV/m)	Margin (dB)	Detector	Antenna Height (cm)	Table Angle (Degree)
1#	2441.000	95.37	0.69	96.06			peak	186	67
2#	2441.000	78.46	0.69	79.15			AVG	186	67
3	4882.000	47.58	6.77	54.35	74.00	-19.65	peak	115	317
4	4882.000	38.11	6.77	44.88	54.00	-9.12	AVG	115	317
5	7323.000	40.05	10.37	50.42	74.00	-23.58	peak	184	248
6	7323.000	28.35	10.37	38.72	54.00	-15.28	AVG	184	248
Antenna Polarity & Test Distance: Vertical at 3 m									
No.	Frequency (MHz)	Reading (dBuV)	Factor (dB)	Emission Level (dBuV/m)	Limit (dBuV/m)	Margin (dB)	Detector	Antenna Height (cm)	Table Angle (Degree)
1#	2441.000	83.86	0.69	84.55			peak	150	109
2#	2441.000	68.11	0.69	68.80			AVG	150	109
3	4882.000	46.67	6.77	53.44	74.00	-20.56	peak	235	265
4	4882.000	37.02	6.77	43.79	54.00	-10.21	AVG	235	265
5	7323.000	41.34	10.37	51.71	74.00	-22.29	peak	166	240
6	7323.000	28.32	10.37	38.69	54.00	-15.31	AVG	166	240

Remarks:

- Emission Level = Read Level + Factor (Antenna Factor + Cable Loss - Preamp Factor)
Margin value = Emission level – Limit value
- #2441MHz: Fundamental frequency.
- The amplitude of spurious emissions attenuated more than 20 dB below the permissible value is not required to be report.

Frequency Range	1GHz ~ 25GHz	Detector Function	Peak (PK) Average (AVG)
Test Channel	Channel 78		

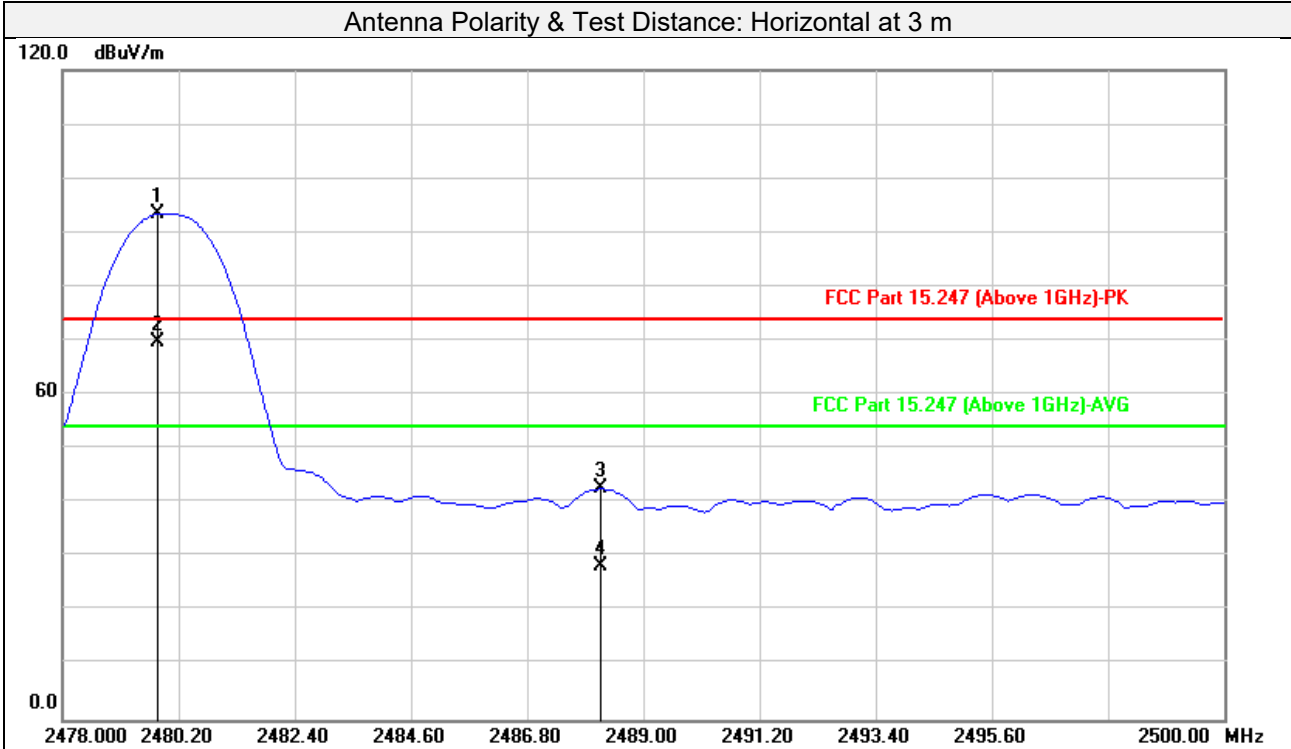

No.	Frequency (MHz)	Reading (dBuV)	Factor (dB)	Emission Level (dBuV/m)	Limit (dBuV/m)	Margin (dB)	Detector	Antenna Height (cm)	Table Angle (Degree)
1#	2479.808	92.53	0.85	93.38			peak	170	52
2#	2479.808	68.93	0.85	69.78			AVG	170	52
3	2488.184	41.76	0.86	42.62	74.00	-31.38	peak	170	52
4	2488.184	27.64	0.86	28.50	54.00	-25.50	AVG	170	52
5	4960.000	47.89	6.93	54.82	74.00	-19.18	peak	118	312
6	4960.000	38.53	6.93	45.46	54.00	-8.54	AVG	118	312
7	7440.000	40.38	10.67	51.05	74.00	-22.95	peak	233	212
8	7440.000	28.18	10.67	38.85	54.00	-15.15	AVG	233	212

Remarks:

- Emission Level = Read Level + Factor (Antenna Factor + Cable Loss - Preamp Factor)
Margin value = Emission level – Limit value
- #2480MHz: Fundamental frequency.
- The amplitude of spurious emissions attenuated more than 20 dB below the permissible value is not required to be report.

Frequency Range	1GHz ~ 25GHz	Detector Function	Peak (PK) Average (AVG)
Test Channel	Channel 78		

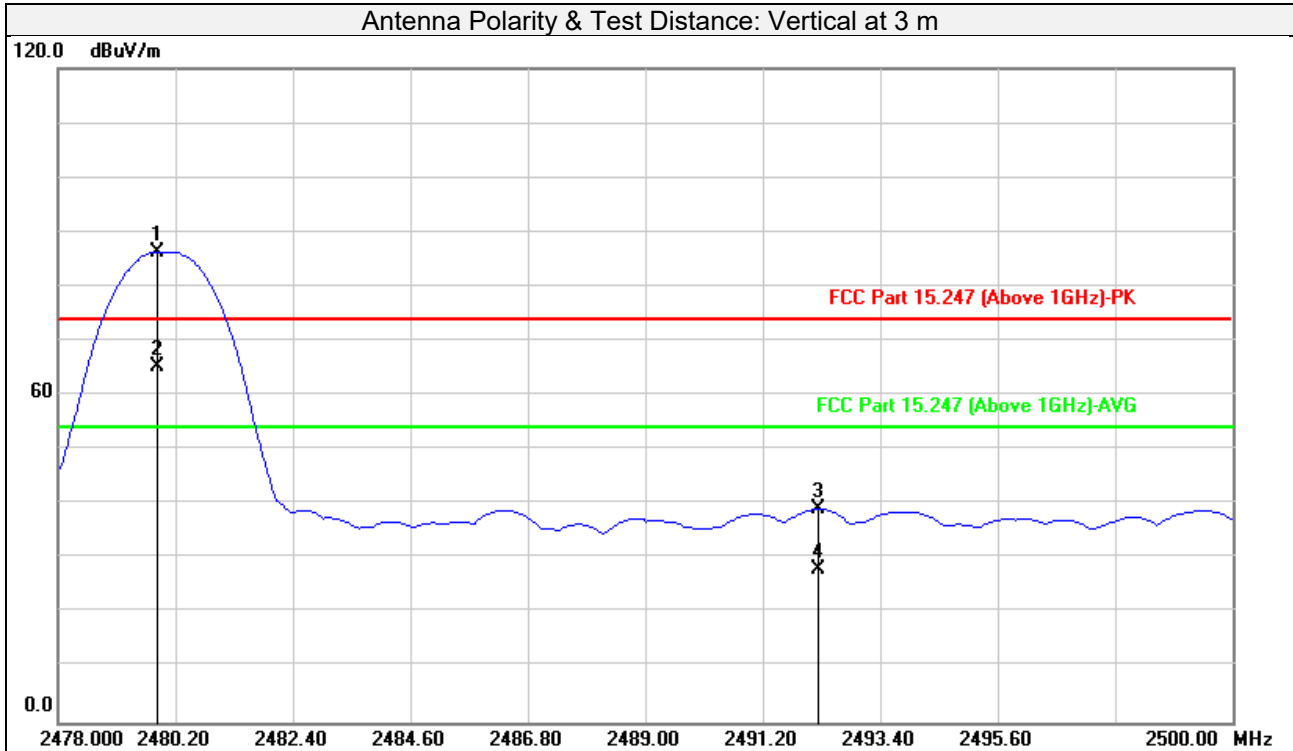

No.	Frequency (MHz)	Reading (dBuV)	Factor (dB)	Emission Level (dBuV/m)	Limit (dBuV/m)	Margin (dB)	Detector	Antenna Height (cm)	Table Angle (Degree)
1#	2479.852	85.47	0.85	86.32			peak	123	107
2#	2479.852	64.39	0.85	65.24			AVG	123	107
3	2492.240	38.25	0.86	39.11	74.00	-34.89	peak	123	107
4	2492.240	27.06	0.86	27.92	54.00	-26.08	AVG	123	107
5	4960.000	46.28	6.93	53.21	74.00	-20.79	peak	239	268
6	4960.000	37.58	6.93	44.51	54.00	-9.49	AVG	239	268
7	7440.000	41.44	10.67	52.11	74.00	-21.89	peak	214	299
8	7440.000	28.32	10.67	38.99	54.00	-15.01	AVG	214	299

Remarks:

- Emission Level = Read Level + Factor (Antenna Factor + Cable Loss - Preamp Factor)
Margin value = Emission level – Limit value
- #2480MHz: Fundamental frequency.
- The amplitude of spurious emissions attenuated more than 20 dB below the permissible value is not required to be report.

Lab: [Hwa-Hsing \(Dongguan\) Testing Co., Ltd.](#)

Address: [No. 101, Building N1, Yuyuan 2 Road, Yuyuan Industrial Park, HuangJiang Town, Dongguan City, People's Republic of China](#)

Tel: [0769-83078199](tel:0769-83078199)

Web.: www.hwa-hsing.com

E-Mail: customerservice.dg@hwa-hsing.com

Release

[Ver. 1.5](#)



3.2 Number of Hopping Frequency Used

3.2.1 Limits of Hopping Frequency Used Measurement

At least 15 channels frequencies, and should be equally spaced.

3.2.2 Test Setup

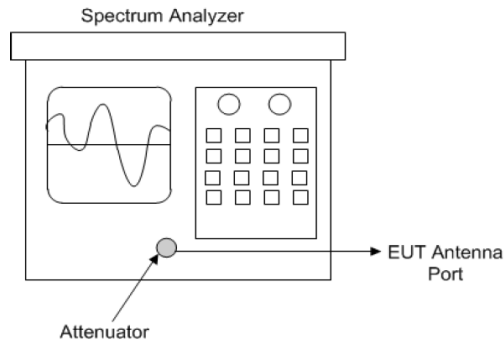

Spectrum analyzer test configuration

3.2.3 Test Instruments

Refer to section 5 to get information of above instrument.

3.2.4 Test Procedure

- Check the calibration of the measuring instrument (SA) using either an internal calibrator or a known signal from an external generator.
- Turn on the EUT and connect its antenna terminal to measurement via a low loss cable. Then set it to any one measured frequency within its operating range and make sure the instrument is operated in its linear range.
- Set the SA on MaxHold Mode, and then keep the EUT in hopping mode. Record all the signals from each channel until each one has been recorded.
- Set the SA on View mode and then plot the result on SA screen.
- Repeat above procedures until all frequencies measured were complete.

3.2.5 Deviation from Test Standard

No deviation.

3.2.6 Test Results

There are 79 hopping frequencies in the hopping mode. Please refer to next page for the test result. On the plots, it shows that the hopping frequencies are equally spaced.

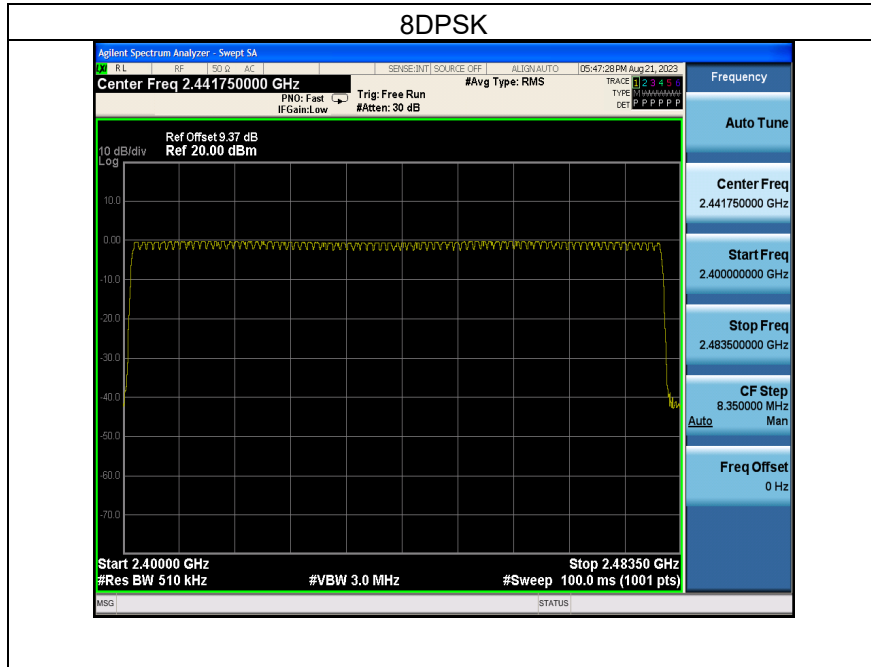
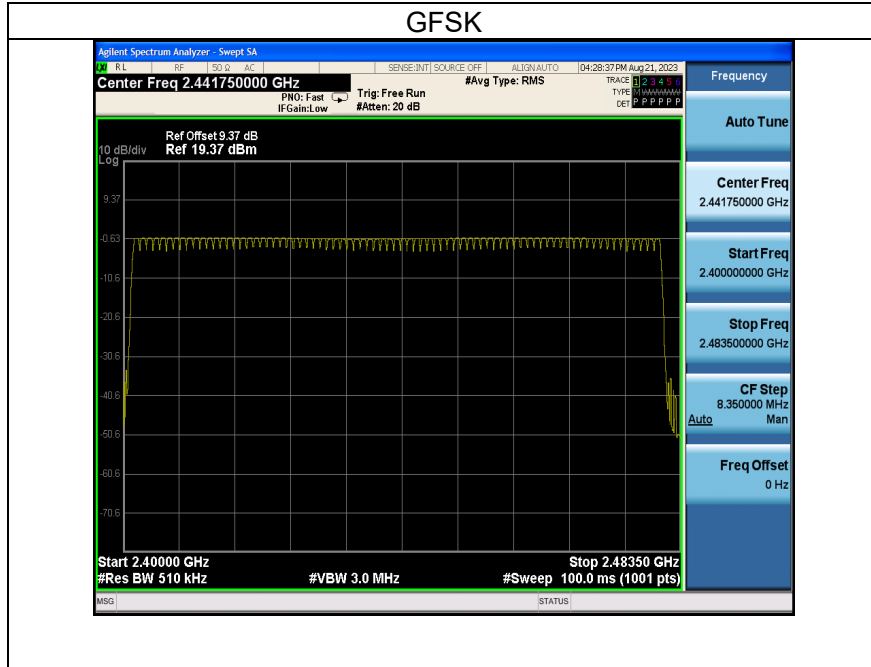



3.3 Dwell Time on Each Channel

3.3.1 Limits of Dwell Time on Each Channel Measurement

The average time of occupancy on any channel shall not be greater than 0.4 seconds within a period of 0.4 seconds multiplied by the number of hopping channels employed.

3.3.2 Test Setup

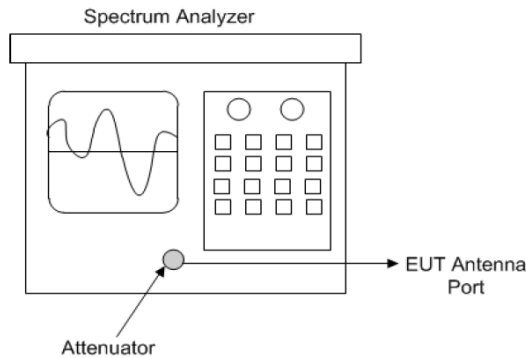

Spectrum analyzer test configuration

3.3.3 Test Instruments

Refer to section 5 to get information of above instrument.

3.3.4 Test Procedures

- a. Check the calibration of the measuring instrument (SA) using either an internal calibrator or a known signal from an external generator.
- b. Turn on the EUT and connect its antenna terminal to measurement via a low loss cable. Then set it to any one measured frequency within its operating range and make sure the instrument is operated in its linear range.
- c. Adjust the center frequency of SA on any frequency be measured and set SA to zero span mode. And then, set RBW and VBW of spectrum analyzer to proper value.
- d. Measure the time duration of one transmission on the measured frequency. And then plot the result with time difference of this time duration.
- e. Repeat above procedures until all different time-slot modes have been completed.

3.3.5 Deviation from Test Standard

No deviation.



3.3.6 est Results

GFSK

Mode	Number of Hopping Channel	Number of transmission in a period (channel number*0.4 sec)				Length of transmission time (msec)	Result (msec)	Limit (msec)	Verdict
		Period (sec)	Sweep time (sec)	times in a sweep	times in a period				
DH1	79	31.6	3.16	31	310	0.381	118.203	400	Pass
DH3	79	31.6	3.16	17	170	1.637	278.290	400	Pass
DH5	79	31.6	3.16	4	40	2.885	115.400	400	Pass

Note: Test plots of the transmitting time slot are shown as below.

8DPSK

Mode	Number of Hopping Channel	Number of transmission in a period (channel number*0.4 sec)				Length of transmission time (msec)	Result (msec)	Limit (msec)	Verdict
		Period (sec)	Sweep time (sec)	times in a sweep	times in a period				
3DH1	79	31.6	3.16	32	320	0.391	125.248	400	Pass
3DH3	79	31.6	3.16	17	170	1.643	279.310	400	Pass
3DH5	79	31.6	3.16	13	130	2.891	375.830	400	Pass

Note: Test plots of the transmitting time slot are shown as below.

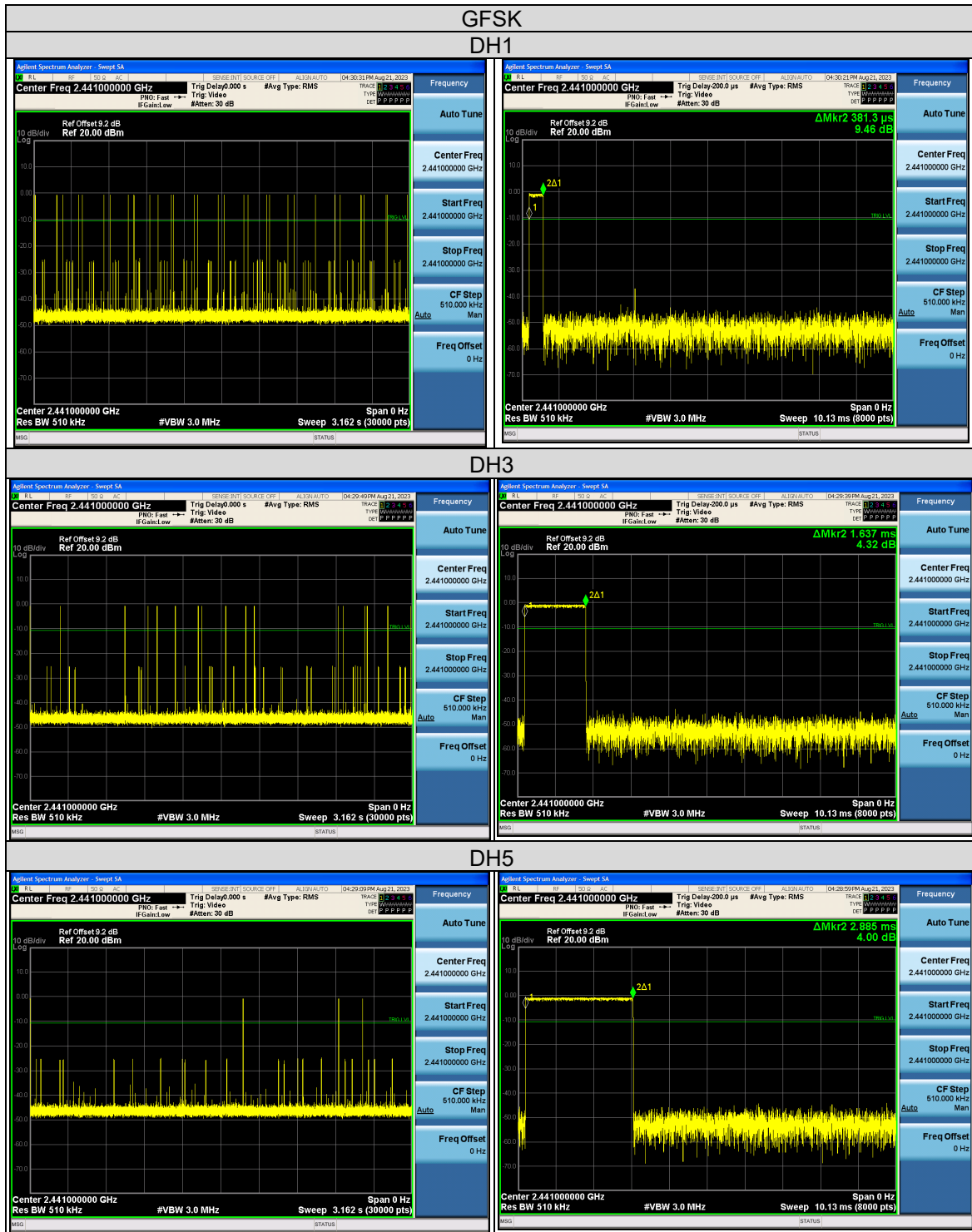

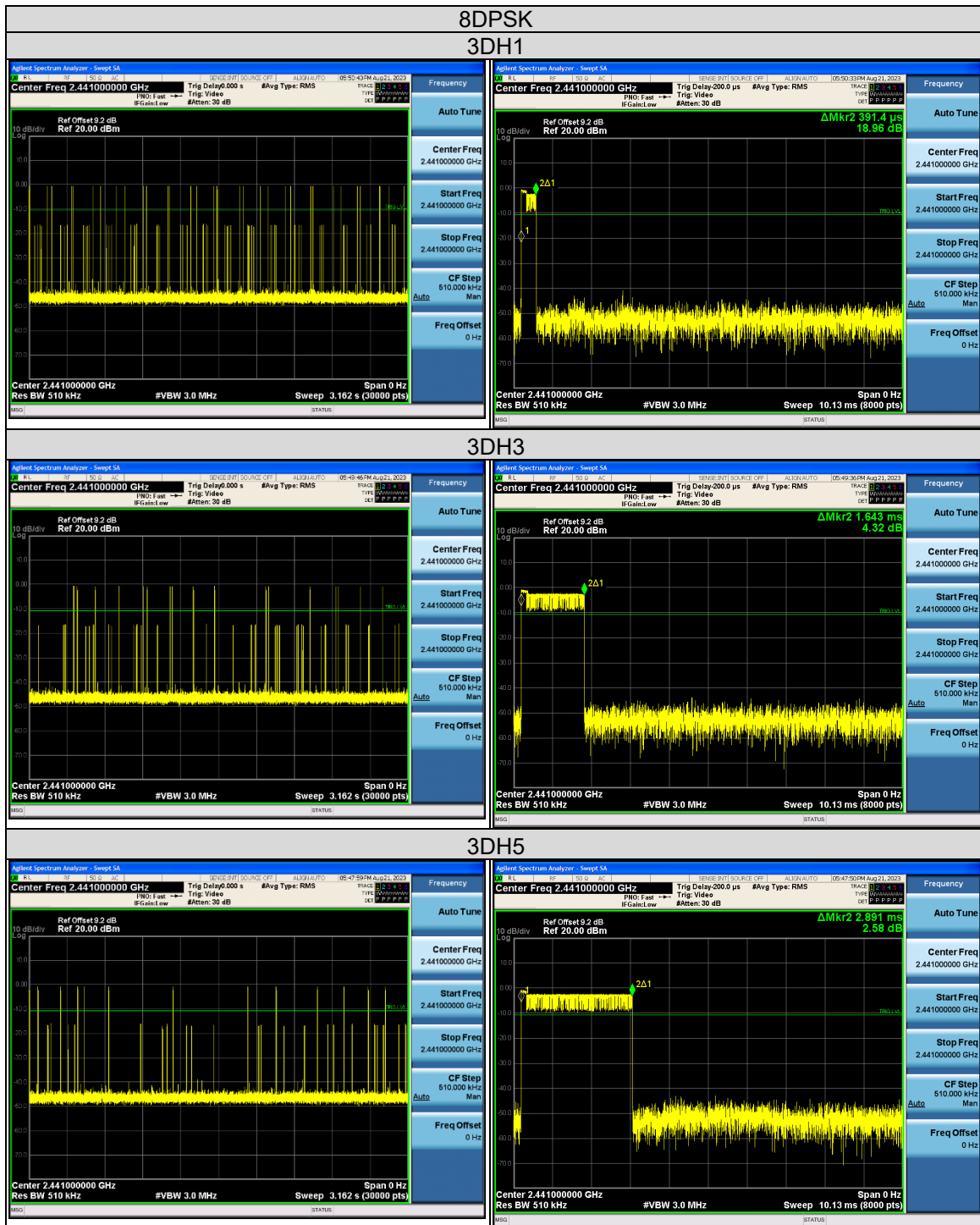

3.4 Channel Bandwidth

3.4.1 Limits of Channel Bandwidth Measurement

For frequency hopping system operating in the 2400-2483.5 MHz, if the 20 dB bandwidth of hopping channel is greater than 25 kHz, two-thirds 20 dB bandwidth of hopping channel shall be a minimum limit for the hopping channel separation.

3.4.2 Test Setup

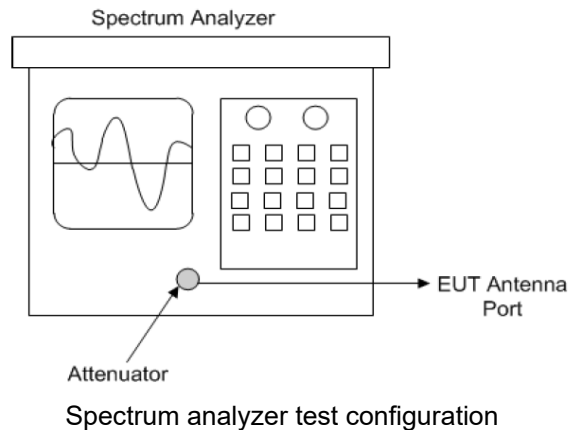

3.4.3 Test Instruments

Refer to section 5 to get information of above instrument.

3.4.4 Test Procedure

- Check the calibration of the measuring instrument using either an internal calibrator or a known signal from an external generator.
- Turn on the EUT and connect it to measurement instrument. Then set it to any one convenient frequency within its operating range. Set a reference level on the instrument equal to the highest peak value.
- Measure the frequency difference of two frequencies that were attenuated 20 dB from the reference level. Record the frequency difference as the emission bandwidth.
- Repeat above procedures until all frequencies measured were complete.

3.4.5 Deviation from Test Standard

No deviation.

3.4.6 EUT Operating Condition

The software provided by client enabled the EUT to transmit and receive data at lowest, middle and highest channel frequencies individually.

Lab: [Hwa-Hsing \(Dongguan\) Testing Co., Ltd.](#)

Address: [No. 101, Building N1, Yuyuan 2 Road, Yuyuan Industrial Park, HuangJiang Town, Dongguan City, People's Republic of China](#)

Tel: [0769-83078199](tel:0769-83078199)

Web.: www.hwa-hsing.com

E-Mail: customerservice.dg@hwa-hsing.com

Release

[Ver. 1.5](#)



3.4.7 Test Results

Channel	Frequency (MHz)	20dB Bandwidth (MHz)	
		GFSK	8DPSK
0	2402	1.026	1.302
39	2441	1.017	1.311
78	2480	0.999	1.290

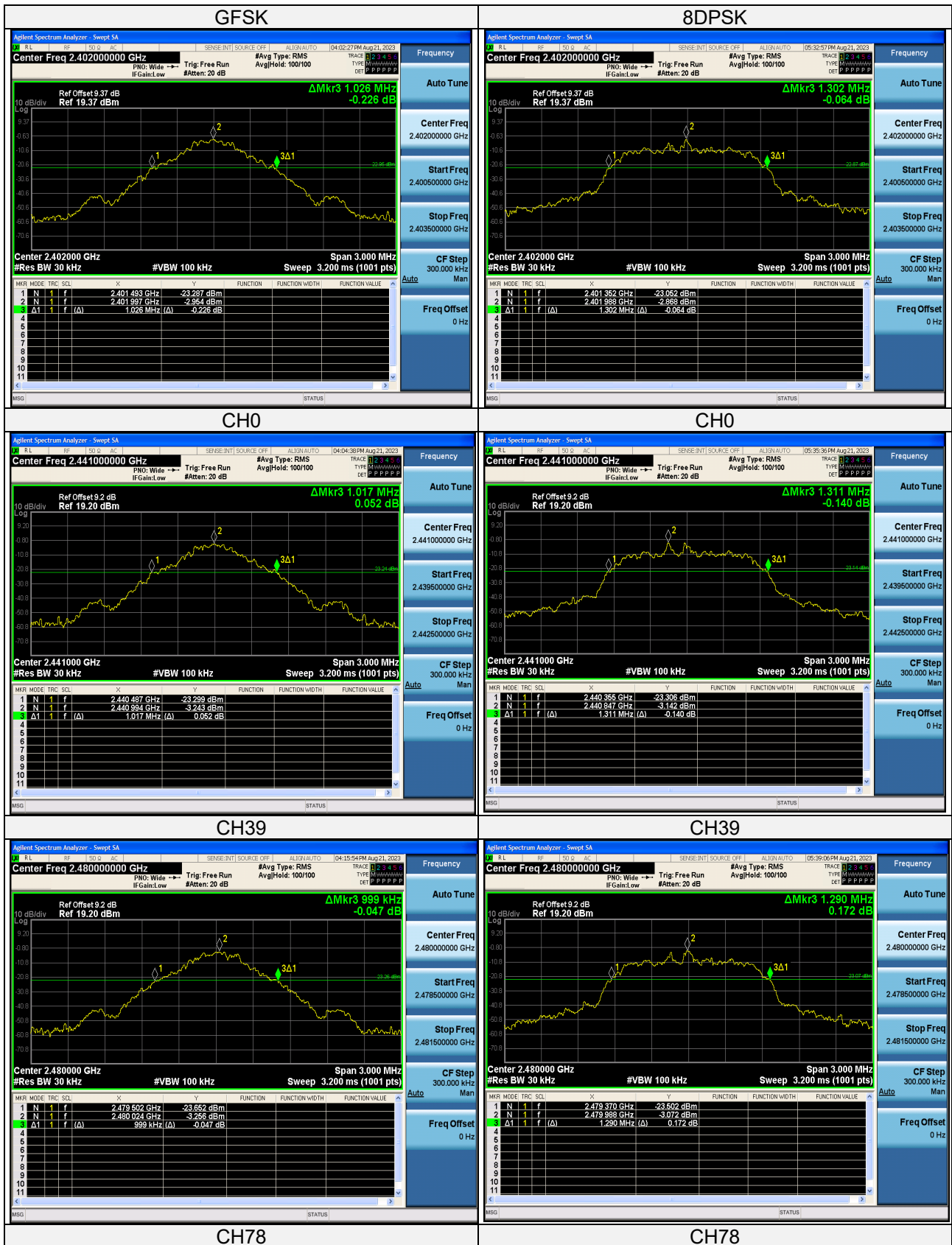

3.5 Occupied Bandwidth Measurement

3.5.1 Test Setup

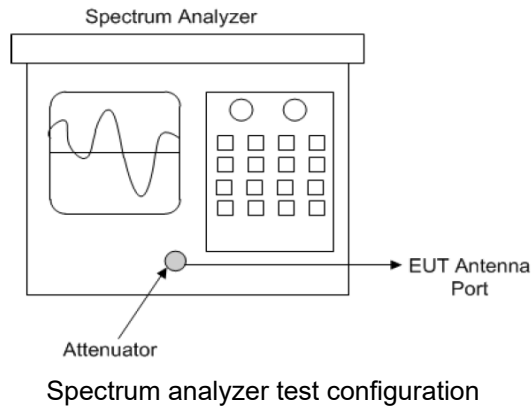

3.5.2 Test Instruments

Refer to section 5 to get information of above instrument

3.5.3 Test Procedure

The transmitter output was connected to the spectrum analyzer through an attenuator. The bandwidth of the fundamental frequency was measured by spectrum analyzer with resolution bandwidth in the range of 1% to 5% of the anticipated emission bandwidth, and a video bandwidth at least 3x the resolution bandwidth and set the detector to PEAK. The width of a frequency band such that, below the lower and above the upper frequency limits, the mean powers emitted are each equal to a specified percentage 0.5% of the total mean power of a given emission.

3.5.4 Deviation from Test Standard

No deviation.

3.5.5 EUT Operating Conditions

The software provided by client to enable the EUT under transmission condition continuously at lowest, middle and highest channel frequencies individually.



3.5.6 Test Results

Channel	Frequency (MHz)	Occupied Bandwidth (MHz)	
		GFSK	8DPSK
0	2402	0.8944	1.1859
39	2441	0.8970	1.1950
78	2480	0.8852	1.1835



3.6 Hopping Channel Separation

3.6.1 Limits of Hopping Channel Separation Measurement

At least 25 kHz or two-third of 20 dB hopping channel bandwidth (whichever is greater).

3.6.2 Test Setup

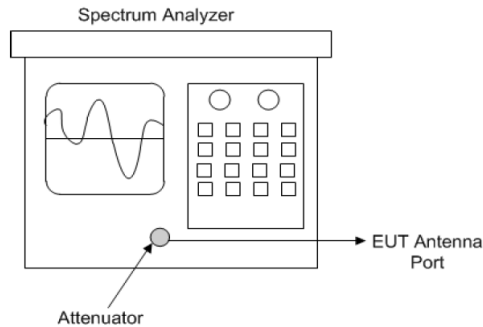

3.6.3 Test Instruments

Refer to section 5 to get information of above instrument.

3.6.4 Test Procedure

- Check the calibration of the measuring instrument using either an internal calibrator or a known signal from an external generator.
- Turn on the EUT and connect it to measurement instrument. Then set it to any one convenient frequency within its operating range.
- By using the MaxHold function record the separation of two adjacent channels.
- Measure the frequency difference of these two adjacent channels by SA MARK function. And then plot the result on SA screen.
- Repeat above procedures until all frequencies measured were complete.

3.6.5 Deviation from Test Standard

No deviation.



3.6.6 Test Results

Channel No.	Frequency (MHz)	Adjacent Channel Separation (MHz)		Minimum Limit (MHz)		Pass / Fail
		GFSK	8DPSK	GFSK	8DPSK	
0	2402	1.002	0.996	0.684	0.868	Pass
39	2441	1.029	0.999	0.678	0.874	Pass
78	2480	0.996	1.014	0.666	0.860	Pass

Note: The minimum limit is two-third 20 dB bandwidth.

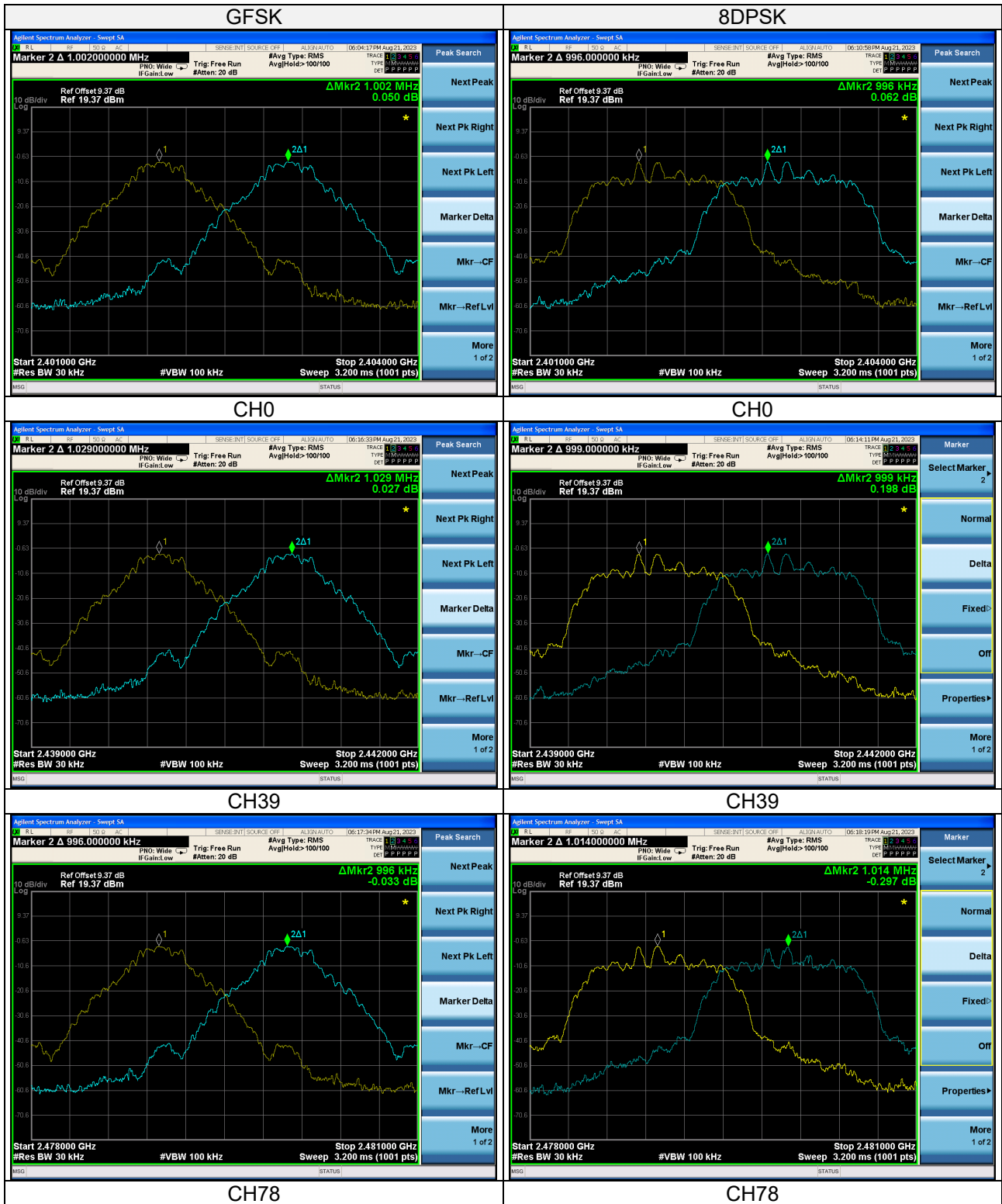



3.7 Maximum Output Power

3.7.1 Limits of Maximum Output Power Measurement

The Maximum Output Power Measurement is 125mW.

3.7.2 Test Setup

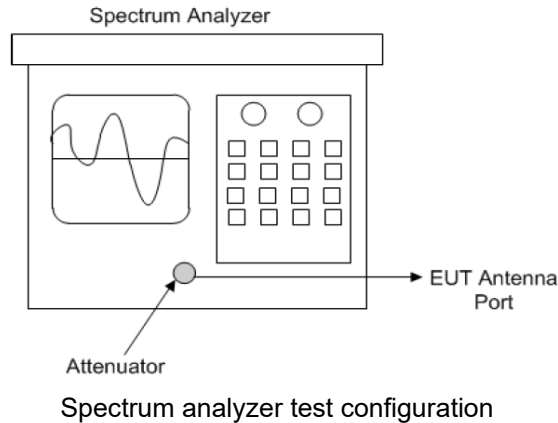

3.7.3 Test Instruments

Refer to section 5 to get information of above instrument.

3.7.4 Test Procedure

Measurement using a spectrum analyzer (SA), Selection of test method:

Maximum peak conducted output power

The following procedure shall be used when an instrument with a resolution bandwidth that is greater than the DTS bandwidth is available to perform the measurement:

- a) Set the RBW > DTS bandwidth.
- b) Set VBW > [3 x RBW]
- c) Set span > [3 x RBW]
- d) Sweep time = auto couple.
- e) Detector = peak
- f) Trace mode = max hold.
- g) Allow trace to fully stabilize.
- h) Use peak marker function to determine the peak amplitude level.



Maximum conducted (average) output power

- a) Check the calibration of the measuring instrument using either an internal calibrator or a known signal from an external generator.
- b) Turn on the EUT and connect it to measurement instrument. Then set it to any one convenient frequency within its operating range. Set a reference level on the measuring instrument equal to the highest peak value.
- c) SA Setting:
 - 1)* Set span to at least 1.5 times the OBW
 - 2)* Set sweep trigger to "free run."
 - 3)* Set RBW= 1% to 5% of the OBW. not to exceed 1MHz.
 - 4)* Set VBW $\geq 3 \times$ RBW
 - 5)* Number of points in sweep $\geq 2 \times$ span /RBW. (This gives bin-to-bin spacing \leq RBW / 2. so that narrowband signals are not lost between frequency bins).
 - 6)* Sweep time \leq (number of points in sweep) x T. where T is defined in 11.6. If this gives a sweep time less than the auto sweep time of the instrument. then method AVGSA-3 shall not be used (use AVGSA-3A). The purpose of this step is so that the averaging time in each bin is less than or equal to the minimum time of a transmission.
 - 7)* Detector =RMS (power averaging).
 - 8)* Trace mode =Max hold.
 - 9)* Allow max hold to run for at least 60 s or longer as needed to allow the trace to stabilize.
 - 10)* Compute power by integrating the spectrum across the OBW of the signal using the instrument's band power measurement function with band limits set equal to the OBW band edges. If the instrument does not have a band power function. then sum the spectrum levels (in power units) at intervals equal to the RBW extending across the entire OBW.
- d. Measure the captured power within the band and recording the plot.
- e. Repeat above procedures until all frequencies required were complete.

3.7.5 Deviation from Test Standard

No deviation.

3.7.6 EUT Operating Condition

The software provided by client enabled the EUT to transmit and receive data at lowest, middle and highest channel frequencies individually.



3.7.7 Test Results

Peak power

Channel No.	Freq. (MHz)	Output Power (dBm)		Output Power (mW)		Power Limit (mW)	Pass / Fail
		GFSK	8DPSK	GFSK	8DPSK		
0	2402	-0.457	-0.395	0.900	0.913	125	Pass
39	2441	-0.775	-0.654	0.837	0.860	125	Pass
78	2480	-0.767	-0.684	0.838	0.854	125	Pass

Average power

Channel No.	Freq. (MHz)	Output Power (dBm)		Output Power (mW)		Power Limit (mW)	Pass / Fail
		GFSK	8DPSK	GFSK	8DPSK		
0	2402	-1.89	-3.02	0.647	0.499	125	Pass
39	2441	-1.95	-3.33	0.638	0.465	125	Pass
78	2480	-1.82	-3.45	0.658	0.452	125	Pass

Peak Power Spectrum Plot

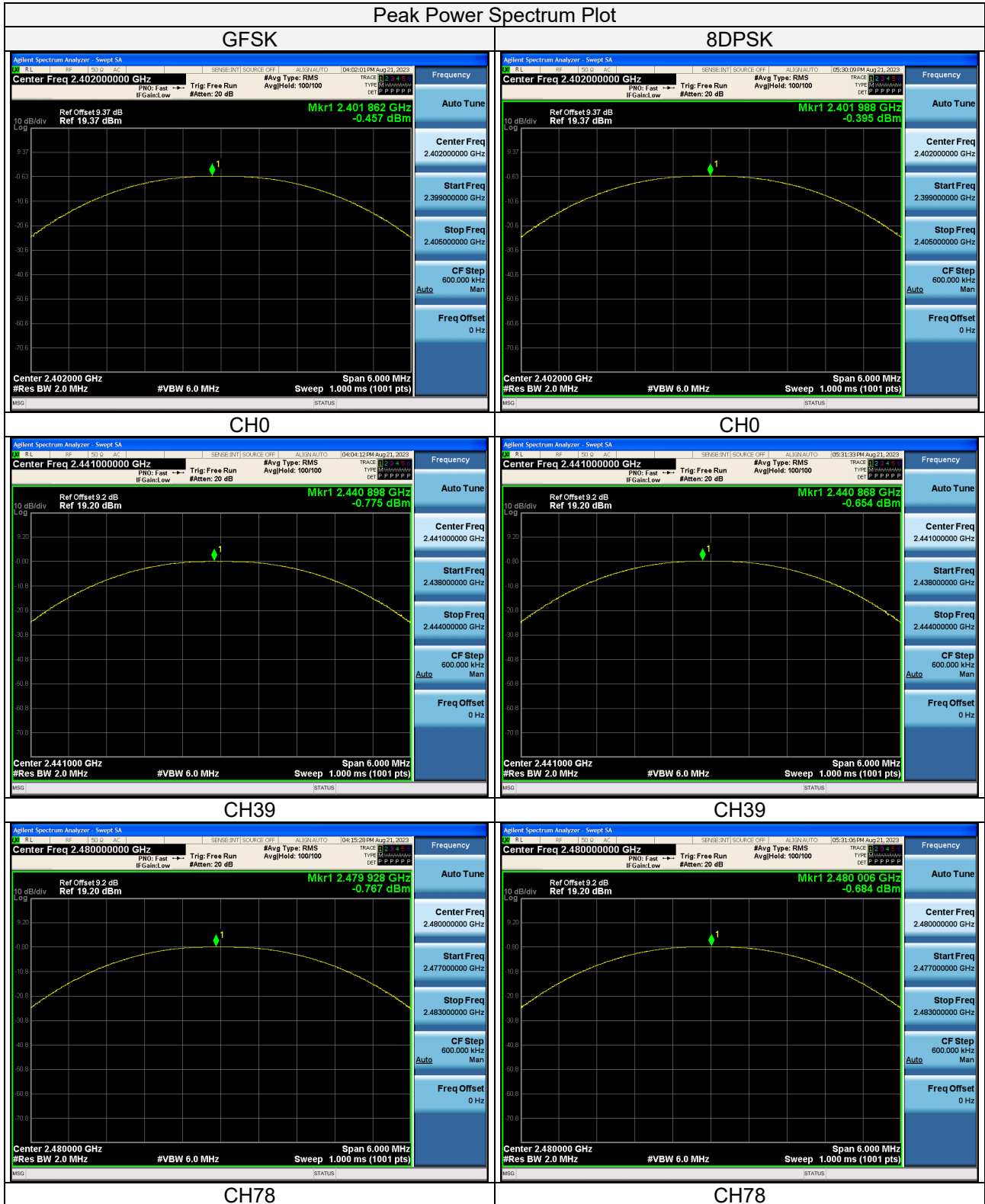

Average Power Spectrum Plot

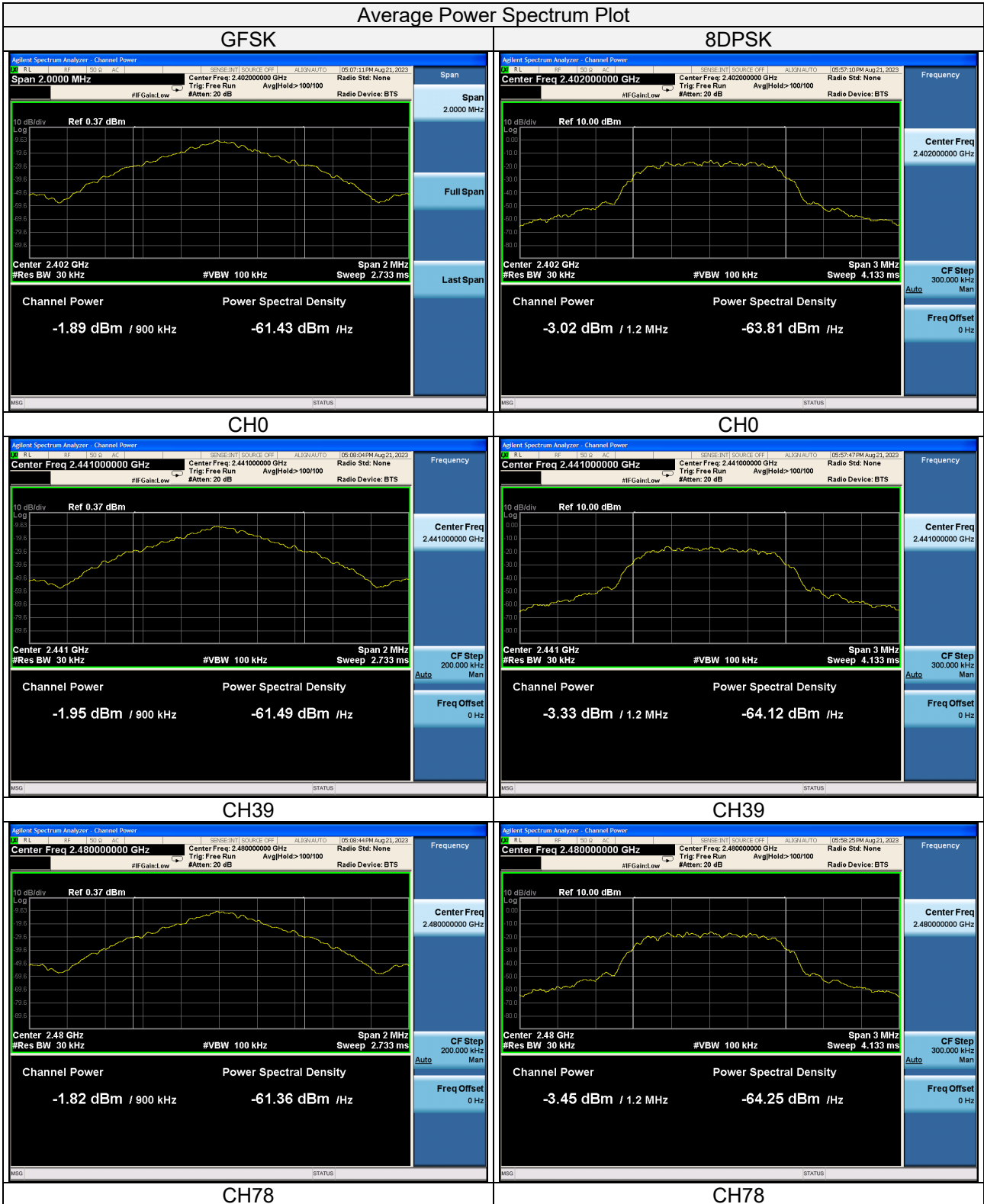

3.8 Conducted Out of Band Emission Measurement

3.8.1 Limits of Conducted Out of Band Emission Measurement

- a. **If the maximum peak conducted output power procedure was used to determine compliance as described in 11.9.1**, then the peak output power measured in any 100 kHz bandwidth outside of the authorized frequency band shall be attenuated by at least 20 dB relative to the maximum in-band peak PSD level in 100 kHz (i.e., 20 dBc).
- b. **If maximum conducted (average) output power was used to determine compliance as described in 11.9.2**, then the peak power in any 100 kHz bandwidth outside of the authorized frequency band shall be attenuated by at least 30 dB relative to the maximum in-band peak PSD level in 100 kHz (i.e., 30 dBc)

3.8.2 Test Setup

- DTS emissions in non-restricted frequency bands Subclause 11.11 of ANSI C63.10 is applicable.
- DTS emissions in restricted frequency bands Subclause 11.12 of ANSI C63.10 is applicable

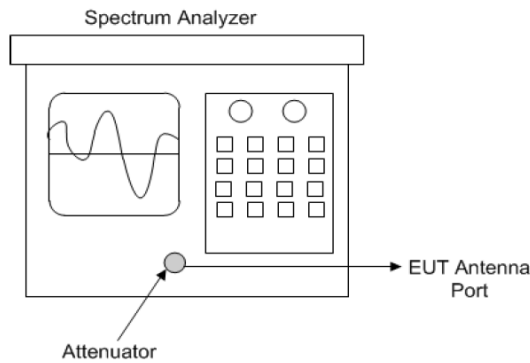

Spectrum analyzer test configuration

3.8.3 Test Instruments

Refer to section 5 to get information of above instrument.



3.8.4 Test Procedure

- a. Establish a reference level by using the following procedure:
 - 1) Set instrument center frequency to DTS channel center frequency.
 - 2) Set the span to 21.5 times the DTS bandwidth)
 - 3) Set the RBW= 100 kHz)
 - 4) Set the VBW $\geq 3 \times$ RBW
 - 5) Detector = peak
 - 6) Sweep time = auto coupling
 - 7) Trace mode =max hold
 - 8) Allow trace to fully stabilize
 - 9) Use the peak marker function to determine the maximum PSD level.

Note that the channel found to contain the maximum PSD level can be used to establish the reference level.

- b. Establish an emission level by using the following procedure:
 - 1) Set the center frequency and span to encompass frequency range to be measured.
 - 2) Set the RBW = 100 kHz
 - 3) Set the VBW ≥ 300 kHz.
 - 4) Detector = peak.
 - 5) Sweep time = auto couple.
 - 6) Trace mode = max hold.
 - 7) Allow trace to fully stabilize.
 - 8) Use the peak marker function to determine the maximum power level in any 100 kHz band segment within the fundamental EBW.

3.8.5 Deviation from Test Standard

No deviation.

3.8.6 EUT Operating Condition

The software provided by client enabled the EUT to transmit and receive data at lowest, middle and highest channel frequencies individually.

3.8.7 Test Results

The spectrum plots are attached on the following images. D1 line indicates the highest level, D2 line indicates the 20dB offset below D1. It shows compliance with the requirement.

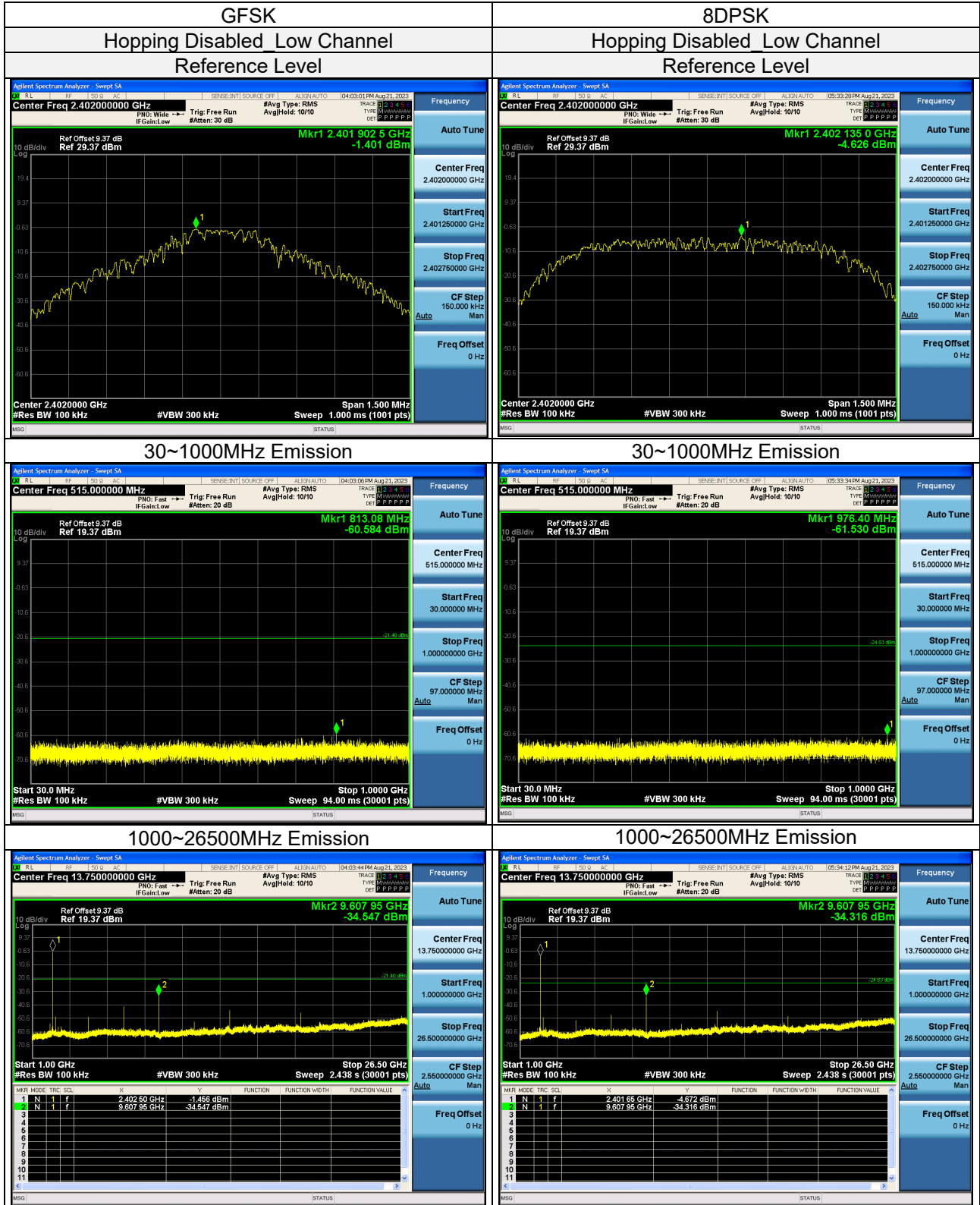

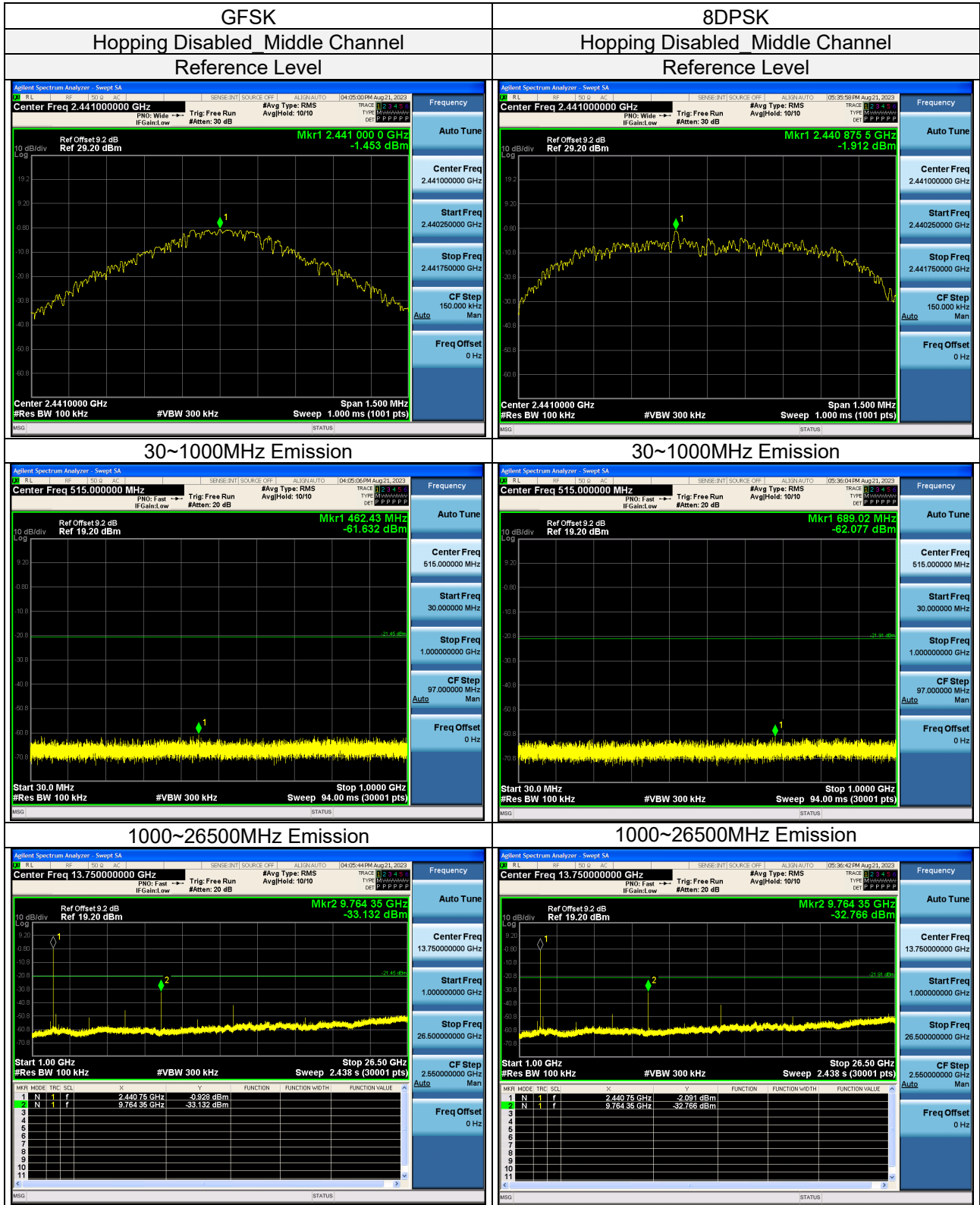

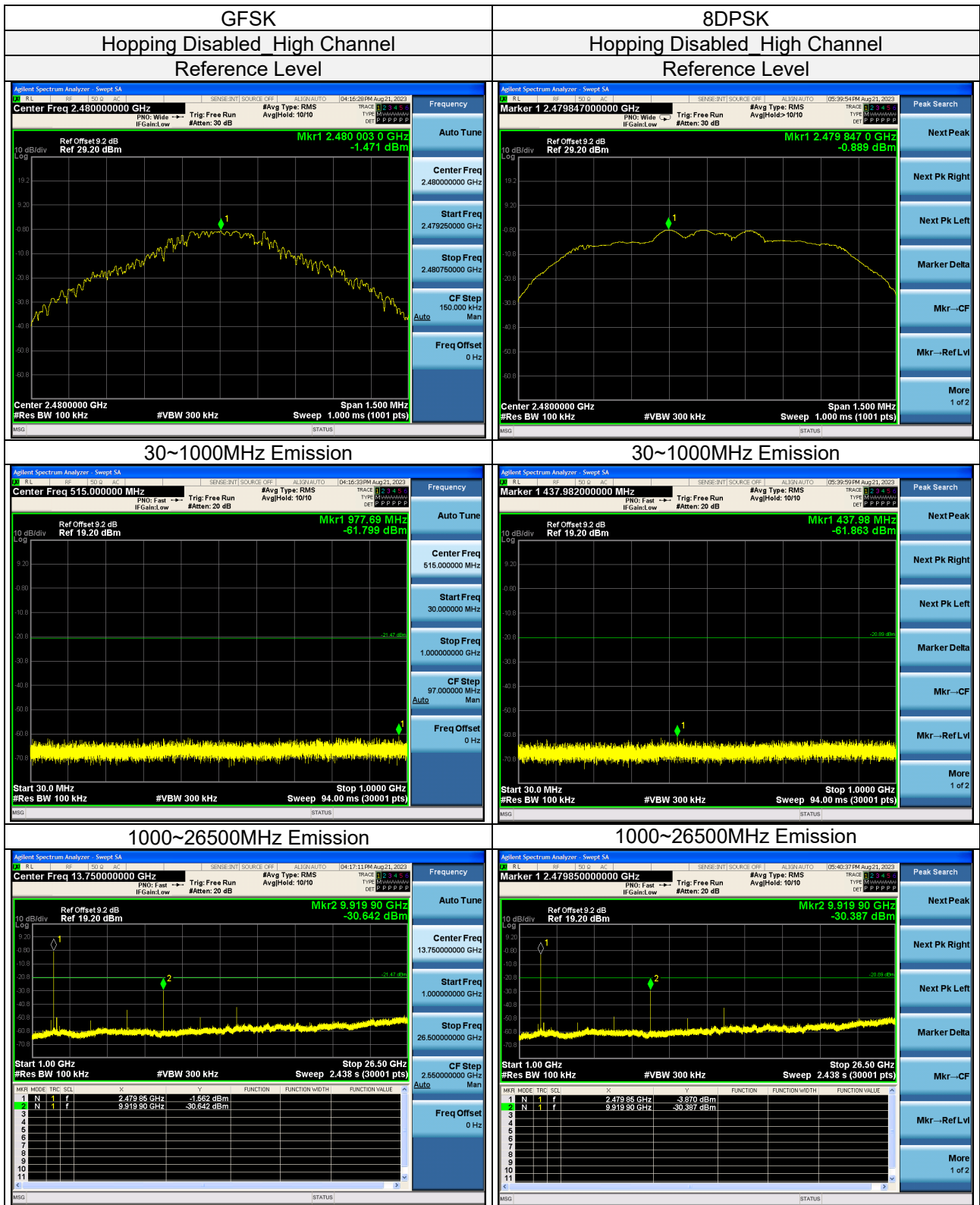

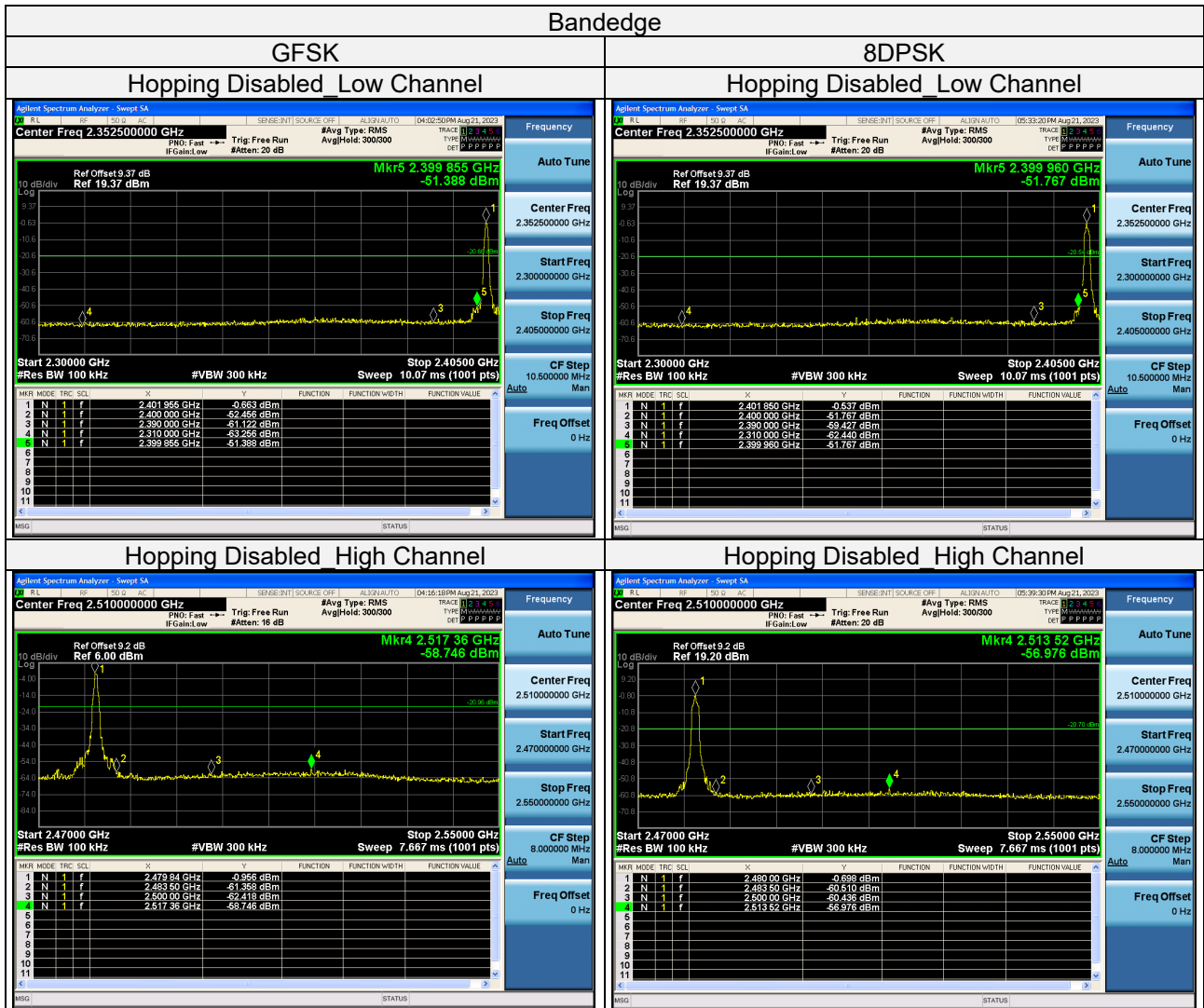

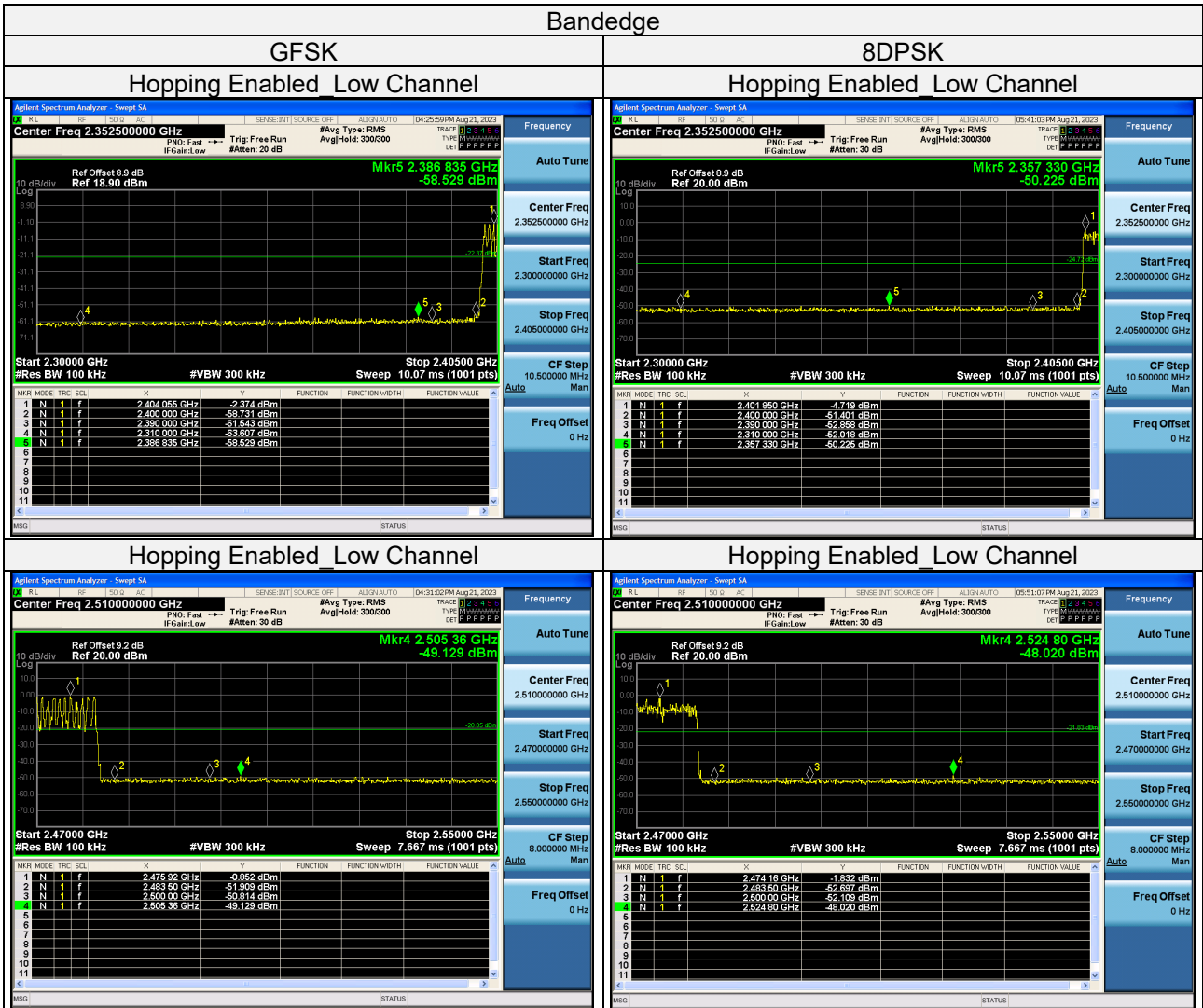



HWA-HSING

Test Report No.: 23080202-RF-US-01

4 Pictures of Test Arrangements

Please refer to the attached file (Test Setup Photo).

Lab: [Hwa-Hsing \(Dongguan\) Testing Co., Ltd.](#)

Address: [No. 101, Building N1, Yuyuan 2 Road, Yuyuan Industrial Park, HuangJiang Town, Dongguan City, People's Republic of China](#)

Tel: [0769-83078199](tel:0769-83078199)

Web.: www.hwa-hsing.com

E-Mail: customerservice.dg@hwa-hsing.com

Release
[Ver. 1.5](#)



5 Test Instruments

Description	Manufacturer	Model No.	Serial No.	Due Date of Calibration
Spectrum	Keysight	N9020A	MY51240612	2023-08-25
Spectrum Analyzer	Rohde&Schwarz	FSV-40N	101783	2023-12-27
Power Meter 10Hz~18GHz	Tonscend	JS0806-2	188060126	2023-08-25
Signal generator	Keysight	E4421B	GB40051020	2023-08-25
Signal generator	Keysight	N5182A	MY47420944	2023-08-25
Test Software	Tonscend	JS0806-2	NA	NA
Hygrothermograph	Yuhuaze	HTC-1	NA	2023-08-25

Note 1. The calibration interval of the above test instruments is 12 months.
: 2. The test was performed in Chamber.

**Appendix – Information on the Testing Laboratories**

We, [Hwa-Hsing \(Dongguan\) Testing Co., Ltd.](#), A global provider of TESTING and CERTIFICATION services for consumer products, electronic products and wireless information technology products. Adhering to the core values “HONEST and TRUSTWORTHY, OBJECTIVE and IMPARTIALITY, RIGOROUS and AFFICIENT”, commitment to provide professional, perfect and efficient comprehensive ONE-STOP solution of TESTING and CERTIFICATION services for Manufacturers, Buyers, Traders, Brands, Retailers. Assist client to better manage risk, protect their brands, reduce costs and cut time to over 150 markets in global. Our laboratories are FCC recognized accredited test firms and accredited and approved according to ISO/IEC 17025.

If you have any comments, please feel free to contact us at the following:

Lab Address: [No. 101, Building N1, Yuyuan 2 Road, Yuyuan Industrial Park, HuangJiang Town, Dongguan City, People's Republic of China](#)

Contact Tel: [0769-83078199](tel:0769-83078199)

Email: Customerservice.dg@hwa-hsing.com

Web Site: www.hwa-hsing.com

The address and road map of all our labs can be found in our web site also.

--- END ---