

TECHNICAL REPORT



Report No.: TW2108148E

File Reference No.: 2021-09-01

Applicant: King of Fans, Inc.

Product: P250061

Trademark: Progress Lighting

Model No.: P250061

Test Standards: FCC Part 15 Subpart B

Test Result: It is herewith confirmed and found to comply with the requirements set up by ANSI C63.4&FCC Part 15 regulations for the evaluation of electromagnetic compatibility

Approved By

A handwritten signature in black ink that reads 'Terry Tang'.

Terry Tang

Manager

Dated: September 01, 2021

Results appearing herein relate only to the sample tested

The technical reports is issued errors and omissions exempt and is subject to withdrawal at

SHENZHEN TIMEWAY TESTING LABORATORIES.

**Zone C, 1st Floor, Block B, Jun Xiang Da Building, Zhongshan Park Road West,
Tong Le Village, Nanshan District, Shenzhen, China**

Tel (755) 83448688 Fax (755) 83442996 Email: info@timeway-lab.com



Special Statement:

The testing quality ability of our laboratory meet with "Quality Law of People's Republic of China" Clause 19.

The testing quality system of our laboratory meet with ISO/IEC-17025 requirements, which is approved by CNAS. This approval result is accepted by MRA of APLAC.

Our test facility is recognized, certified, or accredited by the following organizations:

CNAS-LAB Code: L2292

The EMC Laboratory has been assessed and in compliance with CNAS-CL01 accreditation criteria for testing Laboratories (identical to ISO/IEC 17025:2005 General Requirements) for the Competence of testing Laboratories.

FCC-Registration No.: 744189

The EMC Laboratory has been registered and fully described in a report filed with the (FCC) Federal Communications commission. The acceptance letter from the FCC is maintained in our files. Registration No.: 744189.

Industry Canada (IC) —Registration No.:5205A

The EMC Laboratory has been registered by Certification and Engineering Bureau of Industry Canada for radio equipment testing with Registration No.: 5205A.

A2LA (Certification Number:5013.01)

The EMC Laboratory has been accredited by the American Association for Laboratory Accreditation (A2LA). Certification Number:5013.01



Content

1.0 General Details	4
1.1 Test Lab Details	4
1.2 Applicant Details	4
1.4 Submitted Sample: 1 pc	4
1.5 Test Duration	4
1.6 Test Uncertainty.....	4
1.7 Test Engineer	4
2.0 List of Measurement Equipment	5
2.1 Conducted Emission Test.....	5
2.2 Radiated electromagnetic disturbance test.....	5
2.3 Auxiliary Equipment.....	5
3.0 Technical Details	6
3.1 Investigations Requested	6
3.2 Test Standards	6
4.0 Conducted Power line Test	7
4.1 Schematics of the test	7
4.2 Test Method and test Procedure.....	7
4.3 Power line conducted Emission Limit	7
4.4 Test Results	7
6.0 FCC Label	16
7.0 Photo of testing	17
Conducted Emissions	17

"The report refers only to the sample tested and does not apply to the bulk production.
This report is issued in confidential to the client and it will be strictly treated as such by the SHENZHEN TIMEWAY TESTING LABORATORIES. It may not be reproduced rather in its entirety or in part and it may not be used for illegal purpose. The client to whom the report is issued may, however, show or send it , or a certified copy there of prepared by the SHENZHEN TIMEWAY TESTING LABORATORIES to his customer. Supplier or others persons directly concerned. SHENZHEN TIMEWAY TESTING LABORATORIES will not, without the consent of the client enter into any discussion of correspondence with any third party concerning the contents of the report.
In the event of the improper use of the report. The SHENZHEN TIMEWAY TESTING LABORATORIES reserves the rights to withdraw it and to adopt any other remedies which may be appropriate."



1.0 General Details

1.1 Test Lab Details

Name: SHENZHEN TIMEWAY TESTING LABORATORIES.
Address: Zone C, 1st Floor, Block B, Jun Xiang Da Building, Zhongshan Park Road West, Tong Le Village, Nanshan District, Shenzhen, China
Telephone: (755) 83448688
Fax: (755) 83442996

1.2 Applicant Details

Applicant: King of Fans, Inc.
Address: 1951 N.W. 22nd Street, Fort Lauderdale, FL33311, USA
Telephone: 954-484-7500
Fax: 954-784-7602

1.3 Description of EUT

Product: P250061
Manufacturer: Chienluen Industries (zhongshan) Ltd..
Address: Da Che Industrial Area, Nanlang Town, Zhongshan, Guangdong China 528451
Trademark: Progress Lighting
Model Number: P250061
Rating: Input: 120V, 60Hz, Fan W/O Light Kit: 0.6A, w/o light 40W; Output: w/light 0.85A, w/light 70W
Rx Frequency: 433.92MHz

1.4 Submitted Sample: 1 pc

1.5 Test Duration

Date of Receipt of Application: August 13, 2021
Date of Receipt of Test Item: August 13, 2021
Date of Test: August 13, 2021 ~ September 01, 2021

1.6 Test Uncertainty

Conducted Emissions Uncertainty =3.6dB
Radiated Emissions below 1GHz Uncertainty =4.7dB
Radiated Emissions above 1GHz Uncertainty =6.0dB

1.7 Test Engineer

The sample tested by

A handwritten signature in black ink that reads "Leo Lau".

Print Name: Leo Lau



2.0 List of Measurement Equipment

2.1 Conducted Emission Test

Name	Model No.	Serial No.	Manufacturer	Calibration Date	Calibration Cycle
EMI Test Receiver	ESH3	860905/006	RS	2021.06.18	1Year
Spectrum Analyzer	ESA-L1500A	US37451154	HP	2021.06.18	1Year
PULSE LIMITER	ESH3-Z2	100281	RS	2021.06.18	1Year
LISN	ESH3-Z5	100294	RS	2021.06.18	1Year
LISN	ESH3-Z5	100253	RS	2021.06.18	1Year
LISN	NNB42	00012	SCHAFFNER	2021.01.06	1Year

2.2 Radiated electromagnetic disturbance test

Name	Model No	Serial No.	Manufacturer	Calibration Date	Calibration Cycle
EMI Test Receiver	ESPI 3	100379	RS	2021.06.18	1Year
Spectrum Analyzer	E4407B	MY50441392	HP/Agilent	2021.06.18	1Year
Amplifier	BBV9743	#218	HP/Agilent	2021.06.18	1Year
Bilog Antenna	VULB9163	9163/340	Schwarebeck	2021.07.02	3Year
Horn Antenna	BBHA 9120D	9120D-631	RS	2021.07.02	3Year
Amplifier	8449B	3008A00160	HP/Agilent	2021.06.18	1Year

2.3 Auxiliary Equipment

Device	Manufacturer	Model	Rating
--	--	--	--
--	--	--	--

"The report refers only to the sample tested and does not apply to the bulk production.
This report is issued in confidential to the client and it will be strictly treated as such by the SHENZHEN TIMEWAY TESTING LABORATORIES. It may not be reproduced rather in its entirety or in part and it may not be used for illegal purpose. The client to whom the report is issued may, however, show or send it, or a certified copy thereof prepared by the SHENZHEN TIMEWAY TESTING LABORATORIES to his customer, Supplier or other persons directly concerned. SHENZHEN TIMEWAY TESTING LABORATORIES will not, without the consent of the client enter into any discussion of correspondence with any third party concerning the contents of the report.
In the event of the improper use of the report, the SHENZHEN TIMEWAY TESTING LABORATORIES reserves the rights to withdraw it and to adopt any other remedies which may be appropriate."



3.0 Technical Details

3.1 Investigations Requested

Perform Electromagnetic Interference [EMI] tests for FCC Requirement.

3.2 Test Standards

FCC Part 15 Subpart B

"The report refers only to the sample tested and does not apply to the bulk production.
This report is issued in confidential to the client and it will be strictly treated as such by the SHENZHEN TIMEWAY TESTING LABORATORIES. It may not be reproduced rather in its entirety or in part and it may not be used for illegal purpose. The client to whom the report is issued may, however, show or send it, or a certified copy thereof prepared by the SHENZHEN TIMEWAY TESTING LABORATORIES to his customer, Supplier or others persons directly concerned. SHENZHEN TIMEWAY TESTING LABORATORIES will not, without the consent of the client enter into any discussion of correspondence with any third party concerning the contents of the report.
In the event of the improper use of the report, The SHENZHEN TIMEWAY TESTING LABORATORIES reserves the rights to withdraw it and to adopt any other remedies which may be appropriate."



4.0 Conducted Power line Test

4.1 Schematics of the test

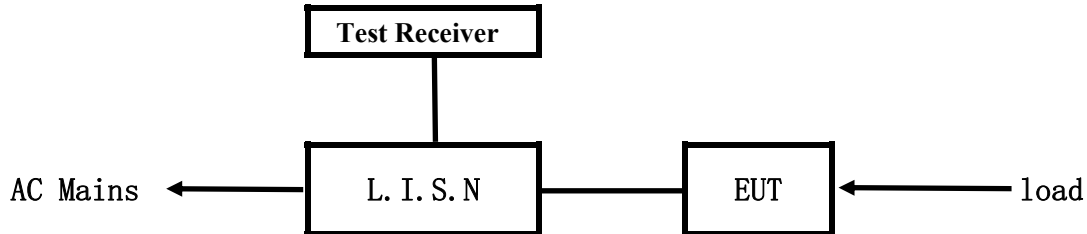

EUT: Equipment Under Test

4.2 Test Method and test Procedure

The EUT was tested according to ANSI C63.4-2014. The Frequency spectrum From 0.15MHz to 30MHz was investigated. The LISN used was 50ohm/50uH as specified by section 5.1 of ANSI C63.4-2014. Cables and peripherals were moved to find the maximum emission levels for each frequency.

Test Voltage: 120V~, 60Hz

Block diagram of Test setup

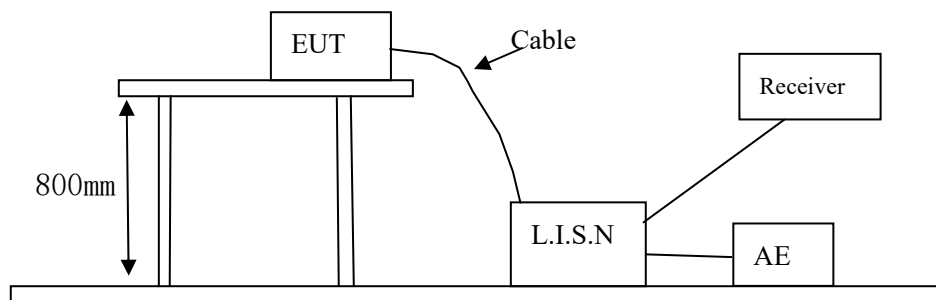

4.3 Power line conducted Emission Limit

Frequency (MHz)	Class A Limits dB(μV)		Class B Limits dB(μV)	
	Quasi-peak Level	Average Level	Quasi-peak Level	Average Level
0.15 ~ 0.50	79.00	66.00	66.00~56.00*	56.00~46.00*
0.50 ~ 5.00	73.00	60.00	56.00	46.00
5.00 ~ 0.00	73.00	60.00	60.00	50.00

- Notes:
- *decreasing linearly with logarithm of frequency.
 - The tighter limit shall apply at the transition frequencies

4.4 Test Results

The frequency spectrum from 0.15MHz to 30MHz was investigated. All reading are quasi-peak values with a resolution bandwidth of 9kHz.

Note: for this report, only receiving mode was tested.

"The report refers only to the sample tested and does not apply to the bulk production. This report is issued in confidential to the client and it will be strictly treated as such by the SHENZHEN TIMEWAY TESTING LABORATORIES. It may not be reproduced rather in its entirety or in part and it may not be used for illegal purpose. The client to whom the report is issued may, however, show or send it, or a certified copy thereof prepared by the SHENZHEN TIMEWAY TESTING LABORATORIES to his customer. Supplier or others persons directly concerned. SHENZHEN TIMEWAY TESTING LABORATORIES will not, without the consent of the client enter into any discussion of correspondence with any third party concerning the contents of the report. In the event of the improper use of the report. The SHENZHEN TIMEWAY TESTING LABORATORIES reserves the rights to withdraw it and to adopt any other remedies which may be appropriate."



A: Conducted Emission on Live Terminal (150kHz to 30MHz)

EUT Operating Environment

Temperature: 25°C Humidity: 75%RH Atmospheric Pressure: 101 kPa

EUT set Condition: Receiving Mode

Results: Pass

Please refer to following diagram for individual

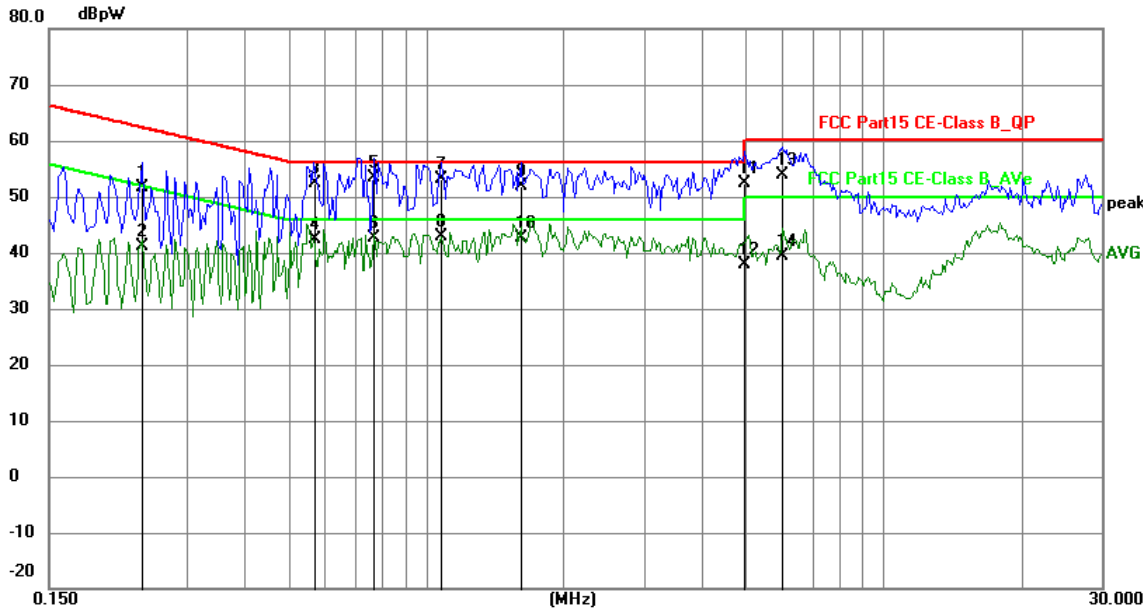

No.	Frequency (MHz)	Reading (dBpW)	Factor (dB)	Level (dBuV)	Limit (dBuV)	Margin (dB)	Detector	P/F
1	0.2397	41.78	9.75	51.53	62.11	-10.58	QP	P
2	0.2397	31.44	9.75	41.19	52.11	-10.92	AVG	P
3	0.5673	42.62	9.77	52.39	56.00	-3.61	QP	P
4	0.5673	32.64	9.77	42.41	46.00	-3.59	AVG	P
5	0.7700	43.48	9.78	53.26	56.00	-2.74	QP	P
6	0.7700	32.88	9.78	42.66	46.00	-3.34	AVG	P
7	1.0821	43.32	9.79	53.11	56.00	-2.89	QP	P
8	1.0821	33.09	9.79	42.88	46.00	-3.12	AVG	P
9	1.6125	42.11	9.80	51.91	56.00	-4.09	QP	P
10	1.6125	32.91	9.80	42.71	46.00	-3.29	AVG	P
11	4.9734	42.33	9.93	52.26	56.00	-3.74	QP	P
12	4.9734	27.86	9.93	37.79	46.00	-8.21	AVG	P
13	6.0225	43.79	9.97	53.76	60.00	-6.24	QP	P
14	6.0225	29.41	9.97	39.38	50.00	-10.62	AVG	P

"The report refers only to the sample tested and does not apply to the bulk production. This report is issued in confidential to the client and it will be strictly treated as such by the SHENZHEN TIMEWAY TESTING LABORATORIES. It may not be reproduced rather in its entirety or in part and it may not be used for illegal purpose. The client to whom the report is issued may, however, show or send it, or a certified copy thereof prepared by the SHENZHEN TIMEWAY TESTING LABORATORIES to his customer. Supplier or others persons directly concerned. SHENZHEN TIMEWAY TESTING LABORATORIES will not, without the consent of the client enter into any discussion of correspondence with any third party concerning the contents of the report. In the event of the improper use of the report. The SHENZHEN TIMEWAY TESTING LABORATORIES reserves the rights to withdraw it and to adopt any other remedies which may be appropriate."



B: Conducted Emission on Neutral Terminal (150kHz to 30MHz)

EUT Operating Environment

Temperature: 25°C Humidity:75%RH Atmospheric Pressure: 101 kPa

EUT set Condition: Receiving Mode

Results: Pass

Please refer to following diagram for individual

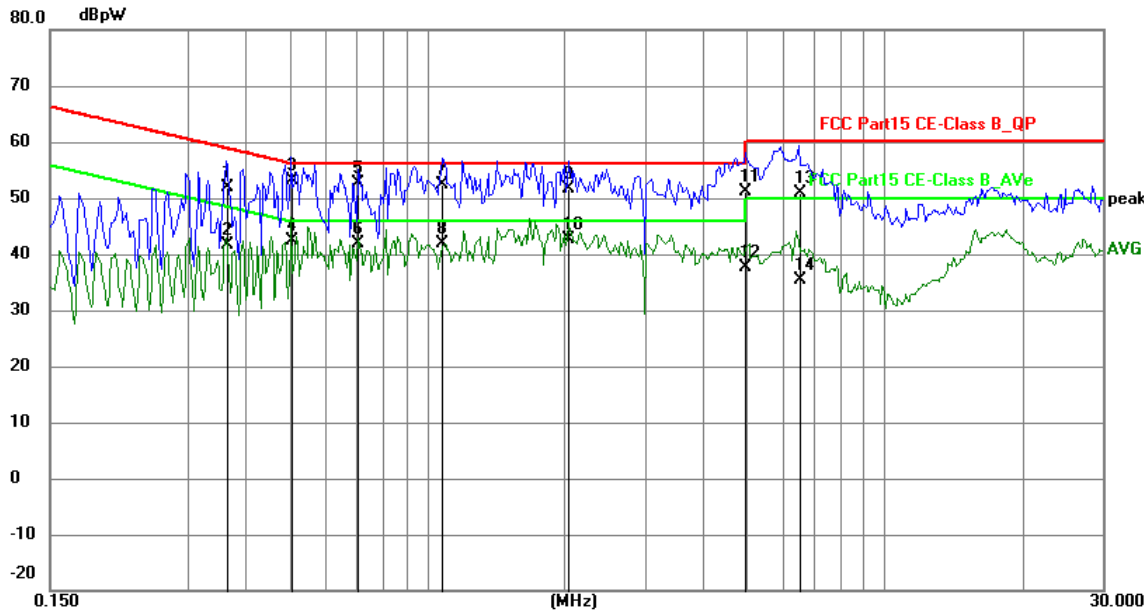

No.	Frequency (MHz)	Reading (dBpW)	Factor (dB)	Level (dBUV)	Limit (dBUV)	Margin (dB)	Detector	P/F
1	0.3645	42.10	9.76	51.86	58.63	-6.77	QP	P
2	0.3645	31.83	9.76	41.59	48.63	-7.04	AVG	P
3	0.5049	43.25	9.77	53.02	56.00	-2.98	QP	P
4	0.5049	32.68	9.77	42.45	46.00	-3.55	AVG	P
5	0.7077	42.76	9.78	52.54	56.00	-3.46	QP	P
6	0.7077	32.18	9.78	41.96	46.00	-4.04	AVG	P
7	1.0821	42.71	9.79	52.50	56.00	-3.50	QP	P
8	1.0821	32.08	9.79	41.87	46.00	-4.13	AVG	P
9	2.0337	41.72	9.80	51.52	56.00	-4.48	QP	P
10	2.0337	32.84	9.80	42.64	46.00	-3.36	AVG	P
11	4.9578	41.18	9.93	51.11	56.00	-4.89	QP	P
12	4.9578	27.77	9.93	37.70	46.00	-8.30	AVG	P
13	6.5178	40.89	9.99	50.88	60.00	-9.12	QP	P
14	6.5178	25.42	9.99	35.41	50.00	-14.59	AVG	P

"The report refers only to the sample tested and does not apply to the bulk production. This report is issued in confidential to the client and it will be strictly treated as such by the SHENZHEN TIMEWAY TESTING LABORATORIES. It may not be reproduced rather in its entirety or in part and it may not be used for illegal purpose. The client to whom the report is issued may, however, show or send it, or a certified copy thereof prepared by the SHENZHEN TIMEWAY TESTING LABORATORIES to his customer. Supplier or others persons directly concerned. SHENZHEN TIMEWAY TESTING LABORATORIES will not, without the consent of the client enter into any discussion of correspondence with any third party concerning the contents of the report. In the event of the improper use of the report. The SHENZHEN TIMEWAY TESTING LABORATORIES reserves the rights to withdraw it and to adopt any other remedies which may be appropriate."



5.0 Radiated Disturbance Test

5.1 Schematics of the test

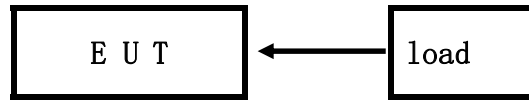

5.2 Test Method and test Procedure:

The EUT was tested according to ANSI C63.4 –2014; The frequency spectrum from 30MHz to 6GHz was investigated. All reading from 30MHz to 1GHz are quasi-peak values with a resolution bandwidth of 120kHz. For measurement above 1GHz, peak values with RBW=VBW=1MHz and PK detector. AV value with RBW=1MHz, VBW=10Hz and PK

Actual Working Voltage and Frequency: 120V~, 60Hz

Block diagram of Test setup

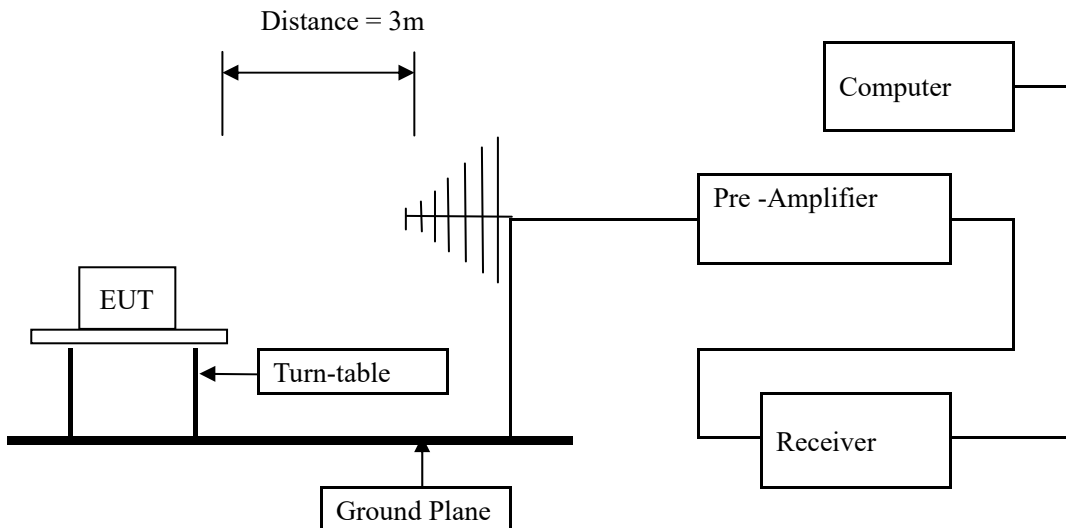

"The report refers only to the sample tested and does not apply to the bulk production.
This report is issued in confidential to the client and it will be strictly treated as such by the SHENZHEN TIMEWAY TESTING LABORATORIES. It may not be reproduced rather in its entirety or in part and it may not be used for illegal purpose. The client to whom the report is issued may, however, show or send it, or a certified copy thereof prepared by the SHENZHEN TIMEWAY TESTING LABORATORIES to his customer, Supplier or others persons directly concerned. SHENZHEN TIMEWAY TESTING LABORATORIES will not, without the consent of the client enter into any discussion of correspondence with any third party concerning the contents of the report.
In the event of the improper use of the report. The SHENZHEN TIMEWAY TESTING LABORATORIES reserves the rights to withdraw it and to adopt any other remedies which may be appropriate."

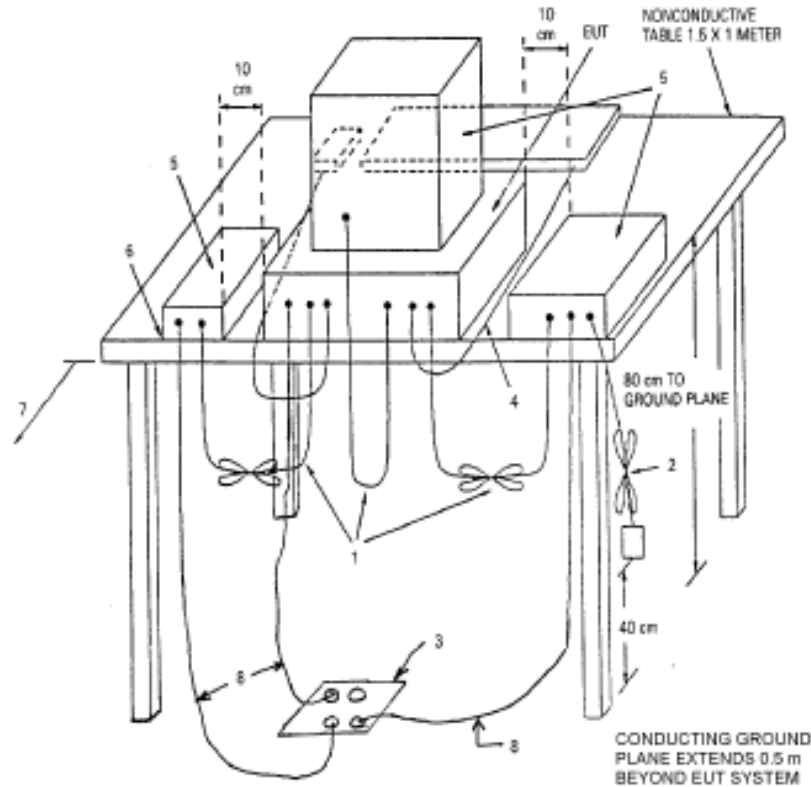

5.3 Radiated Emission Limit

Frequency Range (MHz)	Distance (m)	Field strength (dB μ V/m)
30-88	3	40.00
88-216	3	43.50
216-960	3	46.00
Above 960	3	54.00

Note: The lower limit shall apply at the transition frequencies

5.4 Test result

The frequency spectrum from 30MHz to 6GHz was investigated. All reading from 30MHz to 1GHz are quasi-peak values with a resolution bandwidth of 120kHz. For measurement above 1GHz, peak values with RBW=VBW=1MHz and PK detector. AV value with RBW=1MHz, VBW=10Hz and PK. Measurements were made at 3 meters.

"The report refers only to the sample tested and does not apply to the bulk production. This report is issued in confidential to the client and it will be strictly treated as such by the SHENZHEN TIMEWAY TESTING LABORATORIES. It may not be reproduced rather in its entirety or in part and it may not be used for illegal purpose. The client to whom the report is issued may, however, show or send it, or a certified copy thereof prepared by the SHENZHEN TIMEWAY TESTING LABORATORIES to his customer, Supplier or others persons directly concerned. SHENZHEN TIMEWAY TESTING LABORATORIES will not, without the consent of the client enter into any discussion of correspondence with any third party concerning the contents of the report. In the event of the improper use of the report. The SHENZHEN TIMEWAY TESTING LABORATORIES reserves the rights to withdraw it and to adopt any other remedies which may be appropriate."



A: Radiated Disturbance (30MHz----1000MHz)

Project Number:	CASE1	Test Time:	2021-08-25_13.11.32
EUT Name:	P250061	Test Engineer:	Wanli
Manufacturer:	Chienluen Industries (zhongshan) Ltd..	Test Standard:	FCC PART 15B
Model:	P250061	Work Addition:	Receiving
Temp.(°C):	25	Load:	
Hum.:	65%	Remark:	

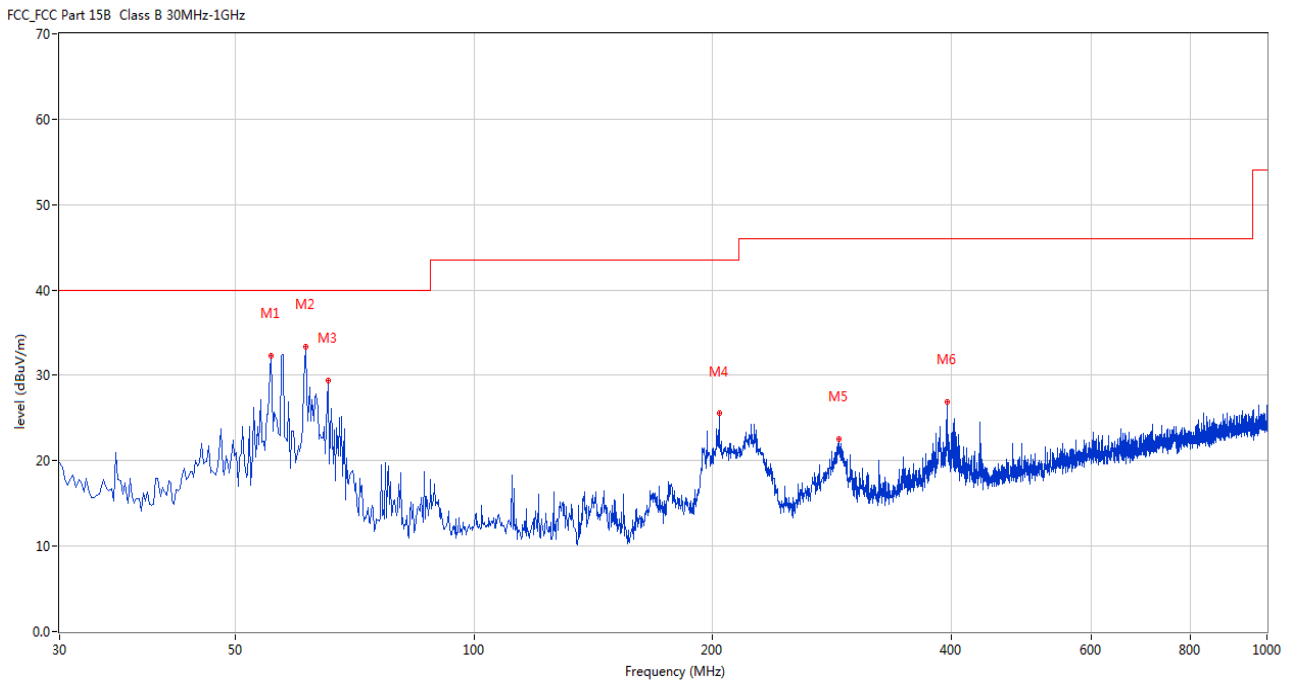

No.	Frequency (MHz)	Results (dBuV/m)	Factor (dB)	Limit (dBuV/m)	Over Limit (dB)	Detector	Table (o)	Height (cm)	ANT	Verdict
1	55.456	32.28	-11.89	40.0	-7.72	Peak	166.00	100	Horizontal	Pass
2	61.275	33.33	-13.14	40.0	-6.67	Peak	104.00	200	Horizontal	Pass
3	65.396	29.41	-13.71	40.0	-10.59	Peak	320.00	200	Horizontal	Pass
4	203.829	25.51	-13.50	43.5	-17.99	Peak	81.00	200	Horizontal	Pass
5	288.925	22.51	-11.24	46.0	-23.49	Peak	149.00	100	Horizontal	Pass
6	394.629	26.85	-8.81	46.0	-19.15	Peak	176.00	100	Horizontal	Pass

"The report refers only to the sample tested and does not apply to the bulk production. This report is issued in confidential to the client and it will be strictly treated as such by the SHENZHEN TIMEWAY TESTING LABORATORIES. It may not be reproduced rather in its entirety or in part and it may not be used for illegal purpose. The client to whom the report is issued may, however, show or send it, or a certified copy thereof prepared by the SHENZHEN TIMEWAY TESTING LABORATORIES to his customer. Supplier or others persons directly concerned. SHENZHEN TIMEWAY TESTING LABORATORIES will not, without the consent of the client enter into any discussion of correspondence with any third party concerning the contents of the report. In the event of the improper use of the report. The SHENZHEN TIMEWAY TESTING LABORATORIES reserves the rights to withdraw it and to adopt any other remedies which may be appropriate."



B: Radiated Disturbance (30MHz----1000MHz)

Project Number:	CASE1	Test Time:	2021-08-25_13.20.45
EUT Name:	P250061	Test Engineer:	Wanli
Manufacturer:	Chienluen Industries (zhongshan) Ltd..	Test Standard:	FCC PART 15B
Model:	P250061	Work Addition:	Receiving
Temp.(°C):	25	Load:	
Hum.:	65%	Remark:	

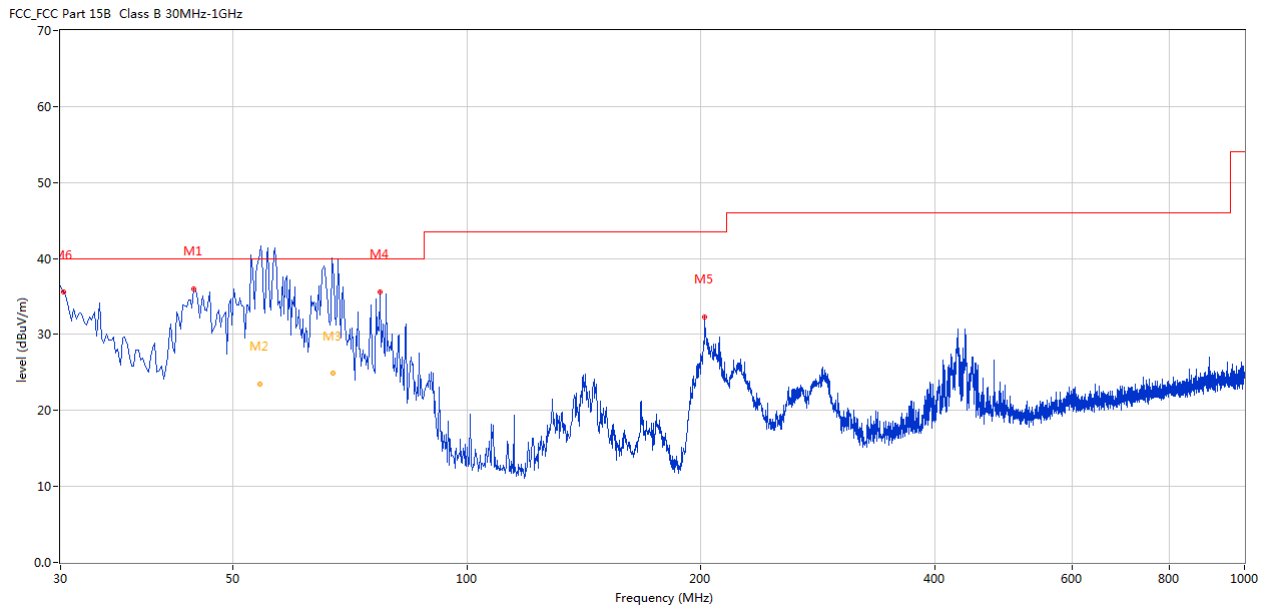

No.	Frequency (MHz)	Results (dBuV/m)	Factor (dB)	Limit (dBuV/m)	Over Limit (dB)	Detector	Table (o)	Height (cm)	ANT	Verdict
1	44.546	36.02	-11.44	40.0	-3.98	Peak	72.00	200	Vertical	Pass
2	54.150	42.45	-11.60	40.0	2.45	Peak	137.00	179	Vertical	N/A
2*	54.150	23.40	-11.60	40.0	-16.60	QP	137.00	179	Vertical	Pass
3	67.212	42.23	-14.32	40.0	2.23	Peak	288.00	124	Vertical	N/A
3*	67.212	24.98	-14.32	40.0	-15.02	QP	288.00	124	Vertical	Pass
4	77.276	35.61	-17.58	40.0	-4.39	Peak	0.00	200	Vertical	Pass
5	202.374	32.36	-13.39	43.5	-11.14	Peak	43.00	100	Vertical	Pass
6	30.242	35.53	-14.31	40.0	-4.47	Peak	271.00	100	Vertical	Pass

"The report refers only to the sample tested and does not apply to the bulk production. This report is issued in confidential to the client and it will be strictly treated as such by the SHENZHEN TIMEWAY TESTING LABORATORIES. It may not be reproduced rather in its entirety or in part and it may not be used for illegal purpose. The client to whom the report is issued may, however, show or send it, or a certified copy thereof prepared by the SHENZHEN TIMEWAY TESTING LABORATORIES to his customer. Supplier or others persons directly concerned. SHENZHEN TIMEWAY TESTING LABORATORIES will not, without the consent of the client enter into any discussion of correspondence with any third party concerning the contents of the report. In the event of the improper use of the report. The SHENZHEN TIMEWAY TESTING LABORATORIES reserves the rights to withdraw it and to adopt any other remedies which may be appropriate."



C: Radiated Disturbance (1000MHz----6000MHz)

EUT Operating Environment

Temperature: 25°C Humidity: 75%RH Atmospheric Pressure: 101 kPa

EUT set Condition: Receiving Mode

Equipment Level: Class B

Results: Pass

Please refer to following diagram for individual

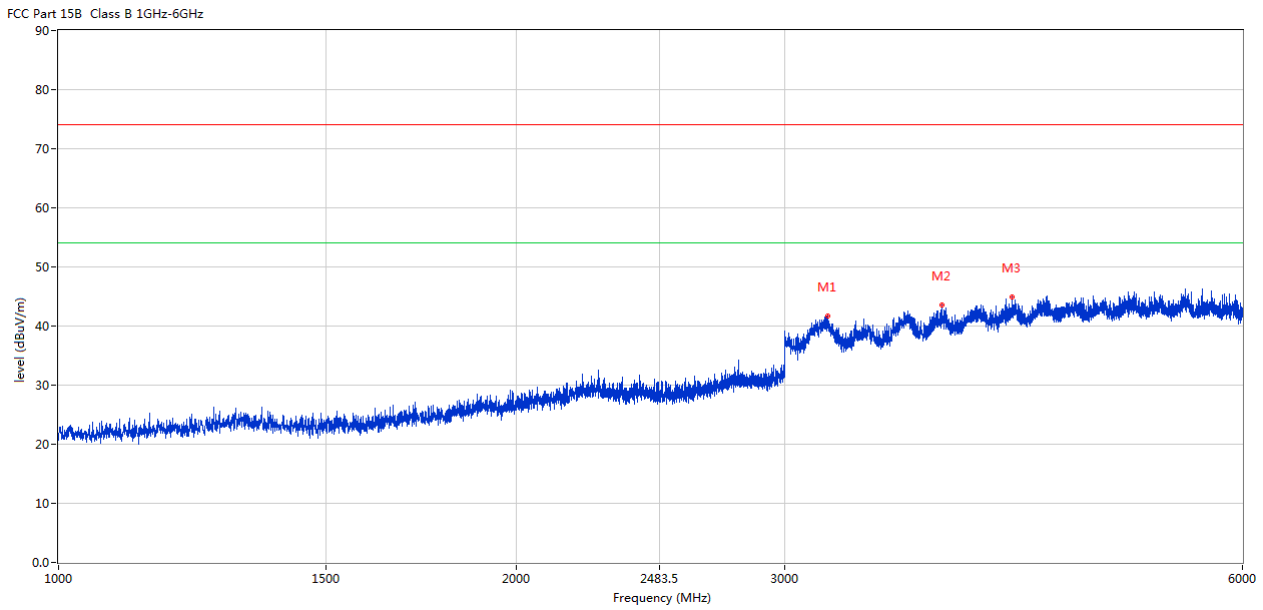

No	Frequency (MHz)	Results (dBuV/m)	Factor (dB)	Limit (dBuV/m)	Over Limit (dB)	Detector	Table (o)	Height (cm)	ANT	Verdict
1	3202.500	41.69	-1.97	74.0	-32.31	Peak	5.00	100	Horizontal	Pass
2	3808.500	43.53	0.35	74.0	-30.47	Peak	3.00	100	Horizontal	Pass
3	4234.500	44.87	1.68	74.0	-29.13	Peak	10.00	100	Horizontal	Pass

"The report refers only to the sample tested and does not apply to the bulk production.
 This report is issued in confidential to the client and it will be strictly treated as such by the SHENZHEN TIMEWAY TESTING LABORATORIES. It may not be reproduced rather in its entirety or in part and it may not be used for illegal purpose. The client to whom the report is issued may, however, show or send it . or a certified copy there of prepared by the SHENZHEN TIMEWAY TESTING LABORATORIES to his customer. Supplier or others persons directly concerned. SHENZHEN TIMEWAY TESTING LABORATORIES will not, without the consent of the client enter into any discussion of correspondence with any third party concerning the contents of the report.
 In the event of the improper use of the report. The SHENZHEN TIMEWAY TESTING LABORATORIES reserves the rights to withdraw it and to adopt any other remedies which may be appropriate."



D: Radiated Disturbance (1000MHz----6000MHz)

EUT Operating Environment

Temperature: 25°C Humidity: 75%RH Atmospheric Pressure: 101 kPa

EUT set Condition: Receiving Mode

Equipment Level: Class B

Results: Pass

Please refer to following diagram for individual

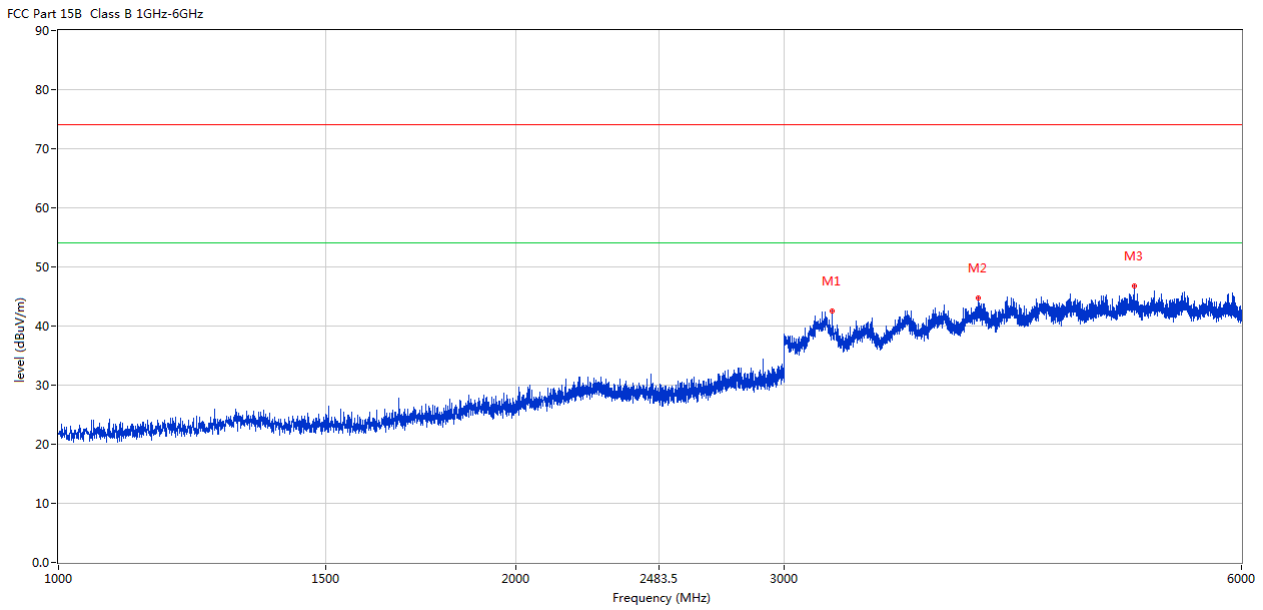

No	Frequency (MHz)	Results (dBuV/m)	Factor (dB)	Limit (dBuV/m)	Over Limit (dB)	Detector	Table (o)	Height (cm)	ANT	Verdict
1	3228.750	42.58	-2.01	74.0	-31.42	Peak	0.00	100	Vertical	Pass
2	4026.750	44.79	1.25	74.0	-29.21	Peak	0.00	100	Vertical	Pass
3	5103.000	46.83	3.81	74.0	-27.17	Peak	4.00	100	Vertical	Pass

"The report refers only to the sample tested and does not apply to the bulk production.
 This report is issued in confidential to the client and it will be strictly treated as such by the SHENZHEN TIMEWAY TESTING LABORATORIES. It may not be reproduced rather in its entirety or in part and it may not be used for illegal purpose. The client to whom the report is issued may, however, show or send it or a certified copy thereof prepared by the SHENZHEN TIMEWAY TESTING LABORATORIES to his customer, Supplier or others persons directly concerned. SHENZHEN TIMEWAY TESTING LABORATORIES will not, without the consent of the client enter into any discussion of correspondence with any third party concerning the contents of the report.
 In the event of the improper use of the report. The SHENZHEN TIMEWAY TESTING LABORATORIES reserves the rights to withdraw it and to adopt any other remedies which may be appropriate."



6.0 FCC Label

FCC ID: RGB-P250061D

This device complies with part 15 of the FCC rules. Operation is subject to the following two conditions (1) this device may not cause harmful interference, and (2) this device must accept any interference received, including interference that may cause undesired operation.

The label must not be a stick-on paper label. The label on these products must be permanently affixed to the product and readily visible at the time of purchase and must last the expected lifetime of the equipment not be readily detachable.



"The report refers only to the sample tested and does not apply to the bulk production. This report is issued in confidential to the client and it will be strictly treated as such by the SHENZHEN TIMEWAY TESTING LABORATORIES. It may not be reproduced rather in its entirety or in part and it may not be used for illegal purpose. The client to whom the report is issued may, however, show or send it . or a certified copy there of prepared by the SHENZHEN TIMEWAY TESTING LABORATORIES to his customer. Supplier or others persons directly concerned. SHENZHEN TIMEWAY TESTING LABORATORIES will not, without the consent of the client enter into any discussion of correspondence with any third party concerning the contents of the report. In the event of the improper use of the report. The SHENZHEN TIMEWAY TESTING LABORATORIES reserves the rights to withdraw it and to adopt any other remedies which may be appropriate."

7.0 Photo of testing

Conducted Emissions



"The report refers only to the sample tested and does not apply to the bulk production. This report is issued in confidential to the client and it will be strictly treated as such by the SHENZHEN TIMEWAY TESTING LABORATORIES. It may not be reproduced rather in its entirety or in part and it may not be used for illegal purpose. The client to whom the report is issued may, however, show or send it . or a certified copy there of prepared by the SHENZHEN TIMEWAY TESTING LABORATORIES to his customer. Supplier or others persons directly concerned. SHENZHEN TIMEWAY TESTING LABORATORIES will not, without the consent of the client enter into any discussion of correspondence with any third party concerning the contents of the report. In the event of the improper use of the report. The SHENZHEN TIMEWAY TESTING LABORATORIES reserves the rights to withdraw it and to adopt any other remedies which may be appropriate."



Radiated Emissions

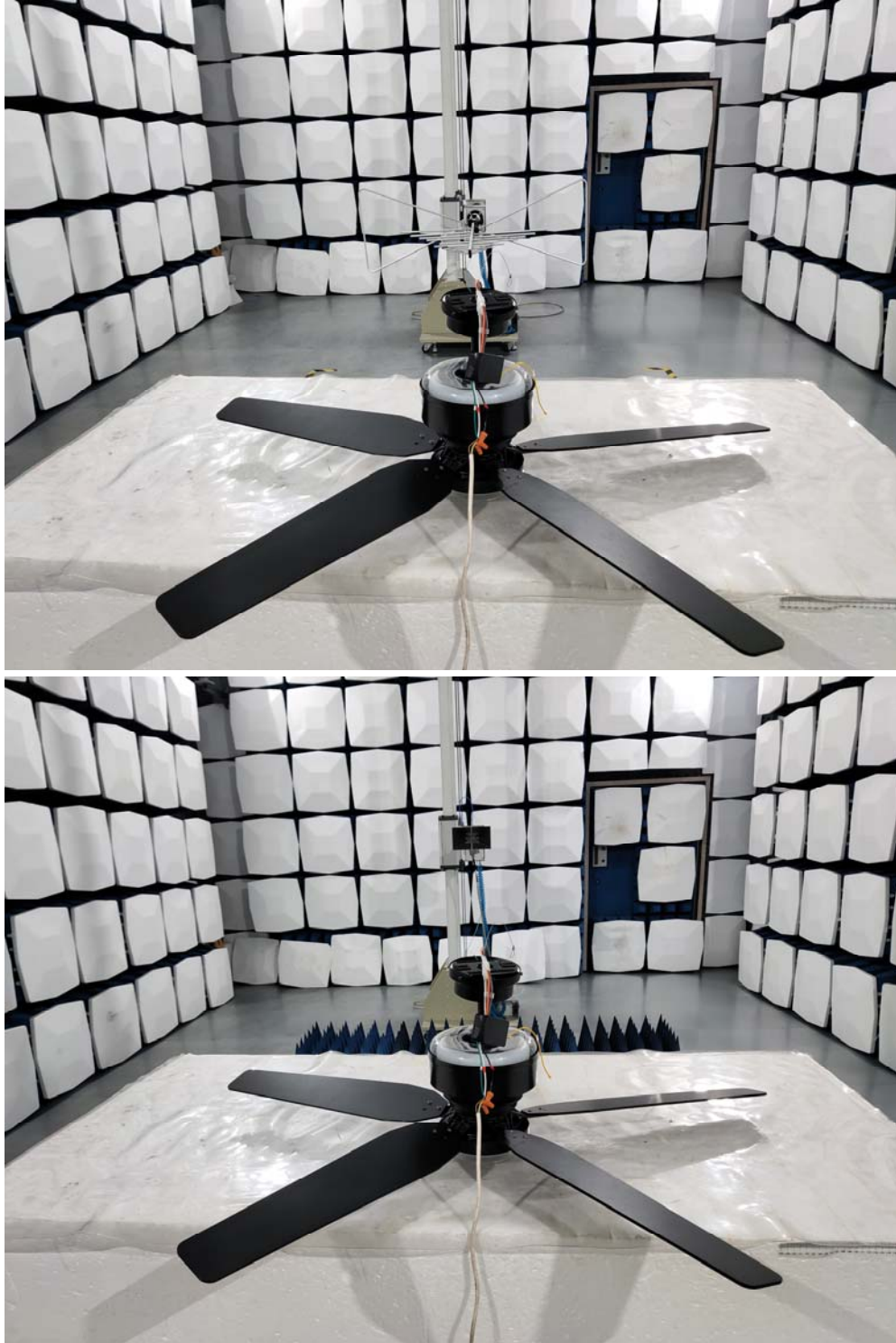

"The report refers only to the sample tested and does not apply to the bulk production. This report is issued in confidential to the client and it will be strictly treated as such by the SHENZHEN TIMEWAY TESTING LABORATORIES. It may not be reproduced rather in its entirety or in part and it may not be used for illegal purpose. The client to whom the report is issued may, however, show or send it , or a certified copy there of prepared by the SHENZHEN TIMEWAY TESTING LABORATORIES to his customer. Supplier or others persons directly concerned. SHENZHEN TIMEWAY TESTING LABORATORIES will not, without the consent of the client enter into any discussion of correspondence with any third party concerning the contents of the report. In the event of the improper use of the report. The SHENZHEN TIMEWAY TESTING LABORATORIES reserves the rights to withdraw it and to adopt any other remedies which may be appropriate."

Photographs – EUT



"The report refers only to the sample tested and does not apply to the bulk production. This report is issued in confidential to the client and it will be strictly treated as such by the SHENZHEN TIMEWAY TESTING LABORATORIES. It may not be reproduced rather in its entirety or in part and it may not be used for illegal purpose. The client to whom the report is issued may, however, show or send it . or a certified copy there of prepared by the SHENZHEN TIMEWAY TESTING LABORATORIES to his customer. Supplier or others persons directly concerned. SHENZHEN TIMEWAY TESTING LABORATORIES will not, without the consent of the client enter into any discussion of correspondence with any third party concerning the contents of the report. In the event of the improper use of the report. The SHENZHEN TIMEWAY TESTING LABORATORIES reserves the rights to withdraw it and to adopt any other remedies which may be appropriate."



Photographs – EUT



"The report refers only to the sample tested and does not apply to the bulk production. This report is issued in confidential to the client and it will be strictly treated as such by the SHENZHEN TIMEWAY TESTING LABORATORIES. It may not be reproduced rather in its entirety or in part and it may not be used for illegal purpose. The client to whom the report is issued may, however, show or send it . or a certified copy there of prepared by the SHENZHEN TIMEWAY TESTING LABORATORIES to his customer. Supplier or others persons directly concerned. SHENZHEN TIMEWAY TESTING LABORATORIES will not, without the consent of the client enter into any discussion of correspondence with any third party concerning the contents of the report. In the event of the improper use of the report. The SHENZHEN TIMEWAY TESTING LABORATORIES reserves the rights to withdraw it and to adopt any other remedies which may be appropriate."

Photographs – EUT

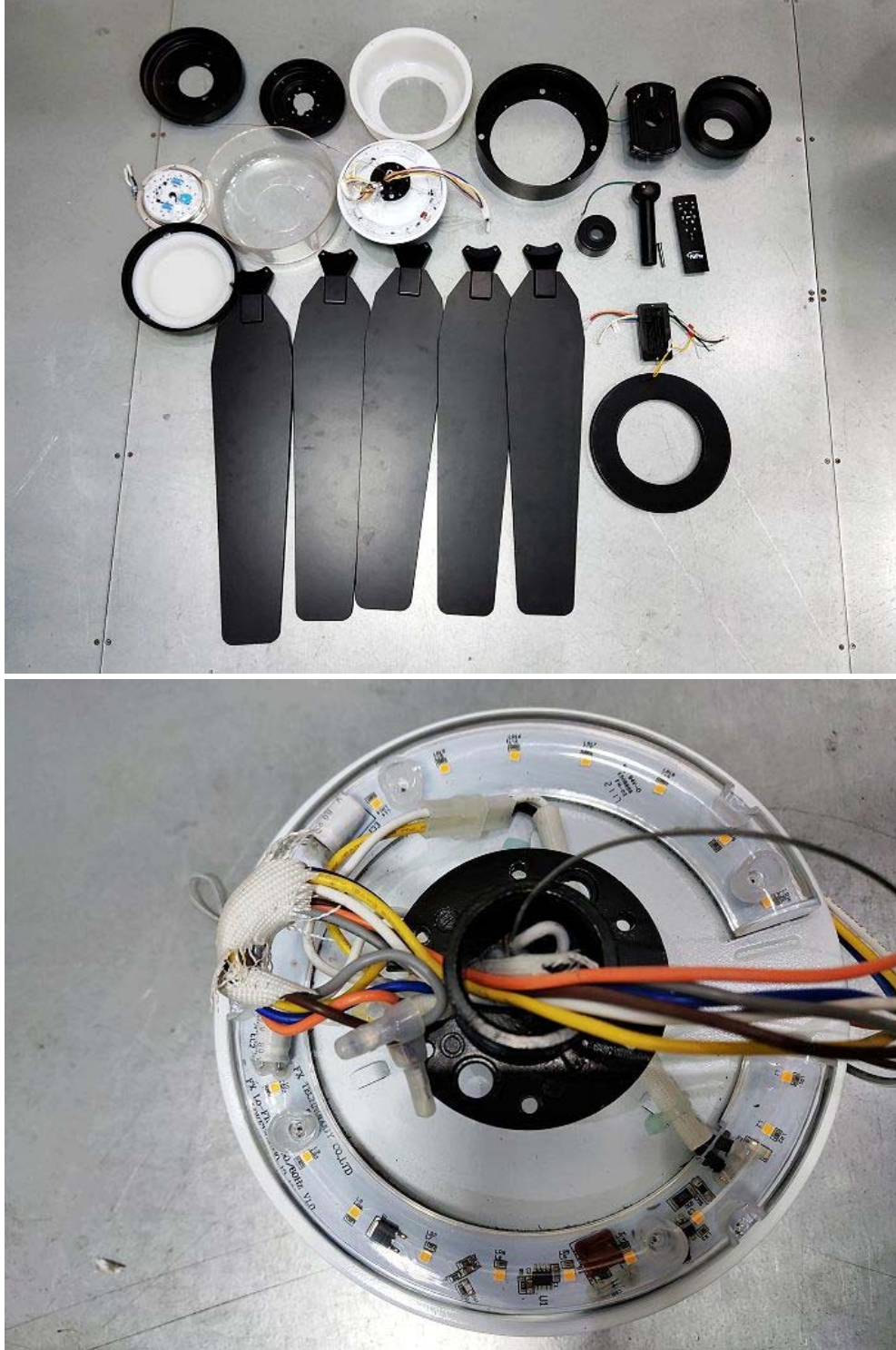

"The report refers only to the sample tested and does not apply to the bulk production. This report is issued in confidential to the client and it will be strictly treated as such by the SHENZHEN TIMEWAY TESTING LABORATORIES. It may not be reproduced rather in its entirety or in part and it may not be used for illegal purpose. The client to whom the report is issued may, however, show or send it . or a certified copy there of prepared by the SHENZHEN TIMEWAY TESTING LABORATORIES to his customer. Supplier or others persons directly concerned. SHENZHEN TIMEWAY TESTING LABORATORIES will not, without the consent of the client enter into any discussion of correspondence with any third party concerning the contents of the report. In the event of the improper use of the report. The SHENZHEN TIMEWAY TESTING LABORATORIES reserves the rights to withdraw it and to adopt any other remedies which may be appropriate."

Photographs – EUT

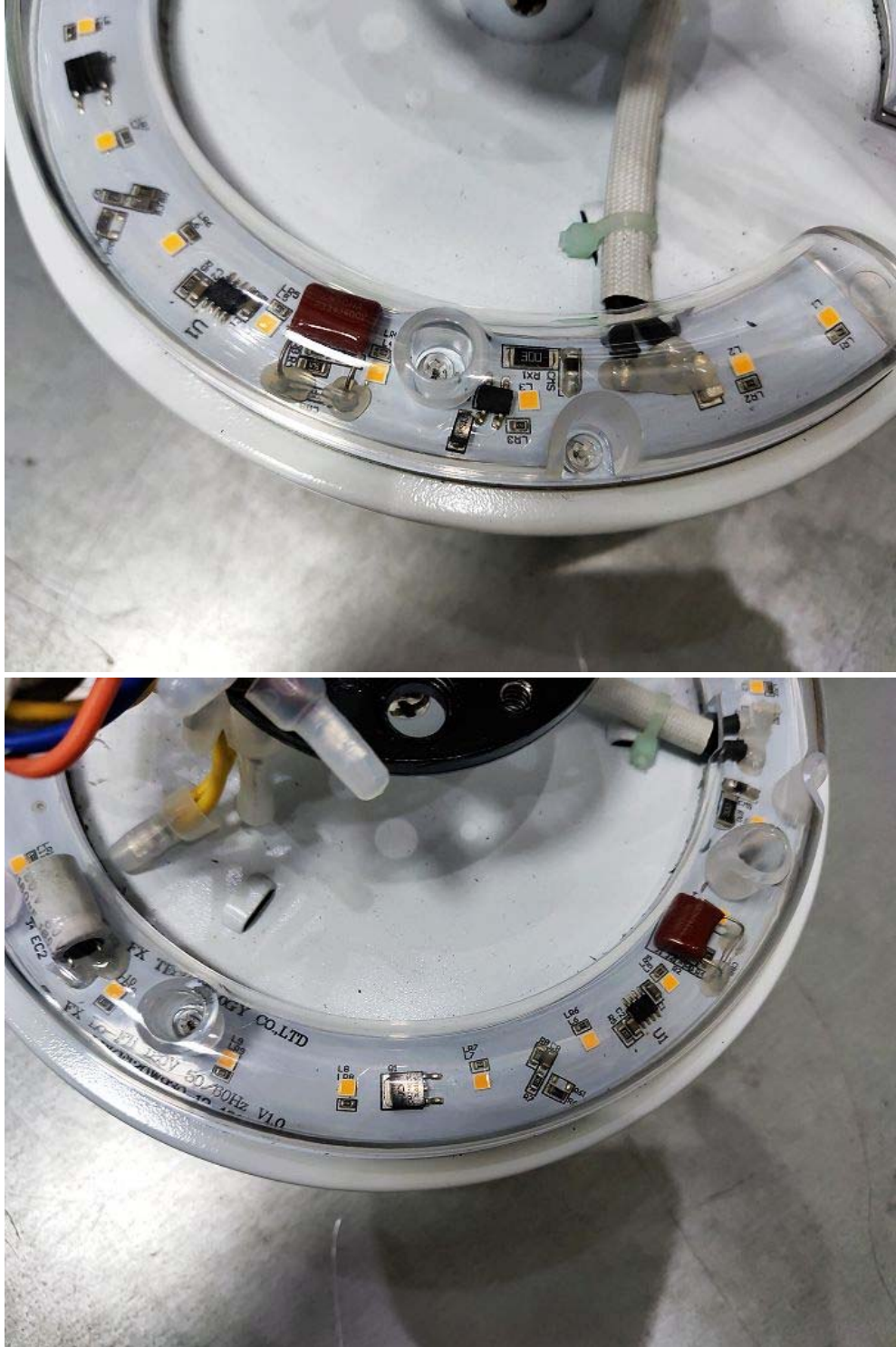

"The report refers only to the sample tested and does not apply to the bulk production. This report is issued in confidential to the client and it will be strictly treated as such by the SHENZHEN TIMEWAY TESTING LABORATORIES. It may not be reproduced rather in its entirety or in part and it may not be used for illegal purpose. The client to whom the report is issued may, however, show or send it, or a certified copy thereof prepared by the SHENZHEN TIMEWAY TESTING LABORATORIES to his customer, Supplier or others persons directly concerned. SHENZHEN TIMEWAY TESTING LABORATORIES will not, without the consent of the client enter into any discussion of correspondence with any third party concerning the contents of the report. In the event of the improper use of the report. The SHENZHEN TIMEWAY TESTING LABORATORIES reserves the rights to withdraw it and to adopt any other remedies which may be appropriate."

Photographs – EUT



"The report refers only to the sample tested and does not apply to the bulk production. This report is issued in confidential to the client and it will be strictly treated as such by the SHENZHEN TIMEWAY TESTING LABORATORIES. It may not be reproduced rather in its entirety or in part and it may not be used for illegal purpose. The client to whom the report is issued may, however, show or send it, or a certified copy thereof prepared by the SHENZHEN TIMEWAY TESTING LABORATORIES to his customer, Supplier or other persons directly concerned. SHENZHEN TIMEWAY TESTING LABORATORIES will not, without the consent of the client enter into any discussion of correspondence with any third party concerning the contents of the report. In the event of the improper use of the report, The SHENZHEN TIMEWAY TESTING LABORATORIES reserves the rights to withdraw it and to adopt any other remedies which may be appropriate."

Photographs – EUT

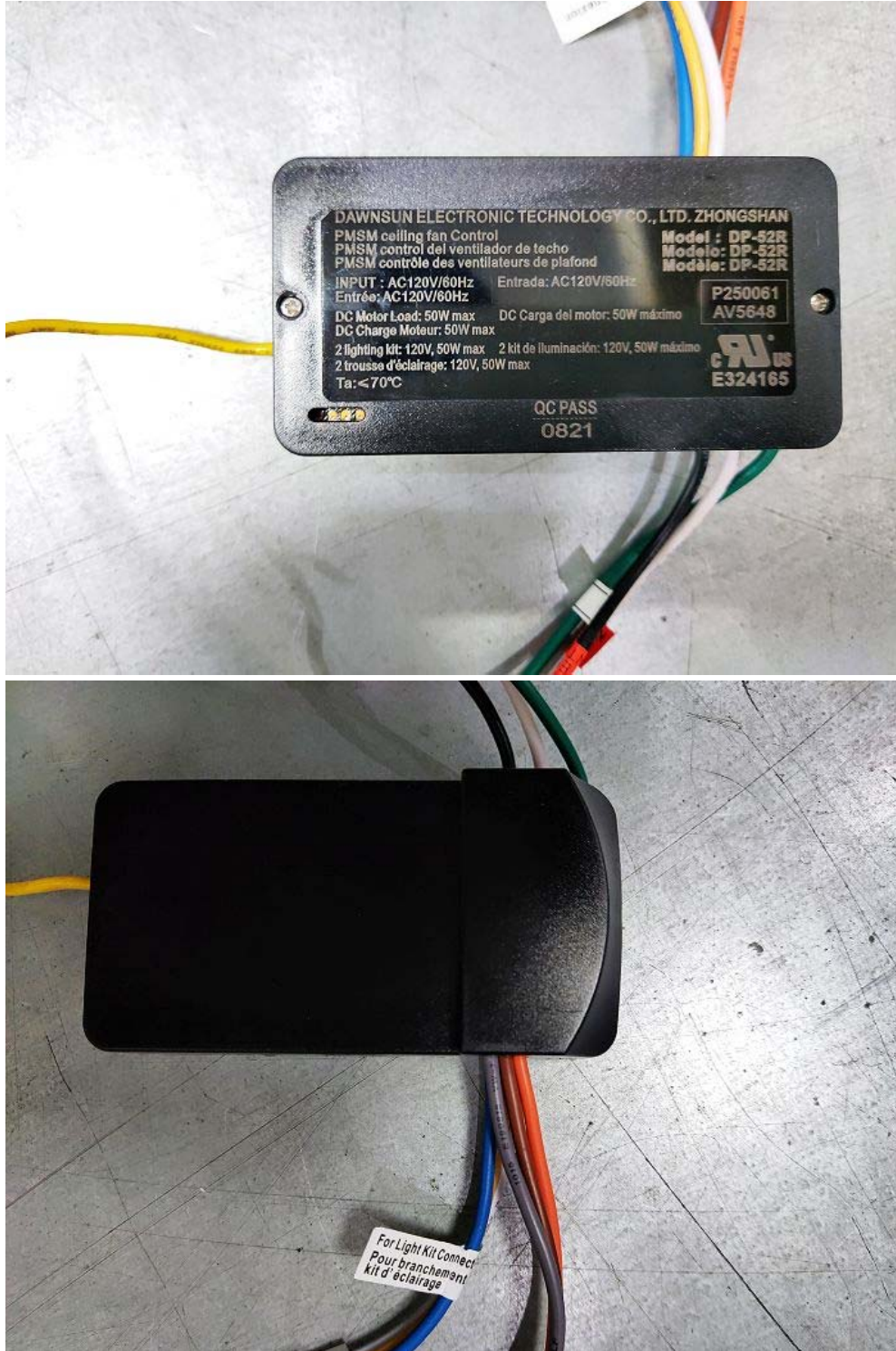

"The report refers only to the sample tested and does not apply to the bulk production. This report is issued in confidential to the client and it will be strictly treated as such by the SHENZHEN TIMEWAY TESTING LABORATORIES. It may not be reproduced rather in its entirety or in part and it may not be used for illegal purpose. The client to whom the report is issued may, however, show or send it , or a certified copy there of prepared by the SHENZHEN TIMEWAY TESTING LABORATORIES to his customer. Supplier or others persons directly concerned. SHENZHEN TIMEWAY TESTING LABORATORIES will not, without the consent of the client enter into any discussion of correspondence with any third party concerning the contents of the report. In the event of the improper use of the report. The SHENZHEN TIMEWAY TESTING LABORATORIES reserves the rights to withdraw it and to adopt any other remedies which may be appropriate."

Photographs – EUT

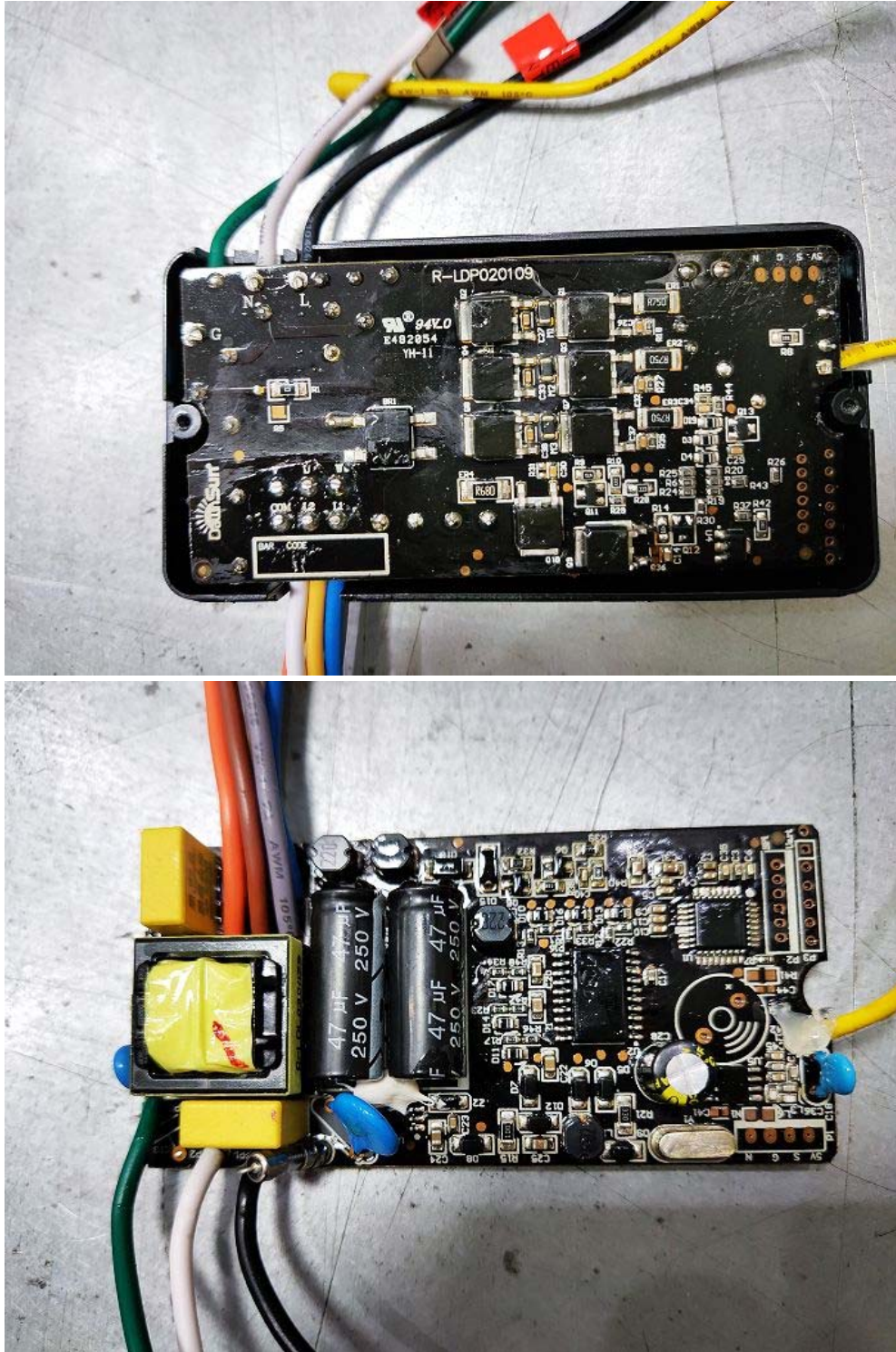

"The report refers only to the sample tested and does not apply to the bulk production. This report is issued in confidential to the client and it will be strictly treated as such by the SHENZHEN TIMEWAY TESTING LABORATORIES. It may not be reproduced rather in its entirety or in part and it may not be used for illegal purpose. The client to whom the report is issued may, however, show or send it, or a certified copy thereof prepared by the SHENZHEN TIMEWAY TESTING LABORATORIES to his customer, Supplier or other persons directly concerned. SHENZHEN TIMEWAY TESTING LABORATORIES will not, without the consent of the client enter into any discussion of correspondence with any third party concerning the contents of the report. In the event of the improper use of the report, The SHENZHEN TIMEWAY TESTING LABORATORIES reserves the rights to withdraw it and to adopt any other remedies which may be appropriate."



Photographs – EUT

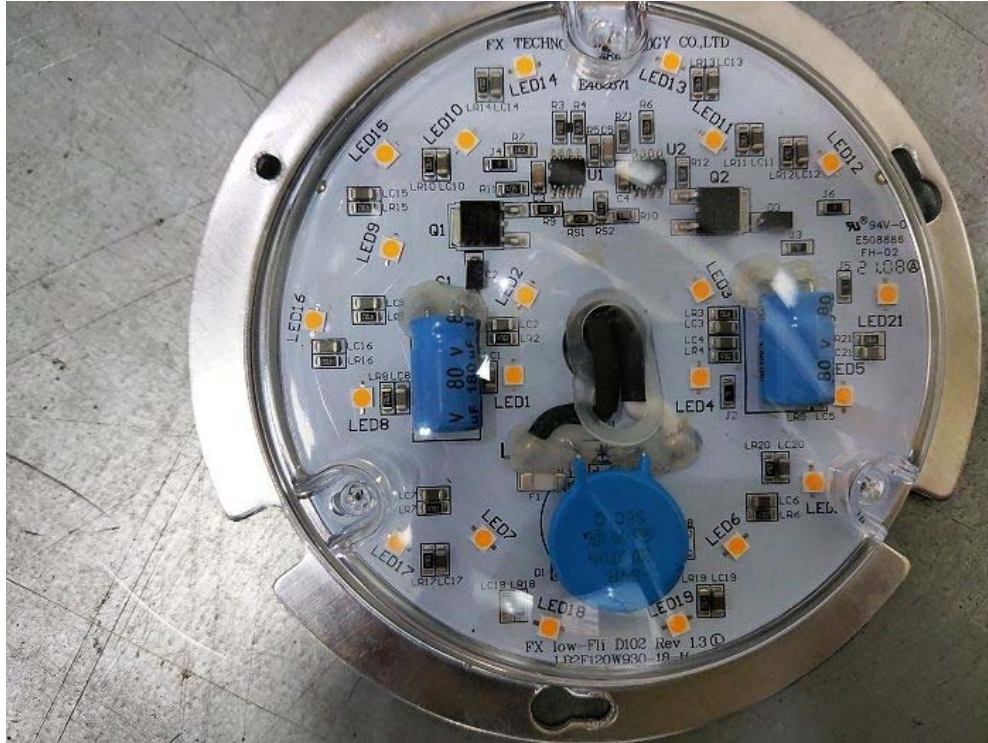

End of The Report

"The report refers only to the sample tested and does not apply to the bulk production. This report is issued in confidential to the client and it will be strictly treated as such by the SHENZHEN TIMEWAY TESTING LABORATORIES. It may not be reproduced rather in its entirety or in part and it may not be used for illegal purpose. The client to whom the report is issued may, however, show or send it . or a certified copy there of prepared by the SHENZHEN TIMEWAY TESTING LABORATORIES to his customer. Supplier or others persons directly concerned. SHENZHEN TIMEWAY TESTING LABORATORIES will not, without the consent of the client enter into any discussion of correspondence with any third party concerning the contents of the report. In the event of the improper use of the report. The SHENZHEN TIMEWAY TESTING LABORATORIES reserves the rights to withdraw it and to adopt any other remedies which may be appropriate."