

FCC TEST REPORT

Product Name: 70" Ajax
Trade Mark: Home Decorators Collection
Model No.: 70-Ajax
Report Number: 171208001EMC-1
Test Standards: FCC 47 CFR Part 15 Subpart B
FCC ID: RGB-70AJAXD
Test Result: PASS
Date of Issue: December 15, 2017

Prepared for:

King of Fans, Inc.
1951 N.W. 22nd Street, Fort Lauderdale, FL33311, USA

Prepared by:

Shenzhen UnionTrust Quality and Technology Co., Ltd.
16/F, Block A, Building 6, Baoneng Science and Technology Park,
Qingxiang Road No.1, Longhua New District, Shenzhen, China
TEL: +86-755-2823 0888
FAX: +86-755-2823 0886

Tested by: Eric Yu
 Eric Yu
 Engineer

Reviewed by: Kevin Liang
 Kevin Liang
 Senior Engineer

Approved by: Jim Long
 Jim Long
 Technical Deputy Manager

Date: December 15, 2017



A circular blue stamp with the text "UnionTrust Laboratories" around the top edge, "UnionTrust" in the center, and "December 15, 2017" below it. At the bottom of the stamp, it says "* Certified *".

Shenzhen UnionTrust Quality and Technology Co., Ltd.

Version

Version No.	Date	Description
V1.0	December 15, 2017	Original



CONTENTS

1. GENERAL INFORMATION	4
1.1 CLIENT INFORMATION	4
1.2 EUT INFORMATION	4
1.2.1 GENERAL DESCRIPTION OF EUT	4
1.2.2 DESCRIPTION OF ACCESSORIES	4
1.3 DESCRIPTION OF SUPPORT UNITS	4
1.4 TEST LOCATION	4
1.5 TEST FACILITY	4
1.6 DEVIATION FROM STANDARDS	5
1.7 ABNORMALITIES FROM STANDARD CONDITIONS	5
1.8 OTHER INFORMATION REQUESTED BY THE CUSTOMER	5
1.9 MEASUREMENT UNCERTAINTY	5
2. TEST SUMMARY	6
3. EQUIPMENT LIST	7
4. TEST CONFIGURATION	8
4.1 ENVIRONMENTAL CONDITIONS FOR TESTING	8
4.1.1 NORMAL OR EXTREME TEST CONDITIONS	8
4.1.2 RECORD OF NORMAL ENVIRONMENT	8
4.2 TEST MODES	8
4.3 TEST SETUP	8
4.3.1 FOR RADIATED EMISSIONS TEST SETUP	8
4.3.2 FOR CONDUCTED EMISSIONS TEST SETUP	9
4.4 SYSTEM TEST CONFIGURATION	9
5. REFERENCE DOCUMENTS FOR TESTING	10
6. EMC REQUIREMENTS SPECIFICATION	10
6.1 RADIATED EMISSION	10
6.2 CONDUCTED EMISSION	15
APPENDIX 1 PHOTOGRAPHS OF TEST SETUP	18
APPENDIX 2 PHOTOGRAPHS OF EUT CONSTRUCTIONAL DETAILS	21
EUT EXTERNAL PHOTOS	21
EUT INTERNAL PHOTOS	21

1. GENERAL INFORMATION

1.1 CLIENT INFORMATION

Applicant:	King of Fans, Inc.
Address of Applicant:	1951 N.W. 22nd Street, Fort Lauderdale, FL33311, USA
Manufacturer:	Chienluen Industries (zhongshan) Ltd.
Address of Manufacturer:	Da Che Industrial Area, Nanlang Town, Zhongshan, Guangdong China 528451

1.2 EUT INFORMATION

1.2.1 General Description of EUT

Product Name:	70" Ajax
Model No.:	70-Ajax
Trade Mark:	Home Decorators Collection
DUT Stage:	Identical Prototype
Power Supply:	AC 120V/60Hz
Classification of digital devices:	Class B
Receiver Frequency:	304 MHz
Software Version:	N/A
Hardware Version:	N/A
Sample Received Date:	December 8, 2017
Sample Tested Date:	December 8, 2017 to December 14, 2017

1.2.2 Description of Accessories

None

1.3 DESCRIPTION OF SUPPORT UNITS

The EUT has been tested independently

1.4 TEST LOCATION

Shenzhen UnionTrust Quality and Technology Co., Ltd.

Address: 16/F, Block A, Building 6, Baoneng Science and Technology Park, Qingxiang Road No.1, Longhua New District, Shenzhen, China 518109
 Telephone: +86 (0) 755 2823 0888
 Fax: +86 (0) 755 2823 0886

1.5 TEST FACILITY

The test facility is recognized, certified, or accredited by the following organizations:

Shenzhen UnionTrust Quality and Technology Co., Ltd.

Address: 16/F, Block A, Building 6, Baoneng Science and Technology Park, Qingxiang Road No.1, Longhua New District, Shenzhen, China
 Tel: +86-755-28230888 Fax: +86-755-28230886 E-mail: info@uttlab.com

[Http://www.uttlab.com](http://www.uttlab.com)

CNAS-Lab Code: L9069

The measuring equipment utilized to perform the tests documented in this report has been calibrated once a year or in accordance with the manufacturer's recommendations, and is traceable under the ISO/IEC/EN 17025 to international or national standards. Equipment has been calibrated by accredited calibration laboratories.

IC-Registration No.: 21600-1

The 3m Semi-anechoic chamber of Shenzhen UnionTrust Quality and Technology Co., Ltd. has been registered by Certification and Engineering Bureau of Industry Canada for radio equipment testing with Registration No.: 21600-1.

A2LA-Lab Certificate No.: 4312.01

Shenzhen UnionTrust Quality and Technology Co., Ltd. has been accredited by A2LA for technical competence in the field of electrical testing, and proved to be in compliance with ISO/IEC 17025: 2005 General Requirements for the Competence of Testing and Calibration Laboratories and any additional program requirements in the identified field of testing.

FCC Accredited Lab.

Designation Number: CN1194
 Test Firm Registration Number: 259480

1.6 DEVIATION FROM STANDARDS

None.

1.7 ABNORMALITIES FROM STANDARD CONDITIONS

None.

1.8 OTHER INFORMATION REQUESTED BY THE CUSTOMER

None.

1.9 MEASUREMENT UNCERTAINTY

Where relevant, the following measurement uncertainty levels have been estimated for tests performed on the Product as specified in CISPR 16-4-2. This uncertainty represents an expanded uncertainty expressed at approximately the 95% confidence level using a coverage factor of k=2.

No.	Item	Measurement Uncertainty
1	Conducted emission 9KHz-150KHz	±3.8 dB
2	Conducted emission 150KHz-30MHz	±3.4 dB
3	Radiated emission 9KHz-30MHz	±4.9 dB
4	Radiated emission 30MHz-1GHz	±4.7 dB
5	Radiated emission 1GHz-18GHz	±5.1 dB
6	Radiated emission 18GHz-26GHz	±5.2 dB
7	Radiated emission 26GHz-40GHz	±5.2 dB

2. TEST SUMMARY

FCC 47 CFR Part 15 Subpart B Test Cases			
Test Item	Test Requirement	Test Method	Result
Conducted Emission	FCC 47 CFR Part 15.107	ANSI C63.4-2014	PASS
Radiated Emission	FCC 47 CFR Part 15.109	ANSI C63.4-2014	PASS



3. EQUIPMENT LIST

Radiated Emission Test Equipment List						
Used	Equipment	Manufacturer	Model No.	Serial Number	Cal. date (mm dd, yyyy)	Cal. Due date (mm dd, yyyy)
<input checked="" type="checkbox"/>	3M Chamber & Accessory Equipment	ETS-LINDGREN	3M	N/A	Dec. 20, 2015	Dec. 19, 2018
<input type="checkbox"/>	Receiver	R&S	ESR7	1316.3003K07-101181-K3	Dec. 22, 2016	Dec. 22, 2017
<input checked="" type="checkbox"/>	Receiver	R&S	ESIB26	100114	Dec. 22, 2016	Dec. 22, 2017
<input type="checkbox"/>	EXA Spectrum Analyzer	KEYSIGHT	N9010A	MY51440197	Dec. 22, 2016	Dec. 22, 2017
<input type="checkbox"/>	Loop Antenna	ETS-LINDGREN	6502	00202525	Jun. 24, 2015	Jun. 23, 2018
<input checked="" type="checkbox"/>	Broadband Antenna	ETS-LINDGREN	3142E	00201566	Jul. 24, 2015	Jul. 23, 2018
<input checked="" type="checkbox"/>	Preamplifier	HP	8447F	2805A02960	Dec. 22, 2016	Dec. 22, 2017
<input type="checkbox"/>	Broadband Antenna (Pre-amplifier)	ETS-LINDGREN	3142E-PA	00201891	Dec. 30, 2016	Dec. 30, 2017
<input checked="" type="checkbox"/>	Horn Antenna (Pre-amplifier)	ETS-LINDGREN	3117-PA	00201874	Dec. 30, 2016	Dec. 30, 2017
<input checked="" type="checkbox"/>	Multi device Controller	ETS-LINDGREN	7006-001	00160105	N/A	N/A
<input checked="" type="checkbox"/>	Test Software	Audix	e3	Software Version: 9.160323		

Conducted Emission Test Equipment List						
Used	Equipment	Manufacturer	Model No.	Serial Number	Cal. date (mm dd, yyyy)	Cal. Due date (mm dd, yyyy)
<input checked="" type="checkbox"/>	Receiver	R&S	ESR7	1316.3003K07-101181-K3	Dec. 22, 2016	Dec. 22, 2017
<input checked="" type="checkbox"/>	Pulse Limiter	R&S	ESH3-Z2	0357.8810.54	Dec. 22, 2016	Dec. 22, 2017
<input checked="" type="checkbox"/>	LISN	R&S	ESH2-Z5	860014/024	Dec. 22, 2016	Dec. 22, 2017
<input checked="" type="checkbox"/>	Test Software	Audix	e3	Software Version: 9.160323		

4. TEST CONFIGURATION

4.1 ENVIRONMENTAL CONDITIONS FOR TESTING

4.1.1 Normal or Extreme Test Conditions

Environment Parameter	Selected Values During Tests		
Test Condition	Ambient		
	Temperature (°C)	Voltage (V)	Relative Humidity (%)
NT/NV	+15 to +35	AC 120/60Hz	20 to 75
Remark:			
1) NV: Normal Voltage; NT: Normal Temperature			

4.1.2 Record of Normal Environment

Test Item	Temperature (°C)	Relative Humidity (%)	Pressure (Kpa)	Tested by
Conducted Emission	25.6	46	99.82	Andy Lin
Radiated Emission	22.5	53	100.24	Terence Chen

4.2 TEST MODES

Test Item	EMI Test Modes
Radiated Emission	Receiving Mode
Conducted Emission	Receiving Mode

4.3 TEST SETUP

4.3.1 For Radiated Emissions test setup

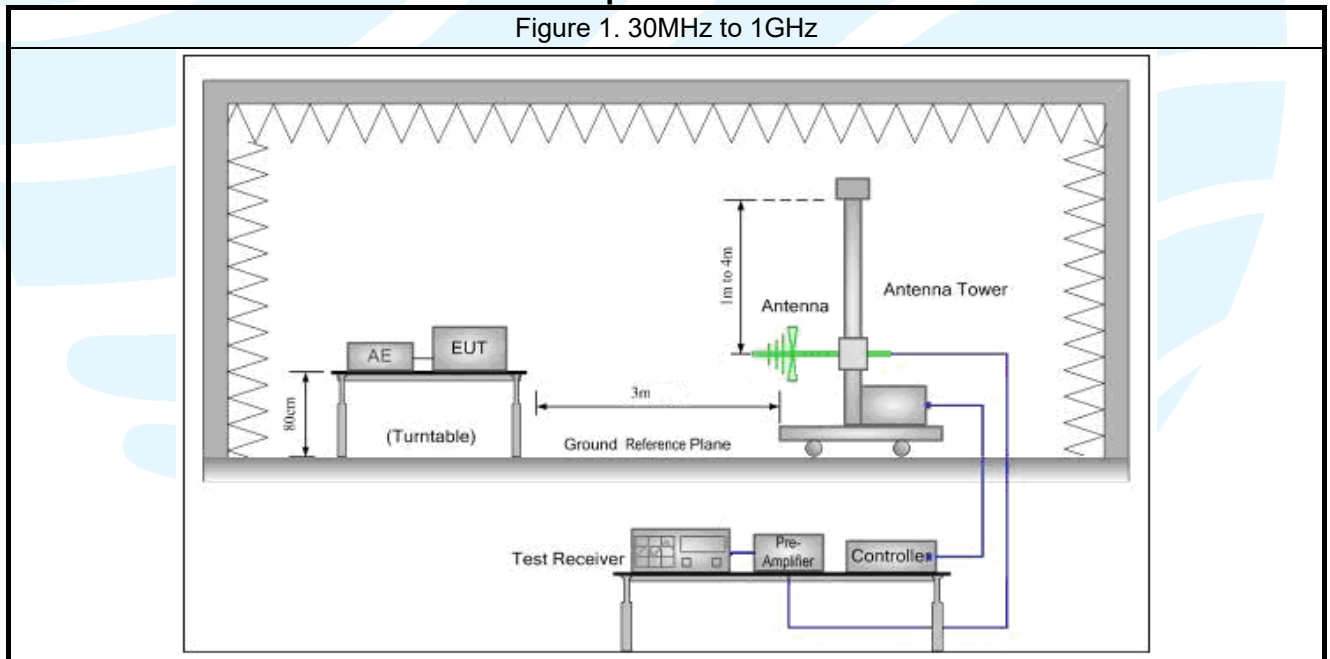

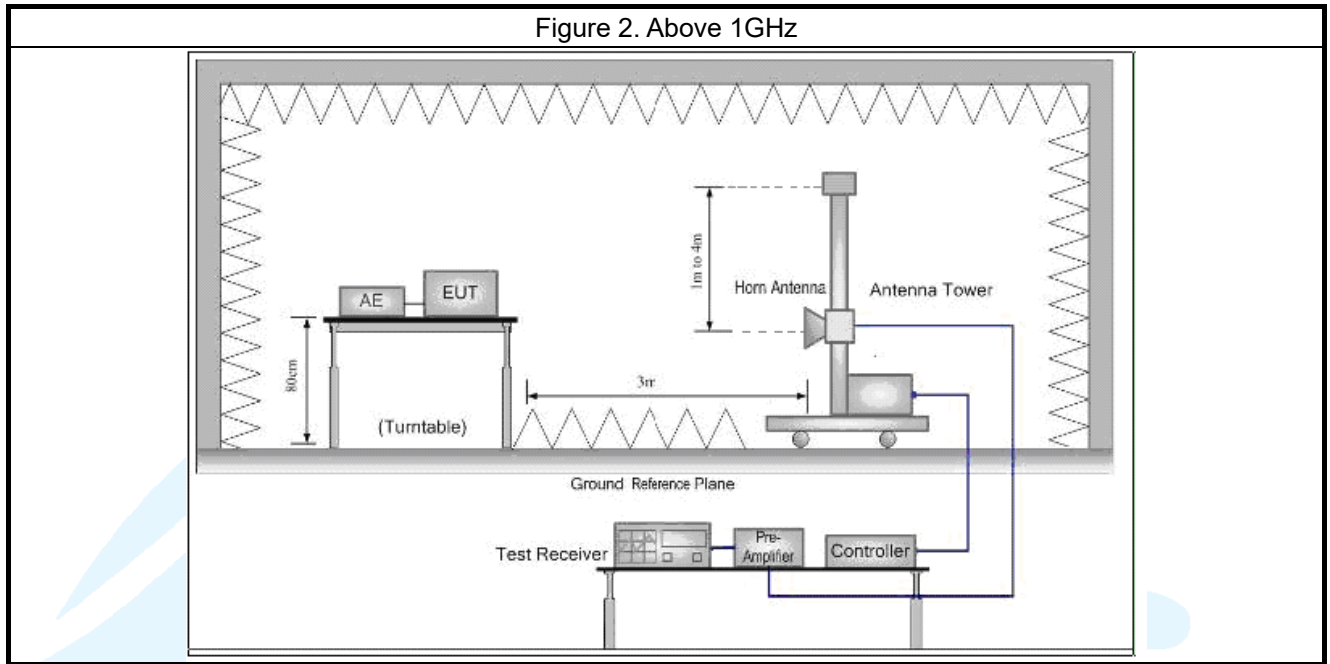

4.3.2 For Conducted Emissions test setup

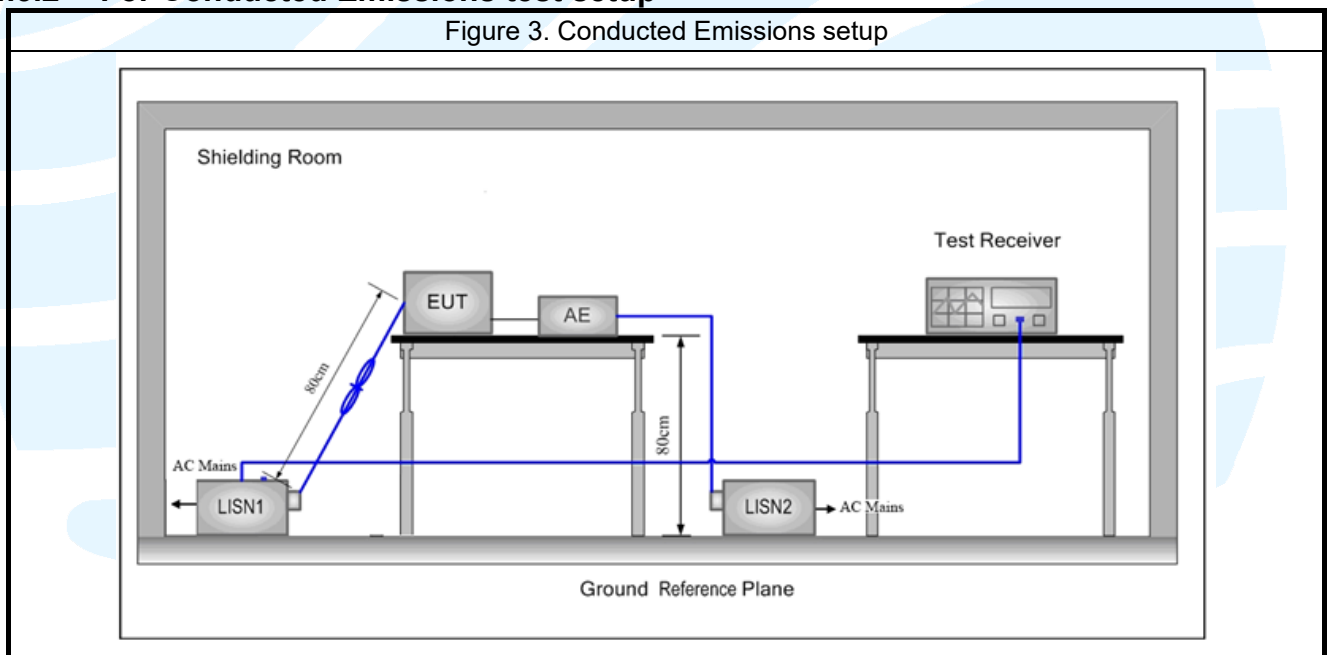

4.4 SYSTEM TEST CONFIGURATION

All readings are extrapolated back to the equivalent three meter reading using inverse scaling with distance. Analyzer resolution is 100 kHz or greater for frequencies below 1000MHz. The resolution is 1 MHz or greater for frequencies above 1000MHz. The spurious emissions more than 20 dB below the permissible value are not reported.

Radiated emission measurement were performed from the lowest radio frequency signal generated in the device which is greater than 9 kHz to the fifth harmonic of the highest fundamental frequency or to 40 GHz, whichever is lower.

5. REFERENCE DOCUMENTS FOR TESTING

No.	Identity	Document Title
1	FCC 47 CFR Part15 Subpart B	Unintentional Radiators
2	ANSI C63.4-2014	American National Standard for Methods of Measurement of Radio-Noise Emissions from Low-Voltage Electrical and Electronic Equipment in the Range of 9 kHz to 40 GHz

6. EMC REQUIREMENTS SPECIFICATION

6.1 RADIATED EMISSION

Test Requirement: FCC 47 CFR Part 15.109

Test Method: ANSI C63.4-2014

Receiver Setup:

Frequency: (f) (MHz)	Detector type	Measurement receiver bandwidth	
		RBW	VBW
$30 \leq f \leq 1\,000$	Quasi Peak	120 kHz	300 kHz
$f \geq 1000$	Peak	1 MHz	3 MHz
	Average	1 MHz	3 MHz

Measured frequency range

Highest frequency generated or used in the device or on which the device operates or tunes (MHz)	Upper frequency of measurement range (MHz)
Below 1.705	30.
1.705-108	1000.
108-500	2000.
500-1000	5000.
Above 1000	5th harmonic of the highest frequency or 40 GHz, whichever is lower.

Limits:

Limits for Class B devices

Frequency (MHz)	limits at 3m (dBµV/m)		
	QP Detector	PK Detector	AV Detector
30-88	40.0	--	--
88-216	43.5	--	--
216-960	46.0	--	--
960 to 1000	54.0	--	--
Above 1000	--	74.0	54.0

Note: 15.35(b), Unless otherwise specified, the limit on peak radio frequency emissions is 20dB above the maximum permitted average emission limit applicable to the equipment under test. This peak limit applies to the total peak emission level radiated by the device.

Remark:

- The lower limit shall apply at the transition frequencies.
- Emission level (dBµV/m) = 20 log Emission level (µV/m).
- For frequencies above 1000 MHz, the field strength limits are based on average detector, however, the peak field strength of any emission shall not exceed the maximum permitted average limits, specified above by more than 20 dB under any condition of modulation.

Test Setup: Refer to section 4.3.1 for details.

Test Procedures:

- From 30 MHz to 1GHz test procedure as below:

Shenzhen UnionTrust Quality and Technology Co., Ltd.

Address: 16/F, Block A, Building 6, Baoneng Science and Technology Park, Qingxiang Road No.1, Longhua New District, Shenzhen, China

Tel: +86-755-28230888

Fax: +86-755-28230888

E-mail: info@uttlab.com

[Http://www.uttlab.com](http://www.uttlab.com)

- 1) The Product was placed on the non-conductive turntable 0.8 m above the ground at a chamber.
- 2) Set the spectrum analyzer/receiver in Peak detector, Max Hold mode, and 120 kHz RBW. Record the maximum field strength of all the pre-scan process in the full band when the antenna is varied between 1~4 m in both horizontal and vertical, and the turntable is rotated from 0 to 360 degrees.
- 3) For each frequency whose maximum record was higher or close to limit, measure its QP value: vary the antenna's height and rotate the turntable from 0 to 360 degrees to find the height and degree where Product radiated the maximum emission, then set the test frequency analyzer/receiver to QP Detector and specified bandwidth with Maximum Hold Mode, and record the maximum value.

2. Above 1GHz test procedure as below:

- 1) The Product was placed on the non-conductive turntable 0.8 m above the ground at a chamber.
- 2) Set the spectrum analyzer/receiver in Peak detector, Max Hold mode, and 1MHz RBW. Record the maximum field strength of all the pre-scan process in the full band when the antenna is varied in both horizontal and vertical, and the turntable is rotated from 0 to 360 degrees.
- 3) For each frequency whose maximum record was higher or close to limit, measure its AV value: rotate the turntable from 0 to 360 degrees to find the degree where Product radiated the maximum emission, then set the test frequency analyzer/receiver to AV value and specified bandwidth with Maximum Hold Mode, and record the maximum value.

Equipment Used: Refer to section 3 for details.

Test Result: Pass

The measurement data as follows:

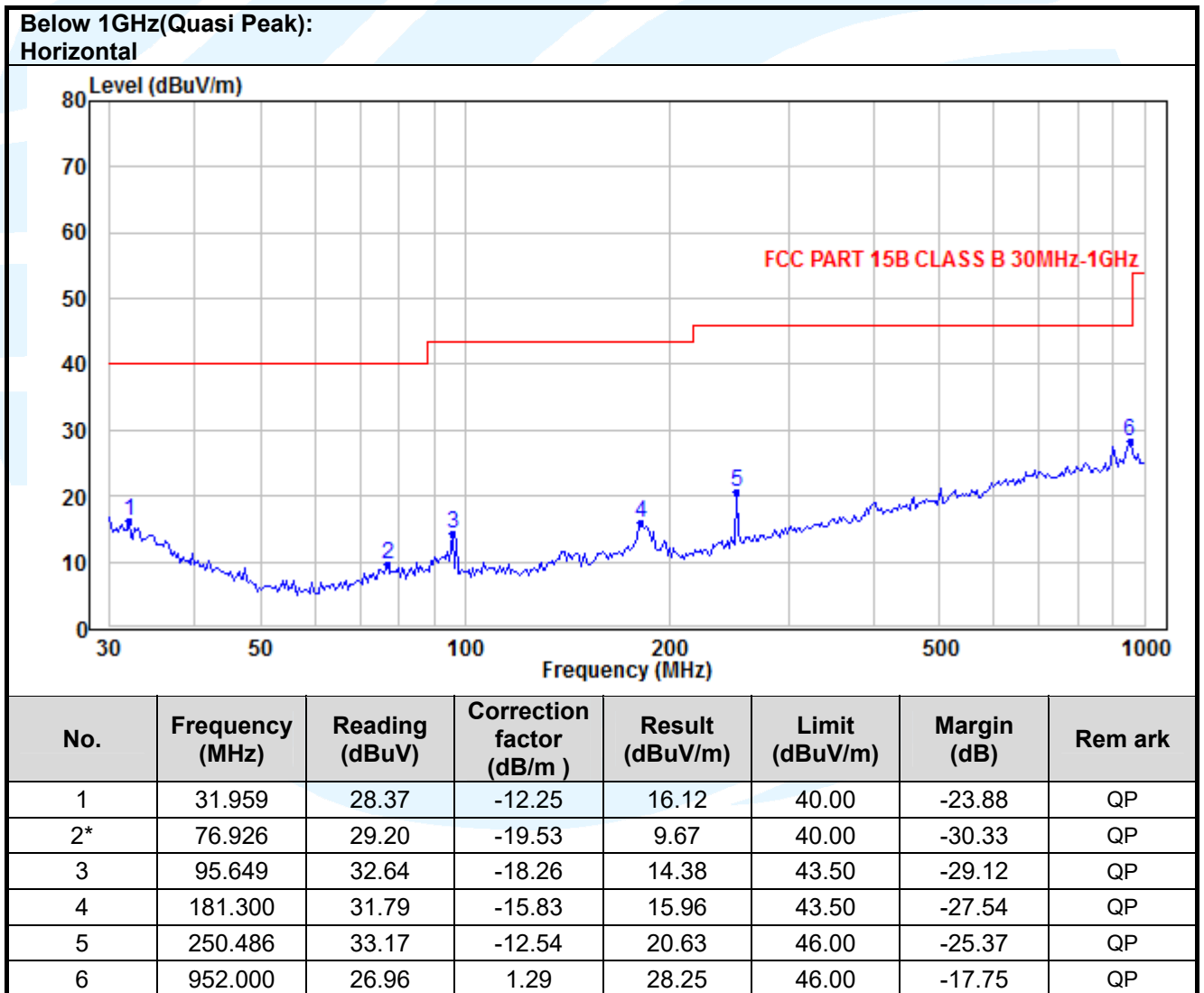

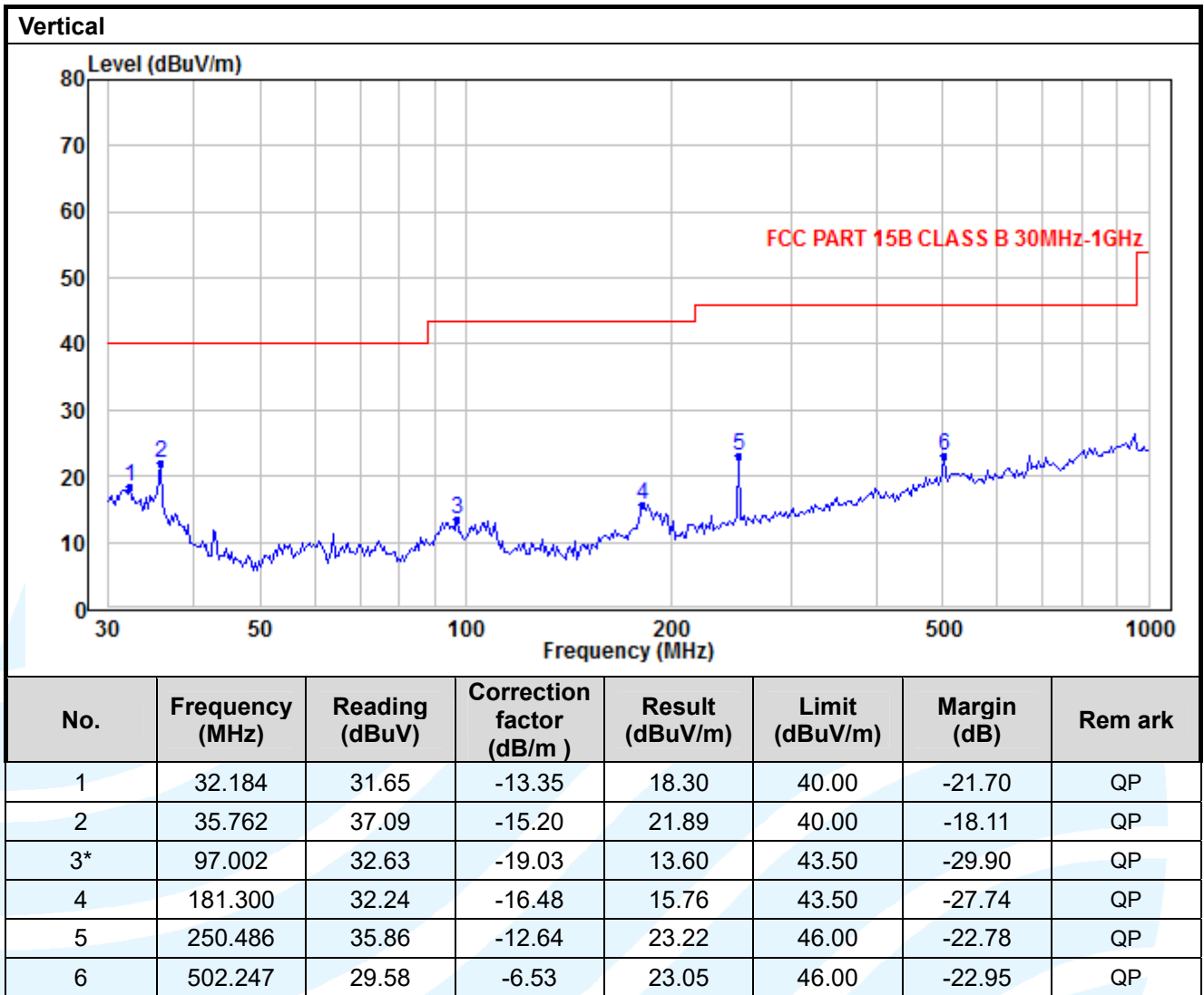

**Above 1GHz(Peak & Average)
Horizontal**

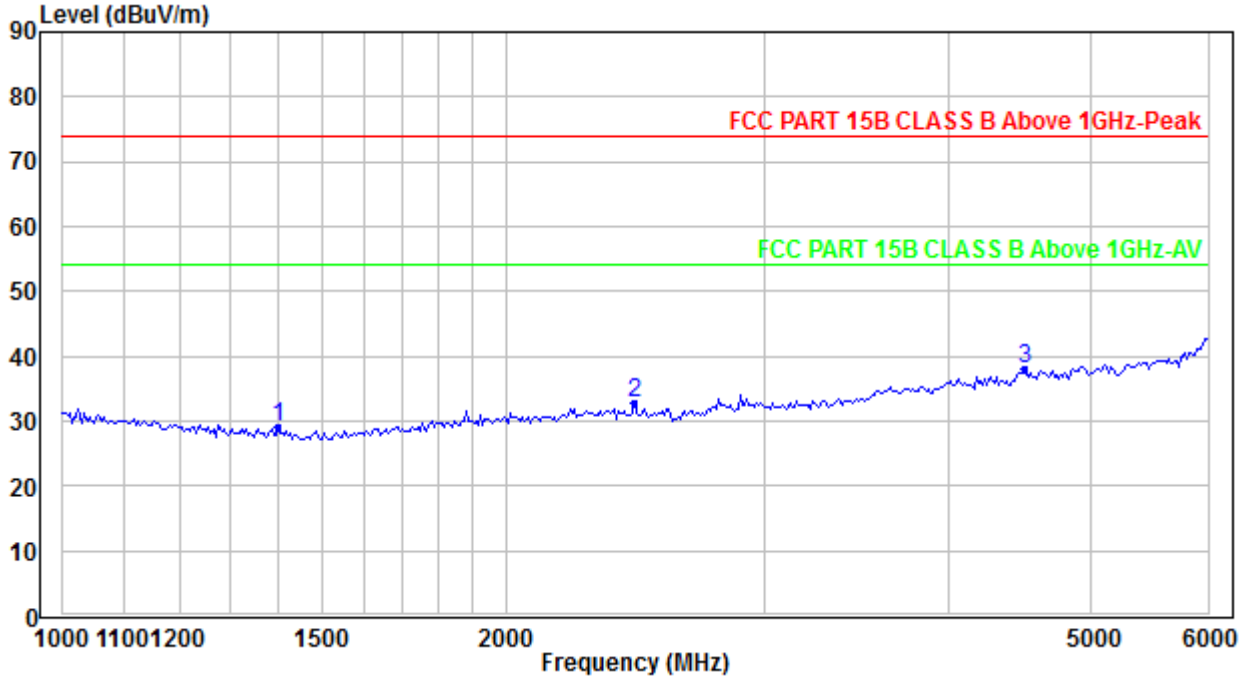

No.	Frequency (MHz)	Reading (dBuV)	Correction factor (dB/m)	Result (dBuV/m)	Limit (dBuV/m)	Margin (dB)	Remark
1*	1401.476	42.39	-13.22	29.17	74.00	-44.83	Peak
2	2445.096	41.71	-8.86	32.85	74.00	-41.15	Peak
3	4501.917	41.90	-3.98	37.92	74.00	-36.08	Peak

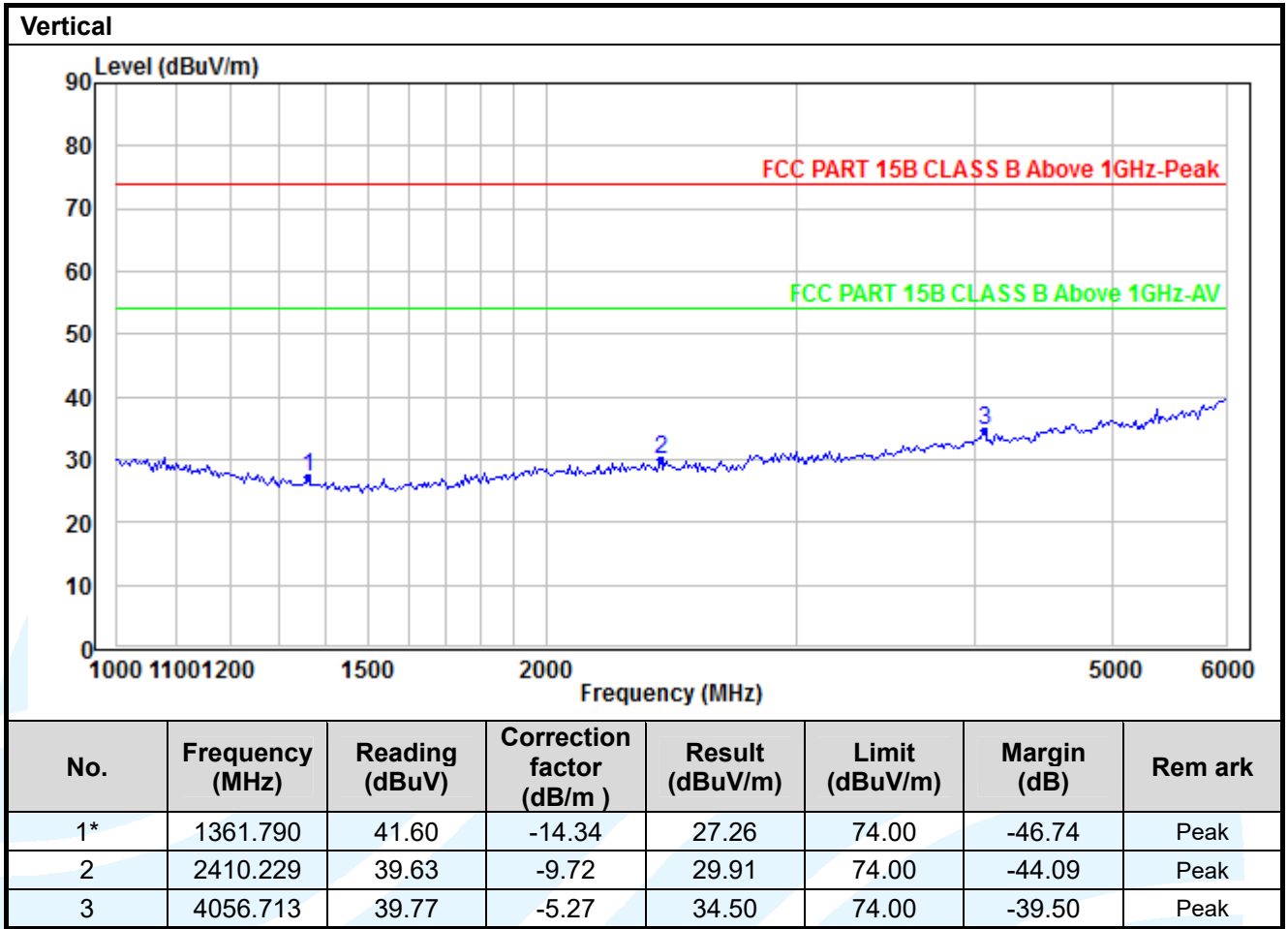

Remark:

Margin=Result-Limit

As shown in this section, for frequencies above 1GHz, the field strength limits are based on average limits. However, the peak field strength of any emission shall not exceed the maximum permitted average limits specified above by more than 20 dB under any condition of modulation. So, only the peak measurements were shown in the report.

6.2 CONDUCTED EMISSION

Test Requirement: FCC 47 CFR Part 15.107

Test Method: ANSI C63.4-2014

Limits:

Limits for Class B devices

Frequency range (MHz)	Limits (dB(μV))	
	Quasi-peak	Average
0,15 to 0,50	66 to 56	56 to 46
0,50 to 5	56	46
5 to 30	60	50

Remark:

1. The lower limit shall apply at the transition frequencies.
2. The limit decreases linearly with the logarithm of the frequency in the range 0.15 to 0.50 MHz.

Test Setup: Refer to section 4.3.2 for details.

Test Procedures:

- 1) The Product was placed on a nonconductive table 0.8 m above the horizontal ground reference plane, and 0.4 m from the vertical ground reference plane, and connected to the main through Line Impedance Stability Network (L.I.S.N).
- 2) The RBW of the receiver was set at 9 kHz in 150 kHz ~ 30MHz with Peak and AVG detector in Max Hold mode. Run the receiver's pre-scan to record the maximum disturbance generated from Product in all power lines in the full band.
- 3) For each frequency whose maximum record was higher or close to limit, measure its QP and AVG values and record.

Equipment Used: Refer to section 3 for details.

Test Result: Pass

The measurement data as follows:

Quasi Peak and Average:

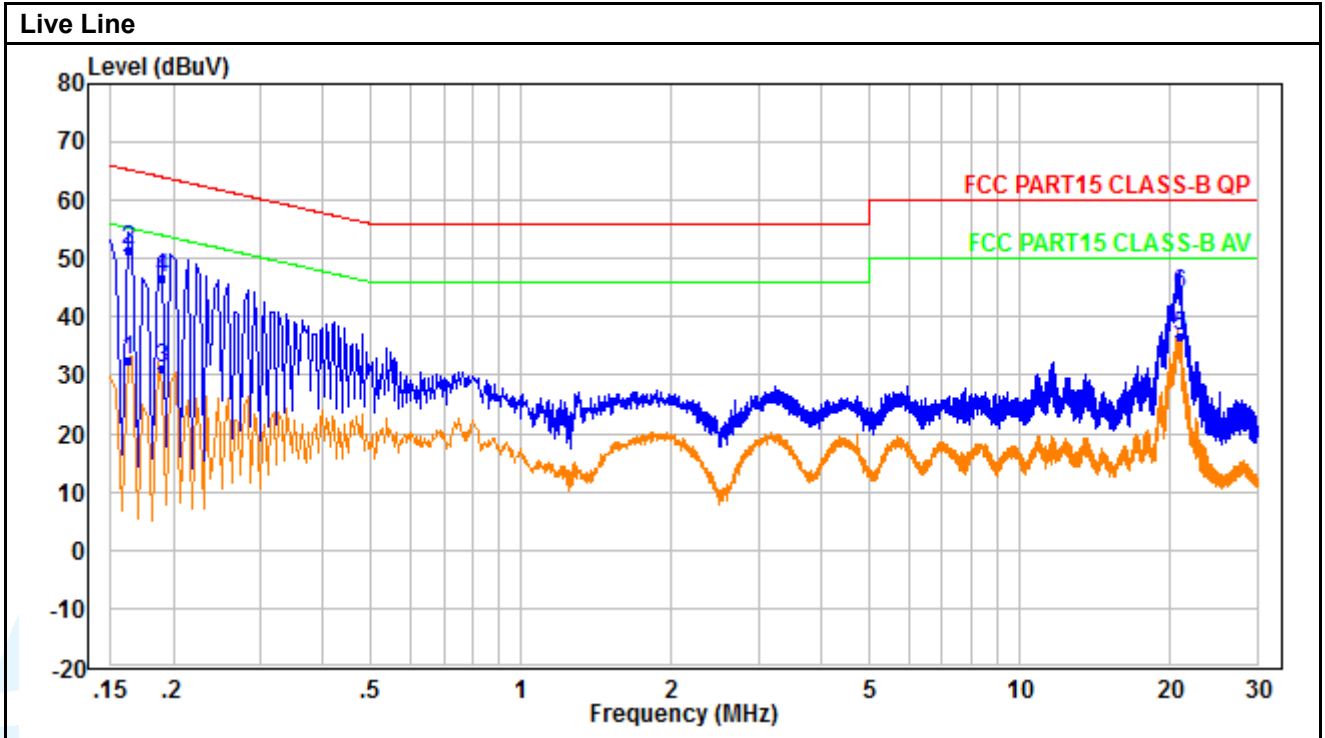

No.	Frequency (MHz)	Reading (dBuV)	Correction factor (dB/m)	Result (dBuV/m)	Limit (dBuV/m)	Margin (dB)	Remark
1*	0.162	22.30	10.20	32.50	55.40	-22.90	Average
2	0.162	41.30	10.20	51.50	65.40	-13.90	QP
3	0.190	21.00	10.20	31.20	54.00	-22.80	Average
4	0.190	36.50	10.20	46.70	64.00	-17.30	QP
5	20.909	23.80	12.90	36.70	50.00	-13.30	Average
6	20.909	30.90	12.90	43.80	60.00	-16.20	QP

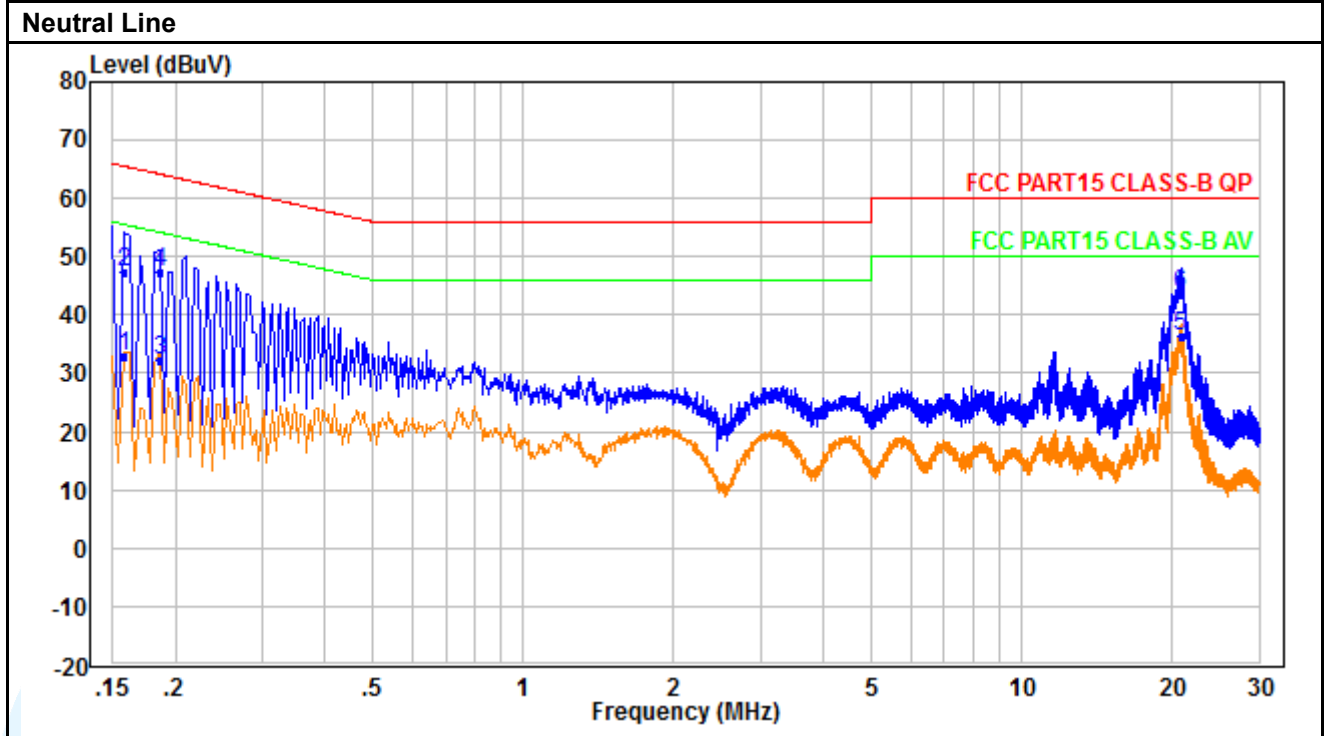

No.	Frequency (MHz)	Reading (dBUV)	Correction factor (dB/m)	Result (dBUV/m)	Limit (dBUV/m)	Margin (dB)	Remark
1*	0.158	22.80	10.20	33.00	55.60	-22.60	Average
2	0.158	37.10	10.20	47.30	65.60	-18.30	QP
3	0.186	22.10	10.20	32.30	54.20	-21.90	Average
4	0.186	37.10	10.20	47.30	64.20	-16.90	QP
5	20.901	23.70	12.80	36.50	50.00	-13.50	Average
6	20.901	30.90	12.80	43.70	60.00	-16.30	QP

Remark:

Margin=Result-Limit

An initial pre-scan was performed on the Phase and neutral lines with peak detector. Quasi-Peak and Average measurement were performed at the frequencies with maximized peak emission were detected.

APPENDIX 1 PHOTOGRAPHS OF TEST SETUP



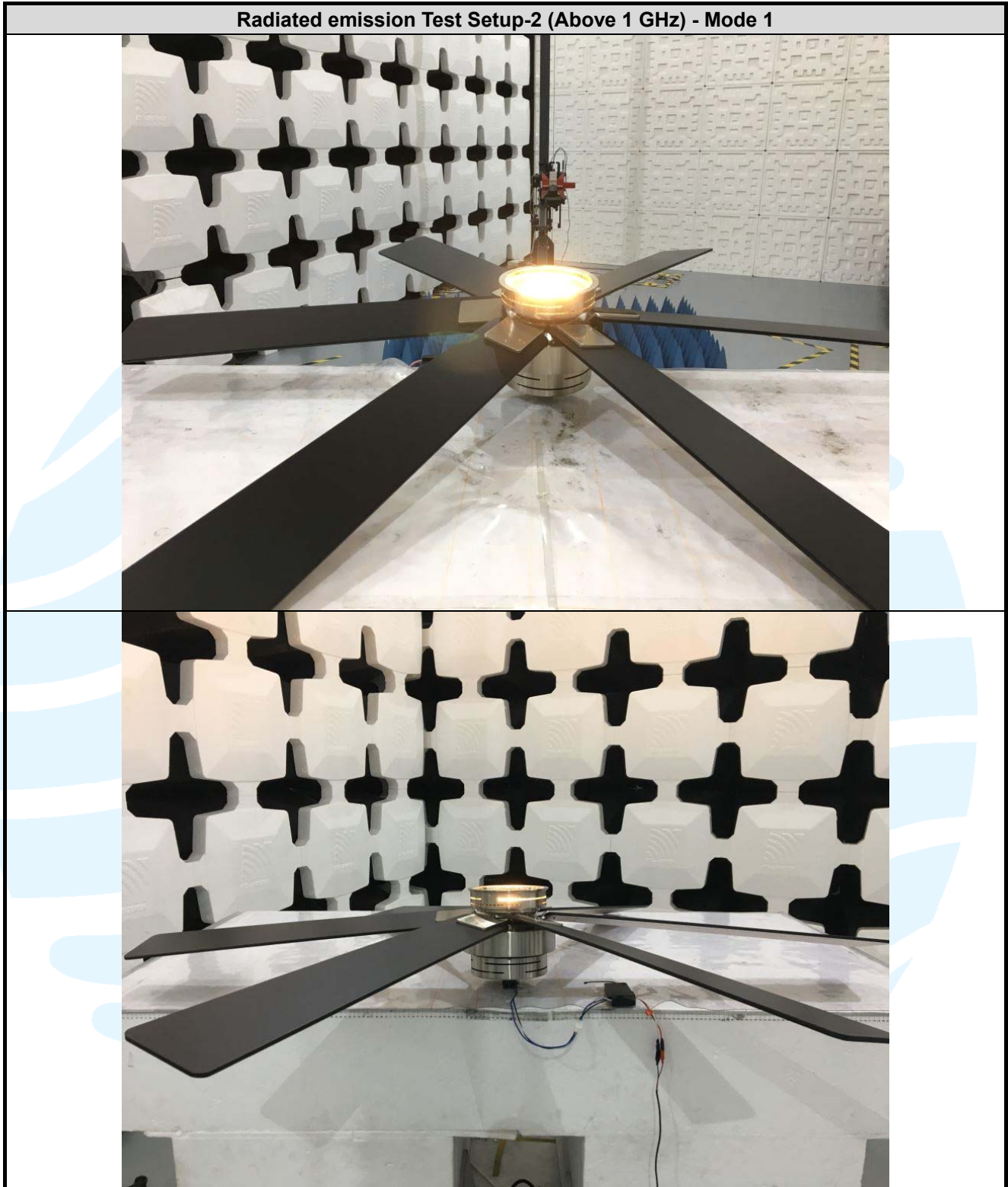

Conducted Emission Test Setup-3 - Mode 1

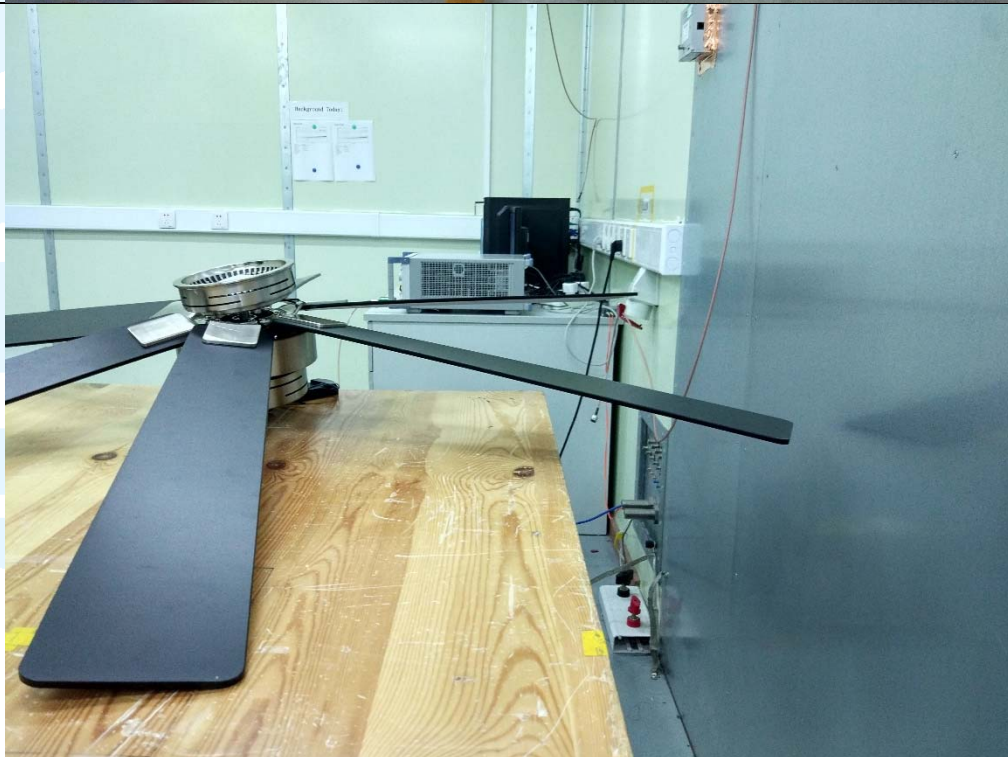
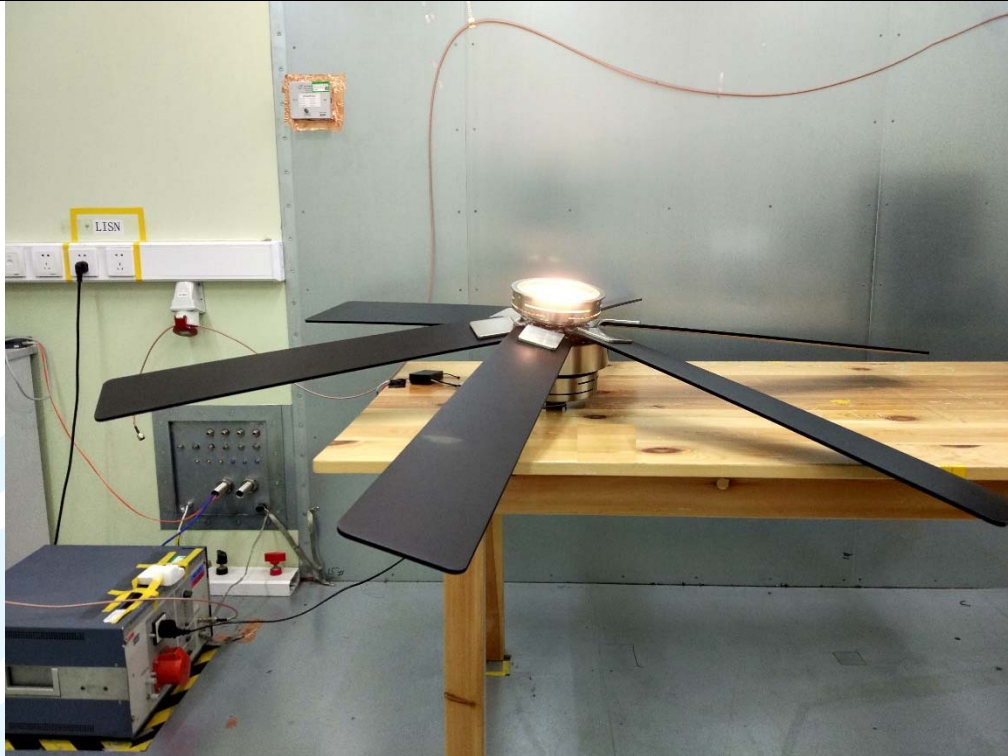

APPENDIX 2 PHOTOGRAPHS OF EUT CONSTRUCTIONAL DETAILS

EUT EXTERNAL PHOTOS

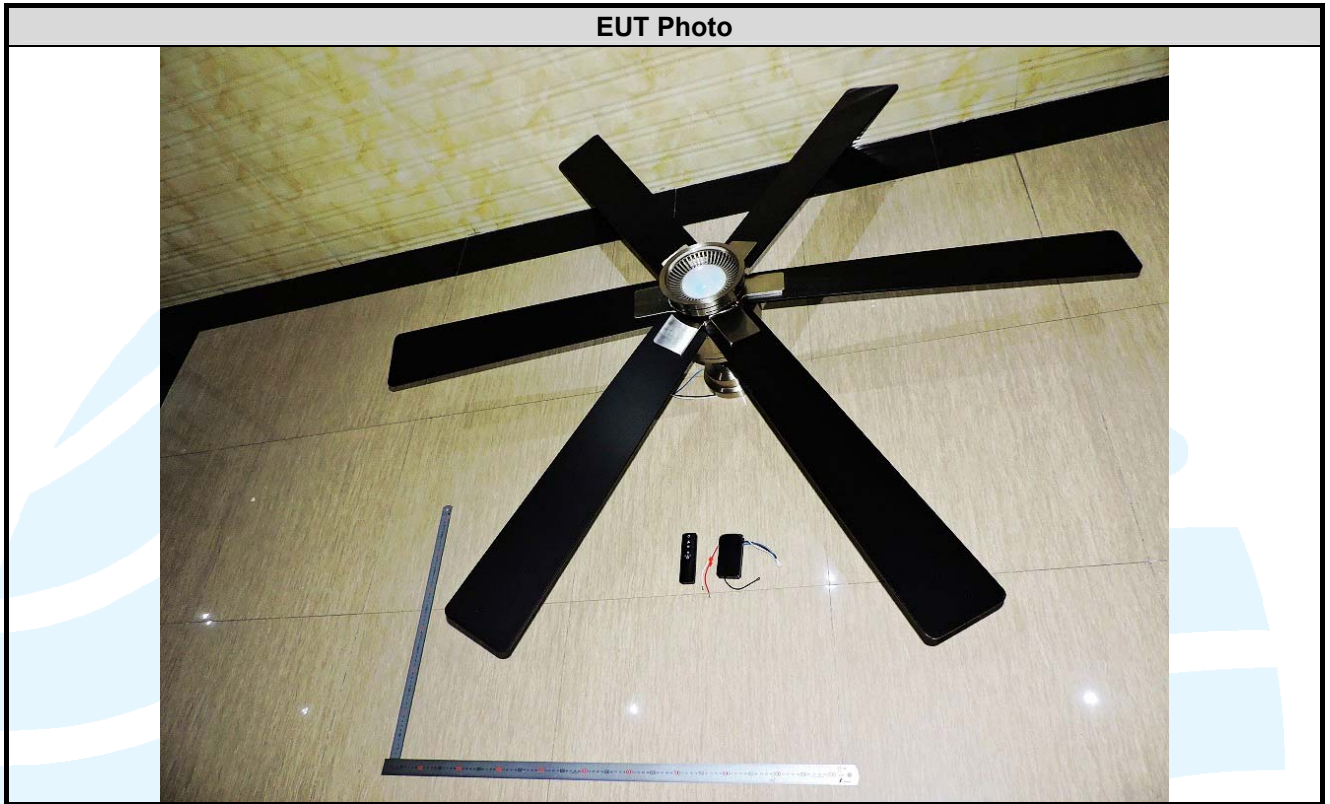

EUT INTERNAL PHOTOS

Shenzhen UnionTrust Quality and Technology Co., Ltd.

Address: 16/F, Block A, Building 6, Baoneng Science and Technology Park, Qingxiang Road No.1, Longhua New District, Shenzhen, China

Tel: +86-755-28230888

Fax: +86-755-28230886

E-mail: info@uttlab.com

[Http://www.uttlab.com](http://www.uttlab.com)

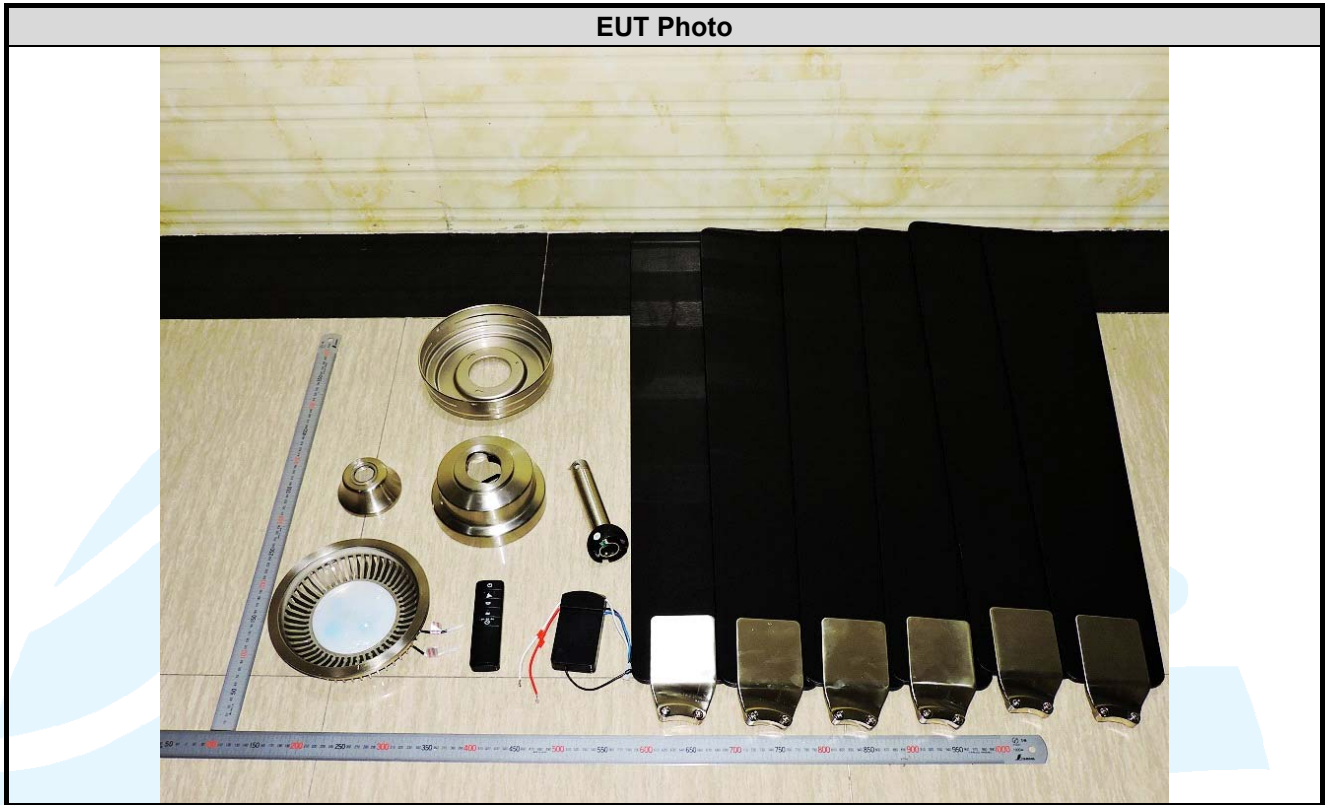

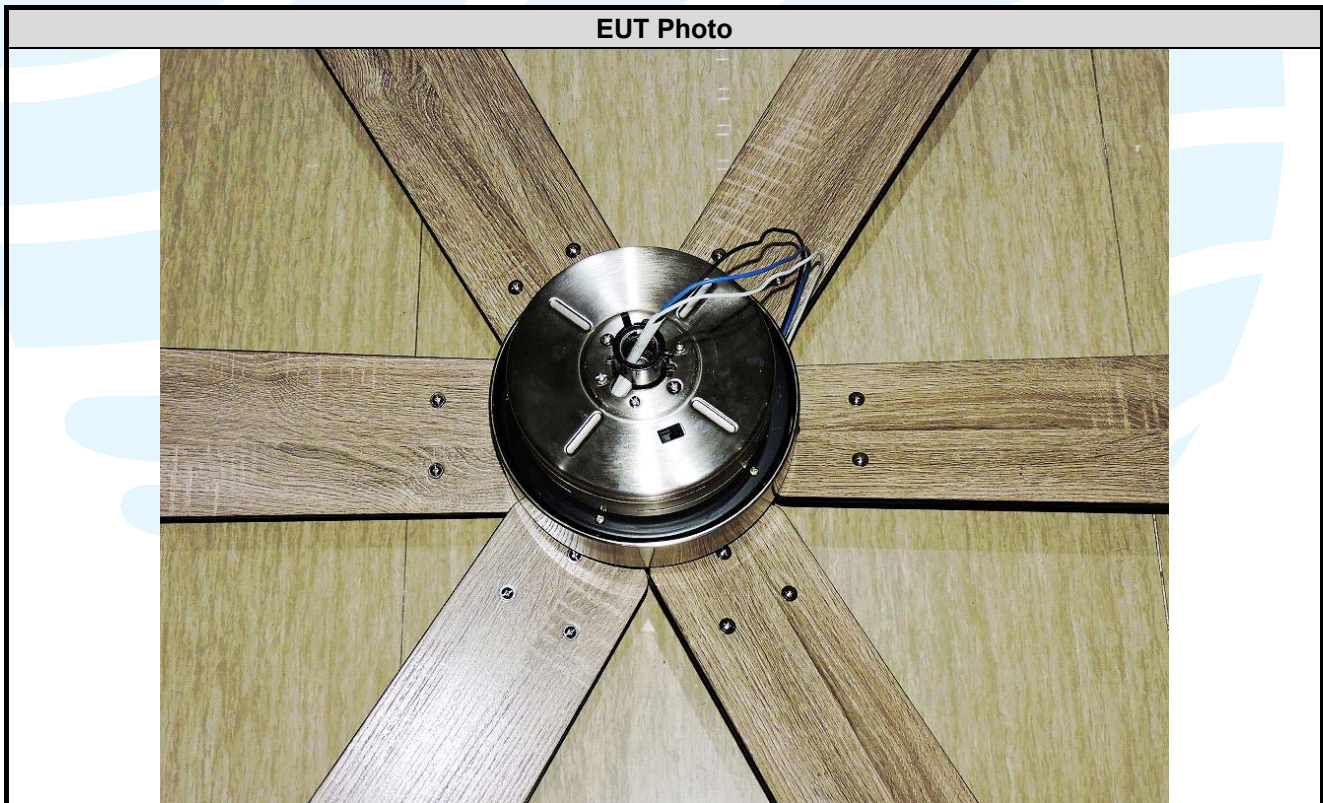
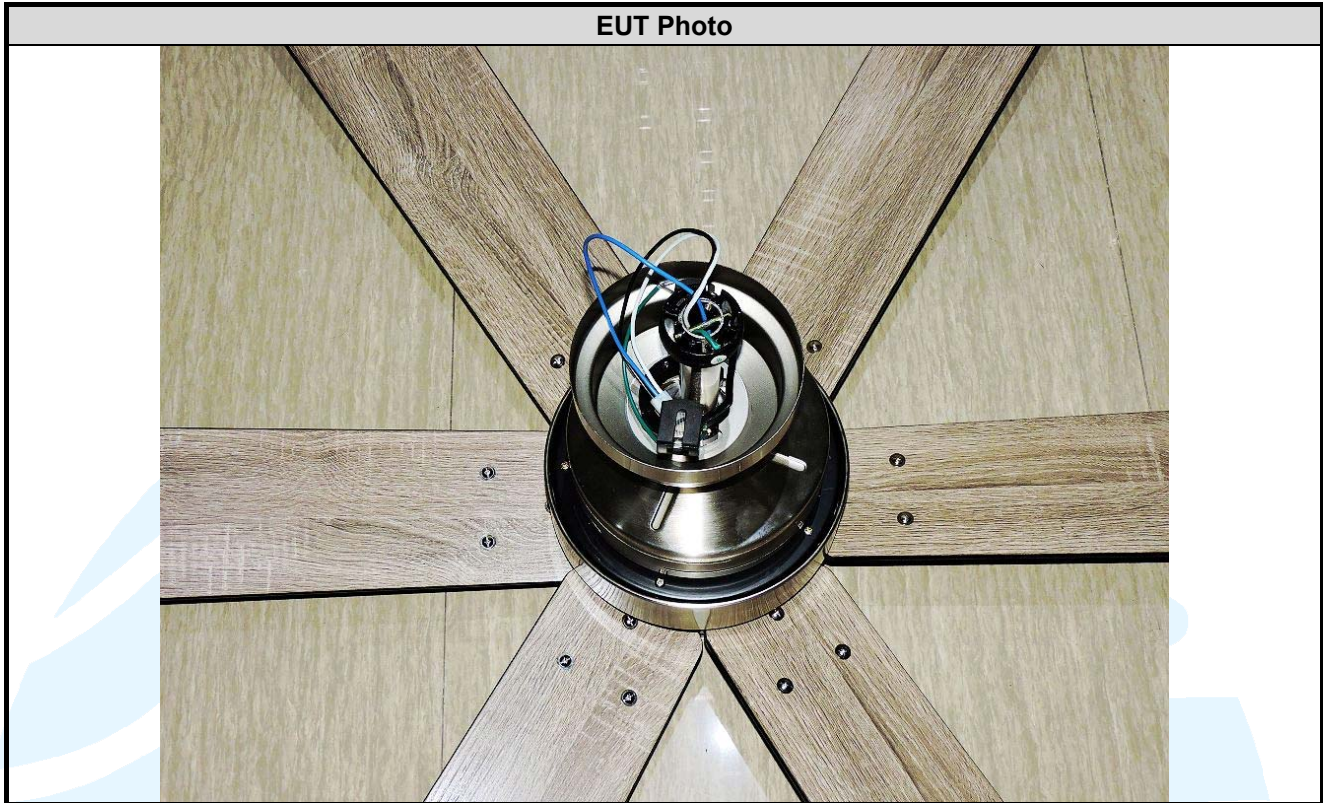

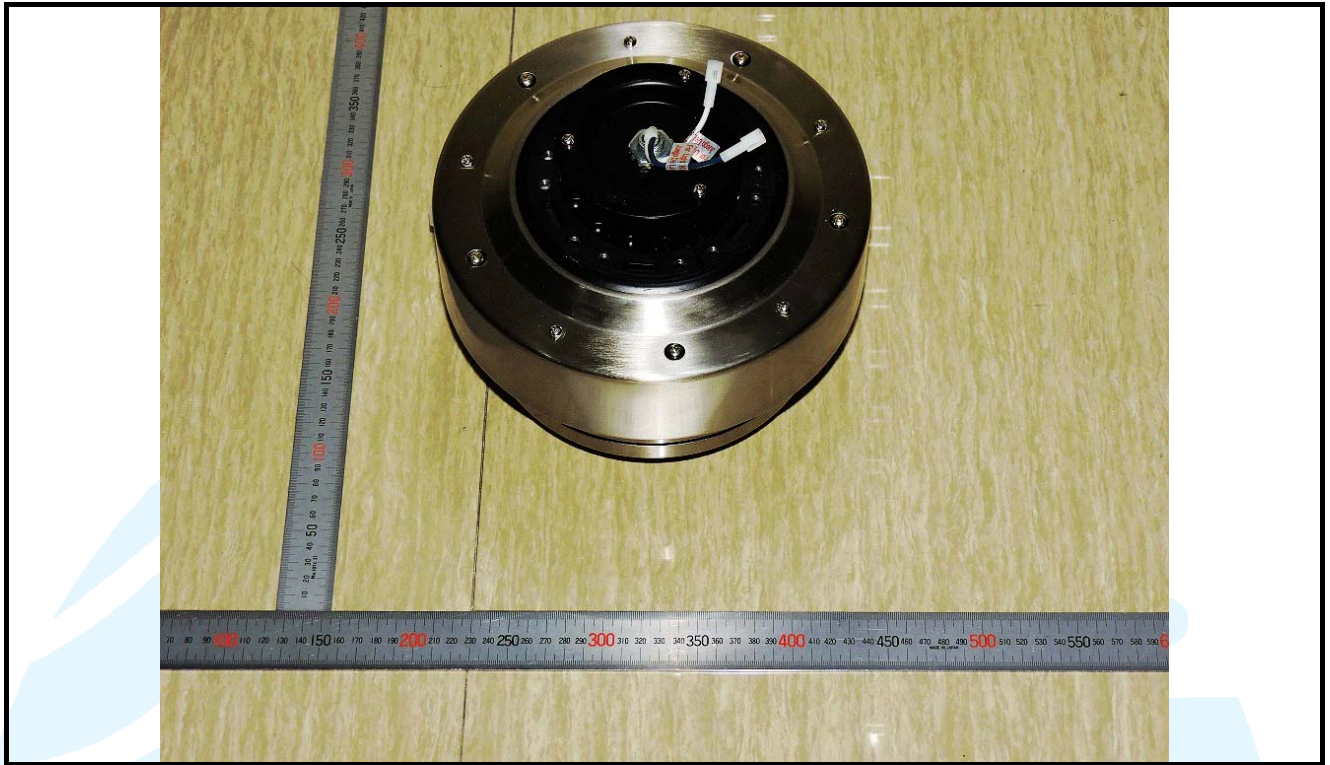

EUT Photo



EUT Photo



EUT Photo

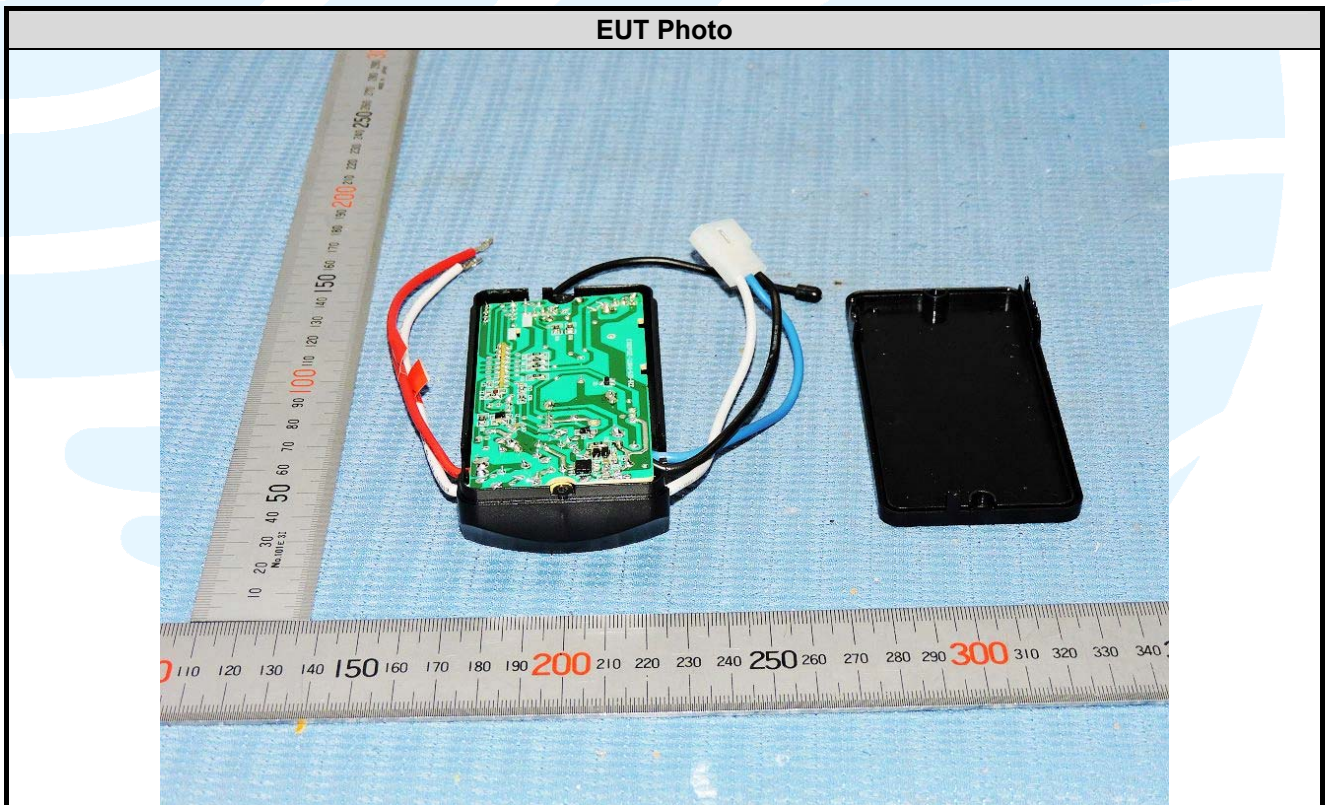

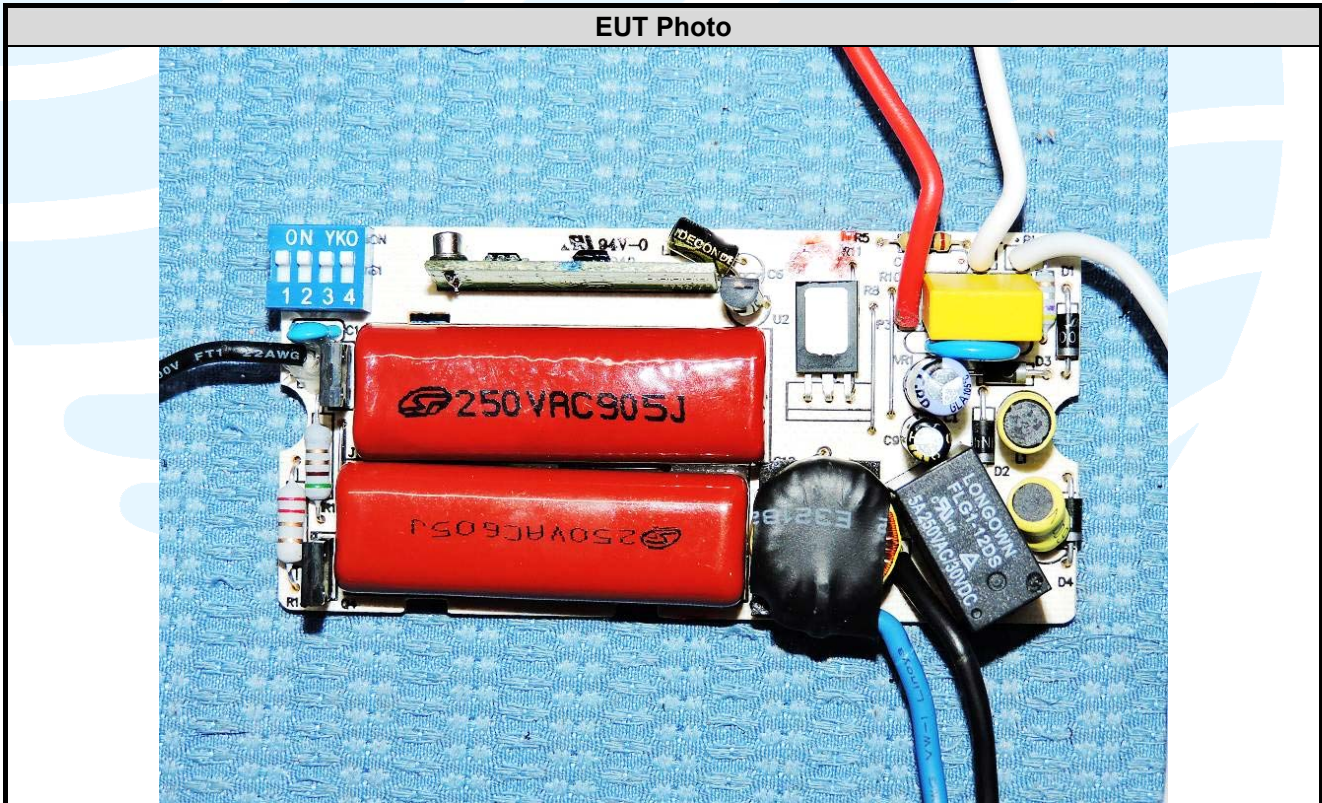
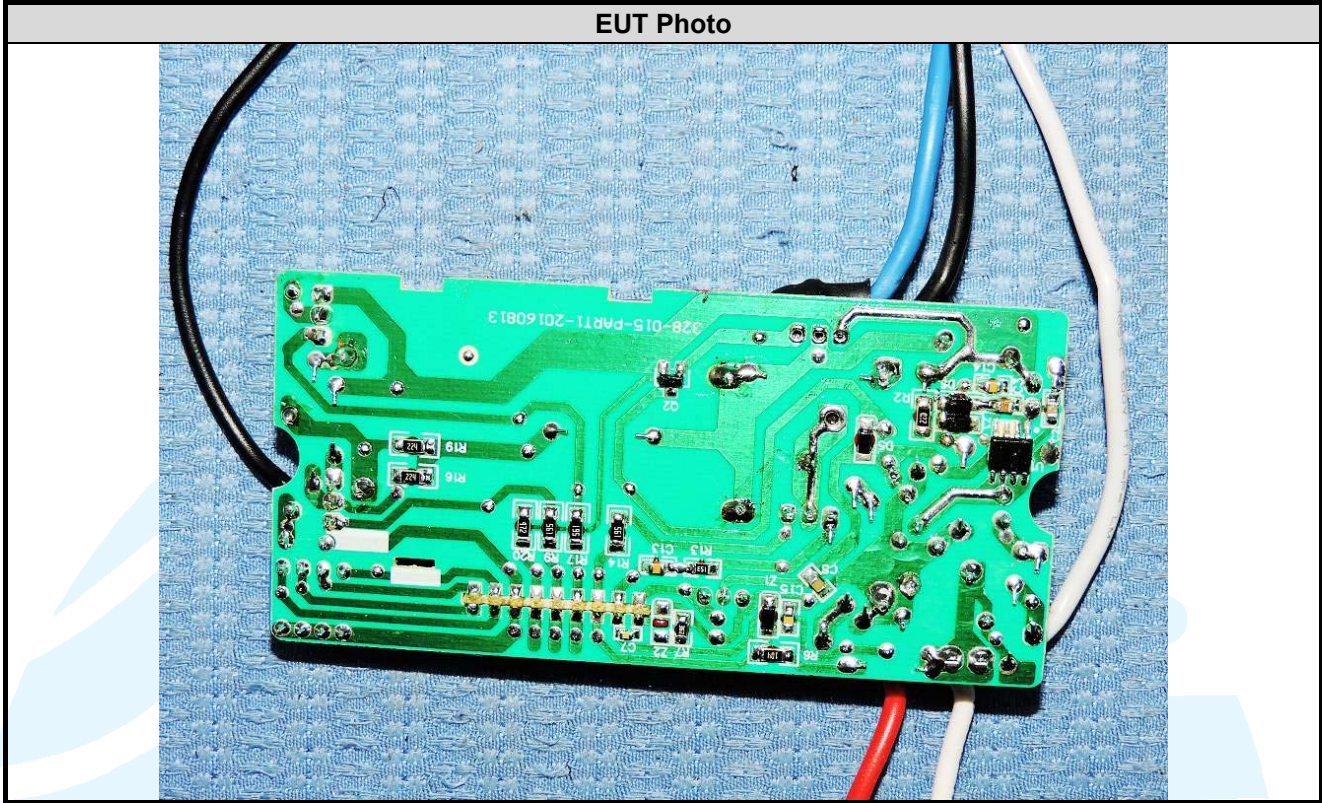

***** End of Report *****

The test report is effective only with both signature and specialized stamp. The result(s) shown in this report refer only to the sample(s) tested. Without written approval of UnionTrust, this report can't be reproduced except in full.