



ISO/IEC17025 Accredited Lab.

Report No: FCC 1504032
File reference No: 2015-04-13

Applicant: King of Fans, Inc.

Product: 52" Campbell

Model No: 52-BVD

Trademark: N/A

Test Standards: FCC Part 15 Subpart B: 2012

Test result: It is herewith confirmed and found to comply with the requirements set up by ANSI C63.4&FCC Part 15 regulations for the evaluation of electromagnetic compatibility

Approved By

Jack Chung

Jack Chung

Manager

Dated: April 13, 2015

Results appearing herein relate only to the sample tested

The technical reports is issued errors and omissions exempt and is subject to withdrawal at

SHENZHEN TIMEWAY TESTING LABORATORIES

Room 512-519, 5/F., East Tower, Building 4, Anhua Industrial Zone, Futian District,
Shenzhen, Guangdong, China

Tel (755) 83448688, Fax (755) 83442996, E-Mail:info@timewaytech.com



Special Statement:

The testing quality ability of our laboratory meet with "Quality Law of People's Republic of China" Clause 19.

The testing quality system of our laboratory meet with ISO/IEC-17025 requirements, which is approved by CNAS. This approval result is accepted by MRA of APLAC.

Our test facility is recognized, certified, or accredited by the following organizations:

CNAS-LAB Code: L2292

The EMC Laboratory has been assessed and in compliance with CNAS-CL01 accreditation criteria for testing Laboratories (identical to ISO/IEC 17025:2005 General Requirements) for the Competence of testing Laboratories.

FCC-Registration No.: 899988

The EMC Laboratory has been registered and fully described in a report filed with the (FCC) Federal Communications commission. The acceptance letter from the FCC is maintained in our files. Registration No.: 899988.

IC- Registration No.: IC5205A-02

The EMC Laboratory has been registered and fully described in a report filed with the (IC) Industry Canada. The acceptance letter from the IC is maintained in our files. Registration IC No.: 5205A-02.

The report refers only to the sample tested and does not apply to the bulk.

This report is issued in confidence to the client and it will be strictly treated as such by the SHENZHEN TIMEWAY TESTING LABORATORIES. It may not be reproduced rather in its entirety or in part and it may not be used for advertising. The client to whom the report is issued may, however, show or send it . or a certified copy there of prepared by the SHENZHEN TIMEWAY TESTING LABORATORIES. to his customer. Supplier or others persons directly concerned. SHENZHEN TIMEWAY TESTING LABORATORIES. will not, without the consent of the client enter into any discussion of correspondence with any third party concerning the contents of the report. In the event of the improper use of the report. The SHENZHEN TIMEWAY TESTING LABORATORIES. reserves the rights to withdraw it and to adopt any other remedies which may be appropriate.



Test Report Conclusion
Content

1.0	General Details	4
1.1	Test Lab Details.....	4
1.2	Applicant Details.....	4
1.3	Description of EUT	4
1.4	Test Uncertainty.....	4
1.5	Submitted Sample.....	4
1.6	Test Duration.....	4
2.0	List of Measurement Equipment	5
2.1	Conducted Emission Test.....	5
2.2	Radiated electromagnetic disturbance test.....	5
2.3	Auxiliary Equipment.....	5
3.0	Technical Details	6
3.1	Investigations Requested.....	6
3.2	Test Standards.....	6
4.0	Power line Conducted Emission Test	7
5.0	Radiated Disturbance Test	11
6.0	FCC ID Label	18
7.0	Photo of testing	19

The report refers only to the sample tested and does not apply to the bulk.

This report is issued in confidence to the client and it will be strictly treated as such by the SHENZHEN TIMEWAY TESTING LABORATORIES. It may not be reproduced in its entirety or in part and it may not be used for advertising. The client to whom the report is issued may, however, show or send it, or a certified copy thereof prepared by the SHENZHEN TIMEWAY TESTING LABORATORIES, to his customer. Supplier or others persons directly concerned. SHENZHEN TIMEWAY TESTING LABORATORIES, will not, without the consent of the client enter into any discussion of correspondence with any third party concerning the contents of the report.

In the event of the improper use of the report, the SHENZHEN TIMEWAY TESTING LABORATORIES, reserves the rights to withdraw it and to adopt any other remedies which may be appropriate.



1.0 General Details

1.1 Test Lab Details

Name : SHENZHEN TIMEWAY TESTING LABORATORIES.
Address: Room 512-519,5/F., East Tower,Building 4, Anhua Industrial Zone,
Futian District,Shenzhen, Guangdong China
Telephone: (755) 83448688
Fax: (755) 83442996
Site on File with the Federal Communications Commission – United States
Registration Number: 899988
For 3m & 10 m OATS
Site Listed with Industry Canada of Ottawa, Canada
Registration Number: IC: 5205A-02
For 3m & 10 m OATS

1.2 Applicant Details

Applicant: King of Fans, Inc.
Address: 1951 N.W. 22nd Street,Fort Lauderdale, FL33311,USA
Telephone: 954-484-7500
Fax: 954-784-7602

1.3 Description of EUT

Product: 52” Campbell
Manufacturer: Chienlun Industries (zhongshan) LTD
Address: Da che Industrial Area,Nanlang Town,zhongshan,Guangdong
China 528451
Brand Name: N/A
Model Number: 52-BVD
Rating: Input:120V, 60Hz; FAN W/O light kit 0.6A 72W; FAN W/Light kit: 2.1A, 252W
Rx Frequency: 304MHz (Matched TX product with FCC ID : KUJCE10202)

1.4 Submitted Sample: 1 Samples

1.5 Test Duration: 2015-04-08 to 2015-04-13

1.6 Test Uncertainty

Conducted Emissions Uncertainty =3.6dB
Radiated Emissions Uncertainty =4.7dB

The report refers only to the sample tested and does not apply to the bulk.

This report is issued in confidence to the client and it will be strictly treated as such by the SHENZHEN TIMEWAY TESTING LABORATORIES. It may not be reproduced rather in its entirety or in part and it may not be used for advertising. The client to whom the report is issued may, however, show or send it . or a certified copy there of prepared by the SHENZHEN TIMEWAY TESTING LABORATORIES. to his customer. Supplier or others persons directly concerned. SHENZHEN TIMEWAY TESTING LABORATORIES. will not, without the consent of the client enter into any discussion of correspondence with any third party concerning the contents of the report.

In the event of the improper use of the report. The SHENZHEN TIMEWAY TESTING LABORATORIES. reserves the rights to withdraw it and to adopt any other remedies which may be appropriate.



1.7 Test Engineer

Terry Tong

The sample tested by _____

Print Name: Terry Tong

2.0 List of Measurement Equipment

2.1 Conducted Emission Test

Name	Model No.	Serial No.	Manufacturer	Calibration Date	Calibration Cycle
EMI Test Receiver	ESH3	860905/006	RS	2014.08.21	1 Year
Spectrum Analyzer	ESA-L1500A	US37451154	HP	2014.08.21	1 Year
PULSE LIMITER	ESH3-Z2	100281	RS	2014.08.22	1 Year
LISN	ESH3-Z5	100294	RS	2014.08.22	1 Year
LISN	ESH3-Z5	100253	RS	2014.08.22	1 Year
LISN	LS16C	10010947251	AFJ	2014.08.21	1 Year
LISN (Three Phase)	NSLK 8126	8126453	Schwarebeck	2014.08.22	1 Year

2.2 Radiated electromagnetic disturbance test

Name	Model No.	Serial No.	Manufacturer	Calibration Date	Calibration Cycle
EMI Test Receiver	ESVD	100008	RS	2014.08.21	1 Year
Coaxial Switch	MP59B	M70585	ANRITSU	N/A	N/A
Spectrum Analyzer	8595E	3441A00893	HP	2014.06.24	1 Year
Amplifier	8447D	2727A05017	HP	2014.08.22	1 Year
Bilog Antenna	VULB9163	9163/340	Schwarebeck	2014.08.23	1 Year
Horn Antenna	BBHA 9120D	9120D-631	Schwarebeck	2014.08.23	1 Year
Horn Antenna	BBHA 9170	BBHA9170265	Schwarebeck	2014.08.23	1 Year

The report refers only to the sample tested and does not apply to the bulk.

This report is issued in confidence to the client and it will be strictly treated as such by the SHENZHEN TIMEWAY TESTING LABORATORIES. It may not be reproduced rather in its entirety or in part and it may not be used for advertising. The client to whom the report is issued may, however, show or send it, or a certified copy thereof prepared by the SHENZHEN TIMEWAY TESTING LABORATORIES, to his customer. Supplier or others persons directly concerned. SHENZHEN TIMEWAY TESTING LABORATORIES, will not, without the consent of the client enter into any discussion of correspondence with any third party concerning the contents of the report.

In the event of the improper use of the report. The SHENZHEN TIMEWAY TESTING LABORATORIES, reserves the rights to withdraw it and to adopt any other remedies which may be appropriate.



3.0 Technical Details

3.1 Investigations Requested

Perform Electromagnetic Interference [EMI] tests for FCC Requirement.

3.2 Test Standards

FCC Part 15 Subpart B: 2012

The report refers only to the sample tested and does not apply to the bulk.

This report is issued in confidence to the client and it will be strictly treated as such by the SHENZHEN TIMEWAY TESTING LABORATORIES. It may not be reproduced rather in its entirety or in part and it may not be used for advertising. The client to whom the report is issued may, however, show or send it, or a certified copy thereof prepared by the SHENZHEN TIMEWAY TESTING LABORATORIES, to his customer, supplier or other persons directly concerned. SHENZHEN TIMEWAY TESTING LABORATORIES will not, without the consent of the client enter into any discussion of correspondence with any third party concerning the contents of the report.

In the event of the improper use of the report, the SHENZHEN TIMEWAY TESTING LABORATORIES reserves the rights to withdraw it and to adopt any other remedies which may be appropriate.

4.0 Conducted Power line Test

4.1 Schematics of the test

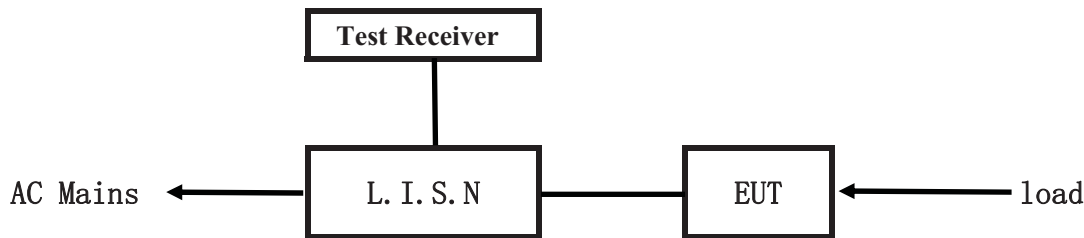

EUT: Equipment Under Test

4.2 Test Method and test Procedure

The EUT was tested according to ANSI C63.4-2009. The Frequency spectrum From 0.15MHz to 30MHz was investigated. The LISN used was 50ohm/50uH as specified by section 5.1 of ANSI C63.4 –2009. Cables and peripherals were moved to find the maximum emission levels for each frequency.

Actual Working Voltage and Frequency: 120V~, 60Hz

Block diagram of Test setup

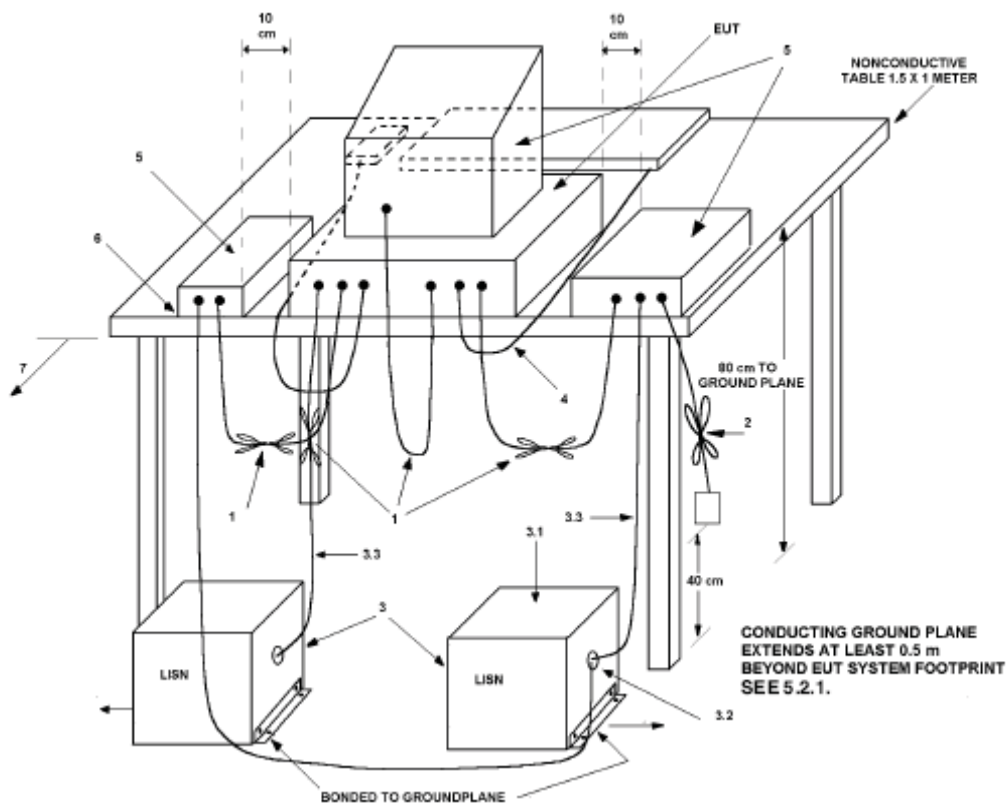

The report refers only to the sample tested and does not apply to the bulk.

This report is issued in confidence to the client and it will be strictly treated as such by the SHENZHEN TIMEWAY TESTING LABORATORIES. It may not be reproduced rather in its entirety or in part and it may not be used for advertising. The client to whom the report is issued may, however, show or send it, or a certified copy thereof prepared by the SHENZHEN TIMEWAY TESTING LABORATORIES, to his customer. Supplier or others persons directly concerned. SHENZHEN TIMEWAY TESTING LABORATORIES, will not, without the consent of the client enter into any discussion of correspondence with any third party concerning the contents of the report.

In the event of the improper use of the report. The SHENZHEN TIMEWAY TESTING LABORATORIES, reserves the rights to withdraw it and to adopt any other remedies which may be appropriate.



4.3 Power line conducted Emission Limit

Frequency(MHz)	Class A Limits dB(μ V)		Class B Limits dB(μ V)	
	Quasi-peak Level	Average Level	Quasi-peak Level	Average Level
0.15 ~ 0.50	79.00	66.00	66.00~56.00*	56.00~46.00*
0.50 ~ 5.00	73.00	60.00	56.00	46.00
5.00 ~ 30.00	73.00	60.00	60.00	50.00

- Notes:
1. *decreasing linearly with logarithm of frequency.
 2. The tighter limit shall apply at the transition frequencies

4.4 Test Results

The frequency spectrum from 0.15MHz to 30MHz was investigated. All reading are quasi-peak values with a resolution bandwidth of 9kHz.

The report refers only to the sample tested and does not apply to the bulk.
This report is issued in confidence to the client and it will be strictly treated as such by the SHENZHEN TIMEWAY TESTING LABORATORIES. It may not be reproduced rather in its entirety or in part and it may not be used for advertising. The client to whom the report is issued may, however, show or send it . or a certified copy there of prepared by the SHENZHEN TIMEWAY TESTING LABORATORIES. to his customer. Supplier or others persons directly concerned. SHENZHEN TIMEWAY TESTING LABORATORIES. will not, without the consent of the client enter into any discussion of correspondence with any third party concerning the contents of the report.
In the event of the improper use of the report. The SHENZHEN TIMEWAY TESTING LABORATORIES. reserves the rights to withdraw it and to adopt any other remedies which may be appropriate.



A: Conducted Emission on Live Terminal (150kHz to 30MHz)

EUT Operating Environment

Temperature: 26°C Humidity: 65%RH Atmospheric Pressure: 101 KPa

EUT set Condition: Receiving Mode

Equipment Level: Class B

Results: PASS

Please refer to following diagram for individual

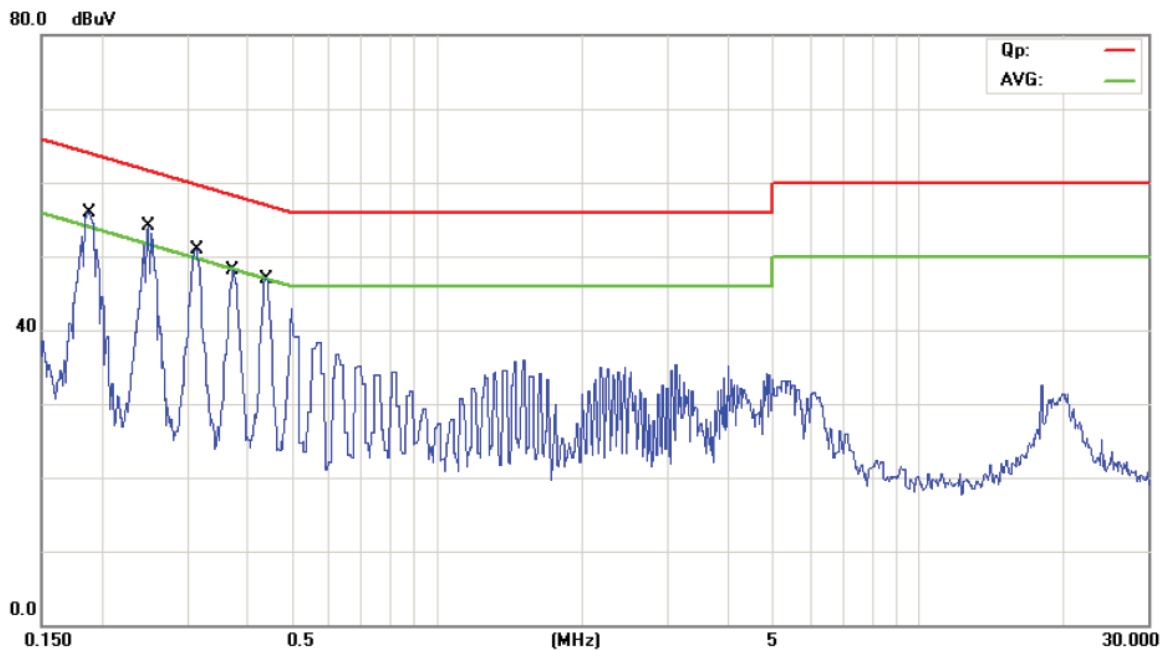

No.	Mk.	Freq. MHz	Reading Level dBuV	Correct Factor dB	Measure- ment dBuV	Limit dBuV	Over dB	Detector	Comment
1		0.1880	43.90	11.04	54.94	64.12	-9.18	QP	
2		0.1880	38.50	11.04	49.54	54.12	-4.58	AVG	
3		0.2501	42.10	11.11	53.21	61.75	-8.54	QP	
4	*	0.2501	36.20	11.11	47.31	51.75	-4.44	AVG	
5		0.3136	37.80	11.17	48.97	59.87	-10.90	QP	
6		0.3136	31.50	11.17	42.67	49.87	-7.20	AVG	
7		0.3754	35.70	11.24	46.94	58.38	-11.44	QP	
8		0.3754	30.60	11.24	41.84	48.38	-6.54	AVG	
9		0.4380	34.40	11.30	45.70	57.10	-11.40	QP	
10		0.4380	28.70	11.30	40.00	47.10	-7.10	AVG	

The report refers only to the sample tested and does not apply to the bulk.

This report is issued in confidence to the client and it will be strictly treated as such by the SHENZHEN TIMEWAY TESTING LABORATORIES. It may not be reproduced rather in its entirety or in part and it may not be used for advertising. The client to whom the report is issued may, however, show or send it, or a certified copy thereof prepared by the SHENZHEN TIMEWAY TESTING LABORATORIES, to his customer. Supplier or others persons directly concerned. SHENZHEN TIMEWAY TESTING LABORATORIES, will not, without the consent of the client enter into any discussion of correspondence with any third party concerning the contents of the report.

In the event of the improper use of the report. The SHENZHEN TIMEWAY TESTING LABORATORIES, reserves the rights to withdraw it and to adopt any other remedies which may be appropriate.



B: Conducted Emission on Neutral Terminal (150kHz to 30MHz)

EUT Operating Environment

Temperature: 26°C Humidity: 65%RH Atmospheric Pressure: 101 KPa

EUT set Condition: Receiving Mode

Equipment Level: Class B

Results: Pass

Please refer to following diagram for individual

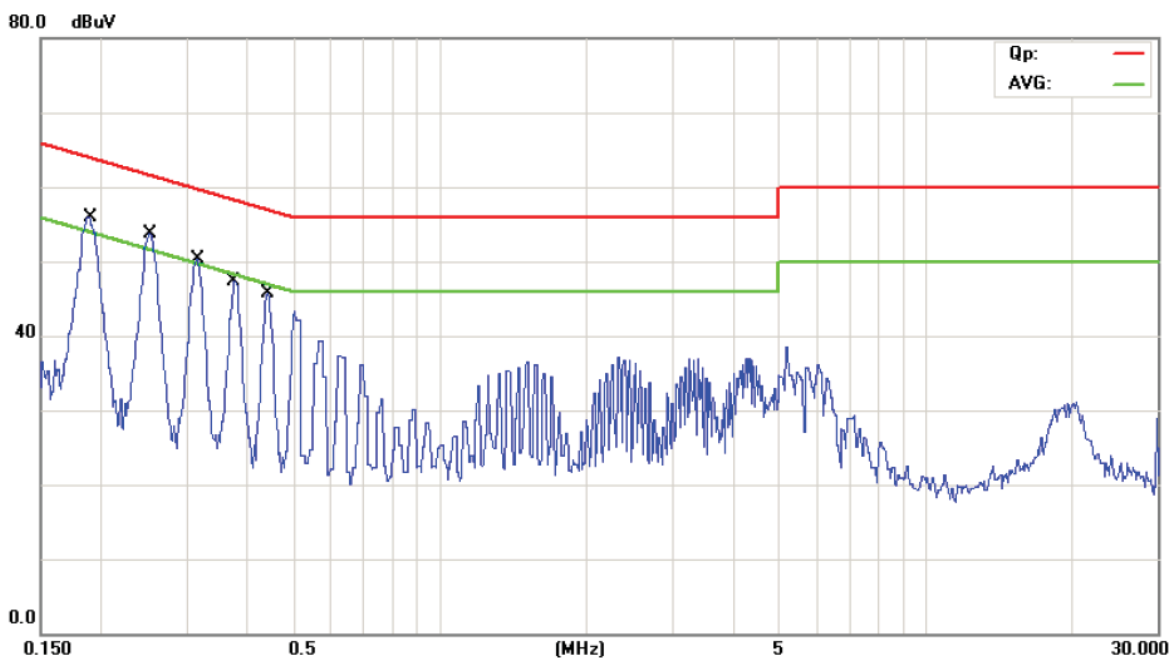

No.	Mk.	Freq.	Reading Level	Correct Factor	Measurement	Limit	Over	Detector	Comment
		MHz	dBuV	dB	dBuV	dBuV	dB		
1		0.1878	43.90	11.04	54.94	64.13	-9.19	QP	
2	*	0.1878	38.50	11.04	49.54	54.13	-4.59	AVG	
3		0.2516	41.00	11.11	52.11	61.70	-9.59	QP	
4		0.2516	34.50	11.11	45.61	51.70	-6.09	AVG	
5		0.3141	37.30	11.17	48.47	59.86	-11.39	QP	
6		0.3141	30.50	11.17	41.67	49.86	-8.19	AVG	
7		0.3741	34.60	11.24	45.84	58.41	-12.57	QP	
8		0.3741	28.40	11.24	39.64	48.41	-8.77	AVG	
9		0.4381	33.30	11.31	44.61	57.10	-12.49	QP	
10		0.4381	26.20	11.31	37.51	47.10	-9.59	AVG	

The report refers only to the sample tested and does not apply to the bulk.
This report is issued in confidence to the client and it will be strictly treated as such by the SHENZHEN TIMEWAY TESTING LABORATORIES. It may not be reproduced rather in its entirety or in part and it may not be used for advertising. The client to whom the report is issued may, however, show or send it, or a certified copy thereof prepared by the SHENZHEN TIMEWAY TESTING LABORATORIES, to his customer. Supplier or others persons directly concerned. SHENZHEN TIMEWAY TESTING LABORATORIES, will not, without the consent of the client enter into any discussion of correspondence with any third party concerning the contents of the report.
In the event of the improper use of the report. The SHENZHEN TIMEWAY TESTING LABORATORIES, reserves the rights to withdraw it and to adopt any other remedies which may be appropriate.

5.0 Radiated Disturbance Test

5.1 Schematics of the test

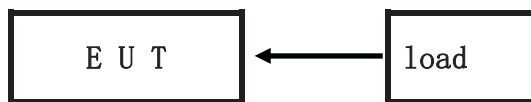

5.2 Test Method and test Procedure:

The EUT was tested according to ANSI C63.4 –2009; The frequency spectrum from 30MHz to 5GHz was investigated. All reading from 30MHz to 1GHz are quasi-peak values with a resolution bandwidth of 120kHz. For measurement above 1GHz, peak values with RBW=VBW=1MHz and PK detector. AV value with RBW=1MHz, VBW=10Hz and PK detector.

Actual Working Voltage and Frequency: 120V~, 60Hz

Block diagram of Test setup

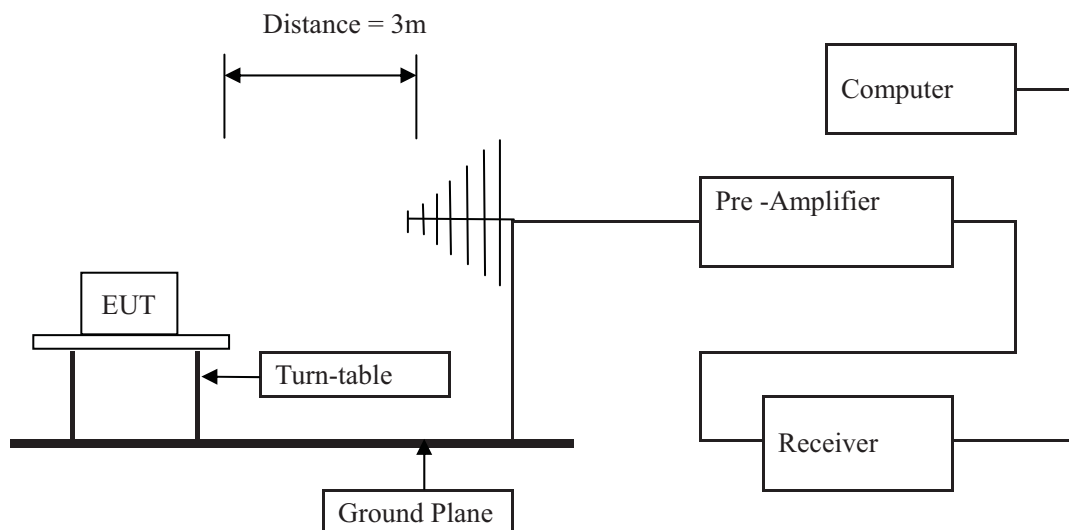

The report refers only to the sample tested and does not apply to the bulk.

This report is issued in confidence to the client and it will be strictly treated as such by the SHENZHEN TIMEWAY TESTING LABORATORIES. It may not be reproduced rather in its entirety or in part and it may not be used for advertising. The client to whom the report is issued may, however, show or send it, or a certified copy thereof prepared by the SHENZHEN TIMEWAY TESTING LABORATORIES, to his customer, Supplier or others persons directly concerned. SHENZHEN TIMEWAY TESTING LABORATORIES, will not, without the consent of the client enter into any discussion of correspondence with any third party concerning the contents of the report.

In the event of the improper use of the report, The SHENZHEN TIMEWAY TESTING LABORATORIES, reserves the rights to withdraw it and to adopt any other remedies which may be appropriate.

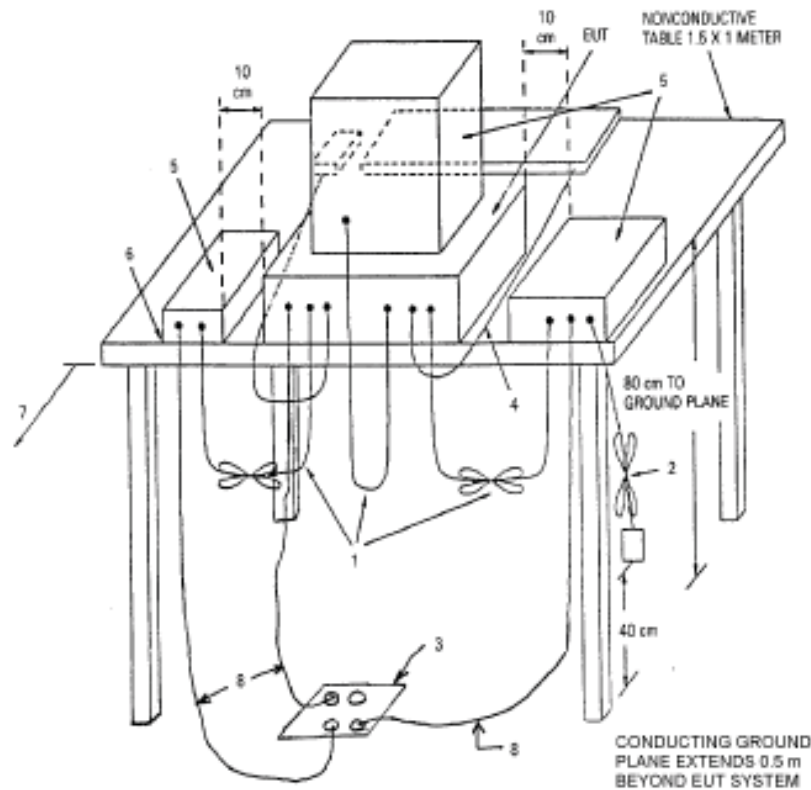

5.3 Radiated Emission Limit

Frequency Range (MHz)	Distance (m)	Field strength (dB μ V/m)
30-88	3	40.00
88-216	3	43.50
216-960	3	46.00
Above 960	3	54.00

Note: 1.The lower limit shall apply at the transition frequencies

2.This is a handheld device. The radiated emissions should be tested under 3-axes position (Lying, Side, and Stand), After pre-test. It was found that the worse radiated emission was get at the lying position.

5.4 Test result

The frequency spectrum from 30MHz to 5GHz was investigated. All reading from 30MHz to 1GHz are quasi-peak values with a resolution bandwidth of 120kHz. For measurement above 1GHz, peak values with RBW=VBW=1MHz and PK detector. AV value with RBW=1MHz, VBW=10Hz and PK. Measurements were made at 3 meters.

The report refers only to the sample tested and does not apply to the bulk.

This report is issued in confidence to the client and it will be strictly treated as such by the SHENZHEN TIMEWAY TESTING LABORATORIES. It may not be reproduced rather in its entirety or in part and it may not be used for advertising. The client to whom the report is issued may, however, show or send it . or a certified copy there of prepared by the SHENZHEN TIMEWAY TESTING LABORATORIES. to his customer. Supplier or others persons directly concerned. SHENZHEN TIMEWAY TESTING LABORATORIES. will not, without the consent of the client enter into any discussion of correspondence with any third party concerning the contents of the report.

In the event of the improper use of the report. The SHENZHEN TIMEWAY TESTING LABORATORIES. reserves the rights to withdraw it and to adopt any other remedies which may be appropriate.



Test result

General Radiated Emission Data and Harmonics Radiated Emission Data

Radiated Emission In Horizontal/ In Vertical (30MHz----1000MHz)

EUT set Condition: Receiving Mode

Results: Pass

Frequency (MHz)	Level@3m (dB μ V/m)	Antenna Polarity	Limit@3m (dB μ V/m)
183.400	23.83	H	43.50
67.040	24.15	V	40.00

The report refers only to the sample tested and does not apply to the bulk.

This report is issued in confidence to the client and it will be strictly treated as such by the SHENZHEN TIMEWAY TESTING LABORATORIES. It may not be reproduced rather in its entirety or in part and it may not be used for advertising. The client to whom the report is issued may, however, show or send it, or a certified copy thereof prepared by the SHENZHEN TIMEWAY TESTING LABORATORIES, to his customer. Supplier or others persons directly concerned. SHENZHEN TIMEWAY TESTING LABORATORIES, will not, without the consent of the client enter into any discussion of correspondence with any third party concerning the contents of the report.

In the event of the improper use of the report. The SHENZHEN TIMEWAY TESTING LABORATORIES, reserves the rights to withdraw it and to adopt any other remedies which may be appropriate.



Test Figure:

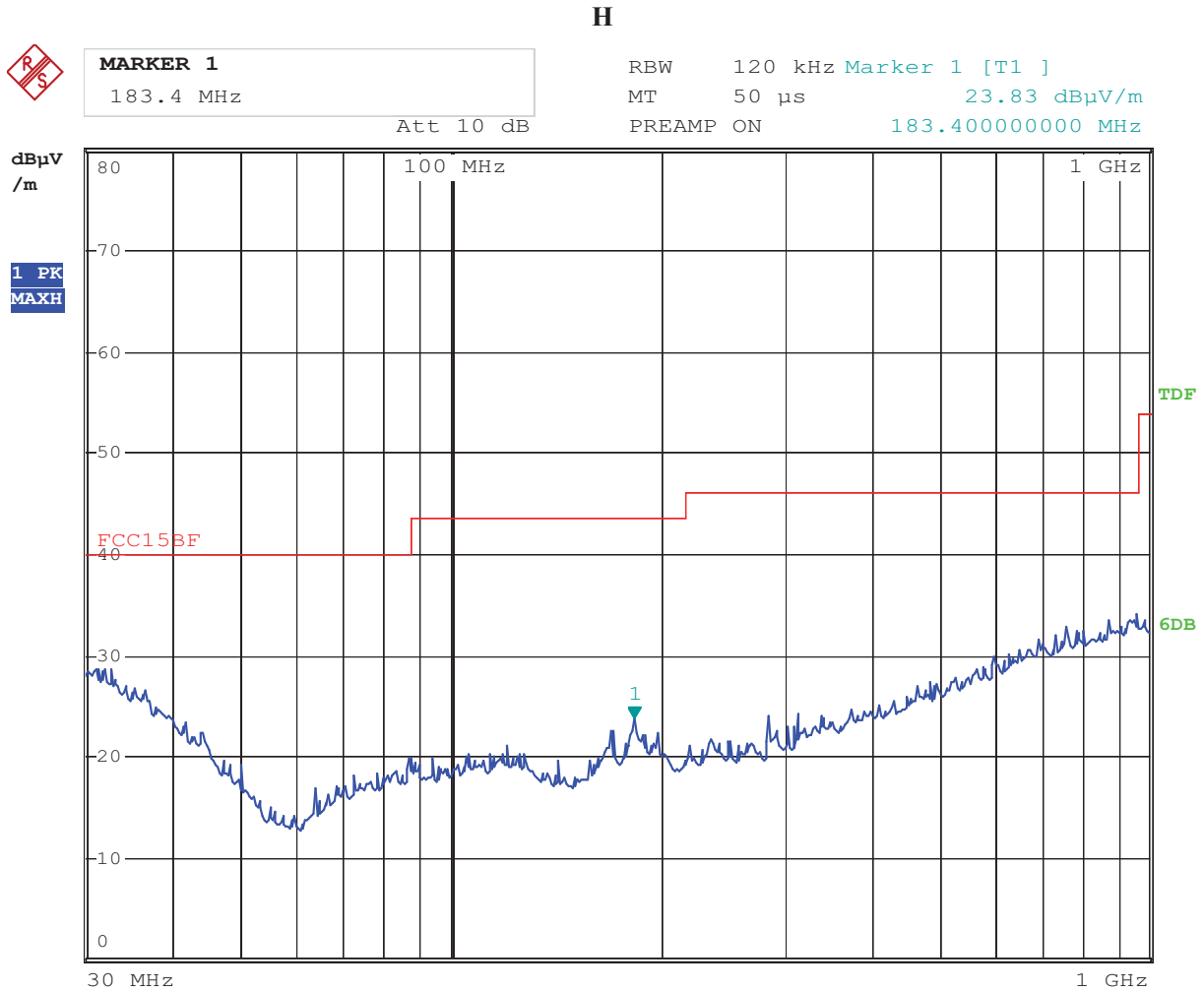

Date: 7.APR.2015 15:05:16

The report refers only to the sample tested and does not apply to the bulk.
 This report is issued in confidence to the client and it will be strictly treated as such by the SHENZHEN TIMEWAY TESTING LABORATORIES. It may not be reproduced rather in its entirety or in part and it may not be used for advertising. The client to whom the report is issued may, however, show or send it, or a certified copy thereof prepared by the SHENZHEN TIMEWAY TESTING LABORATORIES, to his customer. Supplier or others persons directly concerned. SHENZHEN TIMEWAY TESTING LABORATORIES, will not, without the consent of the client enter into any discussion of correspondence with any third party concerning the contents of the report.
 In the event of the improper use of the report. The SHENZHEN TIMEWAY TESTING LABORATORIES, reserves the rights to withdraw it and to adopt any other remedies which may be appropriate.



Test Figure:

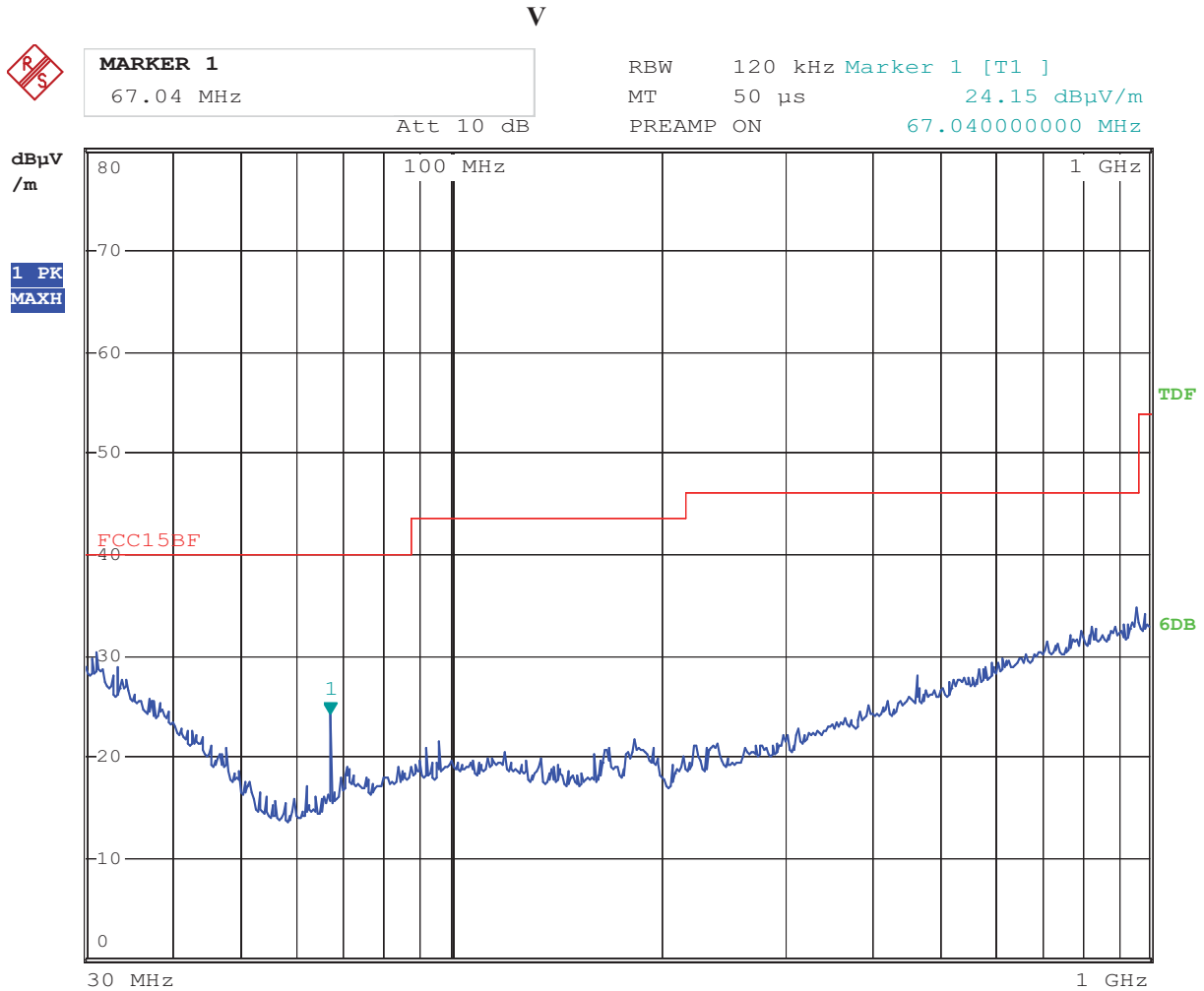

Date: 7.APR.2015 15:07:48

The report refers only to the sample tested and does not apply to the bulk.
 This report is issued in confidence to the client and it will be strictly treated as such by the SHENZHEN TIMEWAY TESTING LABORATORIES. It may not be reproduced rather in its entirety or in part and it may not be used for advertising. The client to whom the report is issued may, however, show or send it, or a certified copy thereof prepared by the SHENZHEN TIMEWAY TESTING LABORATORIES, to his customer. Supplier or others persons directly concerned. SHENZHEN TIMEWAY TESTING LABORATORIES, will not, without the consent of the client enter into any discussion of correspondence with any third party concerning the contents of the report.
 In the event of the improper use of the report. The SHENZHEN TIMEWAY TESTING LABORATORIES, reserves the rights to withdraw it and to adopt any other remedies which may be appropriate.



Radiated Disturbance (1000MHz----5000MHz)

EUT Operating Environment

Temperature: 25°C Humidity: 75%RH Atmospheric Pressure: 101 KPa

EUT set Condition: Receiving Mode

Equipment Level: Class B

Results: Pass

Please refer to following diagram for individual

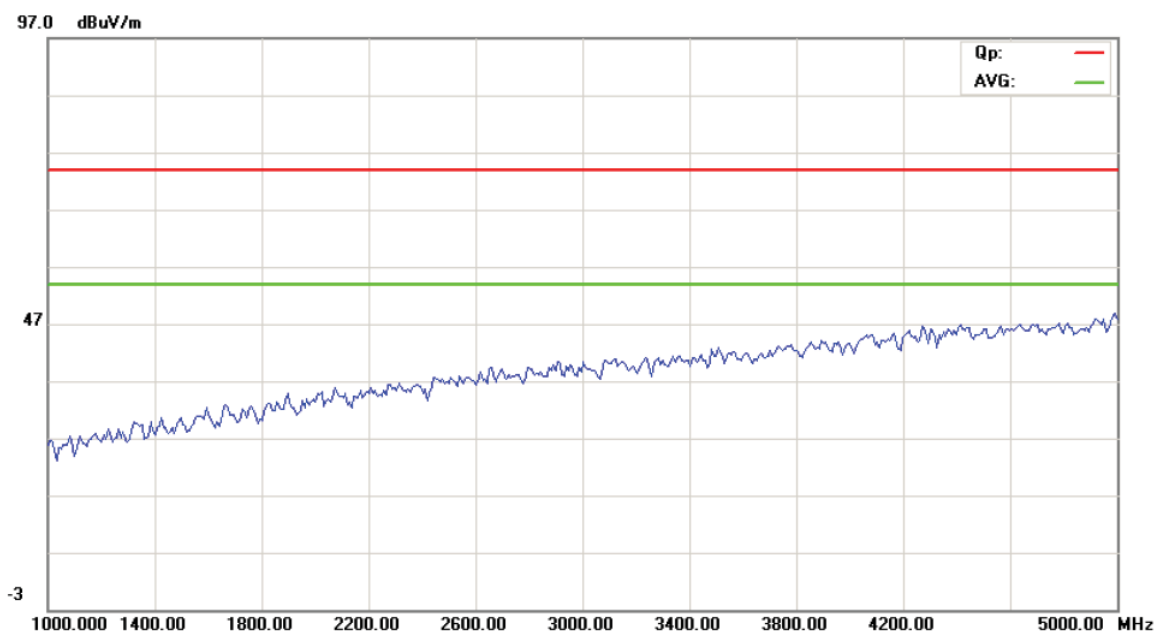

Frequency (MHz)	Level@3m (dBμV/m)	Antenna Polarity	Limit@3m (dBμV/m)
--	--	H	54(AV)

Note: Blue curve is Pk scan result , Pk value is lower than AV limit

The report refers only to the sample tested and does not apply to the bulk.
 This report is issued in confidence to the client and it will be strictly treated as such by the SHENZHEN TIMEWAY TESTING LABORATORIES. It may not be reproduced rather in its entirety or in part and it may not be used for advertising. The client to whom the report is issued may, however, show or send it . or a certified copy there of prepared by the SHENZHEN TIMEWAY TESTING LABORATORIES. to his customer. Supplier or others persons directly concerned. SHENZHEN TIMEWAY TESTING LABORATORIES. will not, without the consent of the client enter into any discussion of correspondence with any third party concerning the contents of the report.
 In the event of the improper use of the report. The SHENZHEN TIMEWAY TESTING LABORATORIES. reserves the rights to withdraw it and to adopt any other remedies which may be appropriate.



Radiated Disturbance (1000MHz----5000MHz)

EUT Operating Environment

Temperature:25°C Humidity: 75%RH Atmospheric Pressure: 101 KPa

EUT set Condition: Receiving Mode

Equipment Level: Class B

Results: Pass

Please refer to following diagram for individual

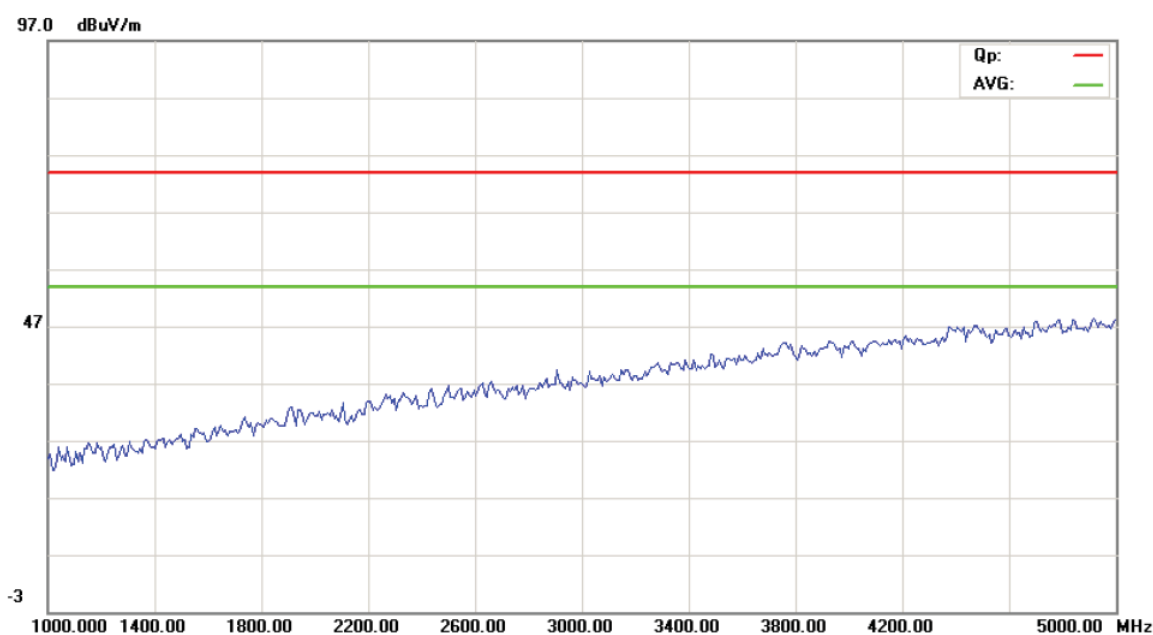

Frequency (MHz)	Level@3m (dBμV/m)	Antenna Polarity	Limit@3m (dBμV/m)
--	--	V	54(AV)

Note: Blue curve is Pk scan result , Pk value is lower than AV limit

The report refers only to the sample tested and does not apply to the bulk.
 This report is issued in confidence to the client and it will be strictly treated as such by the SHENZHEN TIMEWAY TESTING LABORATORIES. It may not be reproduced rather in its entirety or in part and it may not be used for advertising. The client to whom the report is issued may, however, show or send it . or a certified copy there of prepared by the SHENZHEN TIMEWAY TESTING LABORATORIES. to his customer. Supplier or others persons directly concerned. SHENZHEN TIMEWAY TESTING LABORATORIES. will not, without the consent of the client enter into any discussion of correspondence with any third party concerning the contents of the report.
 In the event of the improper use of the report. The SHENZHEN TIMEWAY TESTING LABORATORIES. reserves the rights to withdraw it and to adopt any other remedies which may be appropriate.

6.0 FCC ID Label

FCC ID: RGB-52BVDS

The label must not be a stick-on paper label. The label on these products must be permanently affixed to the product and readily visible at the time of purchase and must last the expected lifetime of the equipment not be readily detachable.

Mark Location:



The report refers only to the sample tested and does not apply to the bulk.

This report is issued in confidence to the client and it will be strictly treated as such by the SHENZHEN TIMEWAY TESTING LABORATORIES. It may not be reproduced rather in its entirety or in part and it may not be used for advertising. The client to whom the report is issued may, however, show or send it, or a certified copy thereof prepared by the SHENZHEN TIMEWAY TESTING LABORATORIES, to his customer, supplier or others persons directly concerned. SHENZHEN TIMEWAY TESTING LABORATORIES, will not, without the consent of the client enter into any discussion of correspondence with any third party concerning the contents of the report.

In the event of the improper use of the report, the SHENZHEN TIMEWAY TESTING LABORATORIES, reserves the rights to withdraw it and to adopt any other remedies which may be appropriate.

7.0 Photo of testing

7.1 Conducted test View--



The report refers only to the sample tested and does not apply to the bulk.

This report is issued in confidence to the client and it will be strictly treated as such by the SHENZHEN TIMEWAY TESTING LABORATORIES. It may not be reproduced rather in its entirety or in part and it may not be used for advertising. The client to whom the report is issued may, however, show or send it . or a certified copy there of prepared by the SHENZHEN TIMEWAY TESTING LABORATORIES. to his customer. Supplier or others persons directly concerned. SHENZHEN TIMEWAY TESTING LABORATORIES. will not, without the consent of the client enter into any discussion of correspondence with any third party concerning the contents of the report.

In the event of the improper use of the report. The SHENZHEN TIMEWAY TESTING LABORATORIES. reserves the rights to withdraw it and to adopt any other remedies which may be appropriate.

7.2 Radiated emission test view--



The report refers only to the sample tested and does not apply to the bulk.

This report is issued in confidence to the client and it will be strictly treated as such by the SHENZHEN TIMEWAY TESTING LABORATORIES. It may not be reproduced rather in its entirety or in part and it may not be used for advertising. The client to whom the report is issued may, however, show or send it, or a certified copy thereof prepared by the SHENZHEN TIMEWAY TESTING LABORATORIES, to his customer, supplier or other persons directly concerned. SHENZHEN TIMEWAY TESTING LABORATORIES, will not, without the consent of the client enter into any discussion of correspondence with any third party concerning the contents of the report.

In the event of the improper use of the report, the SHENZHEN TIMEWAY TESTING LABORATORIES, reserves the rights to withdraw it and to adopt any other remedies which may be appropriate.

Photo for the EUT



The report refers only to the sample tested and does not apply to the bulk.

This report is issued in confidence to the client and it will be strictly treated as such by the SHENZHEN TIMEWAY TESTING LABORATORIES. It may not be reproduced rather in its entirety or in part and it may not be used for advertising. The client to whom the report is issued may, however, show or send it, or a certified copy thereof prepared by the SHENZHEN TIMEWAY TESTING LABORATORIES, to his customer, supplier or other persons directly concerned. SHENZHEN TIMEWAY TESTING LABORATORIES will not, without the consent of the client enter into any discussion of correspondence with any third party concerning the contents of the report.

In the event of the improper use of the report, the SHENZHEN TIMEWAY TESTING LABORATORIES reserves the rights to withdraw it and to adopt any other remedies which may be appropriate.

Photo for the EUT



The report refers only to the sample tested and does not apply to the bulk.

This report is issued in confidence to the client and it will be strictly treated as such by the SHENZHEN TIMEWAY TESTING LABORATORIES. It may not be reproduced rather in its entirety or in part and it may not be used for advertising. The client to whom the report is issued may, however, show or send it, or a certified copy thereof prepared by the SHENZHEN TIMEWAY TESTING LABORATORIES, to his customer, supplier or other persons directly concerned. SHENZHEN TIMEWAY TESTING LABORATORIES will not, without the consent of the client enter into any discussion of correspondence with any third party concerning the contents of the report.

In the event of the improper use of the report, the SHENZHEN TIMEWAY TESTING LABORATORIES reserves the rights to withdraw it and to adopt any other remedies which may be appropriate.

Photo for the EUT

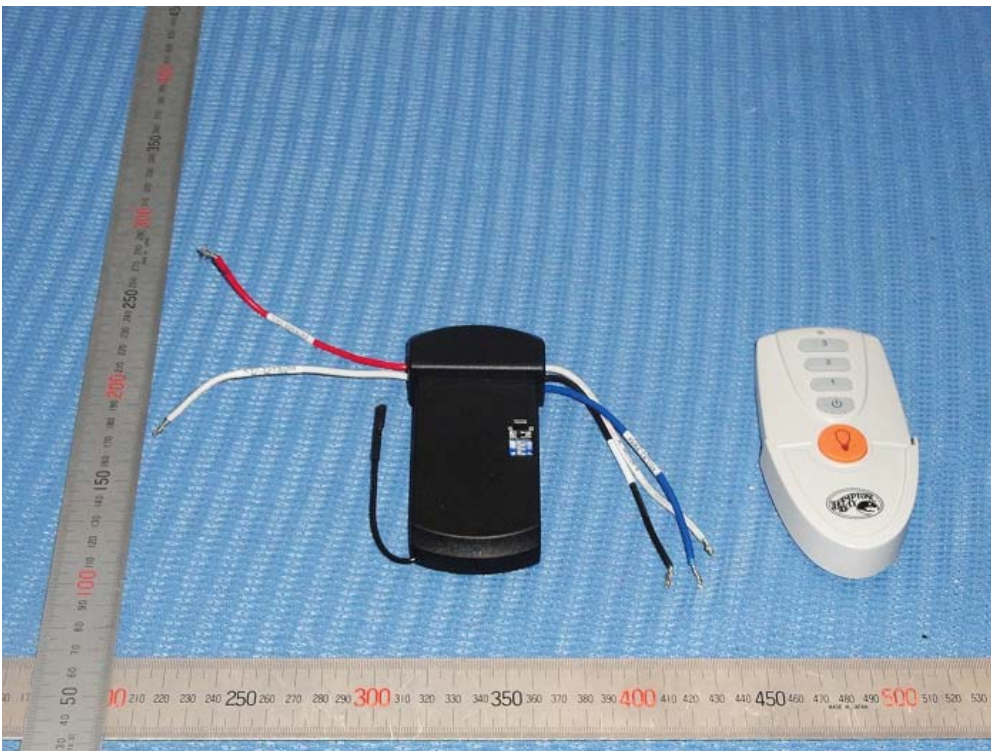

The report refers only to the sample tested and does not apply to the bulk.

This report is issued in confidence to the client and it will be strictly treated as such by the SHENZHEN TIMEWAY TESTING LABORATORIES. It may not be reproduced rather in its entirety or in part and it may not be used for advertising. The client to whom the report is issued may, however, show or send it, or a certified copy thereof prepared by the SHENZHEN TIMEWAY TESTING LABORATORIES, to his customer, supplier or other persons directly concerned. SHENZHEN TIMEWAY TESTING LABORATORIES will not, without the consent of the client enter into any discussion of correspondence with any third party concerning the contents of the report.

In the event of the improper use of the report, the SHENZHEN TIMEWAY TESTING LABORATORIES reserves the rights to withdraw it and to adopt any other remedies which may be appropriate.

Photo for the EUT

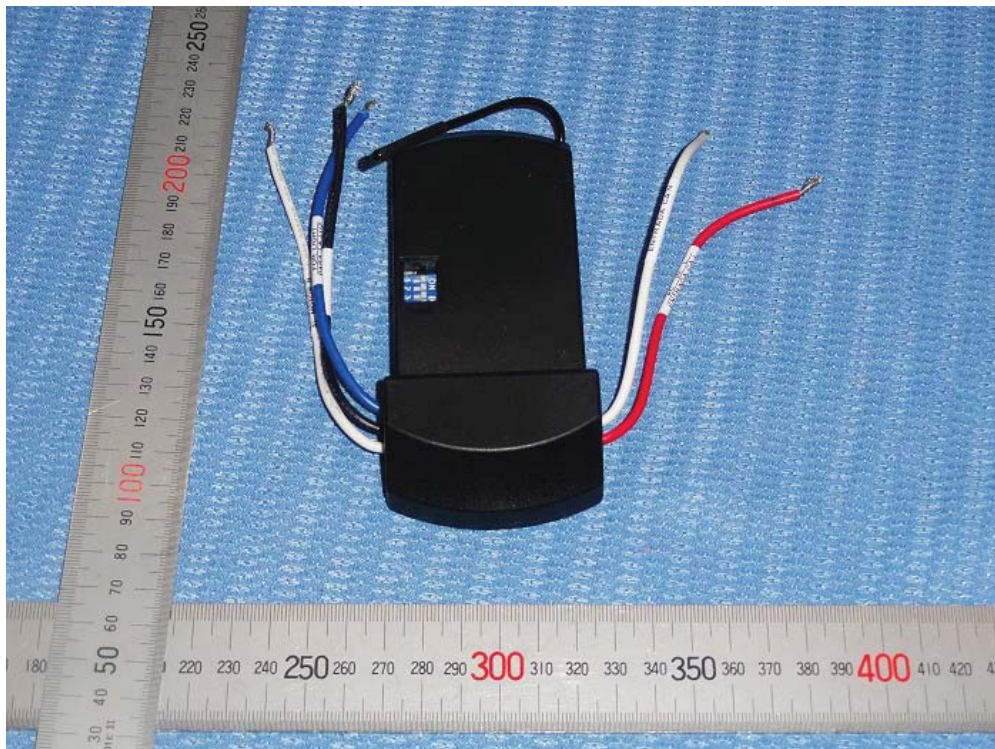
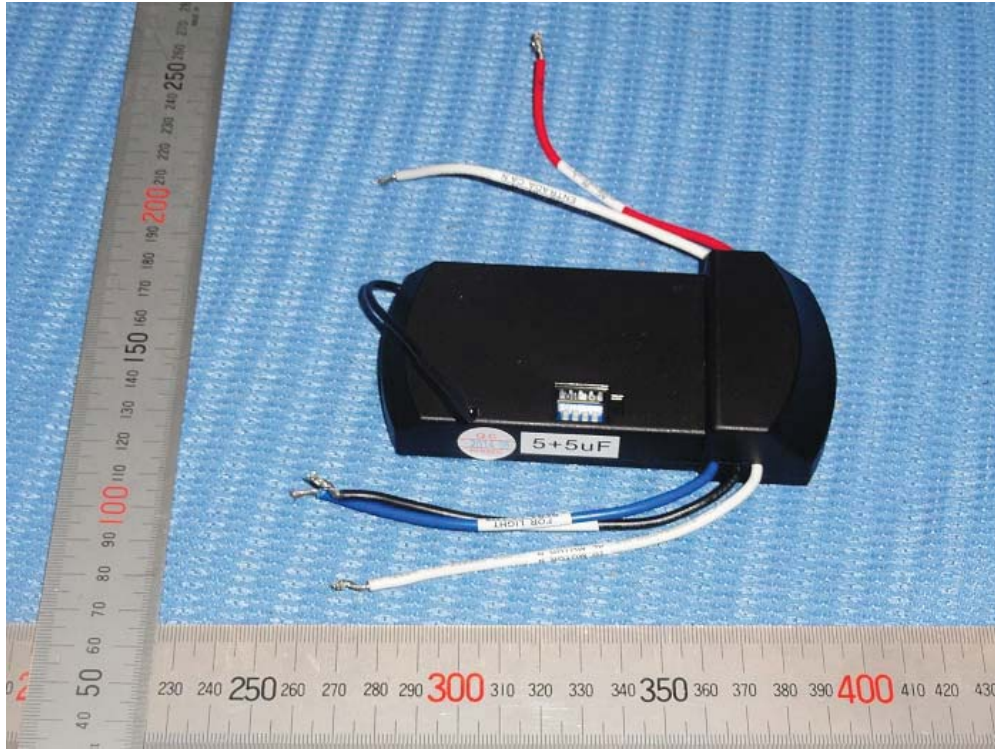

The report refers only to the sample tested and does not apply to the bulk.

This report is issued in confidence to the client and it will be strictly treated as such by the SHENZHEN TIMEWAY TESTING LABORATORIES. It may not be reproduced rather in its entirety or in part and it may not be used for advertising. The client to whom the report is issued may, however, show or send it, or a certified copy thereof prepared by the SHENZHEN TIMEWAY TESTING LABORATORIES, to his customer, supplier or other persons directly concerned. SHENZHEN TIMEWAY TESTING LABORATORIES, will not, without the consent of the client enter into any discussion of correspondence with any third party concerning the contents of the report.

In the event of the improper use of the report, the SHENZHEN TIMEWAY TESTING LABORATORIES, reserves the rights to withdraw it and to adopt any other remedies which may be appropriate.

Photo for the EUT



The report refers only to the sample tested and does not apply to the bulk.

This report is issued in confidence to the client and it will be strictly treated as such by the SHENZHEN TIMEWAY TESTING LABORATORIES. It may not be reproduced rather in its entirety or in part and it may not be used for advertising. The client to whom the report is issued may, however, show or send it, or a certified copy thereof prepared by the SHENZHEN TIMEWAY TESTING LABORATORIES, to his customer, supplier or other persons directly concerned. SHENZHEN TIMEWAY TESTING LABORATORIES will not, without the consent of the client enter into any discussion of correspondence with any third party concerning the contents of the report.

In the event of the improper use of the report, the SHENZHEN TIMEWAY TESTING LABORATORIES reserves the rights to withdraw it and to adopt any other remedies which may be appropriate.

Photo for the EUT

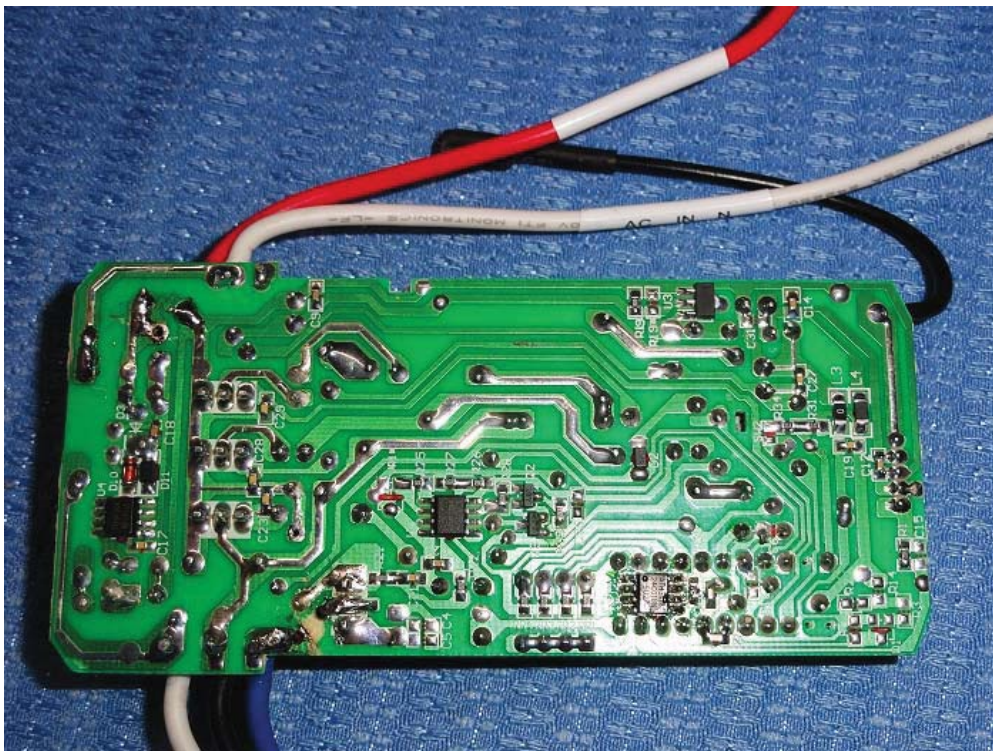

The report refers only to the sample tested and does not apply to the bulk.

This report is issued in confidence to the client and it will be strictly treated as such by the SHENZHEN TIMEWAY TESTING LABORATORIES. It may not be reproduced rather in its entirety or in part and it may not be used for advertising. The client to whom the report is issued may, however, show or send it, or a certified copy thereof prepared by the SHENZHEN TIMEWAY TESTING LABORATORIES, to his customer, supplier or other persons directly concerned. SHENZHEN TIMEWAY TESTING LABORATORIES, will not, without the consent of the client enter into any discussion of correspondence with any third party concerning the contents of the report.

In the event of the improper use of the report, the SHENZHEN TIMEWAY TESTING LABORATORIES, reserves the rights to withdraw it and to adopt any other remedies which may be appropriate.

Photo for the EUT

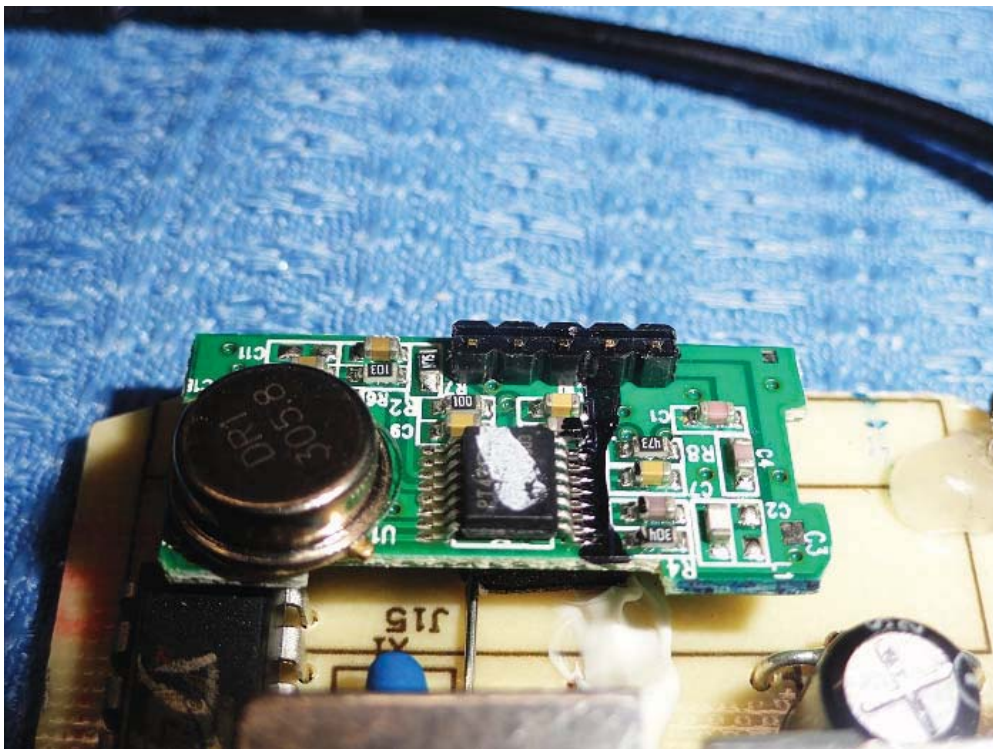

The report refers only to the sample tested and does not apply to the bulk.

This report is issued in confidence to the client and it will be strictly treated as such by the SHENZHEN TIMEWAY TESTING LABORATORIES. It may not be reproduced rather in its entirety or in part and it may not be used for advertising. The client to whom the report is issued may, however, show or send it, or a certified copy thereof prepared by the SHENZHEN TIMEWAY TESTING LABORATORIES, to his customer, supplier or other persons directly concerned. SHENZHEN TIMEWAY TESTING LABORATORIES, will not, without the consent of the client enter into any discussion of correspondence with any third party concerning the contents of the report.

In the event of the improper use of the report, the SHENZHEN TIMEWAY TESTING LABORATORIES, reserves the rights to withdraw it and to adopt any other remedies which may be appropriate.

Photo for the EUT

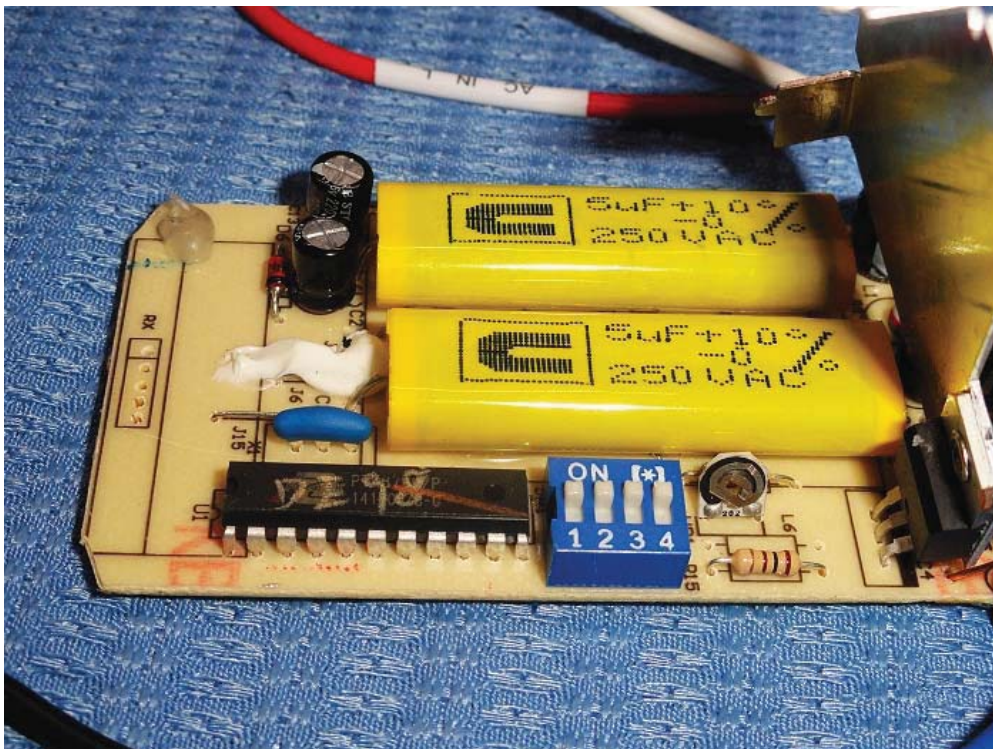
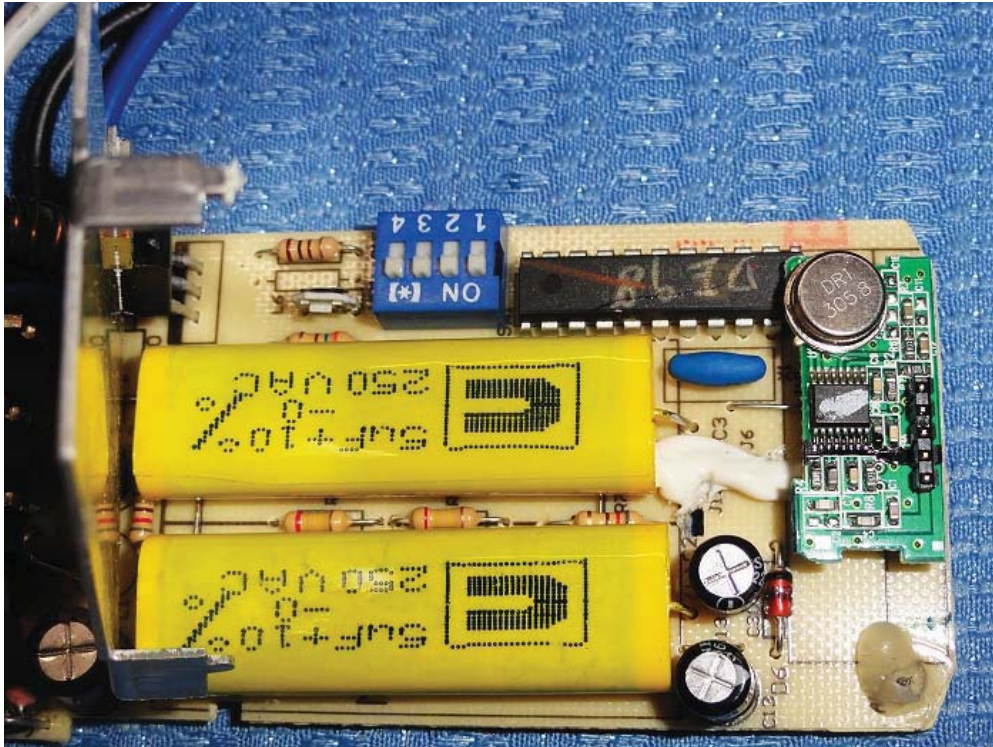

The report refers only to the sample tested and does not apply to the bulk.

This report is issued in confidence to the client and it will be strictly treated as such by the SHENZHEN TIMEWAY TESTING LABORATORIES. It may not be reproduced rather in its entirety or in part and it may not be used for advertising. The client to whom the report is issued may, however, show or send it, or a certified copy thereof prepared by the SHENZHEN TIMEWAY TESTING LABORATORIES, to his customer, supplier or others persons directly concerned. SHENZHEN TIMEWAY TESTING LABORATORIES, will not, without the consent of the client enter into any discussion of correspondence with any third party concerning the contents of the report.

In the event of the improper use of the report, The SHENZHEN TIMEWAY TESTING LABORATORIES, reserves the rights to withdraw it and to adopt any other remedies which may be appropriate.

Photo for the EUT

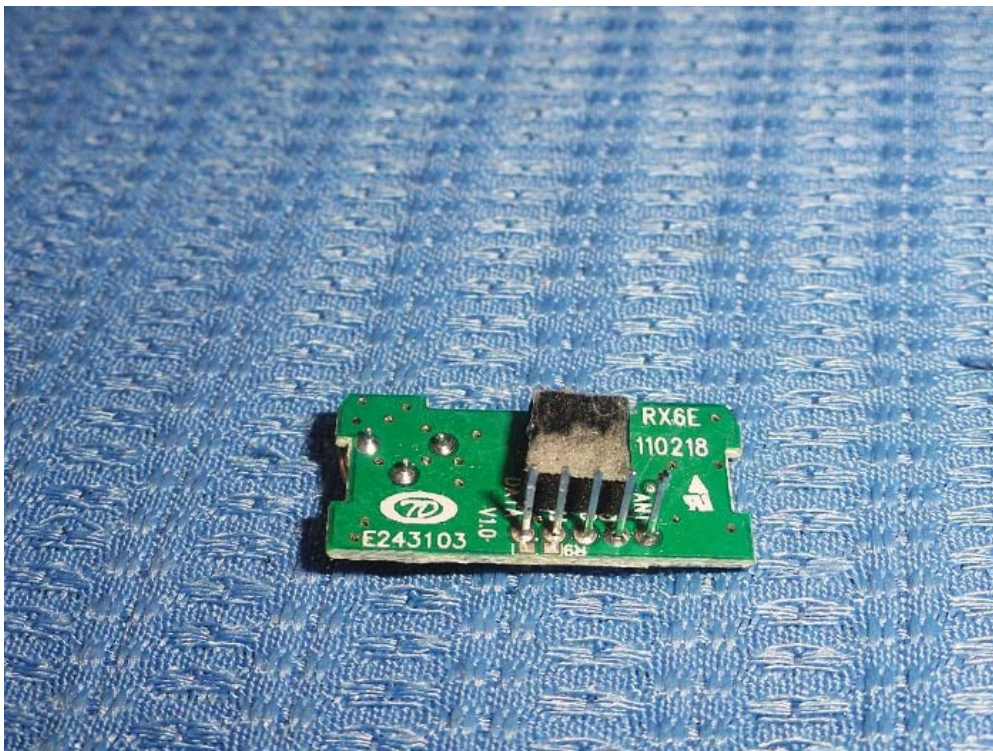
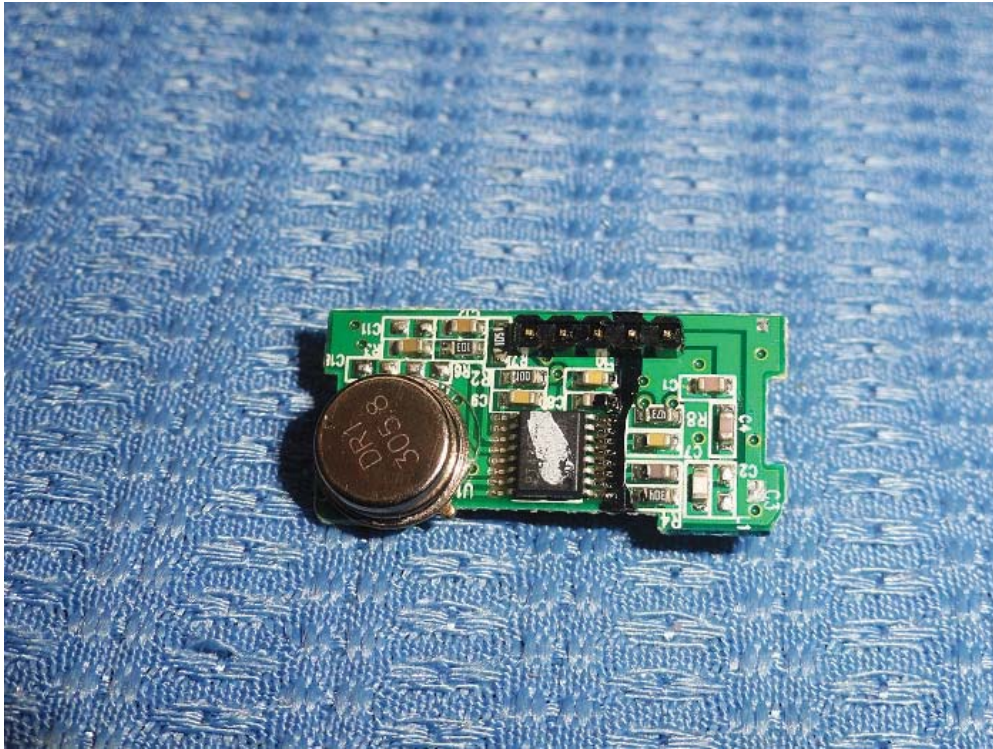

The report refers only to the sample tested and does not apply to the bulk.

This report is issued in confidence to the client and it will be strictly treated as such by the SHENZHEN TIMEWAY TESTING LABORATORIES. It may not be reproduced rather in its entirety or in part and it may not be used for advertising. The client to whom the report is issued may, however, show or send it . or a certified copy there of prepared by the SHENZHEN TIMEWAY TESTING LABORATORIES. to his customer. Supplier or others persons directly concerned. SHENZHEN TIMEWAY TESTING LABORATORIES. will not, without the consent of the client enter into any discussion of correspondence with any third party concerning the contents of the report.

In the event of the improper use of the report. The SHENZHEN TIMEWAY TESTING LABORATORIES. reserves the rights to withdraw it and to adopt any other remedies which may be appropriate.

Photo for the EUT

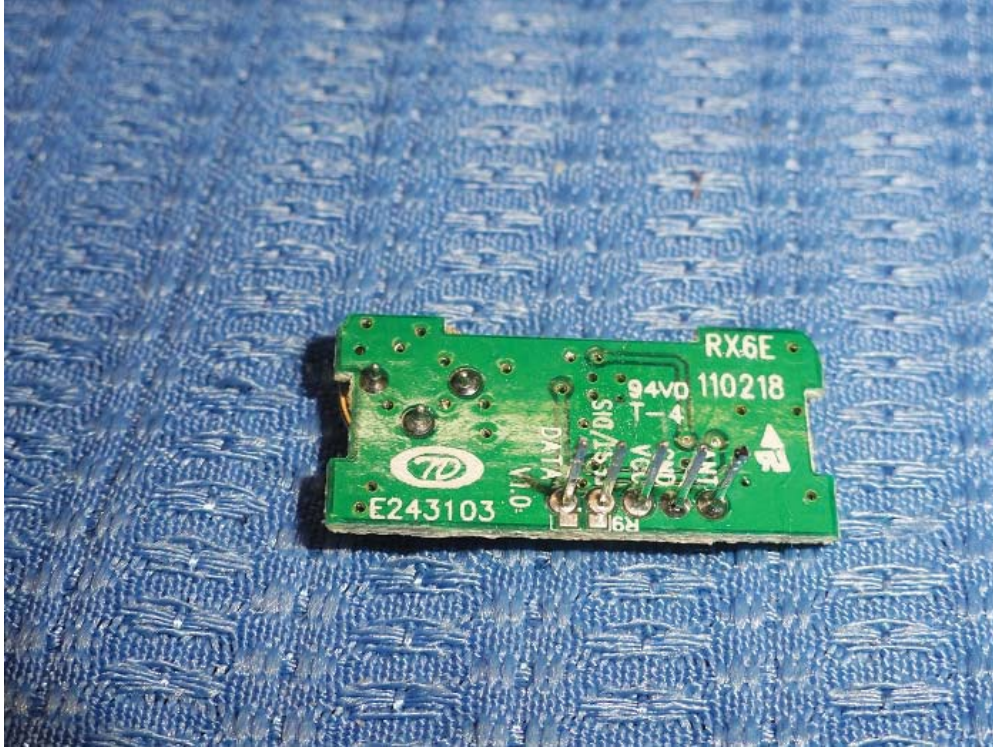

-End of the report-

The report refers only to the sample tested and does not apply to the bulk.

This report is issued in confidence to the client and it will be strictly treated as such by the SHENZHEN TIMEWAY TESTING LABORATORIES. It may not be reproduced rather in its entirety or in part and it may not be used for advertising. The client to whom the report is issued may, however, show or send it . or a certified copy there of prepared by the SHENZHEN TIMEWAY TESTING LABORATORIES. to his customer. Supplier or others persons directly concerned. SHENZHEN TIMEWAY TESTING LABORATORIES. will not, without the consent of the client enter into any discussion of correspondence with any third party concerning the contents of the report.

In the event of the improper use of the report. The SHENZHEN TIMEWAY TESTING LABORATORIES. reserves the rights to withdraw it and to adopt any other remedies which may be appropriate.