

TECHNICAL REPORT



Report No.: FCC1907179
File reference No.: 2019-07-17

Applicant: King of Fans, Inc.

Product: 52" Bentoyga

Model No: 52-BENT

Trademark: Home Decorators Collection

Test Standards: FCC Part 15 Subpart B

Test result: It is herewith confirmed and found to comply with the requirements set up by ANSI C63.4&FCC Part 15 regulations for the evaluation of electromagnetic compatibility

Approved By

Jack Chung

Jack Chung

Manager

Dated: July 17, 2019

Results appearing herein relate only to the sample tested

The technical reports is issued errors and omissions exempt and is subject to withdrawal at

SHENZHEN TIMEWAY TESTING LABORATORIES

Zone C, 1st Floor, Block B, Jun Xiang Da Building, Zhongshan Park Road West, Tong Le Village, Nanshan District, Shenzhen, China

Tel (755) 83448688, Fax (755) 83442996, E-Mail:info@timeway-lab.com



Special Statement:

The testing quality ability of our laboratory meet with "Quality Law of People's Republic of China" Clause 19.

The testing quality system of our laboratory meet with ISO/IEC-17025 requirements, which is approved by CNAS. This approval result is accepted by MRA of APLAC.

Our test facility is recognized, certified, or accredited by the following organizations:

CNAS-LAB Code: L2292

The EMC Laboratory has been assessed and in compliance with CNAS-CL01 accreditation criteria for testing Laboratories (identical to ISO/IEC 17025:2005 General Requirements) for the Competence of testing Laboratories.

FCC-Registration No.: 744189

The EMC Laboratory has been registered and fully described in a report filed with the (FCC) Federal Communications commission. The acceptance letter from the FCC is maintained in our files. Registration No.: 744189.

Industry Canada (IC) —Registration No.:5205A-2

The EMC Laboratory has been registered by Certification and Engineering Bureau of Industry Canada for radio equipment testing with Registration No.: 5205A-2.

A2LA (Certification Number:5013.01)

The EMC Laboratory has been accredited by the American Association for Laboratory Accreditation (A2LA). Certification Number:5013.01

The report refers only to the sample tested and does not apply to the bulk.

This report is issued in confidence to the client and it will be strictly treated as such by the SHENZHEN TIMEWAY TESTING LABORATORIES. It may not be reproduced rather in its entirety or in part and it may not be used for adverting. The client to whom the report is issued may, however, show or send it . or a certified copy there of prepared by the SHENZHEN TIMEWAY TESTING LABORATORIES. to his customer. Supplier or others persons directly concerned. SHENZHEN TIMEWAY TESTING LABORATORIES. will not, without the consent of the client enter into any discussion of correspondence with any third party concerning the contents of the report.

In the event of the improper use of the report. The SHENZHEN TIMEWAY TESTING LABORATORIES. reserves the rights to withdraw it and to adopt any other remedies which may be appropriate.



Test Report Conclusion
Content

1.0	General Details	4
1.1	Test Lab Details.....	4
1.2	Applicant Details.....	4
1.3	Description of EUT	4
1.4	Test Uncertainty.....	4
1.5	Submitted Sample.....	4
1.6	Test Duration.....	4
2.0	List of Measurement Equipment	5
2.1	Conducted Emission Test.....	5
2.2	Radiated electromagnetic disturbance test.....	5
2.3	Auxiliary Equipment.....	5
3.0	Technical Details	6
3.1	Investigations Requested.....	6
3.2	Test Standards.....	6
4.0	Power line Conducted Emission Test	7
5.0	Radiated Disturbance Test	11
6.0	FCC Label	18
7.0	Photo of testing	19

The report refers only to the sample tested and does not apply to the bulk.

This report is issued in confidence to the client and it will be strictly treated as such by the SHENZHEN TIMEWAY TESTING LABORATORIES. It may not be reproduced rather in its entirety or in part and it may not be used for advertising. The client to whom the report is issued may, however, show or send it, or a certified copy thereof prepared by the SHENZHEN TIMEWAY TESTING LABORATORIES, to his customer. Supplier or others persons directly concerned. SHENZHEN TIMEWAY TESTING LABORATORIES, will not, without the consent of the client enter into any discussion of correspondence with any third party concerning the contents of the report.

In the event of the improper use of the report, The SHENZHEN TIMEWAY TESTING LABORATORIES, reserves the rights to withdraw it and to adopt any other remedies which may be appropriate.



1.0 General Details

1.1 Test Lab Details

Name : SHENZHEN TIMEWAY TESTING LABORATORIES.
Address: Zone C, 1st Floor, Block B, Jun Xiang Da Building, Zhongshan Park Road
West, Tong Le Village, Nanshan District, Shenzhen, China
Telephone: (755) 83448688
Fax: (755) 83442996
Site on File with the Federal Communications Commission – United States
Registration Number: 744189
For 3m Anechoic Chamber

1.2 Applicant Details

Applicant: King of Fans, Inc.
Address: 1951 N.W. 22nd Street, Fort Lauderdale, FL33311, USA
Telephone: 954-484-7500
Fax: 954-784-7602

1.3 Description of EUT

Product: 52” Bentoyga
Manufacturer: Chienlun Industries (zhongshan) Ltd..
Address: Da Che Industrial Area, Nanlang Town, Zhongshan, Guangdong China 528451
Trademark: Home Decorators Collection
Model Number: 52-BENT
Rating: Input 120V, 60Hz, w/o light 0.5A, w/o light 65W; Output: w/light 0.82A, w/light 95W
Rx Frequency: 303.78MHz

1.4 Submitted Sample: 1 Samples

1.5 Test Duration: 2019-07-17 to 2019-07-17

1.6 Test Uncertainty

Conducted Emissions Uncertainty =3.6dB
Radiated Emissions below 1GHz Uncertainty =4.7dB
Radiated Emissions above 1GHz Uncertainty =6.0dB

1.7 Test Engineer

The sample tested by

A handwritten signature in black ink that reads "Terry Tang".

Print Name: Terry Tang



2.0 List of Measurement Equipment

2.1 Conducted Emission Test

Name	Model No.	Serial No.	Manufacturer	Calibration Date	Calibration Cycle
EMI Test Receiver	ESH3	860905/006	RS	2019.06.21	1Year
Spectrum Analyzer	ESA-L1500A	US37451154	HP	2019.06.21	1Year
PULSE LIMITER	ESH3-Z2	100281	RS	2019.06.21	1Year
LISN	ESH3-Z5	100294	RS	2019.06.21	1Year
LISN	ESH3-Z5	100253	RS	2019.06.21	1Year
LISN	NNB42	00012	SCHAFFNER	2019.01.08	1Year

2.2 Radiated electromagnetic disturbance test

Name	Model No.	Serial No.	Manufacturer	Calibration Date	Calibration Cycle
EMI Test Receiver	ESPI 3	100379	RS	2019.06.21	1Year
Amplifier	BBV9743	#218	Schwarzbeck	2019.06.21	1Year
Amplifier	8449B	3008A00160	HP	2019.06.21	1Year
Bilog Antenna	VULB9163	1139	Schwarzbeck	2019.07.04	1Year
Horn Antenna	BBHA 9120D	9120D-631	RS	2019.07.09	1Year
Spectrum	E4407B	MY50441392	Agilent	2019.03.27	1Year

2.3 Auxiliary Equipment

Name	Model No.	Serial No.	Manufacturer	Calibration Date	Calibration Cycle
--	--	--	--	--	--

The report refers only to the sample tested and does not apply to the bulk.

This report is issued in confidence to the client and it will be strictly treated as such by the SHENZHEN TIMEWAY TESTING LABORATORIES. It may not be reproduced rather in its entirety or in part and it may not be used for advertising. The client to whom the report is issued may, however, show or send it, or a certified copy thereof prepared by the SHENZHEN TIMEWAY TESTING LABORATORIES, to his customer. Supplier or others persons directly concerned. SHENZHEN TIMEWAY TESTING LABORATORIES, will not, without the consent of the client enter into any discussion of correspondence with any third party concerning the contents of the report.

In the event of the improper use of the report. The SHENZHEN TIMEWAY TESTING LABORATORIES, reserves the rights to withdraw it and to adopt any other remedies which may be appropriate.



3.0 Technical Details

3.1 Investigations Requested

Perform Electromagnetic Interference [EMI] tests for FCC Requirement.

3.2 Test Standards

FCC Part 15 Subpart B

The report refers only to the sample tested and does not apply to the bulk.

This report is issued in confidence to the client and it will be strictly treated as such by the SHENZHEN TIMEWAY TESTING LABORATORIES. It may not be reproduced rather in its entirety or in part and it may not be used for advertising. The client to whom the report is issued may, however, show or send it . or a certified copy there of prepared by the SHENZHEN TIMEWAY TESTING LABORATORIES. to his customer. Supplier or others persons directly concerned. SHENZHEN TIMEWAY TESTING LABORATORIES. will not, without the consent of the client enter into any discussion of correspondence with any third party concerning the contents of the report.

In the event of the improper use of the report. The SHENZHEN TIMEWAY TESTING LABORATORIES. reserves the rights to withdraw it and to adopt any other remedies which may be appropriate.



4.0 Conducted Power line Test

4.1 Schematics of the test

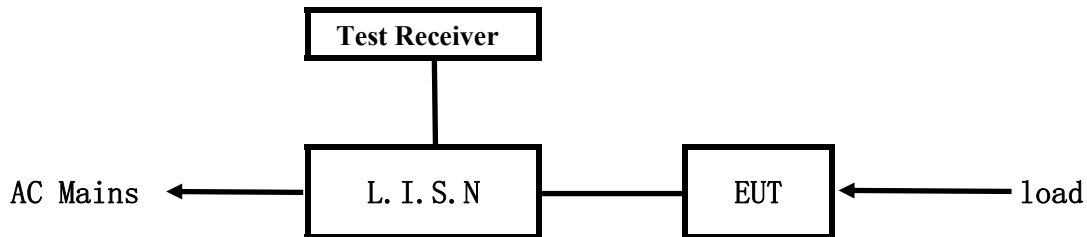

EUT: Equipment Under Test

4.2 Test Method and test Procedure

The EUT was tested according to ANSI C63.4-2014. The Frequency spectrum From 0.15MHz to 30MHz was investigated. The LISN used was 50ohm/50uH as specified by section 5.1 of ANSI C63.4-2014. Cables and peripherals were moved to find the maximum emission levels for each frequency.

Actual Working Voltage and Frequency: 120V~, 60Hz

Block diagram of Test setup

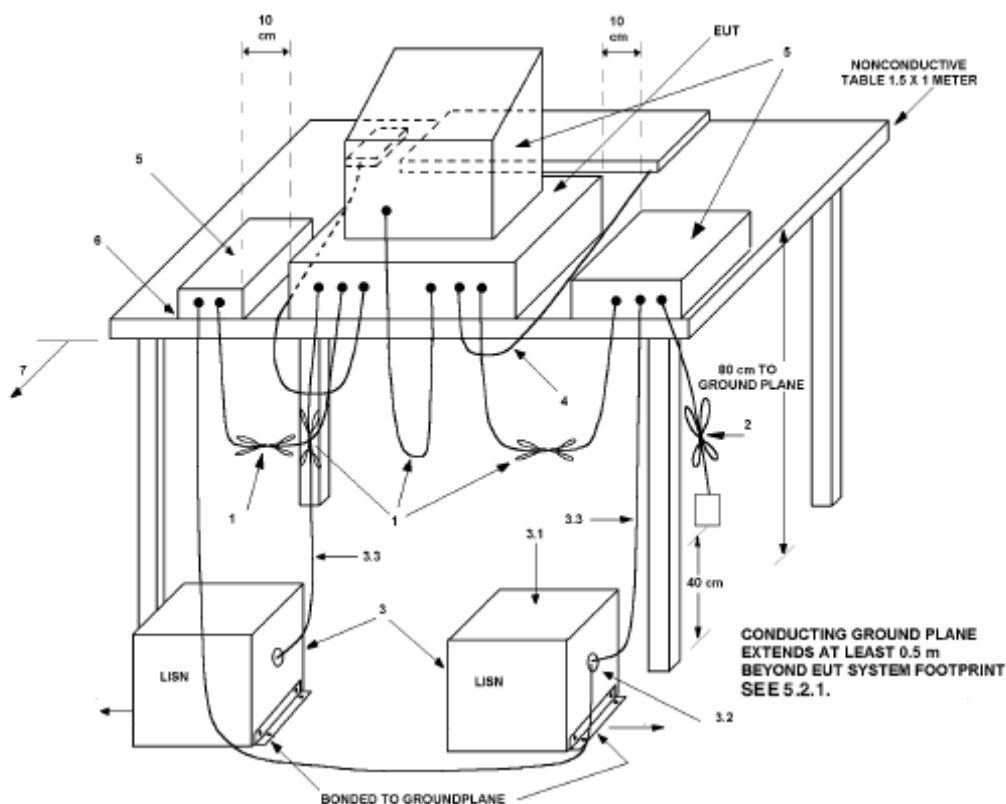

The report refers only to the sample tested and does not apply to the bulk.

This report is issued in confidence to the client and it will be strictly treated as such by the SHENZHEN TIMEWAY TESTING LABORATORIES. It may not be reproduced rather in its entirety or in part and it may not be used for advertising. The client to whom the report is issued may, however, show or send it, or a certified copy thereof prepared by the SHENZHEN TIMEWAY TESTING LABORATORIES, to his customer. Supplier or others persons directly concerned. SHENZHEN TIMEWAY TESTING LABORATORIES, will not, without the consent of the client enter into any discussion of correspondence with any third party concerning the contents of the report.

In the event of the improper use of the report. The SHENZHEN TIMEWAY TESTING LABORATORIES, reserves the rights to withdraw it and to adopt any other remedies which may be appropriate.



4.3 Power line conducted Emission Limit

Frequency(MHz)	Class A Limits dB(μV)		Class B Limits dB(μV)	
	Quasi-peak Level	Average Level	Quasi-peak Level	Average Level
0.15 ~ 0.50	79.00	66.00	66.00~56.00*	56.00~46.00*
0.50 ~ 5.00	76.00	60.00	56.00	46.00
5.00 ~ 30.00	73.00	60.00	60.00	50.00

- Notes:
1. *decreasing linearly with logarithm of frequency.
 2. The tighter limit shall apply at the transition frequencies

4.4 Test Results

The frequency spectrum from 0.15MHz to 30MHz was investigated. All reading are quasi-peak values with a resolution bandwidth of 9kHz.

The report refers only to the sample tested and does not apply to the bulk.
 This report is issued in confidence to the client and it will be strictly treated as such by the SHENZHEN TIMEWAY TESTING LABORATORIES. It may not be reproduced rather in its entirety or in part and it may not be used for advertizing. The client to whom the report is issued may, however, show or send it . or a certified copy there of prepared by the SHENZHEN TIMEWAY TESTING LABORATORIES. to his customer. Supplier or others persons directly concerned. SHENZHEN TIMEWAY TESTING LABORATORIES. will not, without the consent of the client enter into any discussion of correspondence with any third party concerning the contents of the report.
 In the event of the improper use of the report. The SHENZHEN TIMEWAY TESTING LABORATORIES. reserves the rights to withdraw it and to adopt any other remedies which may be appropriate.



A: Conducted Emission on Live Terminal (150kHz to 30MHz)

EUT Operating Environment

Temperature: 26°C Humidity: 65%RH Atmospheric Pressure: 101 kPa

EUT set Condition: Receiving Mode

Equipment Level: Class B

Results: PASS

Please refer to following diagram for individual

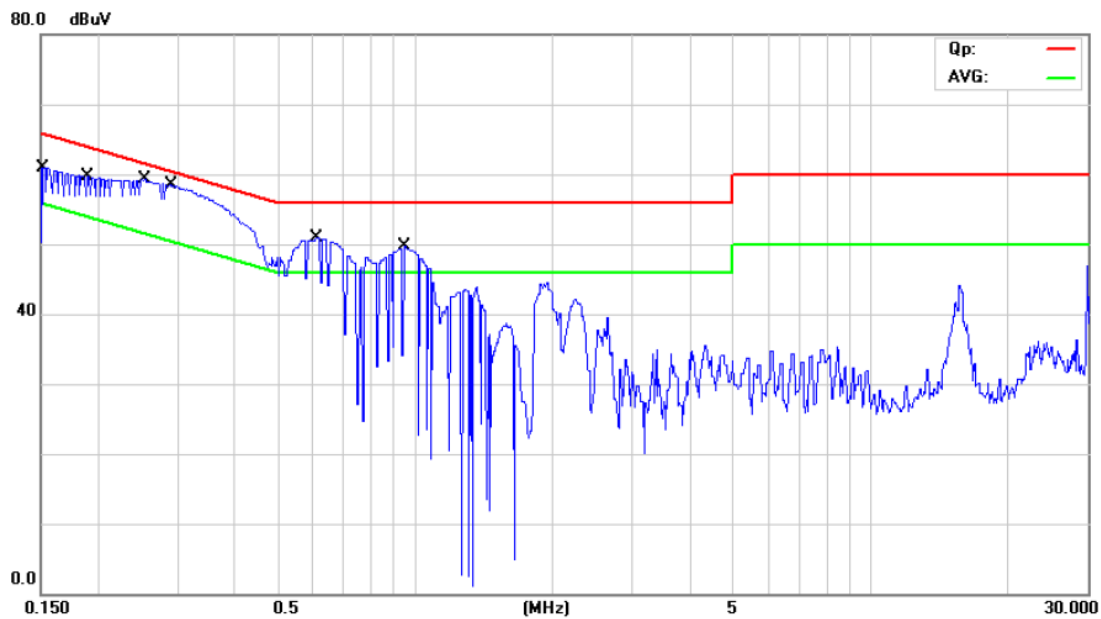

No.	Mk.	Freq. MHz	Reading Level dBuV	Correct Factor dB	Measure- ment dBuV	Limit dBuV	Over dB	Detector	Comment
1		0.1512	52.30	9.78	62.08	65.93	-3.85	QP	
2		0.1512	29.60	9.78	39.38	55.93	-16.55	AVG	
3		0.1910	50.90	9.76	60.66	63.99	-3.33	QP	
4		0.1910	25.10	9.76	34.86	53.99	-19.13	AVG	
5	*	0.2515	49.50	9.75	59.25	61.71	-2.46	QP	
6		0.2515	24.10	9.75	33.85	51.71	-17.86	AVG	
7		0.2897	48.00	9.76	57.76	60.53	-2.77	QP	
8		0.2897	23.70	9.76	33.46	50.53	-17.07	AVG	
9		0.6076	41.40	9.78	51.18	56.00	-4.82	QP	
10		0.6076	18.70	9.78	28.48	46.00	-17.52	AVG	
11		0.9400	36.70	9.79	46.49	56.00	-9.51	QP	
12		0.9400	18.30	9.79	28.09	46.00	-17.91	AVG	

The report refers only to the sample tested and does not apply to the bulk.

This report is issued in confidence to the client and it will be strictly treated as such by the SHENZHEN TIMEWAY TESTING LABORATORIES. It may not be reproduced rather in its entirety or in part and it may not be used for advertising. The client to whom the report is issued may, however, show or send it, or a certified copy thereof prepared by the SHENZHEN TIMEWAY TESTING LABORATORIES, to his customer. Supplier or others persons directly concerned. SHENZHEN TIMEWAY TESTING LABORATORIES, will not, without the consent of the client enter into any discussion of correspondence with any third party concerning the contents of the report.

In the event of the improper use of the report. The SHENZHEN TIMEWAY TESTING LABORATORIES, reserves the rights to withdraw it and to adopt any other remedies which may be appropriate.



B: Conducted Emission on Neutral Terminal (150kHz to 30MHz)

EUT Operating Environment

Temperature: 26°C Humidity: 65%RH Atmospheric Pressure: 101 kPa

EUT set Condition: Receiving Mode

Equipment Level: Class B

Results: Pass

Please refer to following diagram for individual

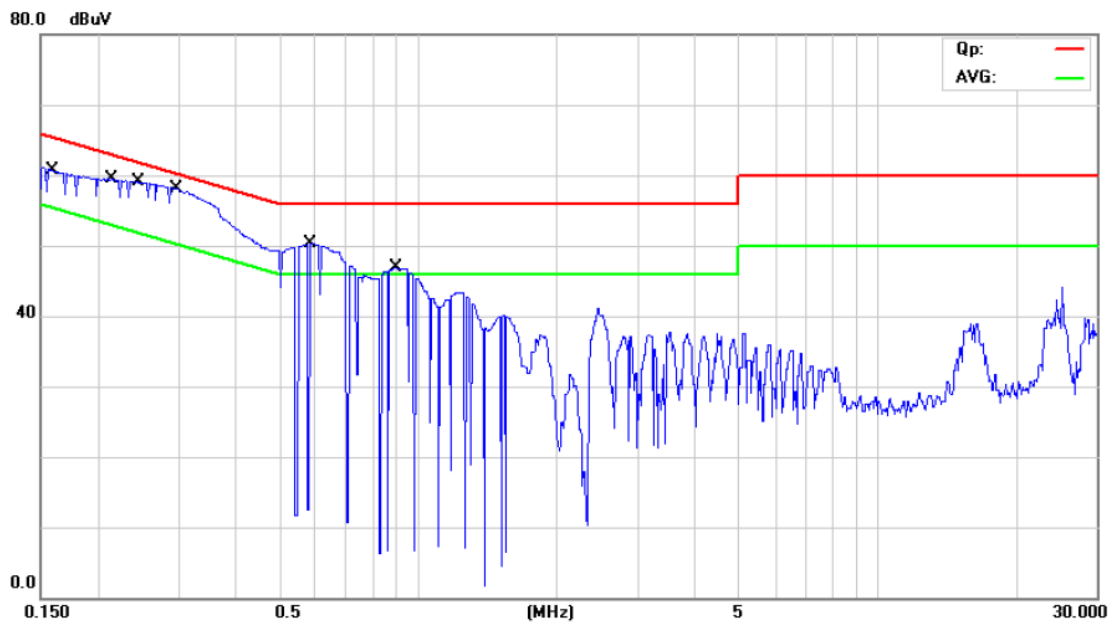

No.	Mk.	Freq.	Reading Level	Correct Factor	Measurement	Limit	Over	Detector	Comment
		MHz	dBuV	dB	dBuV	dBuV	dB		
1		0.1610	51.90	9.78	61.68	65.41	-3.73	QP	
2		0.1610	37.50	9.78	47.28	55.41	-8.13	AVG	
3		0.2143	50.90	9.75	60.65	63.04	-2.39	QP	
4		0.2143	33.50	9.75	43.25	53.04	-9.79	AVG	
5		0.2460	49.60	9.75	59.35	61.89	-2.54	QP	
6		0.2460	33.60	9.75	43.35	51.89	-8.54	AVG	
7	*	0.2952	48.50	9.76	58.26	60.38	-2.12	QP	
8		0.2952	33.40	9.76	43.16	50.38	-7.22	AVG	
9		0.5860	41.30	9.77	51.07	56.00	-4.93	QP	
10		0.5860	26.70	9.77	36.47	46.00	-9.53	AVG	
11		0.8991	36.60	9.79	46.39	56.00	-9.61	QP	
12		0.8991	-4.20	9.79	5.59	46.00	-40.41	AVG	

The report refers only to the sample tested and does not apply to the bulk.

This report is issued in confidence to the client and it will be strictly treated as such by the SHENZHEN TIMEWAY TESTING LABORATORIES. It may not be reproduced rather in its entirety or in part and it may not be used for advertising. The client to whom the report is issued may, however, show or send it, or a certified copy thereof prepared by the SHENZHEN TIMEWAY TESTING LABORATORIES, to his customer. Supplier or others persons directly concerned. SHENZHEN TIMEWAY TESTING LABORATORIES, will not, without the consent of the client enter into any discussion of correspondence with any third party concerning the contents of the report.

In the event of the improper use of the report. The SHENZHEN TIMEWAY TESTING LABORATORIES, reserves the rights to withdraw it and to adopt any other remedies which may be appropriate.



5.0 Radiated Disturbance Test

5.1 Schematics of the test

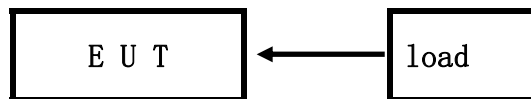

5.2 Test Method and test Procedure:

The EUT was tested according to ANSI C63.4 –2014; The frequency spectrum from 30MHz to 6GHz was investigated. All reading from 30MHz to 1GHz are quasi-peak values with a resolution bandwidth of 120kHz. For measurement above 1GHz, peak values with RBW=VBW=1MHz and PK detector. AV value with RBW=1MHz, VBW=10Hz and PK

Actual Working Voltage and Frequency: 120V~, 60Hz

Block diagram of Test setup

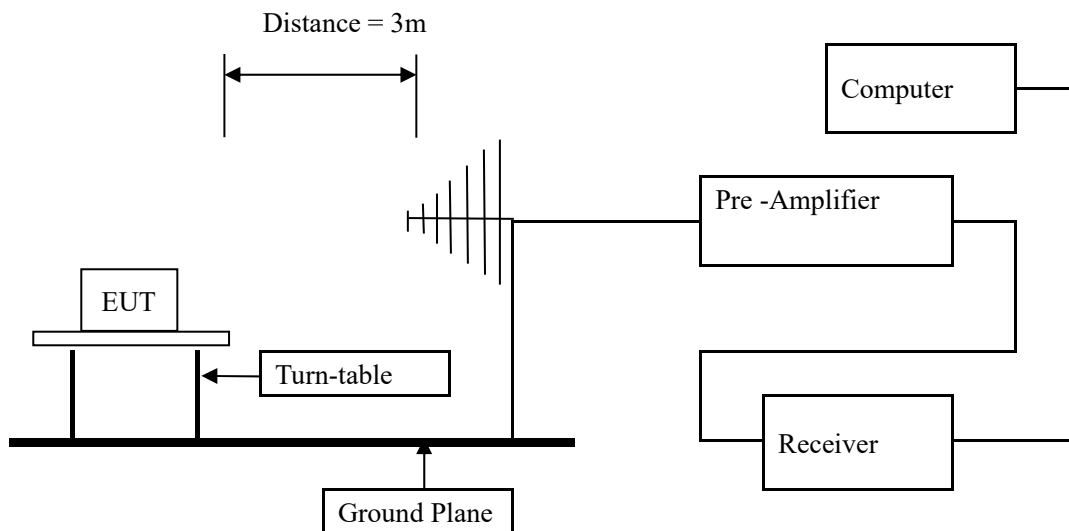

The report refers only to the sample tested and does not apply to the bulk.
This report is issued in confidence to the client and it will be strictly treated as such by the SHENZHEN TIMEWAY TESTING LABORATORIES. It may not be reproduced rather in its entirety or in part and it may not be used for advertising. The client to whom the report is issued may, however, show or send it, or a certified copy thereof prepared by the SHENZHEN TIMEWAY TESTING LABORATORIES, to his customer. Supplier or others persons directly concerned. SHENZHEN TIMEWAY TESTING LABORATORIES, will not, without the consent of the client enter into any discussion of correspondence with any third party concerning the contents of the report.
In the event of the improper use of the report. The SHENZHEN TIMEWAY TESTING LABORATORIES, reserves the rights to withdraw it and to adopt any other remedies which may be appropriate.

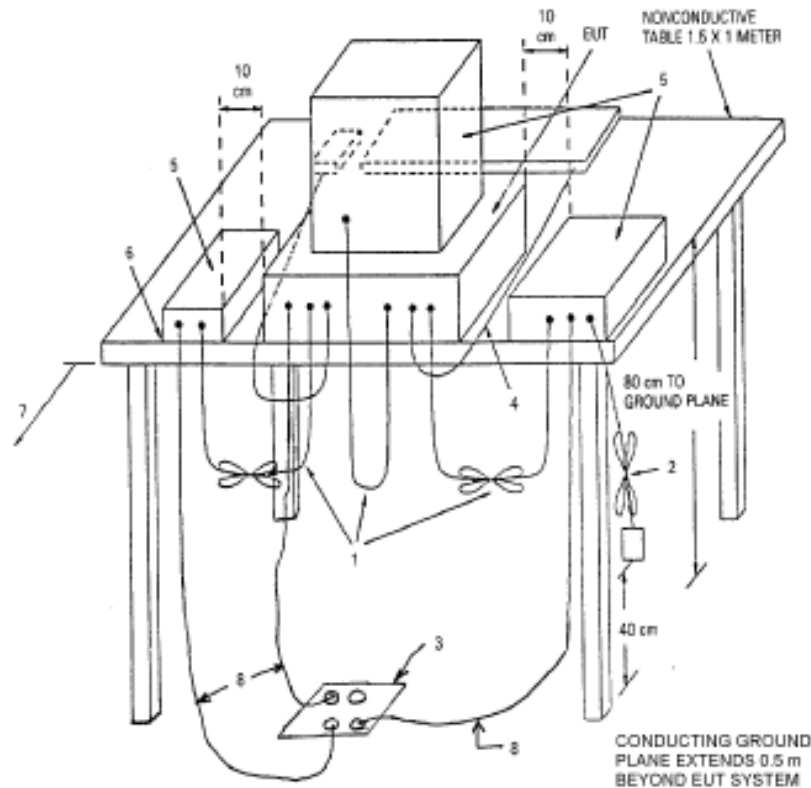

5.3 Radiated Emission Limit

Frequency Range (MHz)	Distance (m)	Field strength (dB μ V/m)
30-88	3	40.00
88-216	3	43.50
216-960	3	46.00
Above 960	3	54.00

Note: The lower limit shall apply at the transition frequencies

5.4 Test result

The frequency spectrum from 30MHz to 6GHz was investigated. All reading from 30MHz to 1GHz are quasi-peak values with a resolution bandwidth of 120kHz. For measurement above 1GHz, peak values with RBW=VBW=1MHz and PK detector. AV value with RBW=1MHz, VBW=10Hz and PK. Measurements were made at 3 meters.

The report refers only to the sample tested and does not apply to the bulk.

This report is issued in confidence to the client and it will be strictly treated as such by the SHENZHEN TIMEWAY TESTING LABORATORIES. It may not be reproduced in its entirety or in part and it may not be used for advertising. The client to whom the report is issued may, however, show or send it, or a certified copy thereof prepared by the SHENZHEN TIMEWAY TESTING LABORATORIES, to his customer, supplier or other persons directly concerned. SHENZHEN TIMEWAY TESTING LABORATORIES will not, without the consent of the client enter into any discussion of correspondence with any third party concerning the contents of the report.

In the event of the improper use of the report, the SHENZHEN TIMEWAY TESTING LABORATORIES reserves the rights to withdraw it and to adopt any other remedies which may be appropriate.



Test result

General Radiated Emission Data and Harmonics Radiated Emission Data

Radiated Emission In Horizontal/ In Vertical (30MHz----1000MHz)

EUT set Condition:	Receiving Mode
Equipment Level:	Class B
Results:	Pass

The report refers only to the sample tested and does not apply to the bulk.

This report is issued in confidence to the client and it will be strictly treated as such by the SHENZHEN TIMEWAY TESTING LABORATORIES. It may not be reproduced rather in its entirety or in part and it may not be used for advertizing. The client to whom the report is issued may, however, show or send it . or a certified copy there of prepared by the SHENZHEN TIMEWAY TESTING LABORATORIES. to his customer. Supplier or others persons directly concerned. SHENZHEN TIMEWAY TESTING LABORATORIES. will not, without the consent of the client enter into any discussion of correspondence with any third party concerning the contents of the report.

In the event of the improper use of the report. The SHENZHEN TIMEWAY TESTING LABORATORIES. reserves the rights to withdraw it and to adopt any other remedies which may be appropriate.



Test Figure:

H

FCC_FCC Part 15B Class B 30MHz-1GHz

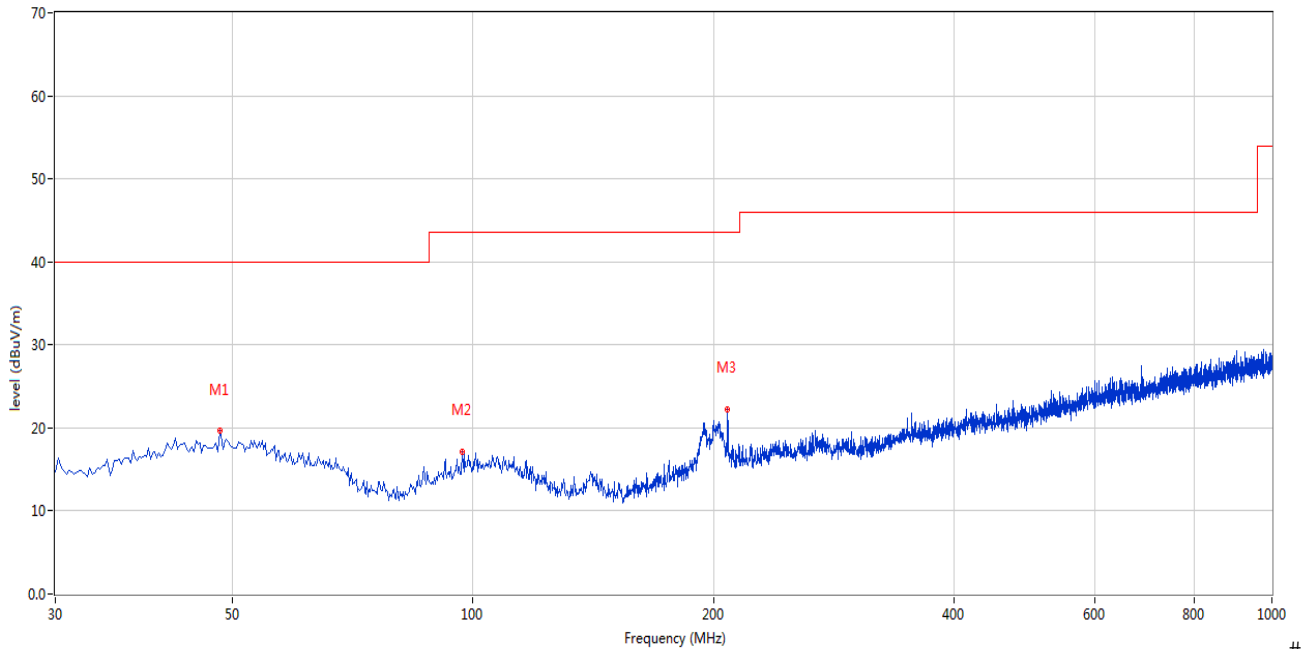

No.	Frequency (MHz)	Results (dBuV/m)	Factor (dB)	Limit (dBuV/m)	Over Limit (dB)	Detector	Table (o)	Height (cm)	ANT	Verdict
1	48.183	19.67	-11.26	40.0	-20.33	Peak	164.00	200	H	Pass
2	96.913	17.17	-13.96	43.5	-26.33	Peak	313.00	200	H	Pass
3	208.193	22.28	-13.69	43.5	-21.22	Peak	194.00	200	H	Pass

The report refers only to the sample tested and does not apply to the bulk.

This report is issued in confidence to the client and it will be strictly treated as such by the SHENZHEN TIMEWAY TESTING LABORATORIES. It may not be reproduced in its entirety or in part and it may not be used for advertising. The client to whom the report is issued may, however, show or send it, or a certified copy thereof prepared by the SHENZHEN TIMEWAY TESTING LABORATORIES, to his customer. Supplier or other persons directly concerned. SHENZHEN TIMEWAY TESTING LABORATORIES, will not, without the consent of the client enter into any discussion of correspondence with any third party concerning the contents of the report.

In the event of the improper use of the report, the SHENZHEN TIMEWAY TESTING LABORATORIES, reserves the rights to withdraw it and to adopt any other remedies which may be appropriate.



Test Figure:

V

FCC_FCC Part 15B Class B 30MHz-1GHz

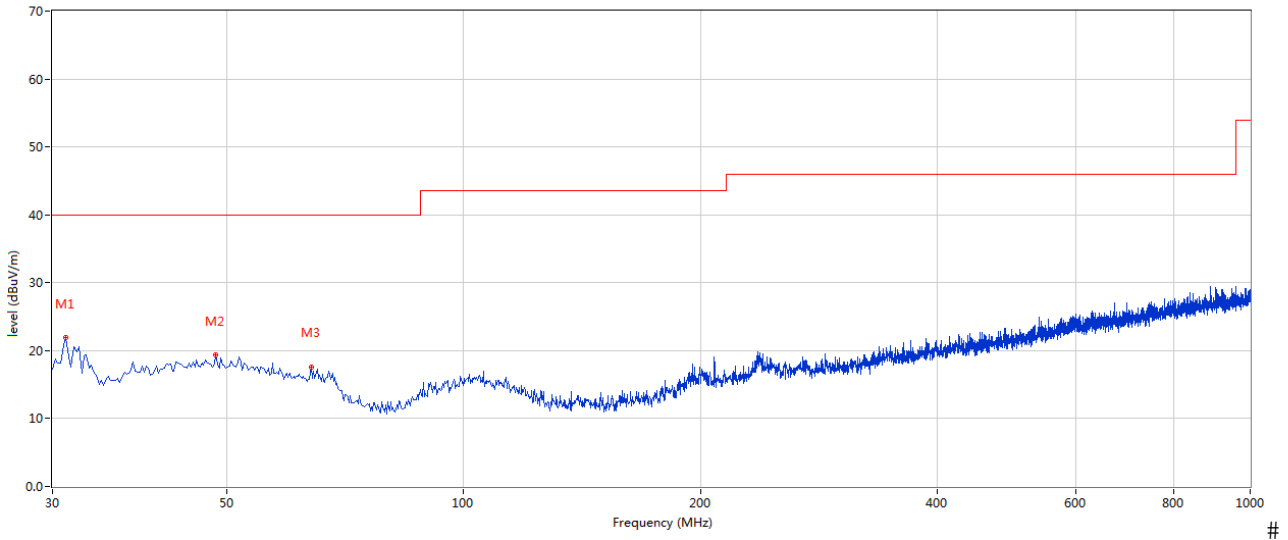

No.	Frequency (MHz)	Results (dBuV/m)	Factor (dB)	Limit (dBuV/m)	Over Limit (dB)	Detector	Table (o)	Height (cm)	ANT	Verdict
1	30.242	18.77	-14.31	40.0	-21.23	Peak	360.00	200	V	Pass
2	48.425	19.34	-11.22	40.0	-20.66	Peak	189.00	200	V	Pass
3	63.942	17.64	-13.32	40.0	-22.36	Peak	129.00	100	V	Pass

#

The report refers only to the sample tested and does not apply to the bulk.

This report is issued in confidence to the client and it will be strictly treated as such by the SHENZHEN TIMEWAY TESTING LABORATORIES. It may not be reproduced in its entirety or in part and it may not be used for advertising. The client to whom the report is issued may, however, show or send it, or a certified copy thereof prepared by the SHENZHEN TIMEWAY TESTING LABORATORIES, to his customer, supplier or other persons directly concerned. SHENZHEN TIMEWAY TESTING LABORATORIES will not, without the consent of the client, enter into any discussion of correspondence with any third party concerning the contents of the report.

In the event of the improper use of the report, the SHENZHEN TIMEWAY TESTING LABORATORIES reserves the rights to withdraw it and to adopt any other remedies which may be appropriate.



Radiated Disturbance (1000MHz----6000MHz)

EUT Operating Environment

Temperature: 25°C Humidity: 75%RH Atmospheric Pressure: 101 kPa

EUT set Condition: Receiving Mode

Equipment Level: Class B

Results: Pass

Please refer to following diagram for individual

FCC Part 15B Class B 1GHz-6GHz

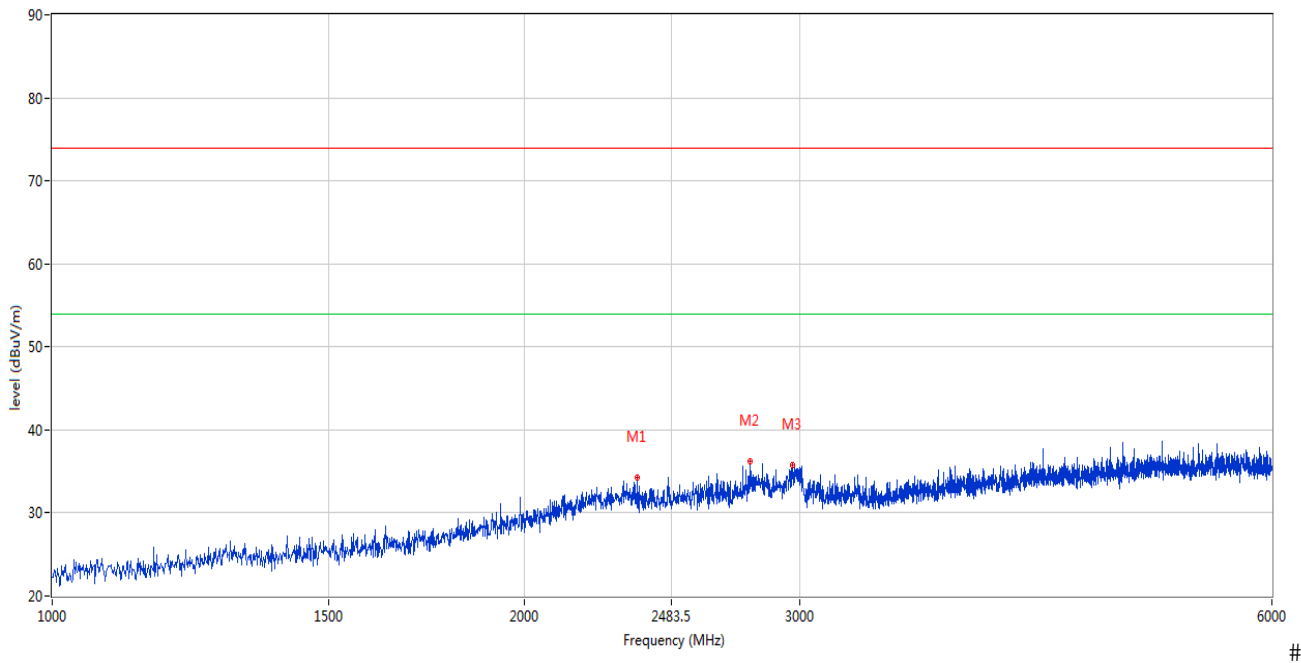

No.	Frequency (MHz)	Results (dBuV/m)	Factor (dB)	Limit (dBuV/m)	Over Limit (dB)	Detector	Table (o)	Height (cm)	ANT	Verdict
1	2363.409	34.23	-3.43	74.0	-39.77	Peak	5.00	100	V	Pass
2	2789.553	36.24	-2.72	74.0	-37.76	Peak	11.00	100	V	Pass
3	2968.258	35.73	-2.65	74.0	-38.27	Peak	10.00	100	V	Pass

The report refers only to the sample tested and does not apply to the bulk.

This report is issued in confidence to the client and it will be strictly treated as such by the SHENZHEN TIMEWAY TESTING LABORATORIES. It may not be reproduced in its entirety or in part and it may not be used for advertising. The client to whom the report is issued may, however, show or send it, or a certified copy thereof prepared by the SHENZHEN TIMEWAY TESTING LABORATORIES, to his customer. Supplier or others persons directly concerned. SHENZHEN TIMEWAY TESTING LABORATORIES, will not, without the consent of the client enter into any discussion of correspondence with any third party concerning the contents of the report.

In the event of the improper use of the report. The SHENZHEN TIMEWAY TESTING LABORATORIES, reserves the rights to withdraw it and to adopt any other remedies which may be appropriate.



Radiated Disturbance (1000MHz----6000MHz)

EUT Operating Environment

Temperature:25°C Humidity: 75%RH Atmospheric Pressure: 101 kPa

EUT set Condition: Receiving Mode

Equipment Level: Class B

Results: Pass

Please refer to following diagram for individual

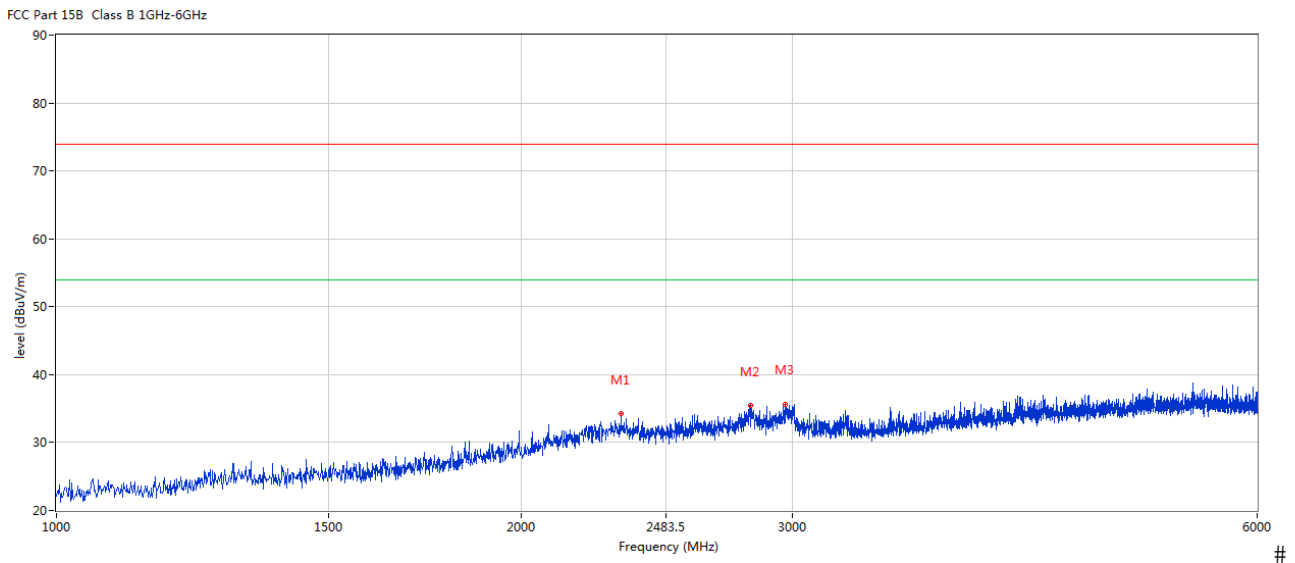

No.	Frequency (MHz)	Results (dBuV/m)	Factor (dB)	Limit (dBuV/m)	Over Limit (dB)	Detector	Table (o)	Height (cm)	ANT	Verdict
1	2322.169	34.25	-3.27	74.0	-39.75	Peak	1.00	100	H	Pass
2	2815.796	35.47	-2.69	74.0	-38.53	Peak	5.00	100	H	Pass
3	2968.258	35.68	-2.65	74.0	-38.32	Peak	3.00	100	H	Pass

The report refers only to the sample tested and does not apply to the bulk.

This report is issued in confidence to the client and it will be strictly treated as such by the SHENZHEN TIMEWAY TESTING LABORATORIES. It may not be reproduced rather in its entirety or in part and it may not be used for advertising. The client to whom the report is issued may, however, show or send it . or a certified copy there of prepared by the SHENZHEN TIMEWAY TESTING LABORATORIES. to his customer. Supplier or others persons directly concerned. SHENZHEN TIMEWAY TESTING LABORATORIES. will not, without the consent of the client enter into any discussion of correspondence with any third party concerning the contents of the report.

In the event of the improper use of the report. The SHENZHEN TIMEWAY TESTING LABORATORIES. reserves the rights to withdraw it and to adopt any other remedies which may be appropriate.



6.0 FCC Label

FCC ID: RGB-52BENTR1

This device complies with part 15 of the FCC rules. Operation is subject to the following two conditions (1) this device may not cause harmful interference, and (2) this device must accept any interference received, including interference that may cause undesired operation.

The label must not be a stick-on paper label. The label on these products must be permanently affixed to the product and readily visible at the time of purchase and must last the expected lifetime of the equipment not be readily detachable.

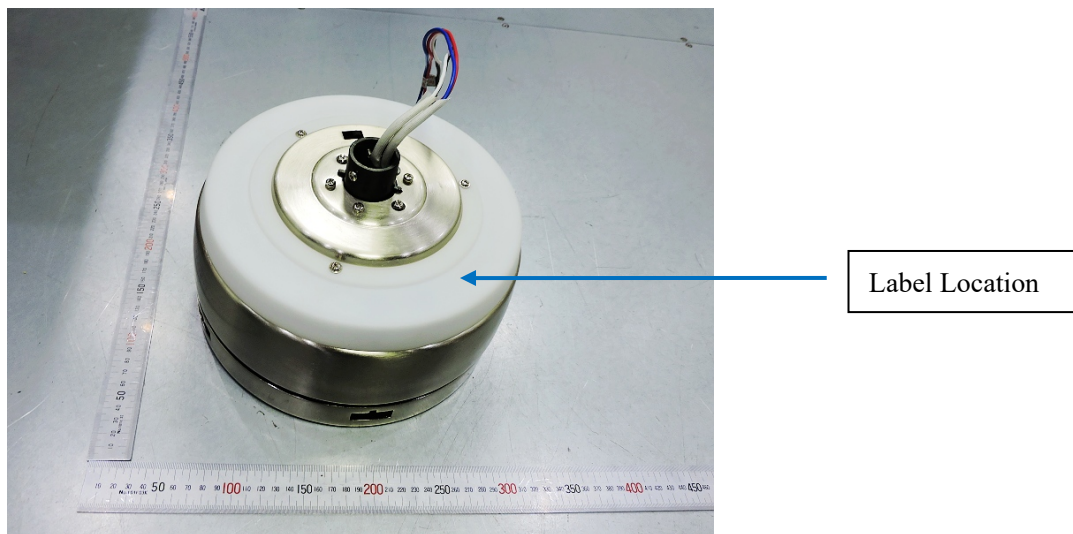

The report refers only to the sample tested and does not apply to the bulk.

This report is issued in confidence to the client and it will be strictly treated as such by the SHENZHEN TIMEWAY TESTING LABORATORIES. It may not be reproduced rather in its entirety or in part and it may not be used for advertising. The client to whom the report is issued may, however, show or send it, or a certified copy thereof prepared by the SHENZHEN TIMEWAY TESTING LABORATORIES, to his customer, supplier or other persons directly concerned. SHENZHEN TIMEWAY TESTING LABORATORIES will not, without the consent of the client enter into any discussion of correspondence with any third party concerning the contents of the report.

In the event of the improper use of the report, the SHENZHEN TIMEWAY TESTING LABORATORIES reserves the rights to withdraw it and to adopt any other remedies which may be appropriate.



7.0 Photo of testing

7.1 Conducted test View--

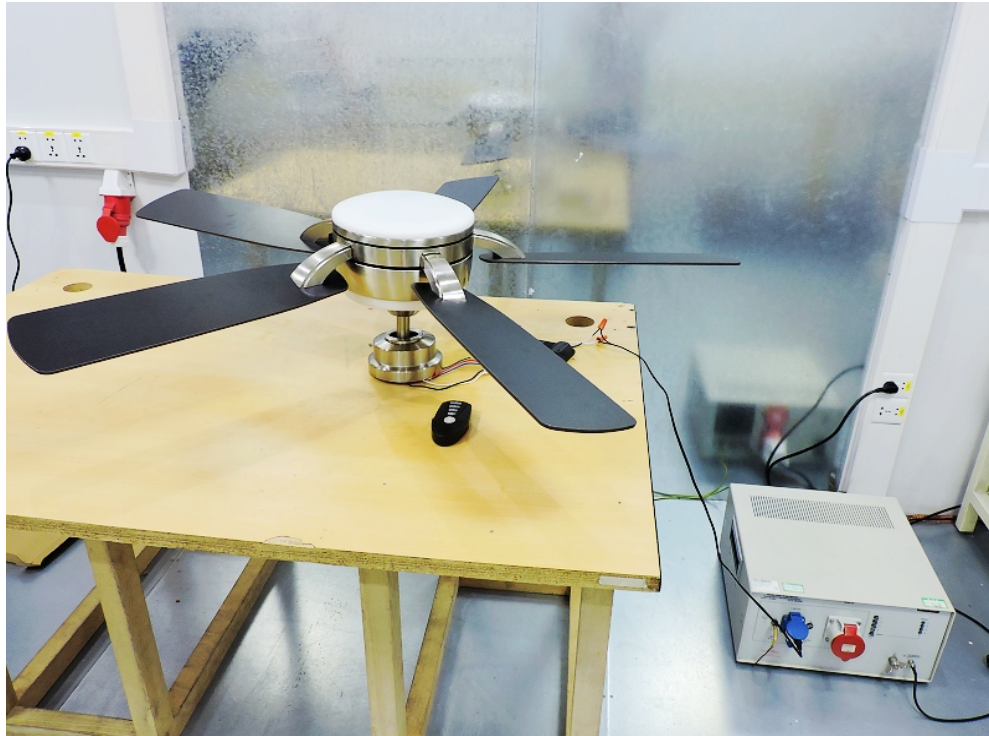

The report refers only to the sample tested and does not apply to the bulk.

This report is issued in confidence to the client and it will be strictly treated as such by the SHENZHEN TIMEWAY TESTING LABORATORIES. It may not be reproduced rather in its entirety or in part and it may not be used for advertising. The client to whom the report is issued may, however, show or send it . or a certified copy there of prepared by the SHENZHEN TIMEWAY TESTING LABORATORIES. to his customer. Supplier or others persons directly concerned. SHENZHEN TIMEWAY TESTING LABORATORIES. will not, without the consent of the client enter into any discussion of correspondence with any third party concerning the contents of the report.

In the event of the improper use of the report. The SHENZHEN TIMEWAY TESTING LABORATORIES. reserves the rights to withdraw it and to adopt any other remedies which may be appropriate.



7.2 Radiated emission test view--

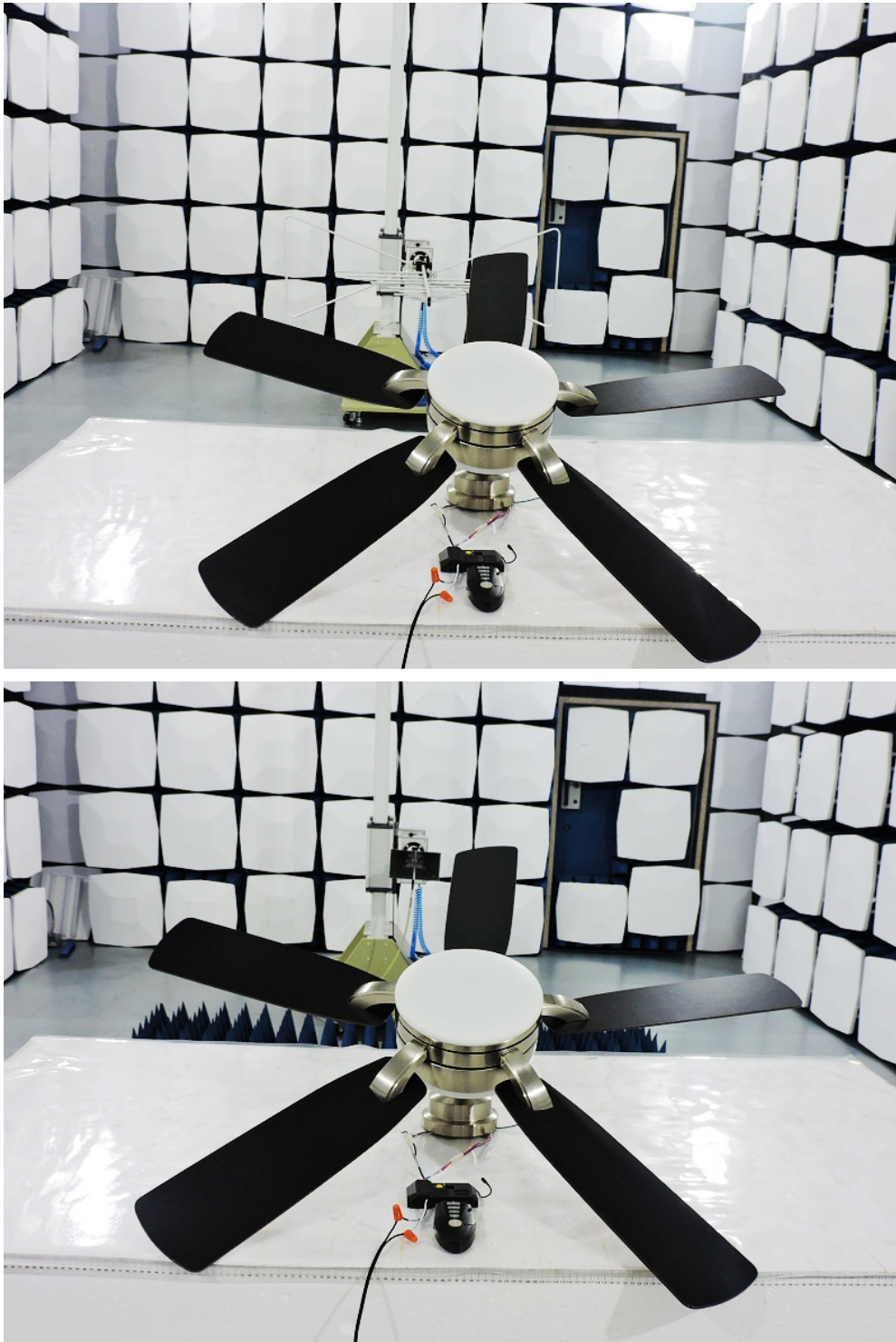

The report refers only to the sample tested and does not apply to the bulk.
This report is issued in confidence to the client and it will be strictly treated as such by the SHENZHEN TIMEWAY TESTING LABORATORIES. It may not be reproduced rather in its entirety or in part and it may not be used for advertising. The client to whom the report is issued may, however, show or send it . or a certified copy there of prepared by the SHENZHEN TIMEWAY TESTING LABORATORIES. to his customer. Supplier or others persons directly concerned. SHENZHEN TIMEWAY TESTING LABORATORIES. will not, without the consent of the client enter into any discussion of correspondence with any third party concerning the contents of the report.
In the event of the improper use of the report. The SHENZHEN TIMEWAY TESTING LABORATORIES. reserves the rights to withdraw it and to adopt any other remedies which may be appropriate.

Photo for the EUT



The report refers only to the sample tested and does not apply to the bulk.

This report is issued in confidence to the client and it will be strictly treated as such by the SHENZHEN TIMEWAY TESTING LABORATORIES. It may not be reproduced rather in its entirety or in part and it may not be used for advertising. The client to whom the report is issued may, however, show or send it, or a certified copy thereof prepared by the SHENZHEN TIMEWAY TESTING LABORATORIES, to his customer, supplier or others persons directly concerned. SHENZHEN TIMEWAY TESTING LABORATORIES, will not, without the consent of the client enter into any discussion of correspondence with any third party concerning the contents of the report.

In the event of the improper use of the report, the SHENZHEN TIMEWAY TESTING LABORATORIES, reserves the rights to withdraw it and to adopt any other remedies which may be appropriate.

Photo for the EUT

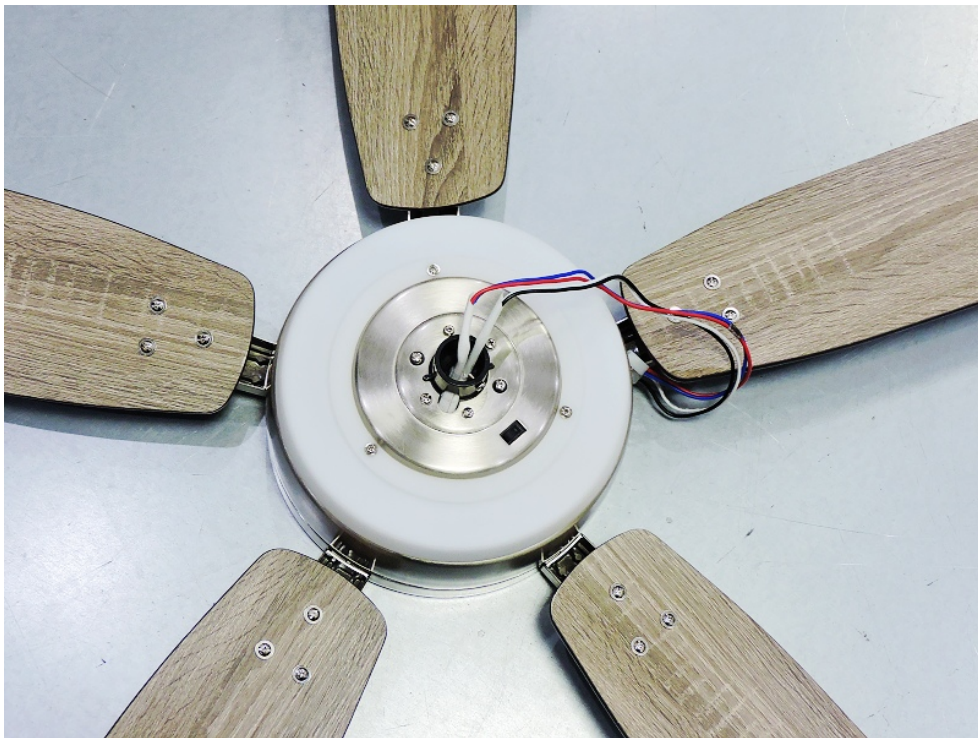
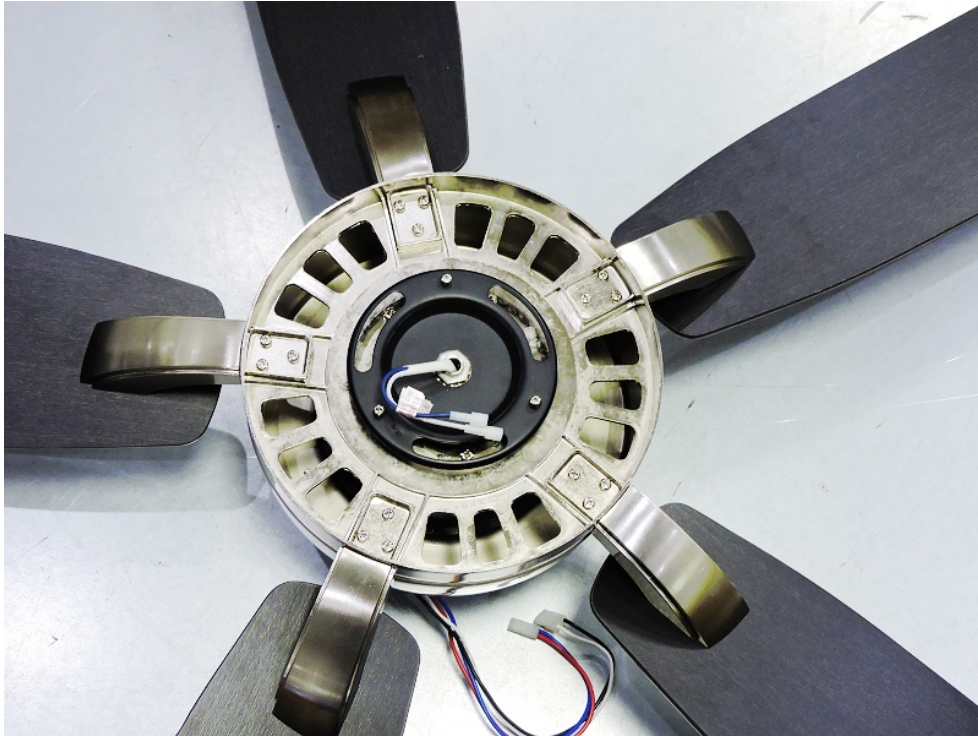

The report refers only to the sample tested and does not apply to the bulk.

This report is issued in confidence to the client and it will be strictly treated as such by the SHENZHEN TIMEWAY TESTING LABORATORIES. It may not be reproduced rather in its entirety or in part and it may not be used for advertising. The client to whom the report is issued may, however, show or send it, or a certified copy thereof prepared by the SHENZHEN TIMEWAY TESTING LABORATORIES, to his customer, supplier or other persons directly concerned. SHENZHEN TIMEWAY TESTING LABORATORIES will not, without the consent of the client enter into any discussion of correspondence with any third party concerning the contents of the report.

In the event of the improper use of the report, the SHENZHEN TIMEWAY TESTING LABORATORIES reserves the rights to withdraw it and to adopt any other remedies which may be appropriate.

Photo for the EUT

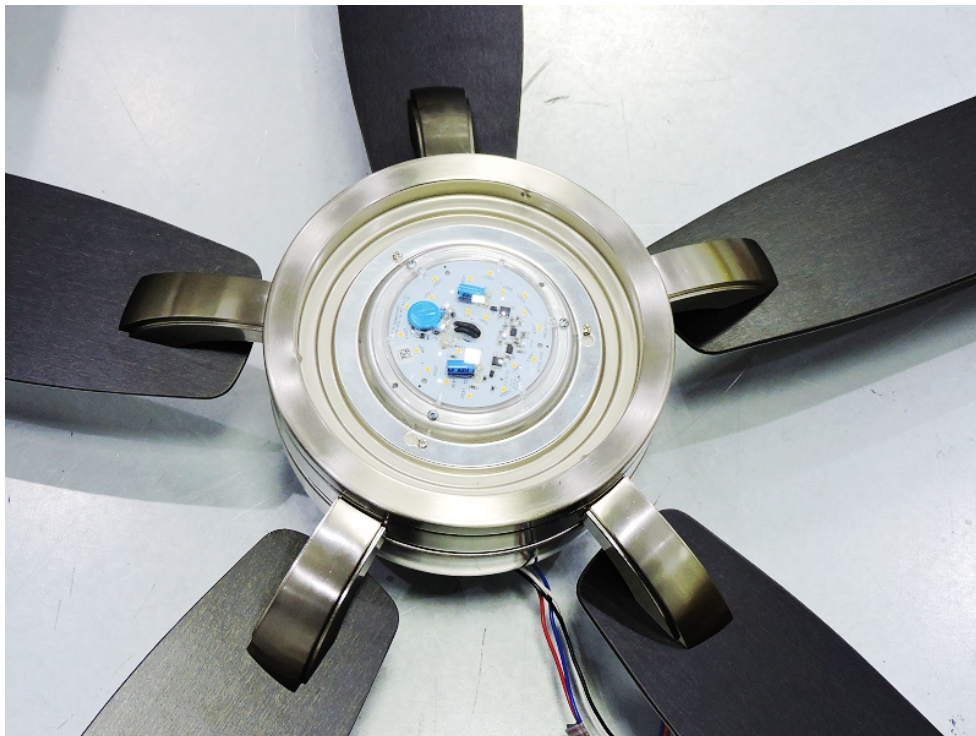
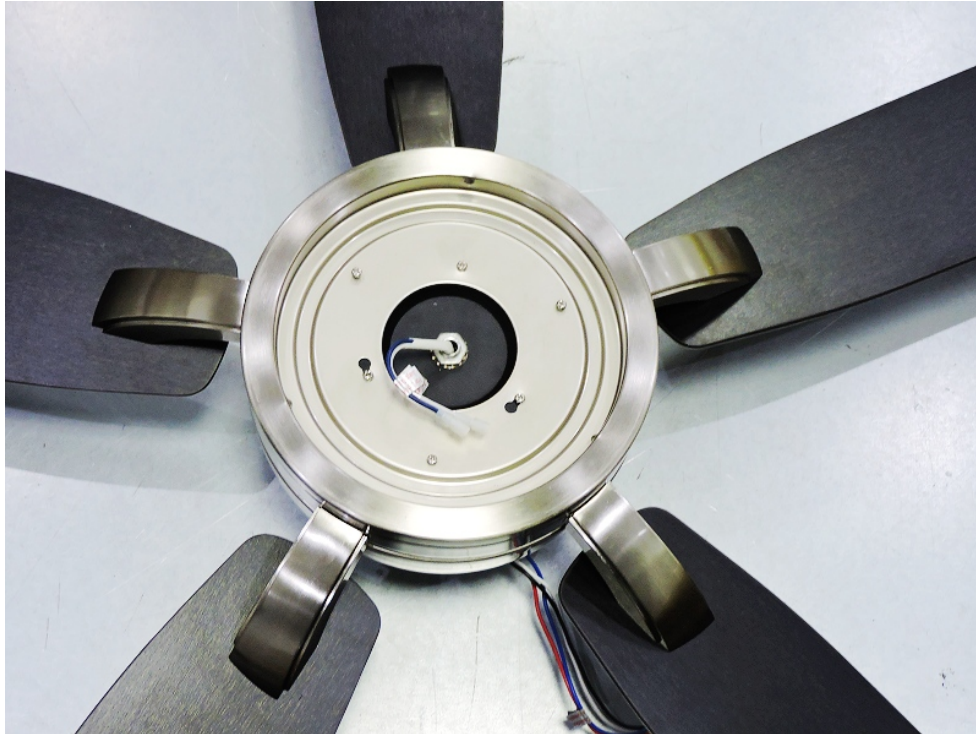

The report refers only to the sample tested and does not apply to the bulk.

This report is issued in confidence to the client and it will be strictly treated as such by the SHENZHEN TIMEWAY TESTING LABORATORIES. It may not be reproduced rather in its entirety or in part and it may not be used for advertising. The client to whom the report is issued may, however, show or send it . or a certified copy there of prepared by the SHENZHEN TIMEWAY TESTING LABORATORIES. to his customer. Supplier or others persons directly concerned. SHENZHEN TIMEWAY TESTING LABORATORIES. will not, without the consent of the client enter into any discussion of correspondence with any third party concerning the contents of the report.

In the event of the improper use of the report. The SHENZHEN TIMEWAY TESTING LABORATORIES. reserves the rights to withdraw it and to adopt any other remedies which may be appropriate.

Photo for the EUT

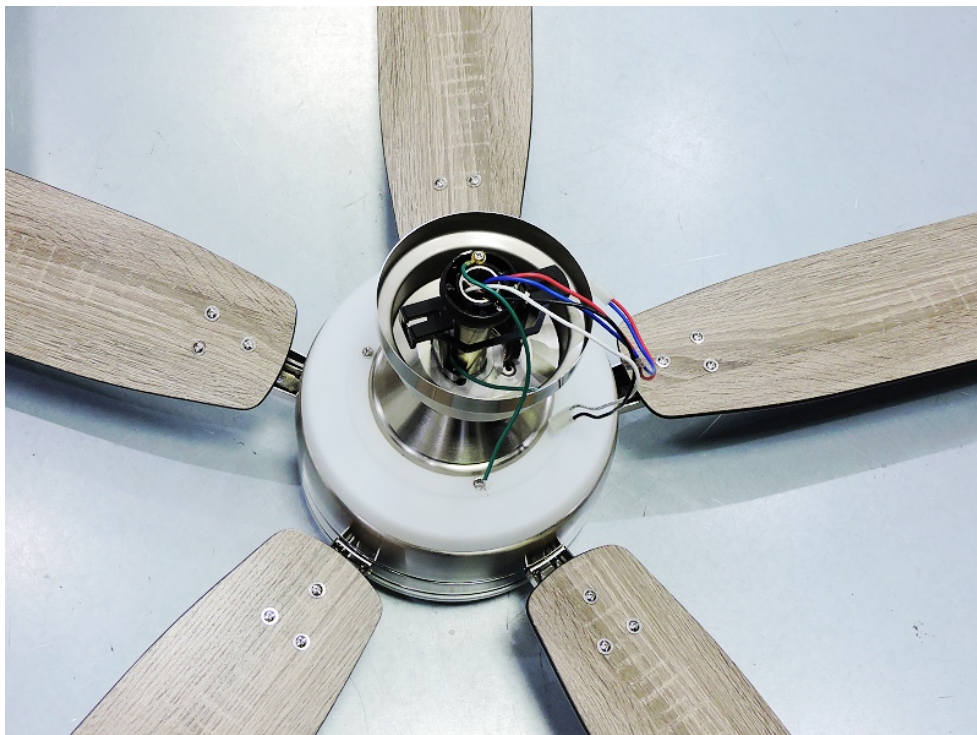
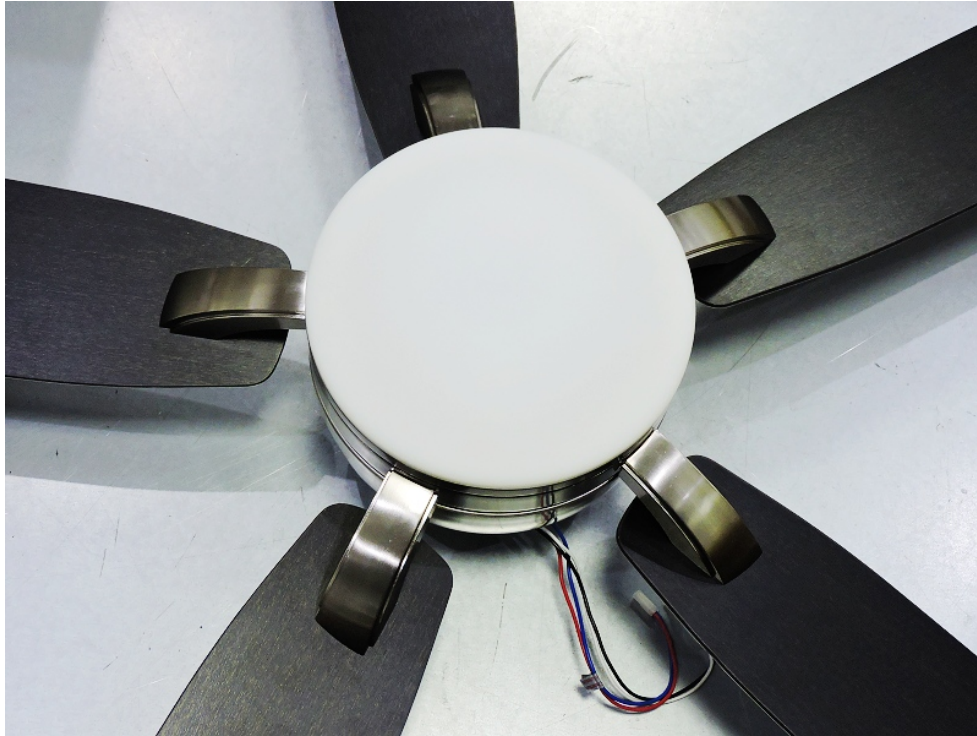

The report refers only to the sample tested and does not apply to the bulk.

This report is issued in confidence to the client and it will be strictly treated as such by the SHENZHEN TIMEWAY TESTING LABORATORIES. It may not be reproduced rather in its entirety or in part and it may not be used for advertising. The client to whom the report is issued may, however, show or send it . or a certified copy there of prepared by the SHENZHEN TIMEWAY TESTING LABORATORIES. to his customer. Supplier or others persons directly concerned. SHENZHEN TIMEWAY TESTING LABORATORIES. will not, without the consent of the client enter into any discussion of correspondence with any third party concerning the contents of the report.

In the event of the improper use of the report. The SHENZHEN TIMEWAY TESTING LABORATORIES. reserves the rights to withdraw it and to adopt any other remedies which may be appropriate.

Photo for the EUT



The report refers only to the sample tested and does not apply to the bulk.

This report is issued in confidence to the client and it will be strictly treated as such by the SHENZHEN TIMEWAY TESTING LABORATORIES. It may not be reproduced rather in its entirety or in part and it may not be used for advertising. The client to whom the report is issued may, however, show or send it . or a certified copy there of prepared by the SHENZHEN TIMEWAY TESTING LABORATORIES. to his customer. Supplier or others persons directly concerned. SHENZHEN TIMEWAY TESTING LABORATORIES. will not, without the consent of the client enter into any discussion of correspondence with any third party concerning the contents of the report.

In the event of the improper use of the report. The SHENZHEN TIMEWAY TESTING LABORATORIES. reserves the rights to withdraw it and to adopt any other remedies which may be appropriate.

Photo for the EUT

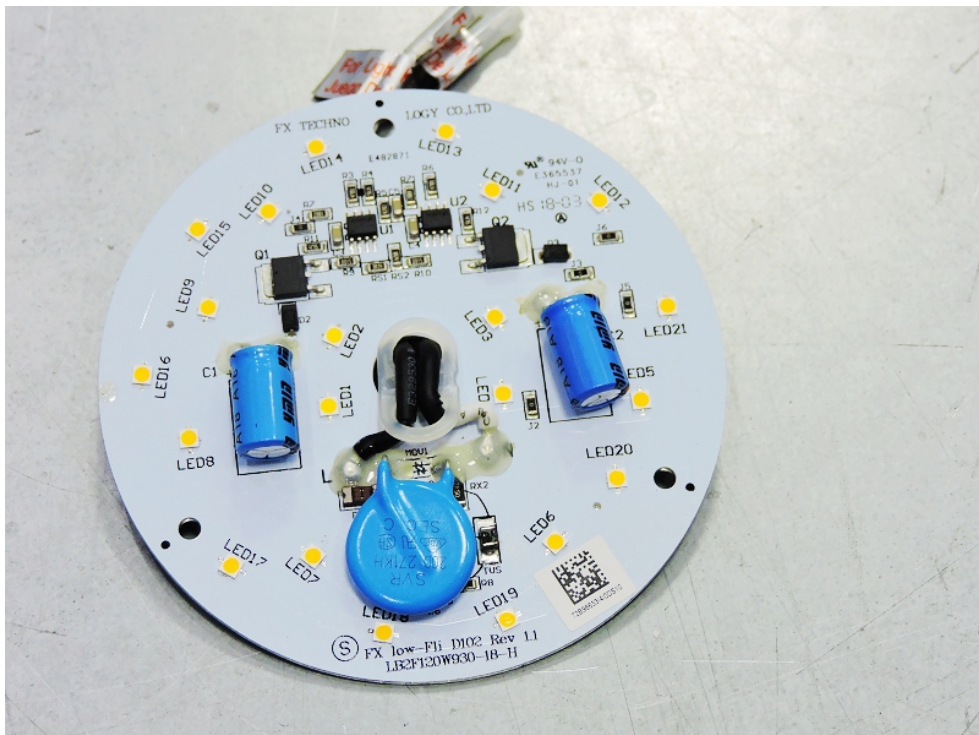
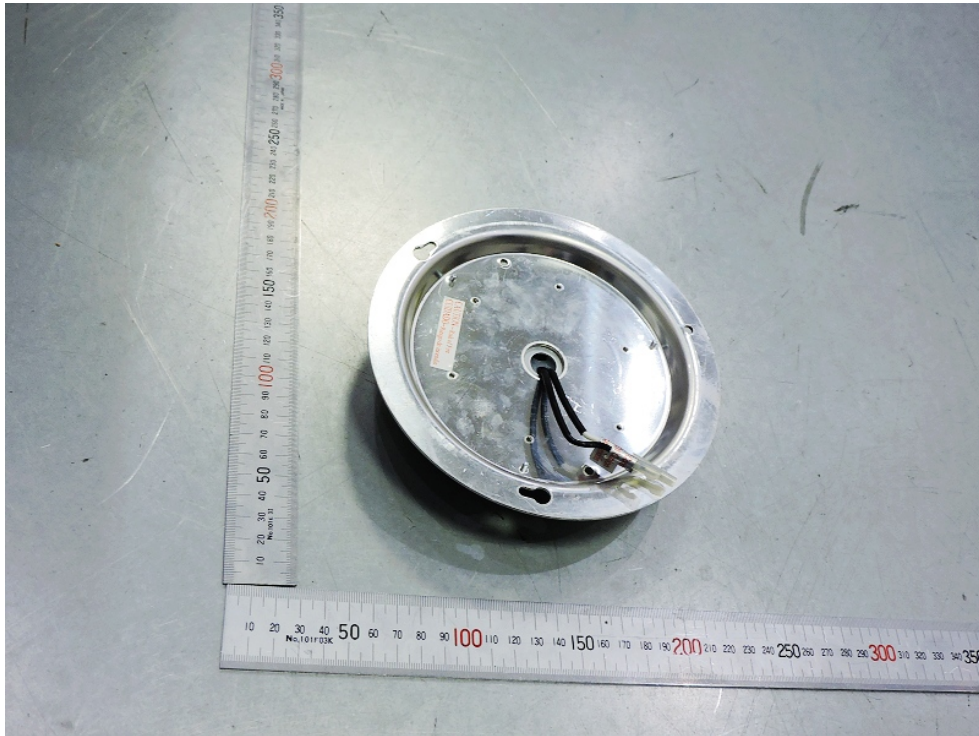

The report refers only to the sample tested and does not apply to the bulk.
This report is issued in confidence to the client and it will be strictly treated as such by the SHENZHEN TIMEWAY TESTING LABORATORIES. It may not be reproduced rather in its entirety or in part and it may not be used for advertising. The client to whom the report is issued may, however, show or send it, or a certified copy thereof prepared by the SHENZHEN TIMEWAY TESTING LABORATORIES, to his customer, supplier or other persons directly concerned. SHENZHEN TIMEWAY TESTING LABORATORIES will not, without the consent of the client enter into any discussion of correspondence with any third party concerning the contents of the report.
In the event of the improper use of the report, the SHENZHEN TIMEWAY TESTING LABORATORIES reserves the rights to withdraw it and to adopt any other remedies which may be appropriate.

Photo for the EUT

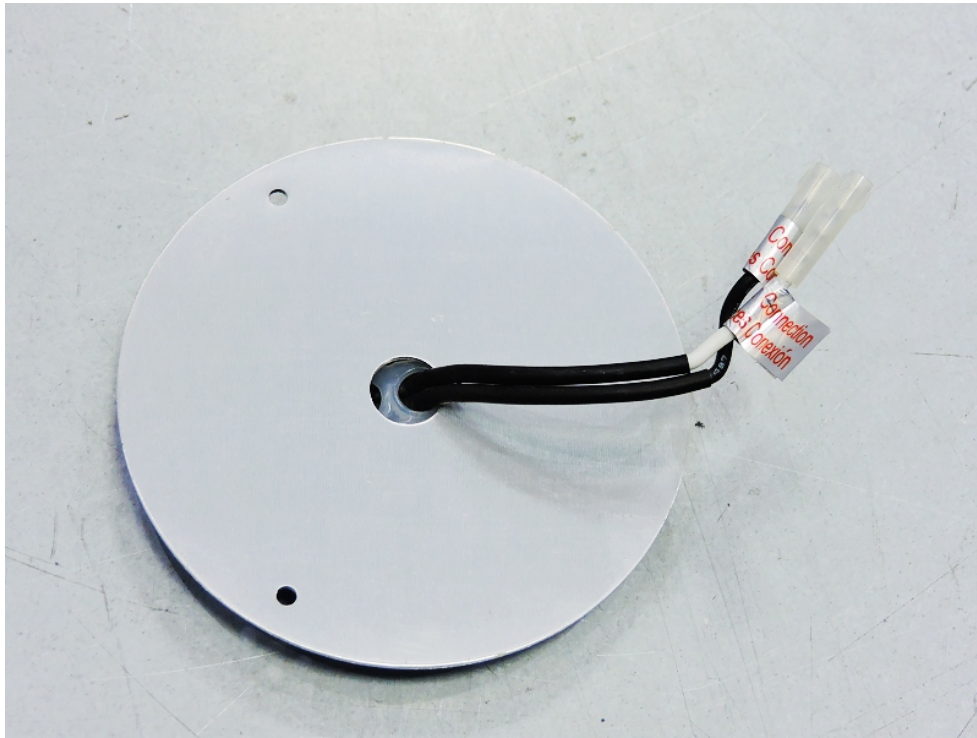

The report refers only to the sample tested and does not apply to the bulk.

This report is issued in confidence to the client and it will be strictly treated as such by the SHENZHEN TIMEWAY TESTING LABORATORIES. It may not be reproduced rather in its entirety or in part and it may not be used for advertising. The client to whom the report is issued may, however, show or send it, or a certified copy thereof prepared by the SHENZHEN TIMEWAY TESTING LABORATORIES, to his customer, supplier or other persons directly concerned. SHENZHEN TIMEWAY TESTING LABORATORIES, will not, without the consent of the client enter into any discussion of correspondence with any third party concerning the contents of the report.

In the event of the improper use of the report, the SHENZHEN TIMEWAY TESTING LABORATORIES, reserves the rights to withdraw it and to adopt any other remedies which may be appropriate.

Photo for the EUT

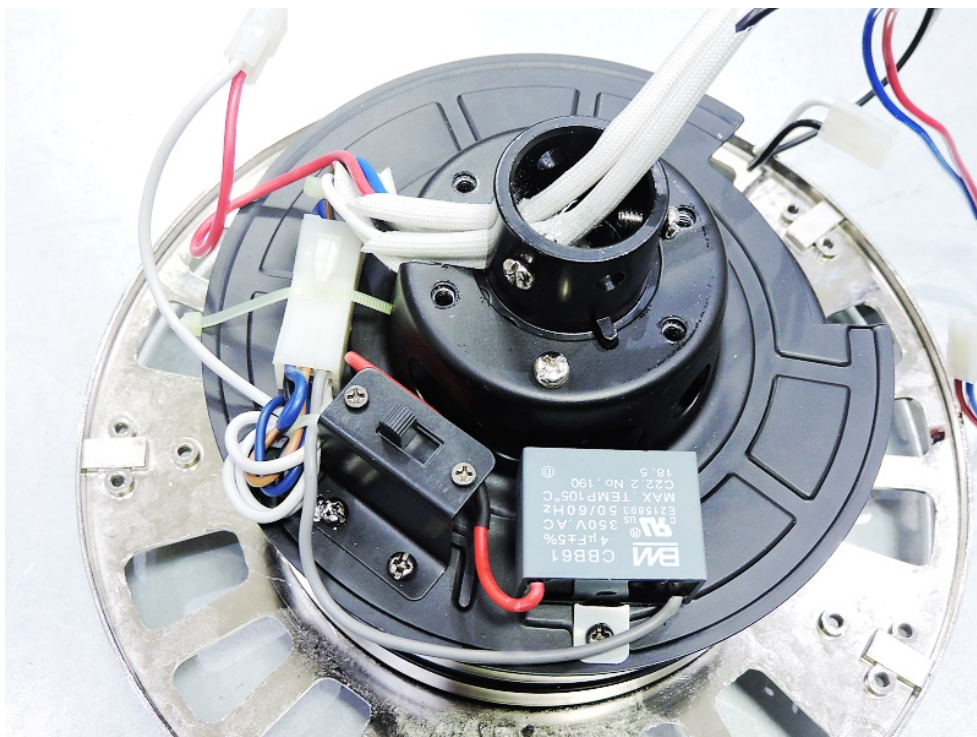
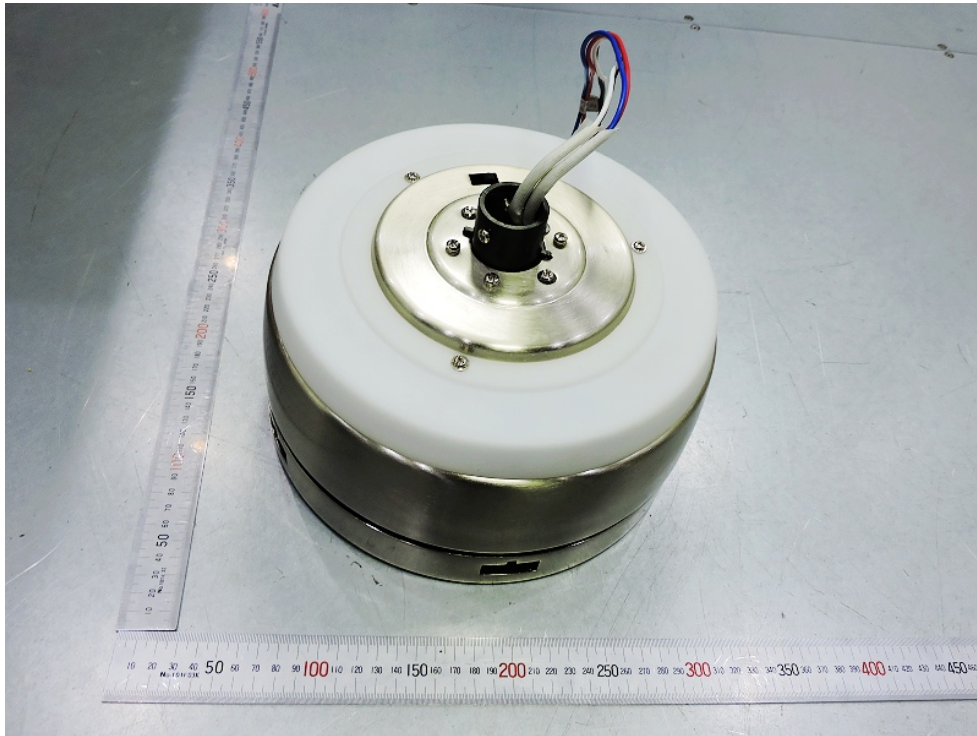

The report refers only to the sample tested and does not apply to the bulk.

This report is issued in confidence to the client and it will be strictly treated as such by the SHENZHEN TIMEWAY TESTING LABORATORIES. It may not be reproduced rather in its entirety or in part and it may not be used for advertising. The client to whom the report is issued may, however, show or send it, or a certified copy thereof prepared by the SHENZHEN TIMEWAY TESTING LABORATORIES, to his customer, supplier or others persons directly concerned. SHENZHEN TIMEWAY TESTING LABORATORIES, will not, without the consent of the client enter into any discussion of correspondence with any third party concerning the contents of the report.

In the event of the improper use of the report, the SHENZHEN TIMEWAY TESTING LABORATORIES, reserves the rights to withdraw it and to adopt any other remedies which may be appropriate.

Photo for the EUT

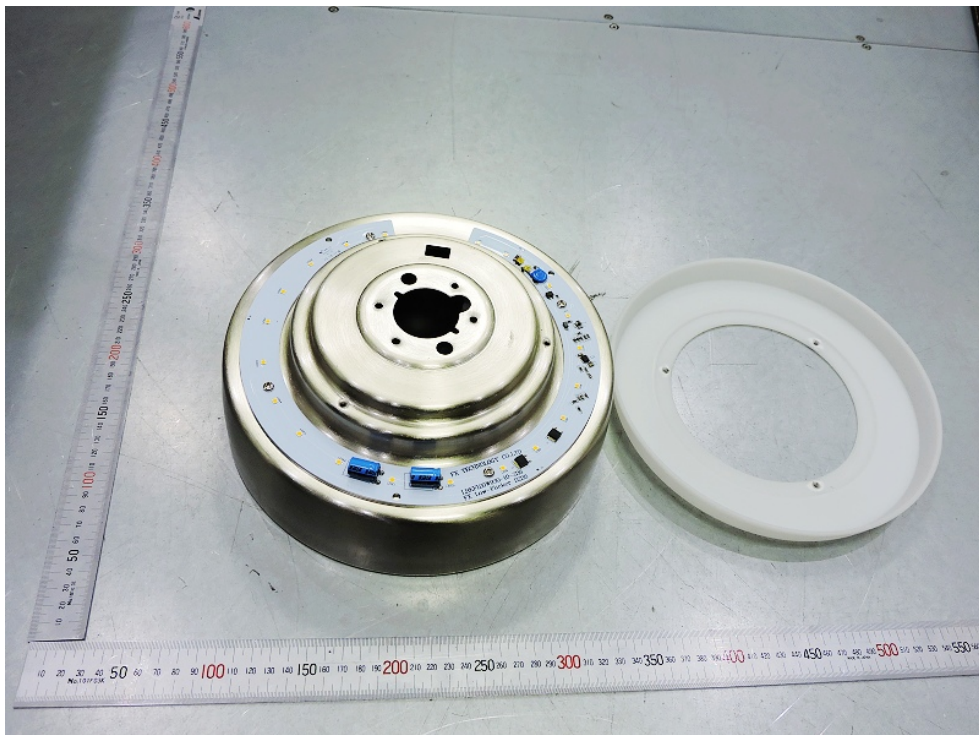
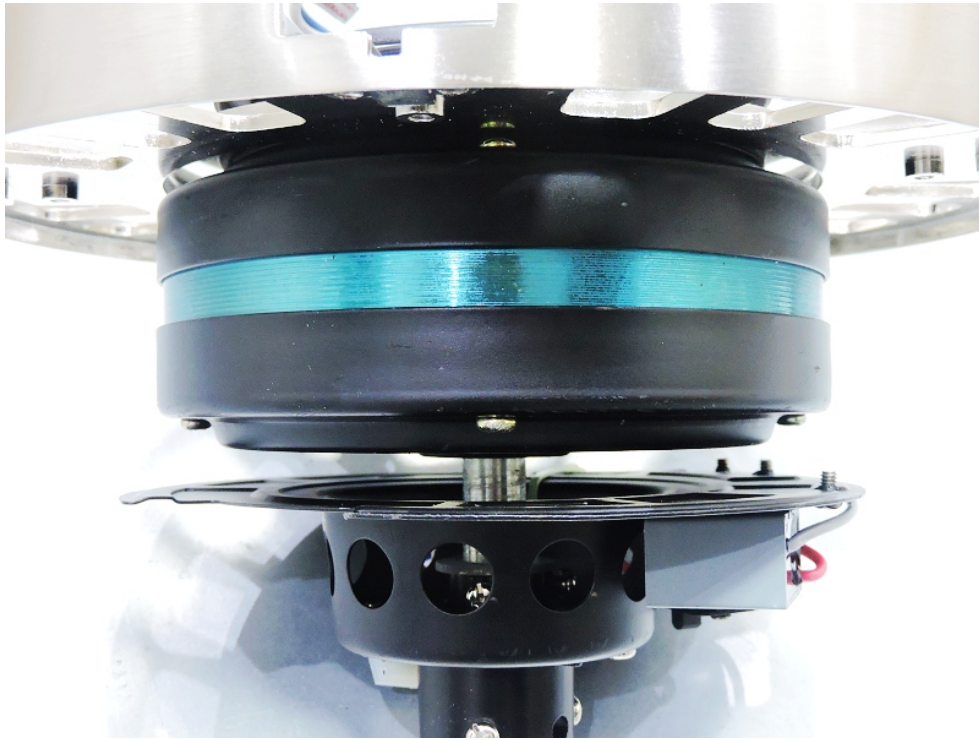

The report refers only to the sample tested and does not apply to the bulk.

This report is issued in confidence to the client and it will be strictly treated as such by the SHENZHEN TIMEWAY TESTING LABORATORIES. It may not be reproduced rather in its entirety or in part and it may not be used for advertising. The client to whom the report is issued may, however, show or send it, or a certified copy thereof prepared by the SHENZHEN TIMEWAY TESTING LABORATORIES, to his customer. Supplier or others persons directly concerned. SHENZHEN TIMEWAY TESTING LABORATORIES, will not, without the consent of the client enter into any discussion of correspondence with any third party concerning the contents of the report.

In the event of the improper use of the report. The SHENZHEN TIMEWAY TESTING LABORATORIES, reserves the rights to withdraw it and to adopt any other remedies which may be appropriate.

Photo for the EUT

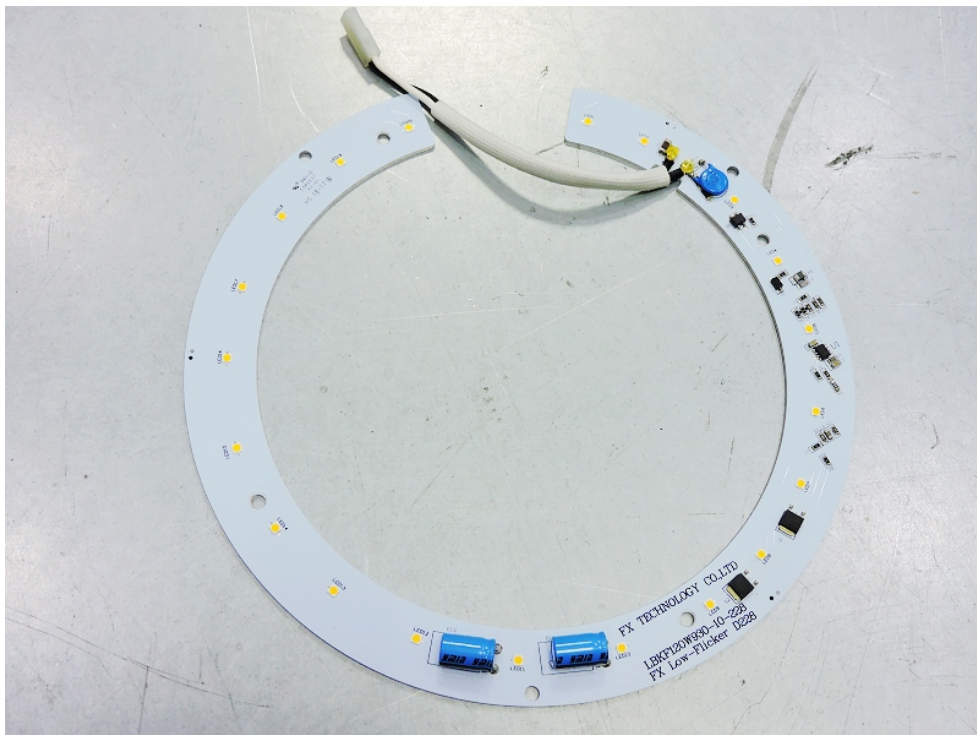
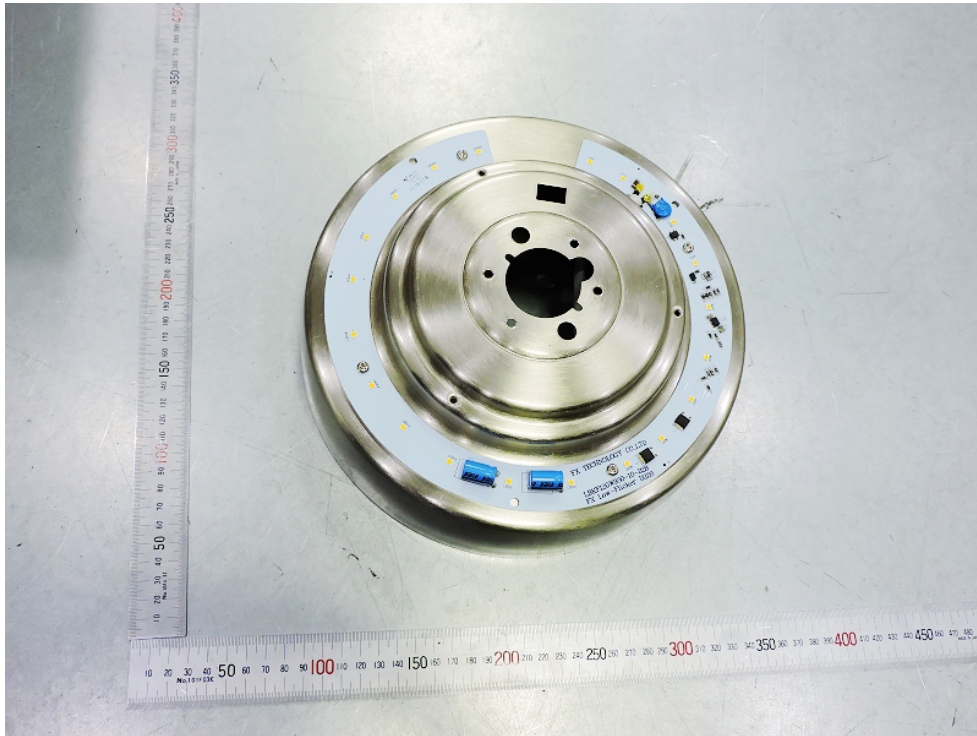

The report refers only to the sample tested and does not apply to the bulk.

This report is issued in confidence to the client and it will be strictly treated as such by the SHENZHEN TIMEWAY TESTING LABORATORIES. It may not be reproduced in its entirety or in part and it may not be used for advertising. The client to whom the report is issued may, however, show or send it, or a certified copy thereof prepared by the SHENZHEN TIMEWAY TESTING LABORATORIES, to his customer, supplier or other persons directly concerned. SHENZHEN TIMEWAY TESTING LABORATORIES will not, without the consent of the client, enter into any discussion of correspondence with any third party concerning the contents of the report.

In the event of the improper use of the report, the SHENZHEN TIMEWAY TESTING LABORATORIES reserves the rights to withdraw it and to adopt any other remedies which may be appropriate.