

ENGINEERING TEST REPORT

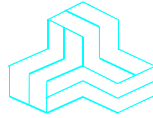

**XBee-PRO
Model No.: XBP24**

FCC ID: OUR-XBEEPRO

Applicant:

**MaxStream, Inc.
355 South 520 West Suite 180
Lindon, UT 84058
USA**

In Accordance With

**Federal Communications Commission (FCC)
Part 15, Subpart C, Section 15.247
Digital Modulation Transmitters Operating in the
Frequency Band 2400 – 2483.5 MHz**

UltraTech's File No.: MXS-050F15C247

This Test report is Issued under the Authority of
Tri M. Luu, Professional Engineer,
Vice President of Engineering
UltraTech Group of Labs



Date: October 26, 2005

Report Prepared by: Anca Dobre

Tested by: Hung Trinh, RFI Technician

Issued Date: October 26, 2005

Test Dates: August 19 – 31, 2005
October 25, 2005

- *The results in this Test Report apply only to the sample(s) tested, and the sample tested is randomly selected.*
- *This report must not be used by the client to claim product endorsement by NVLAP or any agency of the US Government.*

UltraTech

3000 Bristol Circle, Oakville, Ontario, Canada, L6H 6G4
Tel.: (905) 829-1570 Fax: (905) 829-8050

Website: www.ultratech-labs.com, Email: vic@ultratech-labs.com, Email: tri@ultratech-labs.com



31040/SIT



C-1376



46390-2049



200093-0



SL2-IN-E-1119R



00-034



TABLE OF CONTENTS

EXHIBIT 1.	SUBMITTAL CHECK LIST	2
EXHIBIT 2.	INTRODUCTION.....	3
2.1.	SCOPE	3
2.2.	RELATED SUBMITTAL(S)/GRANT(S).....	3
2.3.	NORMATIVE REFERENCES	3
EXHIBIT 3.	PERFORMANCE ASSESSMENT	4
3.1.	CLIENT INFORMATION	4
3.2.	EQUIPMENT UNDER TEST (EUT) INFORMATION.....	4
3.3.	EUT’S TECHNICAL SPECIFICATIONS	5
3.4.	ASSOCIATED ANTENNA DESCRIPTION.....	5
3.5.	LIST OF EUT’S PORTS	6
3.6.	ANCILLARY EQUIPMENT	6
EXHIBIT 4.	EUT OPERATING CONDITIONS AND CONFIGURATIONS DURING TESTS.....	7
4.1.	CLIMATE TEST CONDITIONS.....	7
4.2.	OPERATIONAL TEST CONDITIONS & ARRANGEMENT FOR TESTS	7
EXHIBIT 5.	SUMMARY OF TEST RESULTS.....	8
5.1.	LOCATION OF TESTS	8
5.2.	APPLICABILITY & SUMMARY OF EMC EMISSION TEST RESULTS.....	8
5.3.	MODIFICATIONS INCORPORATED IN THE EUT FOR COMPLIANCE PURPOSES	9
EXHIBIT 6.	MEASUREMENTS, EXAMINATIONS & TEST DATA FOR EMC EMISSIONS	10
6.1.	TEST PROCEDURES.....	10
6.2.	MEASUREMENT UNCERTAINTIES.....	10
6.3.	MEASUREMENT EQUIPMENT USED.....	10
6.4.	ESSENTIAL/PRIMARY FUNCTIONS AS DECLARED BY THE MANUFACTURER.....	10
6.5.	COMPLIANCE WITH FCC PART 15 – GENERAL TECHNICAL REQUIREMENTS.....	11
6.6.	POWER LINE CONDUCTED EMISSIONS [§ 15.207 (a)]	12
6.7.	6 dB BANDWIDTH [§ 15.247 (a) (2)]	18
6.8.	PEAK OUTPUT POWER (CONDUCTED) [§ 15.247(b)].....	23
6.9.	RF EXPOSURE REQUIREMENTS [§§ 15.247 (i), 1.1310]	27
6.10.	TRANSMITTER BAND-EDGE & SPURIOUS CONDUCTED EMISSIONS [§ 15.247(d)].....	30
6.11.	TRANSMITTED POWER DENSITY OF A DIGITAL MODULATION SYSTEM [§ 15.247 (e)]	45
6.12.	TRANSMITTER BAND-EDGE & SPURIOUS RADIATED EMISSIONS AT 3 METERS [§§15.247 (d), 15.209 & 15.205]	50
EXHIBIT 7.	MEASUREMENT UNCERTAINTY.....	82
7.1.	LINE CONDUCTED EMISSION MESUREMENT UNCERTAINTY	82
7.2.	RADIATED EMISSION MEASUREMENT UNCERTAINTY	83
EXHIBIT 8.	MEASUREMENT METHODS.....	84
8.1.	GENERAL TEST CONDITIONS	84
8.2.	METHOD OF MEASUREMENTS – AC MAINS CONDUCTED EMISSIONS.....	85
8.3.	EQUIVALENT ISOTROPIC RADIATED POWER (EIRP).....	86
8.4.	SPURIOUS EMISSIONS (CONDUCTED & RADIATED)	89
8.5.	ALTERNATIVE TEST PROCEDURES.....	92

EXHIBIT 1. SUBMITTAL CHECK LIST

Annex No.	Exhibit Type	Description of Contents	Quality Check (OK)
--	Test Report	Test Report	OK
1	Test Setup Photos	<ul style="list-style-type: none"> AC Conducted Emissions Setup Photos Radiated Emissions Setup Photos 	OK
2	External Photos of EUT	External EUT Photos	OK
3	Internal Photos of EUT	Internal EUT Photos	OK
4	Cover Letters	Letter from Ultratech for Certification Request	OK
5	Attestation Statements	<ul style="list-style-type: none"> Letter from the Applicant to appoint Ultratech to act as an agent Letter from the Applicant to request for Confidentiality Filing Maxstream, Inc. Modular Request 	OK OK
6	ID Label/Location Info	<ul style="list-style-type: none"> ID Label Location of ID Label 	OK
7	Block Diagrams	Block Diagram	OK
8	Schematic Diagrams	Schematic Diagram	OK
9	Parts List/Tune Up Info	Parts List	OK
10	Operational Description	Operational Description	OK
11	RF Exposure Info	MPE Evaluation, see Section 6.9 in this Test Report for details.	OK
12	Users Manual	XBee-PRO OEM RF Module – Product Manual	OK

ULTRATECH GROUP OF LABS

3000 Bristol Circle, Oakville, Ontario, Canada L6H 6G4
 Tel. #: 905-829-1570, Fax. #: 905-829-8050, Email: vic@ultratech-labs.com, Website: <http://www.ultratech-labs.com>

File #: MXS--050F15C247
 September 22, 2005

All test results contained in this engineering test report are traceable to National Institute of Standards and Technology (NIST)

EXHIBIT 2. INTRODUCTION

2.1. SCOPE

Reference:	FCC Part 15, Subpart C, Section 15.247
Title:	Telecommunication - Code of Federal Regulations, CFR 47, Part 15
Purpose of Test:	To gain FCC Certification Authorization for Digital Modulation Transmitters operating in the Frequency Band 2400 – 2483.5 MHz.
Test Procedures:	Both conducted and radiated emissions measurements were conducted in accordance with American National Standards Institute ANSI C63.4 - American National Standard for Methods of Measurement of Radio-Noise Emissions from Low-Voltage Electrical and Electronic Equipment in the Range of 9 kHz to 40 GHz.
Environmental Classification:	<ul style="list-style-type: none"> • Commercial, industrial or business • Residential

2.2. RELATED SUBMITTAL(S)/GRANT(S)

None.

2.3. NORMATIVE REFERENCES

Publication	Year	Title
FCC CFR Parts 0-15	2005	Code of Federal Regulations – Telecommunication
ANSI C63.4	2004	American National Standard for Methods of Measurement of Radio-Noise Emissions from Low-Voltage Electrical and Electronic Equipment in the Range of 9 KHz to 40 GHz
CISPR 22 CISPR 22 +A1 EN 55022	2003-04-10 2004-10-14 2003	Information Technology Equipment - Radio Disturbance Characteristics – Limits and Methods of Measurement
CISPR 16-1-1	2003	Specification for radio disturbance and immunity measuring apparatus and methods. Part 1-1: Measuring Apparatus
CISPR 16-2-1	2004	Specification for radio disturbance and immunity measuring apparatus and methods. Part 2-1: Conducted disturbance measurement
FCC Public Notice DA 00-1407	2000	Part 15 Unlicensed Modular Transmitter Approval
FCC ET Docket No. 99-231	2002	Amendment to FCC Part 15 of the Commission's Rules Regarding to Spread Spectrum Devices
FCC procedures	2005, March 23	Measurement of Digital Transmission Systems operating under Section 15.247

ULTRATECH GROUP OF LABS

3000 Bristol Circle, Oakville, Ontario, Canada L6H 6G4
 Tel. #: 905-829-1570, Fax. #: 905-829-8050, Email: vic@ultratech-labs.com, Website: <http://www.ultratech-labs.com>

File #: MXS--050F15C247
 September 22, 2005

All test results contained in this engineering test report are traceable to National Institute of Standards and Technology (NIST)

EXHIBIT 3. PERFORMANCE ASSESSMENT

3.1. CLIENT INFORMATION

APPLICANT	
Name:	MaxStream, Inc.
Address:	355 South 520 West Suite 180 Lindon, UT 84058 USA
Contact Person:	Mr. David Steed Phone #: (801) 765-9885 Fax #: (801) 765-9895 Email Address: davids@maxstream.net

MANUFACTURER	
Name:	MaxStream, Inc.
Address:	355 South 520 West Suite 180 Lindon, UT 84058 USA
Contact Person:	Mr. David Steed Phone #: (801) 765-9885 Fax #: (801) 765-9895 Email Address: davids@maxstream.net

3.2. EQUIPMENT UNDER TEST (EUT) INFORMATION

The following information (with the exception of the Date of Receipt) has been supplied by the applicant.

Brand Name:	MaxStream, Inc.
Product Name:	XBee-PRO
Model Name or Number:	XBP24
Serial Number:	Test Sample
Type of Equipment:	Digital Modulation Transmitter
Input Power Supply Type:	2.8 Vdc – 3.4 Vdc Hewlett Packard DC Power Supply Model: E3615A S/N: KR61303416
Primary User Functions of EUT:	Wireless modem

ULTRATECH GROUP OF LABS

3000 Bristol Circle, Oakville, Ontario, Canada L6H 6G4
 Tel. #: 905-829-1570, Fax. #: 905-829-8050, Email: vic@ultratech-labs.com, Website: <http://www.ultratech-labs.com>

File #: MXS--050F15C247
 September 22, 2005

All test results contained in this engineering test report are traceable to National Institute of Standards and Technology (NIST)

3.3. EUT’S TECHNICAL SPECIFICATIONS

TRANSMITTER	
Equipment Type:	<ul style="list-style-type: none"> • Mobile • Base Station (fixed use)
Intended Operating Environment:	<ul style="list-style-type: none"> • Commercial, industrial or business • Residential
Power Supply Requirement:	2.8 – 3.4 Vdc
RF Output Power Rating:	From 10 mW (10 dBm) to 63 mW (18 dBm)
Operating Frequency Range:	2410 - 2470 MHz
RF Output Impedance:	50 Ohms
Channel Spacing:	5 MHz
Duty Cycle:	100%
6 dB bandwidth:	1.6 MHz
Modulation Type:	O-QPSK
Oscillator Frequencies:	16 MHz
Antenna Connector Type:	<ul style="list-style-type: none"> • Integral • Unique connector (IPX or U.FL)

3.4. ASSOCIATED ANTENNA DESCRIPTION

There are 4 antenna families to be used with this Module:

1. Surface Mount Chip Antennas Family (incorporates one integral antenna: Surface Mount Chip Antenna, P/N: A24-C1)
2. Omnidirectional Base Station Antennas Family.
3. Yagi Antennas Family.
4. Panel Antennas Family.
5. Low Gain Antenna Family.

The highest gain antenna from each of the above antenna families was selected for testing to represent the worst case (please refer to the Revised Antennas List exhibit for detailed specifications):

1. Chip Antenna (P/N: A24-C1; Max. Antenna Gain = - 1.5 dBi)
2. Maxrad Yagi Antenna (P/N: A24-Y18NF; Max. Antenna Gain: 15 dBi)
3. ARC Panel Antenna (P/N: A24-P19NF; Max. Antenna Gain = 19 dBi)
4. D-Link Antenna: (P/N: A24-F15NF; Max. Antenna Gain = 15 dBi)
5. Rubber Duck Antenna: (P/N: A24-HABSM; Max. Antenna Gain = 2.1 dBi)

Notes:

- The XBP24 RF Module uses either integral antenna (Surface Mount Chip Antenna) or external antennas.
- The highest channel frequency is limited at 2465 MHz when the XBP24 RF Module uses Low Gain Antenna Family (Max. Antenna Gain = 2.1 dBi).

ULTRATECH GROUP OF LABS

3000 Bristol Circle, Oakville, Ontario, Canada L6H 6G4
 Tel. #: 905-829-1570, Fax. #: 905-829-8050, Email: vic@ultratech-labs.com, Website: <http://www.ultratech-labs.com>

File #: MXS--050F15C247
 September 22, 2005

All test results contained in this engineering test report are traceable to National Institute of Standards and Technology (NIST)

3.5. LIST OF EUT'S PORTS

Port Number	EUT's Port Description	Number of Identical Ports	Connector Type	Cable Type (Shielded/Non-shielded)
1	RF IN/OUT Port	1	U.FL or IPX	Shielded
2	DC Supply & I/O Port	1	Pin Header	No cable, direct connection

3.6. ANCILLARY EQUIPMENT

The EUT was tested while connected to the following representative configuration of ancillary equipment necessary to exercise the ports during tests:

Ancillary Equipment # 1	
Description:	Test Jig Board
Brand name:	MaxStream
Model Name or Number:	N/A
Serial Number:	N/A
Connected to EUT's Port:	Module pin signals

EXHIBIT 4. EUT OPERATING CONDITIONS AND CONFIGURATIONS DURING TESTS

4.1. CLIMATE TEST CONDITIONS

The climate conditions of the test environment are as follows:

Temperature:	21°C
Humidity:	51%
Pressure:	102 kPa
Power input source:	2.8 – 3.4 Vdc

4.2. OPERATIONAL TEST CONDITIONS & ARRANGEMENT FOR TESTS

Operating Modes:	<ul style="list-style-type: none"> Each of lowest, middle and highest channel frequencies transmits continuously for emissions measurements. The EUT operates in normal Direct Sequence Mode for occupancy duration and frequency separation.
Special Test Software:	Special software and hardware by the Applicant to operate the EUT at each channel frequency continuously. For example, the transmitter will be operated at each of the lowest, middle and highest frequencies individually continuously during testing.
Special Hardware Used:	The RF Module could be tested outside of the enclosure using Maxstream Test Jig Board connected to EUT.
Transmitter Test Antenna:	The EUT is tested with the antenna fitted in a manner typical of normal intended use as an integral / non-integral antenna equipment as described with the test results.

Transmitter Test Signals	
Frequency Band(s):	2410 - 2470 MHz
Test Frequency(ies): (Near lowest, near middle & near highest frequencies in the frequency range of operation.)	<ul style="list-style-type: none"> 2410 MHz 2440 MHz 2470 MHz
Transmitter Wanted Output Test Signals:	
Transmitter Power (measured maximum output power):	Low: 0.0095 watts High: 0.086 watts
Normal Test Modulation:	O-QPSK
Modulating signal source:	Internal

EXHIBIT 5. SUMMARY OF TEST RESULTS

5.1. LOCATION OF TESTS

All of the measurements described in this report were performed at Ultratech Group of Labs located in the city of Oakville, Province of Ontario, Canada.

- AC Powerline Conducted Emissions were performed in UltraTech's shielded room, 24'(L) by 16'(W) by 8'(H).
- Radiated Emissions were performed at the Ultratech's 3-10 TDK Semi-Anechoic Chamber situated in the Town of Oakville, province of Ontario.

The above test sites have been calibrated in accordance with ANSI C63.4, and found to be in compliance with the requirements of Sec. 2.948 of the FCC Rules. The descriptions and site measurement data of the Oakville 3-10 TDK Semi-Anechoic Chamber has been filed with FCC office (FCC File No.: 31040/SIT 1300B3) and Industry Canada office (Industry Canada File No.: IC2049-1). Last Date of Site Calibration: June 20, 2005.

5.2. APPLICABILITY & SUMMARY OF EMC EMISSION TEST RESULTS

FCC Paragraph	Test Requirements	Compliance (Yes/No)
15.207	Power Line Conducted Emissions Measurements	Yes
15.247 (a)(2)	6 dB Bandwidth of a Digital Modulation System	Yes
15.247(b) & 1.1310	Maximum Output Power	Yes
15.247 (i), 1.1307, 1.1310, 2.1091 & 2.1093	RF Exposure Limit	Yes
15.247(c)	RF Conducted Spurious Emissions at the Transmitter Antenna Terminal	Yes
15.247(d)	Transmitted Power Spectral Density of a Digital Modulation System	Yes
15.247(c), 15.209 & 15.205	Transmitter Radiated Emissions	Yes
The digital circuit portion of the EUT has been tested and verified to comply with FCC Part 15, Subpart B, Class B Digital Devices and the associated Radio Receiver has also been tested and found to comply with Part 15, Subpart B – Radio Receivers. The engineering test report is available upon request.		

ULTRATECH GROUP OF LABS

3000 Bristol Circle, Oakville, Ontario, Canada L6H 6G4
 Tel. #: 905-829-1570, Fax. #: 905-829-8050, Email: vic@ultratech-labs.com, Website: <http://www.ultratech-labs.com>

File #: MXS--050F15C247
 September 22, 2005

All test results contained in this engineering test report are traceable to National Institute of Standards and Technology (NIST)

5.3. MODIFICATIONS INCORPORATED IN THE EUT FOR COMPLIANCE PURPOSES

For compliance purposes, the following conditions have to be applied:

1. XBee-PRO RF Module is connected to any external antenna using a 4 inch coaxial cable with end #1 = U.FL connector (board surface mounted) and end #2 = RPSMA connector (coupled to any external antenna). The cable loss is 0.4 dB.
2. Maxrad Yagi Antenna must be connected as follows:
 - 4inch cable to connect U.FL to RPSMA (cable loss of 0.4 dB)
 - CFD-200 NL antenna cable (3 meters; cable loss of 2.00 dB)
 - Belden 7806R antenna cable (6 meters; cable loss of 4.00 dB)
 - Belden 7806R antenna cable (6 meters; cable loss of 4.00 dB)
 - LMR-400 coaxial cable (7 meters; cable loss of 1.8 dB)
 - Coleman 8421 coaxial cable (10 meters; cable loss of 4.9 dB)

Note: Total cable loss is 17.1 dB.

3. ARC Panel Antenna must be connected as follows:
 - 4 inch cable to connect U.FL to RPSMA (cable loss of 0.4 dB)
 - CFD-200 NL antenna cable (3 meters; cable loss of 2.00 dB)
 - Belden 7806R antenna cable (6 meters; cable loss of 4.00 dB)
 - Belden 7806R antenna cable (6 meters; cable loss of 4.00 dB)
 - LMR-400 coaxial cable (7 meters; cable loss of 1.8 dB)
 - LMR-400 coaxial cable (3 meters; cable loss of 0.8 dB)
 - Coleman 8421 coaxial cable (10 meters; cable loss of 4.9 dB)
 - LMR-400 coaxial cable (4 meters; cable loss of 1.2 dB)

Note: Total cable loss is 19.1 dB.

4. D-Link Antenna must be connected as follows:
 - 4 inch cable to connect U.FL to RPSMA (cable loss of 0.4 dB)
 - CFD-200 NL antenna cable (3 meters; cable loss of 2.00 dB)
 - Belden 7806R antenna cable (6 meters; cable loss of 4.00 dB)
 - Belden 7806R antenna cable (6 meters; cable loss of 4.00 dB)
 - LMR-400 coaxial cable (7 meters; cable loss of 1.8 dB)
 - Coleman 8421 coaxial cable (10 meters; cable loss of 4.9 dB)

Note: Total cable loss is 17.1 dB

EXHIBIT 6. MEASUREMENTS, EXAMINATIONS & TEST DATA FOR EMC EMISSIONS

6.1. TEST PROCEDURES

This section contains test results only. Details of test methods and procedures can be found in Exhibit 8 of this report, FCC procedures: Measurement of Digital Transmission Systems Operating under Section 15.247 (March 23, 2005) and ANSI C63.4.

6.2. MEASUREMENT UNCERTAINTIES

The measurement uncertainties stated were calculated in accordance with requirements of UKAS Document NIS 81 with a confidence level of 95%. Please refer to Exhibit 7 for Measurement Uncertainties.

6.3. MEASUREMENT EQUIPMENT USED

The measurement equipment used complied with the requirements of the Standards referenced in the Methods & Procedures ANSI C63.4, FCC Section 15.247 and CISPR 16-1.

6.4. ESSENTIAL/PRIMARY FUNCTIONS AS DECLARED BY THE MANUFACTURER

Wireless Modem.

6.5. COMPLIANCE WITH FCC PART 15 – GENERAL TECHNICAL REQUIREMENTS

FCC Section	FCC Rules	Manufacturer's Clarification
15.203	<p>Described how the EUT complies with the requirement that either its antenna is permanently attached, or that it employs a unique antenna connector, for every antenna proposed for use with the EUT.</p> <p>The exception is in those cases where EUT must be professionally installed. In order to demonstrate that professional installation is required, the following 3 points must be addressed:</p> <ul style="list-style-type: none">➤ The application (or intended use) of the EUT➤ The installation requirements of the EUT➤ The method by which the EUT will be marketed	<p>The antenna employs one of two unique antenna connectors: IPX or U.FL</p>
15.204	<p>Provided the information for every antenna proposed for use with the EUT:</p> <ul style="list-style-type: none">➤ type (e.g. Yagi, patch, grid, dish, etc...),➤ manufacturer and model number➤ gain with reference to an isotropic radiator	<p>Refer to Section 3.4 of this Test Report for details of antenna information.</p>

6.6. POWER LINE CONDUCTED EMISSIONS [§ 15.207 (a)]

6.6.1. Limits

The equipment shall meet the limits of the following table:

Frequency of emission (MHz)	Class B Conducted Limits (dB μ V)		Measuring Bandwidth
	Quasi-peak	Average	
0.15–0.5	66 to 56*	56 to 46*	RBW = 9 kHz VBW \geq 9 kHz for QP VBW = 1 Hz for Average
0.5–5	56	46	
5–30	60	50	

* Decreases linearly with logarithm of the frequency

6.6.2. Method of Measurements

Refer to Section 8 of this test report & ANSI C63.4.

6.6.3. Test Arrangement

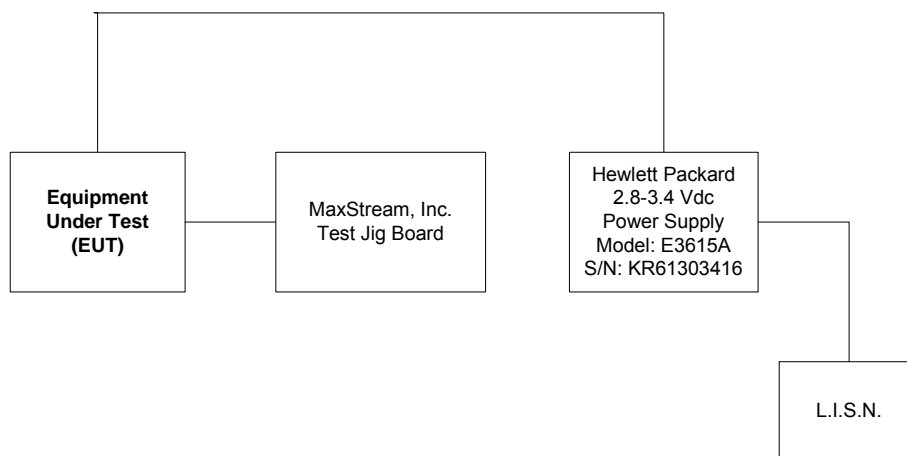

6.6.4. Test Equipment List

Test Instruments	Manufacturer	Model No.	Serial No.	Frequency Range
Spectrum Analyzer/EMI Receiver	Hewlett Packard	HP 8593EM	3412A00103	9 kHz – 26.5 GHz
Transient Limiter	Hewlett Packard	11947A	310701998	9 kHz – 200 MHz 10 dB attenuation
L.I.S.N.	EMCO	3825/2	89071531	9 kHz – 200 MHz 50 Ohms / 50 μ H
24'(L) x 16'(W) x 8'(H) RF Shielded Chamber	Braden Shielding

6.6.5. Test Data

Frequency (MHz)	RF Level (dBμV)	Receiver Detector (P/QP/AVG)	QP Limit (dBuV)	AVG Limit (dBuV)	Margin (dB)	Pass/ Fail	Line Tested (L1/L2)
Test Configuration #1: Transmitter Mode							
0.15	57.3	QP	66.0	56.0	-8.7	Pass	Positive
0.15	43.2	AVG	66.0	56.0	-12.8	Pass	Positive
16.0	33.8	QP	60.0	50.0	-26.2	Pass	Positive
16.0	29.3	AVG	60.0	50.0	-20.7	Pass	Positive
Test Configuration #2: Receiver Mode							
0.15	57.5	QP	66.0	56.0	-8.5	Pass	Negative
0.15	43.5	AVG	66.0	56.0	-12.5	Pass	Negative
16.0	26.0	QP	60.0	50.0	-34.0	Pass	Negative
16.0	20.9	AVG	60.0	50.0	-29.1	Pass	Negative
Test Configuration #3: Receiver Mode							
0.17	44.5	QP	65.0	55.0	-20.5	Pass	Positive
0.17	40.2	AVG	65.0	55.0	-14.8	Pass	Positive
0.71	33.1	QP	56.0	46.0	-22.9	Pass	Positive
0.71	30.6	AVG	56.0	46.0	-15.4	Pass	Positive
1.63	29.3	QP	56.0	46.0	-26.7	Pass	Positive
1.63	26.6	AVG	56.0	46.0	-19.4	Pass	Positive
16.0	35.8	QP	60.0	50.0	-24.2	Pass	Positive
16.0	35.1	AVG	60.0	50.0	-14.9	Pass	Positive
Test Configuration #4: Receiver Mode							
0.17	44.6	QP	65.0	55.0	-20.4	Pass	Negative
0.17	40.4	AVG	65.0	55.0	-14.6	Pass	Negative
0.71	36.7	QP	56.0	46.0	-19.3	Pass	Negative
0.71	35.2	AVG	56.0	46.0	-10.8	Pass	Negative
1.63	33.0	QP	56.0	46.0	-23.0	Pass	Negative
1.63	30.8	AVG	56.0	46.0	-15.2	Pass	Negative
16.0	29.1	QP	60.0	50.0	-30.9	Pass	Negative
16.0	27.7	AVG	60.0	50.0	-22.3	Pass	Negative

Note: See the following test data plots (#1 to 4) for detailed measurements.

Test Configuration #1: Transmitter Mode

Plot 1:
 Power Line Conducted Emissions
 Line Voltage: 2.8 Vdc
 Line Tested: Positive

hp

Signal	Freq (MHz)	PK Amp	QP Amp	AV Amp	AV Δ L2
1	0.150725	60.4	57.3	43.2	-12.8
2	16.000613	36.8	33.8	29.3	-20.7

ACTV DET: PEAK
 MEAS DET: PEAK QP AVG
 MKR 15.95 MHz
 31.09 dB μ V

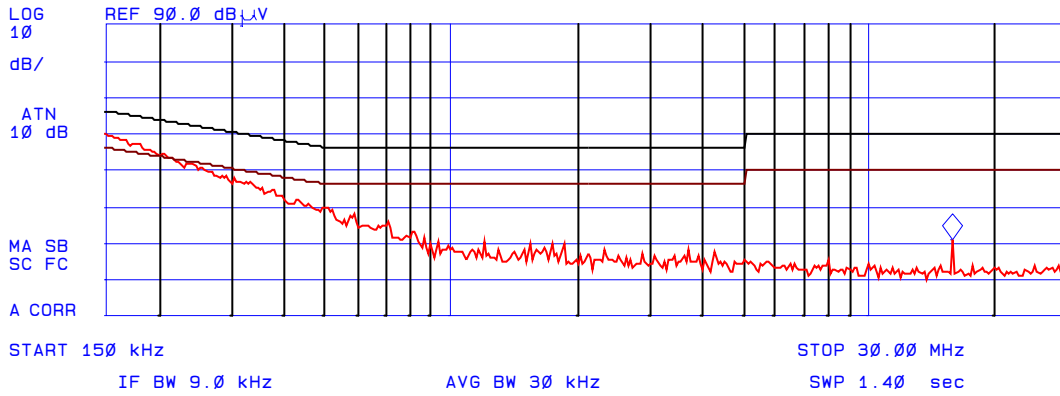

Plot 2:
 Power Line Conducted Emissions
 Line Voltage: 2.8 Vdc
 Line Tested: Negative

177

Signal Freq (MHz)	PK Amp	QP Amp	AV Amp	AV Δ L2
1	0.150375	60.7	57.5	43.5 -12.5
2	16.001125	30.4	26.0	20.9 -29.1

ACTV DET: PEAK
 MEAS DET: PEAK QP AVG
 MKR 15.95 MHz
 27.12 dB μ V

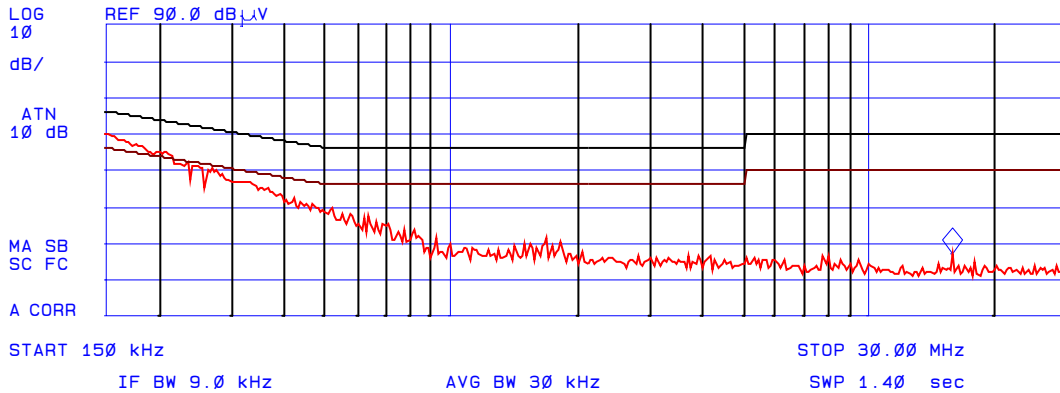

ULTRATECH GROUP OF LABS

3000 Bristol Circle, Oakville, Ontario, Canada L6H 6G4
 Tel. #: 905-829-1570, Fax. #: 905-829-8050, Email: vic@ultratech-labs.com, Website: <http://www.ultratech-labs.com>

File #: MXS--050F15C247
 September 22, 2005

All test results contained in this engineering test report are traceable to National Institute of Standards and Technology (NIST)

Test Configuration #2: Receiver Mode

Plot 3:
 Power Line Conducted Emissions
 Line Voltage: 2.8 Vdc
 Line Tested: Positive

177

Signal	Freq (MHz)	PK Amp	QP Amp	AV Amp	AV Δ L2
1	0.168495	47.5	44.5	40.2	-14.9
2	0.705733	36.3	33.1	30.6	-15.4
3	1.626998	33.1	29.3	26.6	-19.4
4	16.000049	37.5	35.8	35.1	-14.9

ACTV DET: PEAK
 MEAS DET: PEAK QP AVG
 MKR 15.95 MHz
 34.06 dB μ V

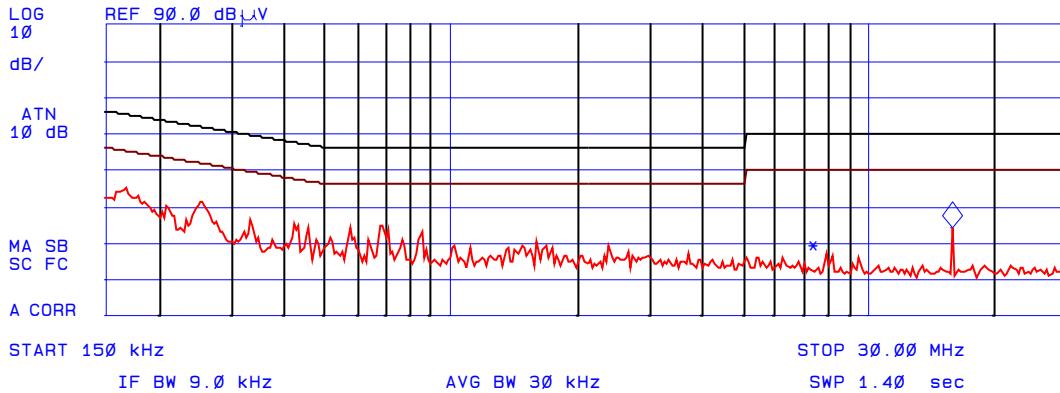

Plot 4:
 Power Line Conducted Emissions
 Line Voltage: 2.8 Vdc
 Line Tested: Negative

hp

Signal	Freq (MHz)	PK Amp	QP Amp	AV Amp	AV Δ L2
1	0.168500	47.9	44.6	40.4	-14.7
2	0.705738	39.1	36.7	35.2	-10.8
3	1.627000	35.3	33.0	30.8	-15.2
4	16.000050	31.7	29.1	27.7	-22.3

ACTV DET: PEAK
 MEAS DET: PEAK QP AVG
 MKR 15.95 MHz
 28.29 dB μ V

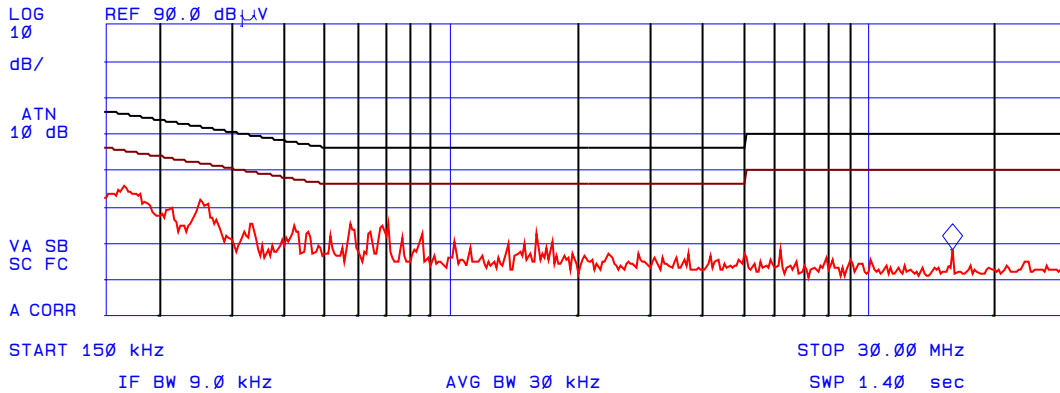

6.7. 6 dB BANDWIDTH [§ 15.247 (a) (2)]

6.7.1. Limits

For a Digital Modulation System, the 6 dB bandwidth shall be at least 500 kHz.

6.7.2. Method of Measurements

Refer to ANSI C63.4 and FCC Procedures (March 23, 2005) for Digital Transmission Systems operating under 15.247.

The transmitter output was connected to the spectrum analyzer. The bandwidth of the fundamental frequency was measured with the spectrum analyzer using 100 kHz RBW and VBW=300 kHz.

6.7.3. Test Arrangement



6.7.4. Test Equipment List

Test Instruments	Manufacturer	Model No.	Serial No.	Frequency Range
Spectrum Analyzer	Rohde & Schwarz	FSEK20/B4/B21	834157/005	9 kHz – 40 GHz

6.7.5. Test Data

Frequency (MHz)	6 dB Bandwidth (MHz)	Minimum Limit (MHz)	Pass/Fail
2410	1.59	0.5	Pass
2440	1.6	0.5	Pass
2470	1.6	0.5	Pass

Please refer to Plot#5 to 7 for detailed measurements.

Plot #5:
6 dB Bandwidth
Test Frequency: 2410 MHz

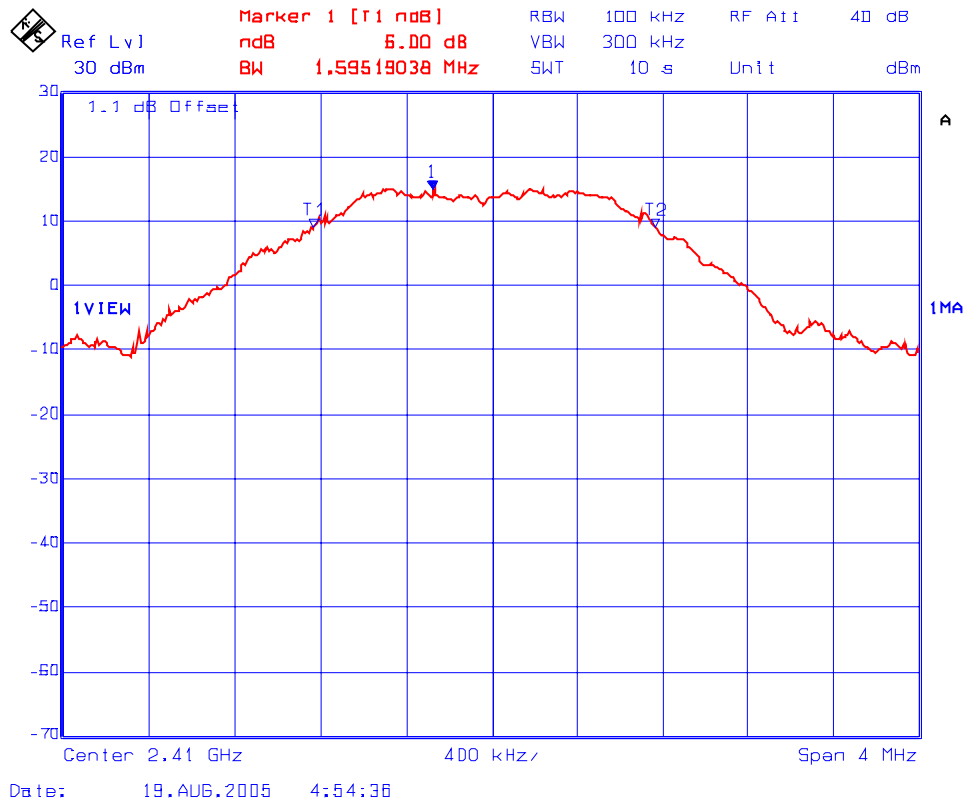

ULTRATECH GROUP OF LABS

3000 Bristol Circle, Oakville, Ontario, Canada L6H 6G4
Tel. #: 905-829-1570, Fax. #: 905-829-8050, Email: vic@ultratech-labs.com, Website: <http://www.ultratech-labs.com>

File #: MXS--050F15C247
September 22, 2005

All test results contained in this engineering test report are traceable to National Institute of Standards and Technology (NIST)

Plot #6:
6 dB Bandwidth
Test Frequency: 2440 MHz

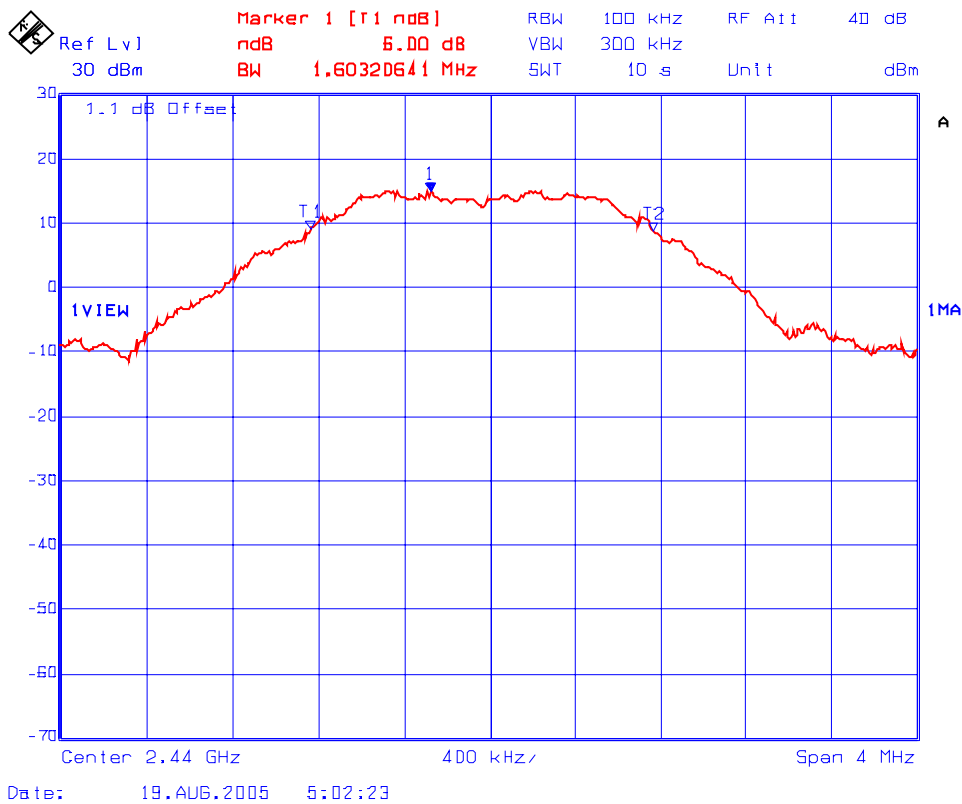

ULTRATECH GROUP OF LABS

3000 Bristol Circle, Oakville, Ontario, Canada L6H 6G4
Tel. #: 905-829-1570, Fax. #: 905-829-8050, Email: vic@ultratech-labs.com, Website: <http://www.ultratech-labs.com>

File #: MXS--050F15C247
September 22, 2005

All test results contained in this engineering test report are traceable to National Institute of Standards and Technology (NIST)

Plot #7:
6 dB Bandwidth
Test Frequency: 2470 MHz

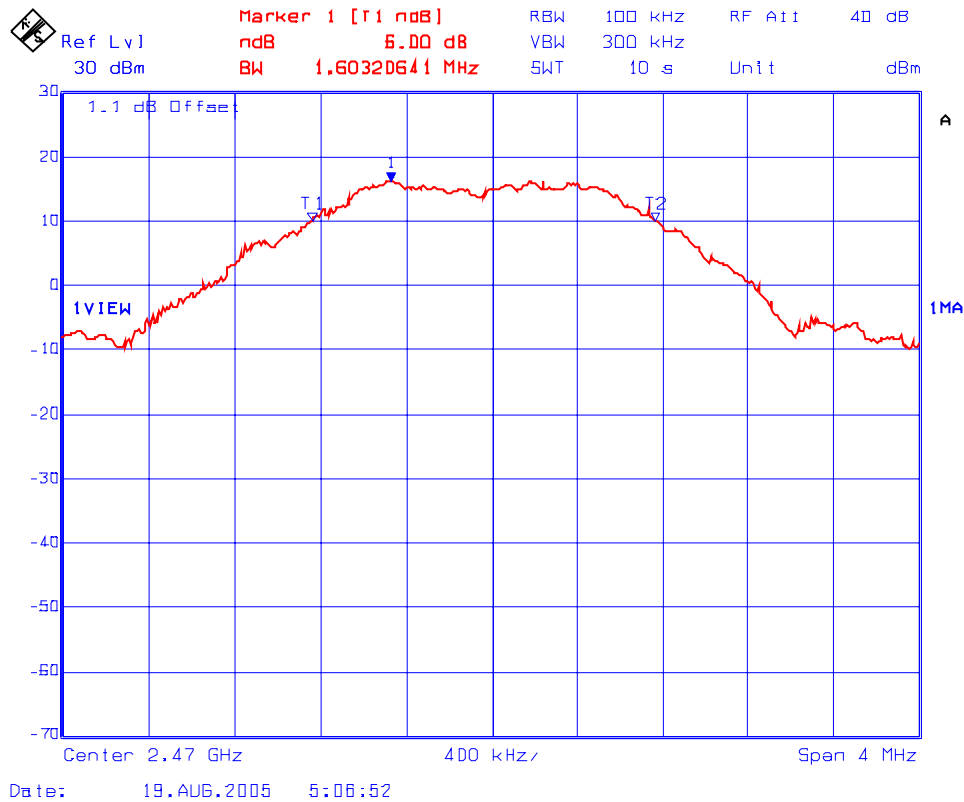

ULTRATECH GROUP OF LABS

3000 Bristol Circle, Oakville, Ontario, Canada L6H 6G4
Tel. #: 905-829-1570, Fax. #: 905-829-8050, Email: vic@ultratech-labs.com, Website: <http://www.ultratech-labs.com>

File #: MXS--050F15C247
September 22, 2005

All test results contained in this engineering test report are traceable to National Institute of Standards and Technology (NIST)

6.8. PEAK OUTPUT POWER (CONDUCTED) [§ 15.247(b)]

6.8.1. Limits

§15.247(b)(3): The maximum peak conducted output power of the transmitter shall not exceed 1 watt.

§15.247(b)(4): If the antennas of directional gain greater than 6 dBi are used, the peak power from the intentional radiator shall be reduced below, as appropriate, by the amount in dB that the directional gain of the antenna exceeds 6 dBi.

6.8.2. Method of Measurements

Refer to Exhibit 8, FCC Procedures for Digital Transmission Systems (March 23, 2005) and ANSI C63.4.

6.8.3. Test Arrangement

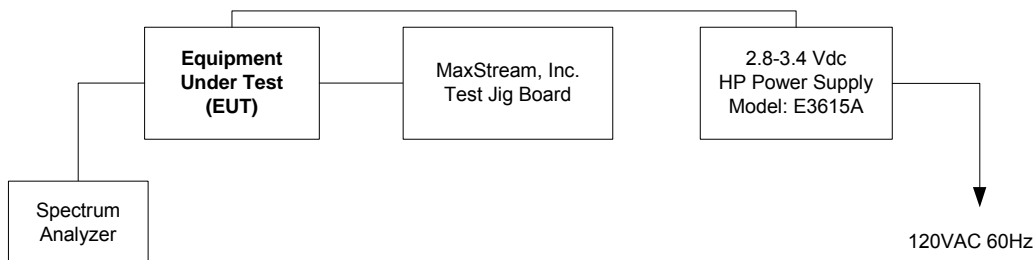

6.8.4. Test Equipment List

Test Instruments	Manufacturer	Model No.	Serial No.	Frequency Range
Spectrum Analyzer	Rohde & Schwarz	FSEK20/B4/B21	834157/005	9 kHz – 40 GHz

6.8.5. Test Data

6.8.5.1. EUT tested with Chip Antenna (Max. Antenna Gain = - 1.5 dBi)

Transmitter Channel	Frequency (MHz)	Peak Power at Antenna Terminal (dBm)	⁽¹⁾ Calculated EIRP (dBm)	Conducted Power Limit (dBm)	EIRP Limit (dBm)
Low Power Setting					
Lowest	2410	9.93	8.43	30.0	36.0
Middle	2440	9.79	8.29	30.0	36.0
Highest	2470	10.41	8.91	30.0	36.0
High Power Setting					
Lowest	2410	18.70	17.2	30.0	36.0
Middle	2440	18.48	16.98	30.0	36.0
Highest	2470	19.34	17.84	30.0	36.0

Note 1:

EIRP calculation:

EIRP = (Peak power at antenna terminal in dBm) + (EUT Antenna gain in dBi)

6.8.5.2. EUT tested with Maxrad Yagi Antenna (Max. Antenna Gain = 15 dBi; Cable Loss = 17.1 dB)

Transmitter Channel	Frequency (MHz)	Peak Power at Antenna Terminal (dBm)	⁽¹⁾ Calculated EIRP (dBm)	Conducted Power Limit (dBm)	EIRP Limit (dBm)
Low Power Setting					
Lowest	2410	9.93	7.93	30.0	36.0
Middle	2440	9.79	7.69	30.0	36.0
Highest	2470	10.41	8.31	30.0	36.0
High Power Setting					
Lowest	2410	18.70	16.6	30.0	36.0
Middle	2440	18.48	16.38	30.0	36.0
Highest	2470	19.34	17.24	30.0	36.0

Note 1:

The following cables were used for EUT tested with Maxrad Yagi Antenna:

- 4inch cable to connect U.FL to RPSMA (cable loss of 0.4 dB)
- CFD-200 NL antenna cable (3 meters; cable loss of 2.00 dB)
- Belden 7806R antenna cable (6 meters; cable loss of 4.00 dB)
- Belden 7806R antenna cable (6 meters; cable loss of 4.00 dB)
- LMR-400 coaxial cable (7 meters; cable loss of 1.8 dB)
- Coleman 8421 coaxial cable (10 meters; cable loss of 4.9 dB)

EIRP calculation:

EIRP = (Peak power at antenna terminal in dBm) + (EUT Antenna gain in dBi) – (Total Cable Loss in dB)

ULTRATECH GROUP OF LABS

3000 Bristol Circle, Oakville, Ontario, Canada L6H 6G4
 Tel. #: 905-829-1570, Fax. #: 905-829-8050, Email: vic@ultratech-labs.com, Website: <http://www.ultratech-labs.com>

File #: MXS--050F15C247
 September 22, 2005

All test results contained in this engineering test report are traceable to National Institute of Standards and Technology (NIST)

6.8.5.3. EUT tested with ARC Panel Antenna (Max. Antenna Gain = 19 dBi; Cable Loss = 19.1 dB)

Transmitter Channel	Frequency (MHz)	Peak Power at Antenna Terminal (dBm)	⁽¹⁾ Calculated EIRP (dBm)	Conducted Power Limit (dBm)	EIRP Limit (dBm)
Low Power Setting					
Lowest	2410	9.93	9.83	30.0	36.0
Middle	2440	9.79	9.69	30.0	36.0
Highest	2470	10.41	10.31	30.0	36.0
High Power Setting					
Lowest	2410	18.70	18.60	30.0	36.0
Middle	2440	18.48	18.38	30.0	36.0
Highest	2470	19.34	19.24	30.0	36.0

Note1:

The following cables were used for EUT tested with ARC Panel Antenna:

- 4 inch cable to connect U.FL to RPSMA (cable loss of 0.4 dB)
- CFD-200 NL antenna cable (3 meters; cable loss of 2.00 dB)
- Belden 7806R antenna cable (6 meters; cable loss of 4.00 dB)
- Belden 7806R antenna cable (6 meters; cable loss of 4.00 dB)
- LMR-400 coaxial cable (7 meters; cable loss of 1.8 dB)
- LMR-400 coaxial cable (3 meters; cable loss of 0.8 dB)
- Coleman 8421 coaxial cable (10 meters; cable loss of 4.9 dB)
- LMR-400 coaxial cable (4 meters; cable loss of 1.2 dB)

EIRP calculation:

$$\text{EIRP} = (\text{Peak power at antenna terminal in dBm}) + (\text{EUT Antenna gain in dBi}) - (\text{Total Cable Loss})$$

6.8.5.4. EUT tested with D-Link Antenna (Max. Antenna Gain = 15 dBi, Cable Loss = 17.1 dB)

Transmitter Channel	Frequency (MHz)	Peak Power at Antenna Terminal (dBm)	⁽¹⁾ Calculated EIRP (dBm)	Conducted Power Limit (dBm)	EIRP Limit (dBm)
Low Power Setting					
Lowest	2410	9.93	7.83	30.0	36.0
Middle	2440	9.79	7.69	30.0	36.0
Highest	2470	10.41	8.31	30.0	36.0
High Power Setting					
Lowest	2410	18.70	16.6	30.0	36.0
Middle	2440	18.48	16.38	30.0	36.0
Highest	2470	19.34	17.24	30.0	36.0

Note 1:

The following cables were used for EUT tested with D-Link Antenna:

- 4 inch cable to connect U.FL to RPSMA (cable loss of 0.4 dB)
- CFD-200 NL antenna cable (3 meters; cable loss of 2.00 dB)

ULTRATECH GROUP OF LABS

3000 Bristol Circle, Oakville, Ontario, Canada L6H 6G4
 Tel. #: 905-829-1570, Fax. #: 905-829-8050, Email: vic@ultratech-labs.com, Website: <http://www.ultratech-labs.com>

File #: MXS--050F15C247
 September 22, 2005

All test results contained in this engineering test report are traceable to National Institute of Standards and Technology (NIST)

- Belden 7806R antenna cable (6 meters; cable loss of 4.00 dB)
- Belden 7806R antenna cable (6 meters; cable loss of 4.00 dB)
- LMR-400 coaxial cable (7 meters; cable loss of 1.8 dB)
- Coleman 8421 coaxial cable (10 meters; cable loss of 4.9 dB)

EIRP calculation:

EIRP = (Peak power at antenna terminal in dBm) + (EUT Antenna gain in dBi) – (Total Cable Loss)

6.9. RF EXPOSURE REQUIREMENTS [§§ 15.247 (i), 1.1310]

6.9.1. Limits

§ 15.247 (i): Systems operating under the provisions of this section shall be operated in a manner that ensures that the public is not exposed to radio frequency energy levels in excess of the Commission’s guidelines. See § 1.1307 (b) (1).

§ 1.1310: The criteria listed in the following table shall be used to evaluate the environmental impact of human exposure to radio-frequency (RF) radiation as specified in 1.1307(b).

TABLE 1—LIMITS FOR MAXIMUM PERMISSIBLE EXPOSURE (MPE)

Frequency range (MHz)	Electric field strength (V/m)	Magnetic field strength (A/m)	Power density (mW/cm ²)	Averaging time (minutes)
(A) Limits for Occupational/Controlled Exposures				
0.3–3.0	614	1.63	*(100)	6
3.0–30	1842/f	4.89/f	*(900/f ²)	6
30–300	61.4	0.163	1.0	6
300–1500	f/300	6
1500–100,000	5	6
(B) Limits for General Population/Uncontrolled Exposure				
0.3–1.34	614	1.63	*(100)	30
1.34–30	824/f	2.19/f	*(180/f ²)	30
30–300	27.5	0.073	0.2	30
300–1500	f/1500	30
1500–100,000	1.0	30

f = frequency in MHz

* = Plane-wave equivalent power density

NOTE 1 TO TABLE 1: Occupational/controlled limits apply in situations in which persons are exposed as a consequence of their employment provided those persons are fully aware of the potential for exposure and can exercise control over their exposure. Limits for occupational/controlled exposure also apply in situations when an individual is transient through a location where occupational/controlled limits apply provided he or she is made aware of the potential for exposure.

NOTE 2 TO TABLE 1: General population/uncontrolled exposures apply in situations in which the general public may be exposed, or in which persons that are exposed as a consequence of their employment may not be fully aware of the potential for exposure or can not exercise control over their exposure.

6.9.2. Method of Measurements

Refer to FCC @ 1.1310, 2.1091 and Public Notice DA 00-705 (March 30, 2000).

Spread spectrum transmitters operating under Section 15.247 are categorically excluded from routine environmental evaluation for demonstrating RF exposure compliance with respect to MPE and/or SAR limits. These devices are not exempted from compliance. As indicated in Section 15.247 (b) (4), these transmitters are required to operate in a manner that ensures that exposure to the public (users and nearby persons) does not exceed the Commission’s RF exposure guidelines (see Sections 1.1307, 2.1091 and 2.1093). Unless a device operates at substantially low output power levels, with a low gain antenna (s), supporting information is generally needed to establish the various potential operating configurations and exposure conditions of a transmitter and its antenna(s), in order to determine compliance with the RF exposure guidelines.

- In order to demonstrate compliance with MPE requirements (see Section 2.1091), the following information is typically needed:
 - (1) Calculation that estimates the minimum separation distance (20 cm or more) between an antenna and persons required to satisfy power density limits defined for free space.
 - (2) Antenna installation and device operating instructions for installers (professional/unskilled users), and the parties responsible for ensuring compliance with the RF exposure requirement
 - (3) Any caution statements and/or warning labels that are necessary in order to comply with the exposure limits
 - (4) Any other RF exposure related issues that may affect MPE compliance

Calculation Method of RF Safety Distance:

$$S = PG/4\pi r^2 = EIRP/4\pi r^2$$

Where: P: power input to the antenna in mW
EIRP: Equivalent (effective) isotropic radiated power
S: power density mW/cm²
G: numeric gain of antenna relative to isotropic radiator
r: distance to centre of radiation in cm

$$r = \sqrt{PG/4\pi S}$$

- For portable transmitters (see Section 2.1093), or devices designed to operate next to a person's body, compliance is determined with respect to the SAR limit (define in the body tissues) for near-field exposure conditions. If the maximum average output power, operating condition configurations and exposure conditions are comparable to those of existing cellular and PCS phones., an SAR evaluation may be required in order to determine if such a device complies with SAR limit. When SAR evaluation data is not available, and the additional supporting information cannot assure compliance, the Commission may request that an SAR evaluation be performed, as provided for in Section 1.1307(d).

6.9.3. MPE Evaluation

Evaluation of RF Exposure Compliance Requirements for Base Unit	
RF Exposure Requirements	Compliance with FCC Rules
Minimum calculated separation distance between antenna and persons required: *2.6 cm	Manufacturer's instruction for separation distance between antenna and persons required: 20 cm.
Antenna installation and device operating instructions for installers (professional/unskilled users), and the parties responsible for ensuring compliance with the RF exposure requirement	Antenna installation and device operating instructions shall be provided to end users to maintain and ensure compliance with RF exposure requirements.
Caution statements and/or warning labels that are necessary in order to comply with the exposure limits	Please refer to User's Manual for RF Exposure Information.
Any other RF exposure related issues that may affect MPE compliance	None.

*The minimum separation distance between the antenna and bodies of users are calculated using the following formula:

$$\text{RF EXPOSURE DISTANCE LIMITS: } r = (PG/4\pi S)^{1/2} = (EIRP/4\pi S)^{1/2}$$

$$S = 1.0 \text{ mW/cm}^2$$

$$EIRP = 19.24 \text{ dBm} = 83.95 \text{ mW (Max. EIRP = worst case)}$$

$$r = (EIRP/4\pi S)^{1/2} = (83.95/4\pi(1.0))^{1/2} = 2.6 \text{ cm}$$

6.10. TRANSMITTER BAND-EDGE & SPURIOUS CONDUCTED EMISSIONS [§ 15.247(d)]

6.10.1. Limits

In any 100 kHz bandwidth outside the operating frequency band, the radio frequency power that is produced by the intentional radiator shall be at least 20 dB below that in the 100 kHz bandwidth within the band that contains the highest level of the desired power, based on either an RF conducted or radiated measurement.

6.10.2. Method of Measurements

Refer to Exhibit 8 of this test report and FCC procedures for Digital Transmission Systems (March 23, 2005).

6.10.3. Test Arrangement

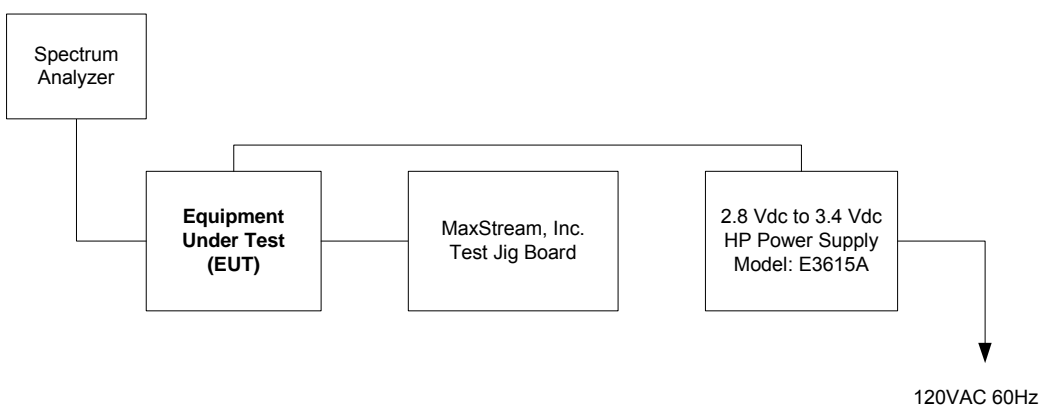

6.10.4. Test Equipment List

Test Instruments	Manufacturer	Model No.	Serial No.	Frequency Range
Spectrum Analyzer	Rhode & Schwarz	FSEK20/B4/B21	834157/005	9kHz – 40GHz

6.10.5. Test Data

6.10.5.1. Band-Edge RF Conducted Emissions

Refer to the following test data plots (8 to 9) for measurements results of Band-edge emissions at lower and upper permitted frequency band.

Plot#8:
Band-Edge RF Conducted Emissions
Low End of Frequency Band
Test Frequency: 2410 MHz

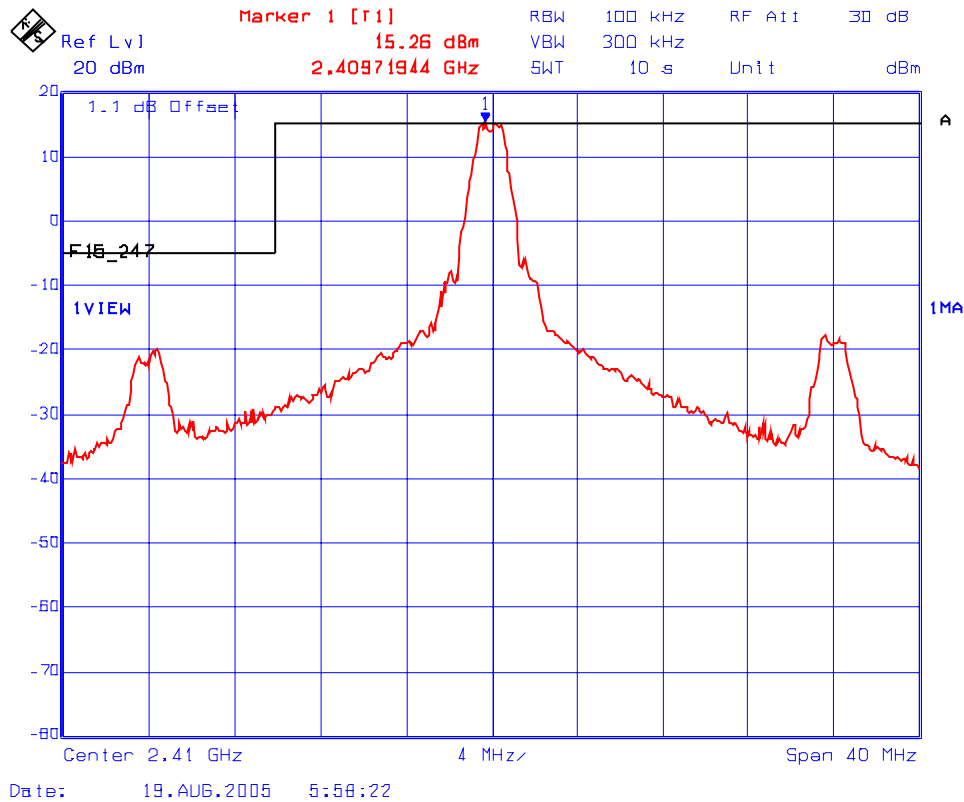

Plot#9:
Band-Edge RF Conducted Emissions
High End of Frequency Band
Test Frequency: 2470 MHz

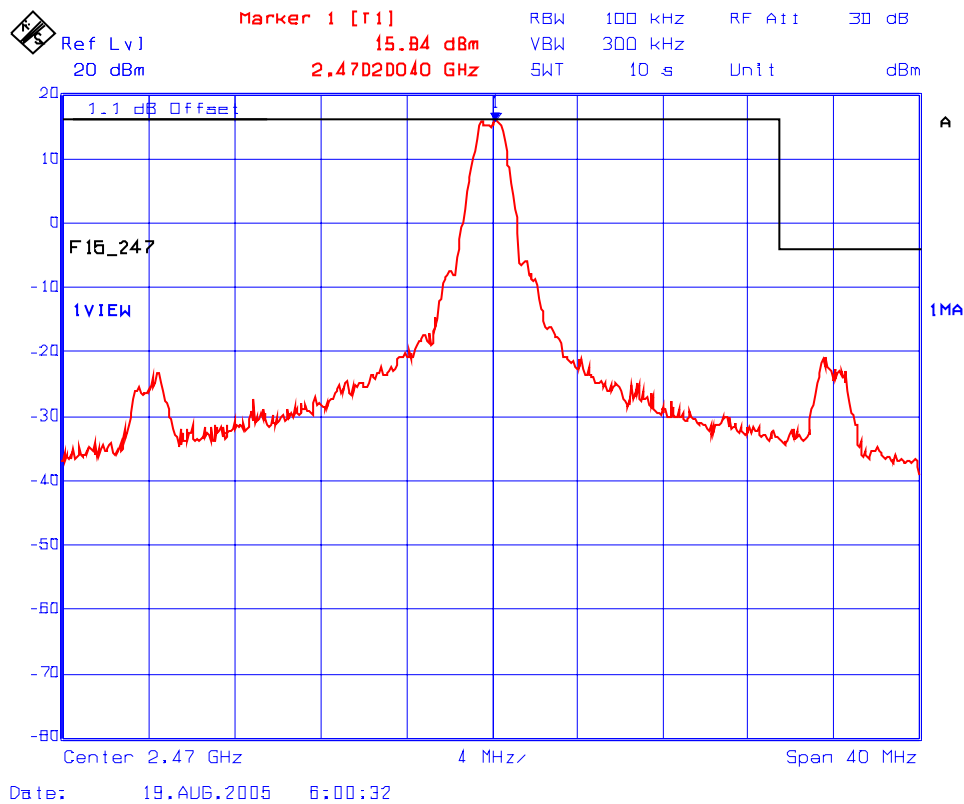

6.10.5.2. Spurious RF Conducted Emissions

6.10.5.2.1. Lowest Frequency (2410 MHz)

The emissions were scanned from 10 MHz to 25 GHz; refer to the following test data (plots 10 to 13) for measurement results.

Plot#10:
Spurious RF Conducted Emissions, Low Power Setting
Transmitter Frequency: 2410 MHz

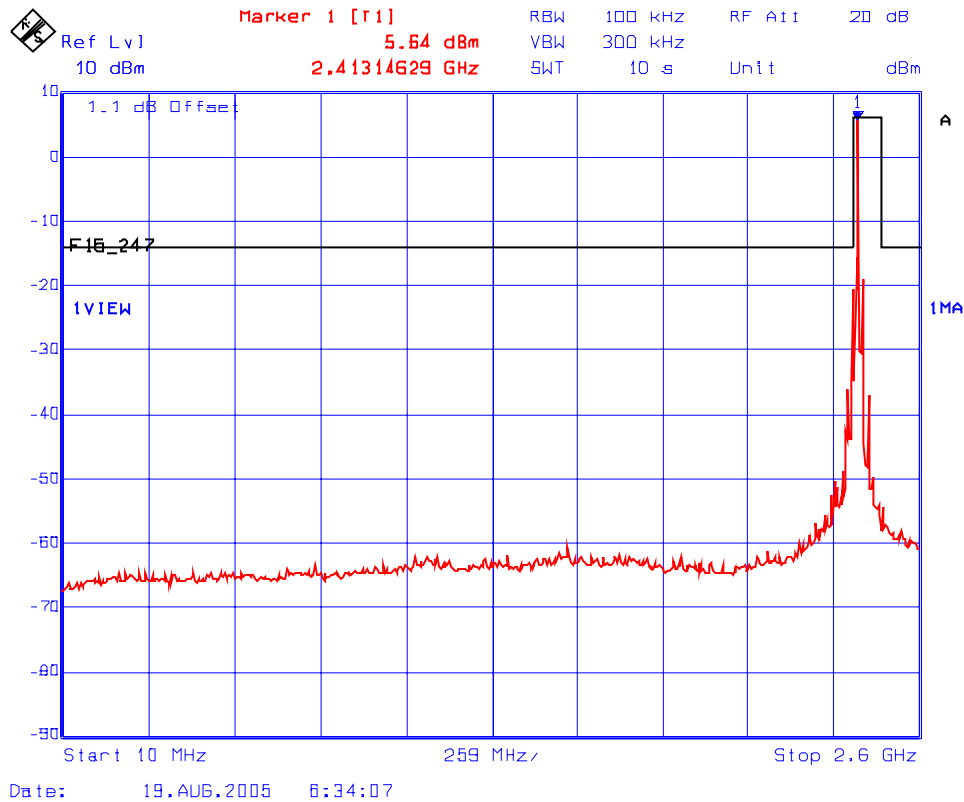

Plot#11:
 Spurious RF Conducted Emissions, Low Power Setting
 Transmitter Frequency: 2410 MHz

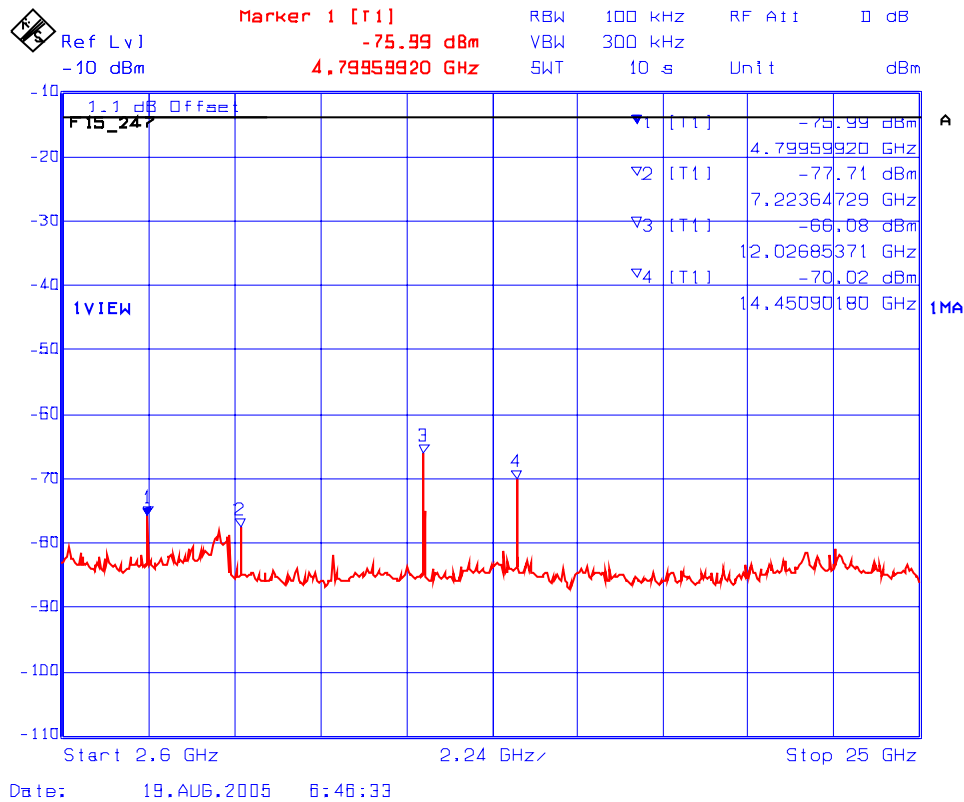

Plot#12:
Spurious RF Conducted Emissions, High Power Setting
Transmitter Frequency: 2410 MHz

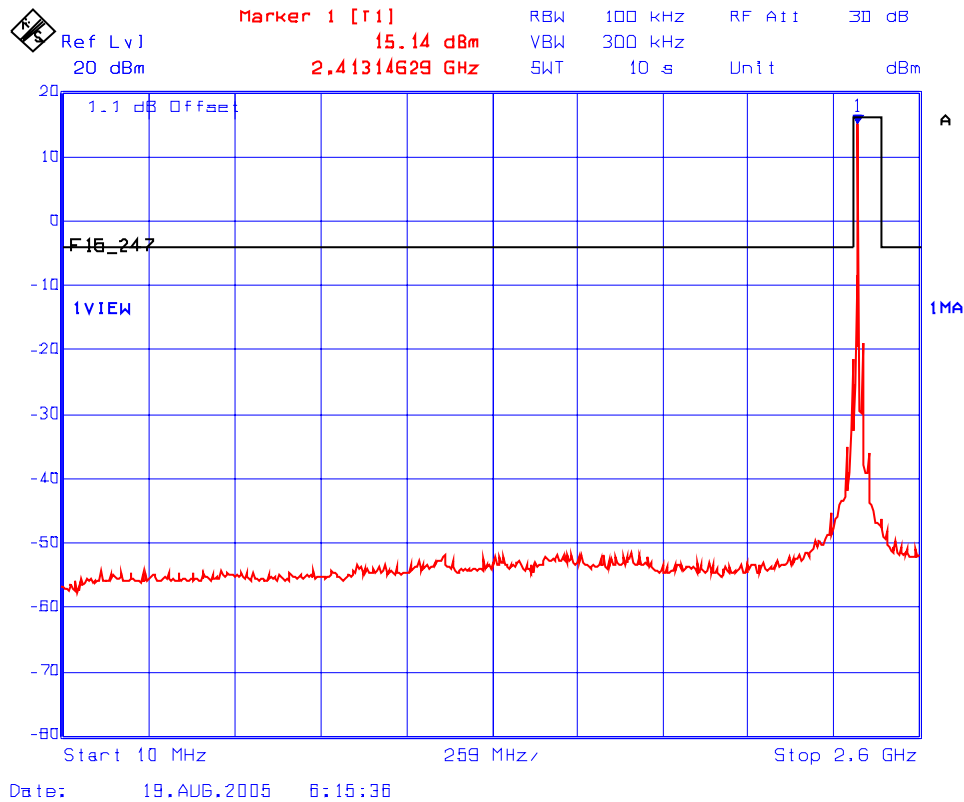

Plot#13:
 Spurious RF Conducted Emissions, High Power Setting
 Transmitter Frequency: 2410 MHz

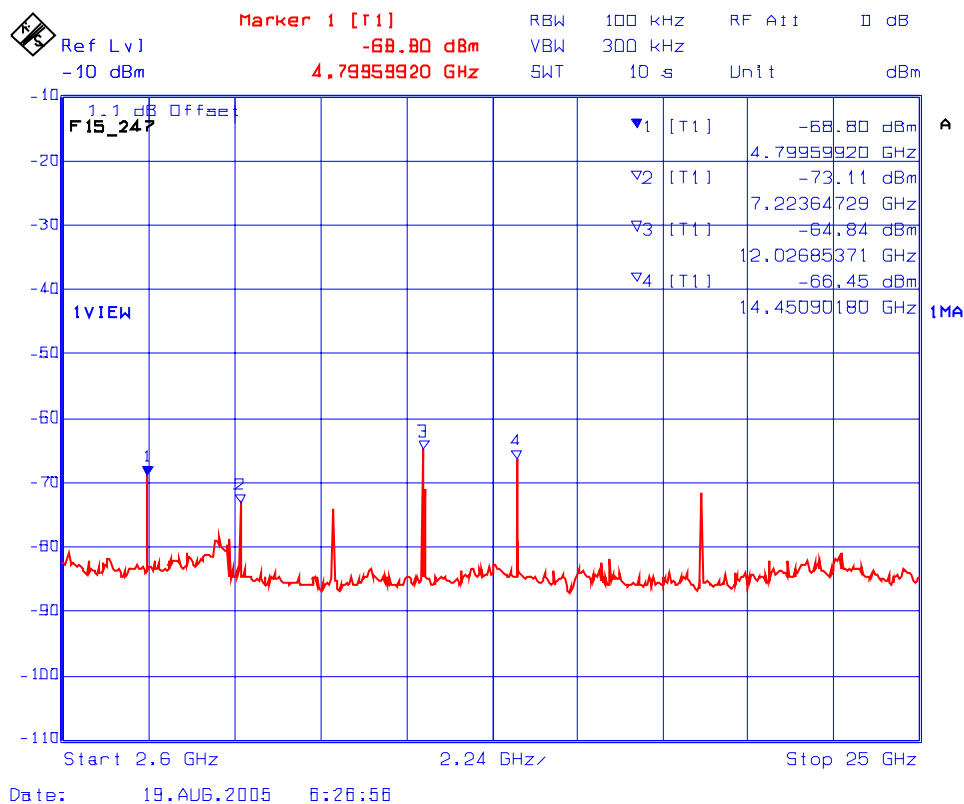

ULTRATECH GROUP OF LABS

3000 Bristol Circle, Oakville, Ontario, Canada L6H 6G4
 Tel. #: 905-829-1570, Fax. #: 905-829-8050, Email: yic@ultratech-labs.com, Website: <http://www.ultratech-labs.com>

File #: MXS--050F15C247
 September 22, 2005

All test results contained in this engineering test report are traceable to National Institute of Standards and Technology (NIST)

6.10.5.2.2. Middle Frequency (2440 MHz)

The emissions were scanned from 10 MHz to 25 GHz; refer to the following test data (plots 14 to 17) for measurements results.

Plot 14:
Spurious RF Conducted Emissions, Low Power Setting
Transmitter Frequency: 2440 MHz

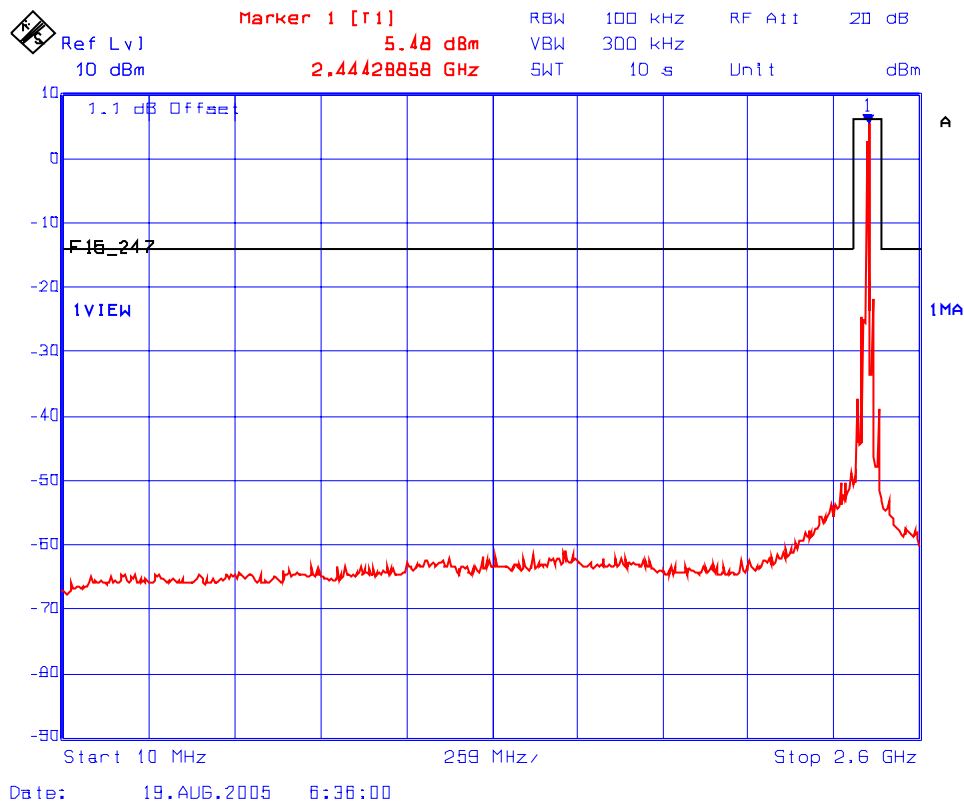

Plot#15:
 Spurious RF Conducted Emissions, Low Power Setting
 Transmitter Frequency: 2440 MHz

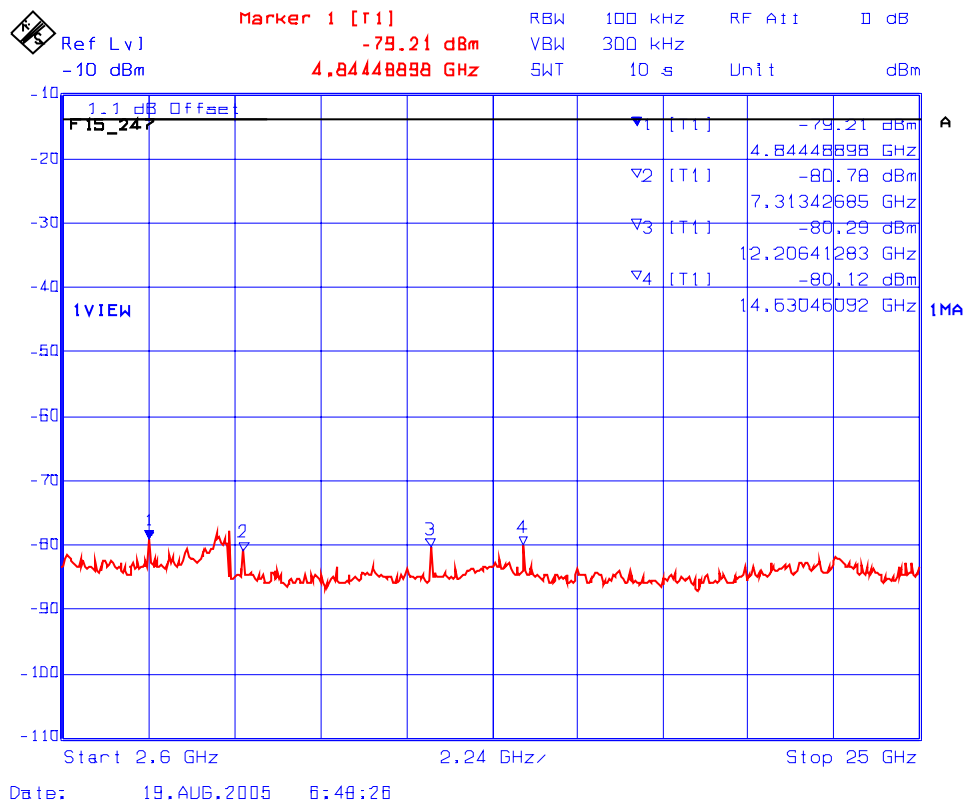

Plot#16:
Spurious RF Conducted Emissions, High Power Setting
Transmitter Frequency: 2440 MHz

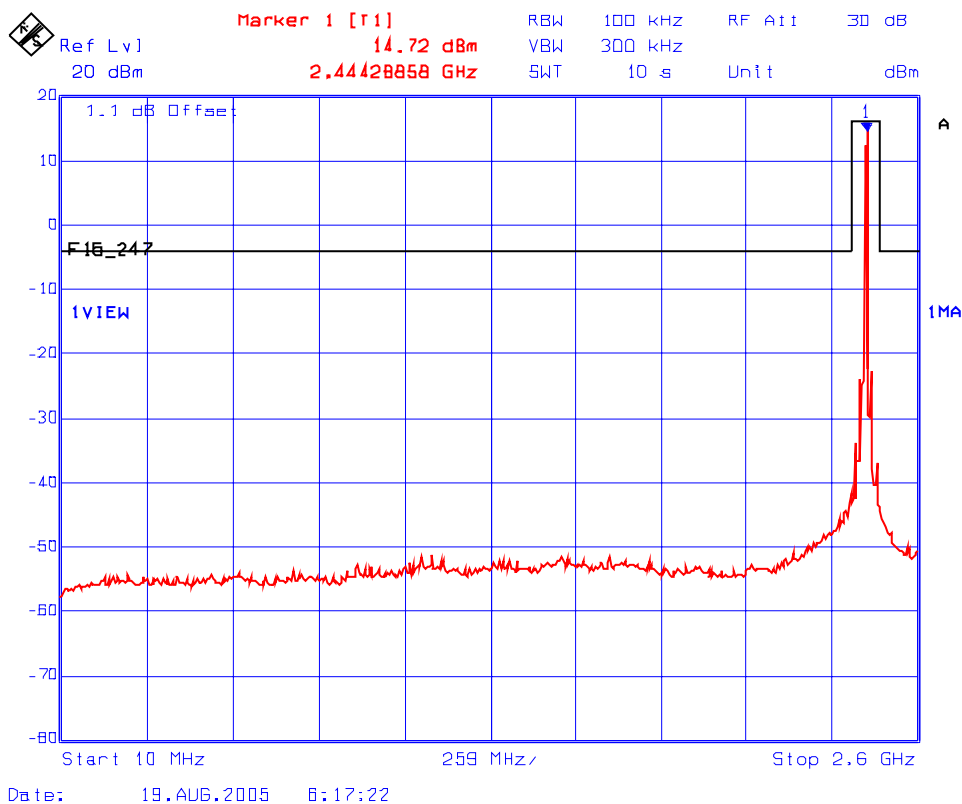

Plot#17:
 Spurious RF Conducted Emissions, High Power Setting
 Transmitter Frequency: 2440 MHz

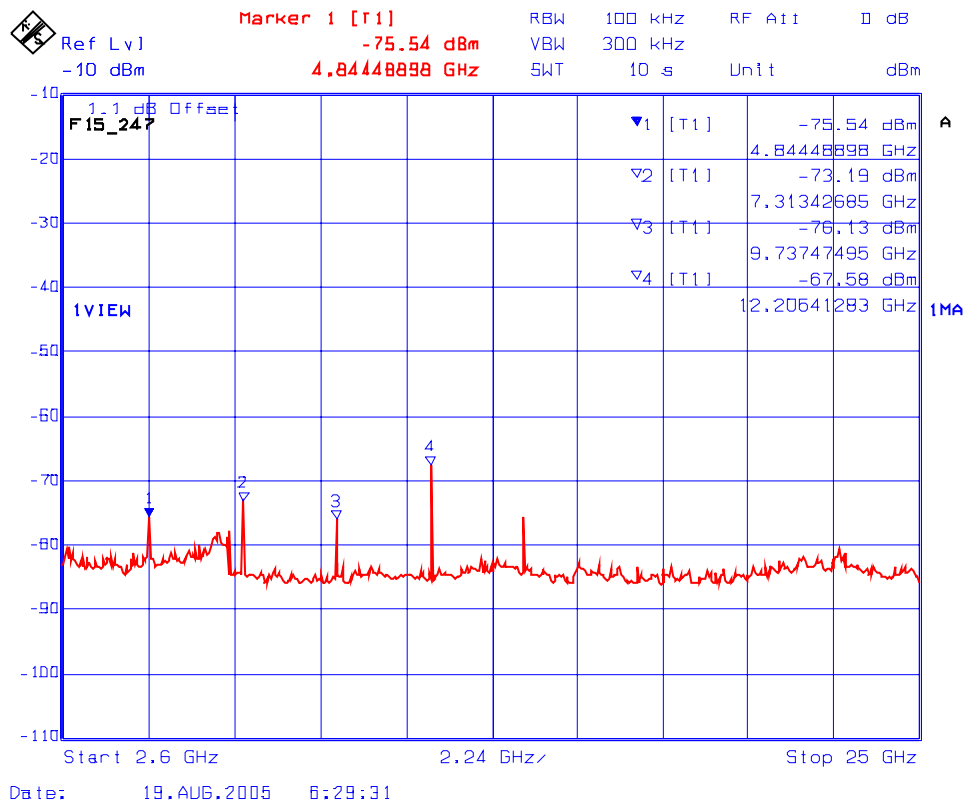

6.10.5.2.3. Highest Frequency (2470 MHz)

The emissions were scanned from 10 MHz to 25 GHz; refer to the following test data (plots 18 to 21) for measurements results.

Plot#18:
Spurious RF Conducted Emissions, Low Power Setting
Transmitter Frequency: 2470 MHz

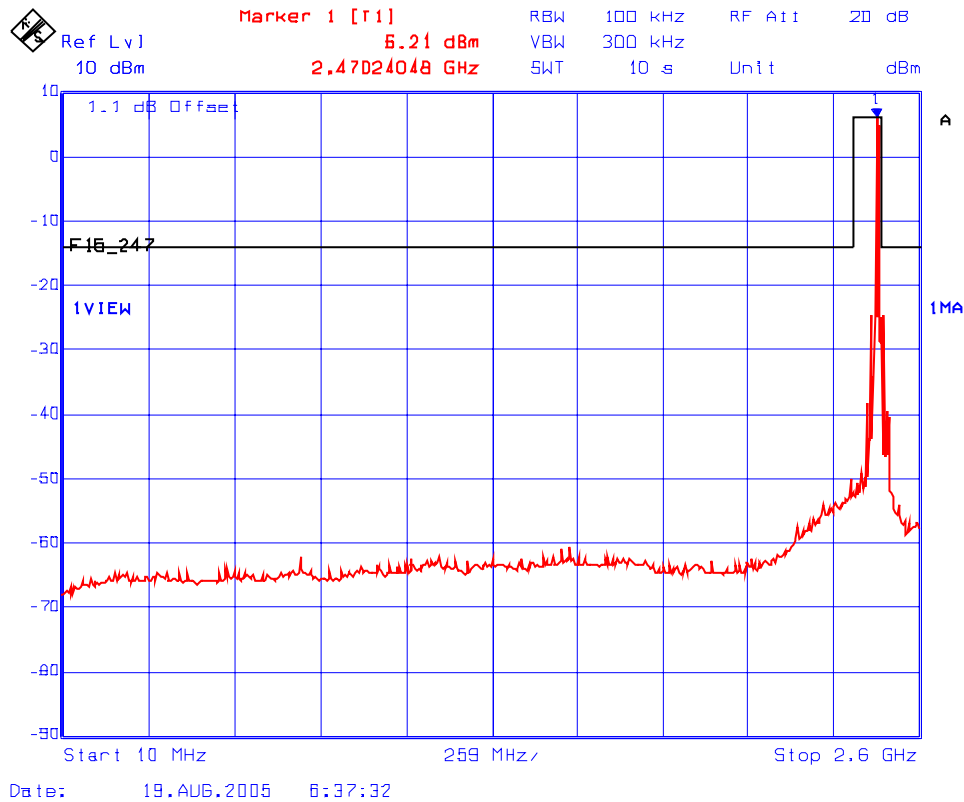

Plot#19:
 Spurious RF Conducted Emissions, Low Power Setting
 Transmitter Frequency: 2470 MHz

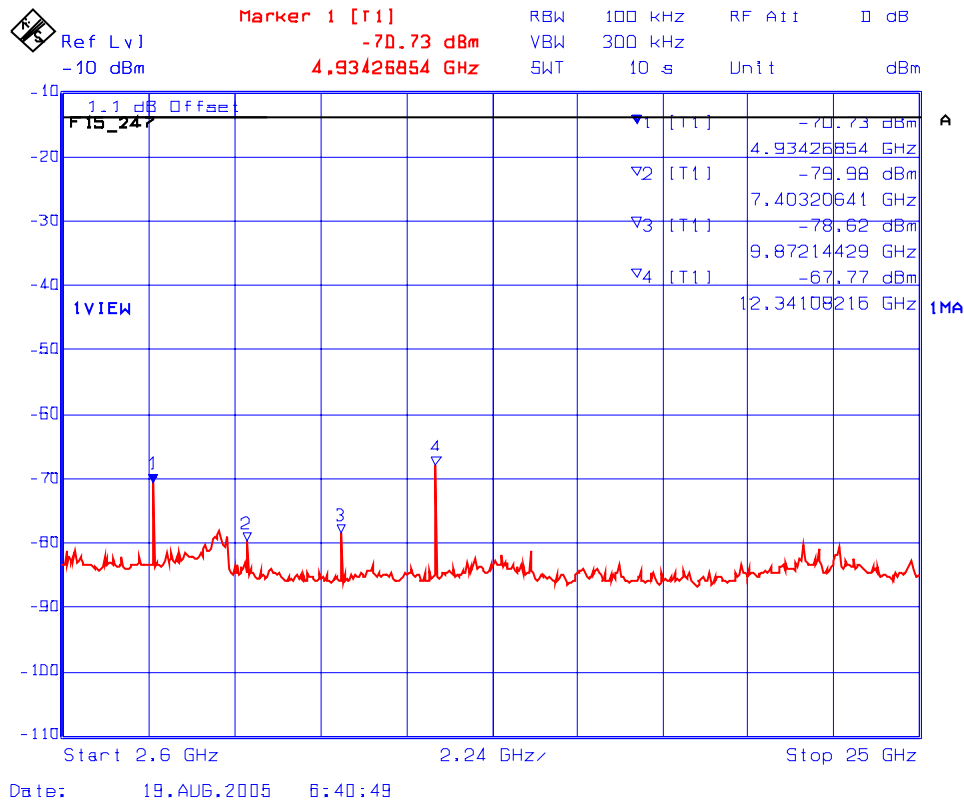

Plot#20:
Spurious RF Conducted Emissions, High Power Setting
Transmitter Frequency: 2470 MHz

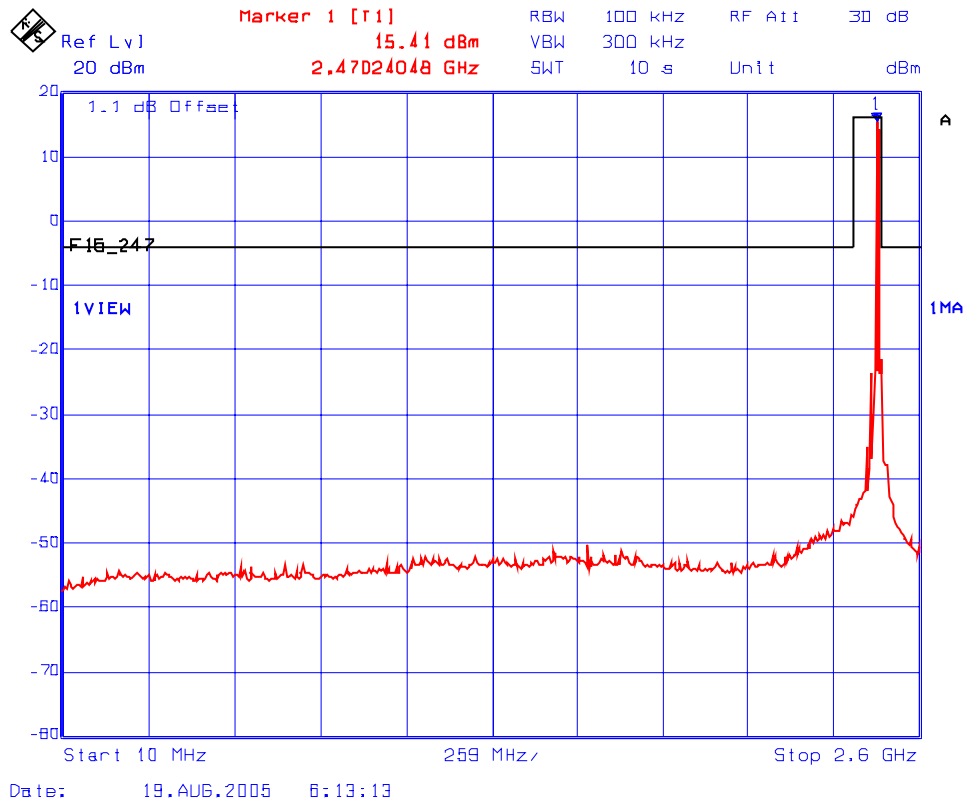

Plot#21:
 Spurious RF Conducted Emissions, High Power Setting
 Transmitter Frequency: 2470 MHz

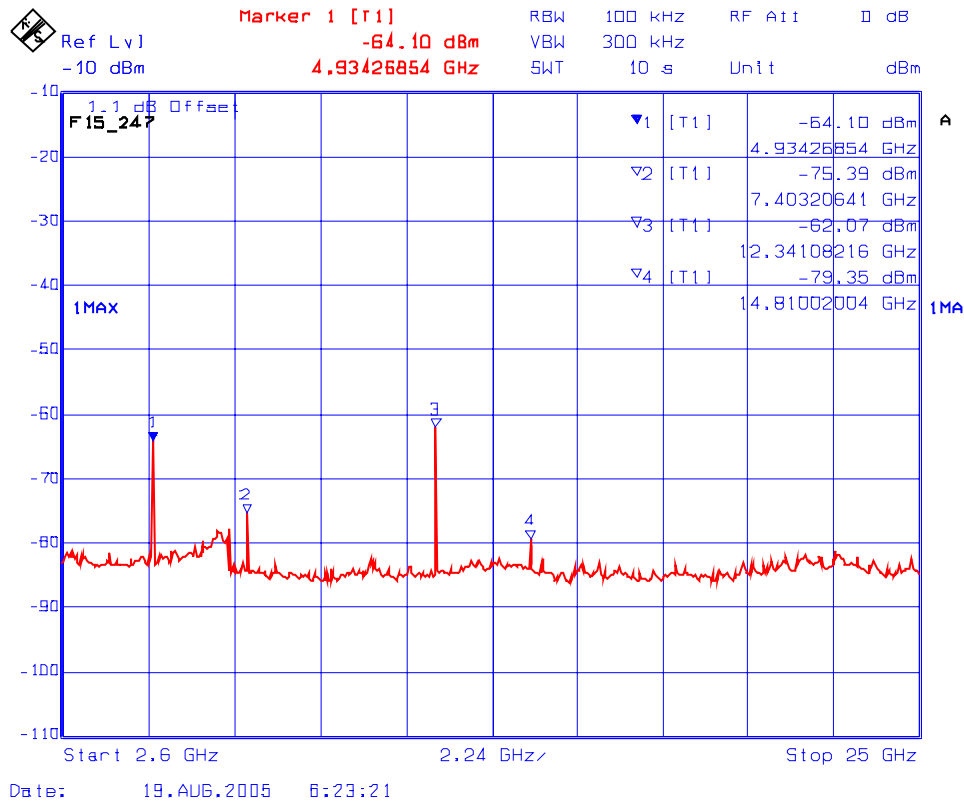

6.11. TRANSMITTED POWER DENSITY OF A DIGITAL MODULATION SYSTEM [§ 15.247 (e)]

6.11.1. Limits

For digitally modulated systems, the power spectral density conducted from the intentional radiator to the antenna shall not be greater than 8 dBm in any 3 kHz band during any time interval of continuous transmission.

6.11.2. Method of Measurements

Refer to Exhibit 8 of this test report and FCC procedures for Digital Transmission Systems (March 23, 2005).

6.11.3. Test Arrangements

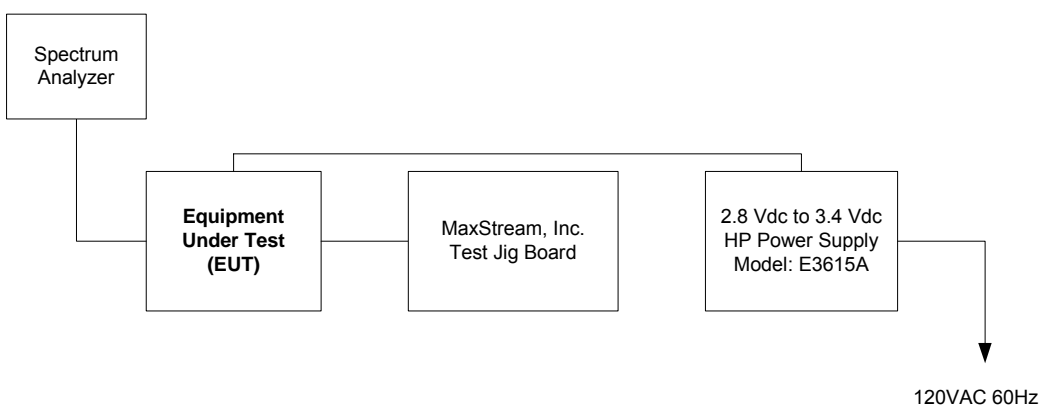

6.11.4. Test Equipment List

Test Instruments	Manufacturer	Model No.	Serial No.	Frequency Range
Spectrum Analyzer	Rhode & Schwarz	FSEK20/B4/B21	834157/005	9kHz – 40GHz

6.11.5. Test Data

Transmitter Channel	Frequency (MHz)	RF Power Level in 3 KHz BW (dBm)	Limit (dBm)	Margin (dB)	Comments (Pass/Fail)
Lowest	2410	4.46	8.0	-3.54	Pass
Middle	2440	4.39	8.0	-3.61	Pass
Highest	2470	5.75	8.0	-2.25	Pass

Refer to Plots#22 to 24 for detailed measurements.

Plot#22:
Power Spectral Density
Transmitter Frequency: 2410 MHz

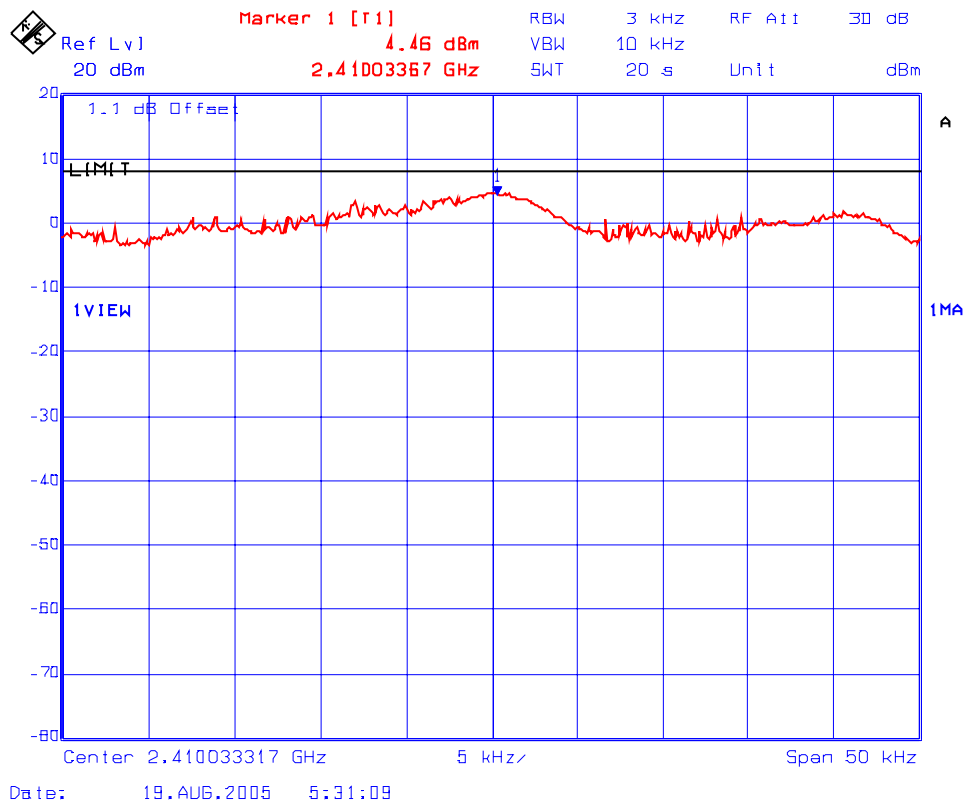

ULTRATECH GROUP OF LABS

3000 Bristol Circle, Oakville, Ontario, Canada L6H 6G4
Tel. #: 905-829-1570, Fax. #: 905-829-8050, Email: vic@ultratech-labs.com, Website: <http://www.ultratech-labs.com>

File #: MXS--050F15C247
September 22, 2005

All test results contained in this engineering test report are traceable to National Institute of Standards and Technology (NIST)

Plot#23:
Power Spectral Density
Transmitter Frequency: 2440 MHz

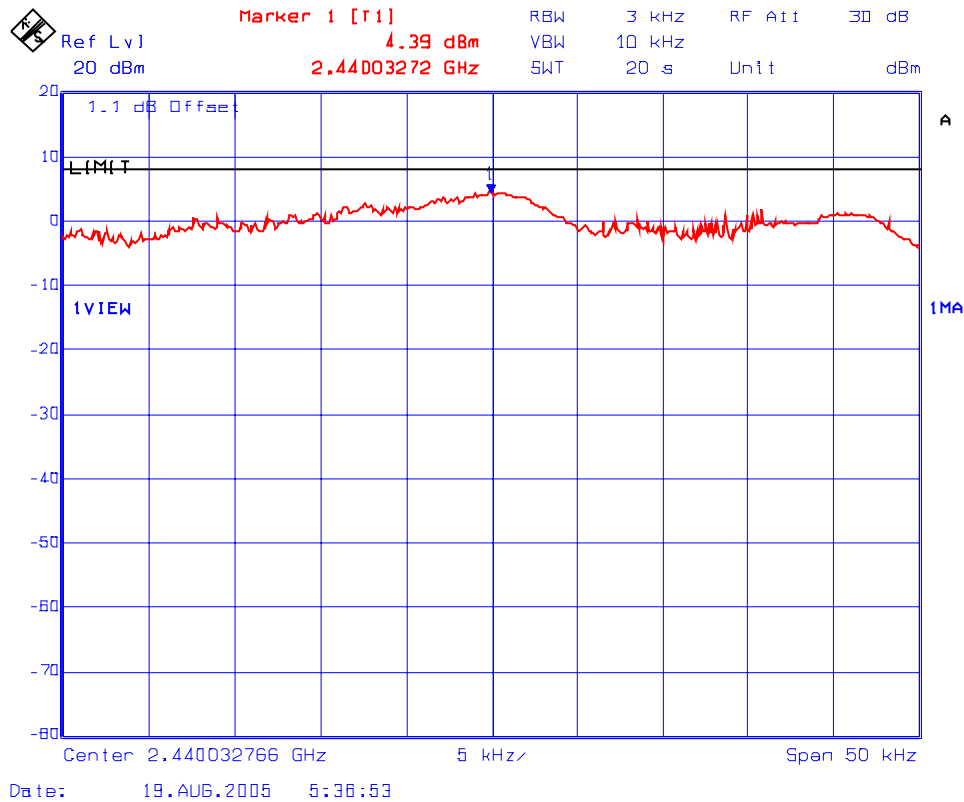

ULTRATECH GROUP OF LABS

3000 Bristol Circle, Oakville, Ontario, Canada L6H 6G4
Tel. #: 905-829-1570, Fax. #: 905-829-8050, Email: vic@ultratech-labs.com, Website: <http://www.ultratech-labs.com>

File #: MXS--050F15C247
September 22, 2005

All test results contained in this engineering test report are traceable to National Institute of Standards and Technology (NIST)

Plot#24:
Power Spectral Density
Transmitter Frequency: 2470 MHz

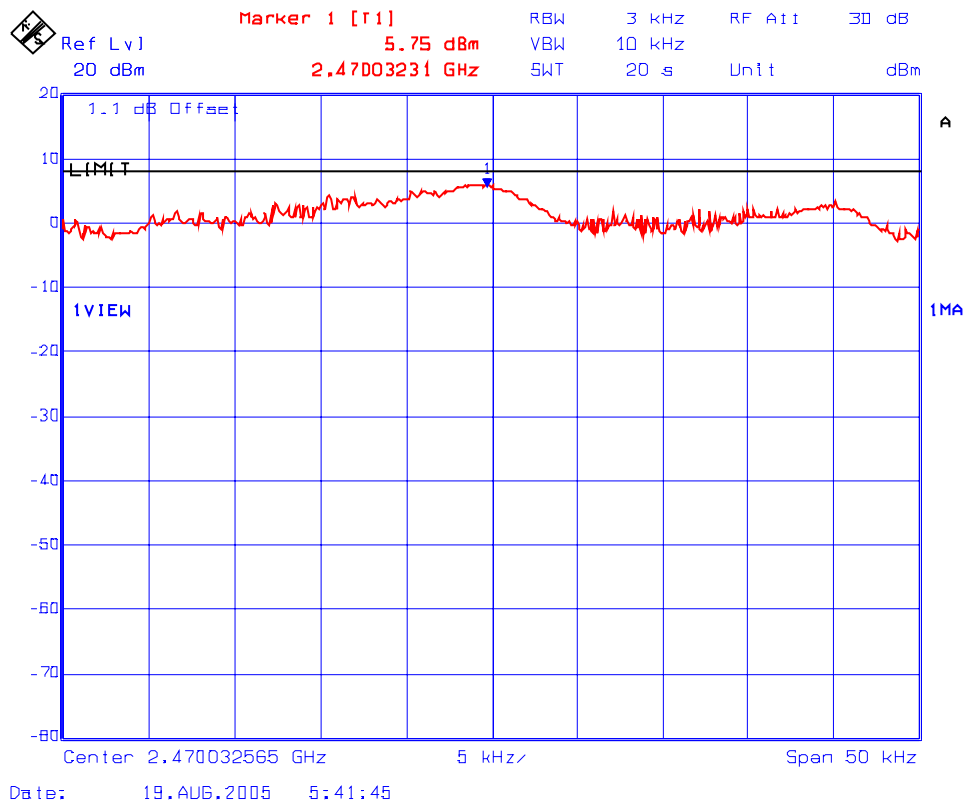

ULTRATECH GROUP OF LABS

3000 Bristol Circle, Oakville, Ontario, Canada L6H 6G4
Tel. #: 905-829-1570, Fax. #: 905-829-8050, Email: vic@ultratech-labs.com, Website: <http://www.ultratech-labs.com>

File #: MXS--050F15C247
September 22, 2005

All test results contained in this engineering test report are traceable to National Institute of Standards and Technology (NIST)

6.12. TRANSMITTER BAND-EDGE & SPURIOUS RADIATED EMISSIONS AT 3 METERS [§§15.247 (d), 15.209 & 15.205]

6.12.1. Limits

In any 100 kHz bandwidth outside the frequency band in which the spread spectrum or digitally modulated intentional radiator is operating, the radio frequency power that is produced by the intentional radiator shall be at least 20 dB below that in the 100 kHz bandwidth within the band that contains the highest level of the desired power, based on either an RF conducted or a radiated measurement.

In addition, radiated emissions, which fall in the restricted band, as defined in Section 15.205 (a), must also comply with the radiated emission limits specified in section 15.209 (a).

Remarks:

- Applies to harmonics/spurious emissions that fall in the restricted bands listed in Section 15.205. The maximum permitted average field strength is listed in Section 15.209.
- The emission limits as specified above are based on measurement instrument employing an average detector. The provisions in Section 15.35 for limiting peak emissions apply.

FCC 47 CFR 15.205(a) - Restricted Frequency Bands

MHz	MHz	MHz	GHz
0.090 - 0.110	162.0125 - 167.17	2310 - 2390	9.3 - 9.5
0.49 - 0.51	167.72 - 173.2	2483.5 - 2500	10.6 - 12.7
2.1735 - 2.1905	240 - 285	2655 - 2900	13.25 - 13.4
8.362 - 8.366	322 - 335.4	3260 - 3267	14.47 - 14.5
13.36 - 13.41	399.9 - 410	3332 - 3339	14.35 - 16.2
25.5 - 25.67	608 - 614	3345.8 - 3358	17.7 - 21.4
37.5 - 38.25	960 - 1240	3600 - 4400	22.01 - 23.12
73 - 75.4	1300 - 1427	4500 - 5250	23.6 - 24.0
108 - 121.94	1435 - 1626.5	5350 - 5460	31.2 - 31.8
123 - 138	1660 - 1710	7250 - 7750	36.43 - 36.5
149.9 - 150.05	1718.8 - 1722.2	8025 - 8500	Above 38.6
156.7 - 156.9	2200 - 2300	9000 - 9200	

**FCC 47 CFR 15.209(a)
 -- Field Strength Limits within Restricted Frequency Bands --**

FREQUENCY (MHz)	FIELD STRENGTH LIMITS (microvolts/m)	DISTANCE (Meters)
0.009 - 0.490	2,400 / F (KHz)	300
0.490 - 1.705	24,000 / F (KHz)	30
1.705 - 30.0	30	30
30 - 88	100	3
88 - 216	150	3
216 - 960	200	3
Above 960	500	3

6.12.2. Method of Measurements

Refer to Exhibit 8, FCC procedures for Digital Transmission Systems (March 23, 2005) and ANSI C3.4 for detailed radiated emissions measurement procedures.

The following measurement procedures were also applied:

- Applies to harmonics/spurious that fall in the restricted bands listed in Section 15.205. The maximum permitted average field strength is listed in Section 15.209. A Pre-Amp and highpass filter are used for this measurement.
- For measurement below 1 GHz, set RBW = 100 KHz, VBW ≥ 100 KHz, SWEEP=AUTO.
- For measurement above 1 GHz, set RBW = 1 MHz, VBW = 1 MHz (Peak) & VBW = 10 Hz (Average), SWEEP=AUTO.
- If the emission is pulsed, modified the unit for continuous operation, then use the settings above for measurements, then correct the reading by subtracting the peak-average correction factor derived from the appropriate duty cycle calculation. See Section 15.35(b) and (c).

6.12.3. Test Arrangement

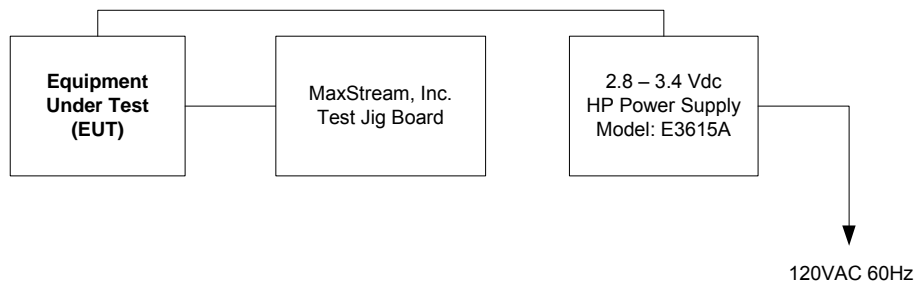

6.12.4. Test Equipment List

Test Instruments	Manufacturer	Model No.	Serial No.	Frequency Range
Spectrum Analyzer	Rohde & Schwarz	FSEK20/B4/B21	834157/005	9 kHz – 40 GHz
Microwave Amplifier	Hewlett Packard	8449B	3008AA00769	1 MHz to 26.5 GHz
Biconilog Antenna	EMCO	3143	1029	20 MHz to 2 GHz
Horn Antenna	EMCO	3155	9701-5061	1 GHz – 18 GHz

6.12.5. Test Data

6.12.5.1. EUT tested with Chip Antenna (Max. Antenna Gain = - 1.5 dBi)

Fundamental Frequency: 2410 MHz
 Modulation: Digital Modulation
 Frequency Test Range: 30 MHz - 25 GHz

Frequency (MHz)	RF Peak Level (dBµV/m)	RF Avg Level (dBµV/m)	Antenna Plane (H/V)	Limit 15.209 (dBµV/m)	Limit 15.247 (dBµV/m)	Margin (dB)	Pass/Fail
2410	114.95	--	V	--	--	--	--
2410	114.37	--	H	--	--	--	--
4820	52.27	37.46	V	54.0	95.0	-16.5	Pass*
4820	52.78	37.59	H	54.0	95.0	-16.4	Pass*

All other harmonics are more than 20 dB below the limit. No other spurious emissions were found from 30 MHz to 25 GHz. See test data plots (25 to 26) for band-edge emissions.

* Emission within the restricted frequency bands.

Plot#25: Band-Edge RF Radiated Emissions, Vertical Polarization
Low End of Frequency Band
Transmitter Frequency: 2410 MHz

Note:

- Trace 1: RBW=1MHz, RBW=3 MHz
- Trace 2: RBW=300 kHz, RBW=1 MHz, Delta (Peak to Band-Edge): 50.45 dB
- Trace 3: RBW=1 MHz, VBW=10 Hz
- Band-Edge Level at 2389 MHz: 114.95 dBμV/m – 50.45 dB = 64.50 dBμV/m

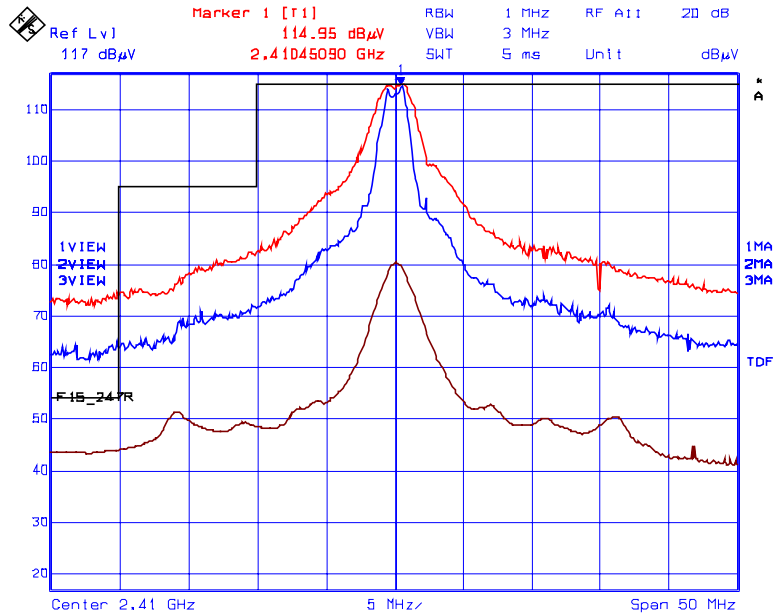

Date: 26.AUG.2005 16:05:27

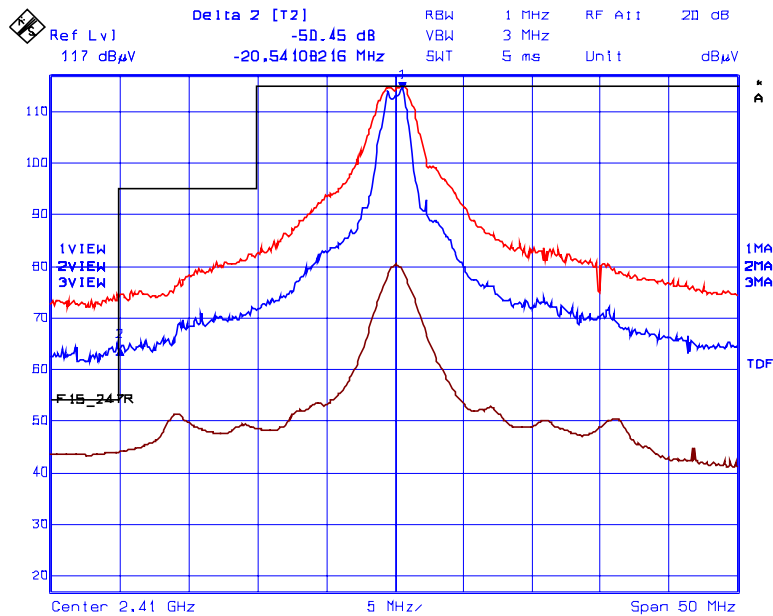

Date: 26.AUG.2005 16:09:16

ULTRATECH GROUP OF LABS

3000 Bristol Circle, Oakville, Ontario, Canada L6H 6G4
Tel. #: 905-829-1570, Fax. #: 905-829-8050, Email: vic@ultratech-labs.com, Website: <http://www.ultratech-labs.com>

File #: MXS--050F15C247
September 22, 2005

All test results contained in this engineering test report are traceable to National Institute of Standards and Technology (NIST)

Plot#26: Band-Edge RF Radiated Emissions, Horizontal Polarization
Low End of Frequency Band
Transmitter Frequency: 2410 MHz

Note:

- Trace 1: RBW=1MHz, RBW=3 MHz
- Trace 2: RBW=300 kHz, RBW=1 MHz, Delta (Peak to Band-Edge): 50.45 dB
- Trace 3: RBW=1 MHz, VBW=10 Hz
- Band-Edge Level at 2389 MHz: 114.37 dBμV/m – 50.45 dB = 63.92 dBμV/m

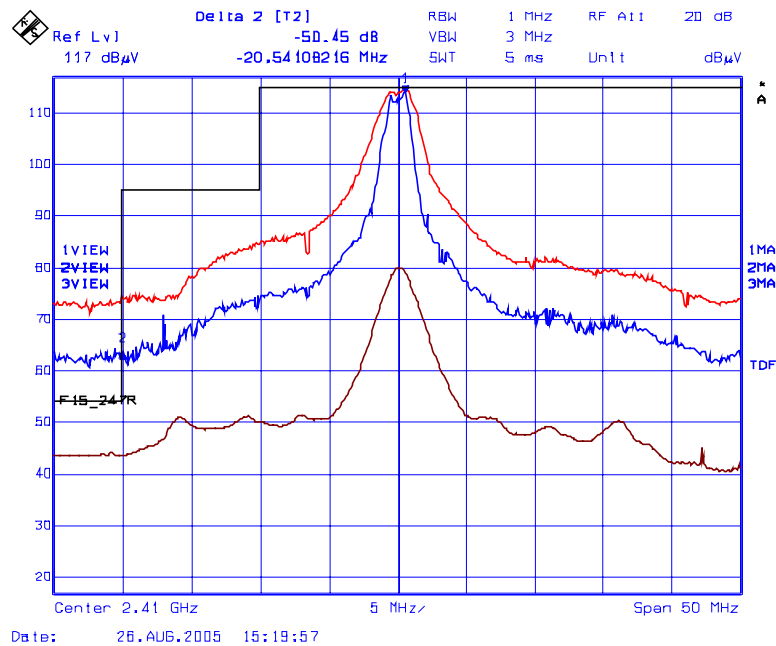
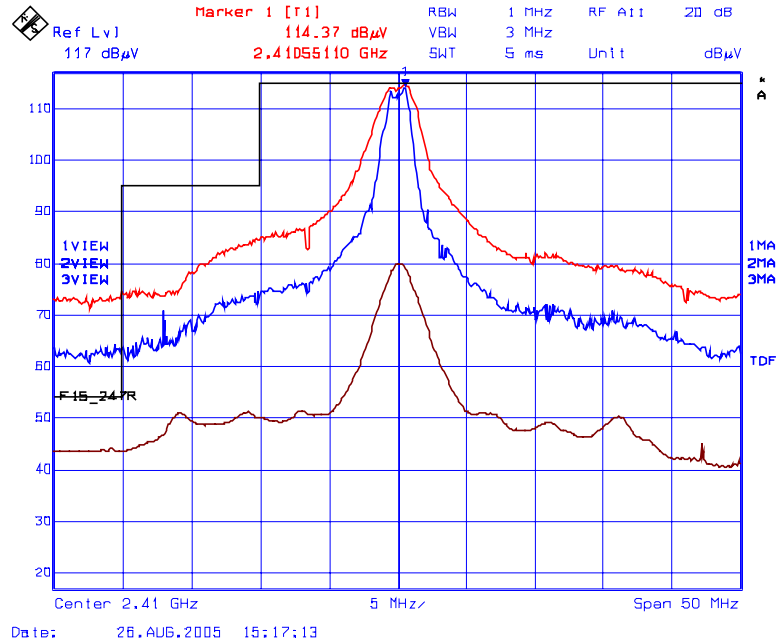

ULTRATECH GROUP OF LABS

3000 Bristol Circle, Oakville, Ontario, Canada L6H 6G4
Tel. #: 905-829-1570, Fax. #: 905-829-8050, Email: vic@ultratech-labs.com, Website: <http://www.ultratech-labs.com>

File #: MXS--050F15C247
September 22, 2005

All test results contained in this engineering test report are traceable to National Institute of Standards and Technology (NIST)

Fundamental Frequency: 2440 MHz
 Modulation: Digital Modulation
 Frequency Test Range: 30 MHz – 25 GHz

Frequency (MHz)	RF Peak Level (dBµV/m)	RF Avg Level (dBµV/m)	Antenna Plane (H/V)	Limit 15.209 (dBµV/m)	Limit 15.247 (dBµV/m)	Margin (dB)	Pass/Fail
2440	113.51	--	V	--	--	--	--
2440	113.80	--	H	--	--	--	--
4880	50.86	35.57	V	54.0	93.8	-18.4	Pass*
4880	52.27	37.36	H	54.0	93.8	-16.6	Pass*
7320	53.99	39.78	V	54.0	93.8	-14.2	Pass*
7320	54.42	40.14	H	54.0	93.8	-13.9	Pass*

All other harmonics are more than 20 dB below the limit. No other spurious emissions were found from 30 MHz to 25 GHz.

* Emission within the restricted frequency bands.

Fundamental Frequency: 2470 MHz
 Modulation: Digital Modulation
 Frequency Test Range: 30 MHz – 25 GHz

Frequency (MHz)	RF Peak Level (dBµV/m)	RF Avg Level (dBµV/m)	Antenna Plane (H/V)	Limit 15.209 (dBµV/m)	Limit 15.247 (dBµV/m)	Margin (dB)	Pass/Fail
2470	112.80	--	V	--	--	--	--
2470	113.36	--	H	--	--	--	--
4940	50.16	35.65	V	54.0	93.4	-18.4	Pass*
4940	52.6	37.95	H	54.0	93.4	-16.1	Pass*
7410	53.21	39.17	V	54.0	93.4	-14.8	Pass*
7410	54.34	40.03	H	54.0	93.4	-14.0	Pass*

All other harmonics are more than 20 dB below the limit. No other spurious emissions were found from 30 MHz to 25 GHz. See test data plots (27 to 28) for band-edge emissions.

* Emission within the restricted frequency bands.

Plot#27: Band-Edge RF Radiated Emissions, Vertical Polarization
Upper End of Frequency Band
Transmitter Frequency: 2470 MHz

Note:

- Trace 1: RBW = 1 MHz, RBW=3 MHz
- Trace 2: RBW = 100 kHz, RBW = 300 kHz, Delta (Peak to Band-Edge): 46.67 dB
- Trace 3: RBW = 1 MHz, VBW = 10 Hz
- Band-Edge Level at 2485.35 MHz: 112.80 dB μ V/m – 46.67 dB = 66.13 dB μ V/m

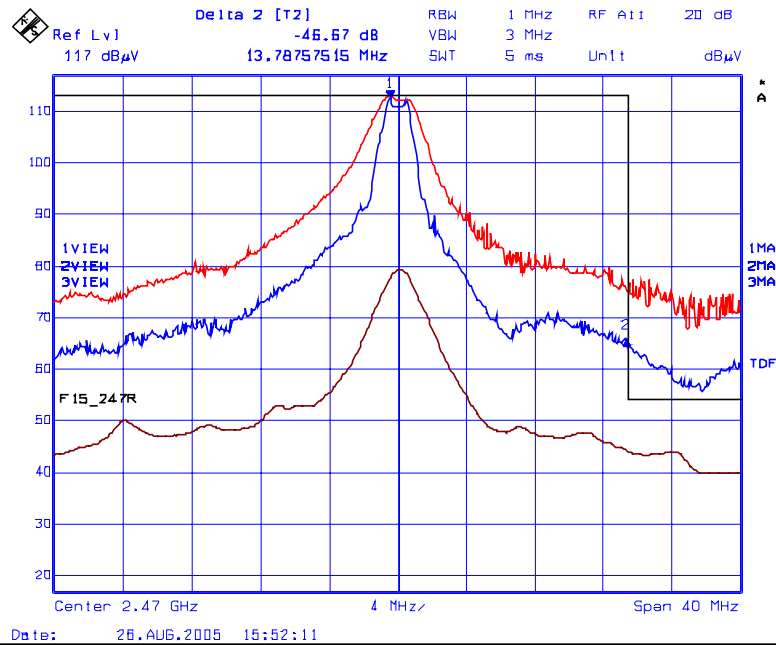
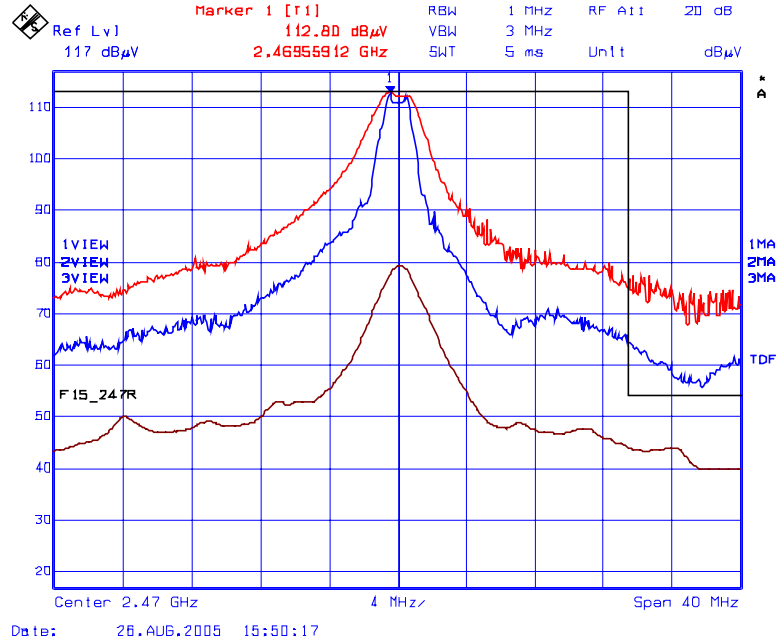

Plot#28: Band-Edge RF Radiated Emissions, Horizontal Polarization
Upper End of Frequency Band
Transmitter Frequency: 2470 MHz

Note:

- Trace 1: RBW = 1 MHz, RBW=3 MHz
- Trace 2: RBW = 100 kHz, RBW = 300 kHz, Delta (Peak to Band-Edge): 45.12 dB
- Trace 3: RBW = 1 MHz, VBW = 10 Hz
- Band-Edge Level at 2486.15 MHz: 113.36 dBμV/m – 45.12 dB = 68.24 dBμV/m

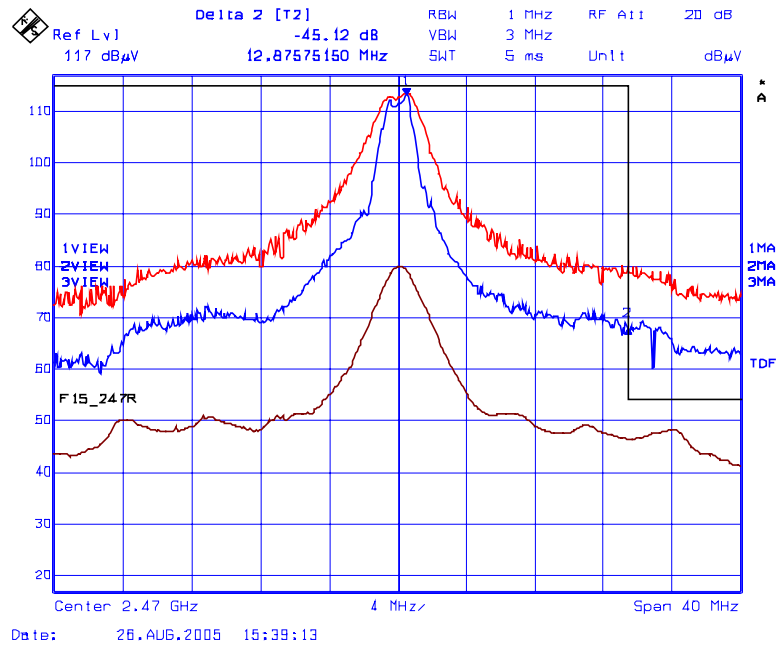
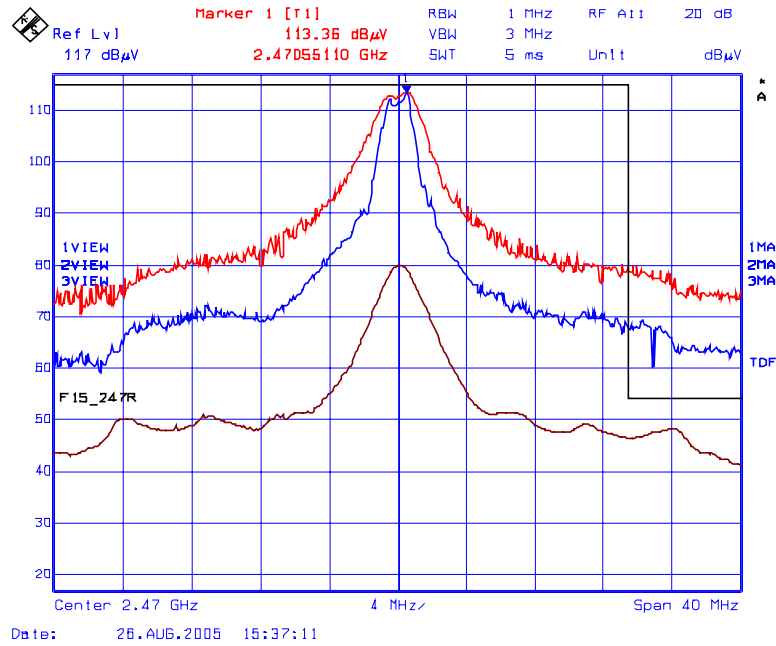

ULTRATECH GROUP OF LABS

3000 Bristol Circle, Oakville, Ontario, Canada L6H 6G4
Tel. #: 905-829-1570, Fax. #: 905-829-8050, Email: vic@ultratech-labs.com, Website: <http://www.ultratech-labs.com>

File #: MXS--050F15C247
September 22, 2005

All test results contained in this engineering test report are traceable to National Institute of Standards and Technology (NIST)

6.12.5.2. EUT tested with Maxrad Yagi Antenna (Max. Antenna Gain = 15 dBi; Cable Loss = 17.1 dB)

Note:

The following cables were used for EUT tested with Maxrad Yagi Antenna:

- 4inch cable to connect U.FL to RPSMA (cable loss of 0.4 dB)
- CFD-200 NL antenna cable (3 meters; cable loss of 2.00 dB)
- Belden 7806R antenna cable (6 meters; cable loss of 4.00 dB)
- Belden 7806R antenna cable (6 meters; cable loss of 4.00 dB)
- LMR-400 coaxial cable (7 meters; cable loss of 1.8 dB)
- Coleman 8421 coaxial cable (10 meters; cable loss of 4.9 dB)

Fundamental Frequency: 2410 MHz
 Modulation: Digital Modulation
 Frequency Test Range: 30 MHz - 25 GHz

Frequency (MHz)	RF Peak Level (dBµV/m)	RF Avg Level (dBµV/m)	Antenna Plane (H/V)	Limit 15.209 (dBµV/m)	Limit 15.247 (dBµV/m)	Margin (dB)	Pass/Fail
2410	111.70	--	V	--	--	--	--
2410	112.19	--	H	--	--	--	--

All harmonics are more than 20 dB below the limit. No other spurious emissions were found from 30 MHz to 25 GHz. See test data plots (29 to 30) for band-edge emissions.

Plot#29: Band-Edge RF Radiated Emissions, Vertical Polarization
Low End of Frequency Band
Transmitter Frequency: 2410 MHz

Note:

- Trace 1: RBW=1MHz, RBW=3 MHz
- Trace 2: RBW=300 kHz, RBW=1 MHz, Delta (Peak to Band-Edge): 48.12 dB
- Trace 3: RBW=1 MHz, VBW=10 Hz
- Band-Edge Level at 2390 MHz: 111.70 dBμV/m – 48.12 dB = 63.58 dBμV/m

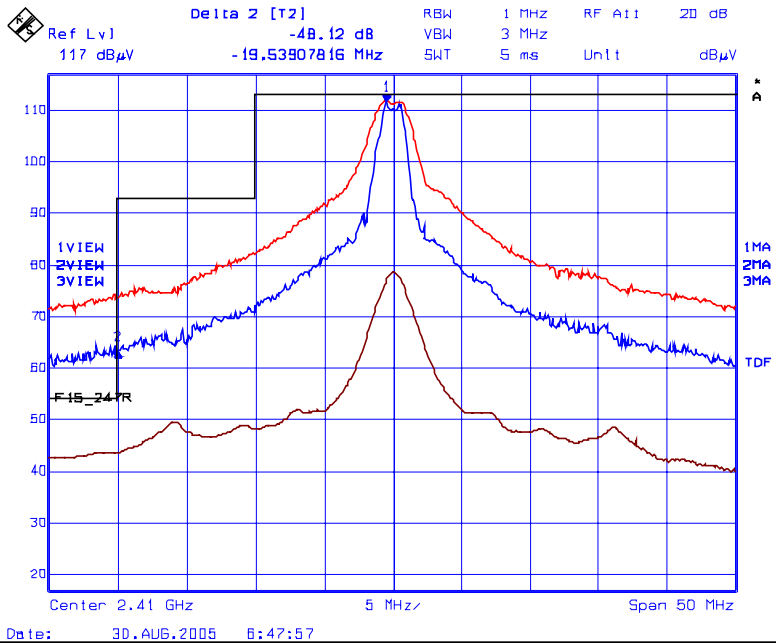
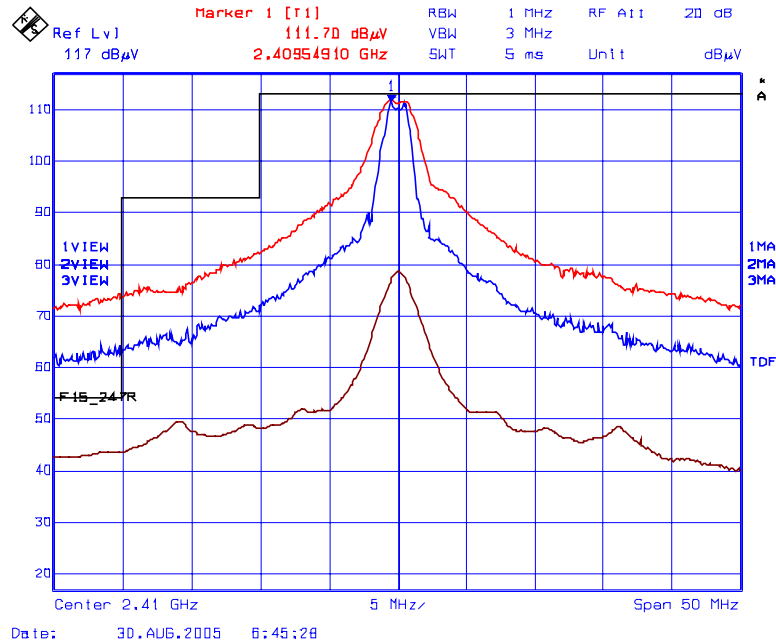

Plot#30: Band-Edge RF Radiated Emissions, Horizontal Polarization
Low End of Frequency Band
Transmitter Frequency: 2410 MHz

Note:

- Trace 1: RBW=1MHz, RBW=3 MHz
- Trace 2: RBW=300 kHz, RBW=1 MHz, Delta (Peak to Band-Edge): 48.57 dB
- Trace 3: RBW=1 MHz, VBW=10 Hz
- Band-Edge Level at 2489 MHz: $112.19 \text{ dB}\mu\text{V/m} - 48.57 \text{ dB} = 63.62 \text{ dB}\mu\text{V/m}$

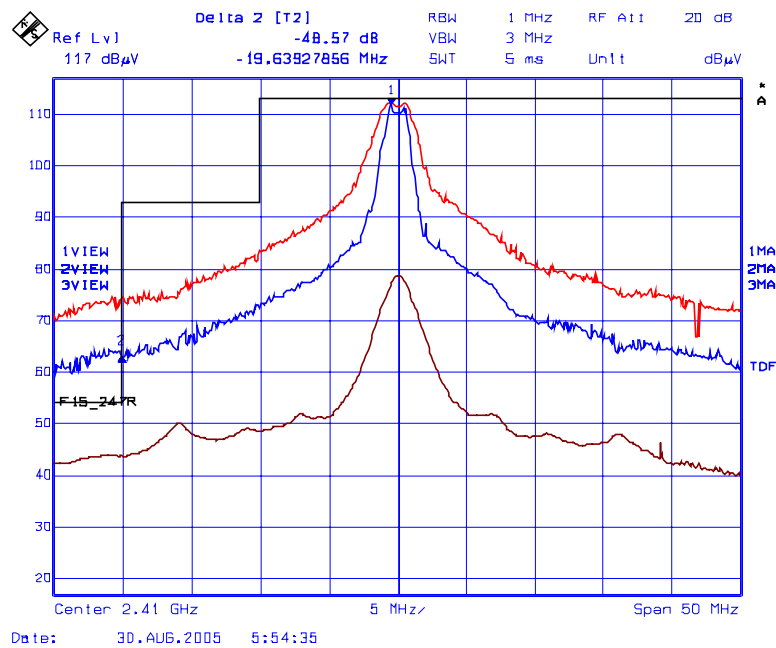
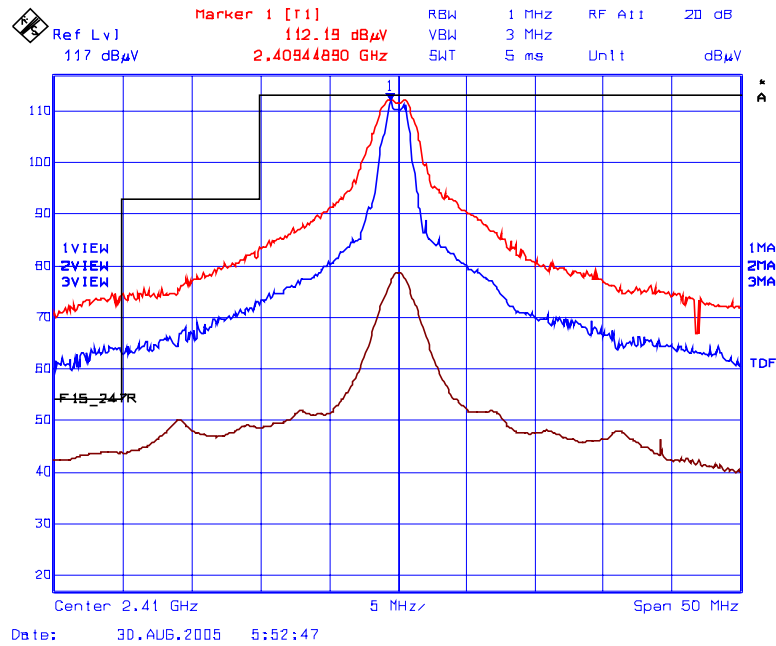

ULTRATECH GROUP OF LABS

3000 Bristol Circle, Oakville, Ontario, Canada L6H 6G4
Tel. #: 905-829-1570, Fax. #: 905-829-8050, Email: vic@ultratech-labs.com, Website: <http://www.ultratech-labs.com>

File #: MXS--050F15C247
September 22, 2005

All test results contained in this engineering test report are traceable to National Institute of Standards and Technology (NIST)

Fundamental Frequency: 2440 MHz
 Modulation: Digital Modulation
 Frequency Test Range: 30 MHz – 25 GHz

Frequency (MHz)	RF Peak Level (dBµV/m)	RF Avg Level (dBµV/m)	Antenna Plane (H/V)	Limit 15.209 (dBµV/m)	Limit 15.247 (dBµV/m)	Margin (dB)	Pass/Fail
2440	111.57	--	V	--	--	--	--
2440	111.88	--	H	--	--	--	--
7320	54.74	40.65	V	54.0	91.9	-13.4	Pass*
7320	53.63	39.74	H	54.0	91.9	-14.3	Pass*

All other harmonics are more than 20 dB below the limit. No other spurious emissions were found from 30 MHz to 25 GHz.

* Emission within the restricted frequency bands.

Fundamental Frequency: 2470 MHz
 Modulation: Digital Modulation
 Frequency Test Range: 30 MHz – 25 GHz

Frequency (MHz)	RF Peak Level (dBµV/m)	RF Avg Level (dBµV/m)	Antenna Plane (H/V)	Limit 15.209 (dBµV/m)	Limit 15.247 (dBµV/m)	Margin (dB)	Pass/Fail
2470	111.98	--	V	--	--	--	--
2470	113.43	--	H	--	--	--	--
7410	55.16	41.12	V	54.0	93.4	-12.9	Pass*
7410	54.47	39.66	H	54.0	93.4	-14.3	Pass*

All other harmonics are more than 20 dB below the limit. No other spurious emissions were found from 30 MHz to 25 GHz. See test data plots (31 to 32) for band-edge emissions.

* Emission within the restricted frequency bands.

Plot#31: Band-Edge RF Radiated Emissions, Vertical Polarization
 Upper End of Frequency Band
 Transmitter Frequency: 2470 MHz

Note:

- Trace 1: RBW = 1 MHz, RBW=3 MHz
- Trace 2: RBW = 100 kHz, RBW = 300 kHz, Delta (Peak to Band-Edge): 43.35 dB
- Trace 3: RBW = 1 MHz, VBW = 10 Hz
- Band-Edge Level at 2483.5 MHz: 111.98 dBμV/m – 43.35 dB = 68.63 dBμV/m

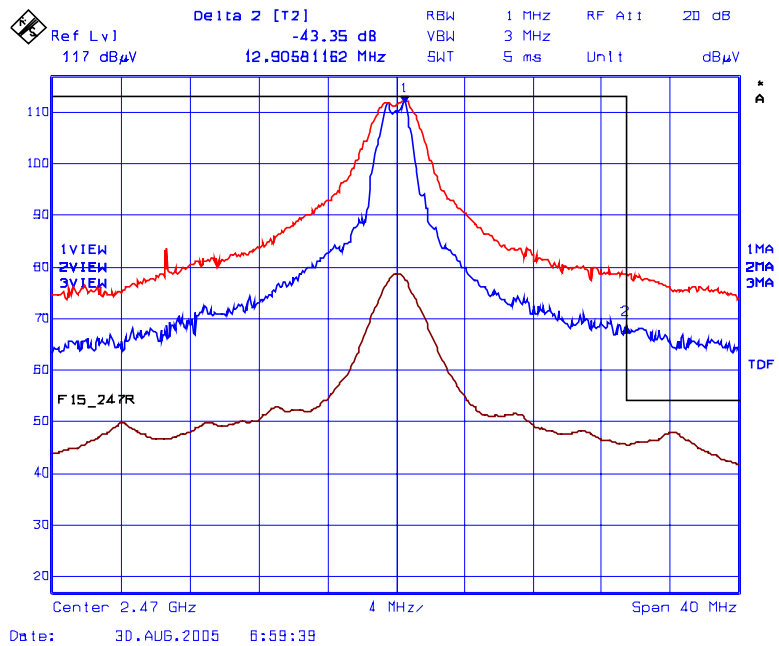
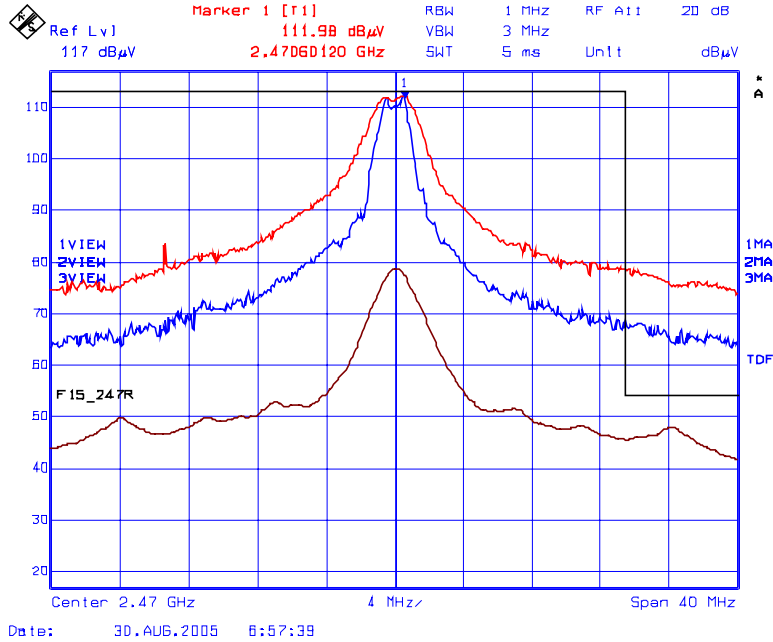

ULTRATECH GROUP OF LABS

3000 Bristol Circle, Oakville, Ontario, Canada L6H 6G4
 Tel. #: 905-829-1570, Fax. #: 905-829-8050, Email: vic@ultratech-labs.com, Website: <http://www.ultratech-labs.com>

File #: MXS--050F15C247
 September 22, 2005

All test results contained in this engineering test report are traceable to National Institute of Standards and Technology (NIST)

Plot#32: Band-Edge RF Radiated Emissions, Horizontal Polarization
 Upper End of Frequency Band
 Transmitter Frequency: 2470 MHz

Note:

- Trace 1: RBW = 1 MHz, RBW=3 MHz
- Trace 2: RBW = 100 kHz, RBW = 300 kHz, Delta (Peak to Band-Edge): 44.68 dB
- Trace 3: RBW = 1 MHz, VBW = 10 Hz
- Band-Edge Level at 2483.5 MHz: $113.439 \text{ dB}\mu\text{V/m} - 44.68 = 68.78 \text{ dB}\mu\text{V/m}$

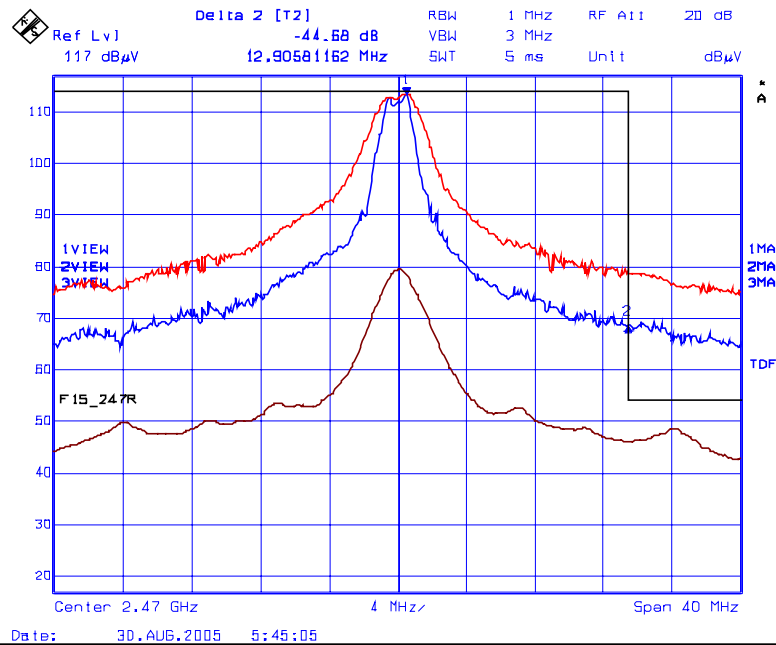
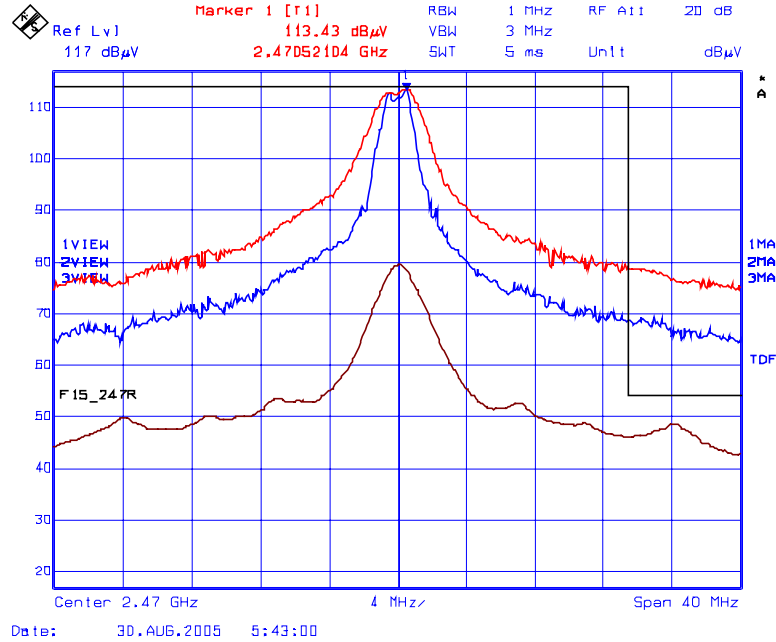

6.12.5.3. EUT tested with ARC Panel Antenna (Max. Antenna Gain = 19 dBi; Cable Loss = 19.1 dB)

Note:

The following cables were used for EUT tested with ARC Panel Antenna:

- 4 inch cable to connect U.FL to RPSMA (cable loss of 0.4 dB)
- CFD-200 NL antenna cable (3 meters; cable loss of 2.00 dB)
- Belden 7806R antenna cable (6 meters; cable loss of 4.00 dB)
- Belden 7806R antenna cable (6 meters; cable loss of 4.00 dB)
- LMR-400 coaxial cable (7 meters; cable loss of 1.8 dB)
- LMR-400 coaxial cable (3 meters; cable loss of 0.8 dB)
- Coleman 8421 coaxial cable (10 meters; cable loss of 4.9 dB)
- LMR-400 coaxial cable (4 meters; cable loss of 1.2 dB)

Fundamental Frequency: 2410 MHz
 Modulation: Digital Modulation
 Frequency Test Range: 30 MHz - 25 GHz

Frequency (MHz)	RF Peak Level (dBµV/m)	RF Avg Level (dBµV/m)	Antenna Plane (H/V)	Limit 15.209 (dBµV/m)	Limit 15.247 (dBµV/m)	Margin (dB)	Pass/Fail
2410	116.06	--	V	--	--	--	--
2410	115.18	--	H	--	--	--	--

All harmonics are more than 20 dB below the limit. No other spurious emissions were found from 30 MHz to 25 GHz. See test data plots (33 to 34) for band-edge emissions.

Plot#33: Band-Edge RF Radiated Emissions, Vertical Polarization
Low End of Frequency Band
Transmitter Frequency: 2410 MHz

Note:

- Trace 1: RBW=1MHz, RBW=3 MHz
- Trace 2: RBW=300 kHz, RBW=1 MHz, Delta (Peak to Band-Edge): 48.23 dB
- Trace 3: RBW=1 MHz, VBW=10 Hz
- Band-Edge Level at 2390 MHz: 116.06 dBμV/m – 48.23 dB = 67.83 dBμV/m

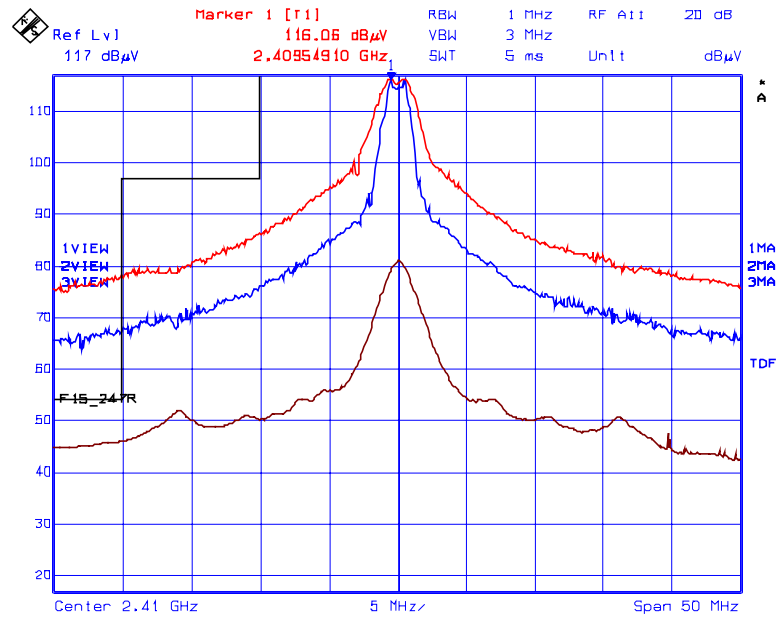

Date: 30.AUG.2005 8:13:41

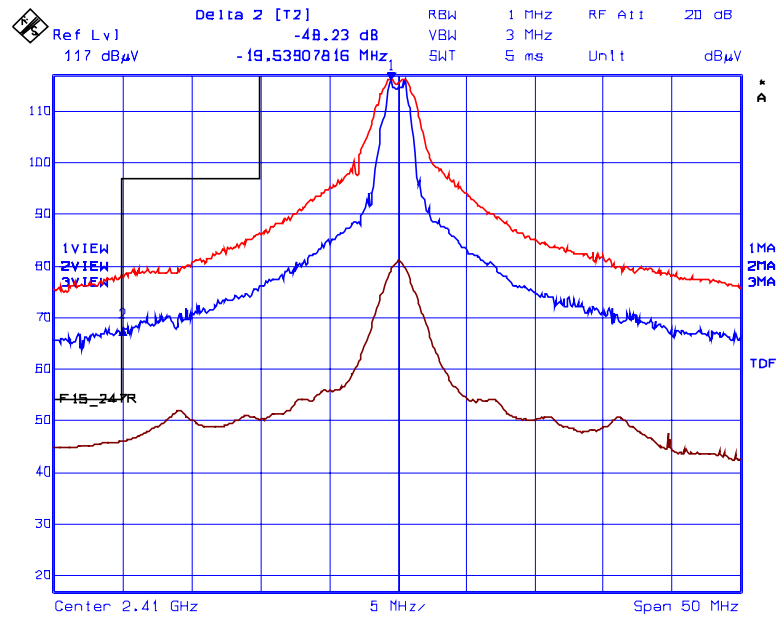

Date: 30.AUG.2005 8:15:55

Plot#34: Band-Edge RF Radiated Emissions, Horizontal Polarization
Low End of Frequency Band
Transmitter Frequency: 2410 MHz

Note:

- Trace 1: RBW=1MHz, RBW=3 MHz
- Trace 2: RBW=300 kHz, RBW=1 MHz, Delta (Peak to Band-Edge): 48.94 dB
- Trace 3: RBW=1 MHz, VBW=10 Hz
- Band-Edge Level at 2390 MHz: 115.18 dBμV/m – 48.94 dB = 66.24 dBμV/m

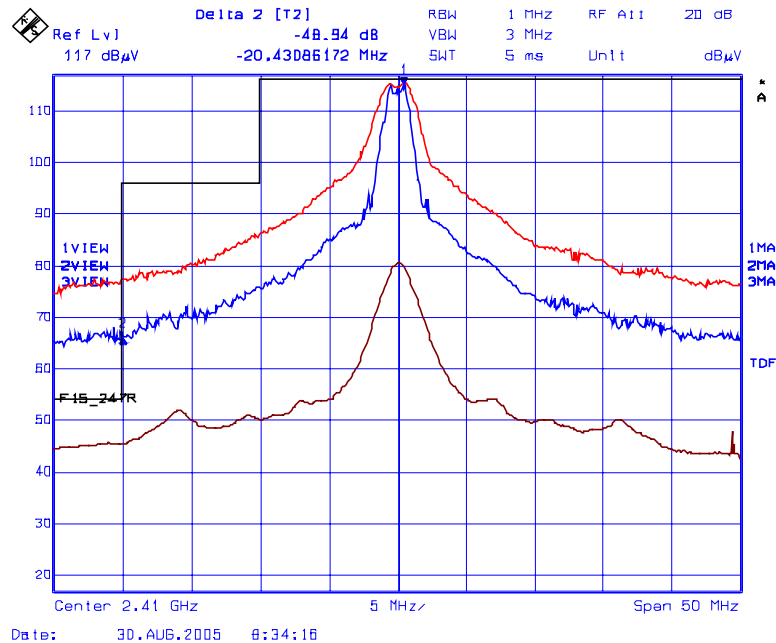
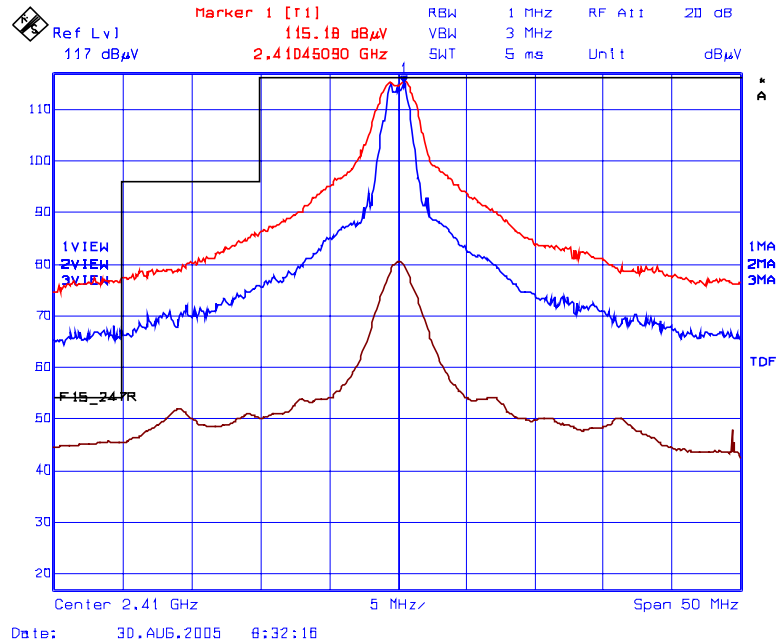

Fundamental Frequency: 2440 MHz
 Modulation: Digital Modulation
 Frequency Test Range: 30 MHz – 25 GHz

Frequency (MHz)	RF Peak Level (dBµV/m)	RF Avg Level (dBµV/m)	Antenna Plane (H/V)	Limit 15.209 (dBµV/m)	Limit 15.247 (dBµV/m)	Margin (dB)	Pass/Fail
2440	115.79	--	V	--	--	--	--
2440	115.74	--	H	--	--	--	--

All harmonics are more than 20 dB below the limit. No other spurious emissions were found from 30 MHz to 25 GHz.

Fundamental Frequency: 2470 MHz
 Modulation: Digital Modulation
 Frequency Test Range: 30 MHz – 25 GHz

Frequency (MHz)	RF Peak Level (dBµV/m)	RF Avg Level (dBµV/m)	Antenna Plane (H/V)	Limit 15.209 (dBµV/m)	Limit 15.247 (dBµV/m)	Margin (dB)	Pass/Fail
2470	116.54	--	V	--	--	--	--
2470	116.14	--	H	--	--	--	--

All other harmonics are more than 20 dB below the limit. No other spurious emissions were found from 30 MHz to 25 GHz. See test data plots (35 to 36) for band-edge emissions.

* Emission within the restricted frequency bands.

Plot#35: Band-Edge RF Radiated Emissions, Vertical Polarization
Upper End of Frequency Band
Transmitter Frequency: 2470 MHz

Note:

- Trace 1: RBW=1MHz, RBW=3 MHz
- Trace 2: RBW=300 kHz, RBW=1 MHz, Delta (Peak to Band-Edge): 44.15 dB
- Trace 3: RBW=1 MHz, VBW=10 Hz
- Band-Edge Level at 2483.5 MHz: $116.54 \text{ dB}\mu\text{V/m} - 44.15 \text{ dB} = 72.39 \text{ dB}\mu\text{V/m}$

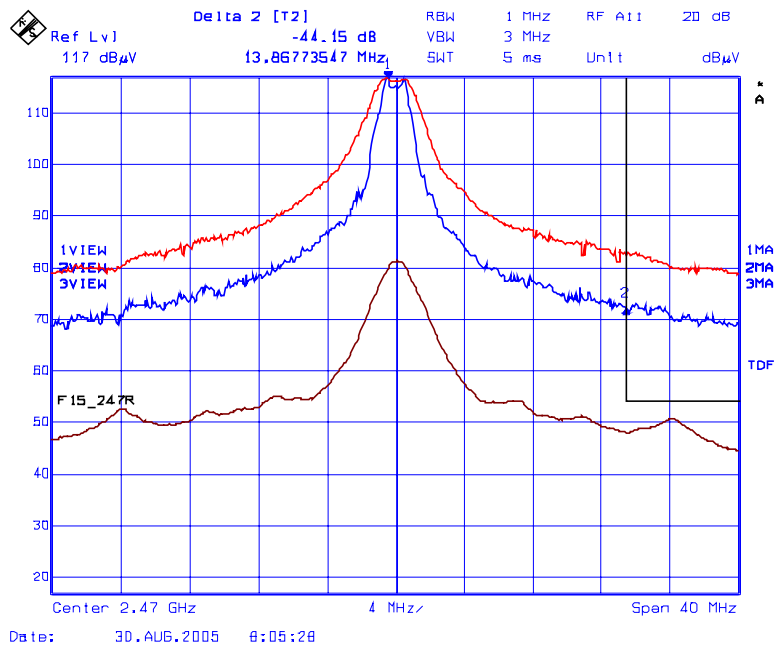
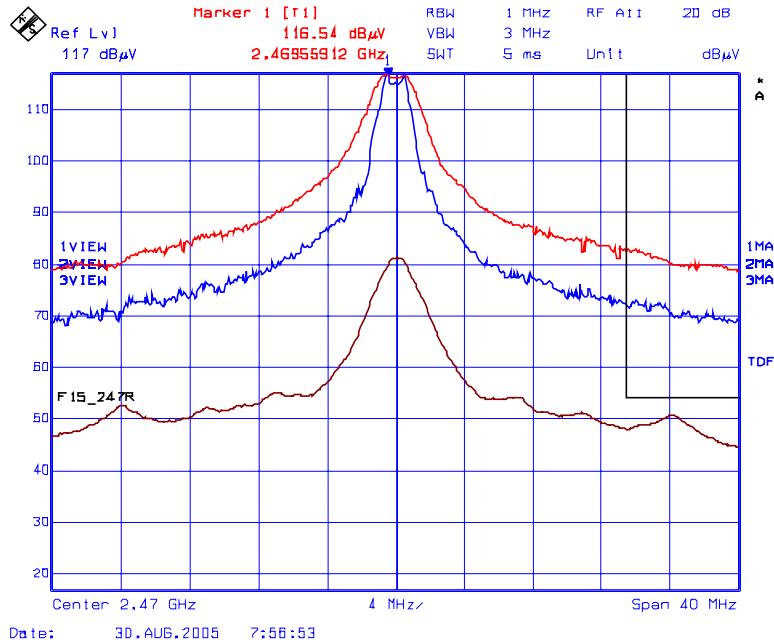

ULTRATECH GROUP OF LABS

3000 Bristol Circle, Oakville, Ontario, Canada L6H 6G4
Tel. #: 905-829-1570, Fax. #: 905-829-8050, Email: vic@ultratech-labs.com, Website: <http://www.ultratech-labs.com>

File #: MXS--050F15C247
September 22, 2005

All test results contained in this engineering test report are traceable to National Institute of Standards and Technology (NIST)

Plot#36: Band-Edge RF Radiated Emissions, Horizontal Polarization
 Upper End of Frequency Band
 Transmitter Frequency: 2470 MHz

Note:

- Trace 1: RBW=1MHz, RBW=3 MHz
- Trace 2: RBW=300 kHz, RBW=1 MHz, Delta (Peak to Band-Edge): 44.38 dB
- Trace 3: RBW=1 MHz, VBW=10 Hz
- Band-Edge Level at 2483.5 MHz: 116.14 dBμV/m – 44.38 = 71.76 dBμV/m

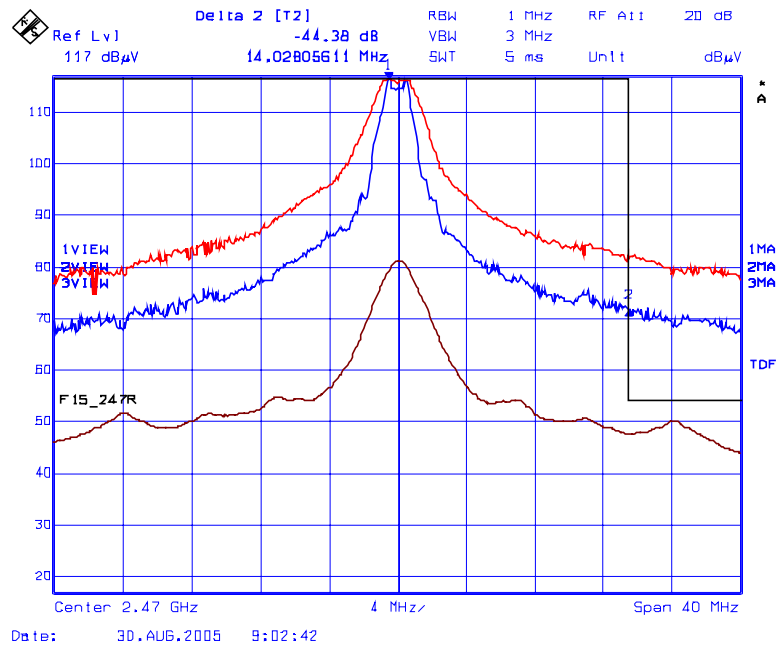
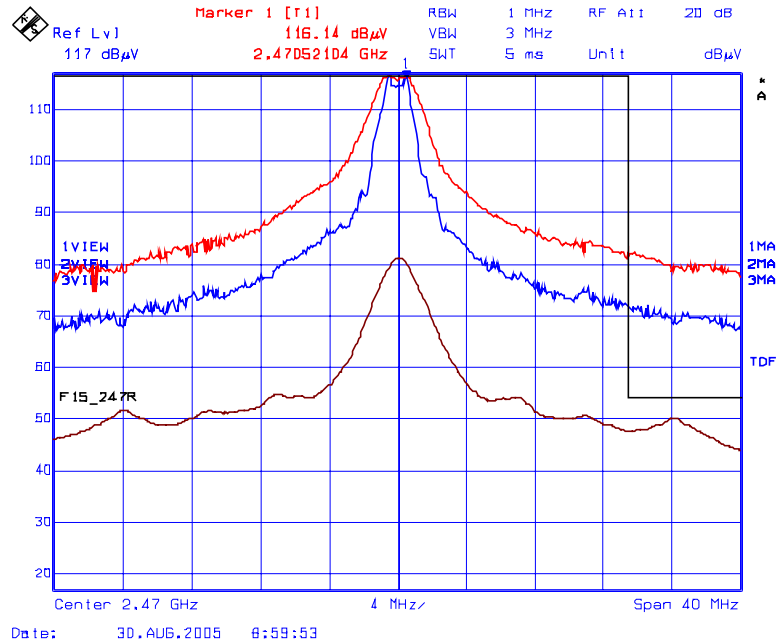

ULTRATECH GROUP OF LABS

3000 Bristol Circle, Oakville, Ontario, Canada L6H 6G4
 Tel. #: 905-829-1570, Fax. #: 905-829-8050, Email: vic@ultratech-labs.com, Website: <http://www.ultratech-labs.com>

File #: MXS--050F15C247
 September 22, 2005

All test results contained in this engineering test report are traceable to National Institute of Standards and Technology (NIST)

6.12.5.4. EUT tested with D-Link Antenna (Max. Antenna Gain = 15 dBi; Cable Loss = 17.1 dB)

Note:

The following cables were used for EUT tested with D-Link Antenna:

- 4 inch cable to connect U.FL to RPSMA (cable loss of 0.4 dB)
- CFD-200 NL antenna cable (3 meters; cable loss of 2.00 dB)
- Belden 7806R antenna cable (6 meters; cable loss of 4.00 dB)
- Belden 7806R antenna cable (6 meters; cable loss of 4.00 dB)
- LMR-400 coaxial cable (7 meters; cable loss of 1.8 dB)
- Coleman 8421 coaxial cable (10 meters; cable loss of 4.9 dB)

Fundamental Frequency: 2410 MHz
 Modulation: Digital Modulation
 Frequency Test Range: 30 MHz – 25 GHz

Frequency (MHz)	RF Peak Level (dB μ V/m)	RF Avg Level (dB μ V/m)	Antenna Plane (H/V)	Limit 15.209 (dB μ V/m)	Limit 15.247 (dB μ V/m)	Margin (dB)	Pass/Fail
2410	114.58	--	V	--	--	--	--
2410	112.98	--	H	--	--	--	--

All harmonics are more than 20 dB below the limit. No other spurious emissions were found from 30 MHz to 25 GHz. See test data plots (37 to 38) for band-edge emissions.

Plot#37: Band-Edge RF Radiated Emissions, Vertical Polarization
Low End of Frequency Band
Transmitter Frequency: 2410 MHz

Note:

- Trace 1: RBW=1MHz, RBW=3 MHz
- Trace 2: RBW=300 kHz, RBW=1 MHz, Delta (Peak to Band-Edge): 47.45 dB
- Trace 3: RBW=1 MHz, VBW=10 Hz
- Band-Edge Level at 2389 MHz: 114.58 dBμV/m – 47.45 dB = 67.13 dBμV/m

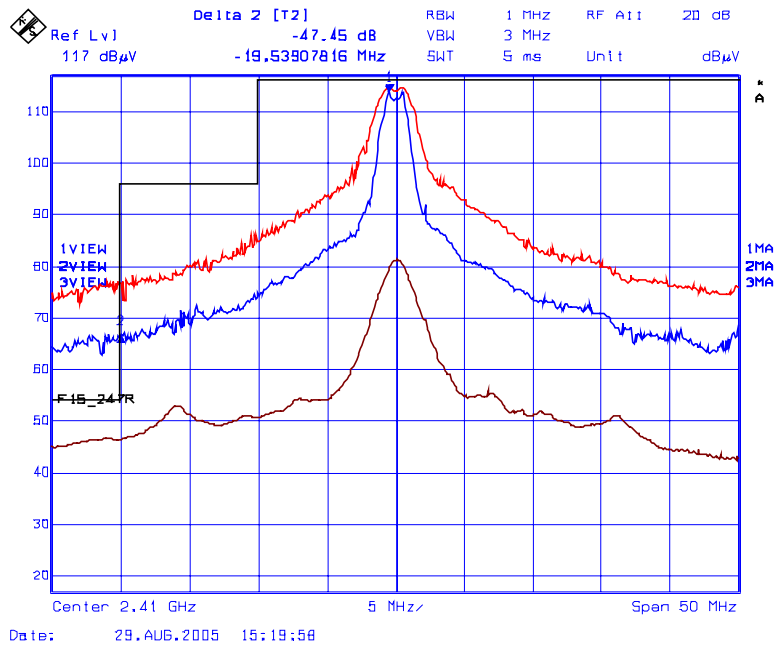
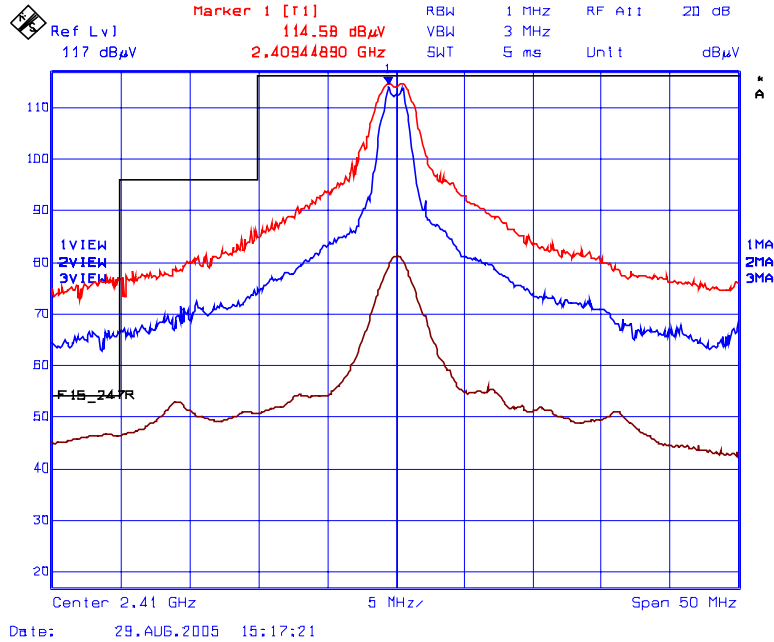

ULTRATECH GROUP OF LABS

3000 Bristol Circle, Oakville, Ontario, Canada L6H 6G4
Tel. #: 905-829-1570, Fax. #: 905-829-8050, Email: vic@ultratech-labs.com, Website: <http://www.ultratech-labs.com>

File #: MXS--050F15C247
September 22, 2005

All test results contained in this engineering test report are traceable to National Institute of Standards and Technology (NIST)

Plot#38: Band-Edge RF Radiated Emissions, Horizontal Polarization
Low End of Frequency Band
Transmitter Frequency: 2410 MHz

Note:

- Trace 1: RBW=1MHz, RBW=3 MHz
- Trace 2: RBW=300 kHz, RBW=1 MHz, Delta (Peak to Band-Edge): 48.90 dB
- Trace 3: RBW=1 MHz, VBW=10 Hz
- Band-Edge Level at 2389.32 MHz: 112.98 dBμV/m – 48.90 dB = 64.08 dBμV/m

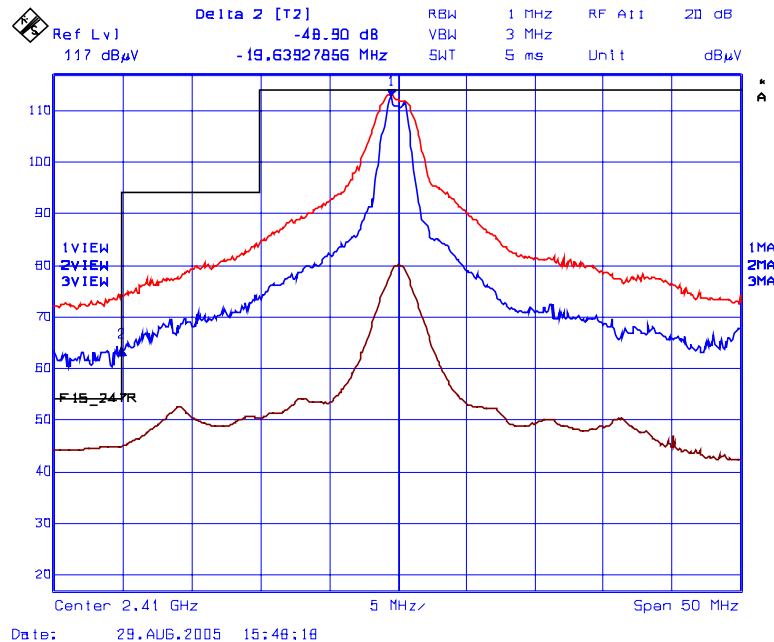
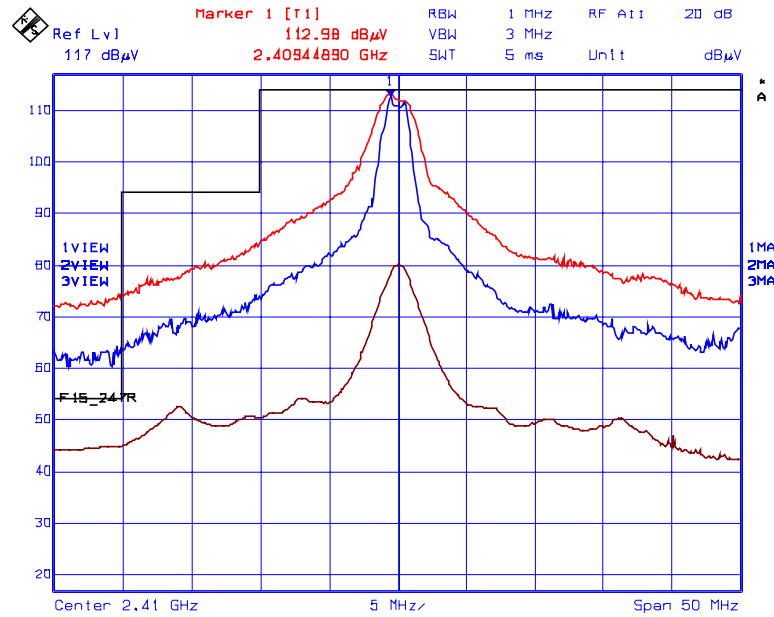

Fundamental Frequency: 2440 MHz
 Modulation: Digital Modulation
 Frequency Test Range: 30 MHz – 25 GHz

Frequency (MHz)	RF Peak Level (dBµV/m)	RF Avg Level (dBµV/m)	Antenna Plane (H/V)	Limit 15.209 (dBµV/m)	Limit 15.247 (dBµV/m)	Margin (dB)	Pass/Fail
2440	114.59	--	V	--	--	--	--
2440	114.01	--	H	--	--	--	--
7320	47.14	34.73	V	54.0	94.6	-19.3	Pass*

All other harmonics are more than 20 dB below the limit. No other spurious emissions were found from 30 MHz to 25 GHz.

* Emission within the restricted frequency bands.

Fundamental Frequency: 2470 MHz
 Modulation: Digital Modulation
 Frequency Test Range: 30 MHz – 25 GHz

Frequency (MHz)	RF Peak Level (dBµV/m)	RF Avg Level (dBµV/m)	Antenna Plane (H/V)	Limit 15.209 (dBµV/m)	Limit 15.247 (dBµV/m)	Margin (dB)	Pass/Fail
2470	115.38	--	V	--	--	--	--
2470	114.74	--	H	--	--	--	--
7410	47.87	34.51	V	54.0	95.4	-19.5	Pass*

All other harmonics are more than 20 dB below the limit. No other spurious emissions were found from 30 MHz to 25 GHz. See test data plots (39 to 40) for band-edge emissions.

* Emission within the restricted frequency bands.

Plot#39: Band-Edge RF Radiated Emissions, Vertical Polarization
Upper End of Frequency Band
Transmitter Frequency: 2470 MHz

Note:

- Trace 1: RBW=1MHz, RBW=3 MHz
- Trace 2: RBW=300 kHz, RBW=1 MHz, Delta (Peak to Band-Edge): 45.83 dB
- Trace 3: RBW=1 MHz, VBW=10 Hz
- Band-Edge Level at 2483.5 MHz: 115.38 dBμV/m – 45.83 dB = 69.75 dBμV/m

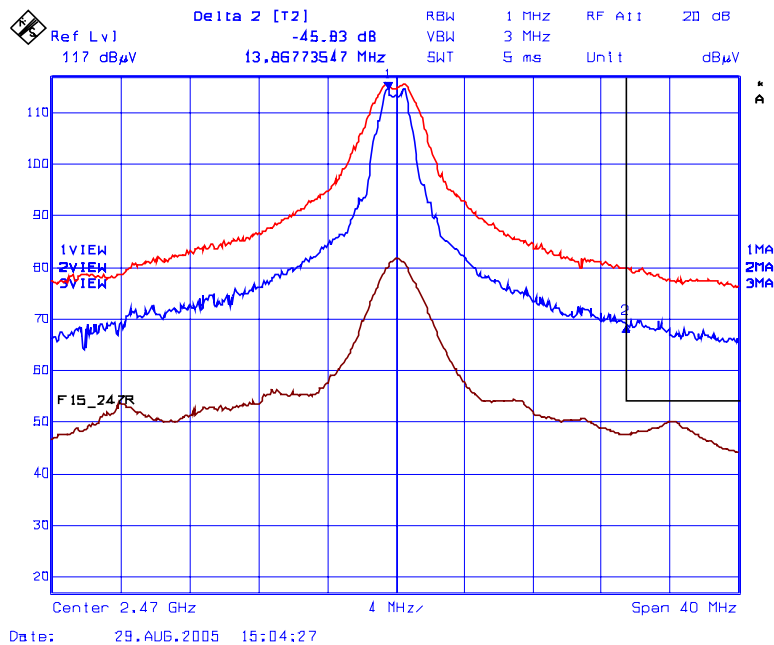
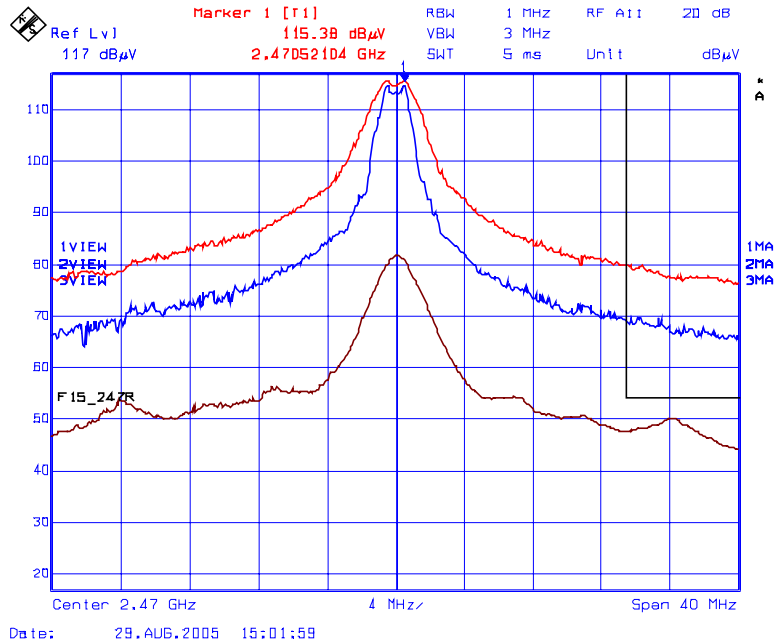

Plot#40: Band-Edge RF Radiated Emissions, Horizontal Polarization
Upper End of Frequency Band
Transmitter Frequency: 2470 MHz

Note:

- Trace 1: RBW=1MHz, RBW=3 MHz
- Trace 2: RBW=300 kHz, RBW=1 MHz, Delta (Peak to Band-Edge): 44.52 dB
- Trace 3: RBW=1 MHz, VBW=10 Hz
- Band-Edge Level at 2383.5 MHz: $114.76 \text{ dB}\mu\text{V/m} - 44.52 \text{ dB} = 70.24 \text{ dB}\mu\text{V/m}$

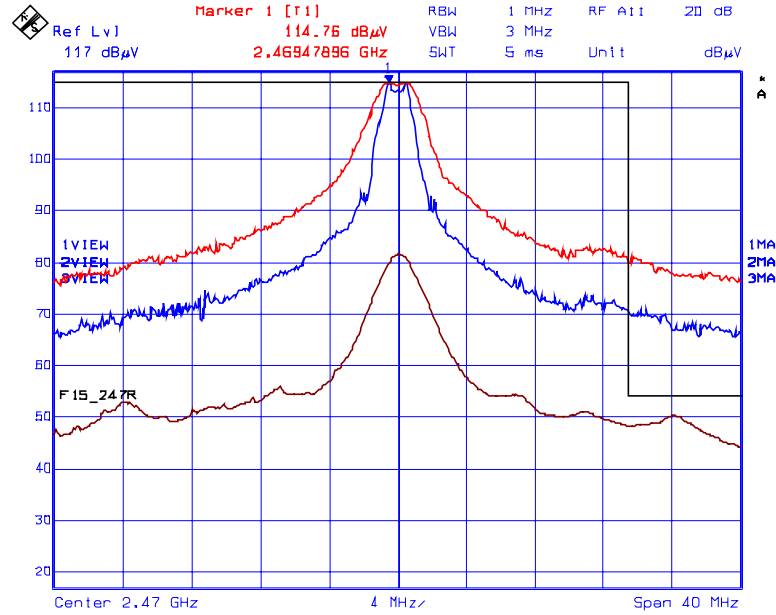

Date: 29.AUG.2005 15:57:17

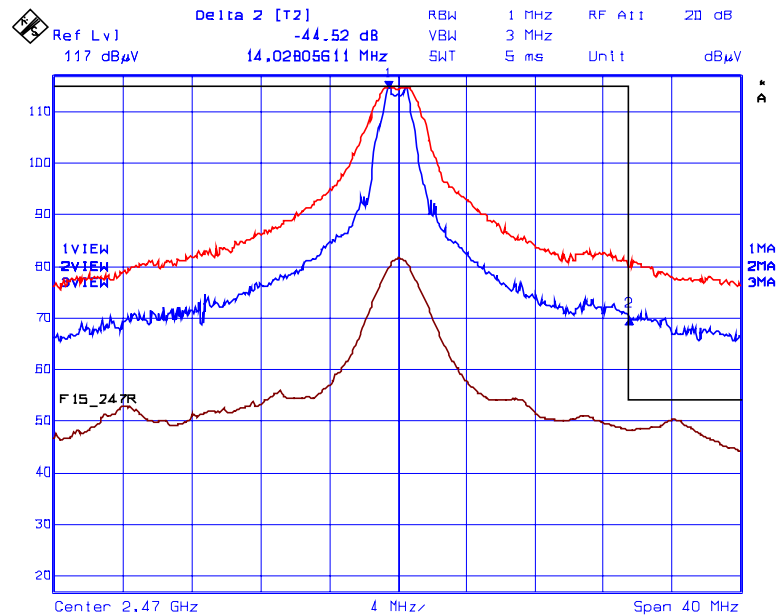

Date: 29.AUG.2005 15:59:29

ULTRATECH GROUP OF LABS

3000 Bristol Circle, Oakville, Ontario, Canada L6H 6G4
Tel. #: 905-829-1570, Fax. #: 905-829-8050, Email: vic@ultratech-labs.com, Website: <http://www.ultratech-labs.com>

File #: MXS--050F15C247
September 22, 2005

All test results contained in this engineering test report are traceable to National Institute of Standards and Technology (NIST)

6.12.5.5. EUT tested with Rubber Duck Antenna (Max. Antenna Gain = 2.1 dBi; Cable Loss = 0.4 dB)

Note:

The following cable was used for EUT tested with Rubber Duck Antenna:

- 4 inch cable to connect U.FL to RPSMA (cable loss of 0.4 dB)

Fundamental Frequency: 2410 MHz
 Modulation: Digital Modulation
 Frequency Test Range: 30 MHz – 25 GHz

Frequency (MHz)	RF Peak Level (dBµV/m)	RF Avg Level (dBµV/m)	Antenna Plane (H/V)	Limit 15.209 (dBµV/m)	Limit 15.247 (dBµV/m)	Margin (dB)	Pass/Fail
2410	116.06	--	V	--	--	--	--
2410	116.24	--	H	--	--	--	--

All harmonics are more than 20 dB below the limit. No other spurious emissions were found from 30 MHz to 25 GHz. See test data plots (41 to 42) for band-edge emissions.

Plot#41: Band-Edge RF Radiated Emissions, Vertical Polarization
 Low End of Frequency Band
 Transmitter Frequency: 2410 MHz

Note:

- Trace 1: RBW=1MHz, RBW=3 MHz
- Trace 2: RBW=300 kHz, RBW=1 MHz, Delta (Peak to Band-Edge): 47.54 dB
- Trace 3: RBW=1 MHz, VBW=10 Hz
- Band-Edge Level at 2388.38 MHz: 116.06 dBμV/m – 47.54 dB = 68.52 dBμV/m

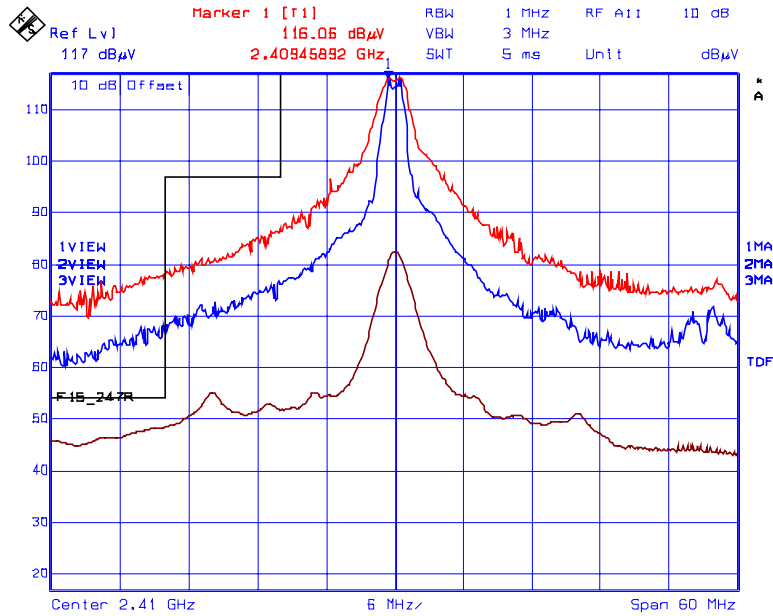

Date: 25.OCT.2005 10:12:57

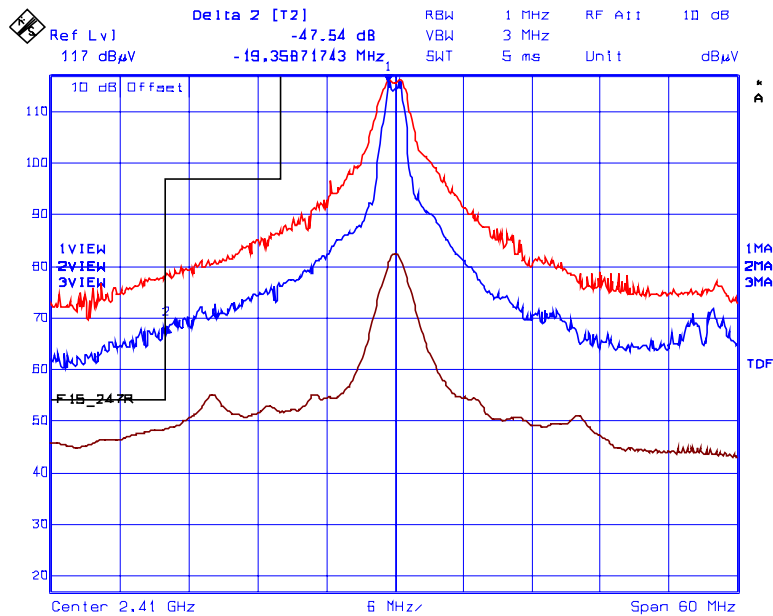

Date: 25.OCT.2005 10:37:07

ULTRATECH GROUP OF LABS

3000 Bristol Circle, Oakville, Ontario, Canada L6H 6G4
 Tel. #: 905-829-1570, Fax. #: 905-829-8050, Email: vic@ultratech-labs.com, Website: <http://www.ultratech-labs.com>

File #: MXS--050F15C247
 September 22, 2005

All test results contained in this engineering test report are traceable to National Institute of Standards and Technology (NIST)

Plot#42: Band-Edge RF Radiated Emissions, Horizontal Polarization
Low End of Frequency Band
Transmitter Frequency: 2410 MHz

Note:

- Trace 1: RBW=1MHz, RBW=3 MHz
- Trace 2: RBW=300 kHz, RBW=1 MHz, Delta (Peak to Band-Edge): 48.59 dB
- Trace 3: RBW=1 MHz, VBW=10 Hz
- Band-Edge Level at 2390 MHz: 116.24 dB μ V/m – 48.59 dB = 67.65 dB μ V/m

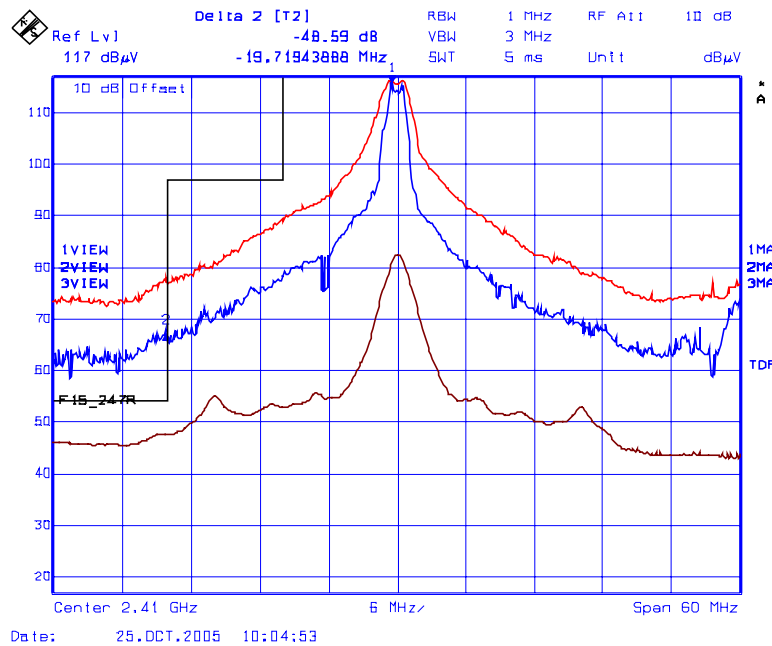
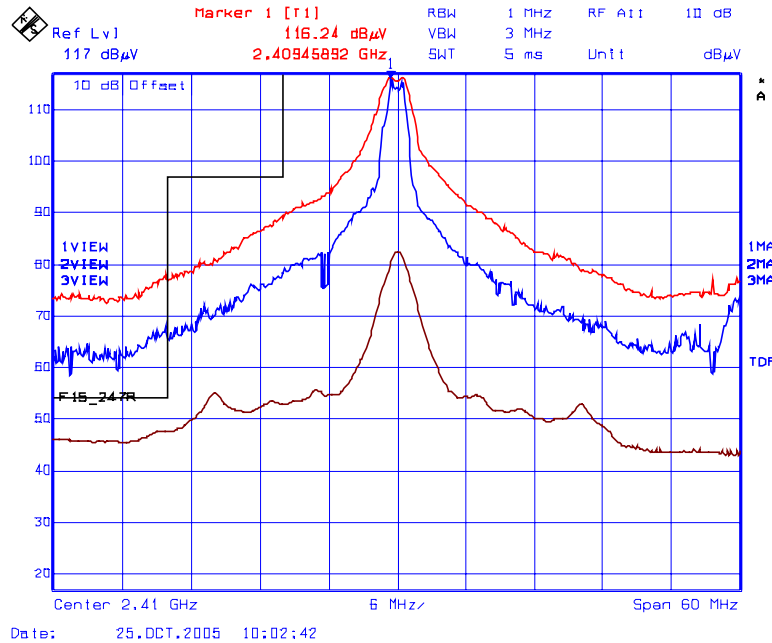

ULTRATECH GROUP OF LABS

3000 Bristol Circle, Oakville, Ontario, Canada L6H 6G4
Tel. #: 905-829-1570, Fax. #: 905-829-8050, Email: vic@ultratech-labs.com, Website: <http://www.ultratech-labs.com>

File #: MXS--050F15C247
September 22, 2005

All test results contained in this engineering test report are traceable to National Institute of Standards and Technology (NIST)

Fundamental Frequency: 2440 MHz
 Modulation: Digital Modulation
 Frequency Test Range: 30 MHz – 25 GHz

Frequency (MHz)	RF Peak Level (dBµV/m)	RF Avg Level (dBµV/m)	Antenna Plane (H/V)	Limit 15.209 (dBµV/m)	Limit 15.247 (dBµV/m)	Margin (dB)	Pass/Fail
2440	116.51	--	V	--	--	--	--
2440	116.80	--	H	--	--	--	--

All harmonics are more than 20 dB below the limit. No other spurious emissions were found from 30 MHz to 25 GHz.

Fundamental Frequency: 2465 MHz
 Modulation: Digital Modulation
 Frequency Test Range: 30 MHz – 25 GHz

Frequency (MHz)	RF Peak Level (dBµV/m)	RF Avg Level (dBµV/m)	Antenna Plane (H/V)	Limit 15.209 (dBµV/m)	Limit 15.247 (dBµV/m)	Margin (dB)	Pass/Fail
2465	116.27	--	V	--	--	--	--
2465	116.85	--	H	--	--	--	--

All other harmonics are more than 20 dB below the limit. No other spurious emissions were found from 30 MHz to 25 GHz. See test data plots (43 to 44) for band-edge emissions.

Plot#43: Band-Edge RF Radiated Emissions, Vertical Polarization
 Upper End of Frequency Band
 Transmitter Frequency: 2465 MHz

Note:

- Trace 1: RBW=1MHz, RBW=3 MHz
- Trace 2: RBW=300 kHz, RBW=1 MHz, Delta (Peak to Band-Edge): 49.93 dB
- Trace 3: RBW=1 MHz, VBW=10 Hz
- Band-Edge Level at 2488.38 MHz: 116.27 dBμV/m – 49.93 dB = 66.34 dBμV/m

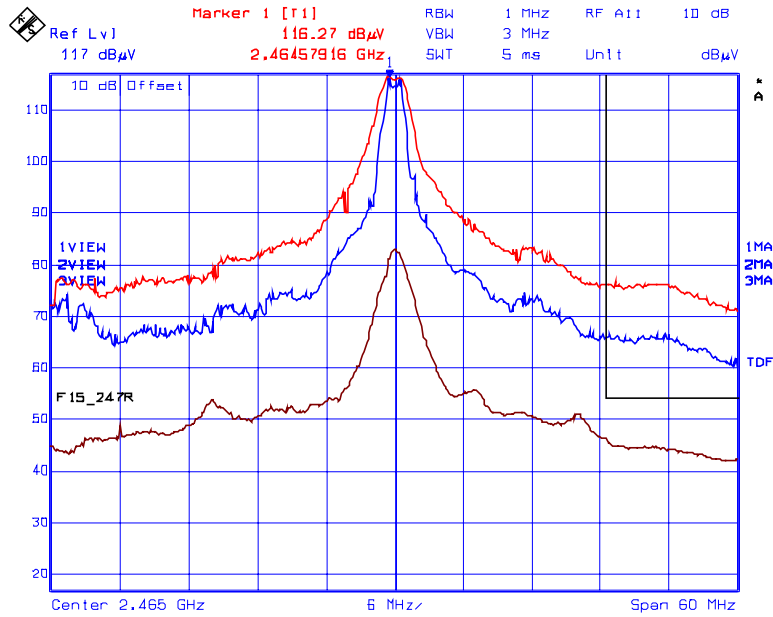

Date: 25.OCT.2005 9:09:23

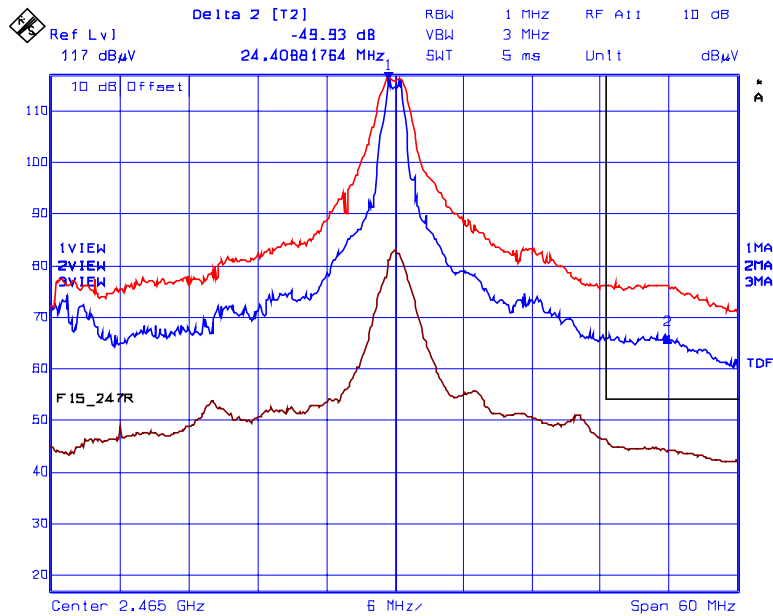

Date: 25.OCT.2005 9:11:26

ULTRATECH GROUP OF LABS

3000 Bristol Circle, Oakville, Ontario, Canada L6H 6G4
 Tel. #: 905-829-1570, Fax. #: 905-829-8050, Email: vic@ultratech-labs.com, Website: <http://www.ultratech-labs.com>

File #: MXS--050F15C247
 September 22, 2005

All test results contained in this engineering test report are traceable to National Institute of Standards and Technology (NIST)

Plot#40: Band-Edge RF Radiated Emissions, Horizontal Polarization
Upper End of Frequency Band
Transmitter Frequency: 2465 MHz

Note:

- Trace 1: RBW=1MHz, RBW=3 MHz
- Trace 2: RBW=300 kHz, RBW=1 MHz, Delta (Peak to Band-Edge): 49.90 dB
- Trace 3: RBW=1 MHz, VBW=10 Hz
- Band-Edge Level at 2383.5 MHz: 116.85 dBμV/m – 49.90 dB = 66.95 dBμV/m

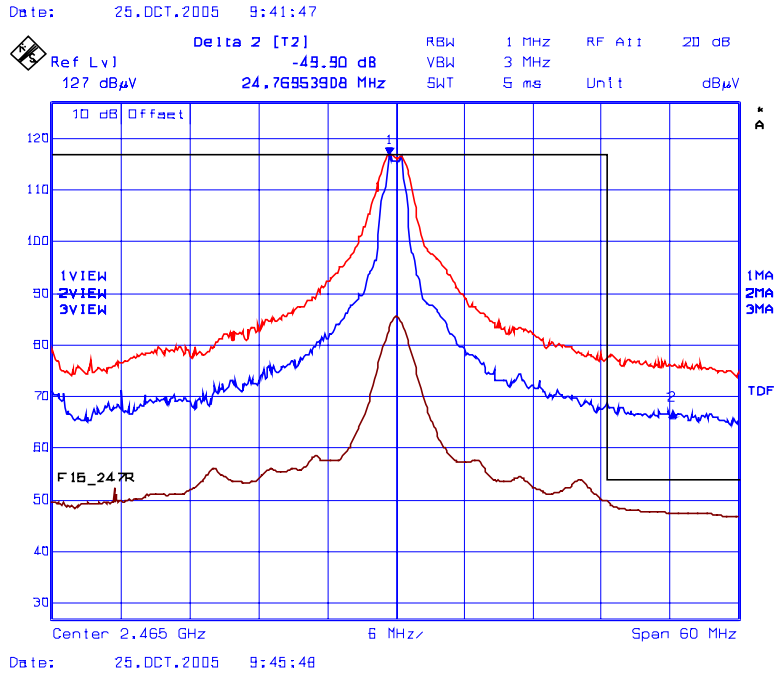
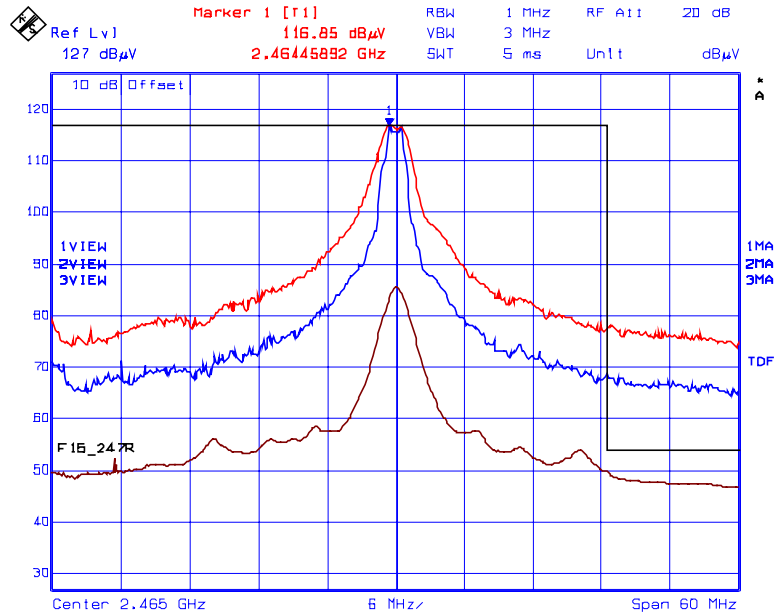

ULTRATECH GROUP OF LABS

3000 Bristol Circle, Oakville, Ontario, Canada L6H 6G4
Tel. #: 905-829-1570, Fax. #: 905-829-8050, Email: vic@ultratech-labs.com, Website: <http://www.ultratech-labs.com>

File #: MXS--050F15C247
September 22, 2005

All test results contained in this engineering test report are traceable to National Institute of Standards and Technology (NIST)

EXHIBIT 7. MEASUREMENT UNCERTAINTY

The measurement uncertainties stated were calculated in accordance with the requirements of NIST Technical Note 1297 and NIS 81 (1994)

7.1. LINE CONDUCTED EMISSION MESUREMENT UNCERTAINTY

CONTRIBUTION (Line Conducted)	PROBABILITY DISTRIBUTION	UNCERTAINTY (dB)	
		9-150 kHz	0.15-30 MHz
EMI Receiver specification	Rectangular	± 1.5	± 1.5
LISN coupling specification	Rectangular	± 1.5	± 1.5
Cable and Input Transient Limiter calibration	Normal (k=2)	± 0.3	± 0.5
Mismatch: Receiver VRC $\Gamma_1 = 0.03$ LISN VRC $\Gamma_R = 0.8(9 \text{ kHz}) 0.2 (30 \text{ MHz})$ Uncertainty limits $20\text{Log}(1 \pm \Gamma_1 \Gamma_R)$	U-Shaped	± 0.2	± 0.3
System repeatability	Std. deviation	± 0.2	± 0.05
Repeatability of EUT	--	--	--
Combined standard uncertainty	Normal	± 1.25	± 1.30
Expanded uncertainty U	Normal (k=2)	± 2.50	± 2.60

Sample Calculation for Measurement Accuracy in 450 kHz to 30 MHz Band:

$$u_c(y) = \sqrt{\sum_{i=1}^m u_i^2(y)} = \pm \sqrt{(1.5^2 + 1.5^2)/3 + (0.5/2)^2 + (0.05/2)^2 + 0.35^2} = \pm 1.30 \text{ dB}$$

$$U = 2u_c(y) = \pm 2.6 \text{ dB}$$

7.2. RADIATED EMISSION MEASUREMENT UNCERTAINTY

CONTRIBUTION (Radiated Emissions)	PROBABILITY DISTRIBUTION	UNCERTAINTY (+ dB)	
		3 m	10 m
Antenna Factor Calibration	Normal (k=2)	± 1.0	± 1.0
Cable Loss Calibration	Normal (k=2)	± 0.3	± 0.5
EMI Receiver specification	Rectangular	± 1.5	± 1.5
Antenna Directivity	Rectangular	± 0.5	± 0.5
Antenna factor variation with height	Rectangular	± 2.0	± 0.5
Antenna phase center variation	Rectangular	0.0	± 0.2
Antenna factor frequency interpolation	Rectangular	± 0.25	± 0.25
Measurement distance variation	Rectangular	± 0.6	± 0.4
Site imperfections	Rectangular	± 2.0	± 2.0
Mismatch: Receiver VRC $\Gamma_1 = 0.2$ Antenna VRC $\Gamma_R = 0.67$ (Bi) 0.3 (Lp) Uncertainty limits $20\text{Log}(1 \pm \Gamma_1 \Gamma_R)$	U-Shaped	+1.1 -1.25	± 0.5
System repeatability	Std. Deviation	± 0.5	± 0.5
Repeatability of EUT		-	-
Combined standard uncertainty	Normal	+2.19 / -2.21	+1.74 / -1.72
Expanded uncertainty U	Normal (k=2)	+4.38 / -4.42	+3.48 / -3.44

Calculation for maximum uncertainty when 3m biconical antenna including a factor of k=2 is used:

$$U = 2u_c(y) = 2x(+2.19) = +4.38 \text{ dB} \quad \text{and} \quad U = 2u_c(y) = 2x(-2.21) = -4.42 \text{ dB}$$

EXHIBIT 8. MEASUREMENT METHODS

8.1. GENERAL TEST CONDITIONS

The following test conditions shall be applied throughout the tests covered in this report.

8.1.1. Normal temperature and humidity

- Normal temperature: +15°C to +35°C
- Relative Humidity: +20% to 75%

The actual values during tests shall be recorded in the test report.

8.1.2. Normal power source

8.1.2.1. Mains Voltage

The nominal test voltage of the equipment to be connected to mains shall be the nominal mains voltage which is the declared voltage or any of the declared voltages for which the equipment was designed. The frequency of test power source corresponding to the AC mains shall be between 59 Hz and 61 Hz.

8.1.2.2. Battery Power Source

For operation from battery power sources, the nominal test voltage shall be as declared by the equipment manufacturer. This shall be recorded in the test report.

8.1.3. Operating Condition of Equipment under Test

- All tests were carried out while the equipment operated at the following frequencies:
 - The lowest operating frequency,
 - The middle operating frequency and
 - The highest operating frequency
- Modulation were applied using the Test Data sequence
- The transmitter was operated at the highest output power, or in the case the equipment able to operate at more than one power level, at the lowest and highest output powers.

8.2. METHOD OF MEASUREMENTS – AC MAINS CONDUCTED EMISSIONS

- AC Mains conducted emissions measurements were performed in accordance with the standard against appropriate limits for each detector function.
- The test was performed in the shielded room, 24'(L) x 16'(W) x 8'(H).
- The test was performed over the frequency range from 150 kHz to 30 MHz to determine the line-to-ground radio noise voltage which was conducted from the EUT power-input terminals that were directly connected to a public power network.
- The EUT normally received power from another device that connects to the public utility ac power lines, measurements would be made on that device with the EUT in operation to ensure that the device continues to comply with the appropriate limits while providing the EUT with power.
- If the EUT operates only from internal or dedicated batteries, with no provisions for connection to the public utility ac power lines, AC Mains conducted measurements are not required.
- Table-top devices were placed on a platform of nominal size 1 m by 1.5m raised 80 cm above the conducting ground plane.
- The EUT current-carrying power lead, except the ground (safety) lead, was individually connected through a LISN to the power source. All unused 50-Ohm connectors of the LISN was terminated in 50-ohm when not connected to the measuring instruments.
- The line cord of the EUT connected to one LISN which was connected to the measuring instrument. Those power cords for the units of devices not under measurement were connected to a separate multiple ac outlet. Drawings and photographs of typically conducted emission test setups were shown in the Test Report. Each current-carrying conductor of the EUT shall be individually tested.
- The EUT was normally operated with a ground (safety) connection, the EUT was connected to the ground at the LISN through a conductor provided in the lead from the ac power mains to the LISN.
- The excess length of the power cord was folded back and forth in an 8-shape on a wooden strip with a vertical prong located on the top of the LISN case.
- The EUT was set-up in its typical configuration and operated in its various modes as described in this test report.
- A preliminary scan was made by using spectrum analyzer system with the detector function set to PEAK mode (9 KHz RBW, VBW > RBW), frequency span 150 kHz to 30 MHz.
- The maximum conducted emission for a given mode of operation was found by using the following step-by-step procedure:
 - Step1. Monitor the frequency range of interest at a fixed EUT azimuth.
 - Step2. Manipulate the system cables and peripheral devices to produce highest amplitude signal relative to the limit. Note the amplitude and frequency of the suspect signal.
 - Step3. The effect of various modes of operation is examined. This is done by varying equipment operation modes as step 2 is being performed.
 - Step4. After completing step 1 through 3, record EUT and peripheral device configuration, mode of operation, cable configuration, signal levels and frequencies for final test.

Each highest signal level at the maximized test configuration was zoomed in a small frequency span on the spectrum analyzer's display (the manipulation of cables and peripheral devices and EUT operation modes might have to be repeated to obtain the highest signal level with the spectrum analyzer set to PEAK detector mode 10 KHz RBW and VBW > RBW). The spectrum analyzer was then set to CISPR QUASI-PEAK detector mode (9 KHz RBW, 1 MHz VBW) and AVERAGE detector mode (10 kHz RBW, 1 Hz VBW). The final highest RF signal levels and frequencies were recorded.

8.3. EQUIVALENT ISOTROPIC RADIATED POWER (EIRP)

8.3.1. Measurements of Transmitter Parameters (Duty Cycle & Peak Power)

- The following shall be applied to the combination(s) of the radio device and its intended antenna(e).
- If the RF level is user adjustable, all measurements shall be made with the highest power level available to the user for that combination.
- The following method of measurement shall apply to both conducted and radiated measurements.
- The radiated measurements are performed at the Ultratech Calibrated Open Field Test Site.
- The measurement shall be performed using normal operation of the equipment with modulation.

Test procedure shall be as follows:

Step 1: Duty Cycle Measurements

- Using a spectrum analyzer with the frequency span set to 0 Hz and the sweep time set at a suitable value to capture the envelope peaks and the duty cycle of the transmitter output signal;
- The duty cycle of the transmitter, $x = T_x \text{ on} / (T_x \text{ on} + T_x \text{ off})$ with $0 < x < 1$, is measure and recorded in the test report. For the purpose of testing, the equipment shall be operated with a duty cycle that is equal or more than 0.1.

Step 2: Calculation of Peak and Average EIRP

- The peak output power of the transmitter shall be determined using a wideband, calibrated RF Peak Power Meter with the power sensor with an integration period that exceeds the repetition period of the transmitter by a factor 5 or more. The observed value shall be recorded as “P” (in dBm);
- The Average EIRP shall be calculated from the above measured power output “A”, the observed duty cycle x, and the applicable antenna assembly gain “G” in dBi, according to the formula:

$$\text{Peak EIRP} = P + G$$
$$\text{Average EIRP} = \text{Peak EIRP} + 10\log(1/x)$$

Figure 1

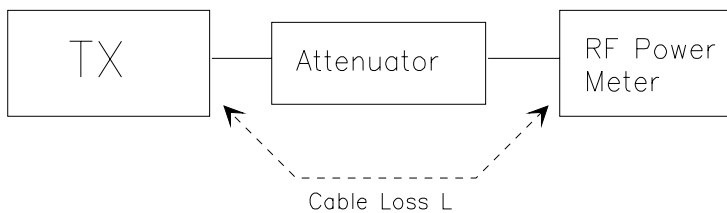

Step 3: Substitution Method. See Figure 2

- (a) The measurements was performed in the absence of modulation (un-modulated)
- (b) Test was performed at listed 3m open area test site (listed with FCC, IC, ITI, NVLAP, ACA & VCCI).
- (c) The transmitter under test was placed at the specified height on a non-conducting turntable (80 cm height)
- (d) The dipole test antenna was used and tuned to the transmitter carrier frequency.
- (e) The spectrum analyzer was tuned to transmitter carrier frequency. The test antenna was lowered or raised from 1 to 4 meters until the maximum signal level was detected.
- (f) The transmitter was rotated through 360° about a vertical axis until a higher maximum signal was received.
- (g) The test antenna was lowered or raised again from 1 to 4 meters until a maximum was obtained. This level was recorded.
- (h) The substitution dipole antenna and the signal generator replaced the transmitter and antenna under test in the same position, and the substitution dipole antenna was placed in vertical polarization. The test dipole antenna was lowered or raised as necessary to ensure that the maximum signal is still received.
- (i) The input signal to the substitution antenna was adjusted in level until an equal or a known related level to that detected from the transmitter was obtained in the test receiver. The maximum carrier radiated power is equal to the power supply by the generator.
- (j) The substitution antenna gain and cable loss were added to the signal generator level for the corrected ERP level.
- (k) Repeat steps (c) to (j) with the substitution antenna oriented in horizontal polarization.
- (l) Actual gain of the EUT's antenna is the difference of the measured ERP and measured RF power at the RF port. Correct the antenna gain if necessary.

Figure 2

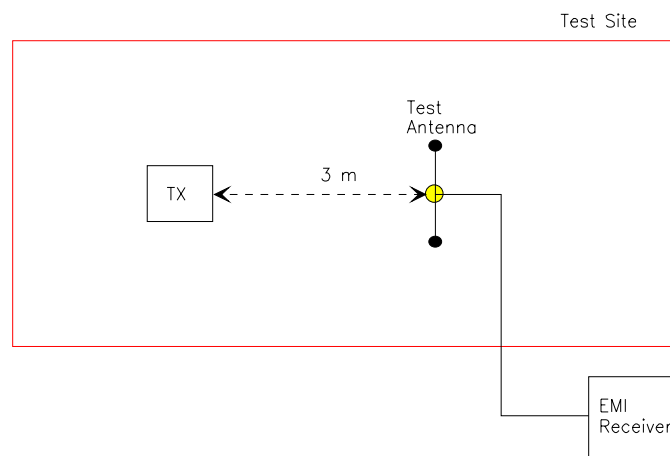
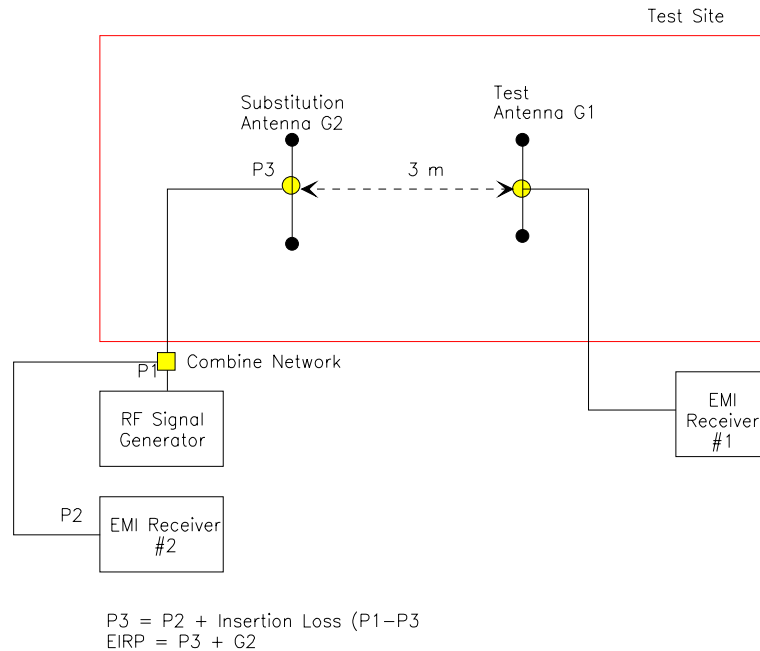

Figure 3



Use the following spectrum analyzer settings:

- Span = approximately 5 times the 20 dB BW, centered on a hopping channel
- RBW > 20 dB BW of the emission measured
- VBW = RBW
- Trace = max hold
- Allow the trace to stabilize
- Use the marker-to-marker function to set the marker to the peak of the emission.
- The indicated level is the peak output power (with the addition of the external attenuation and cable loss).
- The limit is specified in one of the subparagraph of this Section.
- Submit this plot.
- A peak responding power meter may be used instead of a spectrum analyzer.

8.4. SPURIOUS EMISSIONS (CONDUCTED & RADIATED)

For both conducted and radiated measurements, the spurious emissions were scanned from the lowest frequency generated by the EUT or 10 MHz whichever is lower to 10th harmonic of the highest frequency generated by the EUT.

8.4.1. Band-edge and Spurious Emissions (Conducted)

Band-edge Compliance of RF Conducted Emissions:

Use the following spectrum analyzer settings:

- The radio was connected to the measuring equipment via a suitable attenuator.
- Span = wide enough to capture the peak level of the emission operating on the channel closest to the band-edge, as well as any modulation products which fall outside of the authorized band of operation.
- RBW = 1 % of the span
- VBW = RBW
- Sweep = auto
- Detector function = peak
- Trace = max hold
- Allow the trace to stabilize
- Set the marker on the emission at the band-edge, or on the highest modulation product outside of the band, if this level is greater than that at the band-edge
- Enable the marker-delta function, then use the marker-to-peak function to move the marker to the peak of the in-band emission.
- The marker-delta value now displayed must comply with the limit specified
- Now, using the same instrument settings, enable the hopping function of the EUT
- Allow the trace to stabilize
- Follow the same procedure listed above to determine if any spurious emissions cause by the hopping function also comply with the specify limits.
- Submit this plot

Spurious RF Conducted Emissions:

Use the following spectrum analyzer settings:

- The radio was connected to the measuring equipment via a suitable attenuator.
- Span = wide enough to capture the peak level of the in-band-emission and all spurious emissions (e.g. harmonics) from the lowest frequency generated in the EUT up through the 10th harmonic. Typically, several plots are required to cover this entire span.
- RBW = 100 kHz
- VBW = RBW
- Sweep = auto
- Detector function = peak
- Trace = max hold
- Allow the trace to stabilize
- Set the marker on the any spurious emission recorded. The level displayed must comply with the limit specified in this Section.
- Submit this plot

8.4.2. Spurious Emissions (Radiated)

- The radiated emission measurements were performed at the UltraTech's 3-10 TDK Semi-Anechoic Chamber situated in the Town of Oakville, province of Ontario. The Attenuation Characteristics of TDK Semi-Anechoic Chamber have been filed with FCC and Industry Canada.
- Radiated emissions measurements were made using the following test instruments:
 1. Calibrated EMCO BiconiLog antenna in the frequency range from 30 MHz to 2000 MHz.
 2. Calibrated Emco Horn antennas in the frequency range above 1000 MHz (1GHz - 40 GHz).
 3. The test is required for any spurious emission or modulation product that falls in a Restricted Band, as defined in Section 15.205. It must be performed with the highest gain of each type of antenna proposed for use with the EUT. Use the following spectrum analyzer settings:
 - RBW = 100 kHz for $f < 1\text{GHz}$ and $\text{RBW} = 1\text{ MHz}$ for $f \geq 1\text{ GHz}$
 - VBW = RBW
 - Sweep = auto
 - Detector function = peak
 - Trace = max hold
 - Follows the guidelines in ANSI C63.4-2003 with respect to maximizing the emission by rotating the EUT, measuring the emission while the EUT is situated in three orthogonal planes (if appropriate), adjusting the measurement antenna height and polarization, etc.. A pre-amp and highpass filter are required for this test, in order to provide the measuring system with sufficient sensitivity.
 - Allow the trace to stabilize.
 - The peak reading of the emission, after being corrected by the antenna correction factor, cable loss, pre-amp gain, etc.... is the peak field strength which comply with the limit specified in Section 15.35(b)

Calculation of Field Strength:

The field strength is calculated by adding the calibrated antenna factor and cable factor, and subtracting the Amplifier gain (if any) from the measured reading. The basic equation with a sample calculation is as follows:

$$\text{FS} = \text{RA} + \text{AF} + \text{CF} - \text{AG}$$

Where FS = Field Strength
RA = Receiver/Analyzer Reading
AF = Antenna Factor
CF = Cable Attenuation Factor
AG = Amplifier Gain

Example: If a receiver reading of 60.0 dBuV is obtained, the antenna factor of 7.0 dB/m and cable factor of 1.0 dB are added, and the amplifier gain of 30 dB is subtracted. The actual field strength will be:

$$\text{Field Level} = 60 + 7.0 + 1.0 - 30 = 38.0 \text{ dBuV/m.}$$
$$\text{Field Level} = 10^{(38/20)} = 79.43 \text{ uV/m.}$$

- Submit this test data
- Now set the VBW to 10Hz, while maintaining all of the other instrument settings. This peak level, once corrected, must comply with the limit specified in Section 15.209. If the dwell time per channel

of the hopping signal is less than 100ms, then the reading obtained may be further adjusted by a “duty cycle correction factor”, derived from $10\log(\text{dwell time}/100\text{mS})$ in an effort to demonstrate compliance with the 15.209.

- Submit test data

Maximizing The Radiated Emissions:

- The frequencies of emissions were first detected. Then the amplitude of the emissions was measured at the specified measurement distance using required antenna height, polarization, and detector characteristics.
- During this process, cables and peripheral devices were manipulated within the range of likely configuration.
- For each mode of operation required to be tested, the frequency spectrum was monitored. Variations in antenna heights (from 1 meter to 4 meters above the ground plane), antenna polarization (horizontal plane and vertical plane), cable placement and peripheral placement were explored to produce the highest amplitude signal relative to the limit.

The maximum radiated emission for a given mode of operation was found by using the following step-by-step procedure:

Step 1: Monitor the frequency range of interest at a fixed antenna height and EUT azimuth.

Step 2: Manipulate the system cables to produce highest amplitude signal relative to the limit. Note the amplitude and frequency of the suspect signal.

Step 3: Rotate the EUT 360 degrees to maximize the suspected highest amplitude signal. If the signal or another at a different frequency is observed to exceed the previously noted highest amplitude signal by 1 dB or more, go back to the azimuth and repeat Step 2. Otherwise, orient the EUT azimuth to repeat the highest amplitude observation and proceed.

Step 4: Move the antenna over its full allowable range of travel (1 to 4 meters) to maximize the suspected highest amplitude signal. If the signal or another at a different frequency is observed to exceed the previously noted highest amplitude signal by 1 dB or more, return to Step 2 with the highest amplitude observation and proceed.

Step 5: Change the polarization of the antenna and repeat Step 2 through 4. Compare the resulting suspected highest amplitude signal with that found for the other polarization. Select and note the higher of the two signals. This signal is termed the highest observed signal with respect to the limit for this EUT operational mode.

Step 6: The effects of various modes of operation are examined. This is done by varying the equipment modes as steps 2 through 5 are being performed.

Step 7: After completing steps 1 through 6, record the final highest emission level, frequency, antenna polarization and detector mode of the measuring instrument.

8.5. ALTERNATIVE TEST PROCEDURES

If the antenna conducted tests cannot be performed on this device, radiated tests show compliance with the peak output power limit specified in Section 15.247(b) and the spurious RF conducted emission limit specified in Section 15.247 are acceptable. As stated previously, a pre-amp must be used in making the following measurements:

8.5.1. Peak Power Measurements

Calculate the transmitter's peak power using the following equation:

$$E = 30PG/d$$
$$P = (Ed)^2/30G$$

Where:

- E: measured maximum fundamental field strength in V/m. Set the RBW > 6dB bandwidth of the emission or use a peak-power meter.
- G is numeric gain of the transmitting antenna with reference to an isotropic radiator
- D is the distance in meters from which the field strength was measured
- P is the power in watts

8.5.2. Power Spectral Density

Measure the power spectral density as follows:

- A. Tune the analyzer to the highest point of the maximized fundamental emission. Reset the analyzer to RBW = 3 kHz, VBW > RBW, span = 300 kHz, sweep = 100 sec.
- B. From the peak level obtained in (A), derive the field strength, E, by applying the appropriate antenna factor, cable loss, pre-amp gain, etc. Using the equation listed above, calculate a power level for comparison to the + 8 dBm limit.

Note: The above settings are used for peak measurements. The optional procedures for output power and power spectral density measurements can be used when applicable.