

RF TEST REPORT

Test item : GNSS Data Collector
Model No. : FCC: Zeno 20
IC: ZENO20G
Order No. : DTNC1503-00985, DTNC1503-00986
Date of receipt : 2015-03-04
Test duration : 2015-03-11 ~ 2015-03-16
Date of issue : 2015-05-08
Use of report : FCC & IC Original Grant

Applicant : Leica Geosystems AG
Heinrich-Wild-Strasse Heerbrugg CH-9435 Switzerland

Test laboratory : DT&C Co., Ltd.
42, Yurim-ro, 154beon-gil, Cheoin-gu, Yongin-si, Gyeonggi-do, Korea 449-935

Test specification : FCC Part 15 Subpart C.247
RSS-247 Issue 1(2015-05)
RSS-GEN Issue 4(2014-11)
Test environment : See appended test report
Test result : Pass Fail

The test results presented in this test report are limited only to the sample supplied by applicant and the use of this test report is inhibited other than its purpose. This test report shall not be reproduced except in full, without the written approval of DT&C Co., Ltd.

Tested by:



Engineer
HyunSu Son

Reviewed by:



Technical Manager
HongHee Lee

Test Report Version

Test Report No.	Date	Description
DRTFCC1505-0088	May 08, 2015	Initial issue

Table of Contents

1. General Information	5
1.1. Testing Laboratory	5
1.2. Details of Applicant	5
1.3. Description of EUT	5
1.4. Declaration by the manufacturer	5
1.5. Information about the FHSS characteristics:	6
1.6. Test Equipment List	7
1.7. Summary of Test Results	8
1.8. Conclusion of worst-case and operation mode.....	9
2. Transmitter Radiated Spurious Emissions and Conducted Spurious Emission	10
2.1. Test Setup	10
2.2. Limit.....	10
2.3. Test Procedures.....	11
2.3.1. Test Procedures for Radiated Spurious Emissions.....	11
2.3.2. Test Procedures for Conducted Spurious Emissions	11
2.4. Test Results	12
2.4.1. Radiated Emission	12
2.4.2. Conducted Spurious Emissions	15
3. Carrier Frequency Separation.....	39
3.1. Test Setup	39
3.2. Limit.....	39
4. Number of Hopping Frequencies	44
4.1. Test Setup	44
4.2. Limit.....	44
5. 20dBc BW.....	50
5.1. Test Setup	50
5.2. Limit.....	50
5.3. Test Procedure	50
5.4. Test Results	50
6. Time of Occupancy (Dwell Time).....	56
6.1. Test Setup	56
6.2. Limit.....	56
6.3. Test Procedure	56
6.4. Test Results	56
7. Maximum Peak Output Power Measurement	61
7.1. Test Setup	61
7.2. Limit.....	61
7.3. Test Procedure.....	61
7.4. Test Results	62
8. Transmitter AC Power Line Conducted Emission	68

8.1. Test Setup	68
8.2. Limit.....	68
8.3. Test Procedures.....	68
8.4. Test Results	69
9. Antenna Requirement	71
10. Occupied Bandwidth (99%).....	72
APPENDIX I	79

1. General Information

1.1. Testing Laboratory

DT&C Co., Ltd.

Test site number 165783 (FCC), 5740A-3 (IC)

42, Yurim-ro, 154beon-gil, Cheoin-gu, Yongin-si, Gyeonggi-do, Korea 449-935

www.dtnc.net

Telephone : + 82-31-321-2664

FAX : + 82-31-321-1664

1.2. Details of Applicant

Applicant : Leica Geosystems AG

Address : Heinrich-Wild-Strasse Heerbrugg CH-9435 Switzerland

Contact person : Mr Hannes Juen

Phone No. : 0041717273098

1.3. Description of EUT

EUT	GNSS Data Collector
Model Name	FCC: Zeno 20 IC: ZENO20G
Add Model Name	N/A
Serial Number	Identical prototype
Power Supply	DC 3.7 V
Frequency Range	2402 MHz ~ 2480 MHz
Modulation Technique	GFSK, $\pi/4$ -DQPSK, 8DPSK
Number of Channels	79
Antenna Type	Internal Antenna
Antenna Gain	PK : 3.157 dBi
Product SW/HW version	Windows Embedded Handheld 6.5 Professional / MP
Radio SW/HW version	03.001 / 03
Test SW Version	V2.6 (TESCOM /TC-3000B)
RF power setting in TEST SW	N/A

1.4. Declaration by the manufacturer

- NA

1.5. Information about the FHSS characteristics:

- This Bluetooth module has been tested by a Bluetooth Qualification Lab, and we confirm the following:
 - A) The hopping sequence is pseudorandom
 - B) All channels are used equally on average
 - C) The receiver input bandwidth equals the transmit bandwidth
 - D) The receiver hops in sequence with the transmit signal
- 15.247(g): In accordance with the Bluetooth Industry Standard, the system is designed to comply with all of the regulations in Section 15.247 when the transmitter is presented with a continuous data (or information) system.
- 15.247(h): In accordance with the Bluetooth Industry Standard, the system does not coordinate its channels selection/ hopping sequence with other frequency hopping systems for the express purpose of avoiding the simultaneous occupancy of individual hopping frequencies by multiple transmitters.
- 15.247(h): The EUT employs Adaptive Frequency Hopping (AFH) which identifies sources of interference namely devices operating in 802.11 WLAN and excludes them from the list of available channels. The process of re-mapping reduces the number of test channels from 79 channels to a minimum number of 20 channels.

1.6. Test Equipment List

Type	Manufacturer	Model	Cal.Date (yy/mm/dd)	Next.Cal.Date (yy/mm/dd)	S/N
MXA Signal Analyzer	Agilent	N9020A	15/01/06	16/01/06	MY46471445
Bluetooth Tester	TESCOM	TC-3000B	14/06/26	15/06/26	3000B640046
Power Splitter	Anritsu	K241B	14/09/12	15/09/12	020611
Digital Multimeter	H.P	34401A	15/01/06	16/01/06	US36099541
Dynamic Measurement DC Source	Agilent	66332A	14/10/07	15/10/07	US37473305
Thermohygrometer	BODYCOM	BJ5478	14/05/13	15/05/13	120612-2
Vector Signal Generator	Rohde Schwarz	SMBV100A	15/01/06	16/01/06	255571
Signal Generator	R&S	SMF100A	14/07/01	15/07/01	102341
High-pass filter	Wainwright	WHKX3.0	15/01/06	16/01/06	12
LOOP Antenna	Schwarzbeck	FMZB1513	14/04/29	16/04/29	1513-128
TRILOG Broadband Test-Antenna(30MHz-1GHz)	Schwarzbeck	VULB 9160	14/04/30	16/04/30	3358
Double-Ridged Guide Antenna	ETS	3117	14/05/12	16/05/12	00140394
Horn Antenna	A.H.Systems	SAS-574	13/05/27	15/05/27	155
Low Noise Pre Amplifier	tsj	MLA-010K01-B01-27	14/04/09	15/04/09	1844538
			15/04/09	16/04/09	
Amplifier (30dB)	Agilent	8449B	15/02/26	16/02/26	3008A00370
EMI TEST RECEIVER	R&S	ESR7	14/10/21	15/10/21	101109
EMI TEST RECEIVER	R&S	ESC17	15/02/25	16/02/25	100910
CVCF	EM TEST	ENTWAVE 60-400	14/05/26	15/05/26	P1311115470
ARTIFICIAL MAINS NETWORK	R&S	ESH2-Z5	14/09/11	15/09/11	828739/006
PULSE LIMITER	R&S	ESH3-Z2	14/10/21	15/10/21	101333

1.7. Summary of Test Results

FCC Part RSS-247 & GEN	Parameter	Limit (Using in 2400~ 2483.5MHz)	Test Condition	Status Note 1	
15.247(a) RSS-247(5.1)	Carrier Frequency Separation	>= 20dB BW or >= Two-Thirds of the 20dB BW	Conducted	C	
	Number of Hopping Frequencies	>= 15 hops		C	
	20 dB Bandwidth	None		C	
	Dwell Time	=< 0.4 seconds		C	
15.247(b) RSS-247(5.4)	Transmitter Output Power	For FCC =< 1 Watt , if CHs >= 75 Others =<0.125 W For IC if CHs >= 75 =< 1 Watt For Conducted Power =< 4 Watt For e.i.r.p, Others =<0.125 W For Conducted Power. =< 0.5 Watt For e.i.r.p		C	
15.247(d) RSS-247(5.5)	Band-edge	The radiated emission to any 100 kHz of out-band shall be at least 20dB below the highest in- band spectral density.		C	
	Conducted Spurious Emissions			C	
RSS Gen(6.6)	Occupied Bandwidth (99 %)	RSS-Gen		C	
15.205 15.209 RSS-247(5.5)	RadiatedEmissions	FCC 15.209 Limits		Radiated	C
15.207 RSS-Gen(8.8)	AC Conducted Emissions	FCC 15.207 Limits		AC Line Conducted	C
15.203 RSS-Gen(6.7)	Antenna Requirements	FCC 15.203	-	C	
<p>Note 1: C=Comply NC=Not Comply NT=Not Tested NA=Not Applicable</p> <p>Note 2: The sample was tested according to the following specification: ANSI C63.10-2013, DA00-705</p>					

1.8 Conclusion of worst-case and operation mode

The EUT has three type of modulation (GFSK, $\pi/4$ DQPSK and 8DPSK).

Therefore all applicable requirements were tested with all the modulations.

The field strength of spurious emission was measured in three orthogonal EUT positions(X-axis, Y-axis and Z-axis).

Tested frequency information,

- Hopping Function: Enable

	TXFrequency(MHz)	RX Frequency(MHz)
Hopping Band	2402 ~ 2480	2402 ~ 2480

- Hopping Function: Disable

	TXFrequency(MHz)	RX Frequency(MHz)
Lowest Channel	2402	2402
Middle Channel	2441	2441
Highest Channel	2480	2480

2. Transmitter Radiated Spurious Emissions and Conducted Spurious Emission

2.1. Test Setup

Refer to the APPENDIX I.

2.2. Limit

According to §15.247(d), in any 100 kHz bandwidth outside the frequency band in which the spread spectrum or digitally modulated intentional radiator is operating, the radio frequency power that is produced by the intentional radiator shall be at least 20 dB below that in the 100 kHz bandwidth within the band that contains the highest level of the desired power, based on either an RF conducted or a radiated measurement, provided the transmitter demonstrates compliance with the peak conducted power limits. If the transmitter complies with the conducted power limits based on the use of RMS averaging over a time interval, as permitted under paragraph(b)(3) of this section, the attenuation required under this paragraph shall be 30 dB instead of 20 dB. Attenuation below the general limits specified in section §15.209(a) is not required. In addition, radiated emission which in the restricted band, as define in section §15.205(a), must also comply the radiated emission limits specified in section §15.209(a) (see section §15.205(c))

According to § 15.209(a), except as provided elsewhere in this Subpart, the emissions from an intentional radiator shall not exceed the field strength levels specified in the following table

Frequency (MHz)	Limit (uV/m)	Measurement Distance (meter)
0.009 – 0.490	2400/F(KHz)	300
0.490 – 1.705	24000/F(KHz)	30
1.705 – 30.0	30	30
30 ~ 88	100 **	3
88 ~ 216	150 **	3
216 ~ 960	200 **	3
Above 960	500	3

** Except as provided in 15.209(g), fundamental emissions from intentional radiators operating under this Section shall not be located in the frequency bands 54-72 MHz, 76-88MHz, 174-216MHz or 470-806MHz. However, operation within these frequency bands is permitted under other sections of this Part, e.g. 15.231 and 15.241.

According to § 15.205(a) and (b), only spurious emissions are permitted in any of the frequency bands listed below:

MHz	MHz	MHz	MHz	GHz	GHz
0.009 ~ 0.110	8.41425 ~ 8.41475	108 ~ 121.94	1300 ~ 1427	4.5 ~ 5.15	14.47 ~ 14.5
0.495 ~ 0.505	12.29 ~ 12.293	123 ~ 138	1435 ~ 1626.5	5.35 ~ 5.46	15.35 ~ 16.2
2.1735 ~ 2.1905	12.51975 ~ 12.52025	149.9 ~ 150.05	1645.5 ~ 1646.5	7.25 ~ 7.75	17.7 ~ 21.4
4.125 ~ 4.128	12.57675 ~ 12.57725	156.52475 ~	1660 ~ 1710	8.025 ~ 8.5	22.01 ~ 23.12
4.17725 ~ 4.17775	13.36 ~ 13.41	156.52525	1718.8 ~ 1722.2	9.0 ~ 9.2	23.6 ~ 24.0
4.20725 ~ 4.20775	16.42 ~ 16.423	156.7 ~ 156.9	2200 ~ 2300	9.3 ~ 9.5	31.2 ~ 31.8
6.215 ~ 6.218	16.69475 ~ 16.69525	162.0125 ~ 167.17	2310 ~ 2390	10.6 ~ 12.7	36.43 ~ 36.5
6.26775 ~ 6.26825	16.80425 ~ 16.80475	167.72 ~ 173.2	2483.5 ~ 2500	13.25 ~ 13.4	Above 38.6
6.31175 ~ 6.31225	25.5 ~ 25.67	240 ~ 285	2655 ~ 2900		
8.291 ~ 8.294	37.5 ~ 38.25	322 ~ 335.4	3260 ~ 3267		
8.362 ~ 8.366	73 ~ 74.6	399.90 ~ 410	3332 ~ 3339		
8.37625 ~ 8.38675	74.8 ~ 75.2	608 ~ 614	3345.8 ~ 3358		
		960 ~ 1240	3600 ~ 4400		

The field strength of emissions appearing within these frequency bands shall not exceed the limits shown in §15.209. At frequencies equal to or less than 1000 MHz, compliance with the limits in §15.209 shall be demonstrated using measurement instrumentation employing a CISPR quasi-peak detector. Above 1000 MHz, compliance with the emission limits in §15.209 shall be demonstrated based on the average value of the measured emissions. The provisions in §15.35 apply to these measurements.

2.3. Test Procedures

Radiated emissions from the EUT were measured according to the DA 00-705 and ANSI C63.10:2013

2.3.1. Test Procedures for Radiated Spurious Emissions

1. The EUT is placed on a non-conductive table. For emission measurements at or below 1 GHz, the table height is 80 cm. For emission measurements above 1 GHz, the table height is 1.5 m. The table was rotated 360 degrees to determine the position of the highest radiation.
1. During performing radiated emission below 1 GHz, the EUT was set 3 meters away from the interference receiving antenna, which was mounted on the top of a variable-height antenna tower. During performing radiated emission above 1 GHz, the EUT was set 3 meter away from the interference-receiving antenna.
2. For measurements above 1GHz absorbers are placed on the floor between the turn table and the antenna mast in such a way so as to maximize the reduction of reflections. For measurements below 1GHz, the absorbers are removed.
3. The antenna is a broadband antenna, and its height is varied from one meter to four meters above the ground to determine the maximum value of the field strength. Both horizontal and vertical polarizations of the antenna are set to make the measurement.
4. For each suspected emission, the EUT was arranged to its worst case and then the antenna was tuned to heights from 1 meter to 4 meters and the table was turned from 0 degrees to 360 degrees to find the maximum reading.
5. The test-receiver system was set to Peak Detect Function and Specified Bandwidth with Maximum Hold Mode.
6. If the emission level of the EUT in peak mode was 10dB lower than the limit specified, then testing could be stopped and the peak values of the EUT would be reported. Otherwise the emissions that did not have 10dB margin would be re-tested one by one using peak, quasi-peak or average method as specified and then reported in a data sheet.

NOTE 1. The resolution bandwidth and video bandwidth of test receiver/spectrum analyzer is 120kHz for Quasi-peak detection (QP) at frequency below 1GHz.

NOTE 2. The resolution bandwidth and video bandwidth of test receiver/spectrum analyzer is 1MHz for Peak detection and frequency above 1GHz.

NOTE 3. The resolution bandwidth of test receiver/spectrum analyzer is 1MHz and the video bandwidth is 1kHz for Average detection (AV) at frequency above 1GHz.

2.3.2. Test Procedures for Conducted Spurious Emissions

1. The transmitter output was connected to the spectrum analyzer.
2. The **reference level** of the fundamental frequency was measured with the spectrum analyzer using RBW=100 kHz, VBW=300 kHz.
3. The conducted spurious emission was tested each ranges were set as below.

Frequency range: 9 KHz ~ 30 MHz

RBW= 100kHz, VBW= 300kHz, SWEEP TIME = AUTO, DETECTOR = PEAK, TRACE = MAX HOLD, SWEEP POINT: 40001

Frequency range: 30 MHz ~ 10 GHz, 10 GHz~25 GHz

RBW= 1MHz, VBW= 3MHz, SWEEP TIME = AUTO, DETECTOR = PEAK, TRACE = MAX HOLD, SWEEP POINT: 40001

LIMIT LINE = 20 dB below of the reference level of above measurement procedure Step 2. (RBW = 100 KHz, VBW = 300 KHz)

If the emission level with above setting was close to the limit (ie, less than 3 dB margin) then zoom scan is required using RBW = 100 KHz, VBW = 300KHz, SPAN = 100 MHz and BINS = 2001 to get accurate emission level within 100 KHz BW.

Also the path loss for conducted measurement setup was used as described on the Appendix I of this test report.

2.4. Test Results

Ambient temperature : 22 °C

Relative humidity : 34 %

2.4.1. Radiated Emission

9kHz ~ 25GHz Data(Modulation: GFSK)

▪ Lowest Channel

Frequency (MHz)	ANT Pol	The worst case EUT Position (Axis)	Detector Mode	Reading (dBuV)	T.F (dB/m)	D.C.F. (dB)	Distance Factor (dB)	Result (dBuV/m)	Limit (dBuV/m)	Margin (dB)
2382.72	H	X	PK	47.65	-1.36	N/A	N/A	46.29	74.00	27.71
2382.32	H	X	AV	35.29	-1.36	N/A	N/A	33.93	54.00	20.07
4803.92	H	X	PK	47.36	7.95	N/A	N/A	55.31	74.00	18.69
4803.98	H	X	AV	37.63	7.95	N/A	N/A	45.58	54.00	8.42

▪ Middle Channel

Frequency (MHz)	ANT Pol	The worst case EUT Position (Axis)	Detector Mode	Reading (dBuV)	T.F (dB/m)	D.C.F. (dB)	Distance Factor (dB)	Result (dBuV/m)	Limit (dBuV/m)	Margin (dB)
4881.93	H	X	PK	46.31	7.52	N/A	N/A	53.83	74.00	20.17
4882.01	H	X	AV	37.11	7.52	N/A	N/A	44.63	54.00	9.37

▪ Highest Channel

Frequency (MHz)	ANT Pol	The worst case EUT Position (Axis)	Detector Mode	Reading (dBuV)	T.F (dB/m)	D.C.F. (dB)	Distance Factor (dB)	Result (dBuV/m)	Limit (dBuV/m)	Margin (dB)
2484.39	H	X	PK	49.31	-1.52	N/A	N/A	47.79	74.00	26.21
2484.51	H	X	AV	37.02	-1.52	N/A	N/A	35.50	54.00	18.50
4960.59	H	X	PK	45.66	8.42	N/A	N/A	54.08	74.00	19.92
4960.24	H	X	AV	34.27	8.42	N/A	N/A	42.69	54.00	11.31

▪ Hopping Mode

Frequency (MHz)	ANT Pol	The worst case EUT Position (Axis)	Detector Mode	Reading (dBuV)	T.F (dB/m)	D.C.F. (dB)	Distance Factor (dB)	Result (dBuV/m)	Limit (dBuV/m)	Margin (dB)
2379.90	H	X	PK	47.26	-1.36	N/A	N/A	45.90	74.00	28.10
2379.92	H	X	AV	35.36	-1.36	N/A	N/A	34.00	54.00	20.00
2489.19	H	X	PK	50.22	-1.52	N/A	N/A	48.70	74.00	25.30
2488.98	H	X	AV	36.93	-1.52	N/A	N/A	35.41	54.00	18.59

Note.

- No other spurious and harmonic emissions were found greater than listed emissions on above table.
- The bandedge test has performed between 2310-2390MHz for low channel and 2483.5-2500MHz for high channel.
The worst results were reported in the table.
- Sample Calculation.
Margin = Limit – Result / Result = Reading + T.F + D.C.F. / T.F = AF + CL – AG
Where, T.F = Total Factor, AF = Antenna Factor, CL = Cable Loss, AG = Amplifier Gain,
- D.C.F Calculation. (D.C.F. = Duty Cycle Correction Factor)
 - Time to cycle through all channels= $\Delta t = T_{[ms]} \times 20$ minimum hopping channels , where T = pulse width
 - $100ms / \Delta t_{[ms]} = H \rightarrow$ Round up to next highest integer, to account for worst case, H'
 - The Worst Case Dwell Time = $T_{[ms]} \times H'$
 - D.C.F = $20 \times \text{Log}(\text{The Worst Case Dwell Time} / 100ms)dB$

9kHz ~ 25GHz Data(Modulation: $\pi/4$ DQPSK)

▪ Lowest Channel

Frequency (MHz)	ANT Pol	The worst case EUT Position (Axis)	Detector Mode	Reading (dBuV)	T.F (dB/m)	D.C.F. (dB)	Distance Factor (dB)	Result (dBuV/m)	Limit (dBuV/m)	Margin (dB)
2363.36	H	X	PK	48.25	-1.36	N/A	N/A	46.89	74.00	27.11
2362.88	H	X	AV	38.10	-1.36	N/A	N/A	36.74	54.00	17.26
4804.17	H	X	PK	45.96	7.95	N/A	N/A	53.91	74.00	20.09
4804.19	H	X	AV	33.51	7.95	N/A	N/A	41.46	54.00	12.54

▪ Middle Channel

Frequency (MHz)	ANT Pol	The worst case EUT Position (Axis)	Detector Mode	Reading (dBuV)	T.F (dB/m)	D.C.F. (dB)	Distance Factor (dB)	Result (dBuV/m)	Limit (dBuV/m)	Margin (dB)
4882.35	H	X	PK	45.20	7.52	N/A	N/A	52.72	74.00	21.28
4881.97	H	X	AV	32.57	7.52	N/A	N/A	40.09	54.00	13.91

▪ Highest Channel

Frequency (MHz)	ANT Pol	The worst case EUT Position (Axis)	Detector Mode	Reading (dBuV)	T.F (dB/m)	D.C.F. (dB)	Distance Factor (dB)	Result (dBuV/m)	Limit (dBuV/m)	Margin (dB)
2483.56	H	X	PK	50.69	-1.52	N/A	N/A	49.17	74.00	24.83
2483.50	H	X	AV	36.97	-1.52	N/A	N/A	35.45	54.00	18.55
4960.34	H	X	PK	44.46	8.42	N/A	N/A	52.88	74.00	21.12
4959.99	H	X	AV	32.23	8.42	N/A	N/A	40.65	54.00	13.35

▪ Hopping Mode

Frequency (MHz)	ANT Pol	The worst case EUT Position (Axis)	Detector Mode	Reading (dBuV)	T.F (dB/m)	D.C.F. (dB)	Distance Factor (dB)	Result (dBuV/m)	Limit (dBuV/m)	Margin (dB)
2370.48	H	X	PK	46.59	-1.36	N/A	N/A	45.23	74.00	28.77
2376.08	H	X	AV	38.19	-1.36	N/A	N/A	36.83	54.00	17.17
2495.58	H	X	PA	48.73	-1.52	N/A	N/A	47.21	74.00	26.79
2495.00	H	X	AV	37.63	-1.52	N/A	N/A	36.11	54.00	17.89

Note.

- No other spurious and harmonic emissions were found greater than listed emissions on above table.
- The bandedge test has performed between 2310-2390MHz for low channel and 2483.5-2500MHz for high channel.
The worst results were reported in the table.
- Sample Calculation.
Margin = Limit – Result / Result = Reading + T.F + D.C.F. / T.F = AF + CL – AG
Where, T.F = Total Factor, AF = Antenna Factor, CL = Cable Loss, AG = Amplifier Gain,
- D.C.F Calculation. (D.C.F. = Duty Cycle Correction Factor)
 - Time to cycle through all channels= $\Delta t = T_{[ms]} \times 20$ minimum hopping channels , where T = pulse width
 - $100ms / \Delta t_{[ms]} = H \rightarrow$ Round up to next highest integer, to account for worst case, H'
 - The Worst Case Dwell Time = $T_{[ms]} \times H'$
 - D.C.F = $20 \times \text{Log}(\text{The Worst Case Dwell Time} / 100ms)$ dB

9kHz ~ 25GHz Data(Modulation: 8DPSK)

▪ Lowest Channel

Frequency (MHz)	ANT Pol	The worst case EUT Position (Axis)	Detector Mode	Reading (dBuV)	T.F (dB/m)	D.C.F. (dB)	Distance Factor (dB)	Result (dBuV/m)	Limit (dBuV/m)	Margin (dB)
2379.92	H	X	PK	63.97	-1.36	N/A	N/A	62.61	74.00	11.39
2379.76	H	X	AV	44.31	-1.36	N/A	N/A	42.95	54.00	11.05
4804.33	H	X	PK	45.77	7.95	N/A	N/A	53.72	74.00	20.28
4804.07	H	X	AV	33.45	7.95	N/A	N/A	41.40	54.00	12.60

▪ Middle Channel

Frequency (MHz)	ANT Pol	The worst case EUT Position (Axis)	Detector Mode	Reading (dBuV)	T.F (dB/m)	D.C.F. (dB)	Distance Factor (dB)	Result (dBuV/m)	Limit (dBuV/m)	Margin (dB)
4882.09	H	X	PK	45.15	7.52	N/A	N/A	52.67	74.00	21.33
4881.70	H	X	AV	32.63	7.52	N/A	N/A	40.15	54.00	13.85

▪ Highest Channel

Frequency (MHz)	ANT Pol	The worst case EUT Position (Axis)	Detector Mode	Reading (dBuV)	T.F (dB/m)	D.C.F. (dB)	Distance Factor (dB)	Result (dBuV/m)	Limit (dBuV/m)	Margin (dB)
2484.01	H	X	PK	50.28	-1.52	N/A	N/A	48.76	74.00	25.24
2483.50	H	X	AV	37.50	-1.52	N/A	N/A	35.98	54.00	18.02
4960.19	H	X	PK	45.18	8.42	N/A	N/A	53.60	74.00	20.40
4959.76	H	X	AV	32.35	8.42	N/A	N/A	40.77	54.00	13.23

▪ Hopping Mode

Frequency (MHz)	ANT Pol	The worst case EUT Position (Axis)	Detector Mode	Reading (dBuV)	T.F (dB/m)	D.C.F. (dB)	Distance Factor (dB)	Result (dBuV/m)	Limit (dBuV/m)	Margin (dB)
2381.28	H	X	PK	46.80	-1.36	N/A	N/A	45.44	74.00	28.56
2381.04	H	X	AV	38.55	-1.36	N/A	N/A	37.19	54.00	16.81
2489.81	H	X	PK	49.25	-1.52	N/A	N/A	47.73	74.00	26.27
2490.00	H	X	AV	37.74	-1.52	N/A	N/A	36.22	54.00	17.78

Note.

- No other spurious and harmonic emissions were found greater than listed emissions on above table.
- The bandedge test has performed between 2310-2390MHz for low channel and 2483.5-2500MHz for high channel.
The worst results were reported in the table.
- Sample Calculation.
Margin = Limit – Result / Result = Reading + T.F + D.C.F. / T.F = AF + CL – AG
Where, T.F = Total Factor, AF = Antenna Factor, CL = Cable Loss, AG = Amplifier Gain,
- D.C.F Calculation. (D.C.F. = Duty Cycle Correction Factor)
 - Time to cycle through all channels= $\Delta t = T_{[ms]} \times 20$ minimum hopping channels , where T = pulse width
 - 100ms / $\Delta t_{[ms]} = H \rightarrow$ Round up to next highest integer, to account for worst case, H'
 - The Worst Case Dwell Time = $T_{[ms]} \times H'$
 - D.C.F = $20 \times \text{Log}(\text{The Worst Case Dwell Time} / 100\text{ms})\text{dB}$

2.4.2. Conducted Spurious Emissions

Low Band-edge

Lowest Channel & Modulation: GFSK

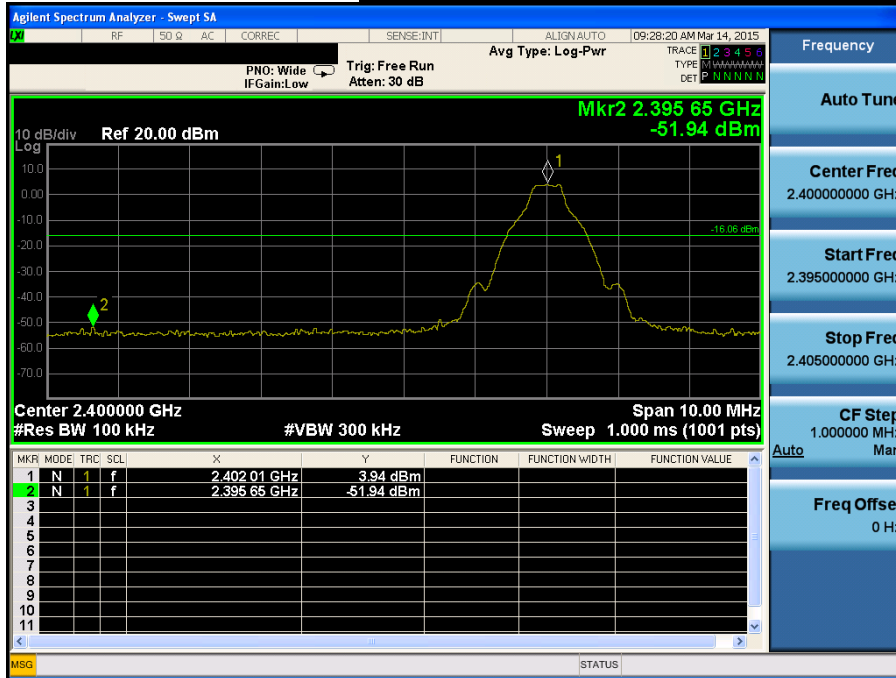

Low Band-edge

Hopping mode & Modulation: GFSK

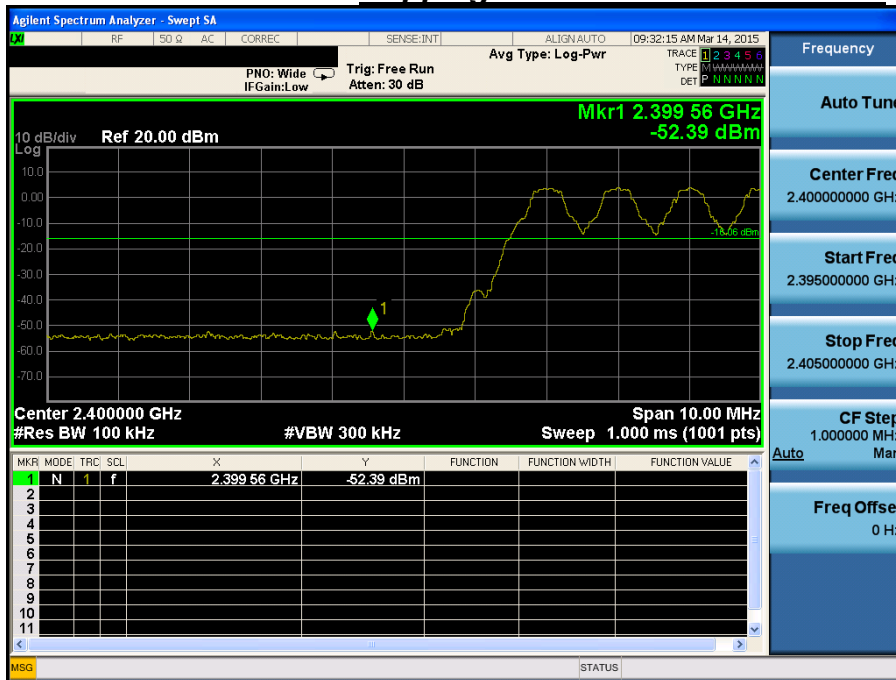

Conducted Spurious Emissions

Lowest Channel&Modulation: GFSK

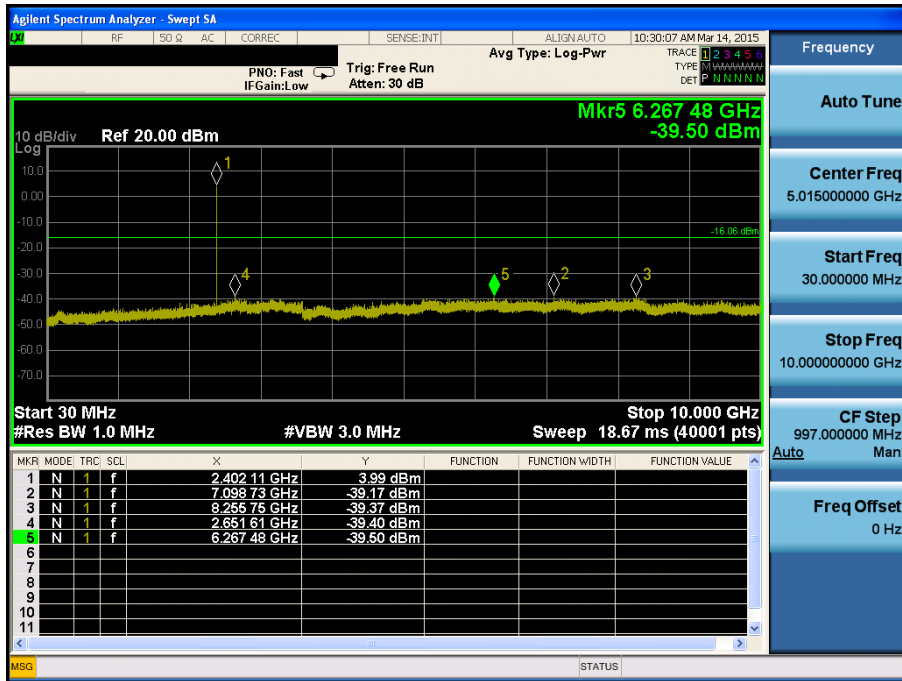
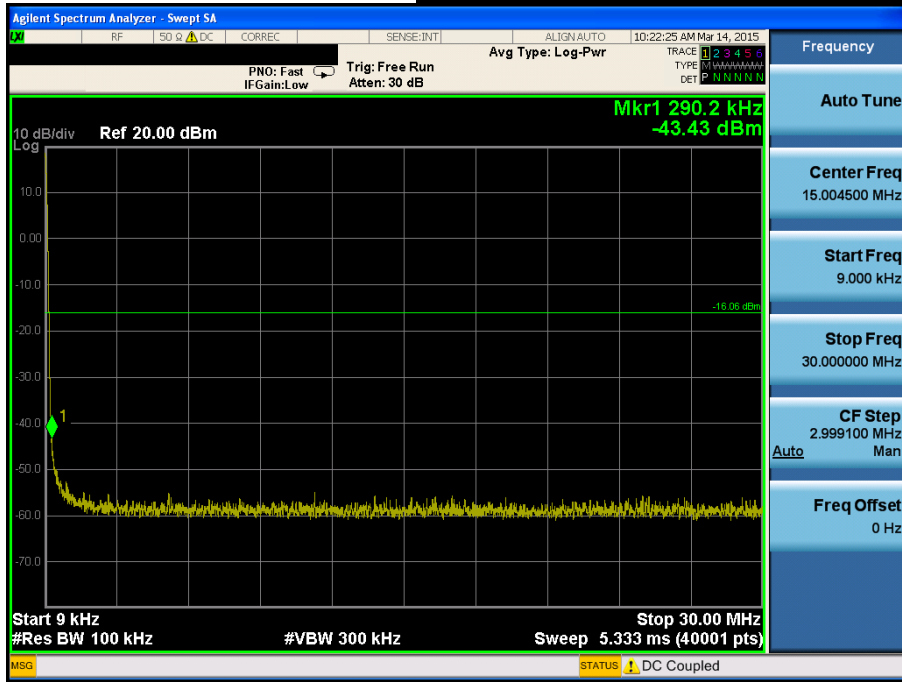

Conducted Spurious Emissions

Lowest Channel&Modulation: GFSK



Reference for limit

Middle Channel&Modulation: GFSK

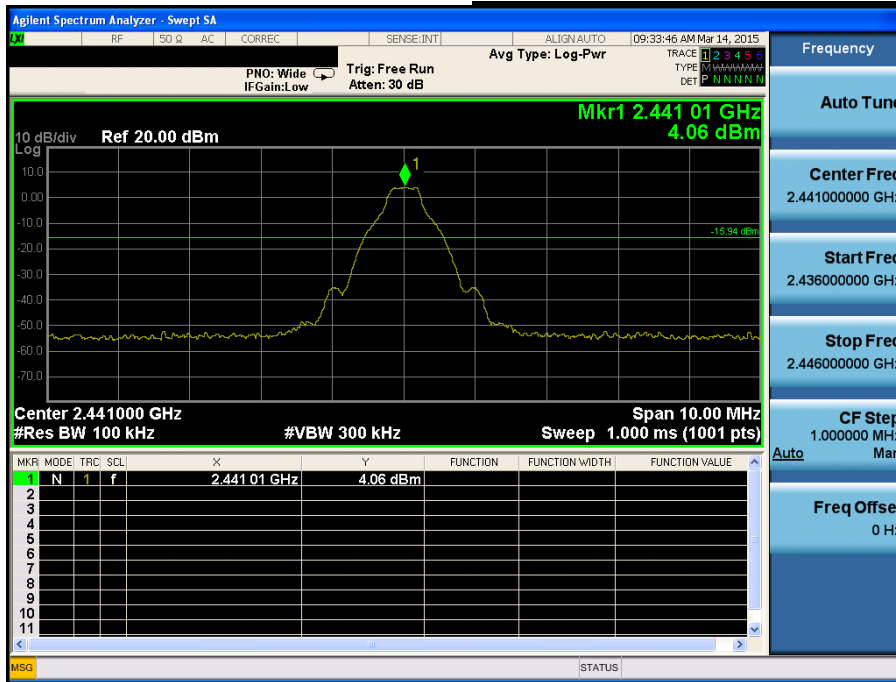

Conducted Spurious Emissions

Middle Channel&Modulation: GFSK

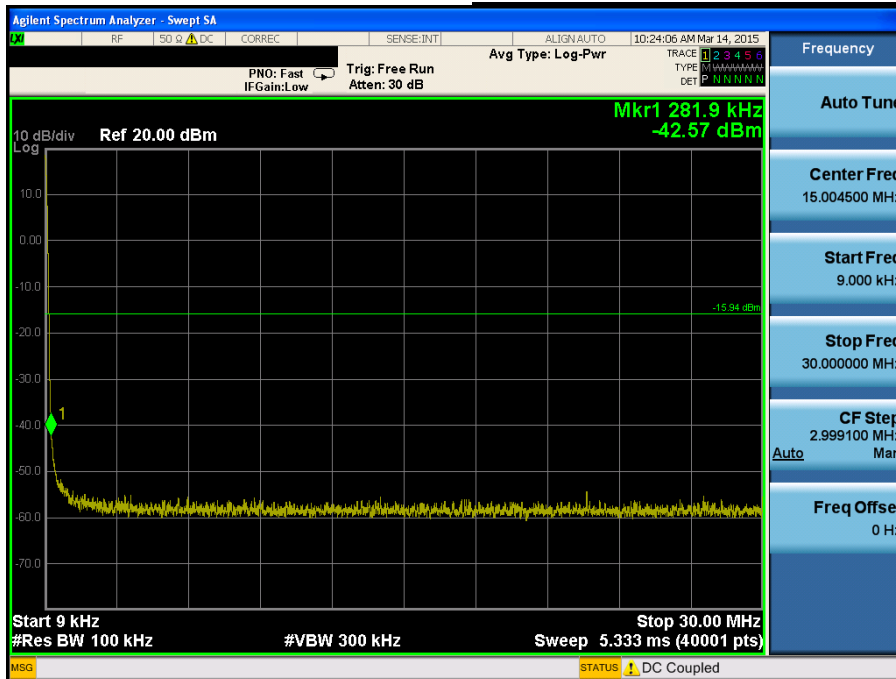

Conducted Spurious Emissions

Middle Channel&Modulation: GFSK

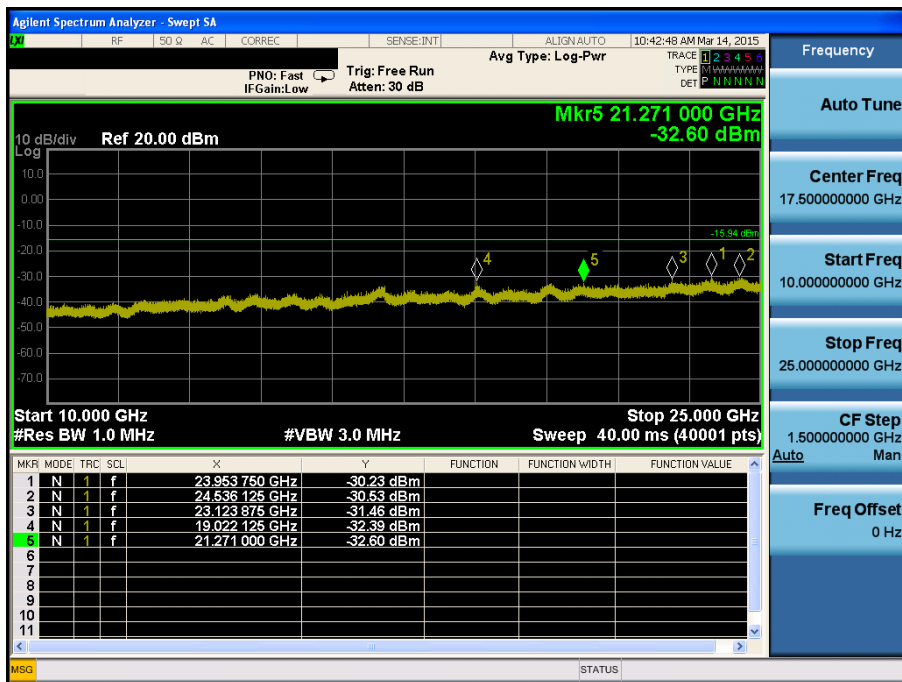
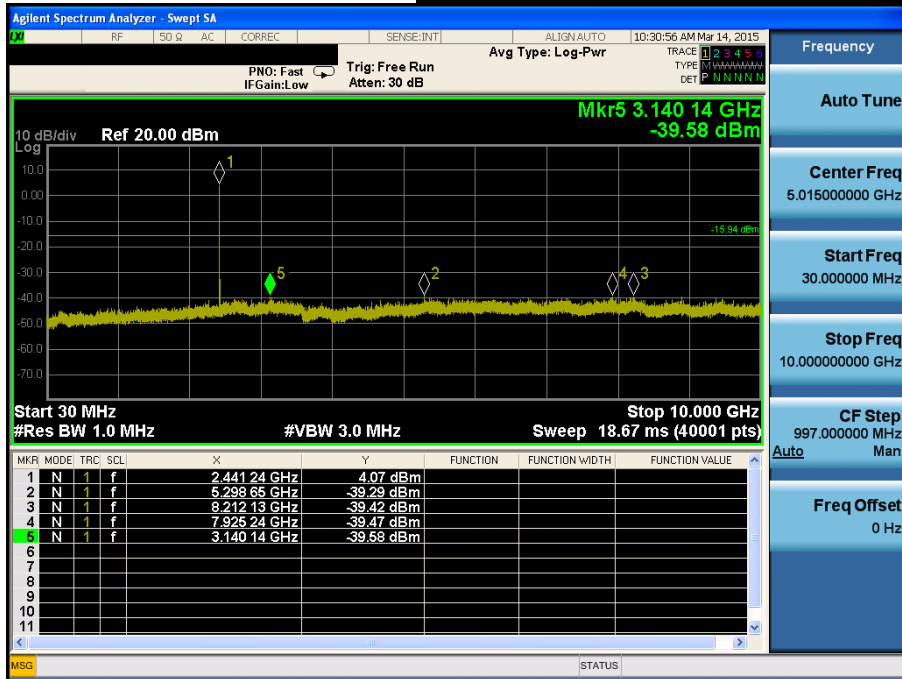

High Band-edge

Highest Channel&Modulation: GFSK

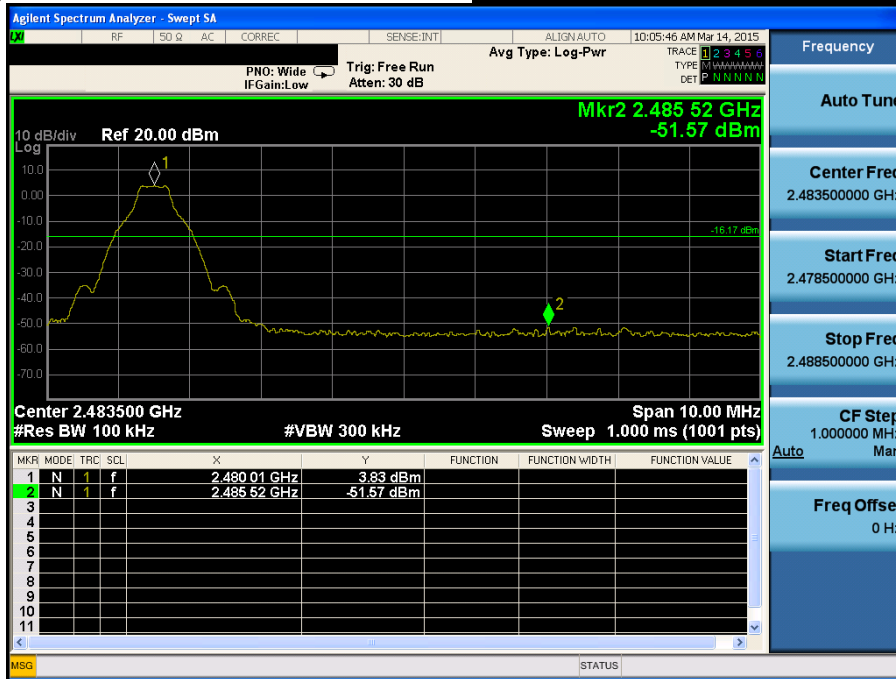

High Band-edge

Hopping mode&Modulation: GFSK

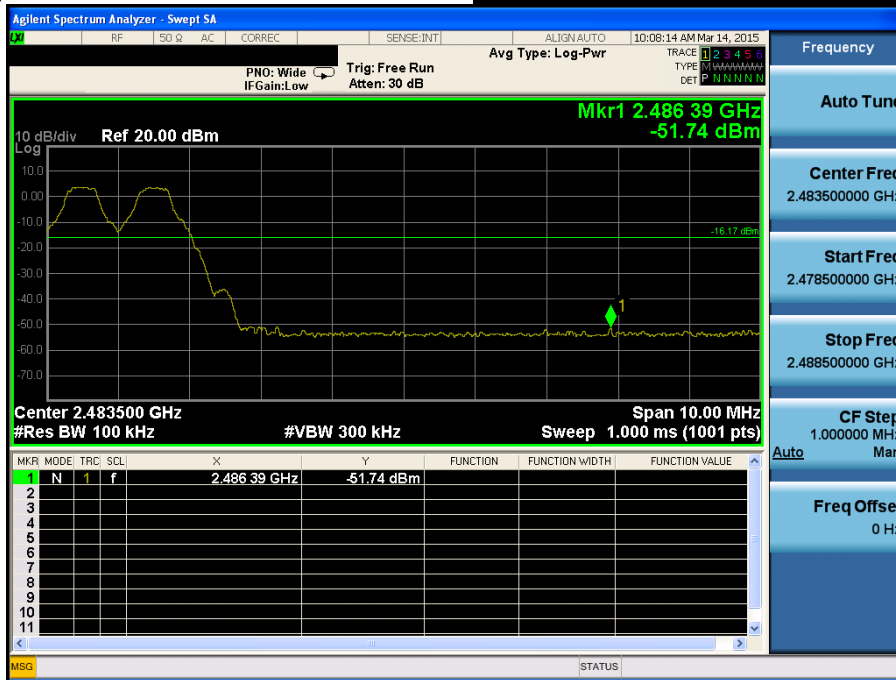

Conducted Spurious Emissions

Highest Channel & Modulation: GFSK

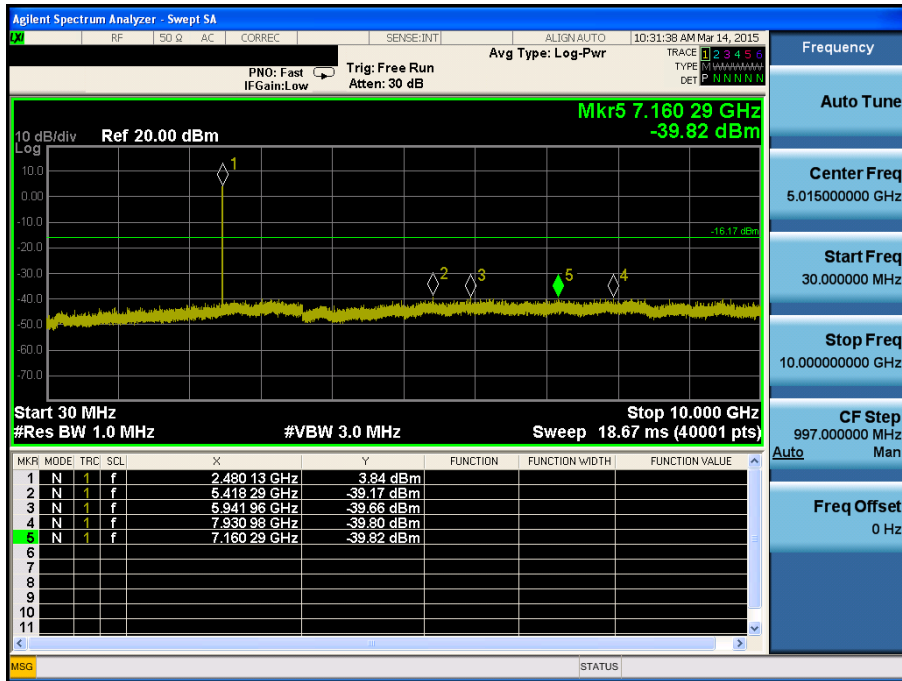
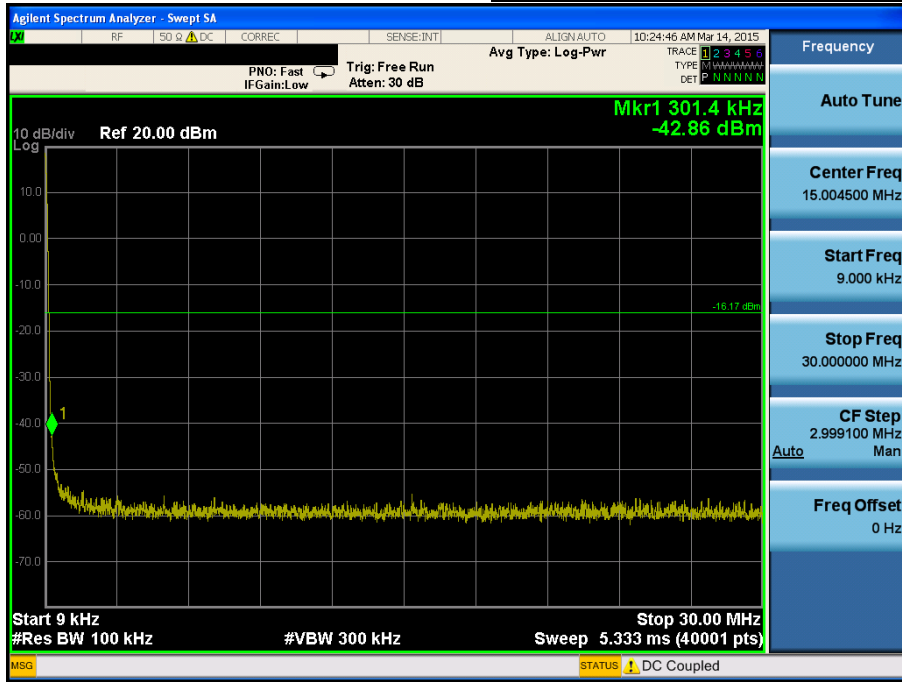

Conducted Spurious Emissions

Highest Channel&Modulation: GFSK

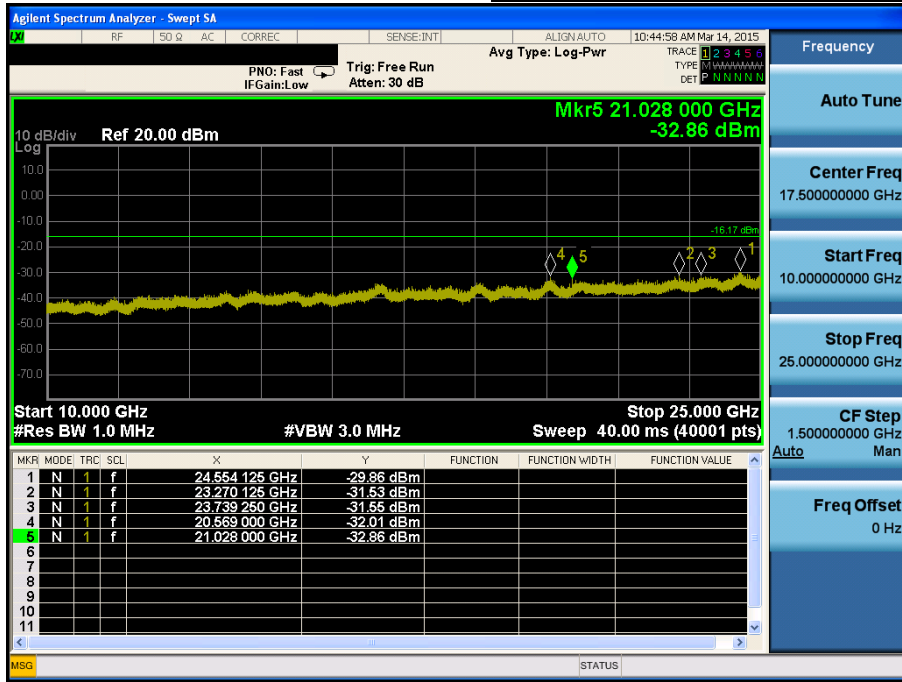

Low Band-edge

Lowest Channel&Modulation: $\pi/4$ QPSK

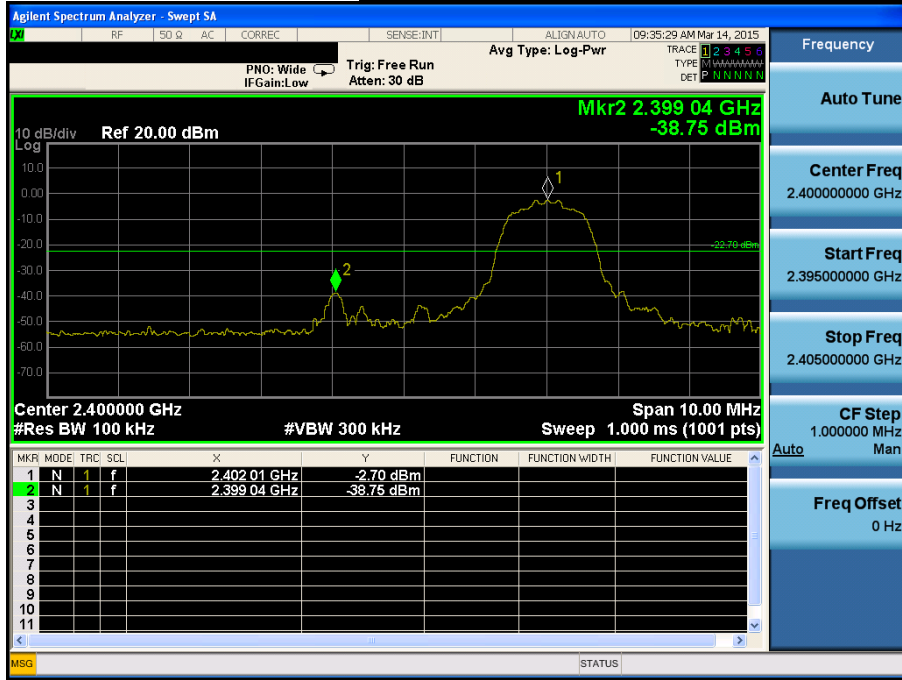

Low Band-edge

Hopping mode&Modulation: $\pi/4$ QPSK

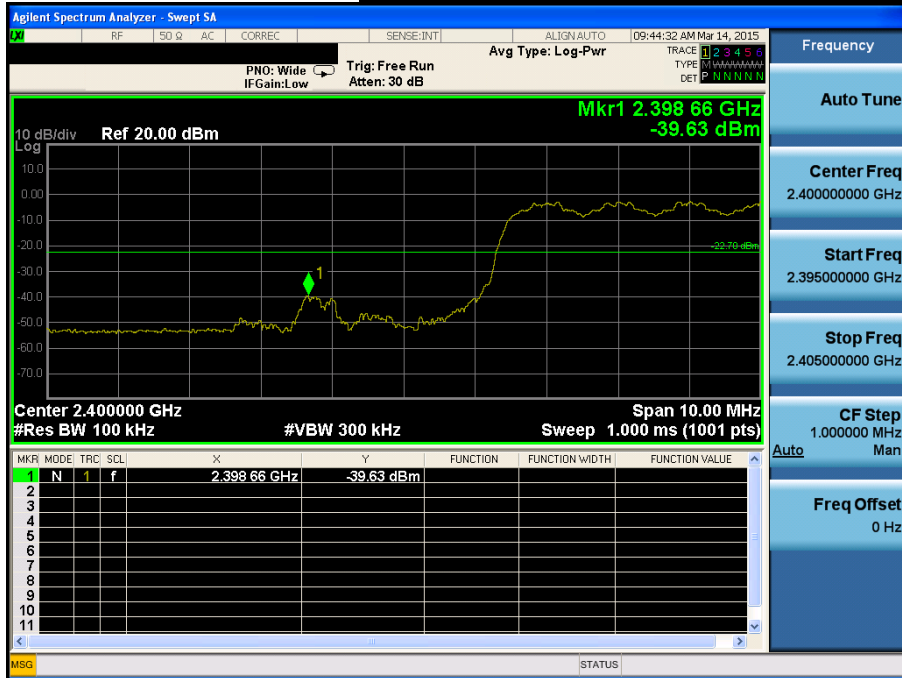

Conducted Spurious Emissions

Lowest Channel & Modulation: $\pi/4$ DQPSK

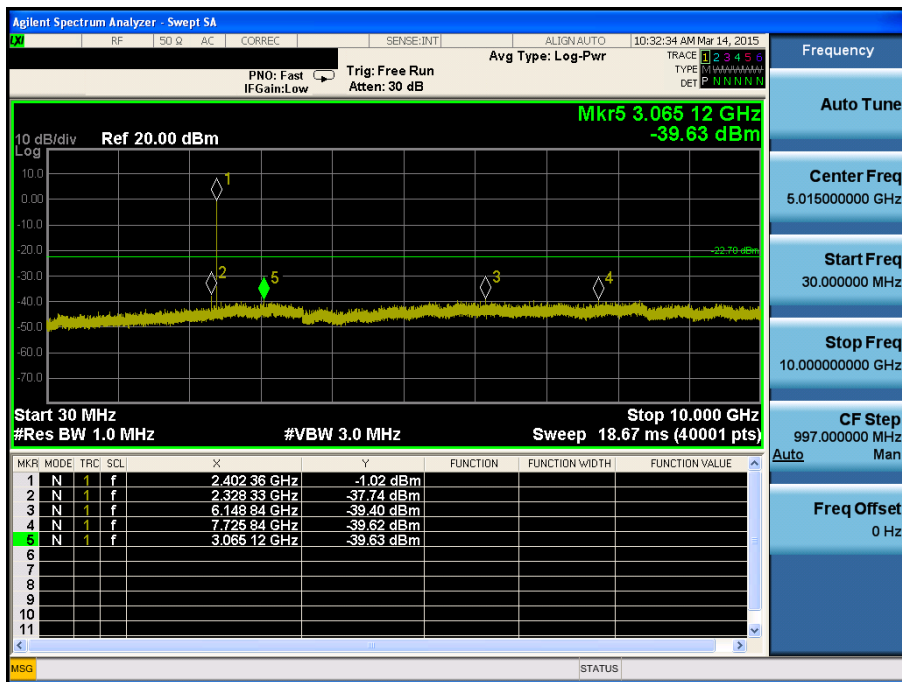
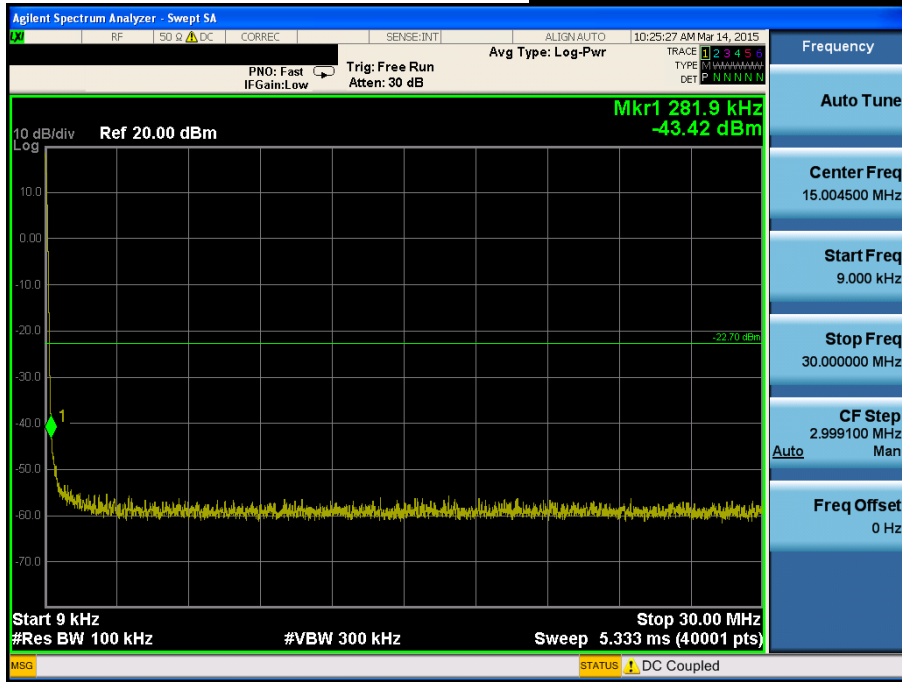

Reference for limit

Middle Channel&Modulation: $\pi/4$ DQPSK

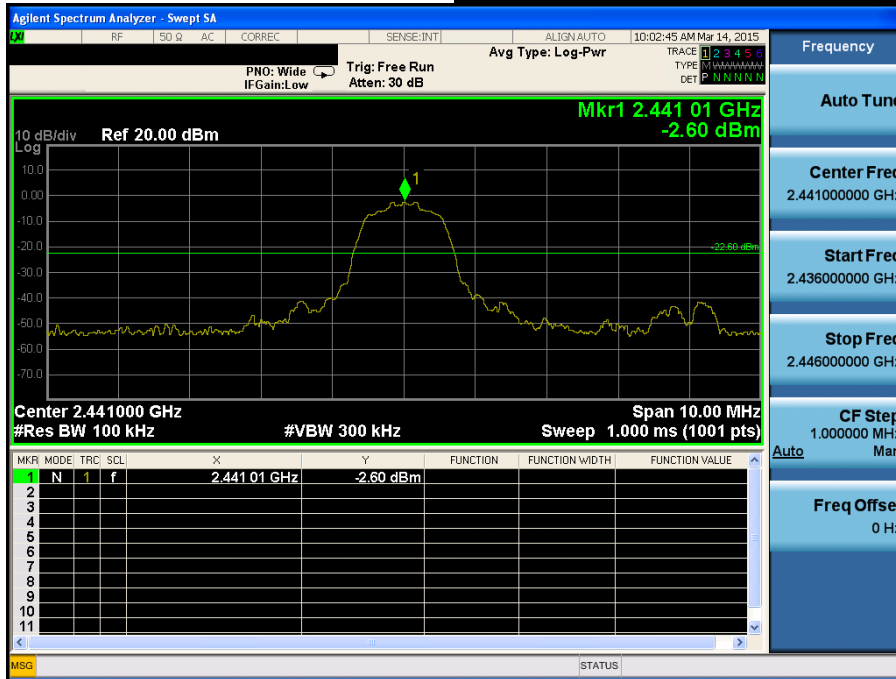

Conducted Spurious Emissions

Middle Channel&Modulation: $\pi/4$ DQPSK

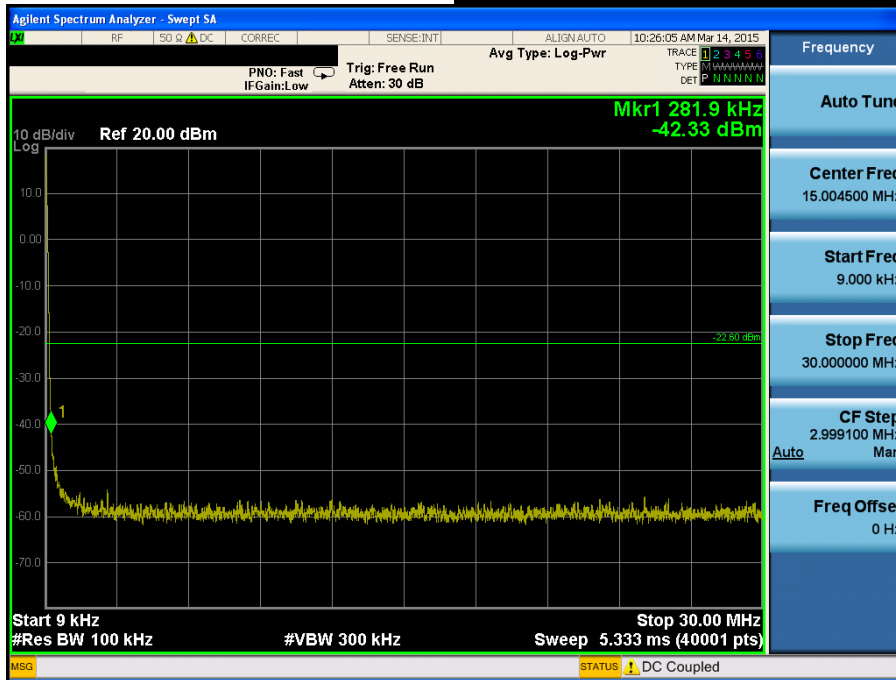

Conducted Spurious Emissions

Middle Channel & Modulation: $\pi/4$ DQPSK

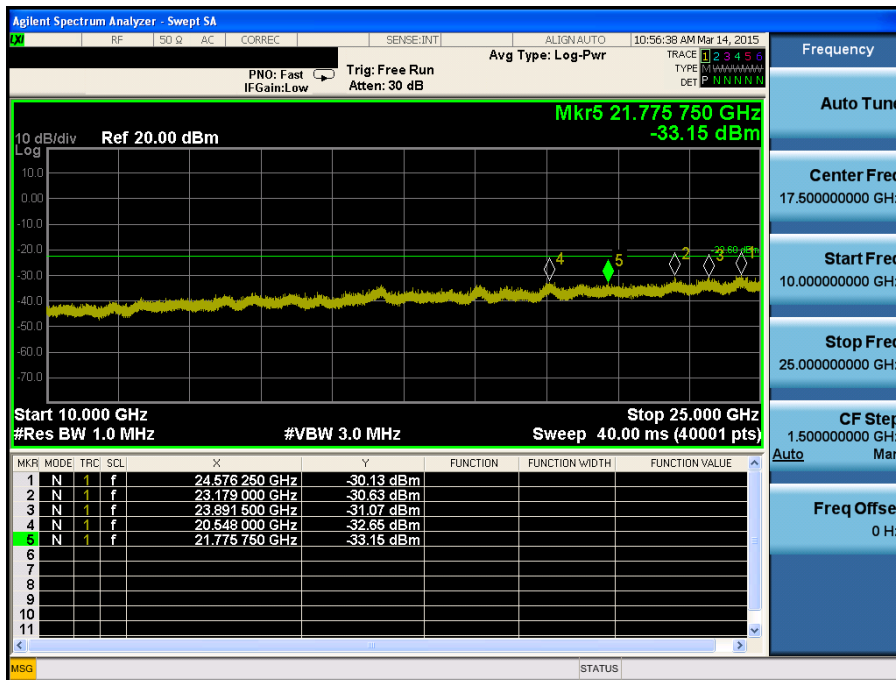
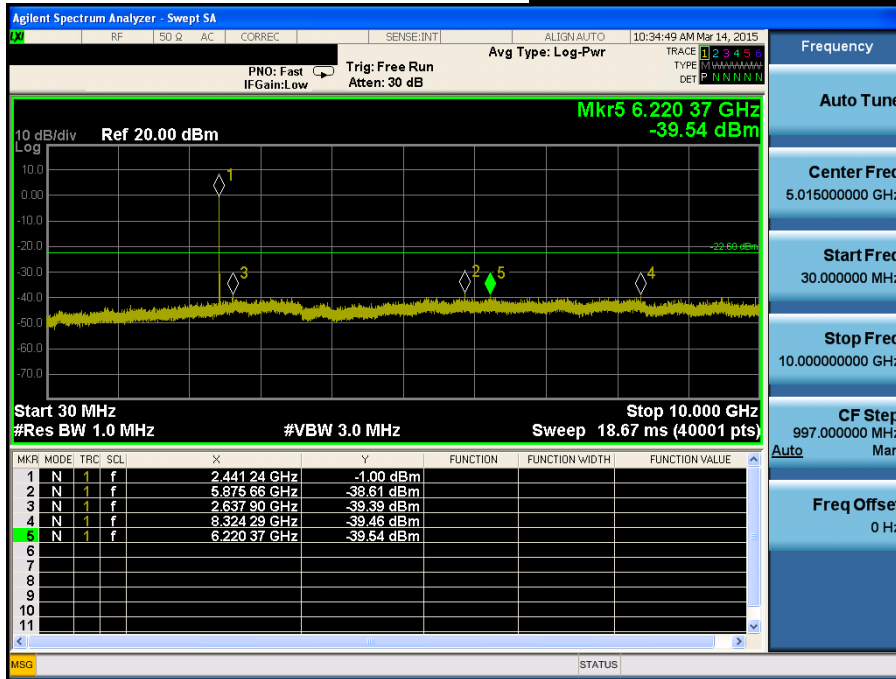

High Band-edge

Highest Channel&Modulation: $\pi/4$ DQPSK

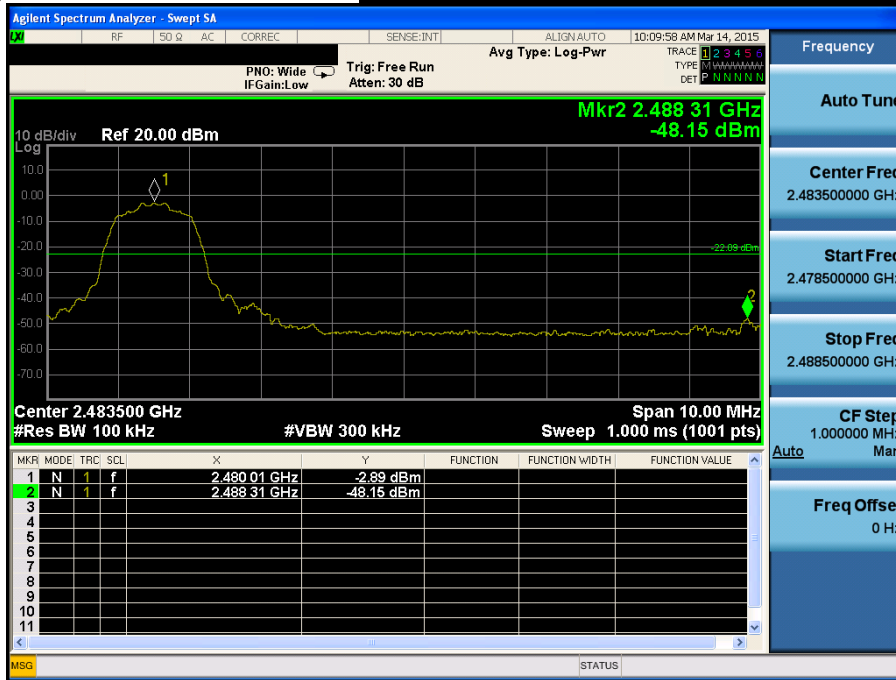

High Band-edge

Hopping mode&Modulation: $\pi/4$ DQPSK

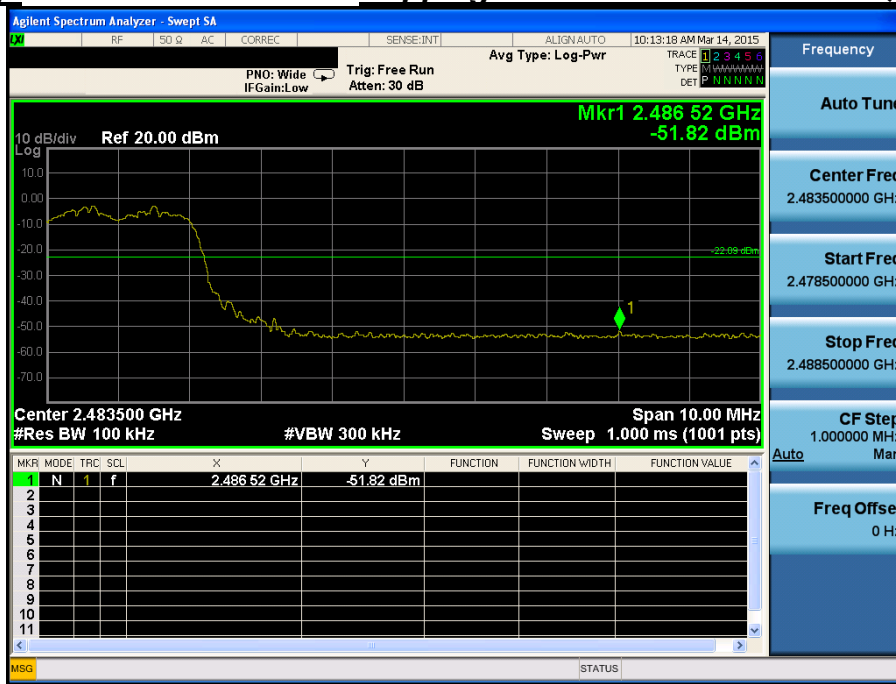

Conducted Spurious Emissions

Highest Channel & Modulation: $\pi/4$ DQPSK

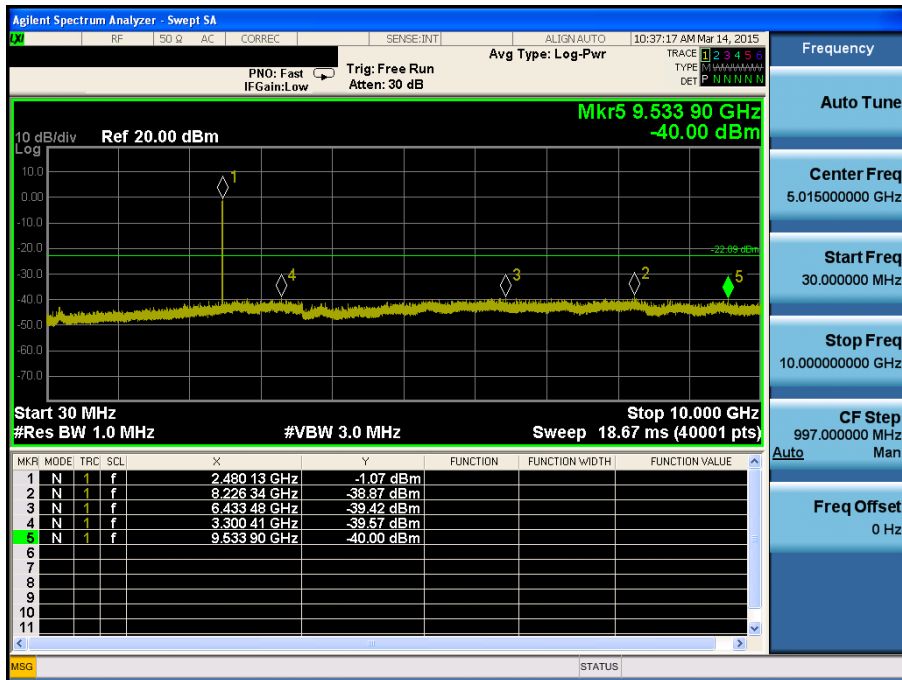
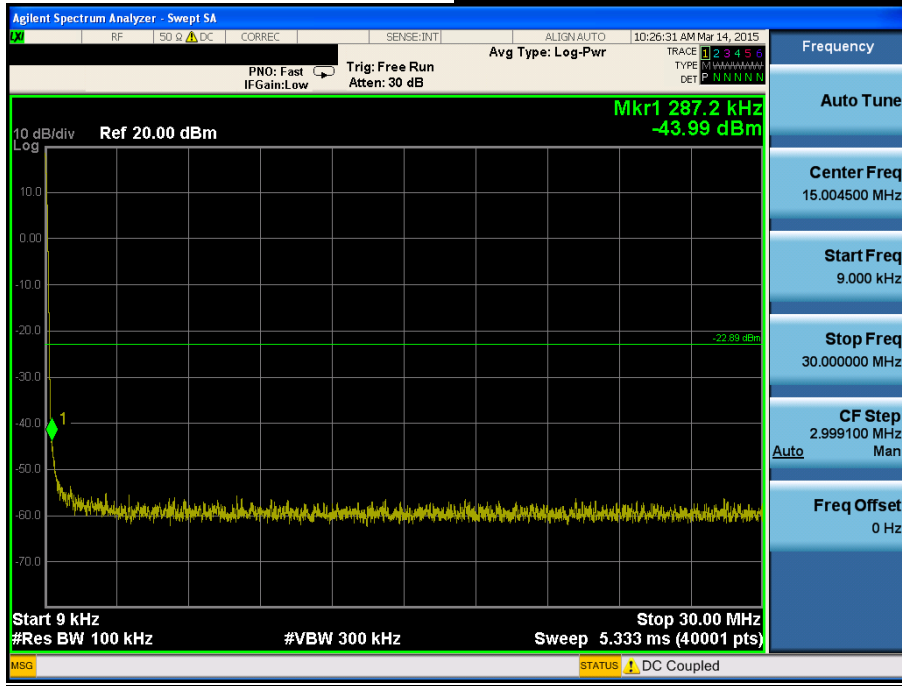

Low Band-edge

Lowest Channel&Modulation: 8DPSK

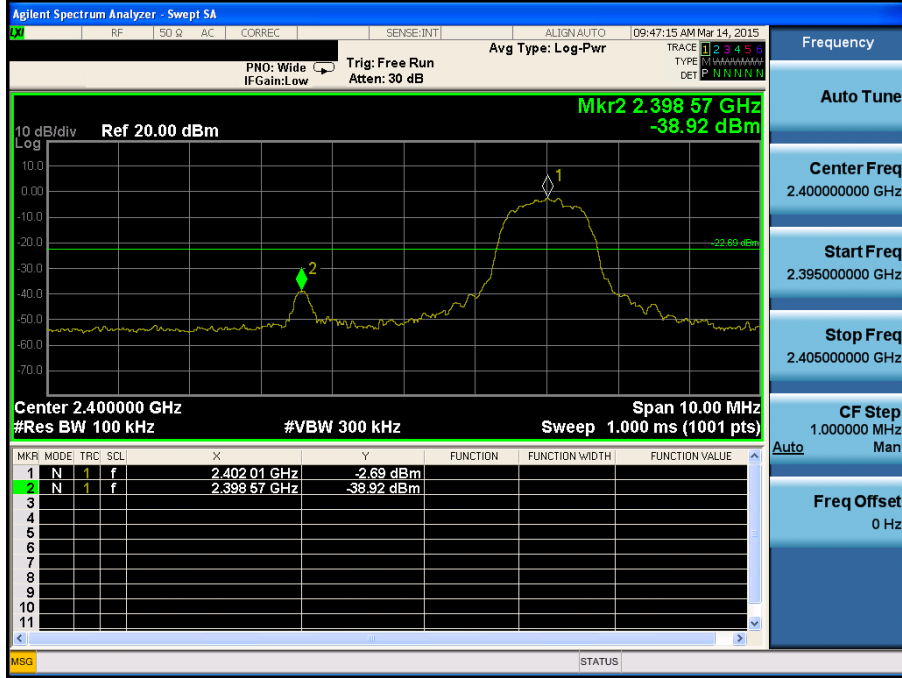

Low Band-edge

Hopping mode&Modulation: 8DPSK

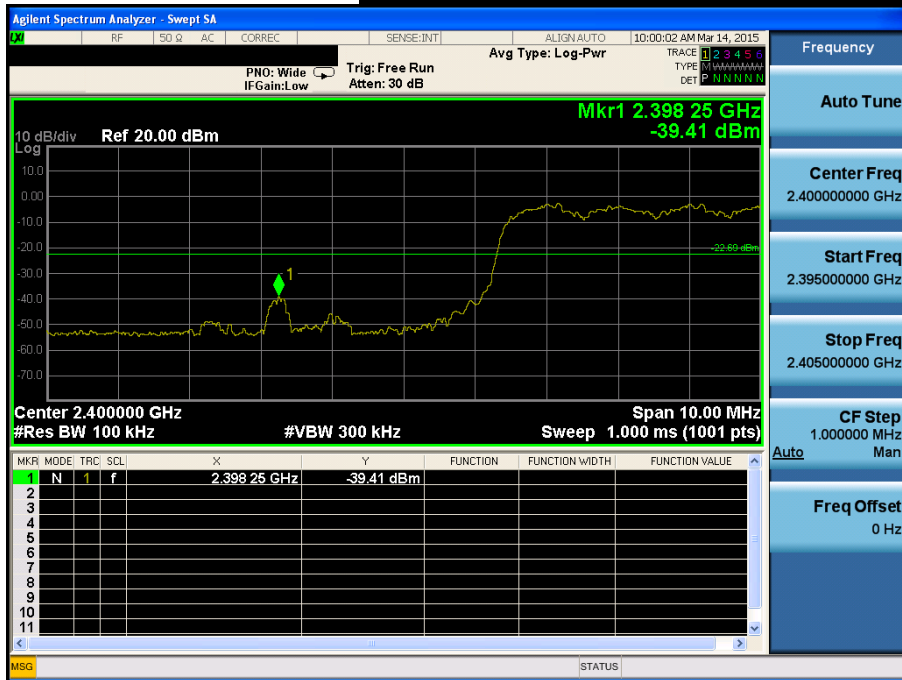

Conducted Spurious Emissions

Lowest Channel&Modulation: 8DPSK

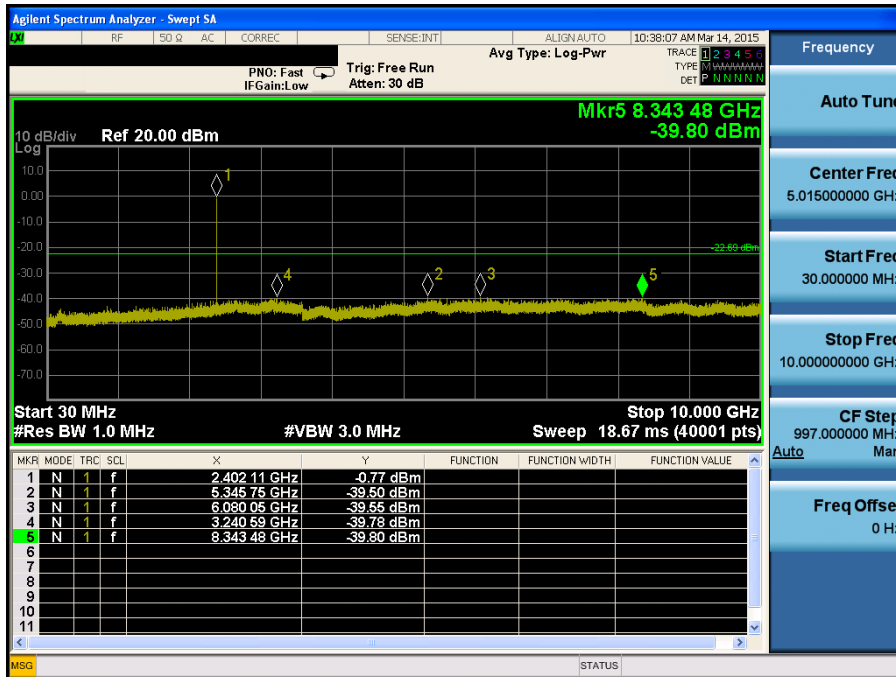
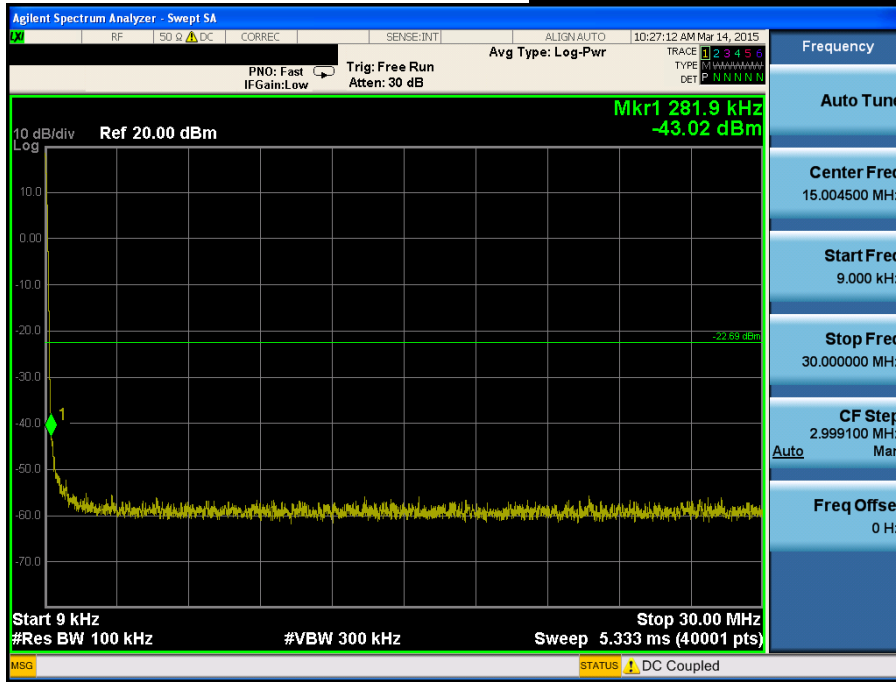

Conducted Spurious Emissions

Lowest Channel&Modulation: 8DPSK

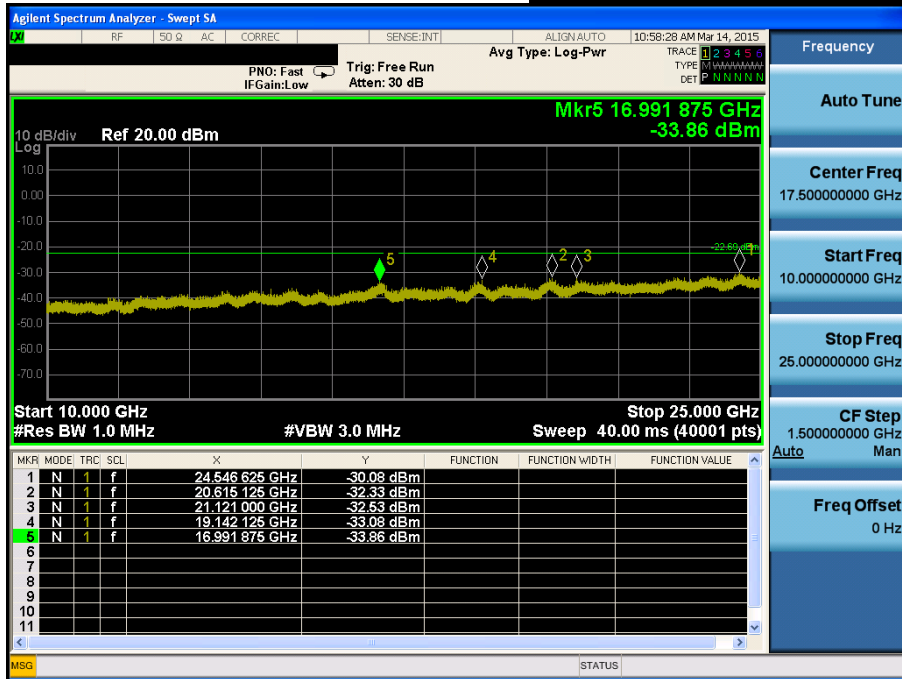

Reference for limit

Middle Channel&Modulation: 8DPSK

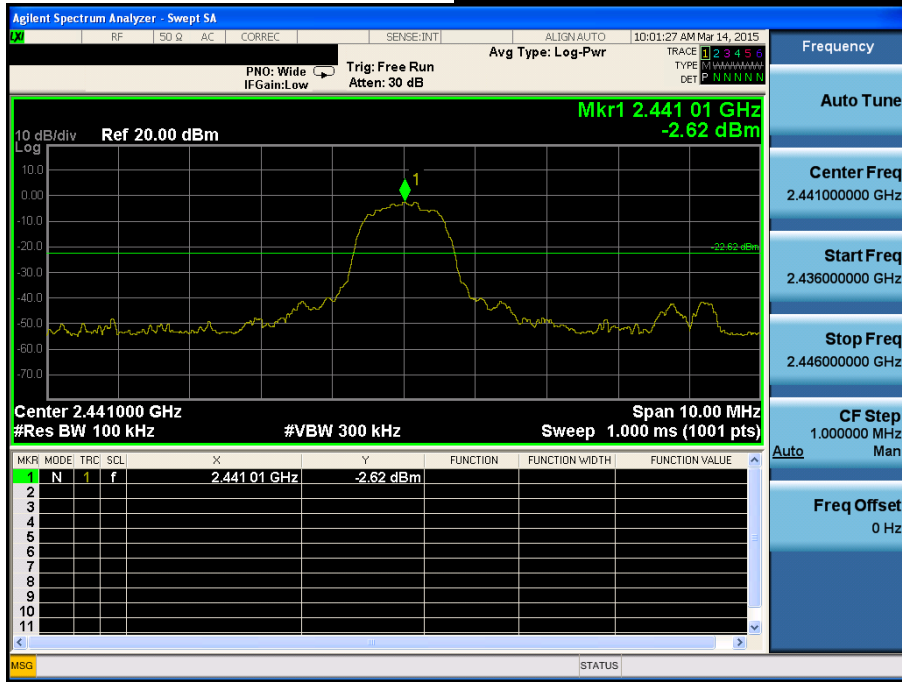

Conducted Spurious Emissions

Middle Channel&Modulation: 8DPSK

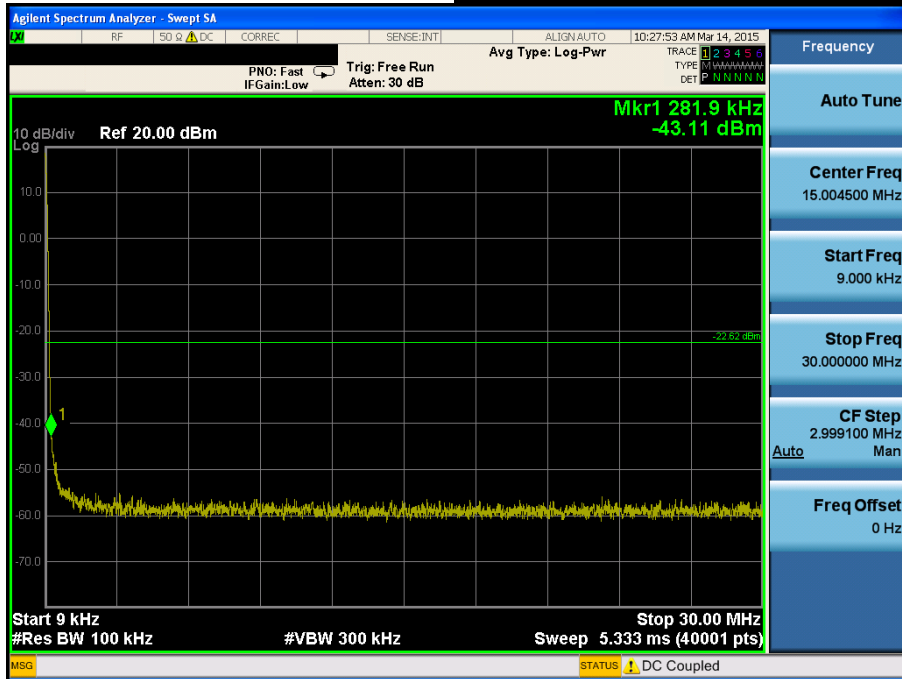

Conducted Spurious Emissions

Middle Channel&Modulation: 8DPSK

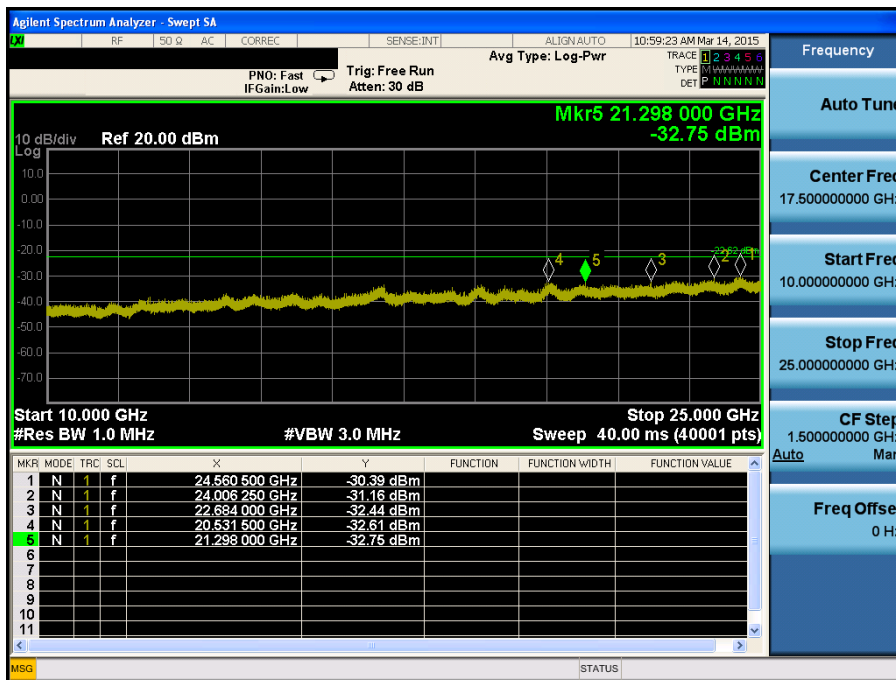
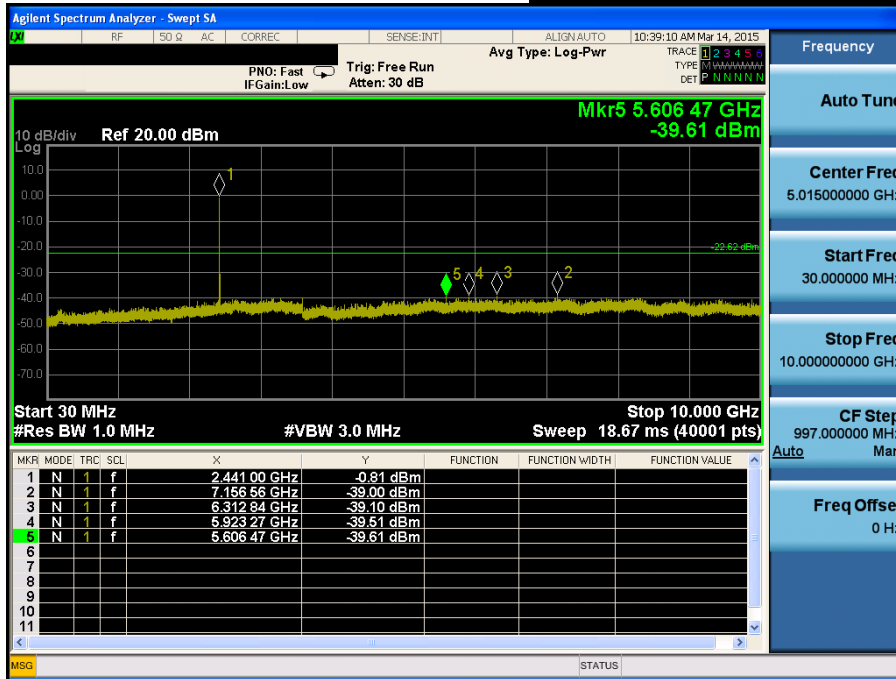

High Band-edge

Highest Channel&Modulation: 8DPSK

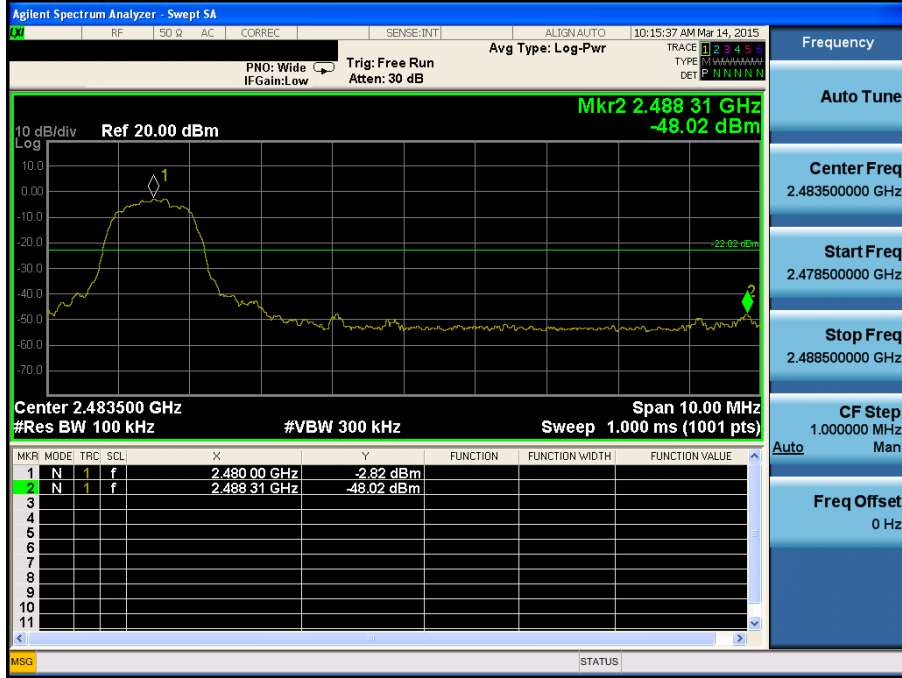

High Band-edge

Hopping mode&Modulation: 8DPSK

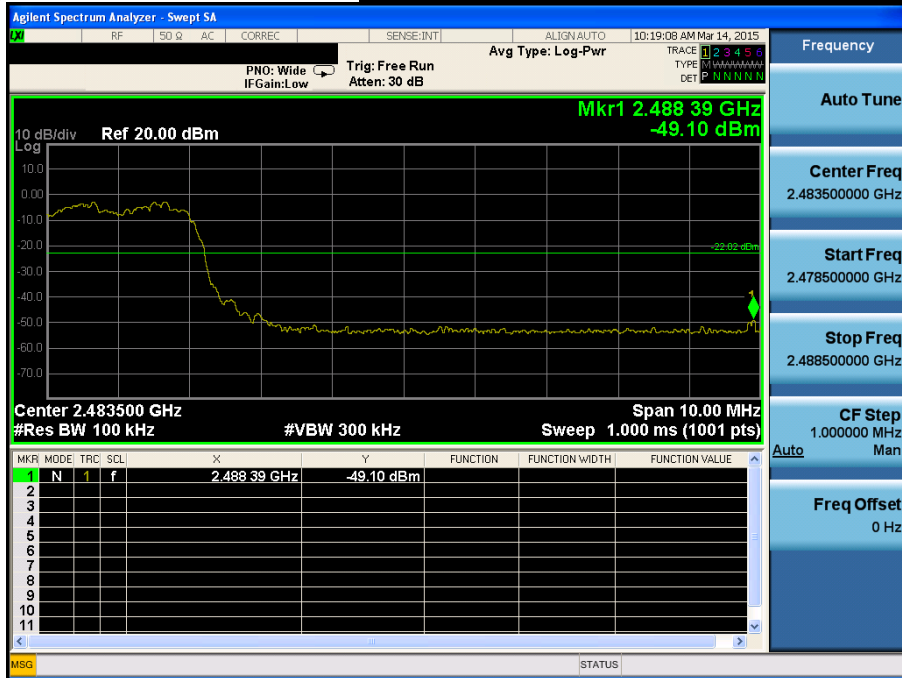

Conducted Spurious Emissions

Highest Channel & Modulation: 8DPSK

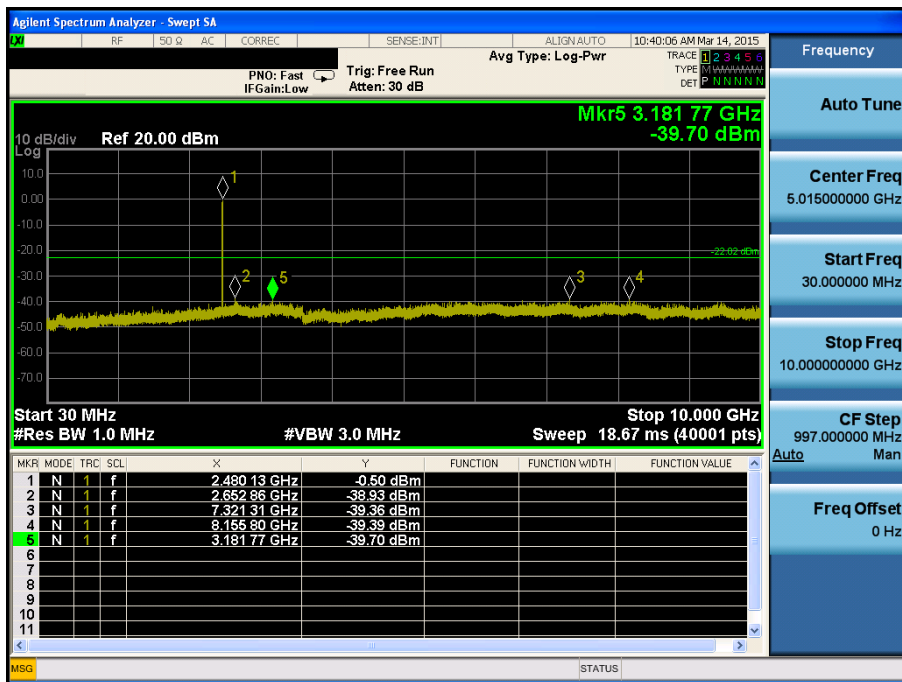
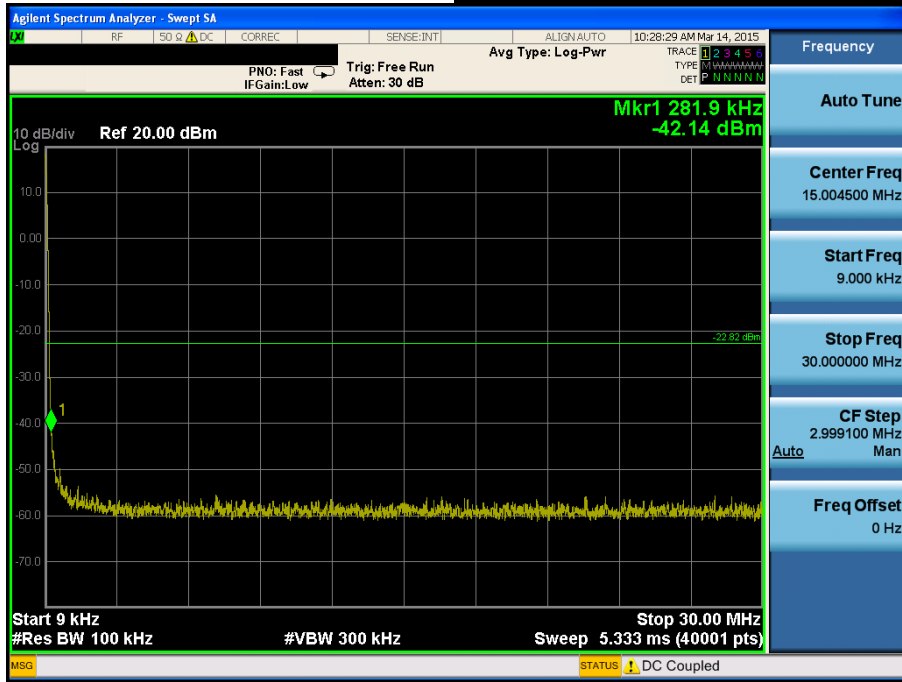

Conducted Spurious Emissions

Highest Channel & Modulation: 8DPSK

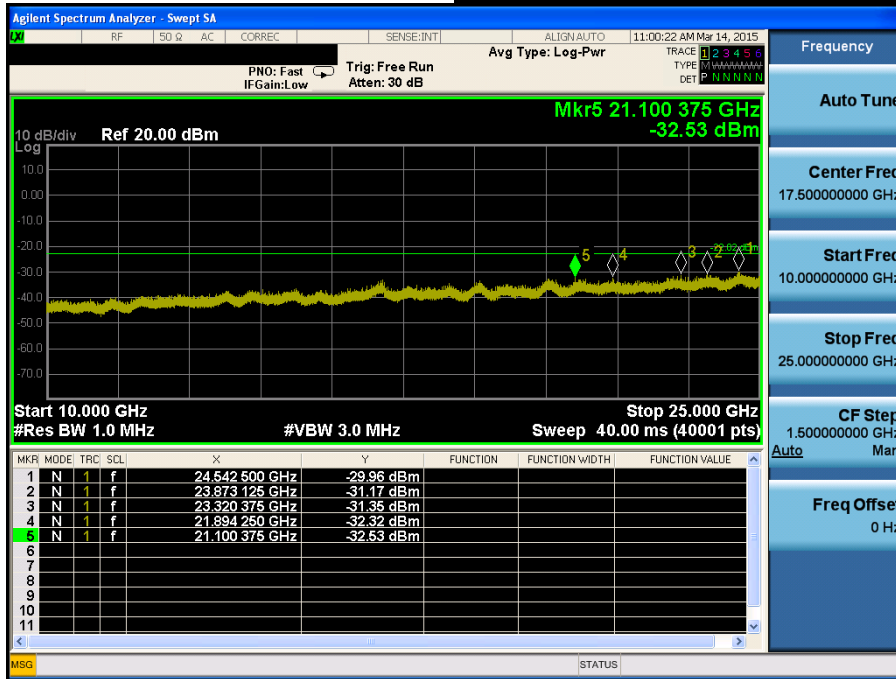

3. Carrier Frequency Separation

3.1. Test Setup

Refer to the APPENDIX I.

3.2. Limit

Limit: $\geq 20\text{dB BW}$ or $\geq \text{Two-Thirds of the } 20\text{dB BW}$

- Procedure:

The carrier frequency separation was measured with a spectrum analyzer connected to the antenna terminal, while EUT had its hopping function enabled.

After the trace being stable, the reading value between the peaks of the adjacent channels using the marker-delta function was recorded as the measurement results.

The spectrum analyzer is set to:

Span = wide enough to capture the peaks of two adjacent channels

RBW = 1% of the span

Sweep = auto

VBW = \geq RBW

Detector function = peak

Trace = max hold

- Measurement Data: **Comply**

- FH mode

Hopping Mode	Test Mode	Peak of adjacent Channel (MHz)	Peak of center channel (MHz)	Test Result (MHz)
Enable	GFSK	2441.009	2442.014	1.005
	$\pi/4$ -DQPSK	2440.997	2441.999	1.002
	8DPSK	2440.997	2441.999	1.002

- AFH mode

Hopping Mode	Test Mode	Peak of adjacent Channel (MHz)	Peak of center channel (MHz)	Test Result (MHz)
Enable	GFSK	2410.013	2411.015	1.002
	$\pi/4$ -DQPSK	2411.000	2412.002	1.002
	8DPSK	2411.162	2412.164	1.002

Note 1: See next pages for actual measured spectrum plots.

- Minimum Standard:

Frequency hopping systems shall have hopping channel carrier frequencies separated by a minimum of 25 kHz or the 20 dB bandwidth of the hopping channel, whichever is greater.
 Alternatively, frequency hopping systems operating in the 2400-2483.5 MHz band may have hopping channel carrier frequencies that are separated by 25 kHz or two-thirds of the 20 dB bandwidth of the hopping channel, whichever is greater, provided the systems operate with an output power no greater than 125 mW

Carrier Frequency Separation (FH)

Hopping mode: Enable&GFSK

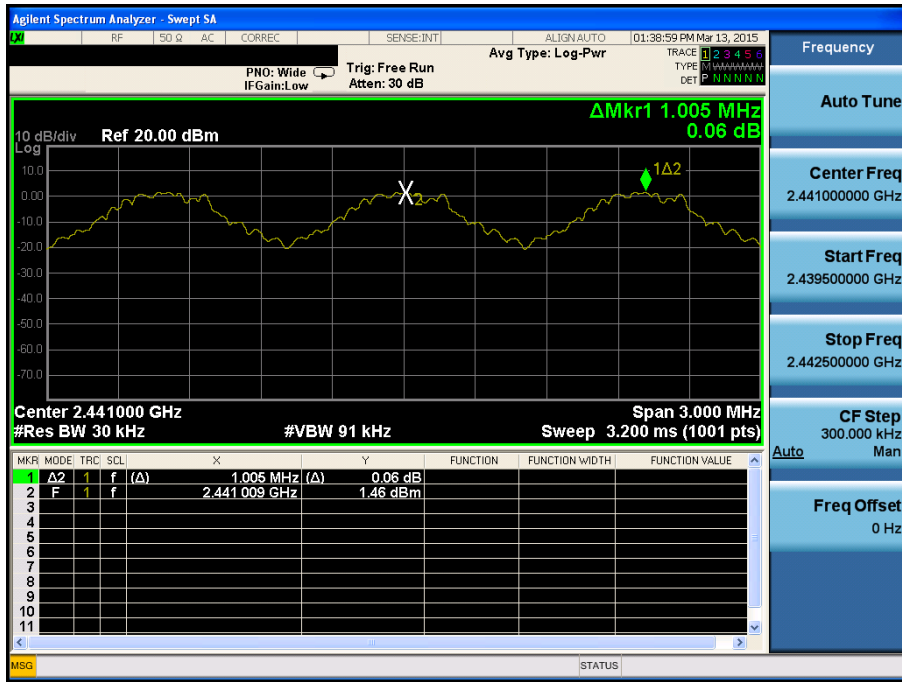

Carrier Frequency Separation (FH)

Hopping mode: Enable& $\pi/4$ -DQPSK

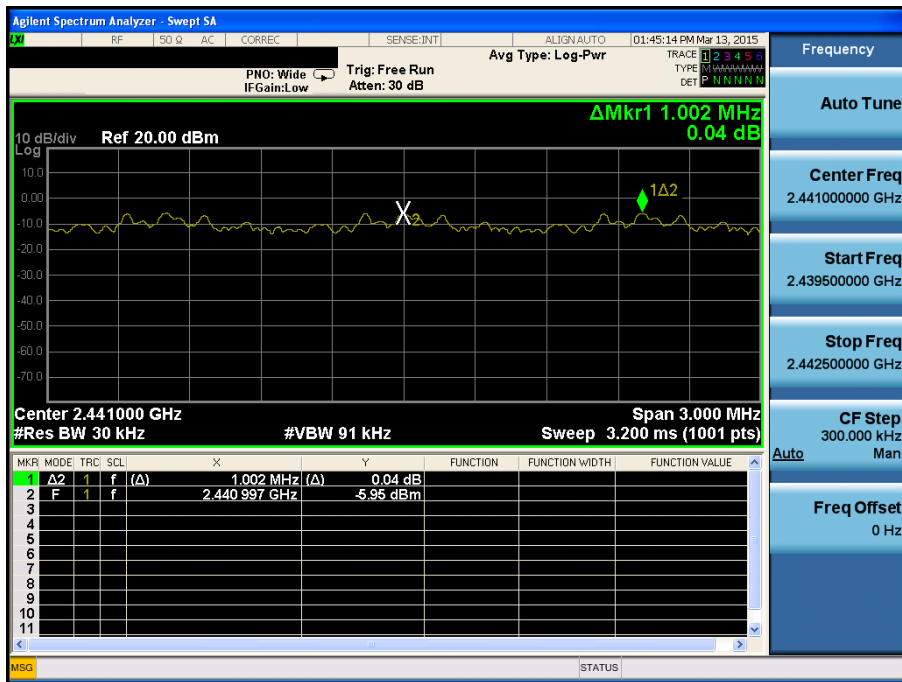

Carrier Frequency Separation (FH)

Hopping mode: Enable&8DPSK

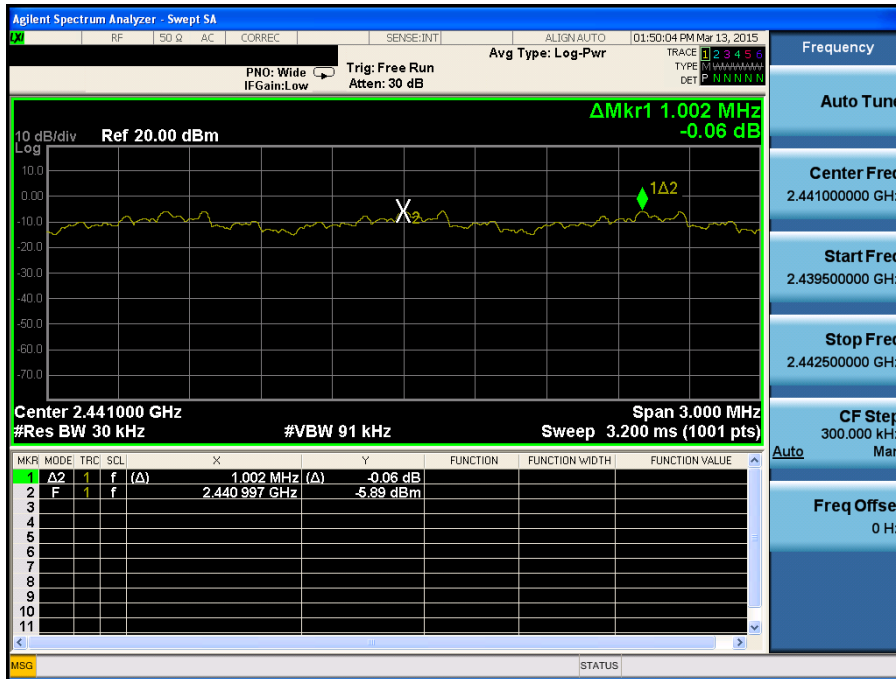

Carrier Frequency Separation (AFH)

Hopping mode: Enable&GFSK

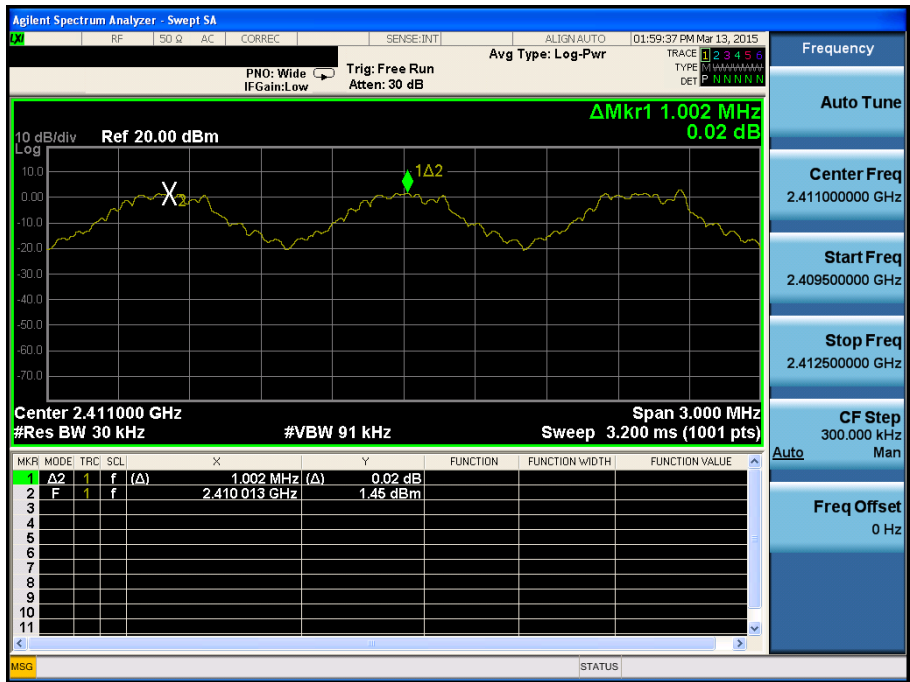

Carrier Frequency Separation (AFH)

Hopping mode: Enable& $\pi/4$ -DQPSK

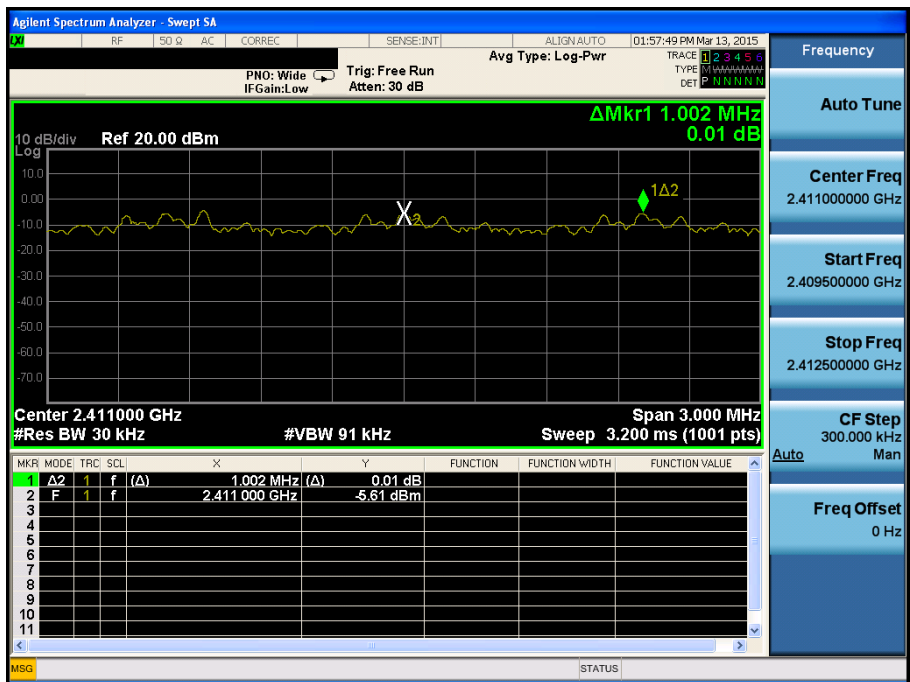

Carrier Frequency Separation (AFH)

Hopping mode: Enable&8DPSK

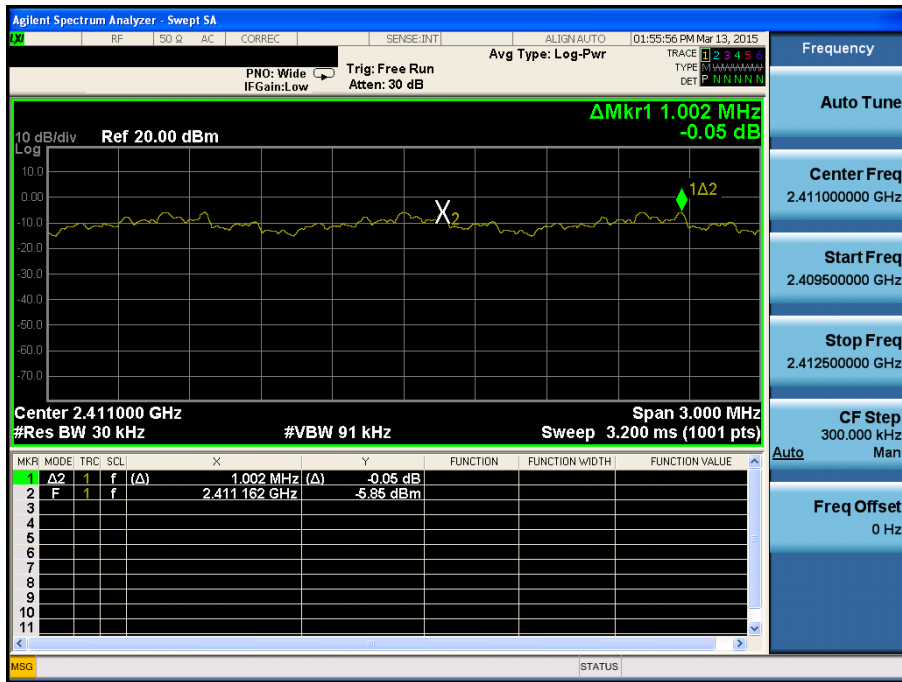

4. Number of Hopping Frequencies

4.1. Test Setup

Refer to the APPENDIX I.

4.2. Limit

Limit: ≥ 15 hops

- Procedure:

The number of hopping frequencies was measured with a spectrum analyzer connected to the antenna terminal, while EUT had its hopping function enabled.

To get higher resolution, two frequency ranges for FH mode within the 2400 ~ 2483.5 MHz were examined.

The spectrum analyzer is set to:

Span = 50MHz Plot 1: Start Frequency = 2391.5MHz, Stop Frequency = 2441.5 MHz

Plot 2: Start Frequency = 2441.5MHz, Stop Frequency = 2491.5 MHz

RBW = 1% of the span or more

Sweep = auto

VBW = \geq RBW

Detector function = peak

Trace = max hold

- Measurement Data: **Comply**

- FH mode

Hopping mode	Test mode	Test Result (Total Hops)
Enable	GFSK	79
	$\pi/4$ -DQPSK	79
	8DPSK	79

- AFH mode

Hopping mode	Test mode	Test Result (Total Hops)
Enable	GFSK	20
	$\pi/4$ -DQPSK	20
	8DPSK	20

Note 1: See next pages for actual measured spectrum plots.

- Minimum Standard:

At least 15 hops

Number of Hopping Frequencies 1(FH)

Hopping mode: Enable & GFSK

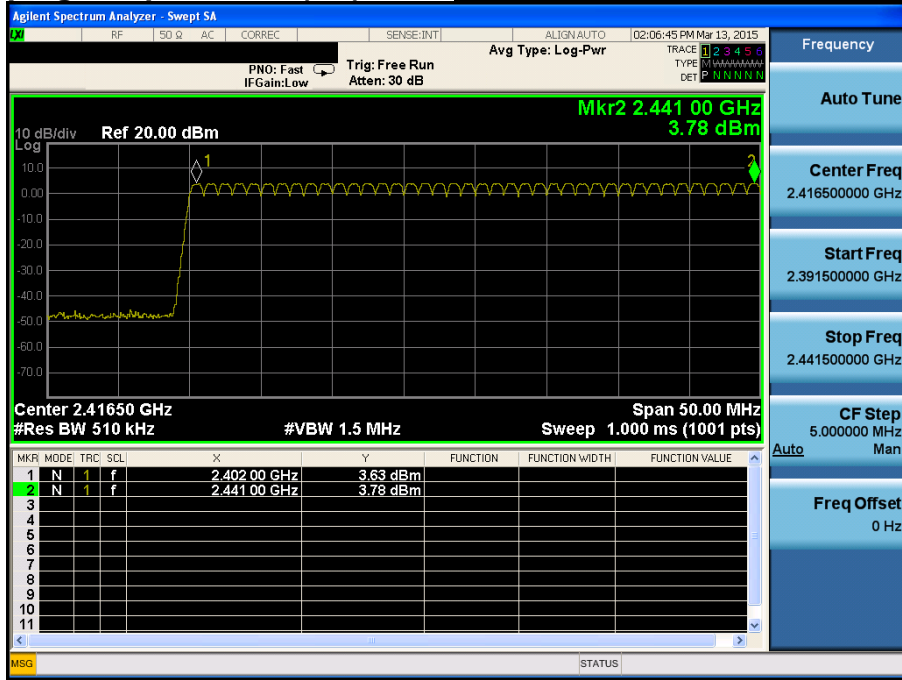

Number of Hopping Frequencies 2(FH)

Hopping mode: Enable & GFSK

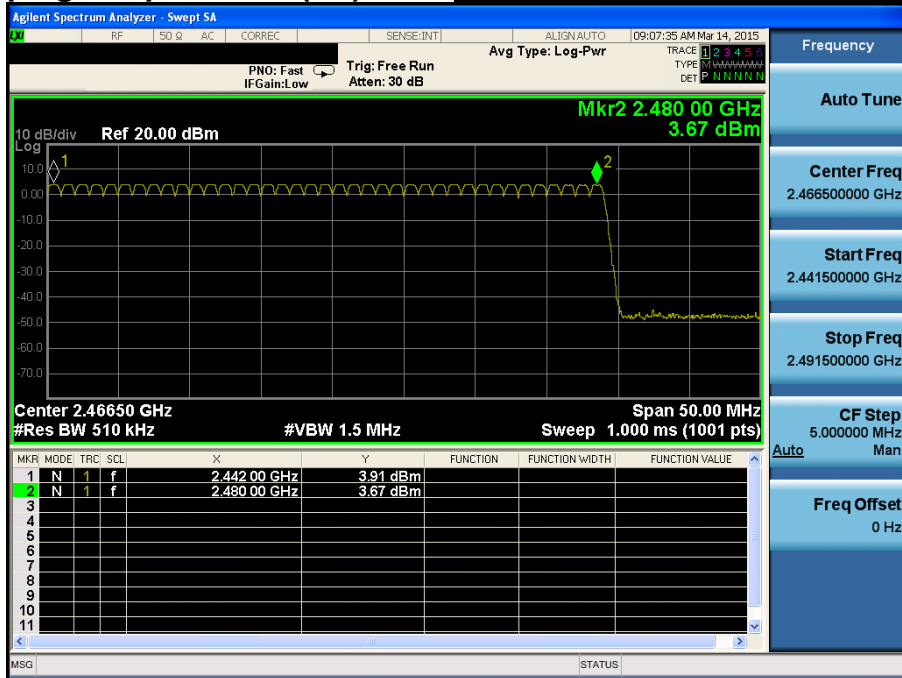

Number of Hopping Frequencies 1(FH)

Hopping mode: Enable & $\pi/4$ -DQPSK

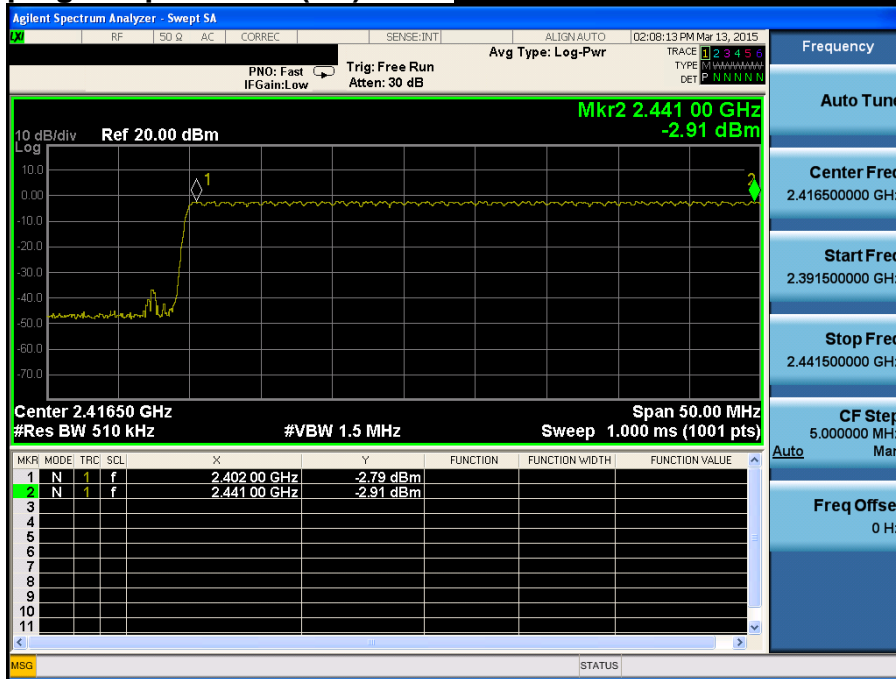

Number of Hopping Frequencies 2(FH)

Hopping mode: Enable & $\pi/4$ -DQPSK

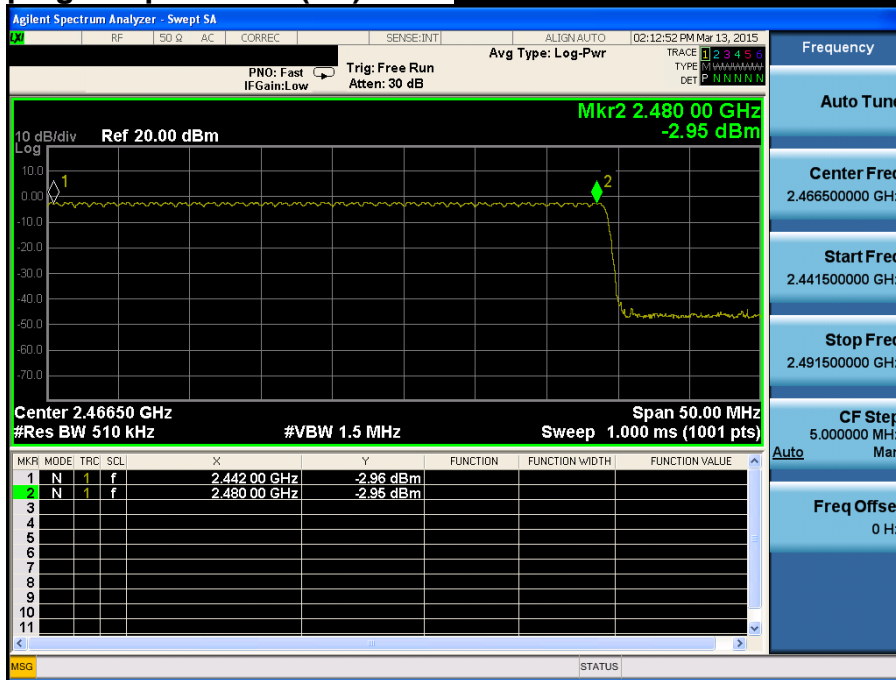

Number of Hopping Frequencies 1(FH)

Hopping mode: Enable&8DPSK

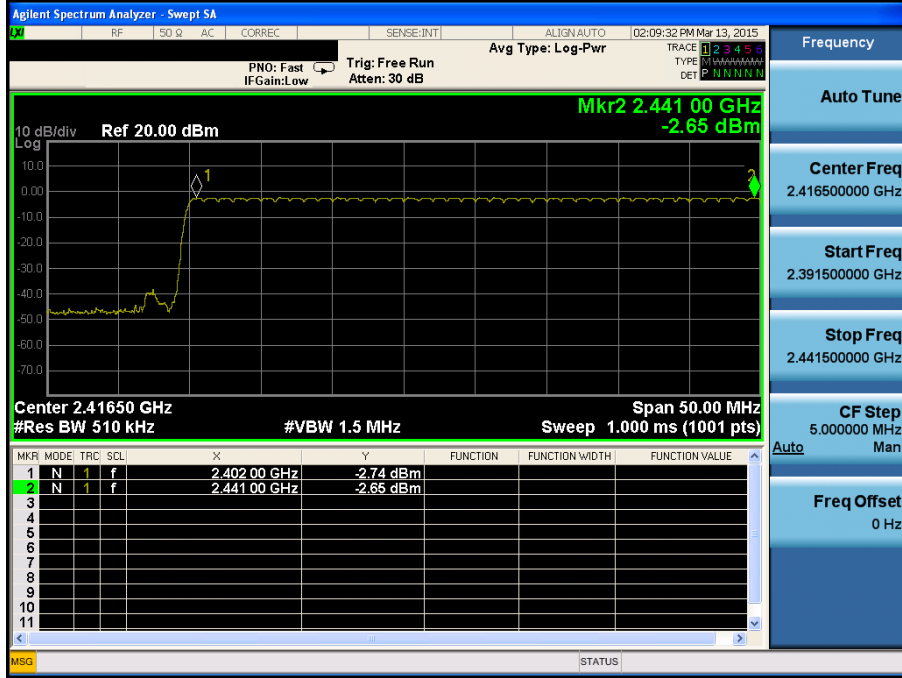

Number of Hopping Frequencies 2(FH)

Hopping mode: Enable & 8DPSK

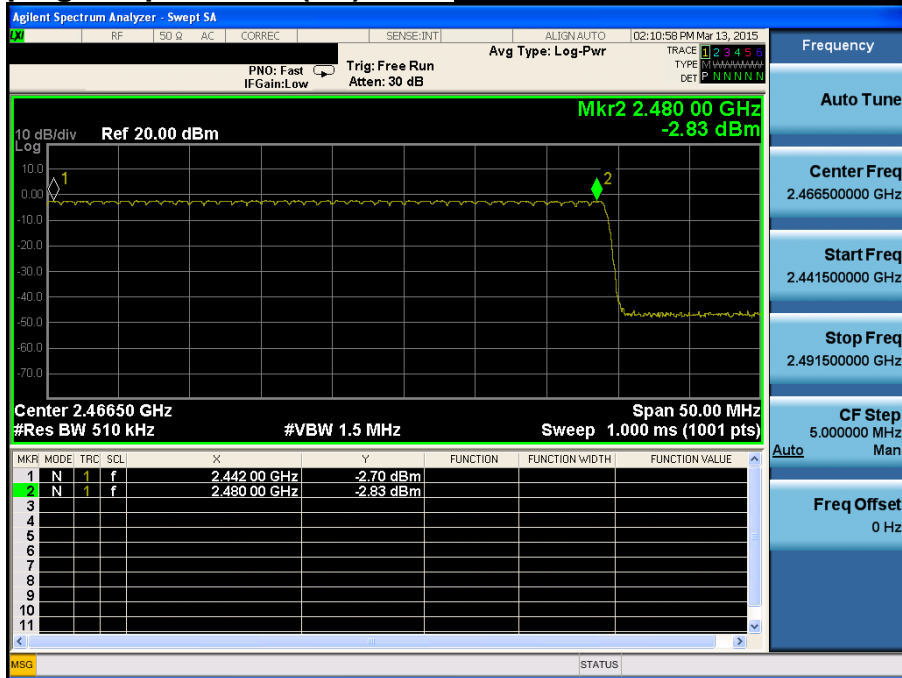

Number of Hopping Frequencies 1(AFH)

Hopping mode: Enable &GFSK

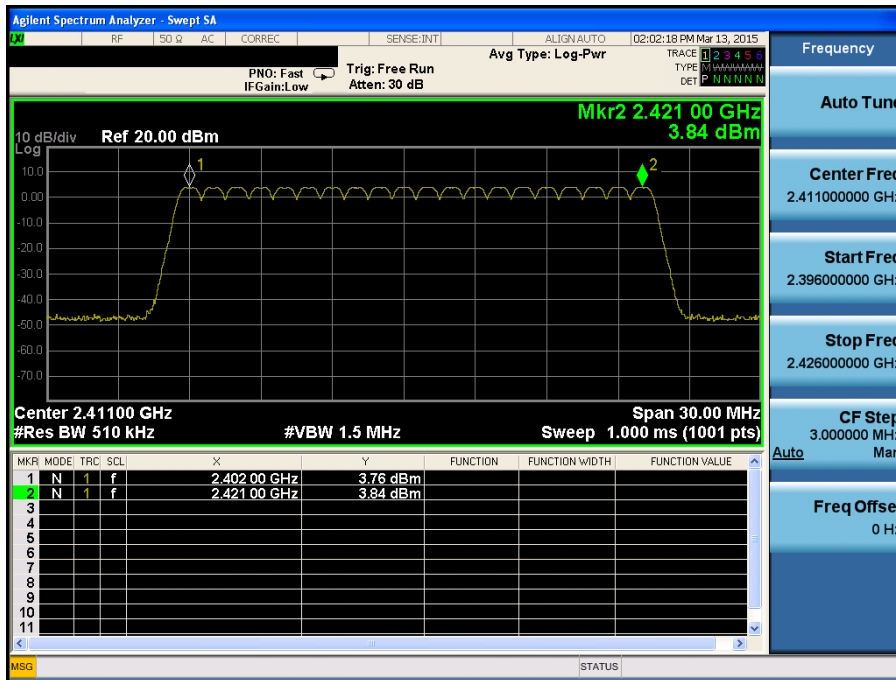

Number of Hopping Frequencies 1(AFH)

Hopping mode: Enable & $\pi/4$ -DQPSK

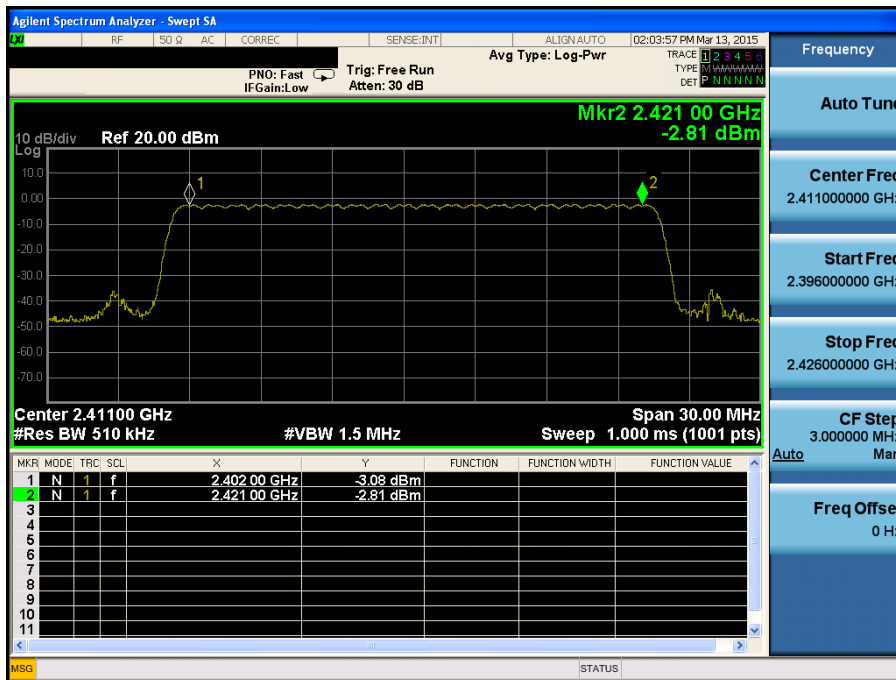

Number of Hopping Frequencies 1(AFH) *Hopping mode: Enable & 8DPSK*

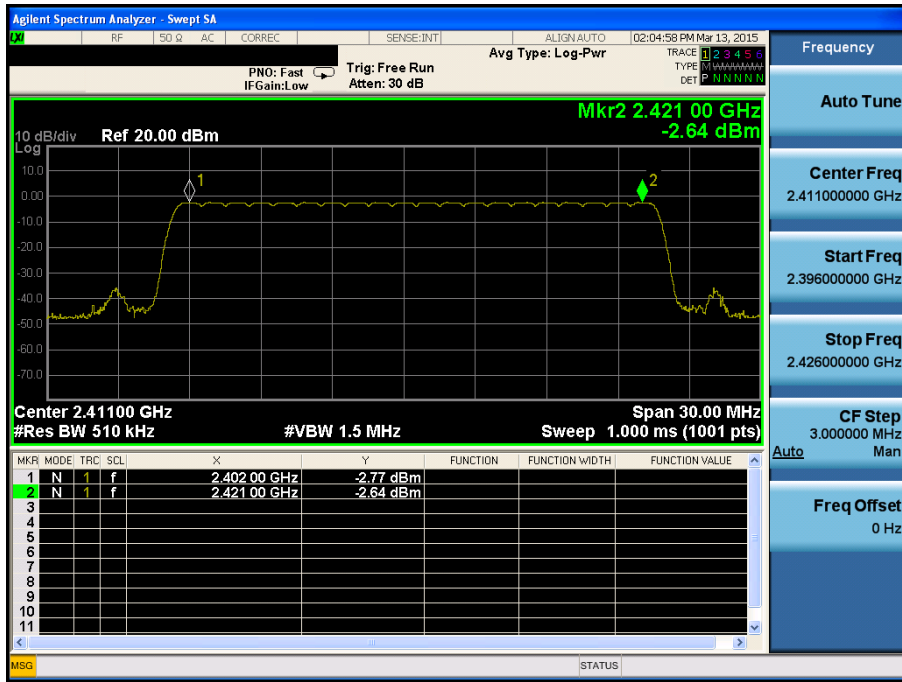

5. 20dBc BW

5.1. Test Setup

Refer to the APPENDIX I.

5.2. Limit

Limit: Not Applicable

5.3. Test Procedure

1. The 20dBc bandwidth were measured with a spectrum analyzer connected to RF antenna connector (conducted measurement) while EUT was operating in transmit mode. The analyzer center frequency was set to the EUT carrier frequency, using the analyzer.
2. The bandwidth of the fundamental frequency was measured with the spectrum analyzer using $RBW \geq 1\%$ of the 20 dB bandwidth, $VBW \geq RBW$, Span = 3MHz.

5.4. Test Results

Ambient temperature : 24 °C
 Relative humidity : 36 %

Modulation	Tested Channel	20dBc BW (MHz)
<u>GFSK</u>	Lowest	0.924
	Middle	0.924
	Highest	0.927
<u>$\pi/4$DQPSK</u>	Lowest	1.320
	Middle	1.323
	Highest	1.320
<u>8DPSK</u>	Lowest	1.308
	Middle	1.338
	Highest	1.308

Note 1: See next pages for actual measured spectrum plots.

20dBc Bandwidth

Lowest Channel & Modulation: GFSK



20dBc Bandwidth

Middle Channel & Modulation: GFSK



20dBc Bandwidth

Highest Channel&Modulation: GFSK



20dBc Bandwidth

Lowest Channel&Modulation: π/4DQPSK



20dBc Bandwidth

Middle Channel & Modulation: $\pi/4$ DQPSK



20dBc Bandwidth

Highest Channel & Modulation: $\pi/4$ DQPSK



20dBc Bandwidth

Lowest Channel&Modulation: 8DPSK



20dBc Bandwidth

Middle Channel&Modulation: 8DPSK



20dBc Bandwidth

Highest Channel & Modulation: 8DPSK



6. Time of Occupancy (Dwell Time)

6.1. Test Setup

Refer to the APPENDIX I.

6.2. Limit

The maximum permissible time of occupancy is 400 ms within a period of 400 ms multiplied by the number of hopping channels employed.

6.3. Test Procedure

The dwell time was measured with a spectrum analyzer connected to the antenna terminal, while EUT had its hopping function enabled.

The spectrum analyzer is set to:

Center frequency = 2441 MHz
 RBW = 1 MHz
 Trace = max hold

Span = zero
 VBW = \geq RBW
 Detector function = peak

6.4. Test Results

Ambient temperature : 24 °C
 Relative humidity : 36 %

- FH mode

Hopping mode	Packet Type	Number of hopping Channels	Burst On Time (ms)	Period (ms)	Test Result (sec)
Enable	DH 5	79	2.880	3.750	0.307
	2 DH 5	79	2.880	3.750	0.307
	3 DH 5	79	2.880	3.750	0.307

- AFH mode

Hopping mode	Packet Type	Number of hopping Channels	Burst On Time (ms)	Period (ms)	Test Result (sec)
Enable	DH 5	20	2.880	3.750	0.154
	2 DH 5	20	2.880	3.750	0.154
	3 DH 5	20	2.880	3.750	0.154

Note 1: Dwell Time = $0.4 \times \text{Hopping channel} \times \text{Burst ON time} \times ((\text{Hopping rate} \div \text{Time slots}) \div \text{Hopping channel})$
 - Time slots for DH5 = 6 slots(TX = 5 slot / RX = 1 slot)
 - Hopping Rate = 1600 for FH mode & 800 for AFH mode

Note 2: See next pages for actual measured spectrum plots.

Time of Occupancy (FH)

Hopping mode: Enable&GFSK

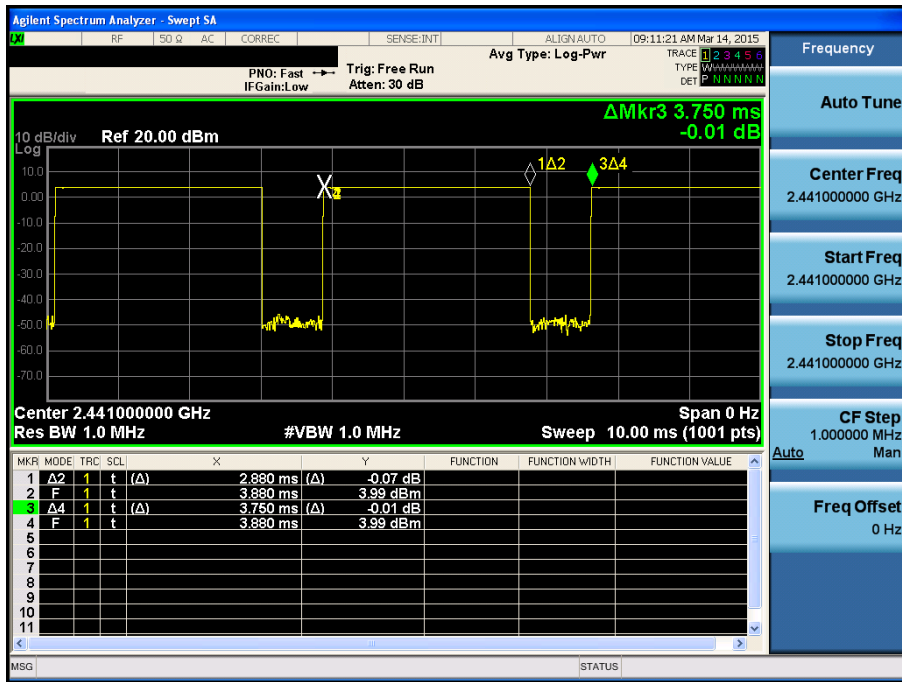

Time of Occupancy (FH)

Hopping mode: Enable& $\pi/4$ -DQPSK

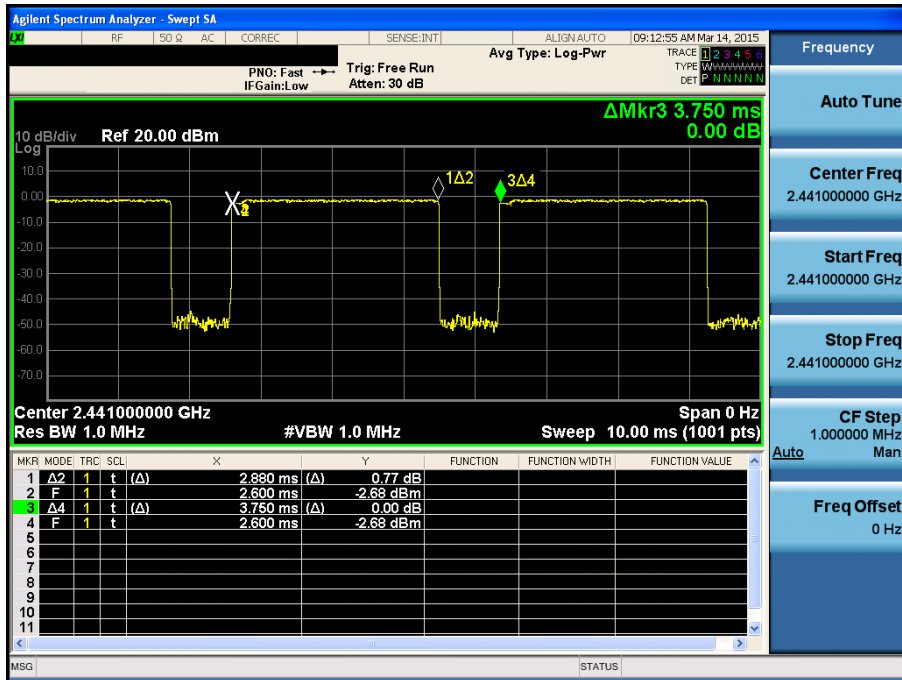

Time of Occupancy (FH)

Hopping mode: Enable&8DPSK

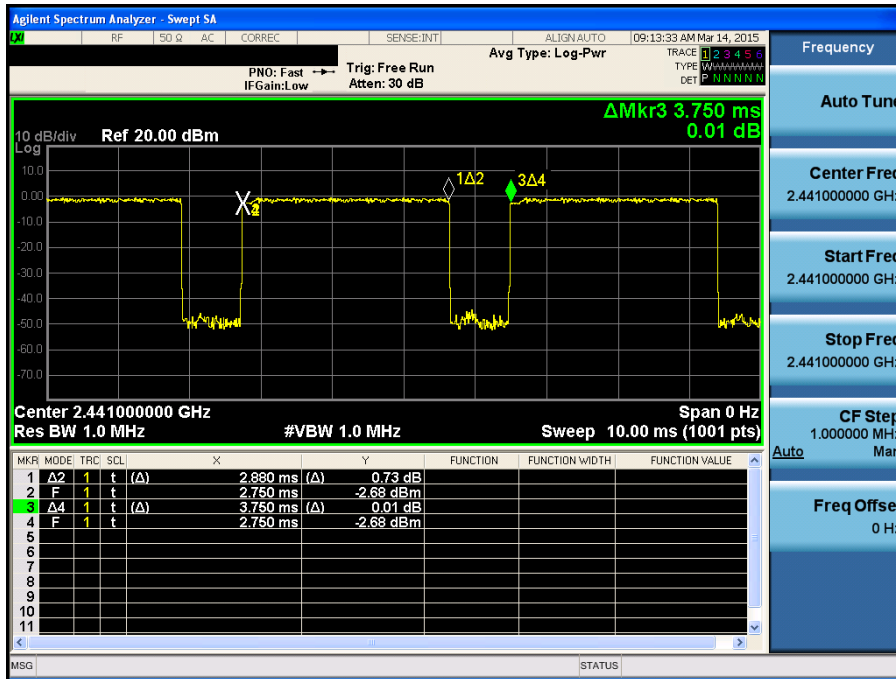

Time of Occupancy (AFH)

Hopping mode: Enable&GFSK

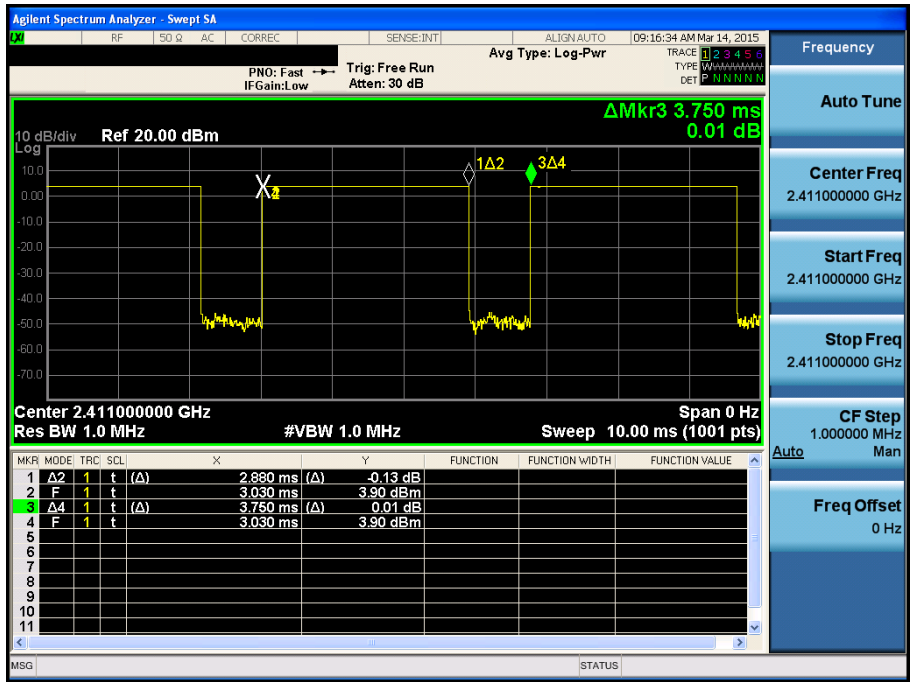

Time of Occupancy (AFH)

Hopping mode: Enable& $\pi/4$ -DQPSK

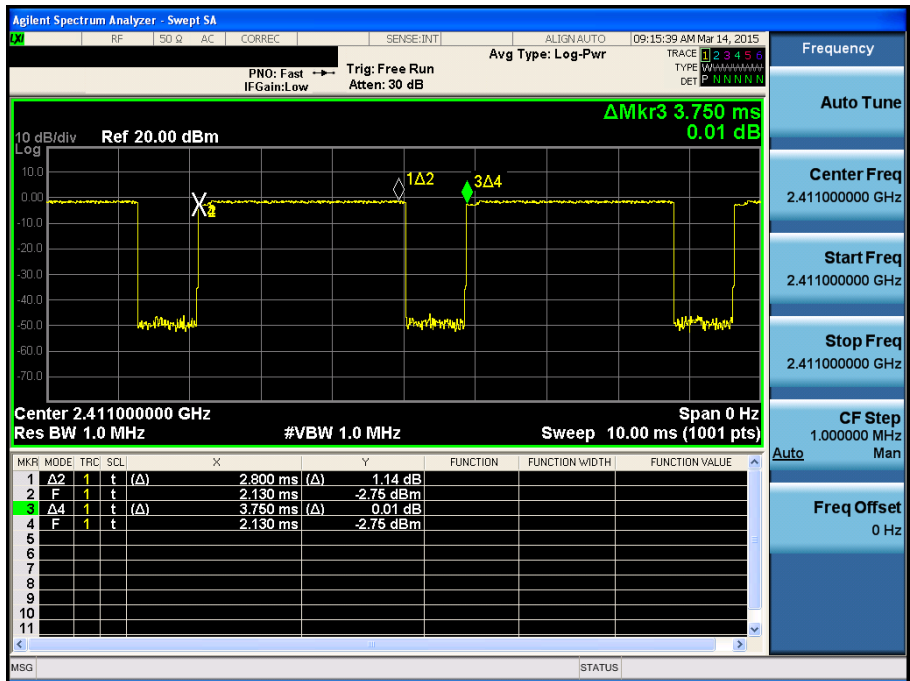

Time of Occupancy (AFH)

Hopping mode: Enable&8DPSK

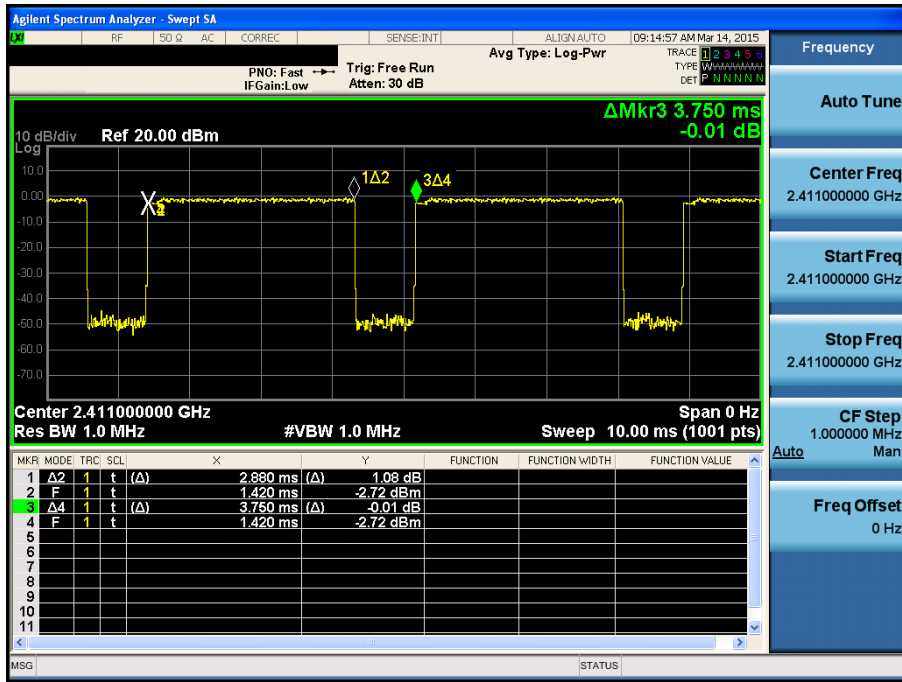

7. Maximum Peak Output Power Measurement

7.1. Test Setup

Refer to the APPENDIX I.

7.2. Limit

■ FCC Requirements

The maximum peak output power of the intentional radiator shall not exceed the following :

1. §15.247(a)(1), Frequency hopping systems shall have hopping channel carrier frequencies separated by a minimum of 25 kHz or the 20 dB bandwidth of the hopping channel, whichever is greater, provided the systems operate with an output power no greater than 125 mW.
2. §15.247(b)(1), For frequency hopping systems operating in the 2 400 – 2 483.5 MHz employing at least 75 non-overlapping hopping channels, and all frequency hopping systems in the 5 725 – 5 805 MHz band: 1 Watt.

■ IC Requirements

1. RSS-247(5.4), For FHSs operating in the band 2400-2483.5 MHz, the maximum peak conducted output power shall not exceed 1.0 W and the e.i.r.p. shall not exceed 4 W if the hopset uses 75 or more hopping channels; the maximum peak conducted output power shall not exceed 0.125 W and the e.i.r.p. shall not exceed 0.5 W if the hopset uses less than 75 hopping channels

7.3. Test Procedure

1. The RF power output was measured with a Spectrum analyzer connected to the RF Antenna connector (conducted measurement) while EUT was operating in transmit mode at the appropriate center frequency, A spectrum analyzer was used to record the shape of the transmit signal.
2. The bandwidth of the fundamental frequency was measured with the spectrum analyzer using ;
Span = approximately 5 times of the 20 dB bandwidth, centered on a hopping channel
RBW \geq 20dB BW
VBW \geq RBW
Sweep = auto
Detector function = peak
Trace = max hold

7.4. Test Results

Ambient temperature : 24 °C
 Relative humidity : 36 %

Modulation	Tested Channel	Peak Output Power	
		dBm	mW
<u>GFSK</u>	Lowest	3.90	2.455
	Middle	4.00	2.512
	Highest	3.77	2.382
<u>$\pi/4$DQPSK</u>	Lowest	-0.52	0.887
	Middle	-0.46	0.899
	Highest	-0.66	0.859
<u>8DPSK</u>	Lowest	0.07	1.016
	Middle	0.16	1.038
	Highest	-0.06	0.986

Note 1: See next pages for actual measured spectrum plots.

Peak Output Power

Lowest Channel & Modulation: GFSK

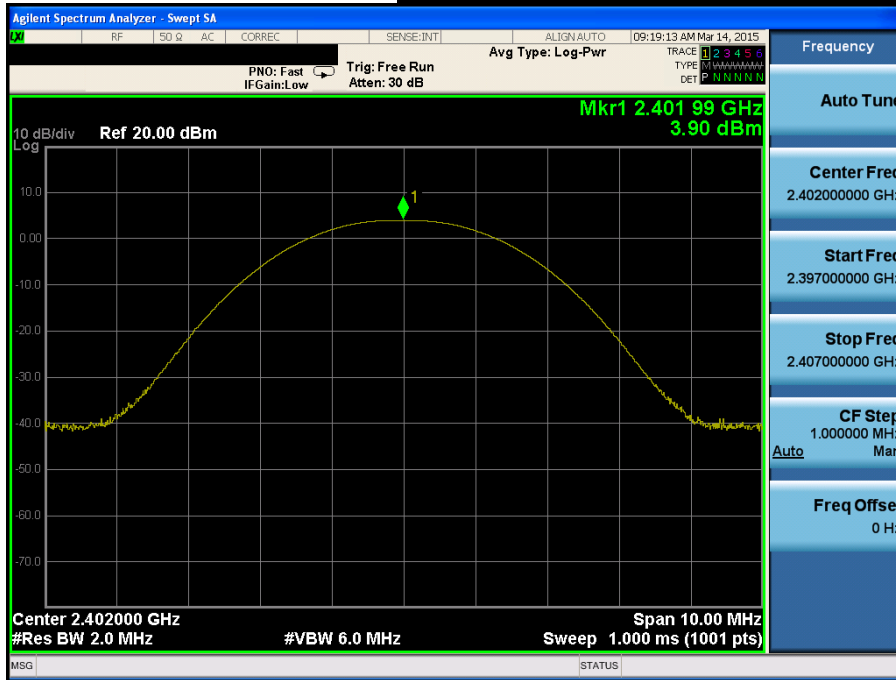

Peak Output Power

Middle Channel & Modulation: GFSK

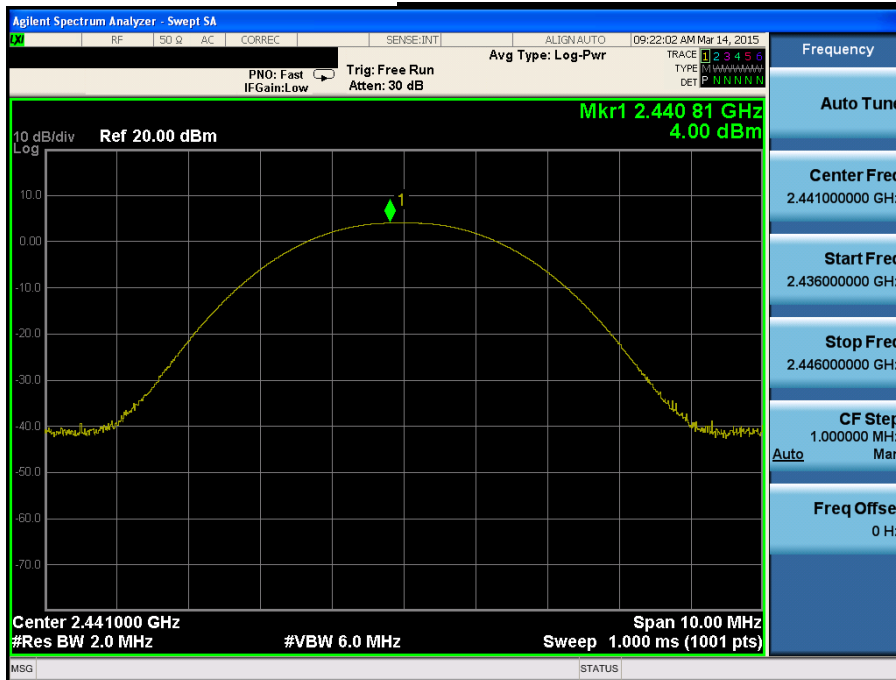

Peak Output Power

Highest Channel & Modulation: GFSK

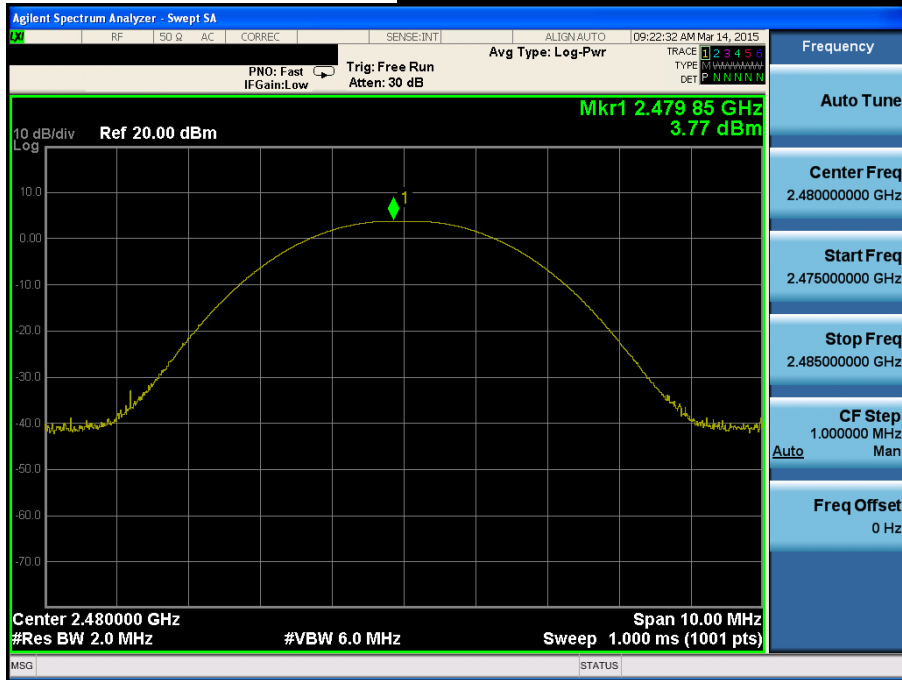

Peak Output Power

Lowest Channel & Modulation: $\pi/4$ QPSK

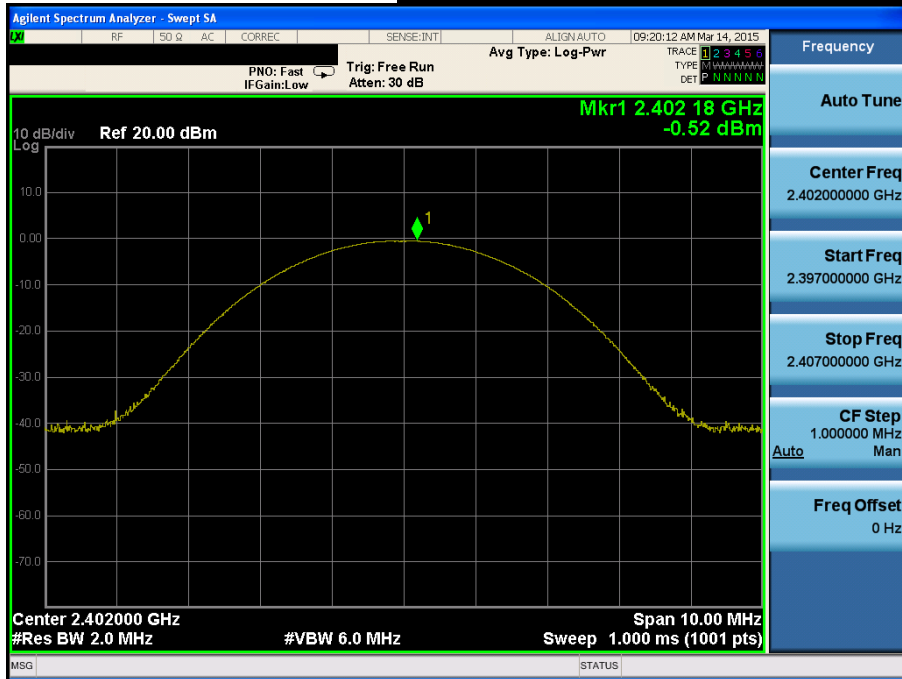

Peak Output Power

Middle Channel & Modulation: $\pi/4$ DQPSK

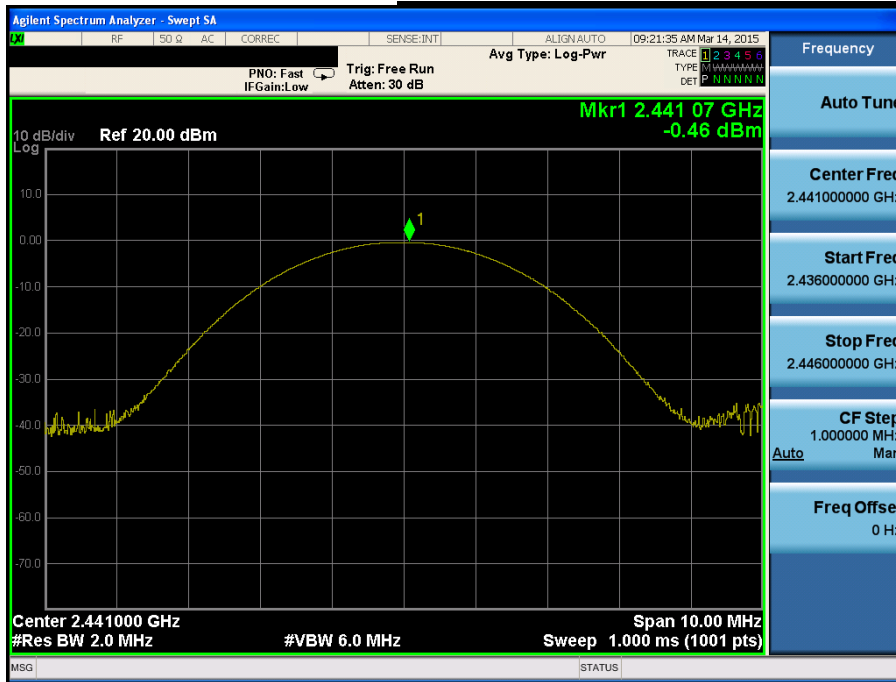

Peak Output Power

Highest Channel & Modulation: $\pi/4$ DQPSK

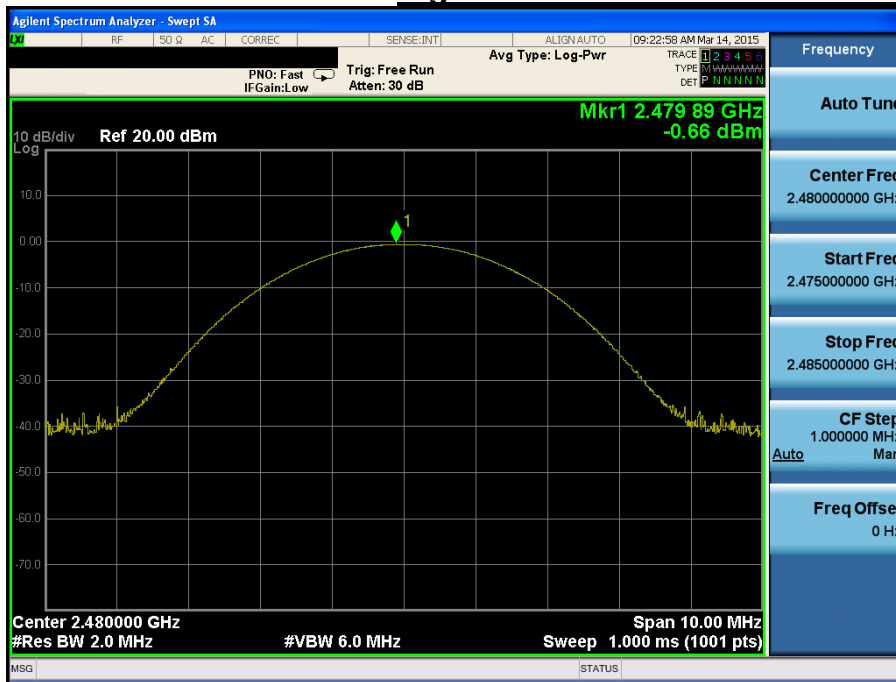

Peak Output Power

Lowest Channel&Modulation: 8DPSK

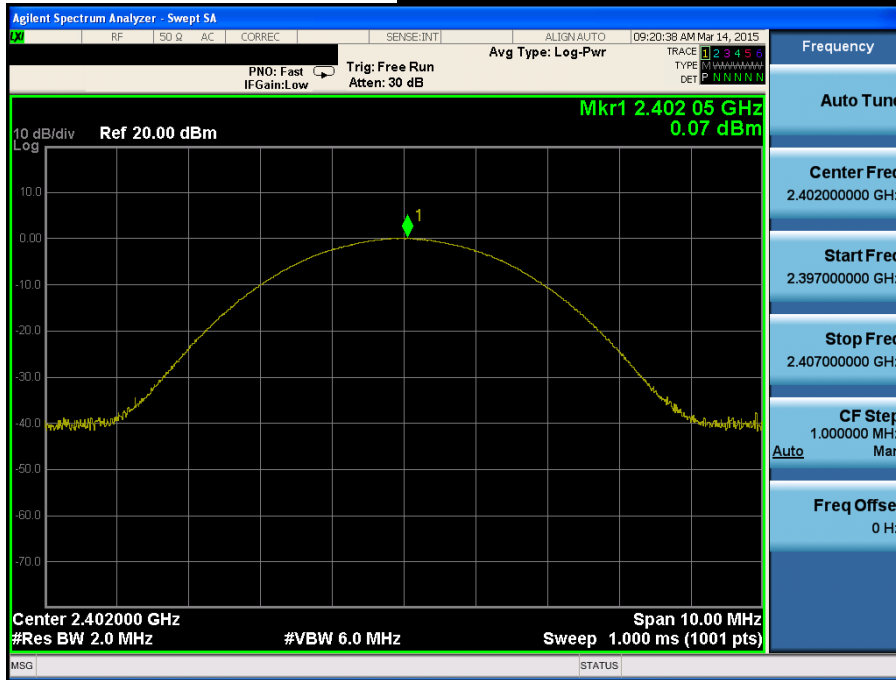

Peak Output Power

Middle Channel&Modulation: 8DPSK

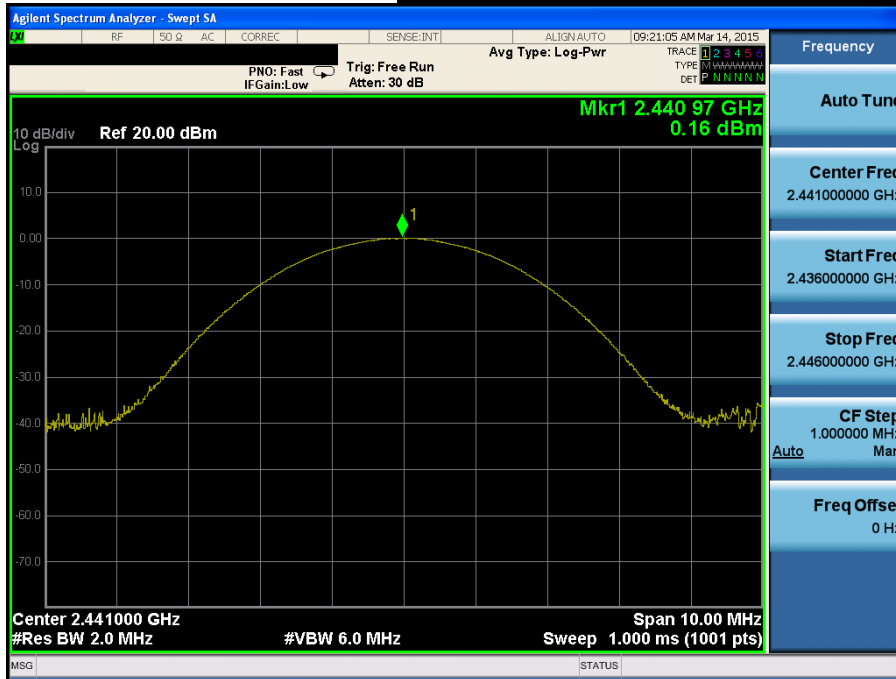

Peak Output Power

Highest Channel & Modulation: 8DPSK

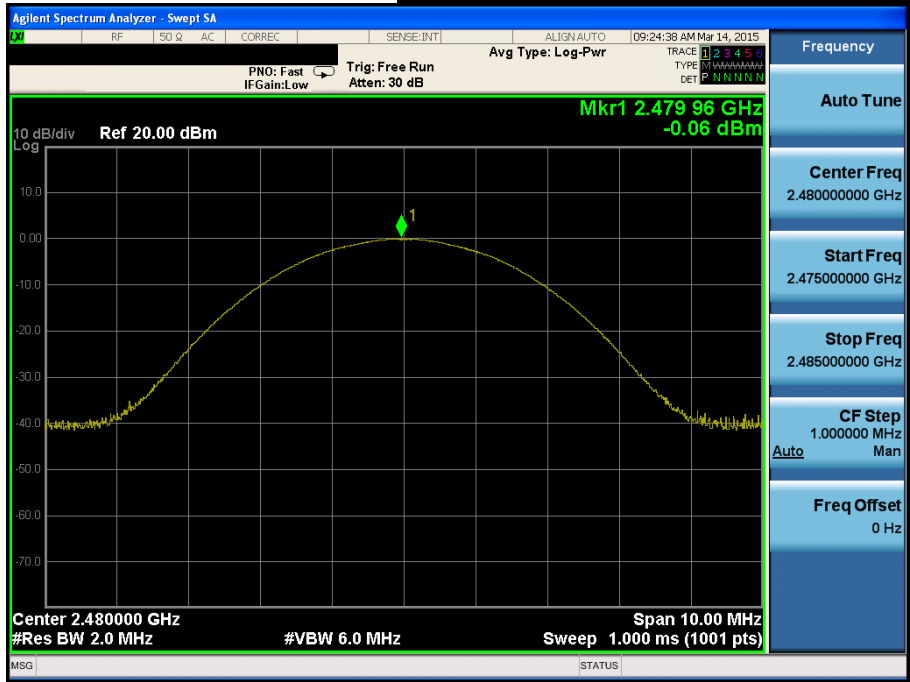

8. Transmitter AC Power Line Conducted Emission

8.1. Test Setup

Refer to test setup photo.

8.2. Limit

According to §15.207(a) for an intentional radiator that is designed to be connected to the public utility (AC) power line, the radio frequency voltage that is conducted back onto the AC power line on any frequency or frequencies, within the band 150 kHz to 30 MHz, shall not exceed the limits in the following table, as measured using a 50 uH/50 ohm line impedance stabilization network(LISN).

Compliance with the provision of this paragraph shall on the measurement of the radio frequency voltage between each power line and ground at the power terminal. The lower applies at the boundary between the frequency ranges.

Frequency Range (MHz)	Conducted Limit (dBuV)	
	Quasi-Peak	Average
0.15 ~ 0.5	66 to 56 *	56 to 46 *
0.5 ~ 5	56	46
5 ~ 30	60	50

* Decreases with the logarithm of the frequency

8.3. Test Procedures

Conducted emissions from the EUT were measured according to the ANSI C63.10-2013

1. The test procedure is performed in a 6.5 m × 3.5 m × 3.5 m (L × W × H) shielded room. The EUT along with its peripherals were placed on a 1.0 m (W) × 1.5 m (L) and 0.8 m in height wooden table and the EUT was adjusted to maintain a 0.4 meter space from a vertical reference plane.
2. The EUT was connected to power mains through a line impedance stabilization network (LISN) which provides 50 ohm coupling impedance for measuring instrument and the chassis ground was bounded to the horizontal ground plane of shielded room.
3. All peripherals were connected to the second LISN and the chassis ground also bounded to the horizontal ground plane of shielded room.
4. The excess power cable between the EUT and the LISN was bundled. The power cables of peripherals were unbundled. All connecting cables of EUT and peripherals were moved to find the maximum emission.

8.4. Test Results

AC Line Conducted Emissions (Graph)&Modulation: GFSK

Results of Conducted Emission

DTNC Date : 2015-03-16

Order No. :
 Model No. : Zeno 20
 Serial No. :
 Test Condition :

Reference No. :
 Power Supply : 120 V 60 Hz
 Temp/Humi. : 20 'C 41 % R.H.
 Operator : H.S.Son

Memo : BT

LIMIT : FCC P15.207 QP
 FCC P15.207 AV

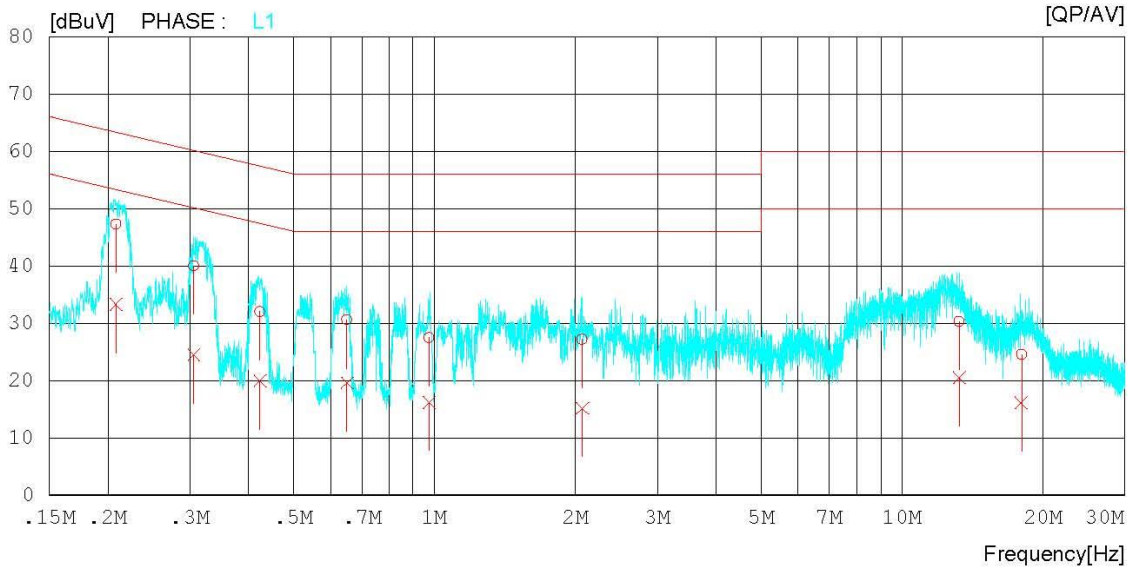
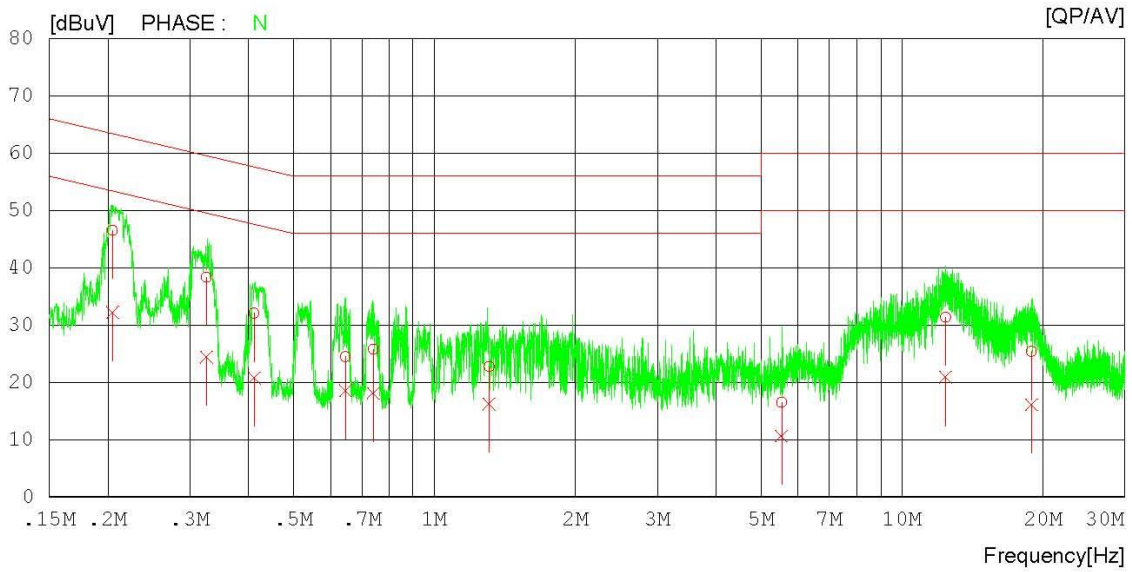

AC Line Conducted Emissions (List)&Modulation: GFSK**Results of Conducted Emission**

DTNC

Date : 2015-03-16

Order No. :
 Model No. : Zeno 20
 Serial No. :
 Test Condition :

Reference No. :
 Power Supply : 120 V 60 Hz
 Temp/Humi. : 20 °C 41 % R.H.
 Operator : H.S.Son

Memo : BT

LIMIT : FCC P15.207 QP
 FCC P15.207 AV

NO	FREQ [MHz]	READING		C. FACTOR [dB]	RESULT		LIMIT		MARGIN		PHASE
		QP [dBuV]	AV [dBuV]		QP [dBuV]	AV [dBuV]	QP [dBuV]	AV [dBuV]	QP [dBuV]	AV [dBuV]	
1	0.20480	36.6	22.3	9.9	46.5	32.2	63.4	53.4	16.9	21.2	N
2	0.32491	28.3	14.4	10.0	38.3	24.4	59.6	49.6	21.3	25.2	N
3	0.41138	21.9	10.7	10.1	32.0	20.8	57.6	47.6	25.6	26.8	N
4	0.64496	14.4	8.4	10.1	24.5	18.5	56.0	46.0	31.5	27.5	N
5	0.73946	15.7	8.0	10.1	25.8	18.1	56.0	46.0	30.2	27.9	N
6	1.31000	12.7	6.1	10.1	22.8	16.2	56.0	46.0	33.2	29.8	N
7	5.52240	6.3	0.4	10.2	16.5	10.6	60.0	50.0	43.5	39.4	N
8	12.40780	20.9	10.4	10.5	31.4	20.9	60.0	50.0	28.6	29.1	N
9	18.94200	14.8	5.5	10.6	25.4	16.1	60.0	50.0	34.6	33.9	N
10	0.20833	37.3	23.3	10.0	47.3	33.3	63.3	53.3	16.0	20.0	L1
11	0.30547	30.0	14.5	10.0	40.0	24.5	60.1	50.1	20.1	25.6	L1
12	0.42350	22.0	9.9	10.0	32.0	19.9	57.4	47.4	25.4	27.5	L1
13	0.65009	20.5	9.5	10.0	30.5	19.5	56.0	46.0	25.5	26.5	L1
14	0.97525	17.4	6.2	10.0	27.4	16.2	56.0	46.0	28.6	29.8	L1
15	2.07120	17.1	5.0	10.1	27.2	15.1	56.0	46.0	28.8	30.9	L1
16	13.25760	19.5	9.8	10.8	30.3	20.6	60.0	50.0	29.7	29.4	L1
17	18.02400	13.7	5.3	10.8	24.5	16.1	60.0	50.0	35.5	33.9	L1

9. Antenna Requirement

■ **Procedure:**

Describe how the EUT complies with the requirement that either its antenna is permanently attached, or that it employs a unique antenna connector, for every antenna proposed for use with the EUT.

■ **Conclusion: Comply**

The antenna is permanently attached.(Refer to Internal Photo file.)

■ **Minimum Standard:**

An intentional radiator shall be designed to ensure that no antenna other than that furnished by the responsible party shall be used with the device. The use of a permanently attached antenna or of an antenna that uses a unique coupling to the intentional radiator shall be considered sufficient to comply with the provisions.

10. Occupied Bandwidth (99%)

- **Procedure: (RSS-Gen Issue 4)**
- The 99% power bandwidth was measured with a calibrated spectrum analyzer.
- Spectrum analyzer plots are included on the following pages.

- **Measurement Data: Comply**

Test Mode	Tested Channel	Test Results (MHz)
<u>GFSK</u>	Lowest	0.852
	Middle	0.852
	Highest	0.864
<u>$\pi/4$DQPSK</u>	Lowest	1.194
	Middle	1.210
	Highest	1.206
<u>8DPSK</u>	Lowest	1.208
	Middle	1.216
	Highest	1.217

- **Minimum Standard:**

NA

Occupied Bandwidth (99%)

Lowest Frequency & GFSK

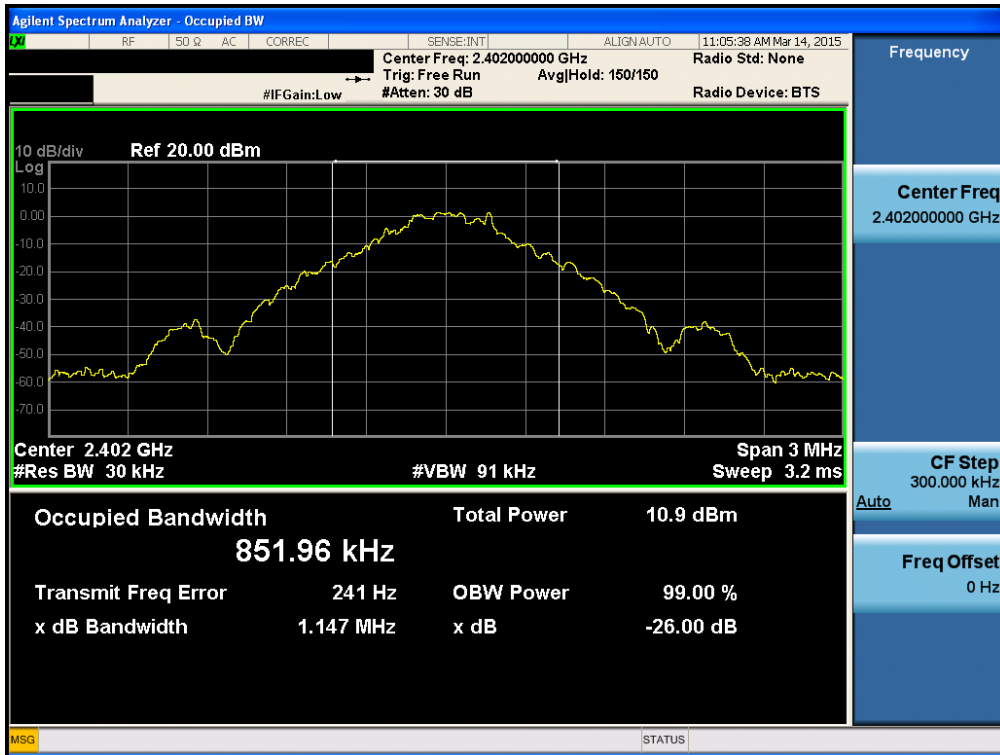

Occupied Bandwidth (99%)

Middle Frequency & GFSK

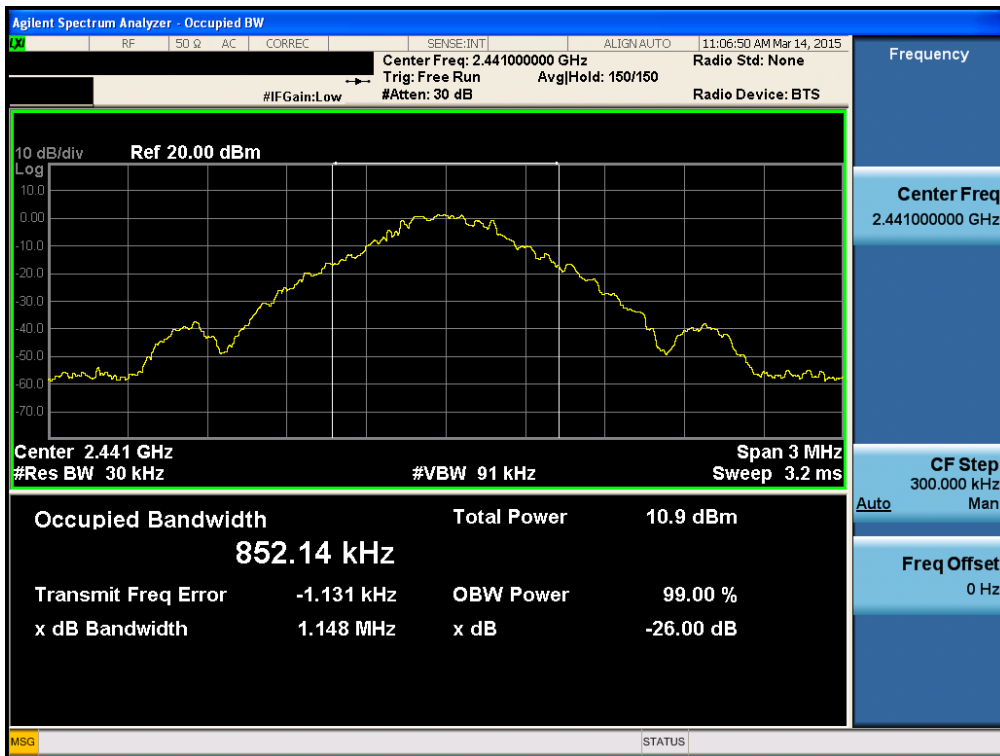

Occupied Bandwidth (99%)

Highest Frequency & GFSK

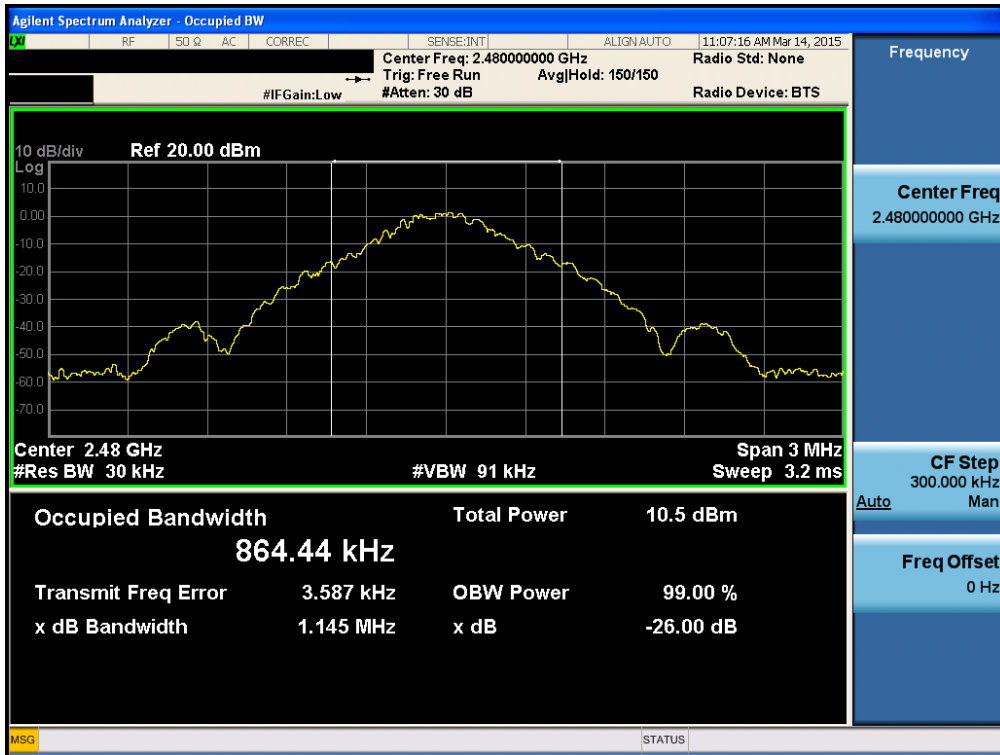

Occupied Bandwidth (99%)

Lowest Frequency & $\pi/4$ DQPSK

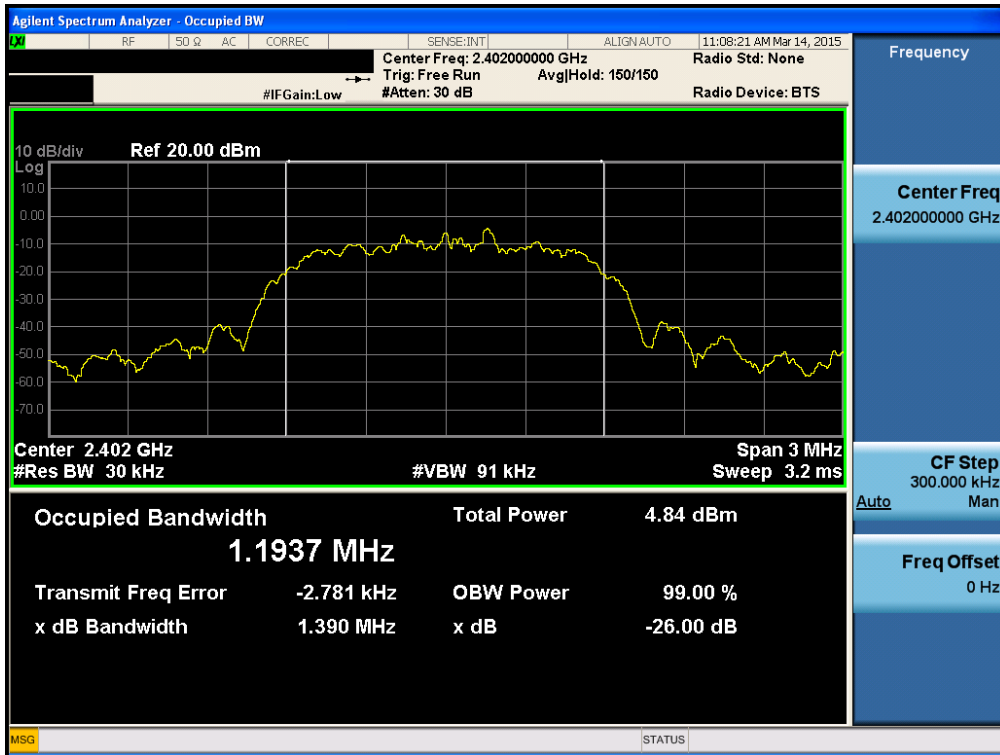

Occupied Bandwidth (99%)

Middle Frequency & $\pi/4$ DQPSK

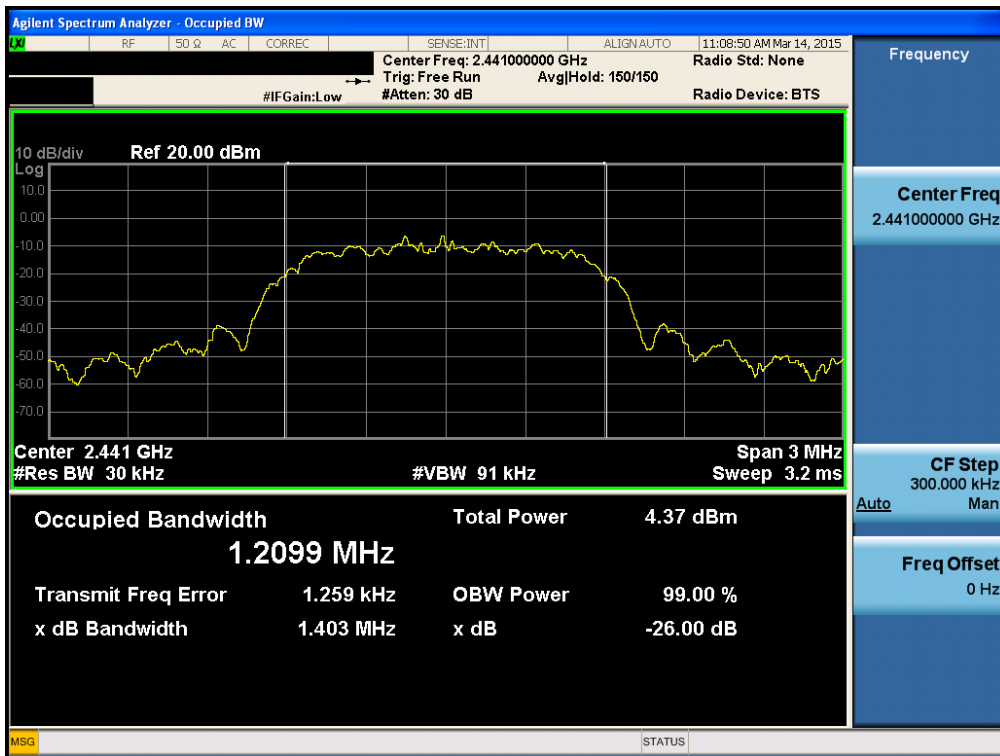

Occupied Bandwidth (99%)

Highest Frequency & $\pi/4$ DQPSK

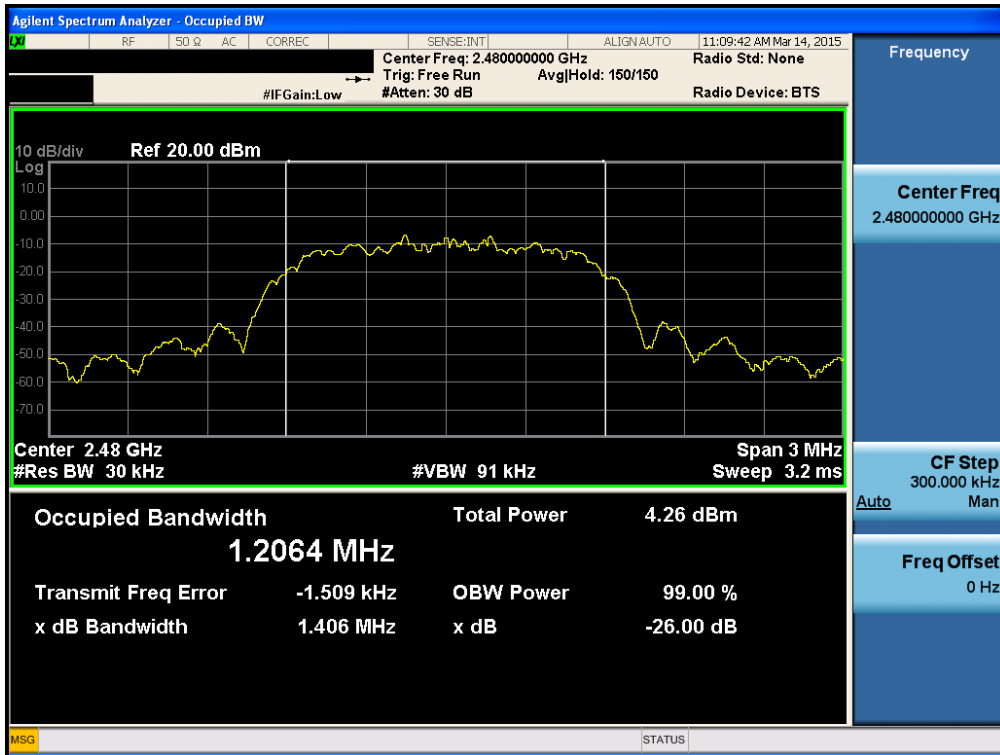

Occupied Bandwidth (99%)

Lowest Frequency & 8DPSK

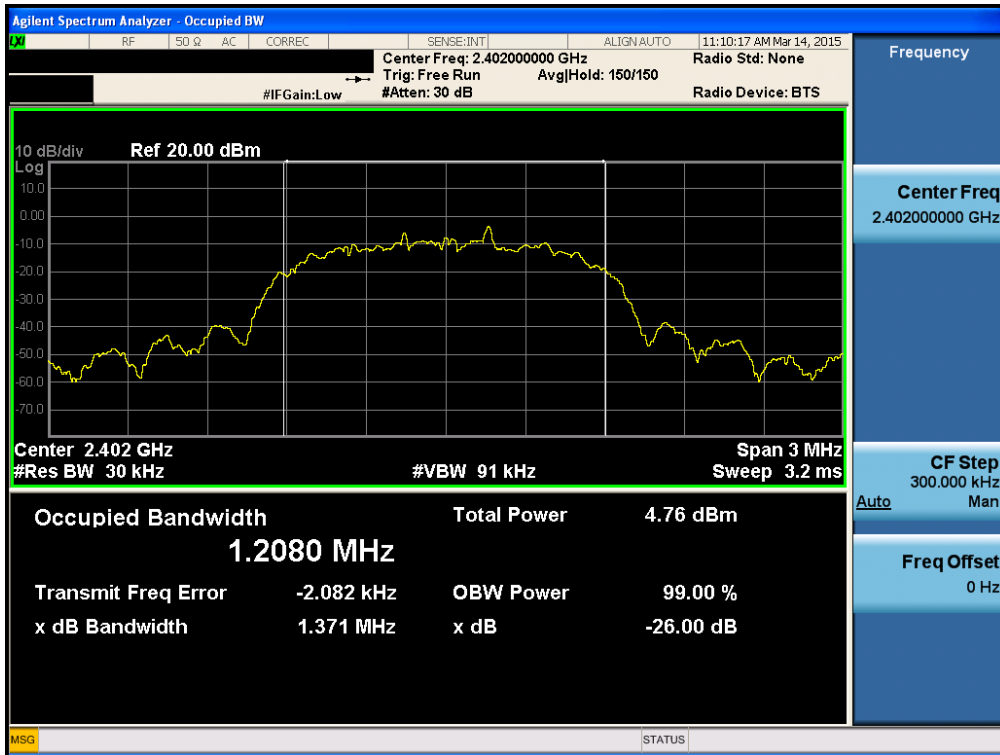

Occupied Bandwidth (99%)

Middle Frequency & 8DPSK

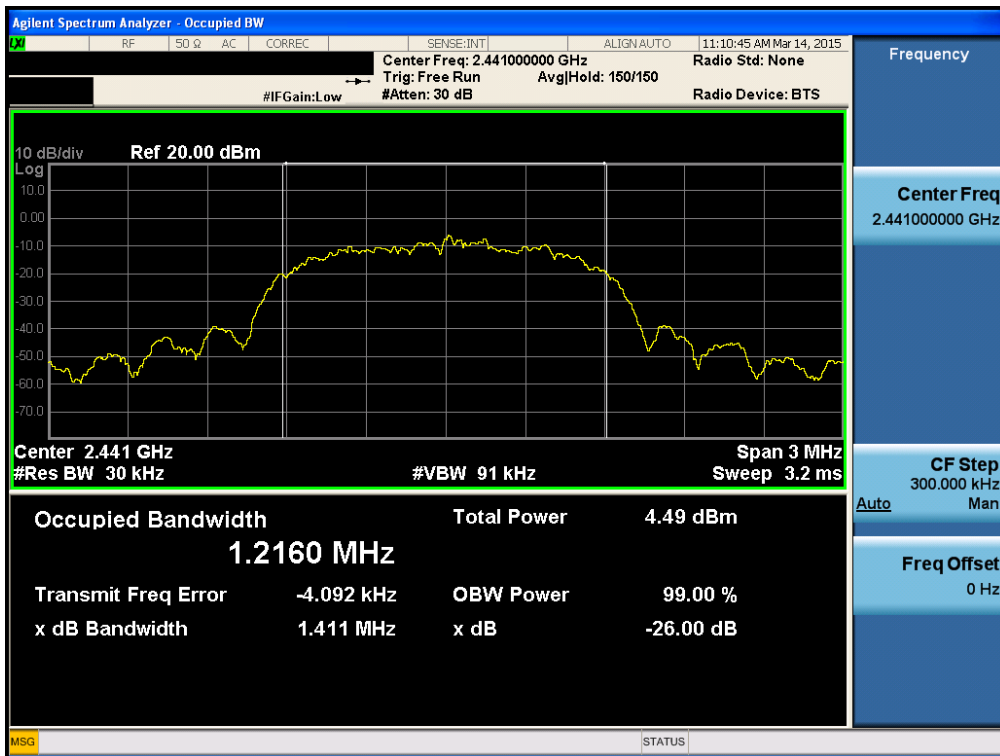

Occupied Bandwidth (99%)

Highest Frequency & 8DPSK

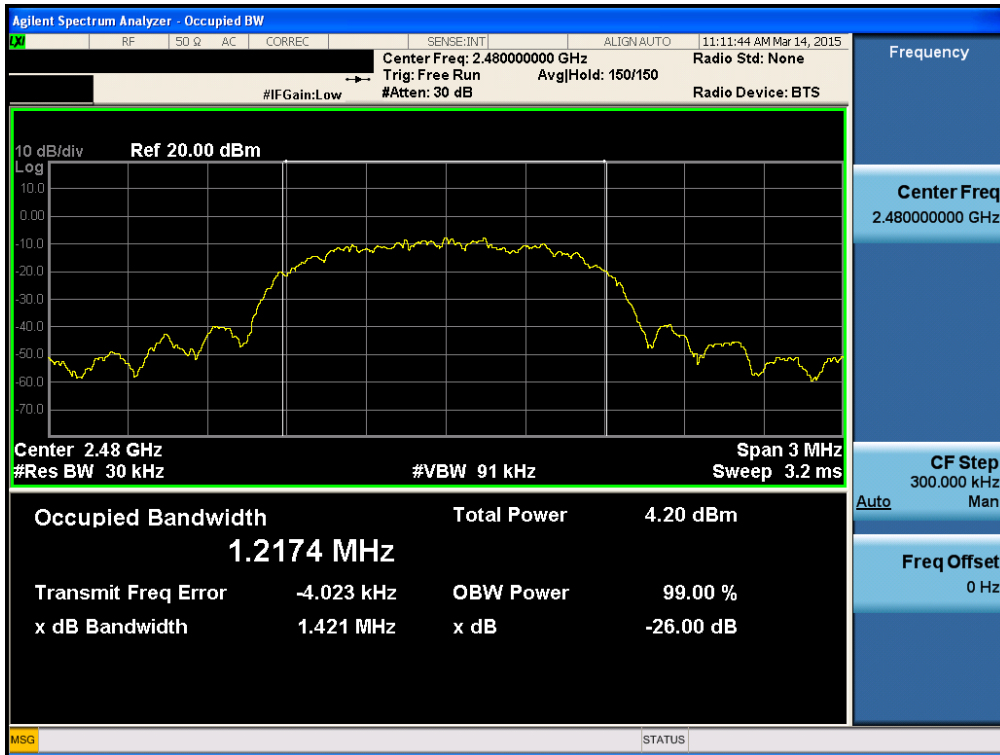

APPENDIX I

Test set up Diagrams&Path lossInformation

▪Radiated Measurement

The diagram below shows the test setup that is utilized to make the measurements for emission from 1 GHz to 25 GHz Emissions.

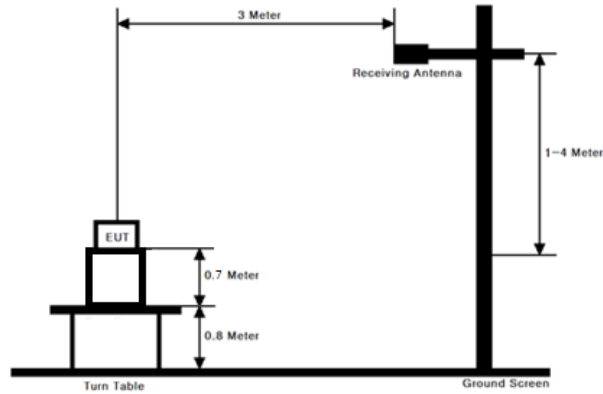

▪Conducted Measurement

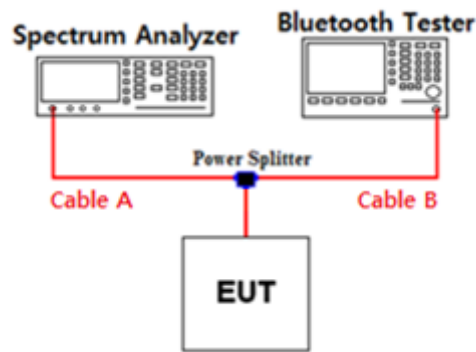

Path loss information

Frequency (GHz)	Path Loss (dB)	Frequency (GHz)	Path Loss (dB)
0.03	6.13	15	7.34
1	6.46	20	7.99
2.402 & 2.441 & 2.480	6.94	25	8.36
5	7.20	-	-
10	7.26	-	-

Note. 1: The path loss from EUT to Spectrum analyzer were measured and used for test.
 Path loss (= S/A's Correction factor) = Cable A + Power splitter