

SAR TEST REPORT

Test item : GNSS Data Collector
Model No. : Zeno 20
Order No. : DTNC1503-00985
Date of receipt : 2015-03-04
Test duration : 2015-04-13 ~ 2015-08-24
Date of issue : 2015-08-25
Use of report : FCC Original Grant

Applicant : Leica Geosystems AG
Heinrich-Wild-Strasse Heerbrugg CH-9435 Switzerland

Test laboratory : DT&C Co., Ltd.
42, Yurim-ro, 154beon-gil, Cheoin-gu, Yongin-si, Gyeonggi-do, Korea 449-935

Test rule part : CFR §2.1093
Test environment : See appended test report
Test result : Pass Fail

The test results presented in this test report are limited only to the sample supplied by applicant and the use of this test report is inhibited other than its purpose. This test report shall not be reproduced except in full, without the written approval of DT&C Co., Ltd.

Tested by:

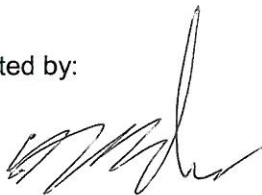

Engineer
BumJun, Park

Witnessed by:

Engineer
N/A

Reviewed by:



Technical Director
Harvey Sung

Table of Contents

1. DESCRIPTION OF DEVICE.....	5
1.1 Guidance Applied.....	6
1.2 Device Overview	6
1.3 Nominal and Maximum Output Power Specifications.....	6
1.4 DUT Antenna Locations	7
1.5 Determination of the SAR Test Configuration.....	8
1.6 SAR Test Exclusions Applied.....	9
1.7 Power Reduction for SAR	10
1.8 Device Serial Numbers	10
2. INTROCUCTION	11
3. DESCRIPTION OF TEST EQUIPMENT	12
3.1 SAR MEASUREMENT SETUP.....	12
3.2 EX3DV4Probe Specification	13
3.3 Probe Calibration Process	14
3.3.1 E-Probe Calibration	14
3.4 Data Extrapolation.....	15
3.5 ELI PHANTOM	16
3.6 Device Holder for Transmitters	16
3.7 Brain & Muscle Simulation Mixture Characterization.....	17
3.8 SAR TEST EQUIPMENT	18
4. TEST SYSTEM SPECIFICATIONS.....	19
5. SAR MEASUREMENT PROCEDURE.....	20
5.1 Measurement Procedure.....	20
6. TEST CONFIGURATION POSITIONS FOR HANDSETS	21
6.1 Device Holder.....	21
6.2 Head Exposure Configurations	21
6.3 Extremity Exposure Configurations.....	21
7. RF EXPOSURE LIMITS	22
8. FCC MEASUREMENT PROCEDURES.....	23
8.1 Measured and Reported SAR.....	23
8.2 Procedures Used to Establish RF Signal for SAR	23
8.3 SAR Measurement Conditions for WCDMA (UMTS).....	23
8.3.1 Output Power Verification.....	23
8.3.2 SAR Measurements for Handsets with Rel 5 HSDPA.....	23
8.3.3 SAR Measurements for Handsets with Rel 6 HSUPA.....	24
8.4 SAR Testing with 802.11 Transmitters	25
8.4.1 General Device Setup	25
8.4.2 Initial Test Position Procedure	25
8.4.3 2.4 GHz SAR Test Requirements.....	26
8.4.4 OFDM Transmission Mode and SAR Test Channel Selection	26
8.4.5 Initial Test Configuration Procedure	26
8.4.6 Subsequent Test Configuration Procedures.....	26
9. RF CONDUCTED POWERS	27
9.1 GSM Conducted Powers.....	27
9.2 WCDMA Conducted Powers.....	28
9.3 WLAN Conducted Powers	29
9.4 Bluetooth Conducted Powers.....	30

10. SYSTEM VERIFICATION	31
10.1 Tissue Verification.....	31
10.2 Test System Verification	32
11. SAR TEST RESULTS	33
11.1 Hand SAR Results	33
11.2 Head SAR Results	35
11.3 SAR Test Notes	36
12. SAR MEASUREMENT VARIABILITY	38
12.1 Measurement Variability.....	38
12.2 Measurement Uncertainty	38
13. IEEE P1528 –MEASUREMENT UNCERTAINTIES	39
14. CONCLUSION	42
15. REFERENCES	43
Attachment 1. – Probe Calibration Data	45
Attachment 2. – Dipole Calibration Data	57
Attachment 3. – SAR SYSTEM VALIDATION	82

Test Report Version

Test Report No.	Date	Description
DRRFCC1505-0038	May. 12, 2015	Final version for approval
DRRFCC1505-0038(1)	Jun. 18, 2015	Changed for KDB 248227 D01v02r01
DRRFCC1505-0038(2)	Aug. 07, 2015	Changed for Tune up
DRRFCC1505-0038(3)	Aug. 25, 2015	Add of Head SAR Test

1. DESCRIPTION OF DEVICE

Environmental evaluation measurements of specific absorption rate (SAR) distributions in emulated human body tissues exposed to radio frequency (RF) radiation from wireless portable devices for compliance with the rules and regulations of the U.S. Federal Communications Commission (FCC).

General Information:

EUT type	GNSS Data Collector				
FCC ID	RFD-ZENO20G				
Equipment model name	Zeno 20				
Equipment serial no.	Identical prototype				
Mode(s) of Operation	GPRS 850, GPRS 1900, WCDMA 850, WCDMA 1900, 2.4 GHz W-LAN (802.11b/g/n HT20)				
TX Frequency Range	824.2 ~ 848.8 MHz (Cellular Band) / 1850.2 ~ 1909.8 MHz (PCS Band) 826.4 ~ 846.6 MHz (WCDMA FDD V) / 1852.4 ~ 1907.6 MHz (WCDMA FDD II) 2412 ~ 2462 MHz (802.11b/g/n HT20)				
RX Frequency Range	869.2 ~ 893.8 MHz (Cellular Band) / 1930.2 ~ 1989.8 MHz (PCS Band) 871.4 ~ 891.6 MHz (WCDMA FDD V) / 1932.4 ~ 1987.6 MHz (WCDMA FDD II) 2412 ~ 2462 MHz (802.11b/g/n HT20)				
Equipment Class	Band	Measured Conducted Power [dBm]	Reported SAR		Reported SAR
			10g Extremity SAR (W/kg)		1g SAR (W/kg)
			Hand		Head
PCB	GPRS 850	32.90	0.23	30.30	0.13
PCB	GPRS 1900	27.00	1.70	27.00	0.11
PCB	WCDMA 850	23.72	0.35	23.72	0.16
PCB	WCDMA 1900	24.00	1.98	24.00	0.19
DTS	2.4 GHz W-LAN	15.68	0.17	15.68	0.07
DSS	Bluetooth	2.72	N/A		
FCC Equipment Class	PCS Licensed Transmitter (PCB) Part 15 Spread Spectrum Transmitter(DSS) Digital Transmission System(DTS)				
Date(s) of Tests	2015-04-13 ~ 2015-08-24				
Antenna Type	Internal Type Antenna				
Functions	<ul style="list-style-type: none"> ● BT(2.4GHz) / W-LAN (2.4GHz 802.11b/g/n(HT20)) supported * No simultaneous transmission between BT & WLAN ● GPRS (GPRS Class: 12) / EDGE (EDGE Class: 12) supported ● GSM Audio is not supported. ● GPRS, WCDMA, W-LAN VoIP supported. (Speaker phone only) ● Mobile Hotspot is not supported. ● This industrial PDA OS doesn't support any simultaneous transmission between transmitters. 				

1.1 Guidance Applied

- IEEE 1528-2003
- FCC KDB Publication 941225 D01 3G SAR Procedures v03
- FCC KDB Publication 248227 D01v02r01 (802.11 Wi-Fi SAR)
- FCC KDB Publication 447498 D01v05r02 (General SAR Guidance)
- FCC KDB Publication 648474 D04 Handset SAR v01r02
- FCC KDB Publication 690783 D01 SAR Listings on Grants v01r03
- FCC KDB Publication 865664 D01 SAR Measurement 100 MHz to 6 GHz v01r04
- FCC KDB Publication 865664 D02 RF Exposure Reporting v01r01
- October 2013 TCB Workshop Notes (GPRS testing criteria)

1.2 Device Overview

Band	Mode	Operating Modes	Tx Frequency
PCB	GPRS/EDGE 850	Data	824.2 ~ 848.8 MHz
	GPRS/EDGE 1900	Data	1850.2 ~ 1909.8 MHz
	WCDMA 850	Data	826.4 ~ 846.6 MHz
	WCDMA 1900	Data	1852.4 ~ 1907.6 MHz
DTS	2.4 GHz WLAN	Data	2412 ~ 2462 MHz
DSS	Bluetooth	Data	2402 ~ 2480 MHz

1.3 Nominal and Maximum Output Power Specifications

This device operates using the following maximum and nominal output power specifications. SAR values were scaled to the maximum allowed power to determine compliance per KDB Publication 447498 D01v05r02.

Band & Mode			Burst Average GMSK [dBm]				Burst Average 8-PSK [dBm]			
			1 TX Slot	2 TX Slot	3 TX Slot	4 TX Slot	1 TX Slot	2 TX Slot	3 TX Slot	4 TX Slot
PCB	GPRS/EDGE 850	Maximum	33.5	30.5	28.4	27.0	27.1	24.0	22.0	21.8
		Nominal	33.0	30.0	27.9	26.5	26.6	23.5	21.5	21.3
	GPRS/EDGE 1900	Maximum	30.3	27.7	25.5	24.0	26.2	23.0	21.0	20.0
		Nominal	29.8	27.2	25.0	23.5	25.7	22.5	20.5	19.5

Band & Mode			Modulated Average [dBm]		
			3GPP RMC	3GPP HSDPA	3GPP HSUPA
PCB	WCDMA 850	Maximum	24.1	24.1	24.1
		Nominal	23.6	23.6	23.6
	WCDMA 1900	Maximum	24.2	24.2	24.2
		Nominal	23.7	23.7	23.7

Band & Mode		Modulated Average [dBm]	
DTS	IEEE 802.11b (2.4 GHz)	Maximum	15.7
		Nominal	14.7
	IEEE 802.11g (2.4 GHz)	Maximum	15.5
		Nominal	14.5
	IEEE 802.11n (2.4 GHz)	Maximum	15.5
		Nominal	14.5
DSS	Bluetooth 1 Mbps	Maximum	3.0
		Nominal	2.0
	Bluetooth 2 Mbps	Maximum	-1.5
		Nominal	-2.5
	Bluetooth 3 Mbps	Maximum	-1.5
		Nominal	-2.5

1.4 DUT Antenna Locations

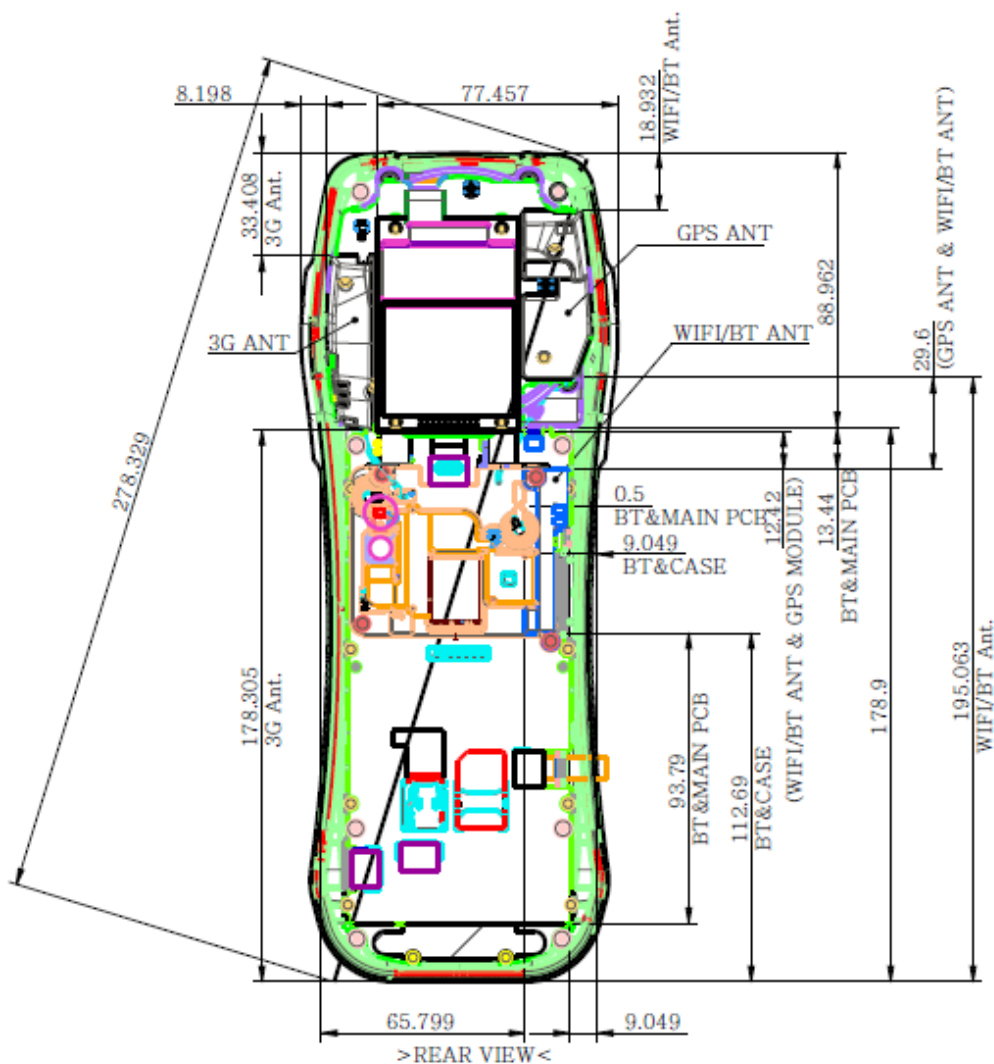

Note: Exact antenna dimensions and separation distances are shown in the "Antenna Location_RFD-ZENO20G" in the FCC Filing.

1.5 Determination of the SAR Test Configuration

According to the applicant's description, this device can be used only in hand (Hand-held Device) or pole mount or vehicle mount and does not support voice call.

Also the body SAR tests are excluded according to the KDB 447498 as below.

When the user uses this device in hand, the bottom side can only be touched to user's body. In this situation, the user's body shall be separated from the closest edges of the antennas as below picture.

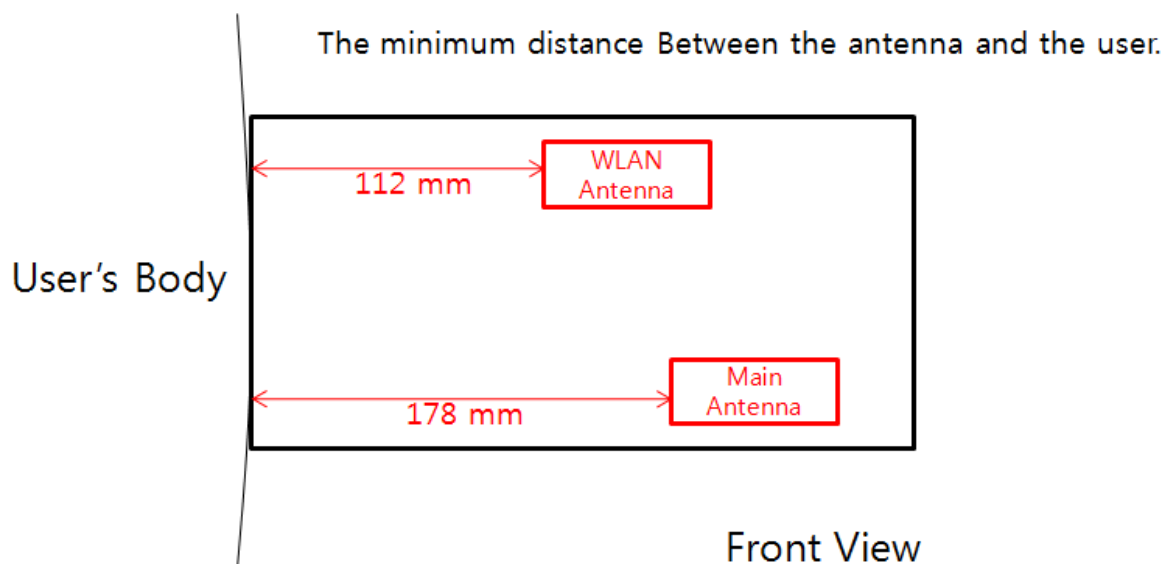

Per FCC KDB 447498 D01v05r02, the SAR exclusion threshold for distances > 50 mm is defined by the following equation: (The SAR test exclusion threshold is determined according to the following, and as illustrated in KDB 447498 Appendix B.)

Table 1.1 Determination of the Body SAR

FREQUENCY		Mode/ Band	Service	# of Time Slots	Equation	Threshold Power [mW]	Tune up Max Power [mW]	Determine Body SAR
MHz	Ch							
848.8	251	GSM 850	GPRS	2	$[163 + (178 - 50)^* (848.8/150)]$	887.3	> <u>281</u> ¹⁾	X
846.6	4233	WCDMA 850	RMC	N/A	$[163 + (178 - 50)^* (846.6/150)]$	885.4	> <u>257</u>	X
1909.8	810	PCS 1900	GPRS	2	$[109 + (178 - 50)^* 10]$	1389	> <u>151</u> ¹⁾	X
1907.6	9538	WCDMA 1900	RMC	N/A	$[109 + (178 - 50)^* 10]$	1389	> <u>263</u>	X
2462	11	802.11b	DSSS	N/A	$[96 + (112 - 50)^* 10]$	716	> <u>37</u>	X

Note 1: GPRS 850 and GPRS 1900 Band Tune up Max Power were calculated Maximum Frame-Averaged Output Power.

Therefore the body SAR tests were excluded as above table 1.1 and only hands SAR tests were conducted.

1.6 SAR Test Exclusions Applied

(A) WIFI & BT for head and hands SAR configuration

Per FCC KDB 447498 D01v05r02, the **1g SAR exclusion threshold for distances < 50 mm** is defined by the following equation:

$$\frac{\text{Max Power of Channel (mW)}}{\text{Test Separation Dist (mm)}} * \sqrt{\text{Frequency(GHz)}} \leq 3.0$$

Based on the maximum conducted power of **Bluetooth** (rounded to the nearest mW) and the antenna to user separation distance, **Bluetooth SAR was not required**; [(2/5)* √2.480] = **0.6** < 3.0.

Based on the maximum conducted power of **2.4 GHz WIFI** (rounded to the nearest mW) and the antenna to user separation distance, **2.4 GHz WIFI SAR was required**; [(37/5)* √2.462] = **11.7** > 3.0.

Per FCC KDB 447498 D01v05r02, the **10g SAR exclusion threshold for distances < 50 mm** is defined by the following equation:

$$\frac{\text{Max Power of Channel (mW)}}{\text{Test Separation Dist (mm)}} * \sqrt{\text{Frequency(GHz)}} \leq 7.5$$

Based on the maximum conducted power of **Bluetooth** (rounded to the nearest mW) and the antenna to user separation distance, **Bluetooth SAR was not required**; [(2/5)* √2.480] = **0.6** < 7.5.

Based on the maximum conducted power of **2.4 GHz WIFI** (rounded to the nearest mW) and the antenna to user separation distance, **2.4 GHz WIFI SAR was required**; [(37/5)* √2.462] = **11.7** > 7.5.

Per KDB Publication 447498 D01v05r02, the maximum power of the channel was rounded to the nearest mW before calculation.

(B) Tested sides for Hands SAR configuration

- 1) Per FCC KDB 447498 D01v05r02, the **10g SAR exclusion threshold for distances < 50 mm** is defined by the following equation:

$$\frac{\text{Max Power of Channel (mW)}}{\text{Test Separation Dist (mm)}} * \sqrt{\text{Frequency(GHz)}} \leq 7.5$$

Table 1.2 SAR Test Exclusion for Edges (Antennas < 50 mm)

FREQUENCY		Mode/ Band	Service	Tune up Max Power [mW]	# of Time Slots	Separation Distance [mm]				Calculated Threshold Power [mW]			
MHz	Ch					Top	Bottom	Right	Left	Top	Bottom	Right	Left
848.8	251	GSM 850	GPRS	281 ¹⁾	2	33	178	8	77	7.8 (O)	> 50mm ²⁾	32.3 (O)	> 50mm ²⁾
846.6	4233	WCDMA 850	RMC	257	N/A	33	178	8	77	7.2 (X)	> 50mm ²⁾	29.6 (O)	> 50mm ²⁾
1909.8	810	PCS 1900	GPRS	151 ¹⁾	2	33	178	8	77	6.3 (X)	> 50mm ²⁾	26.0 (O)	> 50mm ²⁾
1907.6	9538	WCDMA 1900	RMC	263	N/A	33	178	8	77	11.0 (O)	> 50mm ²⁾	45.4 (O)	> 50mm ²⁾
2462	11	802.11b	DSSS	37	N/A	102	112	65	9	> 50mm ²⁾	> 50mm ²⁾	> 50mm ²⁾	6.5 (X)

Note 1: GPRS 850 and GPRS 1900 Band Tune up Max Power were calculated Maximum Frame-Averaged Output Power.

Note 2: See Table 1.3

- 2) Per FCC KDB 447498 D01v05r02, the **SAR exclusion threshold for distances > 50 mm** is defined by the following equation: (the SAR test exclusion threshold is determined according to the following, and as illustrated in KDB 447498 Appendix B.)
- [Power allowed at numeric threshold for 50 mm in step 1) + (test separation distance - 50 mm) · (f_(MHz)/150)] mW, at 100 MHz to 1500 MHz
 - [Power allowed at numeric threshold for 50 mm in step 1) + (test separation distance - 50 mm) · 10] mW at > 1500 MHz and ≤ 6 GHz

Table 1.3 SAR Test Exclusion for Edges (Antennas > 50 mm)

FREQUENCY		Mode/ Band	Service	Tune up Max Power [mW]	# of Time Slots	Separation Distance [mm]				Calculated Threshold Power [mW]			
MHz	Ch					Top	Bottom	Right	Left	Top	Bottom	Right	Left
848.8	251	GSM 850	GPRS	281 ¹⁾	2	33	178	8	77	< 50mm ²⁾	887.3 (X)	< 50mm ²⁾	315.8 (X)
846.6	4233	WCDMA 850	RMC	257	N/A	33	178	8	77	< 50mm ²⁾	885.4 (X)	< 50mm ²⁾	315.4 (X)
1909.8	810	PCS 1900	GPRS	151 ¹⁾	2	33	178	8	77	< 50mm ²⁾	1389 (X)	< 50mm ²⁾	379 (X)
1907.6	9538	WCDMA 1900	RMC	263	N/A	33	178	8	77	< 50mm ²⁾	1389 (X)	< 50mm ²⁾	379 (X)
2462	11	802.11b	DSSS	37	N/A	102	112	65	9	616 (X)	716 (X)	246 (X)	< 50mm ²⁾

Note 1: GPRS 850 and GPRS 1900 Band Tune up Max Power were calculated Maximum Frame-Averaged Output Power.

Note 2: See Table 1.2

Mode	EUT Sides for SAR Testing					
	Top	Bottom	Front	Rear	Right	Left
GPRS 850	O	X	O	O	O	X
GPRS 1900	X	X	O	O	O	X
WCDMA 850	X	X	O	O	O	X
WCDMA 1900	O	X	O	O	O	X
2.4 GHz W-LAN (802.11b/g/n)	X	X	O	O	X	X

Table 1.4 Determined EUT sides for SAR Testing

Note: Particular DUT edges were not required to be evaluated for SAR based on the SAR exclusion threshold in KDB 447498 D01v05r02.

1.7 Power Reduction for SAR

There is no power reduction used for any band/mode implemented in this device for SAR purposes.

1.8 Device Serial Numbers

Band & Mode	Serial Number
GPRS 850	FCC #1
GPRS 1900	FCC #1
WCDMA 850	FCC #1
WCDMA 1900	FCC #1
2.4 GHz WLAN	FCC #1

2. INTROCUCTION

The FCC and Industry Canada have adopted the guidelines for evaluating the environmental effects of radio frequency (RF) radiation in ET Docket 93-62 on Aug. 6, 1996 and Health Canada Safety Code 6 to protect the public and workers from the potential hazards of RF emissions due to FCC-regulated portable devices.

The FCC has adopted the guidelines for evaluating the environmental effects of radio frequency radiation in ET Docket 93-62 on Aug. 6, 1996 to protect the public and workers from the potential hazards of RF emissions due to FCC-regulated portable devices. The safety limits used for the environmental evaluation measurements are based on the criteria published by the American National Standards Institute (ANSI) for localized specific absorption rate (SAR) in IEEE/ANSI C95*.1-2005 Standard for Safety Levels with Respect to Human Exposure to Radio Frequency Electromagnetic Fields, 3 kHz to 300 GHz. 1992 by the Institute of Electrical and Electronics Engineers, Inc., New York, New York 10017. The measurement procedure described in IEEE/ANSI C95.3-1992 Recommended Practice for the Measurement of Potentially Hazardous Electromagnetic Fields - RF and Microwave is used for guidance in measuring SAR due to the RF radiation exposure from the Equipment Under Test (EUT). These criteria for SAR evaluation are similar to those recommended by the National Council on Radiation Protection and Measurements (NCRP) in Biological Effects and Exposure Criteria for Radio frequency Electromagnetic Fields," NCRP Report No. 86 NCRP, 1986, Bethesda, MD 20814. SAR is a measure of the rate of energy absorption due to exposure to an RF transmitting source. SAR values have been related to threshold levels for potential biological hazards.

SAR Definition

Specific Absorption Rate (SAR) is defined as the time derivative (rate) of the incremental energy (dU) absorbed by (dissipated in) an incremental mass (dm) contained in a volume element (dV) of a given density (ρ) It is also defined as the rate of RF energy absorption per unit mass at a point in an absorbing body (see Fig. 2.1)

$$SAR = \frac{d}{dt} \left(\frac{dU}{dm} \right) = \frac{d}{dt} \left(\frac{dU}{\rho dv} \right)$$

Fig. 2.1 SAR Mathematical Equation

SAR is expressed in units of Watts per Kilogram (W/kg).

$$SAR = \frac{\sigma \cdot E^2}{\rho}$$

where:

- σ = conductivity of the tissue-simulating material (S/m)
- ρ = mass density of the tissue-simulating material (kg/m^3)
- E = Total RMS electric field strength (V/m)

NOTE: The primary factors that control rate of energy absorption were found to be the wavelength of the incident field in relations to the dimensions and geometry of the irradiated organism, the orientation of the organism in relation to the polarity of field vectors, the presence of reflecting surfaces, and whether conductive contact is made by the organism with a ground plane.

3. DESCRIPTION OF TEST EQUIPMENT

3.1 SAR MEASUREMENT SETUP

Measurements are performed using the DASY5 automated dosimetric assessment system. The DASY5 is made by Schmid & Partner Engineering AG (SPEAG) in Zurich, Switzerland and consists of high precision robotics system (Staubli), robot controller, desktop computer, near-field probe, probe alignment sensor, and the generic twin phantom containing the brain equivalent material. The robot is a six-axis industrial robot performing precise movements to position the probe to the location (points) of maximum electromagnetic field (EMF) (see Fig. 3.1).

A cell controller system contains the power supply, robot control left each pendant (Joystick), and a remote control used to drive the robot motors. The PC consists of the Intel Core i7-3770 3.40 GHz desktop computer with Windows 7 system and SAR Measurement Software DASY5, A/D interface card, monitor, mouse, and keyboard. The Staubli Robot is connected to the cell controller to allow software manipulation of the robot. A data acquisition electronic (DAE) circuit that performs the signal amplification, signal multiplexing, AD-conversion, offset measurements, mechanical surface detection, collision detection, etc. is connected to the Electro-optical coupler (EOC). The EOC performs the conversion from the optical into digital electric signal of the DAE and transfers data to the PC plug-in card.

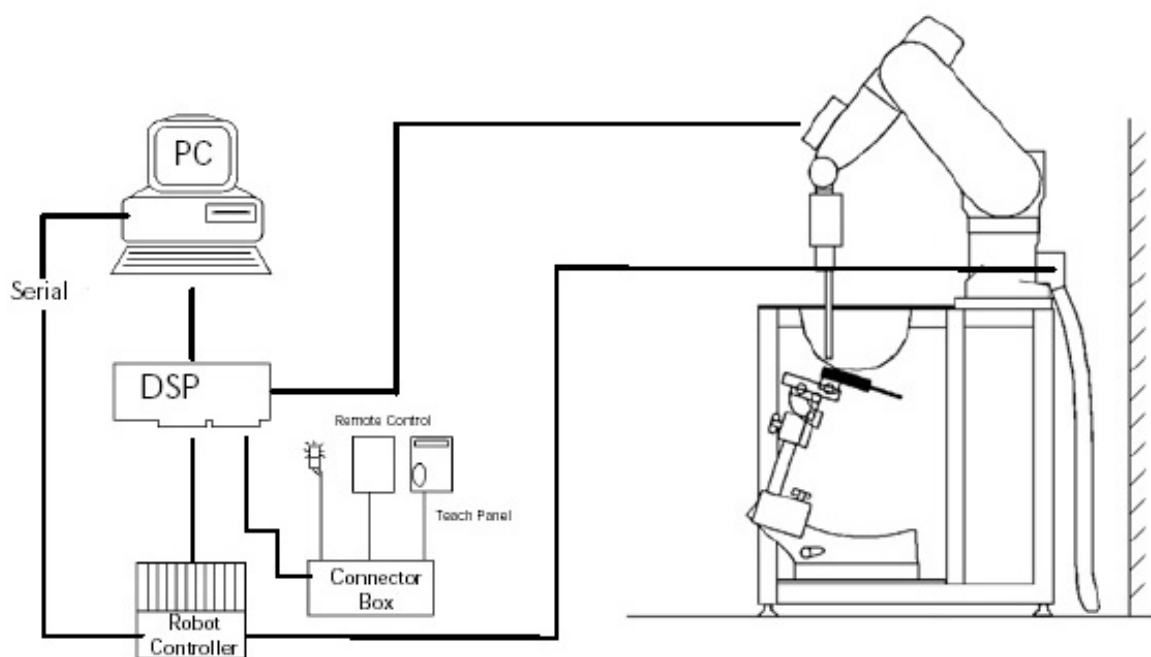

Figure 3.1 SAR Measurement System Setup

The DAE4 consists of a highly sensitive electrometer-grade preamplifier with auto-zeroing, a channel and gain-switching multiplexer, a fast 16 bit AD-converter and a command decoder and control logic unit. Transmission to the PC-card is accomplished through an optical downlink for data and status information and an optical uplink for commands and clock lines. The mechanical probe mounting device includes two different sensor systems for frontal and sidewise probe contacts. They are also used for mechanical surface detection and probe collision detection. The robot uses its own controller with a built in VME-bus computer. The system is described in detail.

3.2 EX3DV4Probe Specification

Calibration	In air from 10 MHz to 6 GHz In brain and muscle simulating tissue at Frequencies of 300 MHz, 450 MHz, 600 MHz, 750 MHz, 835 MHz, 900 MHz, 1750 MHz, 1900 MHz, 2300 MHz, 2450 MHz, 2600 MHz, 3500 MHz, 5200 MHz, 5300 MHz, 5500 MHz, 5600 MHz, 5800 MHz
Frequency	10 MHz to 6 GHz
Linearity	± 0.2 dB(30 MHz to 6 GHz)
Dynamic	10 μ W/g to > 100 mW/g
Range	Linearity : ± 0.2 dB
Dimensions	Overall length : 337 mm
Tip length	20 mm
Body diameter	12 mm
Tip diameter	2.5 mm
Distance from probe tip to sensor center	1.0 mm
Application	SAR Dosimetry Testing Compliance tests of mobile phones

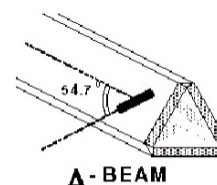

Figure 3.2 Triangular Probe Configurations



Figure 3.3 Probe Thick-Film Technique



DAE System

The SAR measurements were conducted with the dosimetric probe EX3DV4, designed in the classical triangular configuration (see Fig. 3.2) and optimized for dosimetric evaluation. The probe is constructed using the thick film technique; with printed resistive lines on ceramic substrates. The probe is equipped with an optical multitier line ending at the front of the probe tip. It is connected to the EOC box on the robot arm and provides an automatic detection of the phantom surface. Half of the fibers are connected to a pulsed infrared transmitter, the other half to a synchronized receiver. As the probe approaches the surface, the reflection from the surface produces a coupling from the transmitting to the receiving fibers. This reflection increases first during the approach, reaches maximum and then decreases. If the probe is flatly touching the surface, the coupling is zero. The distance of the coupling maximum to the surface is independent of the surface reflectivity and largely independent of the surface to probe angle. The DASY5 software reads the reflection during a software approach and looks for the maximum using a 2nd order fitting. The approach is stopped at reaching the maximum.

3.3 Probe Calibration Process

3.3.1 E-Probe Calibration

Dosimetric Assessment Procedure

Each probe is calibrated according to a dosimetric assessment procedure with accuracy better than +/- 10%. The spherical isotropy was evaluated with the procedure and found to be better than +/-0.25dB. The sensitivity parameters (Norm X, Norm Y, Norm Z), the diode compression parameter (DCP) and the conversion factor (Conv F) of the probe is tested.

Free Space Assessment

The free space E-field from amplified probe outputs is determined in a test chamber. This is performed in a TEM cell for frequencies below 1 GHz, and in a waveguide above 1GHz for free space. For the free space calibration, the probe is placed in the volumetric center of the cavity at the proper orientation with the field. The probe is then rotated 360 degrees.

Temperature Assessment *

E-field temperature correlation calibration is performed in a flat phantom filled with the appropriate simulated brain tissue. The measured free space E-field in the medium, correlates to temperature rise in a dielectric medium. For temperature correlation calibration a RF transparent the remits or based temperature probe is used in conjunction with the E-field probe.

$$SAR = C \frac{\Delta T}{\Delta t}$$

where:

- Δt = exposure time (30 seconds),
- C = heat capacity of tissue (brain or muscle),
- ΔT = temperature increase due to RF exposure.

$$SAR = \frac{|E|^2 \cdot \sigma}{\rho}$$

where:

- σ = simulated tissue conductivity,
- ρ = Tissue density (1.25 g/cm³ for brain tissue)

SAR is proportional to $\Delta T / \Delta t$, the initial rate of tissue heating, before thermal diffusion takes place. Now it's possible to quantify the electric field in the simulated tissue by equating the thermally derived SAR to the E- field;

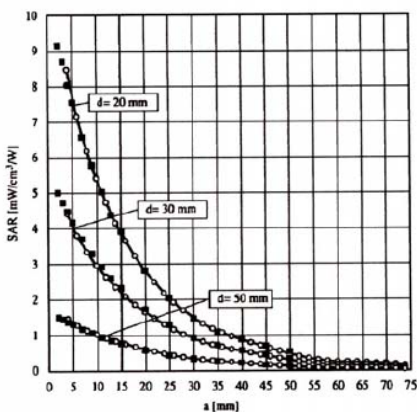

Figure 3.4 E-Field and Temperature Measurements at 900MHz Measurements at 1800MHz

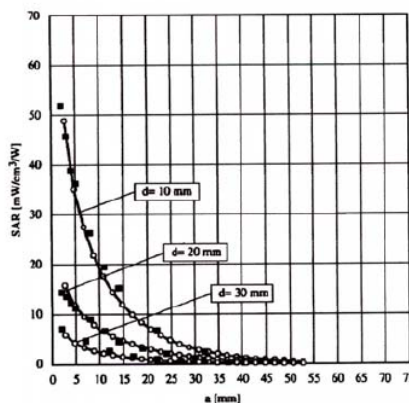

Figure 3.5 E-Field and Temperature

3.4 Data Extrapolation

The DASYS5 software automatically executes the following procedures to calculate the field units from the microvolt readings at the probe connector. The first step of the evaluation is a linearization of the filtered input signal to account for the compression characteristics of the detector diode. The compensation depends on the input signal, the diode type and the DC-transmission factor from the diode to the evaluation electronics. If the exciting field is pulsed, the crest factor of the signal must be known to correctly compensate for peak power. The formula for each channel can be given like below;

$$V_i = U_i + U_i^2 \cdot \frac{cf}{dcp_i}$$

with V_i = compensated signal of channel i (i=x,y,z)
 U_i = input signal of channel i (i=x,y,z)
 cf = crest factor of exciting field (DASY parameter)
 dcp_i = diode compression point (DASY parameter)

From the compensated input signals the primary field data for each channel can be evaluated:

E-field probes: with V_i = compensated signal of channel i (i = x,y,z)
 $Norm_i$ = sensor sensitivity of channel i (i = x,y,z)
 $\mu V/(V/m)^2$ for E-field probes
 $ConvF$ = sensitivity of enhancement in solution
 E_i = electric field strength of channel i in V/m

$$E_i = \sqrt{\frac{V_i}{Norm_i \cdot ConvF}}$$

The RSS value of the field components gives the total field strength (Hermetian magnitude):

$$E_{tot} = \sqrt{E_x^2 + E_y^2 + E_z^2}$$

The primary field data are used to calculate the derived field units.

$$SAR = E_{tot}^2 \cdot \frac{\sigma}{\rho \cdot 1000}$$

with SAR = local specific absorption rate in W/g
 E_{tot} = total field strength in V/m
 σ = conductivity in [mho/m] or [Siemens/m]
 ρ = equivalent tissue density in g/cm³

The power flow density is calculated assuming the excitation field to be a free space field.

$$P_{free} = \frac{E_{tot}^2}{3770}$$

with P_{pwe} = equivalent power density of a plane wave in W/cm²
 E_{tot} = total electric field strength in V/m

3.5 ELI PHANTOM

Phantom for compliance testing of handheld and body-mounted wireless devices in the frequency range of 30 MHz to 6 GHz. ELI is fully compatible with the IEC 62209-2 standard and all known tissue simulating liquids. ELI has been optimized regarding its performance and can be integrated into our standard phantom tables. A cover prevents evaporation of the liquid. Reference markings on the phantom allow installation of the complete setup, including all predefined phantom positions and measurement grids, by teaching three points. The phantom is compatible with all SPEAG dosimetric probes and dipoles.

ELI V5.0 has the same shell geometry and is manufactured from the same material as ELI4, but has reinforced top structure. (see fig. 3.6)



Figure 3.6 ELI Phantom

ELI Phantom Specification:

Shell Thickness	2 ± 0.2 mm (bottom plate)
Dimensions	Major axis: 600 mm Minor axis: 400 mm
Filling Volume	Approx. 30 liters

3.6 Device Holder for Transmitters

In combination with the Twin SAM Phantom V4.0/V4.0c, V5.0 or ELI the Mounting Device(See Fig. 3.7) enables the rotation of the mounted transmitter device in spherical coordinates. Rotation point is the ear opening point. Transmitter devices can be easily and accurately positioned according to IEC, IEEE, FCC or other specifications. The device holder can be locked for positioning at different phantom sections (left head, right head, flat).

Note: A simulating human hand is not used due to the complex anatomical and geometrical structure of the hand that may produce infinite number of configurations. To produce the worst-case condition (the hand absorbs antenna output power),the hand is omitted during the tests.



Figure 3.7 Mounting Device

3.7 Brain & Muscle Simulation Mixture Characterization

The brain and muscle mixtures consist of a viscous gel using hydrox-ethylcellulose (HEC) gelling agent and saline solution (see Table 3.1). Preservation with a bactericide is added and visual inspection is made to make sure air bubbles are not trapped during the mixing process. The mixture is calibrated to obtain proper dielectric constant (permittivity) and conductivity of the desired tissue. The mixture characterizations used for the brain and muscle tissue simulating liquids are according to the data by C. Gabriel and G. Harts grove.



Figure 3.8 Simulated Tissue

Table 3.1 Composition of the Tissue Equivalent Matter

Ingredients (% by weight)	Frequency (MHz)			
	835	1900	2450	5200 ~ 5800
Tissue Type	Body	Body	Body	Body
Water	50.75	70.23	73.40	80.00
Salt (NaCl)	0.940	0.290	0.060	-
Sugar	48.21	-	-	-
HEC	-	-	-	-
Bactericide	0.100	-	-	-
Triton X-100	-	-	-	-
DGBE	-	29.48	26.54	-
Diethylene glycol hexyl ether	-	-	-	-
Polysorbate (Tween) 80	-	-	-	20.00
Target for Dielectric Constant	55.2	53.3	52.7	-
Target for Conductivity (S/m)	0.97	1.52	1.95	-

Salt:	99 % Pure Sodium Chloride	Sugar:	98 % Pure Sucrose
Water:	De-ionized, 16M resistivity	HEC:	Hydroxyethyl Cellulose
DGBE:	99 % Di(ethylene glycol) butyl ether,[2-(2-butoxyethoxy) ethanol]		
Triton X-100(ultra pure):	Polyethylene glycol mono[4-(1,1,3,3-tetramethylbutyl)phenyl] ether		

3.8 SAR TEST EQUIPMENT

Table 3.2 Test Equipment Calibration

	Type	Manufacturer	Model	Cal.Date	Next.Cal.Date	S/N
<input checked="" type="checkbox"/>	SEMITEC Engineering	SEMITEC	N/A	N/A	N/A	Shield Room
<input checked="" type="checkbox"/>	Robot	SCHMID	TX90XL	N/A	N/A	F13/5P9GA1/A/01
<input checked="" type="checkbox"/>	Robot Controller	SCHMID	C58C	N/A	N/A	F13/5P9GA1/C/01
<input checked="" type="checkbox"/>	Joystick	SCHMID	N/A	N/A	N/A	S-12450905
<input checked="" type="checkbox"/>	Intel Core i7-3770 3.40 GHz Windows 7 Professional	N/A	N/A	N/A	N/A	N/A
<input checked="" type="checkbox"/>	Probe Alignment Unit LB	N/A	N/A	N/A	N/A	SE UKS 030 AA
<input checked="" type="checkbox"/>	Mounting Device	SCHMID	Holder	N/A	N/A	SD000H01KA
<input checked="" type="checkbox"/>	Laptop Holder	SCHMID	SMLH1001CD	N/A	N/A	N/A
<input type="checkbox"/>	Twin SAM Phantom	SCHMID	QD000P40CD	N/A	N/A	1785
<input type="checkbox"/>	Twin SAM Phantom	SCHMID	QD000P40CD	N/A	N/A	1786
<input checked="" type="checkbox"/>	2mm Oval Phantom ELI5	SCHMID	QDIVA001BB	N/A	N/A	1223
<input checked="" type="checkbox"/>	Data Acquisition Electronics	SCHMID	DAE4V1	2014-11-05	2015-11-05	1453
<input checked="" type="checkbox"/>	Dosimetric E-Field Probe	SCHMID	EX3DV4	2014-09-22	2015-09-22	3933
<input checked="" type="checkbox"/>	835MHz SAR Dipole	SCHMID	D835V2	2014-11-19	2016-11-19	4d159
<input checked="" type="checkbox"/>	1900MHz SAR Dipole	SCHMID	D1900V2	2014-11-14	2016-11-14	5d176
<input checked="" type="checkbox"/>	2450MHz SAR Dipole	SCHMID	D2450V2	2014-11-19	2016-11-19	920
<input type="checkbox"/>	5GHz SAR Dipole	SCHMID	D5GHzV2	2015-03-23	2017-03-23	1103
<input checked="" type="checkbox"/>	Network Analyzer	Agilent	E5071C	2014-12-19	2015-12-19	MY46111534
<input checked="" type="checkbox"/>	Signal Generator	Agilent	E4438C	2014-09-12	2015-09-12	US41461520
<input checked="" type="checkbox"/>	Amplifier	EMPOWER	BBS3Q7ELU	2014-09-12	2015-09-12	1020
<input type="checkbox"/>	High Power RF Amplifier	EMPOWER	BBS3Q8CCJ	2014-10-20	2015-10-20	1005
<input checked="" type="checkbox"/>	Power Meter	HP	EPM-442A	2015-02-26	2016-02-26	GB37170267
<input checked="" type="checkbox"/>	Power Meter	Anritsu	ML2495A	2014-10-07	2015-10-07	1435003
<input checked="" type="checkbox"/>	Wide Bandwidth Power Sensor	Anritsu	MA2490A	2014-10-07	2015-10-07	1409034
<input checked="" type="checkbox"/>	Power Sensor	HP	8481A	2015-02-26	2016-02-26	3318A96566
<input checked="" type="checkbox"/>	Power Sensor	HP	8481A	2015-02-06	2016-02-06	2702A65976
<input checked="" type="checkbox"/>	Dual Directional Coupler	Agilent	778D-012	2015-01-06	2016-01-06	50228
<input checked="" type="checkbox"/>	Directional Coupler	HP	773D	2014-06-27	2015-06-27	2389A00640
				2015-06-26	2016-06-26	
<input checked="" type="checkbox"/>	Low Pass Filter 1.5GHz	Micro LAB	LA-15N	2014-09-11	2015-09-11	N/A
<input checked="" type="checkbox"/>	Low Pass Filter 3.0GHz	Micro LAB	LA-30N	2014-09-11	2015-09-11	N/A
<input type="checkbox"/>	Low Pass Filter 6.0GHz	Micro LAB	LA-60N	2015-02-25	2016-02-25	03942
<input checked="" type="checkbox"/>	Attenuators(3 dB)	Agilent	8491B	2014-06-27	2015-06-27	MY39260700
				2015-06-26	2016-06-26	
<input checked="" type="checkbox"/>	Attenuators(10 dB)	WEINSCHTEL	23-10-34	2015-01-06	2016-01-06	BP4387
<input type="checkbox"/>	Step Attenuator	HP	8494A	2014-09-11	2015-09-11	3308A33341
<input checked="" type="checkbox"/>	Dielectric Probe kit	SCHMID	DAK-3.5	2014-12-09	2015-12-09	1092
<input checked="" type="checkbox"/>	8960 Series 10 Wireless Comms. Test Set	Agilent	E5515C	2014-09-12	2015-09-12	GB41321164
<input checked="" type="checkbox"/>	Power Splitter	Anritsu	K241B	2014-10-21	2015-10-21	1701102
<input checked="" type="checkbox"/>	Bluetooth Tester	TESCOM	TC-3000B	2014-06-26	2015-06-26	3000B640046
				2015-06-26	2016-06-26	

NOTE: The E-field probe was calibrated by SPEAG, by temperature measurement procedure. Dipole Verification measurement is performed by DT&C before each test. The brain and muscle simulating material are calibrated by DT&C using the dielectric probe system and network analyzer to determine the conductivity and permittivity (dielectric constant) of the brain-equivalent material. Each equipment item was used solely within its respective calibration period.

4. TEST SYSTEM SPECIFICATIONS

Automated TEST SYSTEM SPECIFICATIONS:

Positioner

Robot	Stäubli Unimation Corp. Robot Model: TX90XL
Repeatability	0.02 mm
No. of axis	6

Data Acquisition Electronic (DAE) System

Cell Controller

Processor	Intel Core i7-3770
Clock Speed	3.40 GHz
Operating System	Windows 7 Professional
Data Card	DASY5 PC-Board

Data Converter

Features	Signal, multiplexer, A/D converter. & control logic
Software	DASY5
Connecting Lines	Optical downlink for data and status info Optical uplink for commands and clock

PC Interface Card

Function	24 bit (64 MHz) DSP for real time processing Link to DAE 4 16 bit A/D converter for surface detection system serial link to robot direct emergency stop output for robot
-----------------	--

E-Field Probes

Model	EX3DV4 S/N: 3933
Construction	Triangular core fiber optic detection system
Frequency	10 MHz to 6 GHz
Linearity	± 0.2 dB (30 MHz to 6 GHz)

Phantom

Phantom	ELI Phantom (V5.0)
Shell Material	Composite
Thickness	2 ± 0.2 mm (bottom plate)



Figure 2.2 DASY5 Test System

5. SAR MEASUREMENT PROCEDURE

5.1 Measurement Procedure

The evaluation was performed using the following procedure compliant to FCC KDB Publication 865664 D01v01r04 and IEEE 1528-2013:

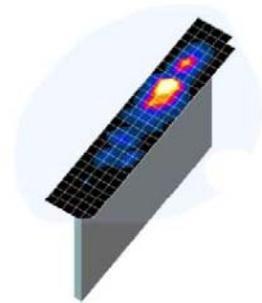

Figure 5.1
Sample SAR Area Scan

1. The SAR distribution at the exposed side of the head or body was measured at a distance no greater than 5.0 mm from the inner surface of the shell. The area covered the entire dimension of the device-head and body interface and the horizontal grid resolution was determined per FCC KDB Publication 865664 D01v01r04 (See Table 5-1) and IEEE1528-2013.
2. The point SAR measurement was taken at the maximum SAR region determined from Step 1 to enable the monitoring of SAR fluctuations /drifts during the 1g/10g cube evaluation. SAR at this fixed point was measured and used as a reference value.
3. Based on the area scan data, the peak of the region with maximum SAR was determined by spline interpolation. Around this point, a volume was assessed according to the measurement resolution and volume size requirements of FCC KDB Publication 865664 D01v01r04 (See Table 5-1) and IEEE 1528-2013. On the basis of this data set, the spatial peak SAR value was evaluated with the following procedure (see references or the DASY manual online for more details):
 - a. SAR values at the inner surface of the phantom are extrapolated from the measured values along the line away from the surface with spacing no greater than that in Table 3-1. The extrapolation was based on a least-squares algorithm. A polynomial of the fourth order was calculated through the points in the z-axis (normal to the phantom shell).
 - b. After the maximum interpolated values were calculated between the points in the cube, the SAR was averaged over the spatial volume (1g or 10g) using a 3D-Spline interpolation algorithm. The 3D-spline is composed of three one-dimensional splines with the “Not a knot” condition (in x, y, and z directions). The volume was then integrated with the trapezoidal algorithm. One thousand points (10 x 10 x 10) were obtained through interpolation, in order to calculate the averaged SAR.
 - c. All neighboring volumes were evaluated until no neighboring volume with a higher average value was found.
4. The SAR reference value, at the same location as step 2, was re-measured after the zoom scan was complete to calculate the SAR drift. If the drift deviated by more than 5%, the SAR test and drift measurements were repeated.

Frequency	Maximum Area Scan Resolution (mm) (Δx_{area} , Δy_{area})	Maximum Zoom Scan Resolution (mm) (Δx_{zoom} , Δy_{zoom})	Maximum Zoom Scan Spatial Resolution (mm)			Minimum Zoom Scan Volume (mm) (x,y,z)
			Uniform Grid	Graded Grid		
				$\Delta z_{zoom}(n)$	$\Delta z_{zoom}(1)^*$	
≤ 2 GHz	≤ 15	≤ 8	≤ 5	≤ 4	$\leq 1.5 * \Delta z_{zoom}(n-1)$	≥ 30
2-3 GHz	≤ 12	≤ 5	≤ 5	≤ 4	$\leq 1.5 * \Delta z_{zoom}(n-1)$	≥ 30
3-4 GHz	≤ 12	≤ 5	≤ 4	≤ 3	$\leq 1.5 * \Delta z_{zoom}(n-1)$	≥ 28
4-5 GHz	≤ 10	≤ 4	≤ 3	≤ 2.5	$\leq 1.5 * \Delta z_{zoom}(n-1)$	≥ 25
5-6 GHz	≤ 10	≤ 4	≤ 2	≤ 2	$\leq 1.5 * \Delta z_{zoom}(n-1)$	≥ 22

Table 5.1 Area and Zoom Scan Resolutions per FCC KDB Publication 865664 D01v01r04*

*Also compliant to IEEE 1528-2013 Table 6

6. TEST CONFIGURATION POSITIONS FOR HANDSETS

6.1 Device Holder

The device holder is made out of low-loss POM material having the following dielectric parameters: relative permittivity $\epsilon = 3$ and loss tangent $\delta = 0.02$.

6.2 Head Exposure Configurations

Transmitters that are built-in within a wrist watch or similar wrist-worn devices typically operate in speaker mode for voice communication, with the device worn on the wrist and positioned next to the mouth. Next to the mouth exposure requires 1-g SAR, and the wrist-worn condition requires 10-g extremity SAR. The 10-g extremity and 1-g SAR test exclusions may be applied to the wrist and face exposure conditions. When SAR evaluation is required, next to the mouth use is evaluated with the front of the device positioned at 10 mm from a flat phantom filled with head tissue-equivalent medium. The face exposure condition procedures in FCC KDB Publication 447498 D01v05r02 should be used to test for face exposure condition SAR compliance.

6.3 Extremity Exposure Configurations

Devices that are designed or intended for use on extremities or mainly operated in extremity only exposure conditions; i.e., hands, wrists, feet and ankles, may require extremity SAR evaluation. When the device also operates in close proximity to the user's body, SAR compliance for the body is also required. The 1-g body and 10-g extremity SAR Exclusion Thresholds found in KDB Publication 447498 D01v05r02 should be applied to determine SAR test requirements.

7. RF EXPOSURE LIMITS

Uncontrolled Environment:

UNCONTROLLED ENVIRONMENTS are defined as locations where there is the exposure of individuals who have no knowledge or control of their exposure. The general population/uncontrolled exposure limits are applicable to situations in which the general public may be exposed or in which persons who are exposed as a consequence of their employment may not be made fully aware of the potential for exposure or cannot exercise control over their exposure. Members of the general public would come under this category when exposure is not employment-related; for example, in the case of a wireless transmitter that exposes persons in its vicinity.

Controlled Environment:

CONTROLLED ENVIRONMENTS are defined as locations where there is exposure that may be incurred by persons who are aware of the potential for exposure, (i.e. as a result of employment or occupation). In general, occupational/controlled exposure limits are employment, who have been made fully aware of the potential for exposure and can exercise control over their exposure. This exposure category is also applicable when the exposure is of a transient nature due to incidental passage through a location where the exposure levels may be higher than the general population/uncontrolled limits, but the exposed person is fully aware of the potential for exposure and can exercise control over his or her exposure by leaving the area or by some other appropriate means.

Table 7.1.SAR Human Exposure Specified in ANSI/IEEE C95.1-2005

	HUMAN EXPOSURE LIMITS	
	General Public Exposure (W/kg) or (mW/g)	Occupational Exposure (W/kg) or (mW/g)
SPATIAL PEAK SAR * (Brain)	1.60	8.00
SPATIAL AVERAGE SAR ** (Whole Body)	0.08	0.40
SPATIAL PEAK SAR *** (Hands / Feet / Ankle / Wrist)	4.00	20.0

1. The Spatial Peak value of the SAR averaged over any 1 gram of tissue (defined as a tissue volume in the shape of a cube) and over the appropriate averaging time.
2. The Spatial Average value of the SAR averaged over the whole body.
3. The Spatial Peak value of the SAR averaged over any 10 grams of tissue (defined as a tissue volume in the shape of a cube) and over the appropriate averaging time.

Uncontrolled Environments are defined as locations where there is the exposure of individuals who have no knowledge or control of their exposure.

Controlled Environments are defined as locations where there is exposure that may be incurred by persons who are aware of the potential for exposure, (i.e.as a result of employment or occupation).

8. FCC MEASUREMENT PROCEDURES

Power measurements were performed using a base station simulator under digital average power.

8.1 Measured and Reported SAR

Per FCC KDB Publication 447498 D01v05r02, When SAR is not measured at the maximum power level allowed for production units, the results must be scaled to the maximum tune-up tolerance limit according to the power applied to the individual channels tested to determine compliance. For simultaneous transmission, the measured aggregate SAR must be scaled according to the sum of the differences between the maximum tune-up tolerance and actual power used to test each transmitter. When SAR is measured at or scaled to the maximum tune-up tolerance limit, the results are referred to as reported SAR. The highest reported SAR results are identified on the grant of equipment authorization according to procedures in KDB 690783 D01v01r03.

8.2 Procedures Used to Establish RF Signal for SAR

The following procedures are according to FCC KDB Publication 941225 D01 "3G SAR Procedures" v03, October 16, 2014.

The device was placed into a simulated call using a base station simulator in a RF shielded chamber. Establishing connections in this manner ensure a consistent means for testing SAR and are recommended for evaluating SAR [4]. Devices under test were evaluated prior to testing, with a fully charged battery and were configured to operate at maximum output power. In order to verify that the device was tested throughout the SAR test at maximum output power, the SAR measurement system measures a "point SAR" at an arbitrary reference point at the start and end of the 1 gram SAR evaluation, to assess for any power drifts during the evaluation. If the power drift deviated by more than 5%, the SAR test and drift measurements were repeated.

8.3 SAR Measurement Conditions for WCDMA (UMTS)

8.3.1 Output Power Verification

Maximum output power is measured on the High, Middle and Low channels for each applicable transmission band according to the general descriptions in section 5.2 of 3GPP TS 34.121, using the appropriate RMC or AMR with TPC (transmit power control) set to all "1s".

Maximum output power is verified on the High, Middle and Low channels according to the general, descriptions in section 5.2 of 3GPP TS 34.121 (release 5), using the appropriate RMC with TPC,(transmit power control) set to all "1s" or applying the required inner loop power control procedures to maintain maximum output power while HSUPA is active. Results for all applicable physical channel configurations (DPCCH, DPDCHn and spreading codes, HS-DPCCH etc) are tabulated in this test report. All configurations that are not supported by the DUT or cannot be measured due to technical or equipment limitations are identified.

8.3.2 SAR Measurements for Handsets with Rel 5 HSDPA

Body SAR for HSDPA is not required for handsets with HSDPA capabilities when the maximum average output power of each RF channel with HSDPA active is less than 0.25 dB higher than that measured without HSDPA using 12.2 kbps RMC and the maximum SAR for 12.2 kbps RMC is $\leq 75\%$ of the SAR limit. Otherwise, SAR is measured for HSDPA, using an FRC with H-Set 1 in Sub-test 1 and a 12.2 kbps RMC configured in Test Loop Mode 1, using the highest body SAR configuration measured in 12.2 kbps RMC without HSDPA, on the maximum output channel with the body exposure configuration that resulted in the highest SAR in 12.2 kbps RMC mode for that RF channel.

The H-set used in FRC for HSDPA should be configured according to the UE category of a test device. The number of HS-DSCH/HSPDSCHs, HARQ processes, minimum inter-TTI interval, transport block sizes and RV coding sequence are defined by the applicable H-set. To maintain a consistent test configuration and stable transmission conditions, QPSK is used in the FRC for SAR testing. HS-DPCCH should be configured with a CQI feedback cycle of 2 ms to maintain a constant rate of active CQI slots. DPCCH and DPDCH gain factors of $\beta_c=9$ and $\beta_d=15$, and power offset parameters of $\Delta_{ACK} = \Delta_{NACK} = 5$ and $\Delta_{CQI}=2$ is used. The CQI value is determined by the UE category, transport block size, number of HS-PDSCHs and modulation used in the FRC.

Sub-test	β_c (Note 5)	β_d	β_d (SF)	β_c/β_d	β_{HS} (Note 1, Note 2)	CM (dB) (Note 3)	MPR (dB) (Note 3)
1	2/15	15/15	64	2/15	4/15	0.0	0.0
2	12/15 (Note 4)	15/15 (Note 4)	64	12/15 (Note 4)	24/15	1.0	0.0
3	15/15	8/15	64	15/8	30/15	1.5	0.5
4	15/15	4/15	64	15/4	30/15	1.5	0.5

Note 1: Δ_{ACK} , Δ_{NACK} and $\Delta_{CQI} = 30/15$ with $\beta_{hs} = 30/15 * \beta_c$.

Note 2: For the HS-DPCCH power mask requirement test in clause 5.2C, 5.7A, and the Error Vector Magnitude (EVM) with HS-DPCCH test in clause 5.13.1A, and HSDPA EVM with phase discontinuity in clause 5.13.1AA, Δ_{ACK} and $\Delta_{NACK} = 30/15$ with $\beta_{hs} = 30/15 * \beta_c$, and $\Delta_{CQI} = 24/15$ with $\beta_{hs} = 24/15 * \beta_c$.

Note 3: CM = 1 for $\beta_c/\beta_d = 12/15$, $\beta_{hs}/\beta_c = 24/15$. For all other combinations of DPDCH, DPCCH and HS-DPCCH the MPR is based on the relative CM difference. This is applicable for only UEs that support HSDPA in release 6 and later releases.

Note 4: For subtest 2 the β_c/β_d ratio of 12/15 for the TFC during the measurement period (TF1, TF0) is achieved by setting the signalled gain factors for the reference TFC (TF1, TF1) to $\beta_c = 11/15$ and $\beta_d = 15/15$.

Figure 8.1 Table C.10.1.4 of TS 234.121-1

8.3.3 SAR Measurements for Handsets with Rel 6 HSUPA

Body SAR for HSUPA is not required when the maximum average output of each RF channel with HSUPA/HSDPA active is less than 0.25 dB higher than as measured without HSUPA/HSDPA using 12.2 kbps RMC and maximum SAR for 12.2 kbps RMC is $\leq 75\%$ of the SAR limit. Otherwise SAR is measured on the maximum output channel for the body exposure configuration produced highest SAR in 12.2 kbps RMC for that RF channel, using the additional procedures under "Release 6 HSPA data devices"

Head SAR for VOIP operations under HSPA is not required when maximum average output of each RF channel with HSPA is less than 0.25 dB higher than as measured using 12.2 kbps RMC. Otherwise SAR is measured using same HSPA configuration as used for body SAR.

Sub-test	β_c (Note 7)	β_d	β_d (SF)	β_c/β_d	β_{HS} (Note 1)	β_{ec}	β_{ed} (Note 4) (Note 5)	β_{ed} (SF)	β_{ed} (Codes)	CM (dB) (Note 2)	MPR (dB) (Note 2) (Note 6)	AG Index (Note 5)	E- TFCI
1	11/15 (Note 3)	15/15 (Note 3)	64	11/15 (Note 3)	22/15	209/25	1309/225	4	1	1.0	0.0	20	75
2	6/15	15/15	64	6/15	12/15	12/15	94/75	4	1	3.0	2.0	12	67
3	15/15	9/15	64	15/9	30/15	30/15	β_{ed1} : 47/15 β_{ed2} : 47/15	4 4	2	2.0	1.0	15	92
4	2/15	15/15	64	2/15	4/15	2/15	56/75	4	1	3.0	2.0	17	71
5	15/15	0	-	-	5/15	5/15	47/15	4	1	1.0	0.0	12	67

Note 1: For sub-test 1 to 4, Δ_{ACK} , Δ_{NACK} and $\Delta_{CQI} = 30/15$ with $\beta_{HS} = 30/15 * \beta_c$. For sub-test 5, Δ_{ACK} , Δ_{NACK} and $\Delta_{CQI} = 5/15$ with $\beta_{HS} = 5/15 * \beta_c$.

Note 2: CM = 1 for $\beta_c/\beta_d = 12/15$, $\beta_{HS}/\beta_c = 24/15$. For all other combinations of DPDCH, DPCCH, HS- DPCCH, E-DPDCH and E-DPCCH the MPR is based on the relative CM difference.

Note 3: For subtest 1 the β_c/β_d ratio of 11/15 for the TFC during the measurement period (TF1, TF0) is achieved by setting the signalled gain factors for the reference TFC (TF1, TF0) to $\beta_c = 10/15$ and $\beta_d = 15/15$.

Note 4: In case of testing by UE using E-DPDCH Physical Layer category 1, Sub-test 3 is omitted according to TS25.306 Table 5.1g.

Note 5: β_{ed} can not be set directly; it is set by Absolute Grant Value.

Note 6: For subtests 2, 3 and 4, UE may perform E-DPDCH power scaling at max power which could results in slightly smaller MPR values.

Note 7: For CLTD Mode 1 test cases power is equally distributed between both the antenna ports.

Figure 8.2 Table C.10.1.4 of TS 134 121-1

8.4 SAR Testing with 802.11 Transmitters

Normal network operating configurations are not suitable for measuring the SAR of 802.11 b/g/n transmitters. Unpredictable fluctuations in network traffic and antenna diversity conditions can introduce undesirable variations in SAR results. The SAR for these devices should be measured using chipset based test mode software to ensure the results are consistent and reliable. See KDB Publication 248227 D01v02r01 for more details.

8.4.1 General Device Setup

Chipset based test mode software is hardware dependent and generally varies among manufacturers. The device operating parameters established in test mode for SAR measurements must be identical to those programmed in production units, including output power levels, amplifier gain settings and other RF performance tuning parameters. The test frequencies should correspond to actual channel frequencies defined for domestic use. SAR for devices with switched diversity should be measured with only one antenna transmitting at a time during each SAR measurement, according to a fixed modulation and data rate. The same data pattern should be used for all measurements.

A periodic duty factor is required for current generation SAR systems to measure SAR. When 802.11 frame gaps are accounted for in the transmission, a maximum transmission duty factor of 92 - 96 % is typically achievable in most test mode configurations. A minimum transmission duty factor of 85% is required to avoid certain hardware and device implementation issues related to wide range SAR scaling. The reported SAR is scaled to 100% transmission duty factor to determine compliance at the maximum tune-up tolerance limit.

8.4.2 Initial Test Position Procedure

For exposure conditions with multiple test positions, such as handset operating next to the ear, devices with hotspot mode, procedures for initial test position can be applied. Using the transmission mode determined by the DSSS procedure or initial test configuration, area scans are measured for all position in an exposure condition. The test position with the highest extrapolated (peak) SAR is used as the initial test position. When reported SAR for the initial test position is ≤ 0.4 W/kg, no additional testing for the remaining test positions is required. Otherwise, SAR is evaluated at the subsequent highest peak SAR position until the reported SAR result is ≤ 0.8 W/kg or all test position are measured.

8.4.3 2.4 GHz SAR Test Requirements

SAR is measured for 2.4 GHz 802.11b DSSS using either a fixed test position or, when applicable, the initial test position procedure. SAR test reduction is determined according to the following:

- 1) When the reported SAR of the highest measured maximum output power channel for the exposure configuration is ≤ 0.8 W/kg, no further SAR testing is required for 802.11b DSSS in that exposure configuration.
- 2) When the reported SAR is > 0.8 W/kg, SAR is required for that exposure configuration using the next highest measured output power channel. When any reported SAR is > 1.2 W/kg, SAR is required for the third channel; i.e., all channels require testing.

2.4 GHz 802.11 g/n OFDM are additionally evaluated for SAR if the highest reported SAR for 802.11b, adjusted by the ratio of the OFDM to DSSS specified maximum output power is > 1.2 W/kg. When SAR is required for OFDM modes in 2.4 GHz band, the Initial Test Configuration Procedures should be followed.

8.4.4 OFDM Transmission Mode and SAR Test Channel Selection

For the 2.4 GHz bands, when the same maximum output power was specified for multiple OFDM transmission mode configurations in a frequency band or aggregated band, SAR is measured using the configuration with the largest channel bandwidth, lowest order modulation and lowest data rate. When the maximum output power of a channel is the same for equivalent OFDM configurations; for example, 802.11n with the same channel bandwidth, modulation and data rate etc., the lower order 802.11 mode i.e., 802.11g then 802.11n is used for SAR measurement. When the maximum output power were the same for multiple test channels, either according to the default or additional power measurement requirements, SAR is measured using the channel closest to the middle of the frequency band or aggregated band. When there are multiple channels with the same maximum output power, SAR is measured using the higher number channel.

8.4.5 Initial Test Configuration Procedure

For OFDM, in both 2.4 bands, an initial test configuration is determined for each frequency band and aggregated band, according to the transmission mode with the highest maximum output power specified for SAR measurements. When the same maximum output is specified for multiple OFDM transmission mode configurations in a frequency band or aggregated band, SAR is measured using the configuration(s) with the largest channel bandwidth, lowest order modulation, and lowest data rate. The channel of the transmission mode with the highest average RF output conducted power will be the initial test configuration.

8.4.6 Subsequent Test Configuration Procedures

For OFDM configurations, in each frequency band and aggregated band, SAR is evaluated for initial test configuration using the fixed test position or the initial test position procedure, when applicable. When the highest reported SAR for the initial test configuration, adjusted by the ratio of the subsequent test configuration to initial test configuration specified maximum output power is ≤ 1.2 W/kg, no additional SAR testing for the subsequent test configurations is required.

9. RF CONDUCTED POWERS

9.1 GSM Conducted Powers

Table 10.1 The power was measured by E5515C

Band	Channel	Maximum Burst-Averaged Output Power (dBm)							
		GPRS/EDGE Data (GMSK)				EDGE Data (8-PSK)			
		GPRS 1 TX Slot	GPRS 2 TX Slot	GPRS 3 TX Slot	GPRS 4 TX Slot	EDGE 1 TX Slot	EDGE 2 TX Slot	EDGE 3 TX Slot	EDGE 4 TX Slot
GSM850	128	32.9	30.3	28.2	26.9	26.9	23.8	22.0	21.1
	190	32.9	30.3	28.2	26.6	26.8	23.7	21.8	20.9
	251	32.8	30.2	28.1	26.6	26.8	23.7	21.9	21.6
PCS 1900	512	29.9	27.3	25.2	23.8	25.8	22.7	21.0	19.6
	661	29.7	27.0	24.7	23.3	25.7	22.5	20.9	19.5
	810	29.4	26.8	24.6	23.5	25.4	22.3	20.5	19.3
Band	Channel	Calculated Maximum Frame-Averaged Output Power (dBm)							
		GPRS/EDGE Data (GMSK)				EDGE Data (8-PSK)			
		GPRS 1 TX Slot	GPRS 2 TX Slot	GPRS 3 TX Slot	GPRS 4 TX Slot	EDGE 1 TX Slot	EDGE 2 TX Slot	EDGE 3 TX Slot	EDGE 4 TX Slot
GSM850	128	23.87	24.28	23.94	23.89	17.87	17.78	17.74	18.09
	190	23.87	24.28	23.94	23.59	17.77	17.68	17.54	17.89
	251	23.77	24.18	23.84	23.59	17.77	17.68	17.64	18.59
PCS 1900	512	20.87	21.28	20.94	20.79	16.77	16.68	16.74	16.59
	661	20.67	20.98	20.44	20.29	16.67	16.48	16.64	16.49
	810	20.37	20.78	20.34	20.49	16.37	16.28	16.24	16.29
GSM850	Frame Avg. Targets:	23.47	23.98	23.64	23.49	17.47	17.48	17.24	18.29
PCS 1900		20.47	21.28	20.74	19.49	16.47	16.48	16.24	16.49

Note:

- Both burst-averaged and calculated frame-averaged powers are included. Frame-averaged power was calculated from the measured burst-averaged power by converting the slot powers into linear units and calculating the energy over 8 timeslots.
- The source-based frame-averaged output power was evaluated for all GPRS slot configurations. The configuration with the highest target frame averaged output power was evaluated for hotspot SAR. When the maximum frame-averaged powers are equivalent across two or more slots (within 0.25 dB), the configuration with the most number of time slots was tested.
- GPRS (GMSK) output powers were measured with coding scheme setting of 1 (CS1) on the base station simulator. CS1 was configured to measure GPRS output power measurements and SAR to ensure GMSK modulation in the signal. Our investigation has shown that CS1 - CS4 settings do not have any impact on the output levels or modulation in the GPRS modes.

GPRS Multislot class: 12 (max 4 TX Uplink slots)
EDGE Multislot class: 12 (max 4 TX Uplink slots)



Figure 9.1 Power Measurement Setup

9.2 WCDMA Conducted Powers

3GPP Release Version	Mode	3GPP 34.121 Subtest	Cellular Band (dBm)			PCS Band (dBm)			3GPP MPR (dB)
			4132	4183	4233	9262	9400	9538	
99	WCDMA	12.2 kbps RMC	24.10	23.72	23.96	24.03	24.00	23.79	-
5	HSDPA	Subtest 1	24.10	23.71	23.87	24.02	23.92	23.78	0
5		Subtest 2	23.99	23.57	23.79	23.88	23.88	23.70	0
5		Subtest 3	23.65	23.19	23.43	23.49	23.49	23.29	0.5
5		Subtest 4	23.61	23.18	23.42	23.46	23.48	23.29	0.5
6	HSUPA	Subtest 1	23.96	23.58	23.79	23.89	23.97	23.69	0
6		Subtest 2	22.09	21.64	21.98	22.12	22.10	21.97	2
6		Subtest 3	22.99	22.68	22.81	22.97	22.98	22.71	1
6		Subtest 4	22.21	21.89	22.02	22.08	22.02	21.89	2
6		Subtest 5	23.99	23.67	23.89	23.86	23.93	23.67	0

Table 10.2 The power was measured by E5515C

WCDMA SAR was tested under RMC 12.2 kbps with HSPA Inactive per KDB Publication 941225 D01v03. HSPA SAR was not required since the average output power of the HSPA subtests was not more than 0.25 dB higher than the RMC level and SAR was less than 1.2 W/kg.



Figure 9.2 Power Measurement Setup

9.3 WLAN Conducted Powers

Mode	Freq.	Channel	802.11b (2.4 GHz) Conducted Power (dBm)			
			Data Rate (Mbps)			
	(MHz)		1	2	5.5	11
802.11b	2412	1	15.45	15.40	15.31	15.29
	2437	6	15.54	15.47	15.42	15.37
	2462	11	<u>15.68</u>	15.60	15.56	15.62

Table 9.3 IEEE 802.11b Average RF Power

Mode	Freq.	Channel	802.11g (2.4 GHz) Conducted Power (dBm)							
			Data Rate (Mbps)							
	(MHz)		6	9	12	18	24	36	48	54
802.11g	2412	1	15.19	15.05	15.11	15.01	14.94	15.06	14.97	15.12
	2437	6	15.23	15.10	14.97	15.09	15.19	15.08	15.04	15.18
	2462	11	15.36	15.21	15.20	15.32	15.28	15.18	15.11	15.24

Table 9.4 IEEE 802.11g Average RF Power

Mode	Freq.	Channel	802.11n HT20 (2.4 GHz) Conducted Power (dBm)							
			Data Rate (Mbps)							
	(MHz)		6.5	13	19.5	26	39	52	58.5	65
802.11n (HT-20)	2412	1	15.04	14.92	14.97	14.90	14.80	14.91	15.01	14.89
	2437	6	15.22	15.10	15.14	15.06	15.08	15.11	15.20	14.96
	2462	11	15.30	15.22	15.28	15.16	15.04	15.18	15.24	15.17

Table 9.5 IEEE 802.11n HT20 Average RF Power

Justification for reduced test configurations for WIFI channels per KDB Publication 248227 D01v02r01 and October 2012 / April 2013 FCC/TCB Meeting Notes:

- Power measurements were performed for the transmission mode configuration with the highest maximum output power specified for production units.
- For transmission modes with the same maximum output power specification, powers were measured for the largest channel bandwidth, lowest order modulation and lowest data rate.
- For transmission modes with identical maximum specified output power, channel bandwidth, modulation and data rates, power measurements were required for all identical configurations.
- For each transmission mode configuration, powers were measured for the highest and lowest channels; and at the mid-band channel(s) when there were at least 3 channels supported. For configurations with multiple mid-band channels, duo to an even number of channels, both channels were measured.
- Output Power and SAR is not required for 802.11 g/n HT20 channels when the highest reported SAR for DSSS is adjusted by the ratio of OFDM to DSSS specified maximum output power and the adjust SAR is ≤ 1.2 W/kg.
- The underlined data rate and channel above were tested for SAR.

The average output powers of this device were tested by below configuration.

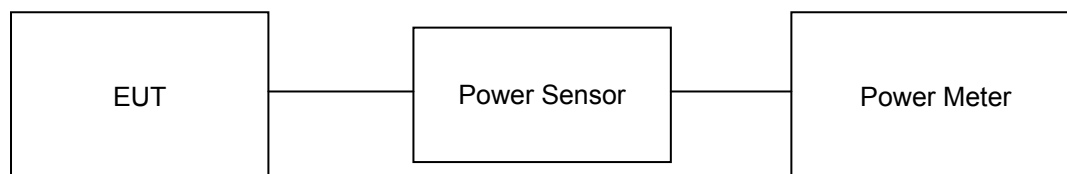

Figure 9.3 Power Measurement Setup

9.4 Bluetooth Conducted Powers

Channel	Frequency	Frame AVG Output Power (1Mbps)		Frame AVG Output Power (2Mbps)		Frame AVG Output Power (3Mbps)	
	(MHz)	(dBm)	(mW)	(dBm)	(mW)	(dBm)	(mW)
Low	2402	2.46	1.76	-2.15	0.61	-2.08	0.62
Mid	2441	2.72	1.87	-1.94	0.64	-1.87	0.65
High	2480	2.58	1.81	-2.08	0.62	-2.01	0.63

Table 9.6 Bluetooth Frame Average RF Power

Note:

The average conducted output powers of Bluetooth were measured using following test setup and a wideband gated RF power meter when the EUT is transmitting at its maximum power level.

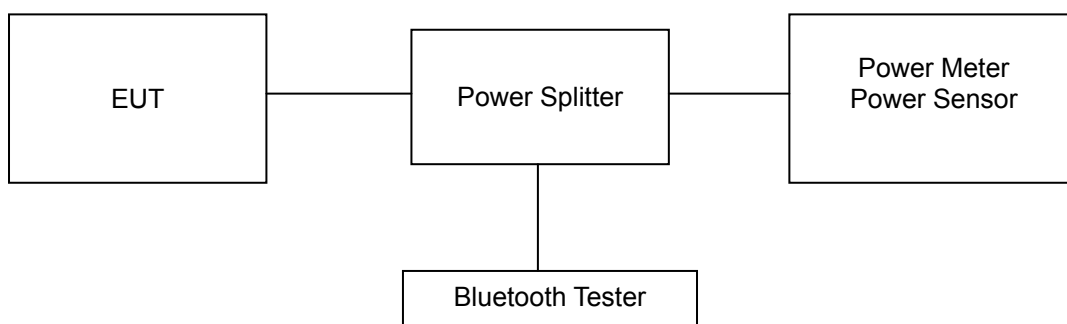

Figure 9.4 Power Measurement Setup

10. SYSTEM VERIFICATION

10.1 Tissue Verification

MEASURED TISSUE PARAMETERS										
Date(s)	Tissue Type	Ambient Temp.[°C]	Liquid Temp.[°C]	Measured Frequency [MHz]	Target Dielectric Constant, ϵ_r	Target Conductivity, σ (S/m)	Measured Dielectric Constant, ϵ_r	Measured Conductivity, σ (S/m)	Er Deviation [%]	σ Deviation [%]
Apr.13. 2015	835 Body	21.5	22.1	824.2	55.243	0.969	53.398	0.992	-3.34	2.37
				835.0	55.200	0.970	53.377	1.003	-3.30	3.40
				836.6	55.197	0.972	53.373	1.004	-3.30	3.29
				848.8	55.160	0.986	53.326	1.016	-3.32	3.04
Apr.14. 2015	835 Body	21.8	22.3	826.4	55.235	0.969	53.307	0.994	-3.49	2.58
				835.0	55.200	0.970	53.258	1.002	-3.52	3.30
				836.6	55.197	0.971	53.248	1.004	-3.53	3.40
				846.6	55.166	0.984	53.210	1.013	-3.55	2.95
Apr.16. 2015	1900 Body	21.3	21.7	1850.2	53.300	1.520	52.282	1.520	-1.91	0.00
				1880.0	53.300	1.520	52.250	1.548	-1.97	1.84
				1900.0	53.300	1.520	52.216	1.567	-2.03	3.09
				1909.8	53.300	1.520	52.198	1.576	-2.07	3.68
Apr.17. 2015	1900 Body	21.7	22.2	1852.4	53.300	1.520	53.009	1.523	-0.55	0.20
				1880.0	53.300	1.520	52.957	1.550	-0.64	1.97
				1900.0	53.300	1.520	52.907	1.569	-0.74	3.22
				1907.6	53.300	1.520	52.889	1.577	-0.77	3.75
Apr.21. 2015	2450 Body	20.8	21.4	2412	52.751	1.914	52.359	1.900	-0.74	-0.73
				2437	52.717	1.938	52.302	1.930	-0.79	-0.41
				2450	52.700	1.950	52.272	1.946	-0.81	-0.21
				2462	52.685	1.967	52.250	1.960	-0.83	-0.36
Aug.24. 2015	835 Head	21.2	21.6	824.2	41.552	0.899	41.250	0.876	-0.73	-2.56
				826.4	41.542	0.899	41.238	0.879	-0.73	-2.22
				835.0	41.500	0.900	41.198	0.887	-0.73	-1.44
				836.6	41.500	0.901	41.183	0.889	-0.76	-1.33
				846.6	41.500	0.912	41.124	0.898	-0.91	-1.54
				848.8	41.500	0.914	41.107	0.900	-0.95	-1.53
Aug.24. 2015	1900 Head	21.2	21.8	1850.2	40.000	1.400	38.926	1.355	-2.69	-3.21
				1852.4	40.000	1.400	38.916	1.358	-2.71	-3.00
				1880.0	40.000	1.400	38.780	1.385	-3.05	-1.07
				1900.0	40.000	1.400	38.712	1.406	-3.22	0.43
				1907.6	40.000	1.400	38.679	1.413	-3.30	0.93
				1909.8	40.000	1.400	38.670	1.416	-3.33	1.14
Aug.24. 2015	2450 Head	21.2	21.7	2412	39.265	1.766	38.583	1.787	-1.74	1.19
				2437	39.222	1.788	38.520	1.813	-1.79	1.40
				2450	39.200	1.800	38.480	1.828	-1.84	1.56
				2462	39.184	1.813	38.454	1.841	-1.86	1.54

The above measured tissue parameters were used in the DASY software. The DASY software was used to perform interpolation to determine the dielectric parameters at the SAR test device frequencies (per KDB 865664 and IEEE 1528-2013 6.6.1.2). The tissue parameters listed in the SAR test plots may slightly differ from the table above due to significant digit rounding in the software.

Measurement Procedure for Tissue verification:

- 1) The network analyzer and probe system was configured and calibrated.
- 2) The probe was immersed in the sample which was placed in a nonmetallic container. Trapped air bubbles beneath the flange were minimized by placing the probe at a slight angle.
- 3) The complex admittance with respect to the probe aperture was measured
- 4) The complex relative permittivity, for example from the below equation (Pournaropoulos and Misra):

$$Y = \frac{j2\omega\epsilon_r\epsilon_0}{[\ln(b/a)]^2} \int_a^b \int_a^b \int_0^\pi \cos\phi' \frac{\exp[-j\omega r(\mu_0\epsilon_r\epsilon_0)^{1/2}]}{r} d\phi' d\rho' d\rho$$

where Y is the admittance of the probe in contact with the sample, the primed and unprimed coordinates refer to source and observation points, respectively, $r^2 = \rho^2 + \rho'^2 - 2\rho\rho'\cos\phi'$, ω is the angular frequency, and $j = \sqrt{-1}$.

10.2 Test System Verification

Prior to assessment, the system is verified to the $\pm 10\%$ of the specifications at 835 MHz, 1900 MHz and 2450 MHz by using the SAR Dipole kit(s). (Graphic Plots Attached)

Table 10.2 System Verification Results

SYSTEM DIPOLE VERIFICATION TARGET & MEASURED												
SAR System #	Freq. [MHz]	SAR Dipole kits	Date(s)	Tissue Type	Ambient Temp. [°C]	Liquid Temp. [°C]	Probe S/N	Input Power (mW)	1W Target SAR (W/kg)	Measured SAR (W/kg)	1 W Normalized SAR (W/kg)	Deviation [%]
D	835	D835V2, SN:4d159	Apr.13. 2015	Body	21.5	22.1	3933	250	6.35	1.50	6.00	-5.51
D	835	D835V2, SN:4d159	Apr.14. 2015	Body	21.8	22.3	3933	250	6.35	1.49	5.96	-6.14
D	1900	D1900V2, SN: 5d176	Apr.16. 2015	Body	21.3	21.7	3933	250	21.2	5.22	20.88	-1.51
D	1900	D1900V2, SN: 5d176	Apr.17. 2015	Body	21.7	22.2	3933	250	21.2	5.31	21.24	0.19
D	2450	D2450V2, SN:920	Apr.21. 2015	Body	20.8	21.4	3933	250	23.9	5.75	23.00	-3.77
D	835	D835V2, SN:4d159	Aug.24.2015	Head	21.2	21.6	3933	250	9.19	2.33	9.32	1.41
D	1900	D1900V2, SN: 5d176	Aug.24.2015	Head	21.2	21.8	3933	250	40.1	9.56	38.24	-4.64
D	2450	D2450V2, SN:920	Aug.24.2015	Head	21.2	21.7	3933	250	52.7	13.60	54.40	3.23

Note1 : System Verification was measured with input 250 mW and normalized to 1W.

Note2 : To confirm the proper SAR liquid depth, the z-axis plots from the system verifications were included since the system verifications were performed using the same liquid, probe and DAE as the SAR tests in the same time period.

Note3: Full system validation status and results can be found in Attachment 3.

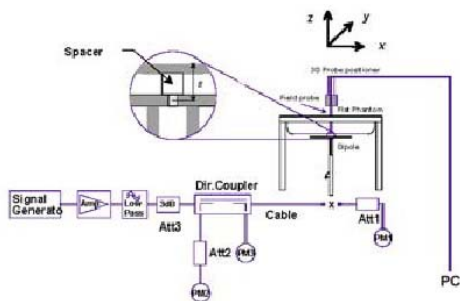

Figure 11.1 Dipole Verification Test Setup Diagram & Photo

11. SAR TEST RESULTS

11.1 Hand SAR Results

Table 11.1 GPRS Hand SAR

MEASUREMENT RESULTS														
FREQUENCY		Mode/ Band	Service	Maximum Allowed Power [dBm]	Conducted Power [dBm]	Drift Power [dB]	Spacing [Side]	Device Serial Number	# of Time Slots	Duty Cycle	10g SAR (W/kg)	Scaling Factor	10g Scaled SAR (W/kg)	Plots #
MHz	Ch													
836.6	190	GSM850	GPRS	30.5	30.3	-0.030	0 mm [Top #1]	FCC #1	2	1:4.15	0.091	1.047	0.095	
836.6	190	GSM850	GPRS	30.5	30.3	0.040	0 mm [Top #2]	FCC #1	2	1:4.15	0.076	1.047	0.080	
836.6	190	GSM850	GPRS	30.5	30.3	0.040	0 mm [Front #1]	FCC #1	2	1:4.15	0.188	1.047	0.197	
836.6	190	GSM850	GPRS	30.5	30.3	-0.040	0 mm [Front #2]	FCC #1	2	1:4.15	0.140	1.047	0.147	
836.6	190	GSM850	GPRS	30.5	30.3	0.070	0 mm [Rear]	FCC #1	2	1:4.15	0.184	1.047	0.193	
836.6	190	GSM850	GPRS	33.5	32.9	0.020	0 mm [Right #1]	FCC #1	1	1:8.3	0.200	1.148	0.230	A1
836.6	190	GSM850	GPRS	30.5	30.3	0.050	0 mm [Right #1]	FCC #1	2	1:4.15	0.208	1.047	0.218	
836.6	190	GSM850	GPRS	28.4	28.2	0.050	0 mm [Right #1]	FCC #1	3	1:2.77	0.201	1.047	0.210	
836.6	190	GSM850	GPRS	27.0	26.6	0.100	0 mm [Right #1]	FCC #1	4	1:2.075	0.193	1.096	0.212	
836.6	190	GSM850	GPRS	30.5	30.3	0.140	0 mm [Right #2]	FCC #1	2	1:4.15	0.136	1.047	0.142	
1880.0	661	PCS1900	GPRS	27.7	27.0	0.070	0 mm [Front #1]	FCC #1	2	1:4.15	0.091	1.175	0.107	
1880.0	661	PCS1900	GPRS	27.7	27.0	0.010	0 mm [Front #2]	FCC #1	2	1:4.15	0.095	1.175	0.112	
1880.0	661	PCS1900	GPRS	27.7	26.4	-0.110	0 mm [Rear]	FCC #1	2	1:4.15	0.257	1.349	0.347	
1880.0	661	PCS1900	GPRS	30.3	29.7	-0.190	0 mm [Right #1]	FCC #1	1	1:8.3	1.420	1.148	1.630	
1880.0	661	PCS1900	GPRS	27.7	27.0	-0.130	0 mm [Right #1]	FCC #1	2	1:4.15	1.450	1.175	1.704	A2
1880.0	661	PCS1900	GPRS	25.5	24.7	0.180	0 mm [Right #1]	FCC #1	3	1:2.77	1.290	1.202	1.551	
1880.0	661	PCS1900	GPRS	24.0	23.3	-0.110	0 mm [Right #1]	FCC #1	4	1:2.075	1.360	1.175	1.598	
1880.0	661	PCS1900	GPRS	27.7	27.0	0.160	0 mm [Right #2]	FCC #1	2	1:4.15	1.100	1.175	1.293	
ANSI / IEEE C95.1-2005- SAFETY LIMIT Spatial Peak Uncontrolled Exposure/General Population Exposure								Extremity 4.0 W/kg (mW/g) averaged over 10 gram						

Note: Top, Front, Right configuration tested twice. Refer to Test photo(SAR).

Table 11.2 WCDMA Hand SAR

MEASUREMENT RESULTS														
FREQUENCY		Mode/ Band	Service	Maximum Allowed Power [dBm]	Conducted Power [dBm]	Drift Power [dB]	Spacing [Side]	Device Serial Number	# of Time Slots	Duty Cycle	10g SAR (W/kg)	Scaling Factor	10g Scaled SAR (W/kg)	Plots #
MHz	Ch													
836.6	4183	WCDMA 850	RMC	24.1	23.72	0.040	0 mm [Front #1]	FCC #1	N/A	1:1	0.224	1.091	0.244	
836.6	4183	WCDMA 850	RMC	24.1	23.72	0.040	0 mm [Front #2]	FCC #1	N/A	1:1	0.162	1.091	0.177	
836.6	4183	WCDMA 850	RMC	24.1	23.72	0.080	0 mm [Rear]	FCC #1	N/A	1:1	0.290	1.091	0.316	
836.6	4183	WCDMA 850	RMC	24.1	23.72	0.090	0 mm [Right #1]	FCC #1	N/A	1:1	0.319	1.091	0.348	
836.6	4183	WCDMA 850	RMC	24.1	23.72	-0.040	0 mm [Right #2]	FCC #1	N/A	1:1	0.323	1.091	0.352	A3
1880.0	9400	WCDMA 1900	RMC	24.2	24.0	-0.170	0 mm [Top #1]	FCC #1	N/A	1:1	0.064	1.047	0.067	
1880.0	9400	WCDMA 1900	RMC	24.2	24.0	0.150	0 mm [Top #2]	FCC #1	N/A	1:1	0.059	1.047	0.062	
1880.0	9400	WCDMA 1900	RMC	24.2	24.0	-0.130	0 mm [Front #1]	FCC #1	N/A	1:1	0.183	1.047	0.192	
1880.0	9400	WCDMA 1900	RMC	24.2	24.0	0.010	0 mm [Front #2]	FCC #1	N/A	1:1	0.182	1.047	0.191	
1880.0	9400	WCDMA 1900	RMC	24.2	24.0	-0.010	0 mm [Rear]	FCC #1	N/A	1:1	0.456	1.047	0.477	
1880.0	9400	WCDMA 1900	RMC	24.2	24.0	-0.150	0 mm [Right #1]	FCC #1	N/A	1:1	1.890	1.047	1.979	A4
1880.0	9400	WCDMA 1900	RMC	24.2	24.0	0.150	0 mm [Right #2]	FCC #1	N/A	1:1	1.780	1.047	1.864	
ANSI / IEEE C95.1-2005- SAFETY LIMIT Spatial Peak Uncontrolled Exposure/General Population Exposure								Extremity 4.0 W/kg (mW/g) averaged over 10 gram						

Note: Top, Front, Right configuration tested twice. Refer to Test photo (SAR).

Table 11.3 DTS (2.4G) Hand SAR

MEASUREMENT RESULTS																
FREQUENCY		Mode/ Antenna	Service	Maximum Allowed Power [dBm]	Conducted Power [dBm]	Drift Power [dB]	Phantom Position	Device Serial Number	Data Rate [Mbps]	Duty Cycle	Area SAR (W/kg)	10g SAR (W/kg)	Scaling Factor (Power)	Scaling Factor (Duty Cycle)	10g Scaled SAR (W/kg)	Plots #
MHz	Ch															
2462	11	802.11b	DSSS	15.70	15.68	-0.150	0 mm [Front #1]	FCC #1	1	89.3	0.146	0.152	1.005	1.120	0.171	A5
2462	11	802.11b	DSSS	15.70	15.68	-0.040	0 mm [Front #2]	FCC #1	1	89.3	0.0475	-	1.005	1.120	-	
2462	11	802.11b	DSSS	15.70	15.68	0.060	0 mm [Rear]	FCC #1	1	89.3	0.0191	-	1.005	1.120	-	
ANSI / IEEE C95.1-2005- SAFETY LIMIT Spatial Peak Uncontrolled Exposure/General Population Exposure								Extremity 4.0 W/kg (mW/g) averaged over 10 gram								

Note(s):

- Highest reported SAR is ≤ 0.4 W/kg. Therefore, further SAR measurements within this exposure condition are not required.
- Front configuration tested twice. Refer to Test photo (SAR).

Adjusted SAR results for OFDM SAR

Adjusted SAR results for OFDM SAR												
FREQUENCY		Mode/ Antenna	Service	Maximum Allowed Power [dBm]	10g Scaled SAR (W/kg)	FREQUENCY [MHz]	Mode	Service	Maximum Allowed Power [dBm]	Ratio of OFDM to DSSS	10g Adjusted SAR (W/kg)	Determine OFDM SAR
MHz	Ch											
2462	11	802.11b	DSSS	15.70	0.171	2462	802.11g	OFDM	15.50	0.955	0.163	X
2462	11	802.11b	DSSS	15.70	0.171	2462	802.11n HT20	OFDM	15.50	0.955	0.163	X
ANSI / IEEE C95.1-2005- SAFETY LIMIT Spatial Peak Uncontrolled Exposure/General Population Exposure								Extremity 4.0 W/kg (mW/g) averaged over 10 gram				

11.2 Head SAR Results

Table 11.4 GPRS Head SAR

MEASUREMENT RESULTS														
FREQUENCY		Mode/ Band	Service	Maximum Allowed Power [dBm]	Conducted Power [dBm]	Drift Power [dB]	Spacing [Side]	Device Serial Number	# of Time Slots	Duty Cycle	1g SAR (W/kg)	Scaling Factor	1g Scaled SAR (W/kg)	Plots #
MHz	Ch													
836.6	190	GSM850	GPRS	33.5	32.9	-0.070	10 mm [Front #1]	FCC #1	1	1:8.3	0.113	1.148	0.130	
836.6	190	GSM850	GPRS	30.5	30.3	-0.090	10 mm [Front #1]	FCC #1	2	1:4.15	0.128	1.047	0.134	A6
836.6	190	GSM850	GPRS	28.4	28.2	-0.130	10 mm [Front #1]	FCC #1	3	1:2.77	0.124	1.047	0.130	
836.6	190	GSM850	GPRS	27.0	26.6	-0.130	10 mm [Front #1]	FCC #1	4	1:2.075	0.118	1.096	0.129	
1880.0	661	PCS1900	GPRS	30.3	29.7	-0.040	10 mm [Front #1]	FCC #1	1	1:8.3	0.083	1.148	0.095	
1880.0	661	PCS1900	GPRS	27.7	27.0	0.130	10 mm [Front #1]	FCC #1	2	1:4.15	0.091	1.175	0.107	A7
1880.0	661	PCS1900	GPRS	25.5	24.7	-0.070	10 mm [Front #1]	FCC #1	3	1:2.77	0.073	1.202	0.088	
1880.0	661	PCS1900	GPRS	24.0	23.3	-0.090	10 mm [Front #1]	FCC #1	4	1:2.075	0.072	1.175	0.085	
ANSI / IEEE C95.1-2005- SAFETY LIMIT Spatial Peak Uncontrolled Exposure/General Population Exposure								Head 1.6 W/kg (mW/g) averaged over 1 gram						

Note: The front #1 with 10 mm spacing configuration was tested since only the front #1 is 10 mm spacing to human head in normal operation of this device.

Table 11.5 WCDMA Head SAR

MEASUREMENT RESULTS														
FREQUENCY		Mode/ Band	Service	Maximum Allowed Power [dBm]	Conducted Power [dBm]	Drift Power [dB]	Spacing [Side]	Device Serial Number	# of Time Slots	Duty Cycle	1g SAR (W/kg)	Scaling Factor	1g Scaled SAR (W/kg)	Plots #
MHz	Ch													
836.6	4183	WCDMA 850	RMC	24.1	23.72	-0.170	10 mm [Front #1]	FCC #1	N/A	1:1	0.147	1.091	0.160	A8
1880.0	9400	WCDMA 1900	RMC	24.2	24.0	-0.020	10 mm [Front #1]	FCC #1	N/A	1:1	0.180	1.047	0.188	A9
ANSI / IEEE C95.1-2005- SAFETY LIMIT Spatial Peak Uncontrolled Exposure/General Population Exposure								Head 1.6 W/kg (mW/g) averaged over 1 gram						

Note: The front #1 with 10 mm spacing configuration was tested since only the front #1 is 10 mm spacing to human head in normal operation of this device.

Table 11.6 DTS (2.4G) Head SAR

MEASUREMENT RESULTS															
FREQUENCY		Mode/ Antenna	Service	Maximum Allowed Power [dBm]	Conducted Power [dBm]	Drift Power [dB]	Phantom Position	Device Serial Number	Data Rate [Mbps]	Duty Cycle	1g SAR (W/kg)	Scaling Factor (Power)	Scaling Factor (Duty Cycle)	1g Scaled SAR (W/kg)	Plots #
MHz	Ch														
2462	11	802.11b	DSSS	15.70	15.68	0.090	10 mm [Front #1]	FCC #1	1	89.3	0.065	1.005	1.120	0.073	A10
ANSI / IEEE C95.1-2005- SAFETY LIMIT Spatial Peak Uncontrolled Exposure/General Population Exposure								Head 1.6 W/kg (mW/g) averaged over 1 gram							

Note(s):
 1. The front #1 with 10 mm spacing configuration was tested since only the front #1 is 10 mm spacing to human head in normal operation of this device.
 2. Highest reported SAR is ≤ 0.4 W/kg. Therefore, further SAR measurements within this exposure condition are not required.

Adjusted SAR results for OFDM SAR

Adjusted SAR results for OFDM SAR												
FREQUENCY		Mode/ Antenna	Service	Maximum Allowed Power [dBm]	1g Scaled SAR (W/kg)	FREQUENCY [MHz]	Mode	Service	Maximum Allowed Power [dBm]	Ratio of OFDM to DSSS	1g Adjusted SAR (W/kg)	Determine OFDM SAR
MHz	Ch											
2462	11	802.11b	DSSS	15.70	0.073	2462	802.11g	OFDM	15.50	0.955	0.070	X
2462	11	802.11b	DSSS	15.70	0.073	2462	802.11n HT20	OFDM	15.50	0.955	0.070	X
ANSI / IEEE C95.1-2005- SAFETY LIMIT Spatial Peak Uncontrolled Exposure/General Population Exposure								Head 1.6 W/kg (mW/g) averaged over 1 gram				

11.3 SAR Test Notes

General Notes:

1. The test data reported are the worst-case SAR values according to test procedures specified in IEEE 1528-2003, and FCC KDB Publication 447498 D01v05r02.
2. Batteries are fully charged at the beginning of the SAR measurements. A standard battery was used for all SAR measurements.
3. Liquid tissue depth was at least 15.0 cm for all frequencies.
4. The manufacturer has confirmed that the device(s) tested have the same physical, mechanical and thermal characteristics and are within operational tolerances expected for production units
5. SAR results were scaled to the maximum allowed power to demonstrate compliance per FCC KDB Publication 447498 D01v05r02.
6. Per FCC KDB Publication 648474 D04v01r02, SAR was evaluated without a headset connected to the device. Since the standalone reported SAR was not > 1.2 W/kg, no additional SAR evaluations using a headset cable were performed.
7. Per FCC KDB 865664 D01v01r04, variability SAR tests were performed when the measured SAR results for a frequency band were greater than 0.8 W/kg. Repeated SAR measurements are highlighted in the tables above for clarity. Please see Section 14 for variability analysis.

GSM Notes:

1. Justification for reduced test configurations per KDB Publication 941225 D01v03 and October2013 TCB Workshop Notes: The source-based frame-averaged output power was evaluated for all GPRS/EDGE slot configurations. The configuration with the highest target frame averaged output power was evaluated for hotspot SAR. When the maximum frame-averaged powers are equivalent across two or more slots (within 0.25 dB), the configuration with the most number of time slots was tested.
2. Per FCC KDB Publication 447498 D01v05r02, if the reported (scaled) SAR measured at the middle channel or highest output power channel for each test configuration is ≤ 0.8 W/kg then testing at the other channels is not required for such test configuration(s). Since the maximum output power variation across the required test channels is not > $\frac{1}{2}$ dB, the middle channel was used for testing.

WCDMA(UMTS) Notes:

1. WCDMA (UMTS) mode in was tested under RMC 12.2 kbps with HSPA Inactive per KDB Publication 941225 D01v03. HSPA SAR was not required since the average output power of the HSPA subtests was not more than 0.25 dB higher than the RMC level and SAR was less than 1.2 W/kg.
2. Per FCC KDB Publication 447498 D01v05r02, if the reported (scaled) SAR measured at the middle channel or highest output power channel for each test configuration is ≤ 0.8 W/kg then testing at the other channels is not required for such test configuration(s). When the maximum output power variation across the required test channels is > $\frac{1}{2}$ dB, instead of the middle channel, the highest output power channel was used.

WLAN Notes:

1. The initial test position procedures were applied. The test position with the highest extrapolated peak SAR will be used as the initial test position. When reported SAR for the initial test position is ≤ 0.4 W/kg, no additional testing for the remaining test positions was required. Otherwise, SAR is evaluated at the subsequent highest peak SAR positions until the reported SAR result is ≤ 0.8 W/kg or all test positions are measured.
2. Justification for test configurations for WLAN per KDB Publication 248227 D01v02r01 for 2.4 GHz WIFI single transmission chain operations, the highest measured maximum output power channel for DSSS was selected for SAR measurement. SAR for OFDM modes (2.4 GHz 802.11g/n) was not required due to the maximum allowed powers and the highest reported DSSS SAR when the highest reported SAR for DSSS is adjusted by the ratio of OFDM to DSSS specified maximum output and the adjusted SAR is ≤ 1.2 W/kg.
3. When the maximum reported 1g averaged SAR ≤ 0.8 W/kg, SAR testing on additional channels was not required. Otherwise, SAR for the next highest output power channel was required until the reported SAR result was ≤ 1.20 W/kg or all test channels were measured.
4. The device was configured to transmit continuously at the required data rate, channel bandwidth and signal modulation, using the highest transmission duty factor to determine compliance.

12. SAR MEASUREMENT VARIABILITY

12.1 Measurement Variability

Per FCC KDB Publication 865664 D01v01r04, SAR measurement variability was assessed for each frequency band, which was determined by the SAR probe calibration point and tissue-equivalent medium used for the device measurements. When both head and body tissue-equivalent media were required for SAR measurements in a frequency band, the variability measurement procedures were applied to the tissue medium with the highest measured SAR, using the highest measured SAR configuration for that tissue-equivalent medium. These additional measurements were repeated after the completion of all measurements requiring the same head or body tissue-equivalent medium in a frequency band. The test device was returned to ambient conditions (normal room temperature) with the battery fully charged before it was re-mounted on the device holder for the repeated measurement(s) to minimize any unexpected variations in the repeated results.

SAR Measurement Variability was assessed using the following procedures for each frequency band:

1. When the original highest measured SAR is ≥ 0.80 W/kg, the measurement was repeated once.
2. A second repeated measurement was performed only if the ratio of largest to smallest SAR for the original and first repeated measurements was > 1.2 or when the original or repeated measurement was ≥ 1.45 W/kg (~ 10% from the 1-g SAR limit).
3. A third repeated measurement was performed only if the original, first or second repeated measurement was ≥ 1.5 W/kg and the ratio of largest to smallest SAR for the original, first and second repeated measurements is > 1.2 .
4. Repeated measurements are not required when the original highest measured SAR is < 0.80 W/kg.

12.2 Measurement Uncertainty

The measured SAR was < 1.5 W/kg for all frequency bands. Therefore, per KDB Publication 865664 D01v01r04, the standard measurement uncertainty analysis per IEEE 1528-2003 was not required.

13. IEEE P1528 –MEASUREMENT UNCERTAINTIES

835 MHz Body

Error Description	Uncertainty value $\pm\%$	Probability Distribution	Divisor	(Ci) 1g	Standard (1g)	vi 2 or Veff
Measurement System						
Probe calibration	± 6.0	Normal	1	1	$\pm 6.0 \%$	∞
Axial isotropy	± 4.7	Rectangular	$\sqrt{3}$	1	$\pm 2.714 \%$	∞
Hemispherical isotropy	± 9.6	Rectangular	$\sqrt{3}$	1	$\pm 5.543 \%$	∞
Boundary Effects	± 0.8	Rectangular	$\sqrt{3}$	1	$\pm 0.462 \%$	∞
Probe Linearity	± 4.7	Rectangular	$\sqrt{3}$	1	$\pm 2.714 \%$	∞
Detection limits	± 0.25	Rectangular	$\sqrt{3}$	1	$\pm 0.144 \%$	∞
Readout Electronics	± 1.0	Normal	1	1	$\pm 1.0 \%$	∞
Response time	± 0.8	Rectangular	$\sqrt{3}$	1	$\pm 0.462 \%$	∞
Integration time	± 2.6	Rectangular	$\sqrt{3}$	1	$\pm 1.501 \%$	∞
RF Ambient Conditions	± 3.0	Rectangular	$\sqrt{3}$	1	$\pm 1.732 \%$	∞
Probe Positioner	± 0.4	Rectangular	$\sqrt{3}$	1	$\pm 0.231 \%$	∞
Probe Positioning	± 2.9	Rectangular	$\sqrt{3}$	1	$\pm 1.674 \%$	∞
Algorithms for Max. SAR Eval.	± 1.0	Rectangular	$\sqrt{3}$	1	$\pm 0.577 \%$	∞
Test Sample Related						
Device Positioning	± 2.9	Normal	1	1	$\pm 2.9 \%$	145
Device Holder	± 3.6	Normal	1	1	$\pm 3.6 \%$	5
Power Drift	± 5.0	Rectangular	$\sqrt{3}$	1	$\pm 2.887 \%$	∞
Physical Parameters						
Phantom Shell	± 4.0	Rectangular	$\sqrt{3}$	1	$\pm 2.31 \%$	∞
Liquid conductivity (Target)	± 5.0	Rectangular	$\sqrt{3}$	0.64	$\pm 2.887 \%$	∞
Liquid conductivity (Meas.)	± 4.5	Normal	1	0.64	$\pm 4.5 \%$	∞
Liquid permittivity (Target)	± 5.0	Rectangular	$\sqrt{3}$	0.6	$\pm 2.887 \%$	∞
Liquid permittivity (Meas.)	± 4.2	Normal	1	0.6	$\pm 4.2 \%$	∞
Combined Standard Uncertainty		RSS			$\pm 12.1 \%$	330
Expanded Uncertainty (k=2)					$\pm 24.2 \%$	

The above measurement uncertainties are according to IEEE P1528 (2003)

1900 MHz Body

Error Description	Uncertainty value $\pm\%$	Probability Distribution	Divisor	(Ci) 1g	Standard (1g)	vi 2 or Veff
Measurement System						
Probe calibration	± 6.0	Normal	1	1	$\pm 6.0 \%$	∞
Axial isotropy	± 4.7	Rectangular	$\sqrt{3}$	1	$\pm 2.714 \%$	∞
Hemispherical isotropy	± 9.6	Rectangular	$\sqrt{3}$	1	$\pm 5.543 \%$	∞
Boundary Effects	± 0.8	Rectangular	$\sqrt{3}$	1	$\pm 0.462 \%$	∞
Probe Linearity	± 4.7	Rectangular	$\sqrt{3}$	1	$\pm 2.714 \%$	∞
Detection limits	± 0.25	Rectangular	$\sqrt{3}$	1	$\pm 0.145 \%$	∞
Readout Electronics	± 1.0	Normal	1	1	$\pm 1.0 \%$	∞
Response time	± 0.8	Rectangular	$\sqrt{3}$	1	$\pm 0.462 \%$	∞
Integration time	± 2.6	Rectangular	$\sqrt{3}$	1	$\pm 1.501 \%$	∞
RF Ambient Conditions	± 3.0	Rectangular	$\sqrt{3}$	1	$\pm 1.732 \%$	∞
Probe Positioner	± 0.4	Rectangular	$\sqrt{3}$	1	$\pm 0.231 \%$	∞
Probe Positioning	± 2.9	Rectangular	$\sqrt{3}$	1	$\pm 1.674 \%$	∞
Algorithms for Max. SAR Eval.	± 1.0	Rectangular	$\sqrt{3}$	1	$\pm 0.577 \%$	∞
Test Sample Related						
Device Positioning	± 2.9	Normal	1	1	$\pm 2.9 \%$	145
Device Holder	± 3.6	Normal	1	1	$\pm 3.6 \%$	5
Power Drift	± 5.0	Rectangular	$\sqrt{3}$	1	$\pm 2.887 \%$	∞
Physical Parameters						
Phantom Shell	± 4.0	Rectangular	$\sqrt{3}$	1	$\pm 2.31 \%$	∞
Liquid conductivity (Target)	± 5.0	Rectangular	$\sqrt{3}$	0.64	$\pm 2.887 \%$	∞
Liquid conductivity (Meas.)	± 4.1	Normal	1	0.64	$\pm 4.1 \%$	∞
Liquid permittivity (Target)	± 5.0	Rectangular	$\sqrt{3}$	0.6	$\pm 2.887 \%$	∞
Liquid permittivity (Meas.)	± 3.9	Normal	1	0.6	$\pm 3.9 \%$	∞
Combined Standard Uncertainty		RSS			$\pm 12.0 \%$	330
Expanded Uncertainty (k=2)					$\pm 24.0 \%$	

The above measurement uncertainties are according to IEEE P1528 (2003)

2450 MHz Body

Error Description	Uncertainty value $\pm\%$	Probability Distribution	Divisor	(Ci) 1g	Standard (1g)	vi 2 or Veff
Measurement System						
Probe calibration	± 6.0	Normal	1	1	$\pm 6.0 \%$	∞
Axial isotropy	± 4.7	Rectangular	$\sqrt{3}$	1	$\pm 2.714 \%$	∞
Hemispherical isotropy	± 9.6	Rectangular	$\sqrt{3}$	1	$\pm 5.543 \%$	∞
Boundary Effects	± 0.8	Rectangular	$\sqrt{3}$	1	$\pm 0.462 \%$	∞
Probe Linearity	± 4.7	Rectangular	$\sqrt{3}$	1	$\pm 2.714 \%$	∞
Detection limits	± 0.25	Rectangular	$\sqrt{3}$	1	$\pm 0.144 \%$	∞
Readout Electronics	± 1.0	Normal	1	1	$\pm 1.0 \%$	∞
Response time	± 0.8	Rectangular	$\sqrt{3}$	1	$\pm 0.462 \%$	∞
Integration time	± 2.6	Rectangular	$\sqrt{3}$	1	$\pm 1.501 \%$	∞
RF Ambient Conditions	± 3.0	Rectangular	$\sqrt{3}$	1	$\pm 1.732 \%$	∞
Probe Positioner	± 0.4	Rectangular	$\sqrt{3}$	1	$\pm 0.231 \%$	∞
Probe Positioning	± 2.9	Rectangular	$\sqrt{3}$	1	$\pm 1.674 \%$	∞
Algorithms for Max. SAR Eval.	± 1.0	Rectangular	$\sqrt{3}$	1	$\pm 0.577 \%$	∞
Test Sample Related						
Device Positioning	± 2.9	Normal	1	1	$\pm 2.9 \%$	145
Device Holder	± 3.6	Normal	1	1	$\pm 3.6 \%$	5
Power Drift	± 5.0	Rectangular	$\sqrt{3}$	1	$\pm 2.887 \%$	∞
Physical Parameters						
Phantom Shell	± 4.0	Rectangular	$\sqrt{3}$	1	$\pm 2.31 \%$	∞
Liquid conductivity (Target)	± 5.0	Rectangular	$\sqrt{3}$	0.64	$\pm 2.887 \%$	∞
Liquid conductivity (Meas.)	± 4.2	Normal	1	0.64	$\pm 4.2 \%$	∞
Liquid permittivity (Target)	± 5.0	Rectangular	$\sqrt{3}$	0.6	$\pm 2.887 \%$	∞
Liquid permittivity (Meas.)	± 4.0	Normal	1	0.6	$\pm 4.0 \%$	∞
Combined Standard Uncertainty		RSS			$\pm 12.1 \%$	330
Expanded Uncertainty (k=2)					$\pm 24.2 \%$	

The above measurement uncertainties are according to IEEE P1528 (2003)

14. CONCLUSION

Measurement Conclusion

The SAR measurement indicates that the EUT complies with the RF radiation exposure limits of the FCC. These measurements are taken to simulate the RF effects exposure under the worst-case conditions. Precise laboratory measures were taken to assure repeatability of the tests. The tested device complies with the requirements in respect to all parameters subject to the test. The test results and statements relate only to the item(s) tested.

Please note that the absorption and distribution of electromagnetic energy in the body are very complex phenomena that depend on the mass, shape, and size of the body, the orientation of the body with respect to the field vectors, and the electrical properties of both the body and the environment. Other variables that may play a substantial role impossible biological effect are those that characterize the environment (e.g. ambient temperature, air velocity, relative humidity, and body insulation) and those that characterize the individual (e.g. age, gender, activity level, debilitation, or disease).

Because innumerable factors may interact to determine the specific biological outcome of an exposure to electromagnetic fields, any protection guide shall consider maximal amplification of biological effects as a result of field-body interactions, environmental conditions, and physiological variables.

15. REFERENCES

- [1] Federal Communications Commission, ET Docket 93-62, Guidelines for Evaluating the Environmental Effects of Radiofrequency Radiation, Aug. 1996.
- [2] ANSI/IEEE C95.1-2005, American National Standard safety levels with respect to human exposure to radiofrequency electromagnetic fields, 3kHz to 300GHz, New York: IEEE, 2006.
- [3] ANSI/IEEE C95.1-1992, American National Standard safety levels with respect to human exposure to radiofrequency electromagnetic fields, 3kHz to 300GHz, New York: IEEE, Sept. 1992.
- [4] ANSI/IEEE C95.3-2002, IEEE Recommended Practice for the Measurement of Potentially Hazardous Electromagnetic Fields - RF and Microwave, New York: IEEE, December 2002.
- [5] IEEE Standards Coordinating Committee 39 –Standards Coordinating Committee 34 – IEEE Std. 1528-2003, Recommended Practice for Determining the Peak Spatial-Average Specific Absorption Rate (SAR) in the Human Body Due to Wireless Communications Devices.
- [6] NCRP, National Council on Radiation Protection and Measurements, Biological Effects and Exposure Criteria for Radio Frequency Electromagnetic Fields, NCRP Report No. 86, 1986. Reprinted Feb. 1995.
- [7] T. Schmid, O. Egger, N. Kuster, Automated E-field scanning system for dosimetric assessments, IEEE Transaction on Microwave Theory and Techniques, vol. 44, Jan. 1996, pp. 105-113.
- [8] K. Pokovic, T. Schmid, N. Kuster, Robust setup for precise calibration of E-field probes in tissue simulating liquids at mobile communications frequencies, ICECOM97, Oct. 1997, pp. -124.
- [9] K. Pokovic, T. Schmid, and N. Kuster, E-field Probe with improved isotropy in brain simulating liquids, Proceedings of the ELMAR, Zadar, Croatia, June 23-25, 1996, pp. 172-175.
- [10] Schmid& Partner Engineering AG, Application Note: Data Storage and Evaluation, June 1998, p2.
- [11] V. Hombach, K. Meier, M. Burkhardt, E. Kuhn, N. Kuster, The Dependence of EM Energy Absorption upon Human Modeling at 900 MHz, IEEE Transaction on Microwave Theory and Techniques, vol. 44 no. 10, Oct.1996, pp. 1865-1873.
- [12] N. Kuster and Q. Balzano, Energy absorption mechanism by biological bodies in the near field of dipole antennas above 300MHz, IEEE Transaction on Vehicular Technology, vol. 41, no. 1, Feb. 1992, pp. 17-23.
- [13] G. Hartsgrrove, A. Kraszewski, A. Surowiec, Simulated Biological Materials for Electromagnetic Radiation Absorption Studies, University of Ottawa, Bio electromagnetics, Canada: 1987, pp. 29-36.
- [14] Q. Balzano, O. Garay, T. Manning Jr., Electromagnetic Energy Exposure of Simulated Users of Portable Cellular Telephones, IEEE Transactions on Vehicular Technology, vol. 44, no.3, Aug. 1995.
- [15] W. Gander, Computer mathematick, Birkhaeuser, Basel, 1992.
- [16] W.H. Press, S.A. Teukolsky, W.T. Vetterling, and B.P. Flannery, Numerical Recipes in C, The Art of Scientific Computing, Second edition, Cambridge University Press, 1992.
- [17] N. Kuster, R. Kastle, T. Schmid, Dosimetric evaluation of mobile communications equipment with known precision, IEEE Transaction on Communications, vol. E80-B, no. 5, May 1997, pp. 645-652.
- [18] CENELEC CLC/SC111B, European Prestandard (prENV 50166-2), Human Exposure to Electromagnetic Fields High-frequency: 10kHz-300GHz, Jan. 1995.
- [19] Prof. Dr. Niels Kuster, ETH, Eidgenössische Technische Hochschule Zürich, Dosimetric Evaluation of the Cellular Phone.
- [20] IEC 62209-1, Human exposure to radio frequency fields from hand-held and body-mounted wireless communication devices - Human models, instrumentation, and procedures - Part 1: Procedure to determine the specific absorption rate (SAR) for hand-held devices used in close proximity to the ear (frequency range of 300MHz to 3 GHz), Feb. 2005.

- [21] Industry Canada RSS-102 Radio Frequency Exposure Compliance of Radio communication Apparatus (All Frequency Bands) Issue 4, March 2010.
- [22] Health Canada Safety Code 6 Limits of Human Exposure to Radio Frequency Electromagnetic Fields in the Frequency Range from 3 kHz – 300 GHz, 2009
- [23] FCC SAR Test Procedures for 2G-3G Devices, Mobile Hotspot and UMPC Devices KDB Publications 941225,D01-D07
- [24] SAR Measurement procedures for IEEE 802.11a/b/g KDB Publication 248227 D01v02r01
- [25] FCC SAR Considerations for Handsets with Multiple Transmitters and Antennas, KDB Publications 648474 D02-D04
- [26] FCC SAR Measurement and Reporting Requirements for 100MHz – 6 GHz, KDB Publications 865664 D01-D02
- [27] FCC General RF Exposure Guidance and SAR Procedures for Dongles, KDB Publication 447498, D01-D02
- [28] 615223 D01 802 16e WiMax SAR Guidance v01, Nov. 13, 2009
- [29] Anexo à Resolução No. 533, de 10 de Setembro de 2009.
- [30] IEC 62209-2, Human exposure to radio frequency fields from hand-held and body-mounted wireless communication devices - Human models, instrumentation, and procedures - Part 2: Procedure to determine the specific absorption rate (SAR) for wireless communication devices used in close proximity to the human body(frequency range of 30 MHz to 6 GHz), Mar. 2010.

Attachment 1. – Probe Calibration Data

**Calibration Laboratory of
Schmid & Partner
Engineering AG**
Zeughausstrasse 43, 8004 Zurich, Switzerland



S Schweizerischer Kalibrierdienst
C Service suisse d'étalonnage
S Servizio svizzero di taratura
S Swiss Calibration Service

Accredited by the Swiss Accreditation Service (SAS)
The Swiss Accreditation Service is one of the signatories to the EA
Multilateral Agreement for the recognition of calibration certificates

Accreditation No.: **SCS 108**

Client **DT&C (Dymstec)**

Certificate No: **EX3-3933_Sep14**

CALIBRATION CERTIFICATE

Object **EX3DV4 - SN:3933**

Calibration procedure(s) **QA CAL-01.v9, QA CAL-12.v9, QA CAL-14.v4, QA CAL-23.v5,
QA CAL-25.v6
Calibration procedure for dosimetric E-field probes**

Calibration date: **September 22, 2014**

This calibration certificate documents the traceability to national standards, which realize the physical units of measurements (SI).
The measurements and the uncertainties with confidence probability are given on the following pages and are part of the certificate.

All calibrations have been conducted in the closed laboratory facility: environment temperature (22 ± 3)°C and humidity < 70%.

Calibration Equipment used (M&TE critical for calibration)

Primary Standards	ID	Cal Date (Certificate No.)	Scheduled Calibration
Power meter E4419B	GB41293874	03-Apr-14 (No. 217-01911)	Apr-15
Power sensor E4412A	MY41498087	03-Apr-14 (No. 217-01911)	Apr-15
Reference 3 dB Attenuator	SN: S5054 (3c)	03-Apr-14 (No. 217-01915)	Apr-15
Reference 20 dB Attenuator	SN: S5277 (20x)	03-Apr-14 (No. 217-01919)	Apr-15
Reference 30 dB Attenuator	SN: S5129 (30b)	03-Apr-14 (No. 217-01920)	Apr-15
Reference Probe ES3DV2	SN: 3013	30-Dec-13 (No. ES3-3013_Dec13)	Dec-14
DAE4	SN: 660	13-Dec-13 (No. DAE4-660_Dec13)	Dec-14
Secondary Standards	ID	Check Date (in house)	Scheduled Check
RF generator HP 8648C	US3642U01700	4-Aug-99 (in house check Apr-13)	In house check: Apr-16
Network Analyzer HP 8753E	US37390585	18-Oct-01 (in house check Oct-13)	In house check: Oct-14

	Name	Function	Signature
Calibrated by:	Jeton Kastrati	Laboratory Technician	
Approved by:	Katja Pokovic	Technical Manager	

Issued: September 23, 2014

This calibration certificate shall not be reproduced except in full without written approval of the laboratory.

Calibration Laboratory of
Schmid & Partner
Engineering AG
Zeughausstrasse 43, 8004 Zurich, Switzerland



S Schweizerischer Kalibrierdienst
C Service suisse d'étalonnage
S Servizio svizzero di taratura
S Swiss Calibration Service

Accredited by the Swiss Accreditation Service (SAS)

Accreditation No.: **SCS 108**

The Swiss Accreditation Service is one of the signatories to the EA Multilateral Agreement for the recognition of calibration certificates

Glossary:

TSL	tissue simulating liquid
NORM _{x,y,z}	sensitivity in free space
ConvF	sensitivity in TSL / NORM _{x,y,z}
DCP	diode compression point
CF	crest factor (1/duty_cycle) of the RF signal
A, B, C, D	modulation dependent linearization parameters
Polarization φ	φ rotation around probe axis
Polarization ϑ	ϑ rotation around an axis that is in the plane normal to probe axis (at measurement center), i.e., $\vartheta = 0$ is normal to probe axis
Connector Angle	information used in DASY system to align probe sensor X to the robot coordinate system

Calibration is Performed According to the Following Standards:

- IEEE Std 1528-2013, "IEEE Recommended Practice for Determining the Peak Spatial-Averaged Specific Absorption Rate (SAR) in the Human Head from Wireless Communications Devices: Measurement Techniques", June 2013
- IEC 62209-1, "Procedure to measure the Specific Absorption Rate (SAR) for hand-held devices used in close proximity to the ear (frequency range of 300 MHz to 3 GHz)", February 2005

Methods Applied and Interpretation of Parameters:

- NORM_{x,y,z}**: Assessed for E-field polarization $\vartheta = 0$ ($f \leq 900$ MHz in TEM-cell; $f > 1800$ MHz: R22 waveguide). NORM_{x,y,z} are only intermediate values, i.e., the uncertainties of NORM_{x,y,z} does not affect the E²-field uncertainty inside TSL (see below ConvF).
- NORM(f)_{x,y,z}** = NORM_{x,y,z} * frequency_response (see Frequency Response Chart). This linearization is implemented in DASY4 software versions later than 4.2. The uncertainty of the frequency response is included in the stated uncertainty of ConvF.
- DCP_{x,y,z}**: DCP are numerical linearization parameters assessed based on the data of power sweep with CW signal (no uncertainty required). DCP does not depend on frequency nor media.
- PAR**: PAR is the Peak to Average Ratio that is not calibrated but determined based on the signal characteristics
- A_{x,y,z}; B_{x,y,z}; C_{x,y,z}; D_{x,y,z}; VR_{x,y,z}**: A, B, C, D are numerical linearization parameters assessed based on the data of power sweep for specific modulation signal. The parameters do not depend on frequency nor media. VR is the maximum calibration range expressed in RMS voltage across the diode.
- ConvF and Boundary Effect Parameters**: Assessed in flat phantom using E-field (or Temperature Transfer Standard for $f \leq 800$ MHz) and inside waveguide using analytical field distributions based on power measurements for $f > 800$ MHz. The same setups are used for assessment of the parameters applied for boundary compensation (alpha, depth) of which typical uncertainty values are given. These parameters are used in DASY4 software to improve probe accuracy close to the boundary. The sensitivity in TSL corresponds to NORM_{x,y,z} * ConvF whereby the uncertainty corresponds to that given for ConvF. A frequency dependent ConvF is used in DASY version 4.4 and higher which allows extending the validity from ± 50 MHz to ± 100 MHz.
- Spherical isotropy (3D deviation from isotropy)**: in a field of low gradients realized using a flat phantom exposed by a patch antenna.
- Sensor Offset**: The sensor offset corresponds to the offset of virtual measurement center from the probe tip (on probe axis). No tolerance required.
- Connector Angle**: The angle is assessed using the information gained by determining the NORM_x (no uncertainty required).

EX3DV4 – SN:3933

September 22, 2014

Probe EX3DV4

SN:3933

Manufactured: July 24, 2013
Calibrated: September 22, 2014

Calibrated for DASY/EASY Systems
(Note: non-compatible with DASY2 system!)

EX3DV4- SN:3933

September 22, 2014

DASY/EASY - Parameters of Probe: EX3DV4 - SN:3933**Basic Calibration Parameters**

	Sensor X	Sensor Y	Sensor Z	Unc (k=2)
Norm ($\mu\text{V}/(\text{V}/\text{m})^2$) ^A	0.49	0.53	0.19	$\pm 10.1\%$
DCP (mV) ^B	102.0	99.5	90.2	

Modulation Calibration Parameters

UID	Communication System Name		A dB	B dB $\sqrt{\mu\text{V}}$	C	D dB	VR mV	Unc ^E (k=2)
0	CW	X	0.0	0.0	1.0	0.00	139.3	$\pm 3.8\%$
		Y	0.0	0.0	1.0		141.1	
		Z	0.0	0.0	1.0		149.8	

The reported uncertainty of measurement is stated as the standard uncertainty of measurement multiplied by the coverage factor k=2, which for a normal distribution corresponds to a coverage probability of approximately 95%.

^A The uncertainties of NormX,Y,Z do not affect the E²-field uncertainty inside TSL (see Pages 5 and 6).

^B Numerical linearization parameter: uncertainty not required.

^E Uncertainty is determined using the max. deviation from linear response applying rectangular distribution and is expressed for the square of the field value.

EX3DV4-- SN:3933

September 22, 2014

DASY/EASY - Parameters of Probe: EX3DV4 - SN:3933**Calibration Parameter Determined in Head Tissue Simulating Media**

f (MHz) ^C	Relative Permittivity ^F	Conductivity (S/m) ^F	ConvF X	ConvF Y	ConvF Z	Alpha ^G	Depth ^G (mm)	Unct. (k=2)
300	45.3	0.87	13.04	13.04	13.04	0.08	1.50	± 13.3 %
450	43.5	0.87	12.65	12.65	12.65	0.15	1.80	± 13.3 %
600	42.7	0.88	11.04	11.04	11.04	0.08	1.20	± 13.3 %
750	41.9	0.89	10.90	10.90	10.90	0.42	0.80	± 12.0 %
835	41.5	0.90	10.48	10.48	10.48	0.60	0.65	± 12.0 %
900	41.5	0.97	10.36	10.36	10.36	0.50	0.70	± 12.0 %
1750	40.1	1.37	8.76	8.76	8.76	0.24	1.00	± 12.0 %
1900	40.0	1.40	8.46	8.46	8.46	0.28	0.91	± 12.0 %
2300	39.5	1.67	8.39	8.39	8.39	0.22	1.04	± 12.0 %
2450	39.2	1.80	7.99	7.99	7.99	0.30	0.85	± 12.0 %
2600	39.0	1.96	7.40	7.40	7.40	0.32	0.91	± 12.0 %
3500	37.9	2.91	7.35	7.35	7.35	0.17	1.92	± 13.1 %
5200	36.0	4.66	5.38	5.38	5.38	0.35	1.80	± 13.1 %
5300	35.9	4.76	5.15	5.15	5.15	0.35	1.80	± 13.1 %
5500	35.6	4.96	5.01	5.01	5.01	0.40	1.80	± 13.1 %
5600	35.5	5.07	4.90	4.90	4.90	0.40	1.80	± 13.1 %
5800	35.3	5.27	4.78	4.78	4.78	0.40	1.80	± 13.1 %

^C Frequency validity above 300 MHz of ± 100 MHz only applies for DASY v4.4 and higher (see Page 2), else it is restricted to ± 50 MHz. The uncertainty is the RSS of the ConvF uncertainty at calibration frequency and the uncertainty for the indicated frequency band. Frequency validity below 300 MHz is ± 10, 25, 40, 50 and 70 MHz for ConvF assessments at 30, 64, 128, 150 and 220 MHz respectively. Above 5 GHz frequency validity can be extended to ± 110 MHz.

^F At frequencies below 3 GHz, the validity of tissue parameters (ϵ and σ) can be relaxed to ± 10% if liquid compensation formula is applied to measured SAR values. At frequencies above 3 GHz, the validity of tissue parameters (ϵ and σ) is restricted to ± 5%. The uncertainty is the RSS of the ConvF uncertainty for indicated target tissue parameters.

^G Alpha/Depth are determined during calibration. SPEAG warrants that the remaining deviation due to the boundary effect after compensation is always less than ± 1% for frequencies below 3 GHz and below ± 2% for frequencies between 3-6 GHz at any distance larger than half the probe tip diameter from the boundary.

EX3DV4- SN:3933

September 22, 2014

DASY/EASY - Parameters of Probe: EX3DV4 - SN:3933**Calibration Parameter Determined in Body Tissue Simulating Media**

f (MHz) ^C	Relative Permittivity ^F	Conductivity (S/m) ^F	ConvF X	ConvF Y	ConvF Z	Alpha ^G	Depth ^G (mm)	Unct. (k=2)
300	58.2	0.92	12.23	12.23	12.23	0.05	1.10	± 13.3 %
450	56.7	0.94	12.93	12.93	12.93	0.05	1.10	± 13.3 %
600	56.1	0.95	11.28	11.28	11.28	0.10	1.20	± 13.3 %
750	55.5	0.96	10.58	10.58	10.58	0.25	0.95	± 12.0 %
835	55.2	0.97	10.38	10.38	10.38	0.55	0.75	± 12.0 %
900	55.0	1.05	10.27	10.27	10.27	0.32	0.80	± 12.0 %
1750	53.4	1.49	8.91	8.91	8.91	0.38	0.83	± 12.0 %
1900	53.3	1.52	8.14	8.14	8.14	0.38	0.82	± 12.0 %
2300	52.9	1.81	7.96	7.96	7.96	0.26	1.02	± 12.0 %
2450	52.7	1.95	7.78	7.78	7.78	0.64	0.59	± 12.0 %
2600	52.5	2.16	7.58	7.58	7.58	0.64	0.59	± 12.0 %
3500	51.3	3.31	6.96	6.96	6.96	0.19	2.26	± 13.1 %
5200	49.0	5.30	4.91	4.91	4.91	0.40	1.90	± 13.1 %
5300	48.9	5.42	4.72	4.72	4.72	0.40	1.90	± 13.1 %
5500	48.6	5.65	4.18	4.18	4.18	0.50	1.90	± 13.1 %
5600	48.5	5.77	4.01	4.01	4.01	0.50	1.90	± 13.1 %
5800	48.2	6.00	4.24	4.24	4.24	0.50	1.90	± 13.1 %

^C Frequency validity above 300 MHz of ± 100 MHz only applies for DASY v4.4 and higher (see Page 2), else it is restricted to ± 50 MHz. The uncertainty is the RSS of the ConvF uncertainty at calibration frequency and the uncertainty for the indicated frequency band. Frequency validity below 300 MHz is ± 10, 25, 40, 50 and 70 MHz for ConvF assessments at 30, 64, 128, 150 and 220 MHz respectively. Above 5 GHz frequency validity can be extended to ± 110 MHz.

^F At frequencies below 3 GHz, the validity of tissue parameters (ϵ and σ) can be relaxed to ± 10% if liquid compensation formula is applied to measured SAR values. At frequencies above 3 GHz, the validity of tissue parameters (ϵ and σ) is restricted to ± 5%. The uncertainty is the RSS of the ConvF uncertainty for indicated target tissue parameters.

^G Alpha/Depth are determined during calibration. SPEAG warrants that the remaining deviation due to the boundary effect after compensation is always less than ± 1% for frequencies below 3 GHz and below ± 2% for frequencies between 3-6 GHz at any distance larger than half the probe tip diameter from the boundary.

EX3DV4- SN:3933

September 22, 2014

Frequency Response of E-Field (TEM-Cell:ifi110 EXX, Waveguide: R22)

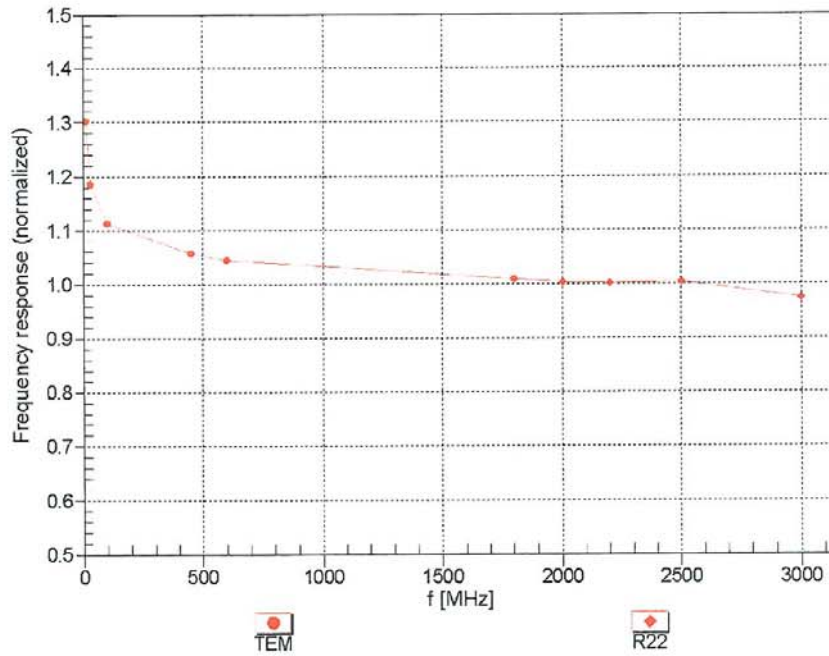

Uncertainty of Frequency Response of E-field: $\pm 6.3\%$ (k=2)

EX3DV4- SN:3933

September 22, 2014

Receiving Pattern (ϕ), $\theta = 0^\circ$

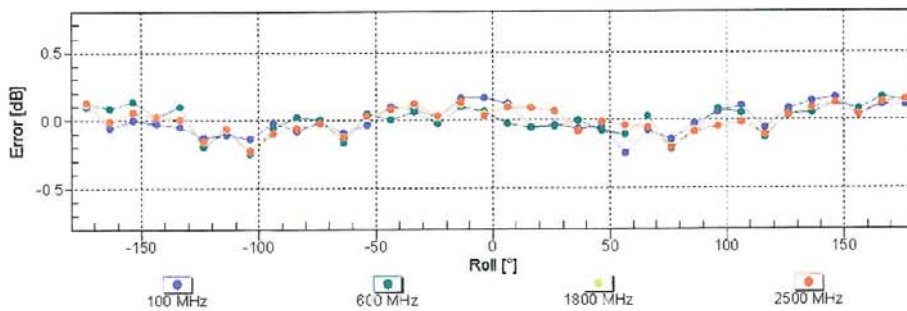
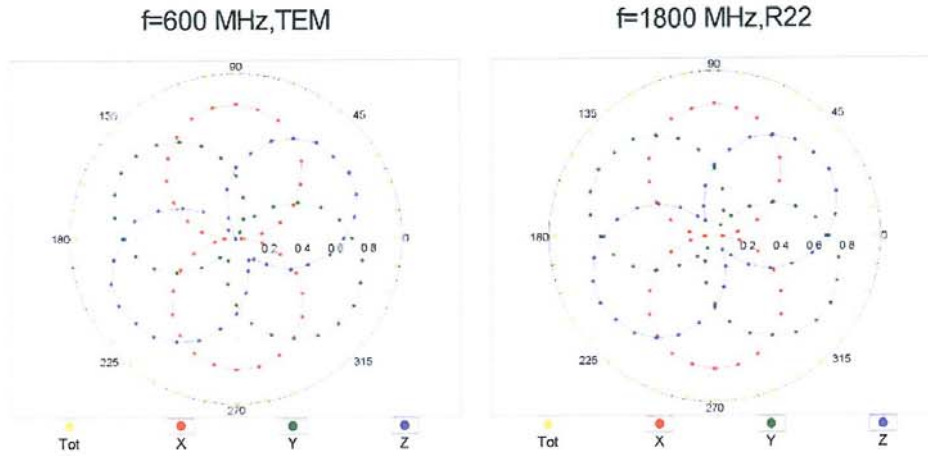

Uncertainty of Axial Isotropy Assessment: $\pm 0.5\%$ (k=2)

EX3DV4- SN:3933

September 22, 2014

Dynamic Range $f(\text{SAR}_{\text{head}})$ (TEM cell, $f_{\text{eval}} = 1900 \text{ MHz}$)

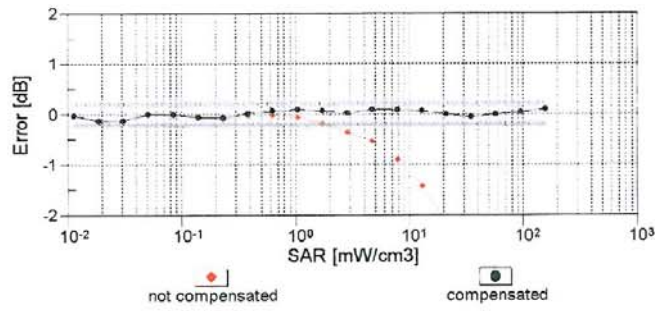
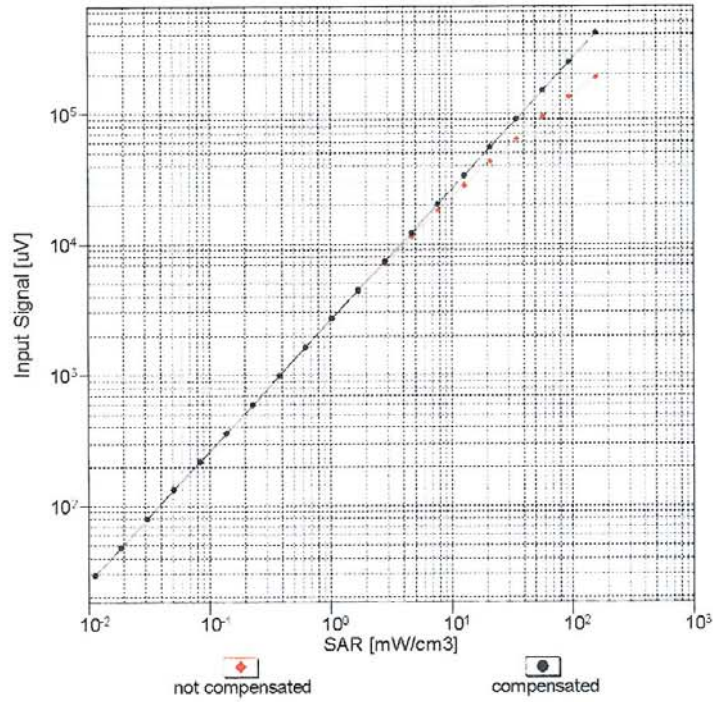

Uncertainty of Linearity Assessment: $\pm 0.6\%$ ($k=2$)

EX3DV4- SN:3933

September 22, 2014

Conversion Factor Assessment

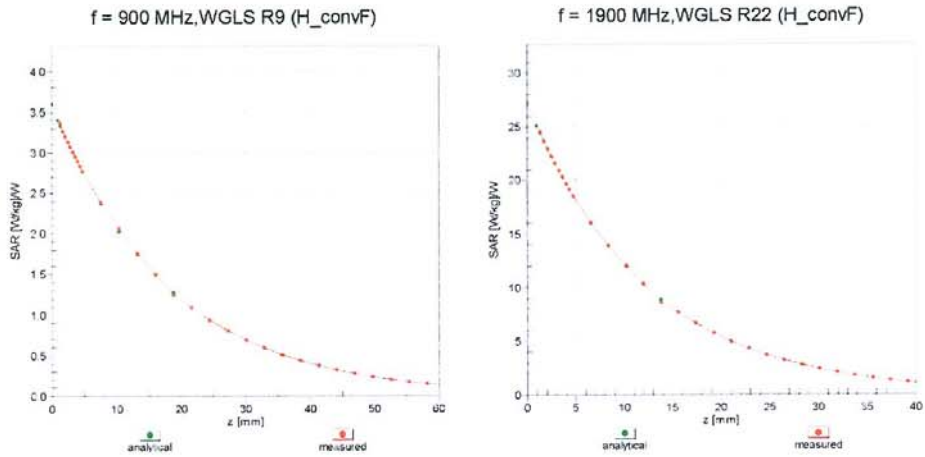

Deviation from Isotropy in Liquid

Error (ϕ, θ), f = 900 MHz

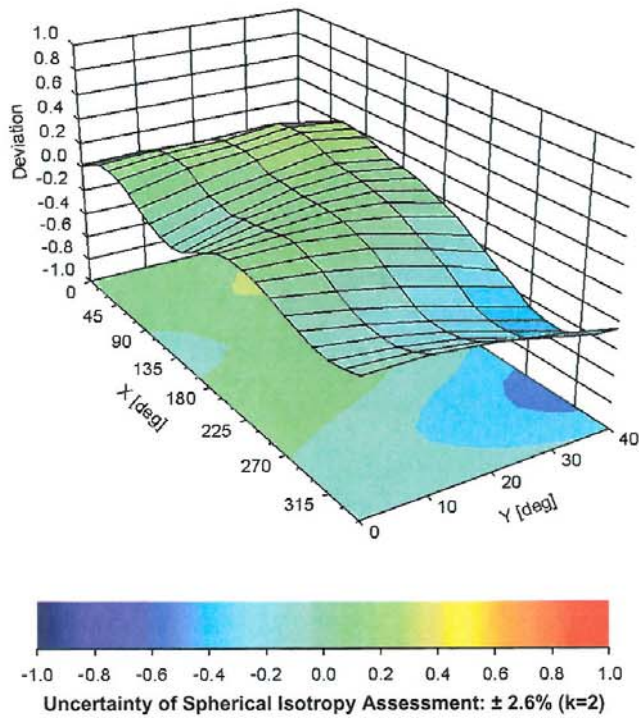

EX3DV4- SN:3933

September 22, 2014

DASY/EASY - Parameters of Probe: EX3DV4 - SN:3933**Other Probe Parameters**

Sensor Arrangement	Triangular
Connector Angle (°)	-103.6
Mechanical Surface Detection Mode	enabled
Optical Surface Detection Mode	disabled
Probe Overall Length	337 mm
Probe Body Diameter	10 mm
Tip Length	9 mm
Tip Diameter	2.5 mm
Probe Tip to Sensor X Calibration Point	1 mm
Probe Tip to Sensor Y Calibration Point	1 mm
Probe Tip to Sensor Z Calibration Point	1 mm
Recommended Measurement Distance from Surface	1.4 mm