

Leica iCON gps 160



User Manual
Version 1.1
English

- when it has to be **right**

Leica
Geosystems

PART OF
HEXAGON

Introduction

Purchase

Congratulations on the purchase of a Leica iCON gps 160 system.



This manual contains important safety directions as well as instructions for setting up the product and operating it. Refer to **1 Safety Directions** for further information.

Read carefully through the User Manual before you switch on the product.



The content of this document is subject to change without prior notice. Ensure that the product is used in accordance with the latest version of this document.

Updated versions are available for download at the following Internet address: <https://myworld.leica-geosystems.com> > myDownloads

Product identification

The model and serial number of your product are indicated on the type label. Always refer to this information when contacting your agency or Leica Geosystems authorised service centre.

Trademarks



- Windows® is a registered trademark of Microsoft Corporation in the United States and other countries
- CompactFlash and CF are trademarks of SanDisk Corporation
- *Bluetooth*® is a registered trademark of Bluetooth SIG, Inc.

All other trademarks are the property of their respective owners.

Validity of this manual

This manual applies to the Leica iCON gps 160 SmartAntenna.

Available documentation

Name	Description/Format		
Leica iCON gps 160 Quick Guide	Provides an overview of the product together with technical data and safety directions. Intended as a quick reference field guide.	✓	✓
Leica iCON gps 160 User Manual	All instructions required in order to operate the product to a basic level are contained in the User Manual. Provides an overview of the product together with technical data and safety directions.		✓

Refer to the following resources for all Leica iCON gps 160 documentation/software:

- the Leica USB documentation card
- <https://myworld.leica-geosystems.com>



<https://myworld.leica-geosystems.com> offers a wide range of services, information and training material.

With direct access to myWorld, you are able to access all relevant services whenever it is convenient for you.

The availability of services depends on the instrument model.

Service	Description
myProducts	Add all products that you and your company own and explore your world of Leica Geosystems: View detailed information on your products and update your products with the latest software and keep up-to-date with the latest documentation.
myService	View the current service status and full service history of your products in Leica Geosystems service centres. Access detailed information on the services performed and download your latest calibration certificates and service reports.
mySupport	Create new support requests for your products that will be answered by your local Leica Geosystems Support Team. View the complete history of your support requests and view detailed information on each request in case you want to refer to previous support requests.
myLearning	Welcome to the home of Leica Geosystems online learning! There are numerous online courses – available to all customers with products that have valid CCPs (Customer Care Packages).
myTrustedServices	Add your subscriptions and manage users for Leica Geosystems Trusted Services, the secure software services, that assist you to optimise your workflow and increase your efficiency.
mySmartNet	Add and view your HxGNSmartNet subscriptions and user information. HxGNSmartNet delivers high-precision and high-availability GNSS network correction services in real time. The HxGNSmartNet Global family offers Network RTK with RTK bridging and Precise Point Positioning (PPP) services. These services work exclusively with Leica Geosystems GS sensors, providing the highest accuracy. Combined, they ensure HxGNSmartNet coverage everywhere.
myDownloads	Downloads of software, manuals, tools, training material and news for Leica Geosystems products.

Table of Contents

1	Safety Directions	6
1.1	General Introduction	6
1.2	Definition of Use	7
1.3	Limits of Use	7
1.4	Responsibilities	8
1.5	Hazards of Use	8
1.6	Electromagnetic Compatibility (EMC)	12
2	Description of the System	15
2.1	System Components	15
2.2	Unpacking the Container	17
2.2.1	Base Station Container	17
2.2.2	Rover Setup Container	19
2.3	Instrument Components	20
2.4	Compatible Field Controllers	21
2.4.1	Available Field Controller	21
2.4.2	Holder and Clamps for Field Controllers	23
2.4.3	iCON Series Field Software Overview	24
3	Using the iCON gps 160 SmartAntenna	26
3.1	Power Supply	26
3.2	Batteries	27
3.2.1	Installing the Internal Battery	27
3.2.2	General Battery Handling	28
3.3	Installing a SIM Card	28
3.4	Using USB Memory Devices	30
3.5	Installation on a Machine	30
3.6	Antenna Heights	31
3.6.1	Understanding Antenna Heights	31
3.6.2	The Antenna Reference Plane, ARP	32
3.6.3	Measuring the Antenna Height for a Pillar Setup	32
3.6.4	Measuring the Antenna Height for a Tripod Setup	34
3.6.5	Measuring the Antenna Height for a Pole Setup	36
4	Setups with Accessories	37
4.1	Real-Time Base Setup	37
4.2	Local Base Station Setup with External GNSS Antenna	38
4.3	Real-Time Base with Raw Data Logging	39
4.4	Raw Data Logging Setup	40
4.5	Real-Time Rover Setup	41
4.6	Setup for Machine Use	42
4.7	Setup for Vehicle Use	43
4.8	Establish Bluetooth Data Connection	43
5	iCON gps 160 SmartAntenna User Interface	44
5.1	User Interface Description	44
5.2	Main Menu	45
5.3	Submenus	49
5.3.1	Navigation in Submenus	49
5.3.2	How to Change Settings and Edit Values	49
5.3.3	Available Sub Menus	51
6	Software Tools	58
6.1	Base Setup	58
6.1.1	Base Setup Description	58
6.1.2	Manual Base Setup	59

6.1.3	Base Setup using BasePilot	68
6.1.4	Base Coordinates	68
6.2	Rover Setup	69
6.3	ORP and NMEA Output	77
6.4	Raw Data Logging	79
6.5	Leica ConX	80
6.6	Import, Export, or Delete Data	85
6.7	Licensing	86
7	Configuration of the gps 160 SmartAntenna using the Web Interface	88
8	Coordinate Systems	89
9	Care and Transport	90
9.1	Transport	90
9.2	Storage	90
9.3	Cleaning and Drying	90
10	Technical Data	92
10.1	Technical Data iCON gps 160 SmartAntenna	92
10.1.1	Tracking Characteristics	92
10.1.2	Accuracy	92
10.1.3	General Technical Data of the Product	93
10.2	Antennas Technical Data	95
10.3	Pin Assignments and Sockets	97
10.4	Conformity Declarations	99
10.4.1	iCON gps 160	99
10.4.2	CGA100	103
10.5	Dangerous Goods Regulations	105
11	Software Licence Agreement/Warranty	106
Appendix A	NMEA Message Formats	107
A.1	Overview	107
A.2	Symbols Used for Describing the NMEA Formats	107
A.3	GGA - Global Positioning System Fix Data	110
A.4	GGK - Real-Time Position with DOP	111
A.5	GGQ - Real-Time Position with CQ	112
A.6	GLL - Geographic Position Latitude/Longitude	113
A.7	GNS - GNSS Fix Data	114
A.8	GSA - GNSS DOP and Active Satellites	115
A.9	GSV - GNSS Satellites in View	117
A.10	GST - Position Error Statistics	119
A.11	HDT - Heading, True	120
A.12	LLK - Leica Local Position and GDOP	120
A.13	LLQ - Leica Local Position and Quality	121
A.14	RMC - Recommended Minimum Specific GNSS Data	122
A.15	VTG - Course Over Ground and Ground Speed	123
A.16	ZDA - Time and Date	124
A.17	PJK - Local Coordinate Position Output	124
Appendix B	ORP – Orientation and Position	126
Appendix C	Glossary	129
C.1	C	129
C.2	G	130
C.3	N	131
C.4	W	132

1 Safety Directions

1.1 General Introduction

Description

The following directions enable the person responsible for the product, and the person who actually uses the equipment, to anticipate and avoid operational hazards.

The person responsible for the product must ensure that all users understand these directions and adhere to them.

About warning messages





Warning messages are an essential part of the safety concept of the instrument. They appear wherever hazards or hazardous situations can occur.

Warning messages...

- make the user alert about direct and indirect hazards concerning the use of the product.
- contain general rules of behaviour.

For the users' safety, all safety instructions and safety messages shall be strictly observed and followed! Therefore, the manual must always be available to all persons performing any tasks described here.

DANGER, WARNING, CAUTION and **NOTICE** are standardised signal words for identifying levels of hazards and risks related to personal injury and property damage. For your safety, it is important to read and fully understand the following table with the different signal words and their definitions! Supplementary safety information symbols may be placed within a warning message as well as supplementary text.

Type	Description
 DANGER	Indicates an imminently hazardous situation which, if not avoided, will result in death or serious injury.
 WARNING	Indicates a potentially hazardous situation or an unintended use which, if not avoided, could result in death or serious injury.
 CAUTION	Indicates a potentially hazardous situation or an unintended use which, if not avoided, may result in minor or moderate injury.
NOTICE	Indicates a potentially hazardous situation or an unintended use which, if not avoided, may result in appreciable material, financial and environmental damage.
	Important paragraphs which must be adhered to in practice as they enable the product to be used in a technically correct and efficient manner.

Additional symbols



Warning against explosive material.



Warning against flammable substances.



Product must not be opened or modified or tampered with.



Indicates the temperature limits at which the product may be stored, transported or used.

1.2

Definition of Use

Intended use

- Computing with software.
- Carrying out measurement tasks using various GNSS measuring techniques.
- Recording GNSS and point related data.
- Remote control of product.
- Data communication with external appliances.
- Measuring raw data and computing coordinates using carrier phase and code signal from GNSS satellites.

Reasonably foreseeable misuse

- Use of the product without instructions
- Use outside of the intended use and limits
- Disabling of safety systems
- Removal of hazard notices
- Opening the product using tools, for example a screwdriver, unless this is permitted for certain functions
- Modification or conversion of the product
- Use after misappropriation
- Use of products with recognisable damage or defects
- Use with accessories from other manufacturers without the prior explicit approval of Leica Geosystems
- Inadequate safeguards at the working site
- Controlling of machines, moving objects or similar monitoring applications without additional control and safety installations

1.3

Limits of Use

Environment

Suitable for use in an atmosphere appropriate for permanent human habitation. Not suitable for use in aggressive or explosive environments.

WARNING

Working in hazardous areas or close to electrical installations or similar situations

Life Risk.

Precautions:

- ▶ Local safety authorities and safety experts must be contacted by the person responsible for the product before working in such conditions.

1.4

Responsibilities

Manufacturer of the product

Leica Geosystems AG, CH-9435 Heerbrugg, hereinafter referred to as Leica Geosystems, is responsible for supplying the product, including the User Manual and original accessories, in a safe condition.

Person responsible for the product

The person responsible for the product has the following duties:

- To understand the safety instructions on the product and the instructions in the User Manual
- To ensure that the product is used in accordance with the instructions
- To be familiar with local regulations relating to safety and accident prevention
- To stop operating the system and inform Leica Geosystems immediately if the product and the application become unsafe
- To ensure that the national laws, regulations and conditions for the operation of the product are respected
- To ensure that radio modems are not operated without the permission of the local authorities on frequencies and/or output power levels other than those specifically reserved and intended for use without a specific permit. The internal and external radio modems have been designed to operate on frequency ranges and output power ranges, the exact use of which differs from one region and/or country to another.

1.5

Hazards of Use

NOTICE

Dropping, misusing, modifying, storing the product for long periods or transporting the product

Watch out for erroneous measurement results.

Precautions:

- ▶ Periodically carry out test measurements and perform the field adjustments indicated in the User Manual, particularly after the product has been subjected to abnormal use as well as before and after important measurements.

DANGER

Risk of electrocution

Because of the risk of electrocution, it is dangerous to use poles, levelling staffs and extensions in the vicinity of electrical installations such as power cables or electrical railways.

Precautions:

- ▶ Keep at a safe distance from electrical installations. If it is essential to work in this environment, first contact the safety authorities responsible for the electrical installations and follow their instructions.



WARNING

Distraction/loss of attention

During dynamic applications, for example stakeout procedures, there is a danger of accidents occurring if the user does not pay attention to the environmental conditions around, for example obstacles, excavations or traffic.

Precautions:

- ▶ The person responsible for the product must make all users fully aware of the existing dangers.
-

WARNING

Inadequate securing of the working site

This can lead to dangerous situations, for example in traffic, on building sites and at industrial installations.

Precautions:

- ▶ Always ensure that the working site is adequately secured.
 - ▶ Adhere to the regulations governing safety, accident prevention and road traffic.
-

CAUTION

Not properly secured accessories

If the accessories used with the product are not properly secured and the product is subjected to mechanical shock, for example blows or falling, the product may be damaged or people can sustain injury.

Precautions:

- ▶ When setting up the product, make sure that the accessories are correctly adapted, fitted, secured, and locked in position.
 - ▶ Avoid subjecting the product to mechanical stress.
-

CAUTION

Unused connectors must be protected using the attached dust cap.

WARNING

Lightning strike

If the product is used with accessories, for example masts, staffs, poles, you may increase the risk of being struck by lightning.

Precautions:

- ▶ Do not use the product in a thunderstorm.
-

⚠ DANGER

Risk of being struck by lightning

If the product is used with accessories, for example on masts, staffs, poles, you may increase the risk of being struck by lightning. Danger from high voltages also exists near power lines. Lightning, voltage peaks, or the touching of power lines can cause damage, injury and death.

Precautions:

- ▶ Do not use the product in a thunderstorm as you can increase the risk of being struck by lightning.
- ▶ Be sure to remain at a safe distance from electrical installations. Do not use the product directly under or close to power lines. If it is essential to work in such an environment contact the safety authorities responsible for electrical installations and follow their instructions.
- ▶ If the product has to be permanently mounted in an exposed location, it is advisable to provide a lightning conductor system. A suggestion on how to design a lightning conductor for the product is given below. Always follow the regulations in force in your country regarding grounding antennas and masts. These installations must be carried out by an authorised specialist.
- ▶ To prevent damages due to indirect lightning strikes (voltage spikes) cables, for example for antenna, power source or modem should be protected with appropriate protection elements, like a lightning arrester. These installations must be carried out by an authorised specialist.
- ▶ If there is a risk of a thunderstorm, or if the equipment is to remain unused and unattended for a long period, protect your product additionally by unplugging all systems components and disconnecting all connecting cables and supply cables, for example, instrument - antenna.

Lightning conductors

Suggestion for design of a lightning conductor for a GNSS system:

1. On non-metallic structures
Protection by air terminals is recommended. An air terminal is a pointed solid or tubular rod of conducting material with proper mounting and connection to a conductor. The position of four air terminals can be uniformly distributed around the antenna at a distance equal to the height of the air terminal.
The air terminal diameter should be 12 mm for copper or 15 mm for aluminium. The height of the air terminals should be 25 cm to 50 cm. All air terminals should be connected to the down conductors. The diameter of the air terminal should be kept to a minimum to reduce GNSS signal shading.
2. On metallic structures
Protection is as described for non-metallic structures, but the air terminals can be connected directly to the conducting structure without the need for down conductors.

Air terminal arrangement, plan view

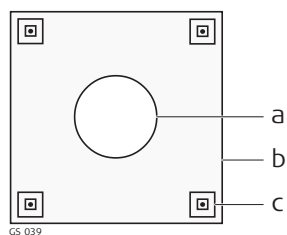

- a Antenna
- b Support structure
- c Air terminal

Grounding the instrument/antenna

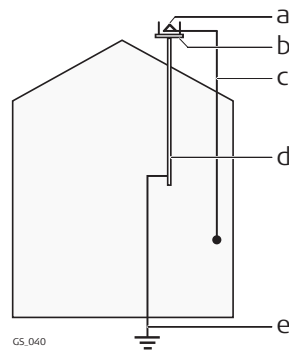

- a Antenna
- b Lightning conductor array
- c Antenna/instrument connection
- d Metallic mast
- e Connection to earth

⚠ WARNING

Inappropriate mechanical influences to batteries

During the transport, shipping or disposal of batteries it is possible for inappropriate mechanical influences to constitute a fire hazard.

Precautions:

- ▶ Before shipping the product or disposing it, discharge the batteries by the product until they are flat.
- ▶ When transporting or shipping batteries, the person in charge of the product must ensure that the applicable national and international rules and regulations are observed.
- ▶ Before transportation or shipping, contact your local passenger or freight transport company.

⚠ WARNING

Exposure of batteries to high mechanical stress, high ambient temperatures or immersion into fluids

This can cause leakage, fire or explosion of the batteries.

Precautions:

- ▶ Protect the batteries from mechanical influences and high ambient temperatures. Do not drop or immerse batteries into fluids.

⚠ WARNING

Short circuit of battery terminals

If battery terminals are short circuited e.g. by coming in contact with jewellery, keys, metallised paper or other metals, the battery can overheat and cause injury or fire, for example by storing or transporting in pockets.

Precautions:

- ▶ Make sure that the battery terminals do not come into contact with metallic/conductive objects.

WARNING

Incorrect fastening of the external antenna

Incorrect fastening of the external antenna to vehicles or transporters poses the risk of the equipment being broken by mechanical influence, vibration or airstream. This may result in accident and physical injury.

Precautions:

- ▶ Attach the external antenna professionally. The external antenna must be secured additionally, for example by use of a safety cord. Ensure that the mounting device is correctly mounted and able to carry the weight of the external antenna (>1 kg) safely.

WARNING

Improper disposal

If the product is improperly disposed of, the following can happen:

- If polymer parts are burnt, poisonous gases are produced which may impair health.
- If batteries are damaged or are heated strongly, they can explode and cause poisoning, burning, corrosion or environmental contamination.
- By disposing of the product irresponsibly you may enable unauthorised persons to use it in contravention of the regulations, exposing themselves and third parties to the risk of severe injury and rendering the environment liable to contamination.

Precautions:

▶



The product must not be disposed with household waste. Dispose of the product appropriately in accordance with the national regulations in force in your country. Always prevent access to the product by unauthorised personnel.

Product-specific treatment and waste management information can be received from your Leica Geosystems distributor.

WARNING

Improperly repaired equipment

Risk of injuries to users and equipment destruction due to lack of repair knowledge.

Precautions:

- ▶ Only authorised Leica Geosystems Service Centres are entitled to repair these products.

1.6

Electromagnetic Compatibility (EMC)

Description

The term Electromagnetic Compatibility is taken to mean the capability of the product to function smoothly in an environment where electromagnetic radiation and electrostatic discharges are present, and without causing electromagnetic disturbances to other equipment.

 **CAUTION**

Electromagnetic radiation

Electromagnetic radiation can cause disturbances in other equipment.

Precautions:

- ▶ Although the product meets the strict regulations and standards which are in force in this respect, Leica Geosystems cannot completely exclude the possibility that other equipment may be disturbed.

 **CAUTION**

Use of the product with accessories from other manufacturers. For example, field computers, personal computers or other electronic equipment, non-standard cables or external batteries

This may cause disturbances in other equipment.

Precautions:

- ▶ Use only the equipment and accessories recommended by Leica Geosystems.
- ▶ When combined with the product, other accessories must meet the strict requirements stipulated by the guidelines and standards.
- ▶ When using computers, two-way radios or other electronic equipment, pay attention to the information about electromagnetic compatibility provided by the manufacturer.

 **CAUTION**

Intense electromagnetic radiation. For example, near radio transmitters, transponders, two-way radios or diesel generators

Although the product meets the strict regulations and standards which are in force in this respect, Leica Geosystems cannot completely exclude the possibility that the function of the product may be disturbed in such an electromagnetic environment.

Precautions:

- ▶ Check the plausibility of results obtained under these conditions.

 **CAUTION**

Electromagnetic radiation due to improper connection of cables

If the product is operated with connecting cables, attached at only one of their two ends, the permitted level of electromagnetic radiation may be exceeded and the correct functioning of other products may be impaired. For example, external supply cables or interface cables.

Precautions:

- ▶ While the product is in use, connecting cables, for example product to external battery or product to computer, must be connected at both ends.

 **WARNING**

Use of product with radio or digital cellular phone devices

Electromagnetic fields can cause disturbances in other equipment, installations, medical devices, for example pacemakers or hearing aids, and aircrafts. Electromagnetic fields can also affect humans and animals.

Precautions:

- ▶ Although the product meets the strict regulations and standards which are in force in this respect, Leica Geosystems cannot completely exclude the possibility that other equipment can be disturbed or that humans or animals can be affected.
 - ▶ Do not operate the product with radio or digital cellular phone devices in the vicinity of filling stations or chemical installations, or in other areas where an explosion hazard exists.
 - ▶ Do not operate the product with radio or digital cellular phone devices near medical equipment.
 - ▶ Do not operate the product with radio or digital cellular phone devices in aircrafts.
 - ▶ Do not operate the product with radio or digital cellular phone devices for long periods with the product immediately next to your body.
-

2

Description of the System

2.1

System Components

Description

The Leica iCON gps 160 SmartAntenna together with dedicated accessories such as the Leica CGA100 GNSS antenna and Field Controller, offer you highest productivity and flexibility. For example, a Base Station configuration as well as Rover configuration is possible, but the system also can be used in a Machine configuration.

Two example configurations are shown in the following paragraphs.

Main components, Base Station configuration

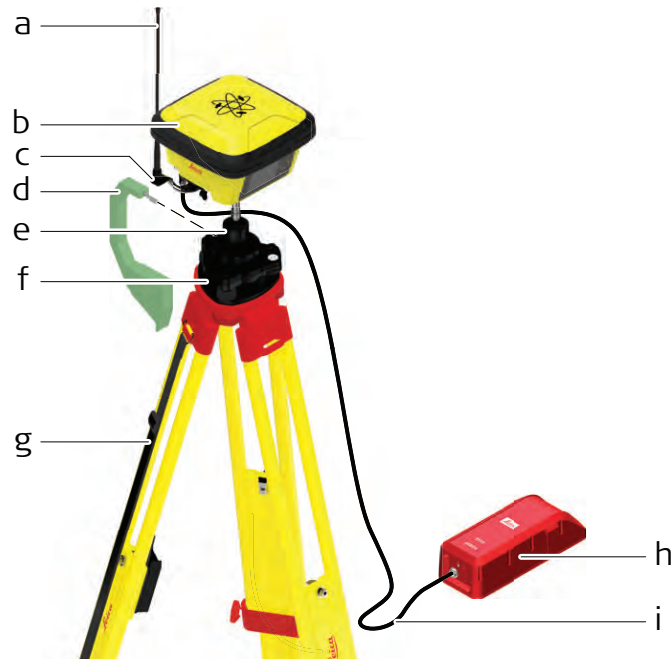

25022_001

a	Radio antenna	f	Tribrach
b	iCON gps 160 SmartAntenna	g	Tripod
c	CA51 Antenna arm	h	GEB373 external battery
d	GSZ4-1 Height hook	i	GEV219 power cable
e	GRT246 Carrier		

Component	Description
iCON gps 160 SmartAntenna	To calculate the position from the computed ranges to all visible GNSS (Global Navigation Satellite System) satellites.
Radio antenna	For optimum radio coverage.
Tripod, tribrach, carrier	To setup the instrument as a Base Station.

Main components, Rover configuration

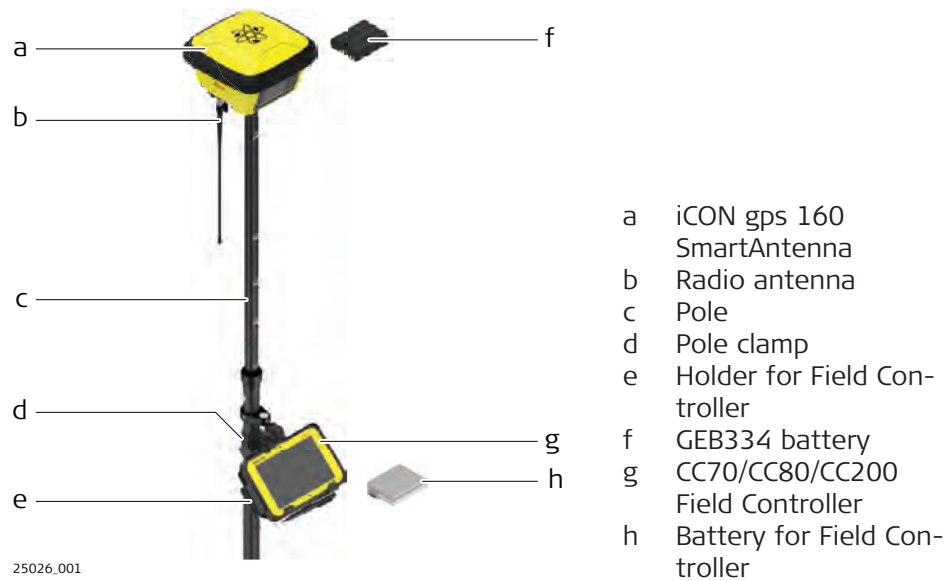

Component	Description
iCON gps 160 SmartAntenna	To calculate the position from the computed ranges to all visible GNSS (G lobal N avigation S atellite S ystem) satellites.
Field Controller	Compatible controllers running iCON field software can be used to operate the iCON gps 160 SmartAntenna.
Radio antenna	For optimum radio coverage.
Pole, pole clamp, holder for Field Controller	To setup the instrument as a Rover.

Satellite channels

Depending on the satellite systems and signals configured, a maximum number of 555 channels is allocated.

Instrument	Description
iCON gps 160 SmartAntenna	GPS, GLONASS, BeiDou and Galileo GNSS receiver, triple frequency, code and phase, real-time capable

Special features iCON gps 160 SmartAntenna

iCON gps 160 SmartAntenna is equipped with several special features:

- Wide supply voltage range of 9 V to 35 V
- Voltage peak protection and reverse polarity protection
- Can be used on a machine when being mounted inside the cabin
- Can be used near the sea
- Protection caps on connectors
- Display and keys for status and configuration
- Versatile connectivity including USB, Serial RS232 and Bluetooth
- USB host port for data transfer and firmware upgrade
- Built-in high speed LTE (4G) / HSPA (3.5G) modem
- Built-in radio options
- Robust, compact housing with aluminium bottom and plastic top

Special features CGA100

CGA100 antennas are equipped with several special features:

- Can be used near the sea
- Standard robust 5/8" Whitworth thread
- Robust TNC connector
- Future proof four constellation, multi-frequency antenna element
- Robust, compact plastic housing

Commands for Remote Config

The iCON gps 160 SmartAntenna can be communicated:

- via the Leica Machine Control Net Protocol on the serial port P1 and Bluetooth.

Documentation for the communication protocol is available on request from the Leica Geosystems representative.

2.2

Unpacking the Container

Description

Available delivery packages:

- Hard-top container comprising all items for a GNSS Rover setup.
- Hard-top container comprising all items for a Base Station setup, including various Field Controllers.

2.2.1

Base Station Container

CTC9 Container upper shell

The large-size CTC9 container comprises all items for the Base Station setup. The content of the upper shell is the same for all available container configuration.

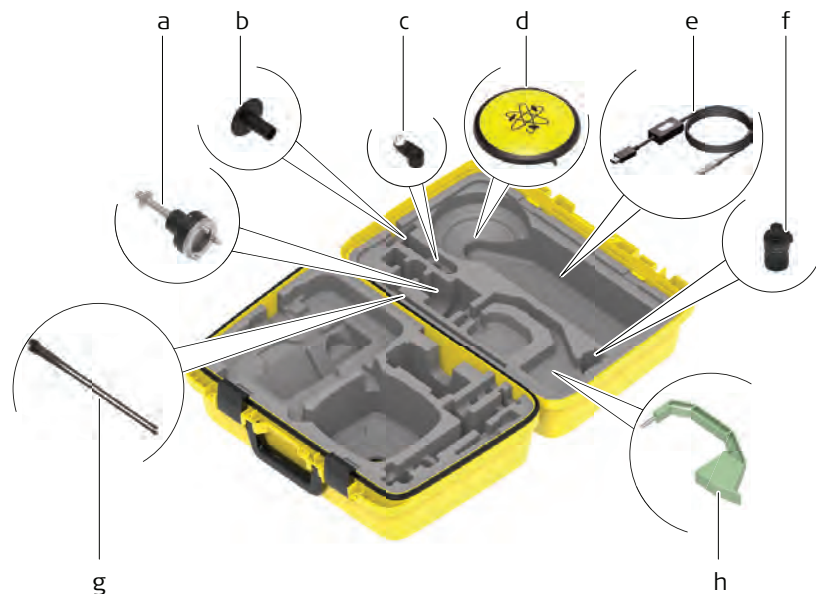

25032.001

- | | | | |
|---|--|---|----------------------------|
| a | GRT246 Carrier | e | GEV269 Data transfer cable |
| b | GHT36 Base for telescopic rod | f | CRP15 Quick Snap Connector |
| c | GAD34 Arm, adapter antenna to extension | g | GAT1/GAT2 Radio antennas |
| d | CGA100 robust multi-frequency GNSS antenna | h | GSZ4-1 Height hook |

CTC9 container lower shell with iCON CC70/CC80/CC200

Large-size CTC9 container configuration with iCON Field Controller.

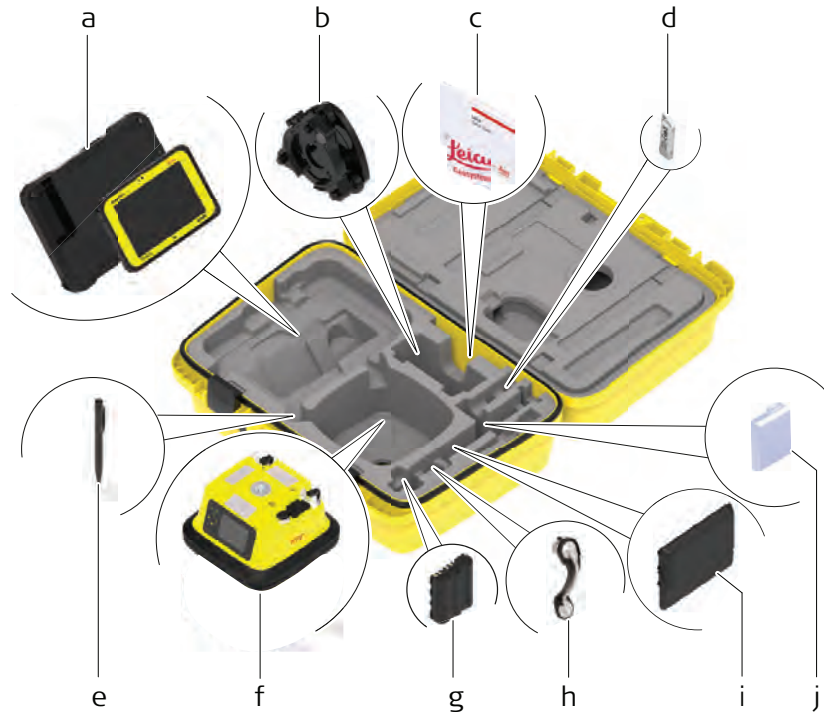

25034.001

- | | | | |
|---|------------------------------------|---|--|
| a | CC200/CC70/CC80 Field Controller | f | iCON gps 160 SmartAntenna |
| b | Tribrach | g | GEB334 Battery |
| c | Manual & USB documentation card | h | CA51 Antenna arm |
| d | MS1 Industrial 1GB USB flash drive | i | Spare battery for CC200 Field Controller |
| e | Stylus for Field Controller | j | Spare battery for CC70/CC80 Field Controller |

2.2.2

Rover Setup Container

CTC9 Container upper shell

The CTC9 container comprises all items for the Rover setup of the iCON gps 160 SmartAntenna and its accessories.

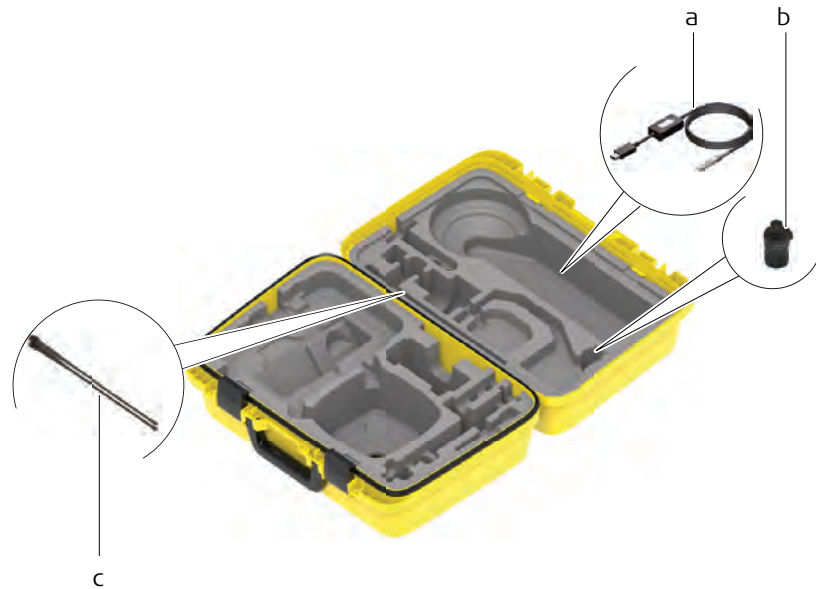

25032.001

- a GEV269 Data transfer cable
- b CRP15 Quick Snap Connector
- c GAT1/GAT2 Radio antennas

CTC9 container lower shell with iCON CC70/CC80

CTC9 container configuration with iCON Field Controller and accessories.

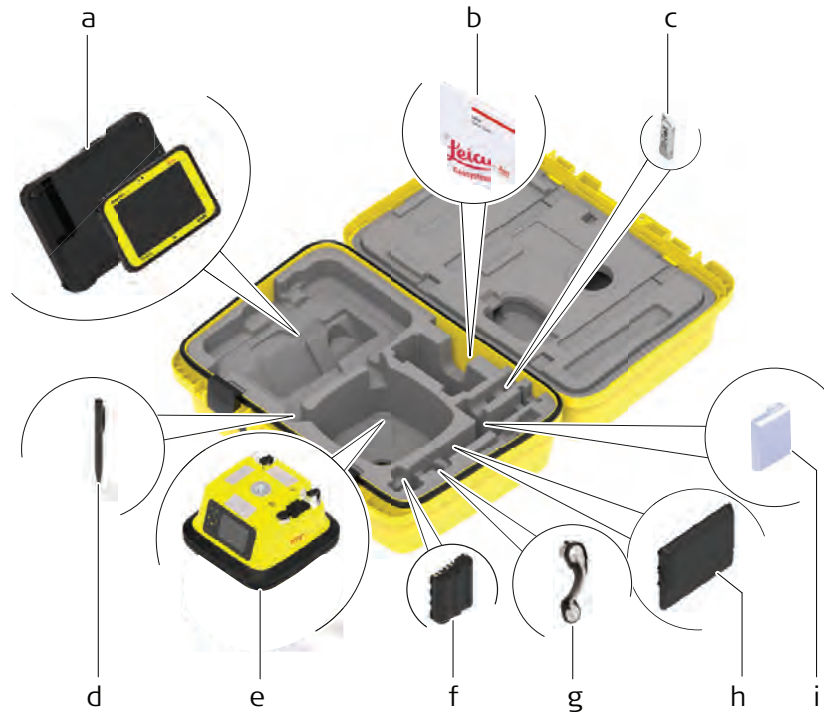

25035.001

- | | | | |
|---|------------------------------------|---|--|
| a | CC200/CC70/CC80 Field Controller | e | iCON gps 160 SmartAntenna |
| b | Manual & USB documentation card | f | GEB334 Battery |
| c | MS1 Industrial 1GB USB flash drive | g | CA51 Antenna arm |
| d | Stylus for Field Controller | h | Spare battery for CC200 Field Controller |
| | | i | Spare battery for CC70/CC80 Field Controller |

2.3

Instrument Components

iCON gps 160 SmartAntenna components

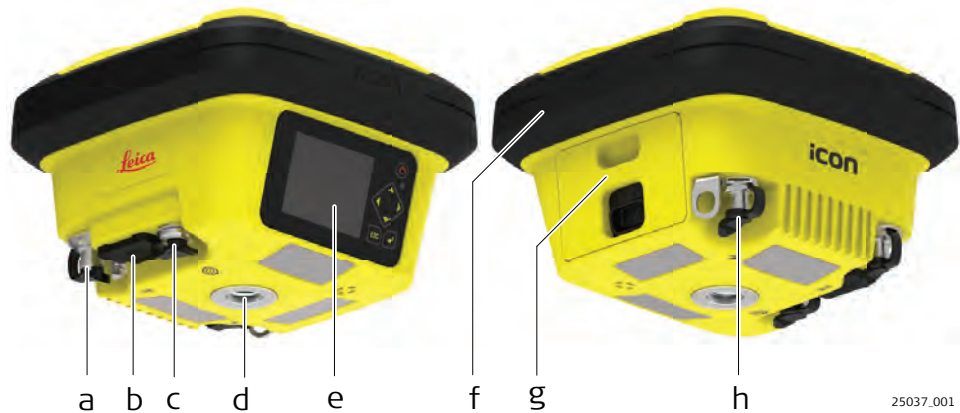

25037.001

- | | | | |
|---|-------------------------------|---|---|
| a | Radio antenna connector (TNC) | f | Internal Bluetooth antenna |
| b | USB data port, Type A | g | Battery compartment and SIM card holder |
| c | LEMO connector (serial) | h | GNSS antenna connector (TNC) |
| d | Whitworth thread, 5/8" | | |
| e | Display and action buttons | | |

Element	Function
USB 2.0	USB A data port, for data exchange, software updates.
LEMO connector (8-pin, female)	RS232 for connection of external power supply or data in/out.
GNSS antenna connector (TNC)	For connection of an external GNSS antenna, for example CGA100 for reference setup and machine use case.
Radio antenna connector (TNC)	For connection of an external antenna for the internal radio.

CGA100 components



21302_001

- a Whitworth thread, 5/8"
- b Antenna reference plane
- c TNC female connector

2.4

Compatible Field Controllers

2.4.1

Available Field Controller

About the controllers



The iCON gps 160 SmartAntenna can be used as a standalone device or in combination with compatible controllers running iCON field software.

CC70/CC80 upside

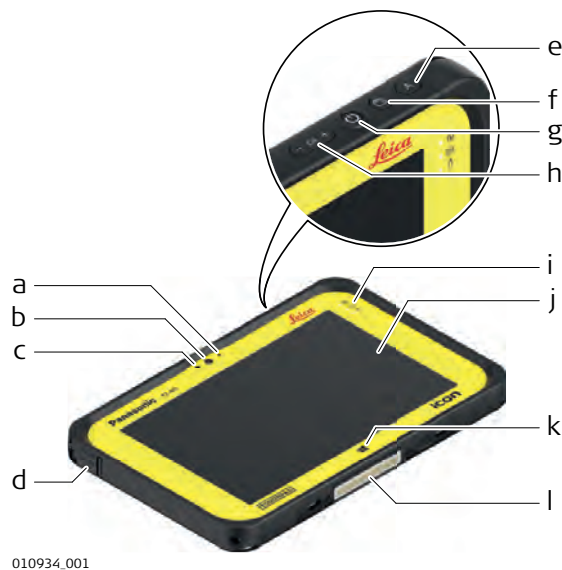

010934_001

- a Camera Indicator
- b Camera Lens
- c Ambient Light Sensor
- d Power connector, DC power supply in
- e Measure key
- f Touch mode selection
- g Power key
- h Volume key
- i Status LEDs, for power, hard drive, and battery
- j Display
- k Windows key
- l Docking station contacts

CC70/CC80 rear side



- a Microphone
- b Battery pack
- c Headset connector
- d USB connector
- e Rear camera: lens, light, and indicator
- f Battery lock
- g microSIM card slot
- h microSD memory card slot

CC200

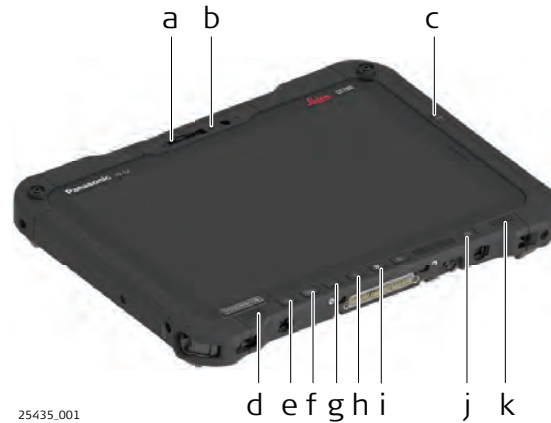

- a Front camera with privacy cover
- b Ambient light sensor
- c Hard key A3: dedicated to 'Measure'
- d Speakers
- e Hard key A1: user-definable
- f Hard Key A2: user-definable
- g Volume -
- h Volume +
- i Windows' key
- j Power button
- k Speakers

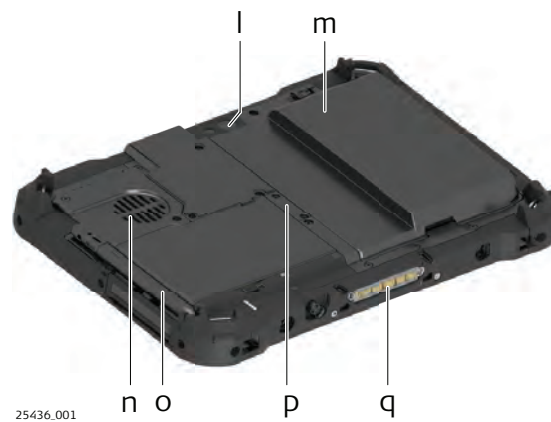

- l Rear camera
- m Battery compartment
- n Fan
- o Digitizer pen
- p SIM card slot
- q Docking connector

Holder for CC70/CC80

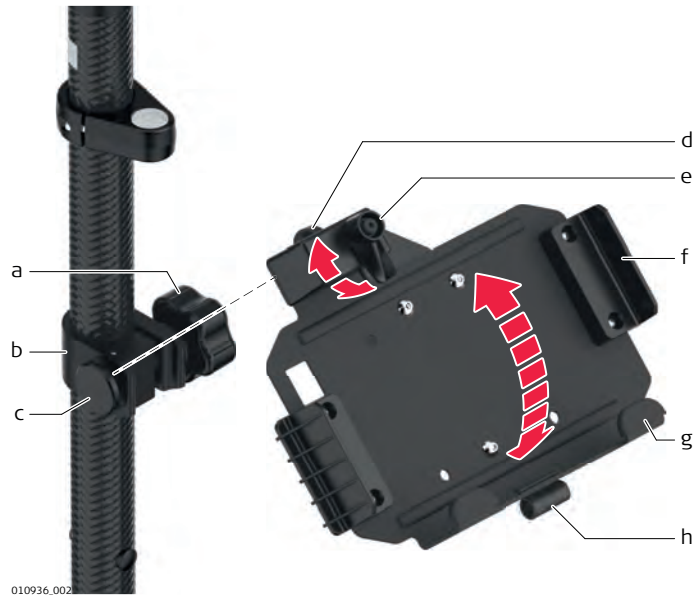

010936_002

Clamp

- a Tightening screw
- b Pole clamp
- c Clamping bolt

Holder

- d Mounting arm
- e Locking lever
- f Mounting brackets (side)
- g Mounting brackets (bottom)
- h Holder for stylus

Bracket for CC200

Pole mount

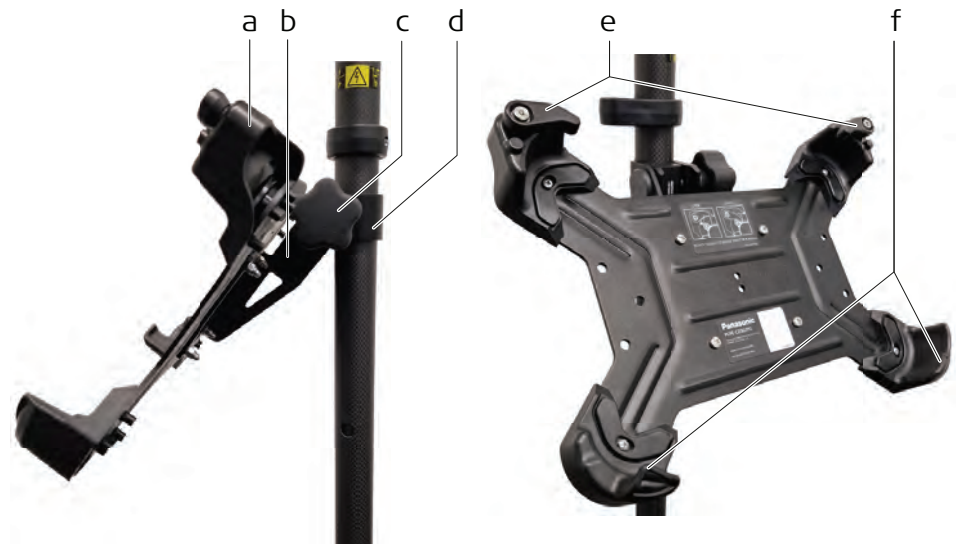

25437_001

- a Tablet holder
- b Mounting arm
- c Tightening screw
- d Pole clamp

- e Locking levers
- f Mounting brackets

Machine mount



26028.001

- | | | | |
|---|------------------|---|---|
| a | Tablet holder | e | Double socket arm |
| b | Pole clamp | f | Adjustment knob |
| c | Tightening screw | g | Suction cup for mounting on the machine surface |
| d | Mounting arm | | |

2.4.3

iCON Series Field Software Overview



The iCON site/iCON build Field Software is the recommended software on the compatible Field Controllers to run the iCON gps 160 SmartAntenna. Sole Base Station and Rover use is also possible with the on-board software.

iCON site software - main menu at a glance



Refer to the iCON site software and documentation for further information.

**iCON build software
- main menu at a
glance**

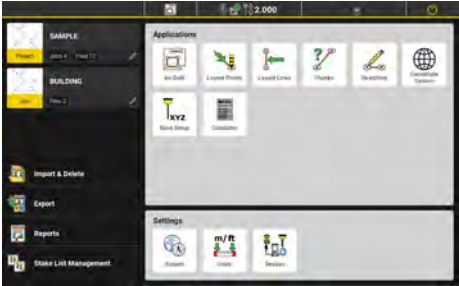

Refer to the iCON build software and documentation for further information.

3 Using the iCON gps 160 SmartAntenna

3.1 Power Supply

General

Use the batteries, chargers and accessories recommended by Leica Geosystems to ensure the correct functionality of the instrument.



- The battery must be charged before using it for the first time.
 - For new batteries or batteries that have been stored for more than 3 months, one charge and discharge cycle is recommended.
-

Internal and external power supply

Power for the instrument can be supplied by the internal GEB334 battery or externally.

External power can be supplied by:

- 9 V to 35 V DC power supply (machine or vehicle) via a converter cable supplied by Leica Geosystems.
- GEB373 battery connected via a cable.
- 110 V/240 V AC to 12 V DC power supply unit, supplied by Leica Geosystems.



External power for the iCON gps 160 SmartAntenna can be supplied using the LEMO port.



The iCON gps 160 SmartAntenna can use internal and external power supply in parallel.



For permanent operations use **Uninterruptible Power Supply** units as a backup in a main power failure.



In general, all installation works - including the setting up of a permanent power supply - must be done by a dedicated installation specialist. Please contact the local selling unit or dealer for further information.

3.2

Batteries

3.2.1

Installing the Internal Battery

Insert and remove the battery step-by-step



1. Push the slide fastener of the battery compartment in the direction of the arrow with the open-lock symbol.
2. Remove the cover.
3. To remove the battery, push the retaining clip downwards. This releases the battery from its fixed position.
4. Remove the battery.
5. To insert the battery, slide the battery into the battery compartment with the battery contacts facing upwards. Push the battery into the compartment so that it locks into position.
6. Put the cover of the battery compartment back into place.
7. Push the slide fastener in the direction of the arrow with the close-lock symbol.

3.2.2

General Battery Handling

First-time use/ charging batteries

- The battery must be charged before using it the first time, because it is delivered with an energy content as low as possible or might be in sleep mode.
 - The permissible temperature range for charging is from 0 °C to +40 °C/ +32 °F to +104 °F. For optimal charging, we recommend charging the batteries at a low ambient temperature of +10 °C to +20 °C/+50 °F to +68 °F if possible
 - It is normal for the battery to become warm during charging. Using the chargers recommended by Leica Geosystems, it is not possible to charge the battery once the temperature is too high
 - For new batteries or batteries that have been stored for a long time (> three months), it is effectual to make a discharge/charge cycle
 - For Li-Ion batteries, a single discharge/charge cycle is sufficient. We recommend carrying out the process when the battery capacity indicated on the charger or on a Leica Geosystems product deviates significantly from the actual battery capacity available.
-

Operation / Discharging

- The batteries can be operated from -20°C to +60°C/-4°F to +140°F.
 - Low operating temperatures reduce the capacity that can be drawn; high operating temperatures reduce the service life of the battery.
-

3.3

Installing a SIM Card



- Keep the card dry.
 - Use it only within the specified temperature range.
 - Do not bend the card.
 - Protect the card from direct impacts.
-



Failure to follow these instructions could result in data loss and/or permanent damage to the card.

Insert and remove the SIM card step-by-step



25039.00x



Ensure the instrument is placed on a stable surface.

1. Push the slide fastener of the battery compartment in the direction of the arrow with the open-lock symbol. Remove the cover.
2. Remove the battery by pushing the retaining clip downwards. This releases the battery from its fixed position. Remove the battery.
3. Orientate the SIM card as illustrated. Insert the SIM card into the card slot and push it in until it locks in place.
 The SIM card needs to be of size "Micro".
4. Insert the battery by sliding the battery into the battery compartment with the battery contacts facing upwards. Push the battery into the compartment so that it locks into position. Put the cover of the battery compartment back into place.
5. Push the slide fastener in the direction of the arrow with the close-lock symbol.

3.4

Using USB Memory Devices

Insert and remove a USB Memory device step-by-step



25041.001

☞ Ensure the instrument is placed on a stable surface.

1. Remove the cap from the USB flash drive.
2. Detach the USB port cover.
3. Slide the USB flash drive firmly into the USB host port.

☞ Take care not to damage the USB flash drive when moving the iCON gps 160 SmartAntenna or when handling around the device.

☞ It is recommended to close the USB port cover when not in use.

Preconditions for using USB Memory devices

- USB Memory devices must be formatted in FAT, FAT32 or exFAT format.
- To import data from a USB Memory device to the iCON gps 160 SmartAntenna, appropriate folders must be created on the USB device and the files placed in the correct folder. Refer to [6.6 Import, Export, or Delete Data](#) for further information.

3.5

Installation on a Machine



In general, all installation works must be done by a dedicated installation specialist. Please contact the local selling unit or dealer for further information.

The installation information within this User Manual is indicated to increase the operators understanding of the system and its maintaining.



Before installation:

- Please observe the maximum vibration and ambient temperature values indicated in chapter [10 Technical Data](#).
- Check that all parts needed are delivered. Refer to [2.2 Unpacking the Container](#) for further information.
- It is strongly recommended that you bench test all components before commencing installation on the actual machine to make sure that all components are fully operational.

iCON gps 160 SmartAntenna Installation location

The iCON gps 160 SmartAntenna must be installed in the machine cabin itself. For easy mounting the optional Machine Bracket CMB3 is recommended.



The product must not be installed on the tool of the machine and/or on mechanical components that move the tool. Tools include for example bucket of excavator, blade of dozer, screed of paver. Mechanical parts include for example boom and stick of an excavator, hydraulic cylinder of a dozer or tow arm of an asphalt paver. Further, the instrument must not be installed near chassis, chain gear, wheels or on engine components connected to the engine itself. The cases stated are intended simply as examples. The instrument must not be installed on a mast as well.

Installation of a CGA100 GNSS antenna

For best results, it is recommended to mount the GNSS antenna in a way ensuring an unobstructed view of the sky.

Installation of antenna for internal radio

- External antennas with a magnetic mount can be used and installed on the roof of the cabin.
- This will increase the radio signal and therefore the reception of correction signals from a base station.

Cable installation

- Ensure that cables between the iCON gps 160 SmartAntenna and the CGA100 antenna in particular are installed in a way that prevents them from getting bent and stretched.
- It is strongly recommended to use strain relief brackets.
- Route the cable as directly as possible and avoid crossing cables.
- Be sure not to tie the cables into "hot" hydraulic hoses.

3.6

Antenna Heights

3.6.1

Understanding Antenna Heights

Description

The height of the GNSS antenna above a point consists of three components:

- the vertical height reading,
- the vertical offset,
- the vertical phase centre offset.

For most operations, pre-configured standard settings in the instrument can be used. They automatically take the vertical phase centre offsets into account.

ARP

The antenna accepts vertical height readings to the **Antenna Reference Plane**, ARP.

Vertical phase centre variations

These are handled automatically in the standard antenna records. The antenna calibrations to determine the phase centre variations were executed by Geo++ GmbH.



Pillar setup. For other than the GRT246 carrier, the dimensions must be determined and the vertical offset must be adapted.



Tripod setup. For height measurement devices other than the height hook, the dimensions must be determined and the vertical offset must be adapted.



Pole setup. For other than Leica poles, the dimensions must be determined.



Mast setup. The dimensions of the mast must be determined.

3.6.2

The Antenna Reference Plane, ARP

Description

The Antenna Reference Plane:

- Is where the instrument heights are measured to.
- Is where the phase centre variations refer to.
- Varies for different instruments.

ARP of the antenna

The ARP for the antenna is shown in the diagram.



- a The Antenna Reference Plane is the underside of the threaded metal insert.

ARP of the antenna

The ARP for the CGA100 antenna is shown in the diagram.

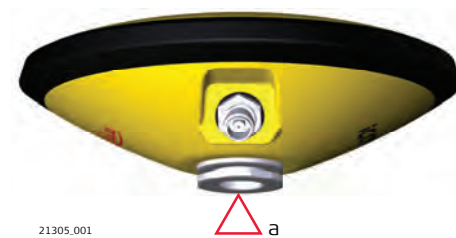

- a The Antenna Reference Plane is the underside of the threaded metal insert.

3.6.3

Measuring the Antenna Height for a Pillar Setup

Measuring the antenna height - pillar setup

Setup type	Antenna name	The required measurement
Pillar	iCON gps 160 SmartAntenna	the vertical height reading to the ARP.

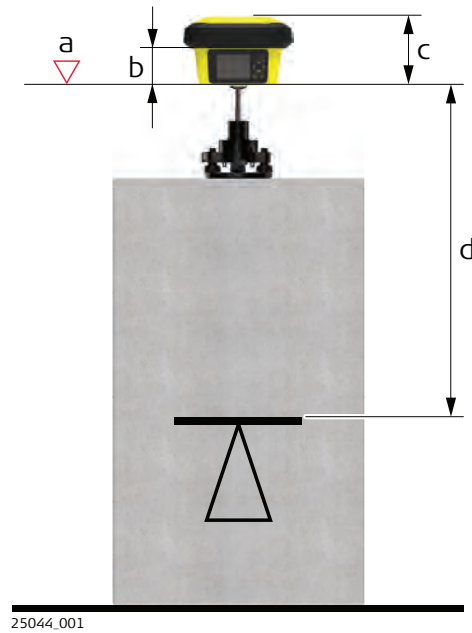

- a Antenna reference plane ARP
- b Vertical phase centre offset for L1
- c Vertical phase centre offset for L2
- d **Vertical Height Reading**
No vertical offset.

25044_001

Determining the antenna height with the GRT246 carrier step-by-step

1. Measure a height from the pillar benchmark to a surface on the carrier.
2. Use the appropriate measurement from the diagram above. Determine the height difference between the measured surface on the carrier and where the ARP of the antenna sits on the carrier.
3. The vertical height reading = adding the values in step 1. and step 2.

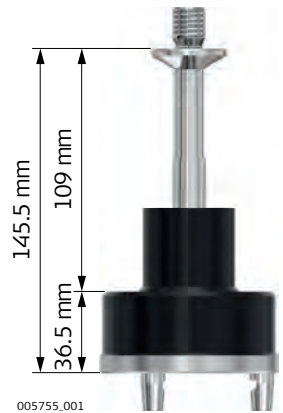

005755_001

Measuring the antenna height - pillar setup

Setup type	Antenna name	The required measurement
Pillar	CGA100	the vertical height reading to the ARP.

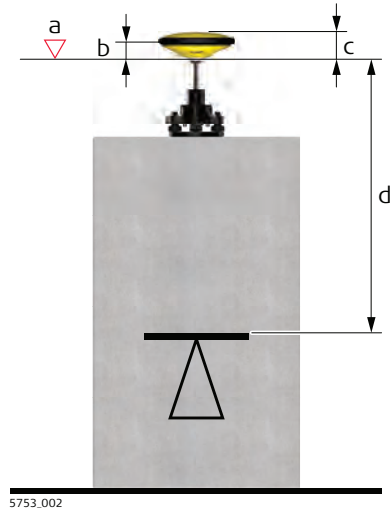

- a Antenna reference plane ARP
 - b Vertical phase centre offset for L1
 - c Vertical phase centre offset for L2
 - d Vertical Height Reading
- No vertical offset.

Determining the antenna height with the GRT246 carrier step-by-step

1. Measure a height from the pillar benchmark to a surface on the carrier.
2. Use the appropriate measurement from the diagram above. Determine the height difference between the measured surface on the carrier and where the ARP of the antenna sits on the carrier.
3. The vertical height reading = adding the values in step 1. and step 2.

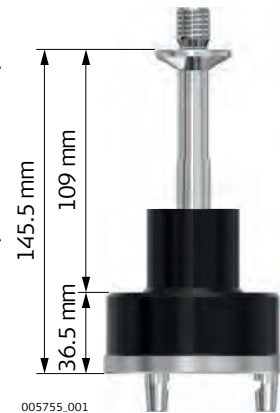

3.6.4

Measuring the Antenna Height for a Tripod Setup

Measuring the antenna height - tripod setup

Setup Type	Antenna type	The required measurement
Tripod	iCON gps 160 SmartAntenna	the vertical height reading from the height hook.

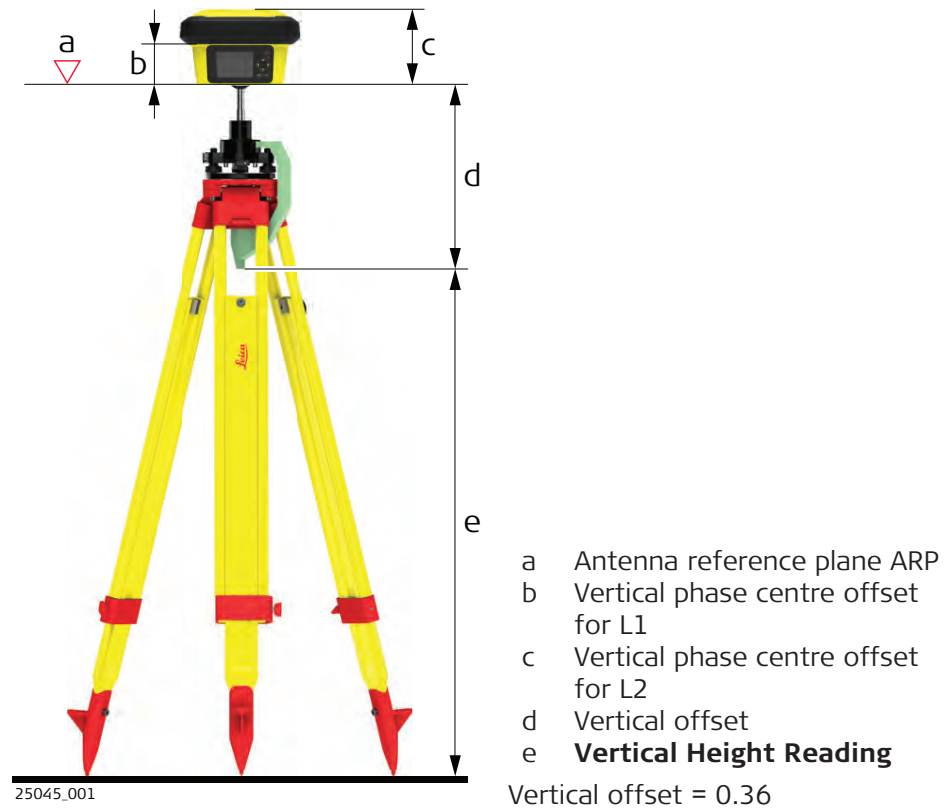

Determining the antenna height with the height hook step-by-step

- The vertical height reading = vertical height reading from the height hook.
 - The vertical height reading is the height difference between the ground mark and the bottom end of the height hook.
 - The vertical offset of 0.36m is automatically stored in the antenna setup record for a tripod setup and will automatically be taken into account. It does not need to be entered.

Measuring the antenna height - tripod setup

Setup Type	Antenna type	The required measurement
Tripod	CGA100	the vertical height reading from the height hook.

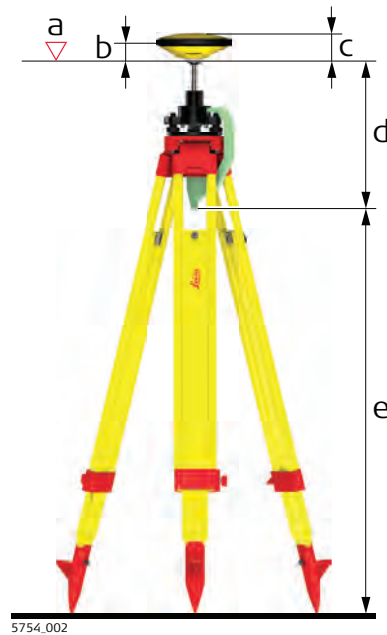

- a Antenna reference plane ARP
- b Vertical phase centre offset for L1
- c Vertical phase centre offset for L2
- d Vertical offset
- e Vertical Height Reading

Vertical offset = 0.36

Determining the antenna height with the height hook step-by-step

1. The vertical height reading = vertical height reading from the height hook.
 - The vertical height reading is the height difference between the ground mark and the bottom end of the height hook.
 - The vertical offset of 0.36m is automatically stored in the antenna setup record for a tripod setup and will automatically be taken into account. It does not need to be entered.

3.6.5

Measuring the Antenna Height for a Pole Setup

Measuring the antenna height - pole setup

Setup Type	Antenna type	The required measurement
Pole	iCON gps 160 SmartAntenna	vertical height reading of the pole.

4

Setups with Accessories



In the following chapters example configurations are shown, covering the most common use cases.

Further configurations are possible. Please contact the local selling unit or dealer for information regarding special use cases.

iCON gps 160 SmartAntenna general description

The iCON gps 160 SmartAntenna is equipped with a built-in LTE modem for network access, for example Ntrip. To work with a local base, a radio module can be used if installed.



A built-in radio is not available with all variants.

4.1

Real-Time Base Setup

Real-time reference setup with internal modem

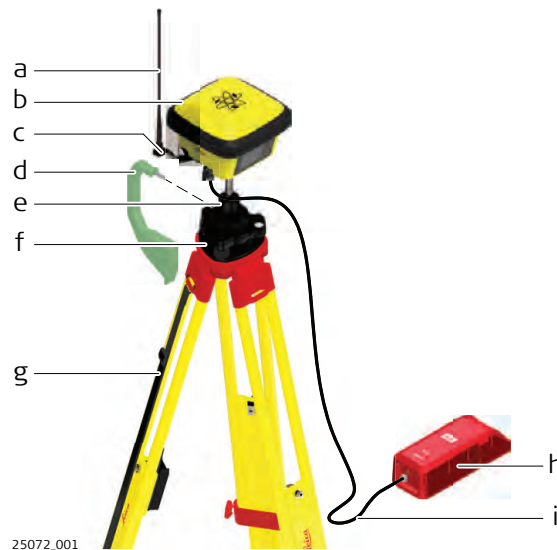

- a Radio antenna
- b iCON gps 160 SmartAntenna
- c CA51 Antenna arm
- d GSZ4-1 Height hook
- e GRT246 Carrier
- f Tribrach
- g Tripod
- h GEB373 external battery
- i GEV219 power cable

Real-time reference setup step-by-step

1. **Setting Up the Equipment**
 - Set up the tripod, mount and level the tribrach onto the tripod.
 - Check that the tribrach is correctly centred over the marker.
 - Place and lock the carrier into the tribrach.
 - Screw the iCON gps 160 SmartAntenna onto the carrier.
 - Check that the tribrach is still correctly positioned and levelled.
 - Hang the external battery onto a tripod leg.
 - Take the GEV219.
 - Attach the 8 pin plug connector to the iCON gps 160 SmartAntenna.
 - Attach the 5 pin plug connector to the external battery.
 - Insert the battery into the field controller.
 - Turn on the antenna and the Field Controller.

2. **Perform a Base Station setup on the iCON gps 160 SmartAntenna or configure a Base Station in the iCON field software**
 - Refer to [6.1 Base Setup](#) or the iCON site Software Manual for further information.

4.2

Local Base Station Setup with External GNSS Antenna

Local Base Station setup with external GNSS antenna

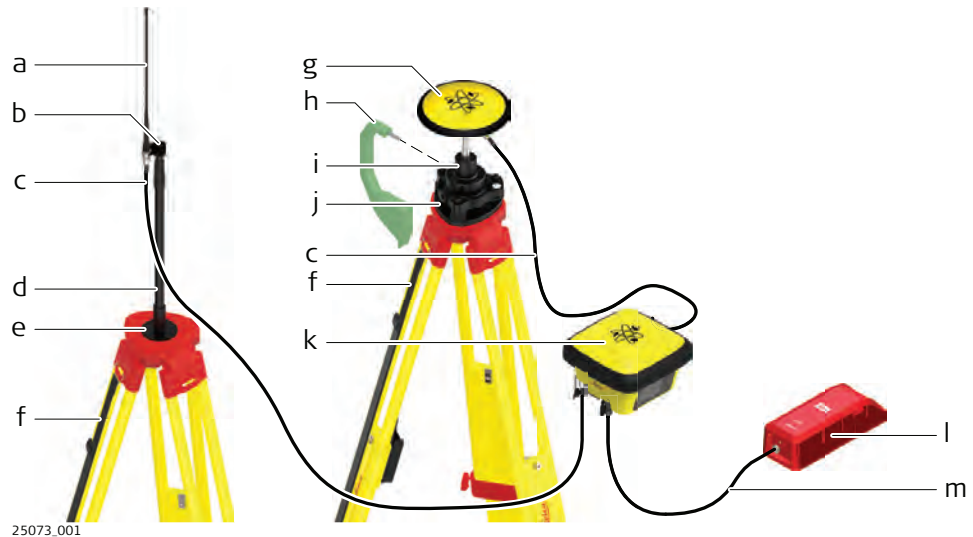

- | | | | |
|---|--|---|---------------------------|
| a | Radio antenna | h | GSZ4-1 Height hook |
| b | GAD34 arm, 3 cm | i | GRT246 Carrier |
| c | GEV120 antenna cable, 2.8 m, 2 x | j | Tribrach |
| d | GAD32 telescopic rod | k | iCON gps 160 SmartAntenna |
| e | GHT36 base for telescopic rod | l | GEB373 external battery |
| f | Tripod, 2 x | m | GEV219 power cable |
| g | CGA100 Robust multi-frequency GNSS antenna | | |

Local Base Station setup with external GNSS antenna step-by-step

1. **Setting Up the CGA100 and radio antenna:**
 - Set up both tripods.
 - Mount and level the tribrach onto the tripod for the CGA100.
 - Check that the tribrach is correctly centred over the marker.
 - Place and lock the carrier into the tribrach.
 - Screw the CGA100 antenna onto the carrier.
 - Check that the tribrach is still correctly positioned and levelled.
 - Mount the GHT36 on the 2nd tripod. Attach the telescopic rod and the GAD34 arm.
 - Screw the radio antenna onto the GAD34 arm.

2. **Setting Up the iCON gps 160 SmartAntenna:**
 - Place the iCON gps 160 SmartAntenna e.g. in a container.
 - Connect the TNC cable to the radio antenna port of the SmartAntenna and to the GAD34 at the radio antenna.
 - Connect a second TNC cable to the SmartAntenna and the CGA100 antenna.
 - Connect the iCON gps 160SmartAntenna via the 8-pin socket to an external power source.
 - Use the GEV219 cable to connect the external battery GEB373 using the 5-pin socket.
 - OR**
 - Use the GEV71 cable to connect i.e. a car battery with the free wire ends.
 - Turn on the antenna.
-
3. **Perform a Base Station setup on the iCON gps 160 SmartAntenna or run the Reference Setup application of the iCON field software**
 - Refer to [6.1 Base Setup](#) or the iCON site Software Manual for further information.



Connecting the GEV71 cable to an external power source (i.e. car battery) needs expert knowledge.

4.3

Real-Time Base with Raw Data Logging

Real-time reference setup for raw data logging

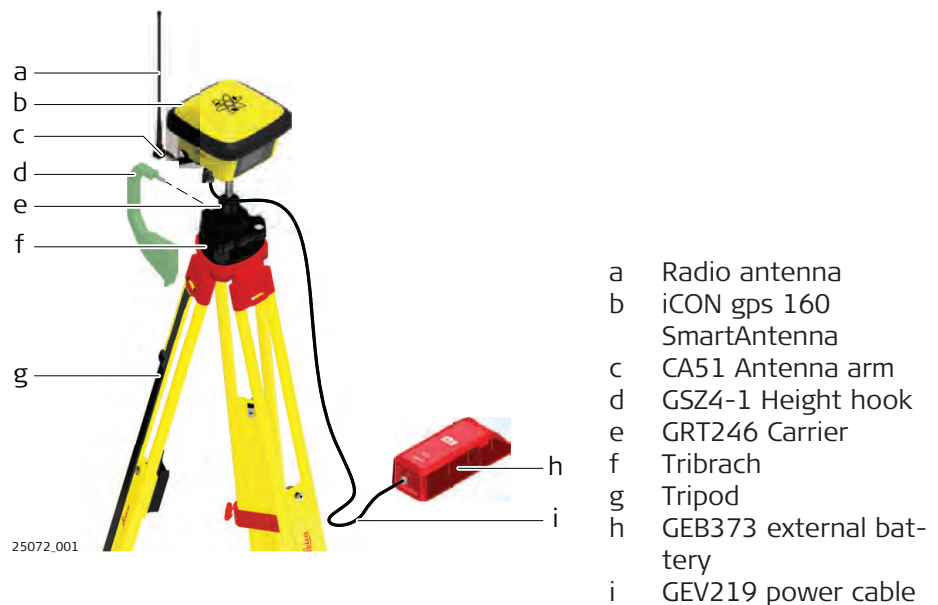

Real-time reference setup for raw data logging step-by-step

- 1. Setting Up the Equipment**
 - Set up the tripod, mount and level the tribrach onto the tripod.
 - Check that the tribrach is correctly centred over the marker.
 - Place and lock the carrier into the tribrach.
 - Screw the iCON gps 160 SmartAntenna onto the carrier.
 - Check that the tribrach is still correctly positioned and levelled.
 - Hang the external batteries onto the tripod legs.
 - Take the GEV219 cable.
 - Attach the connector with the 8 pin plug to the iCON gps 160 SmartAntenna.
 - Attach the connector with the 5 pin plug to the external battery.
 - Turn on the antenna and the Field Controller.
- 2. Configuring the Raw Data Logging**
 - Refer to [6.4 Raw Data Logging](#).
- 3. Perform a Base Station setup on the iCON gps 160 SmartAntenna or run the Reference Setup application of the iCON site software**
 - Refer to [6.1 Base Setup](#) or the iCON site Software Manual for further information.

4.4

Raw data logging setup for post-processing

Raw Data Logging Setup

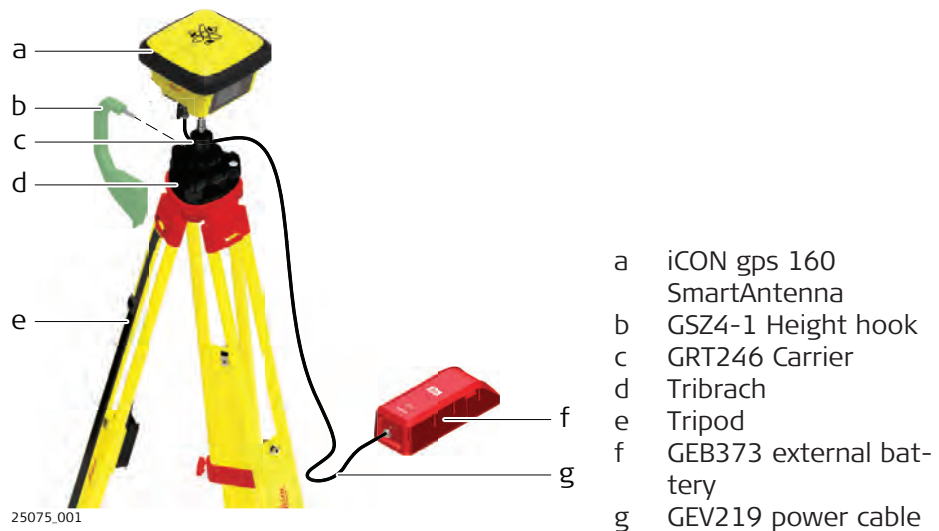

Raw data logging setup step-by-step

- Setting Up the Equipment**
 - Set up the tripod, mount and level the tribrach onto the tripod.
 - Check that the tribrach is correctly centred over the marker.
 - Place and lock the carrier into the tribrach.
 - Screw the iCON gps 160 SmartAntenna onto the carrier.
 - Check that the tribrach is still correctly positioned and levelled.

If available:

- Hang the external battery onto a tripod leg.
- Take the GEV219.
- Attach the connectors with the 8 pin plug to the iCON gps 160 SmartAntenna.
- Attach the connector with the 5 pin plug to the external battery.
- Turn on the antenna.

Else:

- Use internal battery of the antenna without battery cabling.

- Configuring the Raw Data Logging**

- Refer to [6.4 Raw Data Logging](#).

4.5

Real-Time Rover Setup

Use

The equipment setup is used for real-time rover with extended periods of use in the field.

Real-time rover setup with iCON CC70/CC80

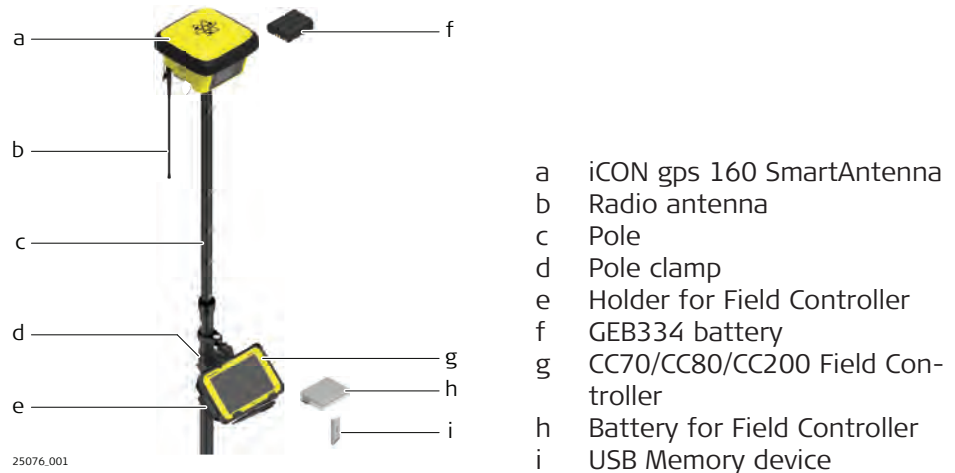

Real-time rover setup step-by-step

1. **Setting Up the Equipment**
 - Insert the battery into the iCON gps 160 SmartAntenna.
 - Screw iCON gps 160 SmartAntenna onto the top of the telescopic pole.
 - Ensure that the compression lock is not clamped.
 - Extend the telescopic pole and ensure that the snap-lock clicks into its position. The snap-lock ensures that there is no slipping of the telescopic pole.
 - Clamp the compression lock. The compression lock maintains straightness.
 - Fix the holder to the clamp with the tightening screw. Before tightening, ensure that the holder is at a comfortable working height and angle. This can be achieved by sliding the clamp along the pole and rotating the holder about the clamp. Tighten the tightening screw.
 - Insert the battery into the field controller.
 - Clip the field controller onto the holder and lock into position.
 - Turn on the antenna and the controller.

2. **Run the data collection or stake-out application of the iCON field software**
 - Refer to the iCON site Software Manual for further information.

4.6

Setup for Machine Use

Setup for Machine use

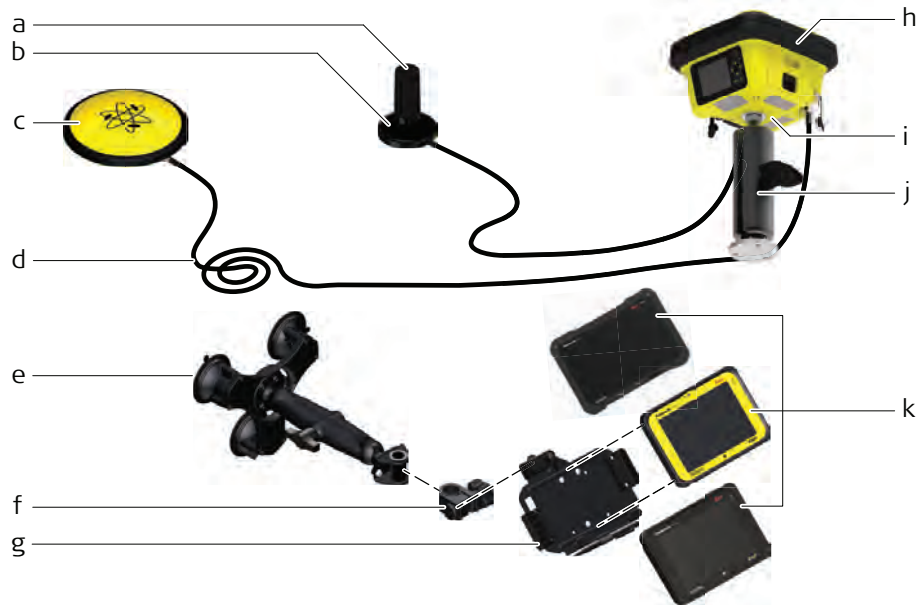

25077_001

- | | | | |
|---|--|---|----------------------------|
| a | Radio antenna CA12/CA13/CA43 | e | CMB11 vehicle adaptor |
| b | CA22 radio antenna magnetic mount | f | GHT63 pole clamp |
| c | CGA100 robust multi-frequency GNSS antenna | g | CMB10 tablet holder |
| d | CA16 antenna cable, 10 m | h | iCON gps 160 SmartAntenna |
| | | i | Internal modem |
| | | j | CMB3 machine bracket |
| | | k | CC70/CC80/CC200 Machine PC |



All necessary installation works must be carried out by a dedicated installation specialist. Please contact the local selling unit or dealer for further information.

4.7

Setup for Vehicle Use

Setup for Machine use



- a Radio antenna GAT1/GAT2/CA6
- b iCON gps 160 SmartAntenna
- c CA51 Antenna arm
- d GEB334 battery
- e USB flash drive
- f CMB12 magnetic mount

4.8

Establish Bluetooth Data Connection

Bluetooth connection setup

Activate the internal Bluetooth module of the iCON gps 160 SmartAntenna. Refer to [Bluetooth Menu](#).



Follow the instructions of the controller User Manual about how to establish a Bluetooth connection.

5 iCON gps 160 SmartAntenna User Interface



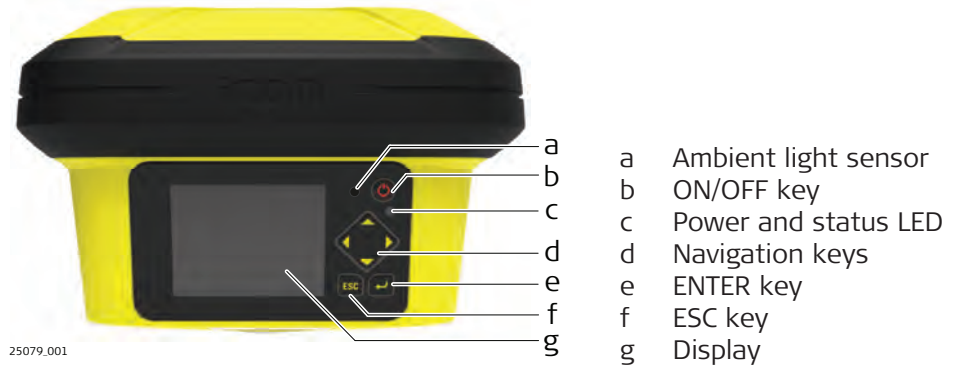

5.1 User Interface Description

User Interface overview



User Interface elements

The instrument can be controlled via the user interface elements.

Action buttons	Function						
Navigation	 4-way navigation in the menus via left, right, up and down buttons.						
ENTER	 <ul style="list-style-type: none"> To activate editing. To accept changes. To enter a menu or submenu. 						
ESC	 <ul style="list-style-type: none"> To cancel operations. To leave a menu or submenu. 						
ON/OFF	 Gives access to startup and shutdown: press for three seconds.						
Display	Displays status information and software functions.						
Ambient light sensor	Energy saving ambient light sensor.  When the display Backlight is set to Auto , the backlight intensity is automatically adjusted on the ambient light sensor input.						
Power LED	<table border="0"> <tr> <td>off</td> <td>Instrument is switched off.</td> </tr> <tr> <td>continuously green</td> <td> <ul style="list-style-type: none"> Normal operation mode. No errors. </td> </tr> <tr> <td>continuously red</td> <td> <ul style="list-style-type: none"> During start-up of the instrument. For various errors occurring. The current status information is shown on the display. </td> </tr> </table>	off	Instrument is switched off.	continuously green	<ul style="list-style-type: none"> Normal operation mode. No errors. 	continuously red	<ul style="list-style-type: none"> During start-up of the instrument. For various errors occurring. The current status information is shown on the display.
off	Instrument is switched off.						
continuously green	<ul style="list-style-type: none"> Normal operation mode. No errors. 						
continuously red	<ul style="list-style-type: none"> During start-up of the instrument. For various errors occurring. The current status information is shown on the display. 						

 Use the  and the  navigation buttons to select a menu item and to navigate within submenus.

 Use the  button to enter a submenu and confirm settings.



Use the **ESC** button to discard settings, cancel operations and to go back one menu level.

5.2

Main Menu

Description

The Main Menu is the first screen displayed when the instrument is switched on.

Main menu content

The Main Menu features a matrix set of menu icons.



The appearance of the menu icons depend upon the current instrument status and configuration.

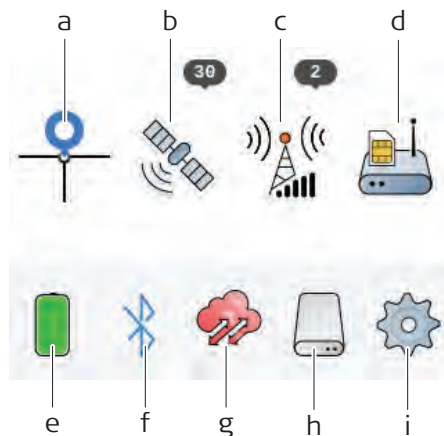





25533_001

- a Position icon
- b Satellite icon
- c Radio icon
- d Modem icon
- e Battery/Power icon
- f Bluetooth icon
- g Leica ConX/Port Summary icon
- h Memory and logging icon
- i Settings icon







Additional icon information







The menu icons on the display provide additional information related to basic instrument status.



Icon	Description
	Position Instrument has not obtained a position.
	<ul style="list-style-type: none"> • Navigated position has been obtained. • Error ≤ 10 m.
	<ul style="list-style-type: none"> • Float position has been obtained. • Error ≤ 0.5 m.
	<ul style="list-style-type: none"> • xRTK position has been obtained. • Error < 0.05 to 0.10 m.



Icon	Description
	<ul style="list-style-type: none"> • High accuracy position has been obtained. • Error \leq 0.05 m.
	iCON gps 160 SmartAntenna is operating as a base .
	BasePilot setup in progress.
	BasePilot setup failed .

Icon	Description
	Number of tracked satellites.

Icon	Description
Radio	
	Radio not in use.
	<ul style="list-style-type: none"> • Radio set to receive correction data in rover mode. • Active radio channel is displayed. • Waves flash when correction data is received.
	<ul style="list-style-type: none"> • Radio set to transmit correction data in base mode. • Active radio channel is displayed. • Waves flash when correction data is transmitted.
	Radio frequency set manually .
	Radio error .
	Sensor is receiving corrections over Smartlink Fill due to an interrupted or broken radio link.

Icon	Description
Modem	
	Modem not in use.
	Modem connected to a cell phone network.
	<ul style="list-style-type: none"> Modem set to receive correction data in rover mode. Waves flash when correction data is received.
	<ul style="list-style-type: none"> Modem set to transmit correction data in base mode. Waves flash when correction data is transmitted.
	Modem error .
	Sensor is receiving corrections over Smartlink Fill due to an interrupted or broken modem link.

Icon	Description
Bluetooth	
	Bluetooth OFF.
	Bluetooth ON.
	Bluetooth connection active .

Icon	Description
Battery/ Power	
	Internal battery in use . Level and colour indicate the battery power level.
	Internal battery very low .
	<ul style="list-style-type: none"> External power is used. Internal battery is installed.

Icon	Description
	<ul style="list-style-type: none"> External power is used. Internal battery is not installed.



External power is used, **low voltage** warning.

Icon	Description
------	-------------

Leica ConX/Port Summary



Leica ConX is **not** configured or is configured but **idle**.



New iCON gps 160 firmware is **available for download** from Leica ConX.



View function enabled in Leica ConX.



Flashing arrows in the icon: **Track** function enabled in Leica ConX.



Leica ConX **error**.

Port Summary: view the current status for the NMEA output and Remote (MPI).

Ethernet Status: view the current Ethernet status.

Icon	Description
------	-------------

Memory and logging



Memory icon (**internal** memory).



USB flash drive inserted.



Raw data logging ongoing.



Memory **error** (internal memory is full, needs attention).

Icon	Description
------	-------------

Settings



Settings icon.



5.3

Submenus

5.3.1

Navigation in Submenus

How to navigate in submenus

Buttons	Description
	<ul style="list-style-type: none"> Use the navigation buttons to select a submenu entry.
	<ul style="list-style-type: none"> To enter a menu entry press ENTER.
	<ul style="list-style-type: none"> Use the navigation buttons to navigate through a submenu with multiple pages.

Example of a submenu

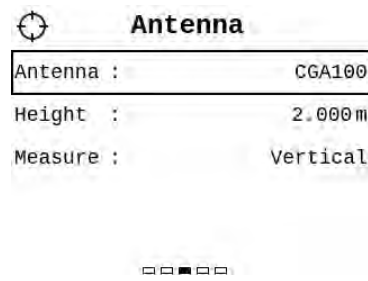

Small boxes at the bottom of a submenu page indicate the number of pages within the submenu, while a solid black box indicates the current page.

Locked Submenus

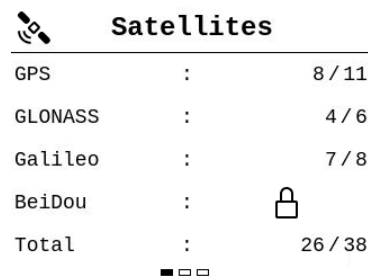





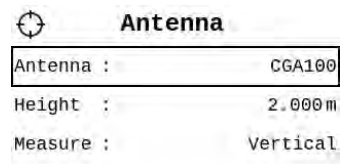

Features that are not active due to a missing licence are marked with a **lock** symbol ().

5.3.2



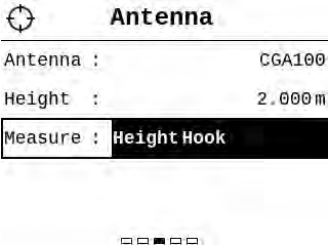



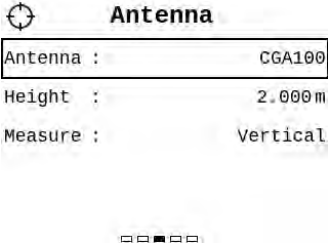

How to Change Settings and Edit Values

How to change settings

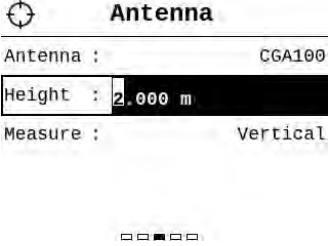
Example screen	Action	Button
	<ol style="list-style-type: none"> Enter the desired submenu as described before, for example Antenna 1 settings. 	
	<p><i>The first editable value is automatically selected, indicated by a frame around the entry.</i></p>	
	<ol style="list-style-type: none"> Use the navigation action buttons, to select a different option, for example Measure. 	

Example screen	Action	Button
	3. Press ENTER to enter the list of available sub-options.	
	4. Use the navigation action buttons to scroll through the list of options.	
	5. Press ENTER to confirm the selection.	
	6. Press ESC to discard the setting and cancel the operation.	

Select and edit values



Example screen	Action	Button
	1. Enter the desired submenu as described before, for example Antenna 1 settings.	
	2. Use the UP/DOWN navigation buttons, to select the desired option, for example Height .	
	3. Press ENTER to enter the input field.	
	4. Use the UP/DOWN navigation buttons, to change the value of a digit.	
	5. Use the LEFT/RIGHT navigation buttons to change to the preceding/next digit.	
	6. Press ENTER to confirm the setting	
	7. Press ESC to discard the setting and cancel the operation.	





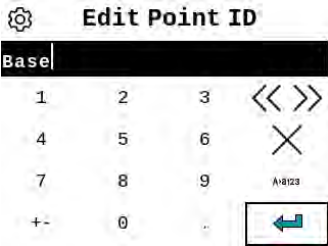

Enter numbers or text

The user interface is equipped with a virtual keyboard for alphanumerical and numerical input.



Press  repeatedly to toggle between the different characters.

Example screen	Action	Button
	1. Select a submenu item, as shown in the example.	
	2. Press ENTER to edit a number/text field.	
	3. Use the navigation action buttons to select a key on the virtual keyboard.	

Example screen	Action	Button
	4. Press ENTER (if necessary repeatedly) to select and enter a character or number.	
	5. Select  and press ENTER to save the changes.	
Special keys	Function	
A>a>123	Switches between upper/lower case characters and the numerical keyboard.	
 	Moves the position of the cursor.	
	Deletes the character left of the cursor (backspace functionality).	
	Stores the current content of the description field and ends input mode.	

5.3.3

Available Sub Menus

Position Menu

Informs about:

- **Position Quality:**
 - **Position Quality**
 - **Height Quality**
 - **GDOP:** Geometric Dilution Of Precision. The smaller the number, the higher the possible precision.
 - **Solution: Navigated, Float, xRTK or Fixed**
- **Position Antenna:**
 - The coordinate system used: **WGS84, Via Network** or any loaded coordinate system files.
 - Position Coordinates
 - Position Height
- **Antenna 1:**
 - The active GNSS antenna
 - Height of the active antenna
 - Measurement mode of antenna height: **Vertical** or **Height Hook**
- **RTK Mode:**
 - The active **RTK Mode**
 - BasePilot: Used or Not Used
- Current **Date & Time**

Configurable values (if external antenna is connected):

- Antenna type
- Antenna height
- Measurement mode of Antenna height

Satellite Menu

Informs about:

- **Satellites Antenna 1:**
 - The number of tracked satellites and available satellites, if no position is given (no base correction data received).
 - The number of used satellites and available satellites, when position is available (with base correction data).
 - **Cut-Off Angle:** below this defined angle satellites will not be taken into account for calculations.
- **Reference Satellites:**
 - The number of reference satellites, in rover mode only.

Configurable value:

- **Cut-Off Angle**
-

Radio Menu

Informs about:

- Radio status information, including managing internal power supply for the radio
- Connection details of the internal and / or external radio
- Base station information
- Radio channel, frequency and bandwidth (if applicable)
- Internal power supply Yes/No, Radio On/Off
- Protocol (for some radio types only)
- Correction format (only in base mode)
When in base mode, the RTK correction format can be edited from within the radio menu.
- FEC (Forward Error Correction) (if applicable)

Configurable values:

- Radio channel, frequency and bandwidth (if applicable)
 - Internal power supply Yes/No, Radio On/Off
 - Protocol (for some radio types only)
 - Correction format (only in base mode)
When in base mode, the RTK correction format can be edited from within the radio menu.
 - FEC (Forward Error Correction) (if applicable)
-

Modem Menu

Informs about:

- **Internal Modem:**
 - Modem type and connection details
 - Managing internal power supply for the modem
 - RTK status
 - Base Station information

Configurable values:

- Internal power supply for the modem Yes/No
 - Modem connect/disconnect
 - Selected mobile internet service type
 - Correction format (only in base mode)
When in base mode, the RTK correction format can be edited from within the modem menu.
-

Power Menu

Informs about:

- Battery level of internal and / or external battery

Configurable values:

- None
-

Bluetooth Menu

Informs about:

- Bluetooth connection details and status

Configurable value:

- Activate/deactivate Bluetooth
-

Leica ConX and Port Summary Menu

Informs about:

- The status of **Leica ConX** and its functions View, Track and Sync
- Enable or disable the **Share screen** function, to allow a remote user to view the instrument's screen
- The different ports and their usage/status

Configurable values:

- Activate/deactivate **Share screen**
-

Storage Menu

Informs about:

- **Internal Memory:**
 - Free/Used/Total Memory
 - Raw data logging active/inactive
- **USB Storage:**
 - Free/Used/Total Memory, when a USB memory device is inserted

Configurable values:

- None
-

Settings Menu

Contains following submenus:

- **Tools**
 - **System Information**
 - **System Configuration**
 - **Service**
 - **Copyrights**
-

Settings Menu: Tools

Functions	Description
Base Setup	Execute a Base Station setup. Refer to 6.1 Base Setup for further information.
Rover Setup	Execute a Rover setup. Refer to 6.2 Rover Setup for further information.
NMEA Output	Attend the NMEA Output settings. Refer to 6.3 ORP and NMEA Output for further information.  The appropriate license must be installed to access the NMEA Output wizard.
Raw Data Logging	<ul style="list-style-type: none">• Setup/Start Raw Data Logging. Refer to 6.4 Raw Data Logging for further information.• View the Log file list.• Export Log files to a connected USB memory device.• Delete all Log files.

Functions	Description
Leica ConX	<ul style="list-style-type: none"> View the current Leica ConX Status. Leica ConX Sync Download: download data from the Leica ConX web page. Leica ConX Sync Upload: upload data to the Leica ConX web page. Leica ConX Firmware: search for and execute available instrument firmware updates from the Leica ConX web page. Perform a Leica ConX Setup. <p> Refer to 6.5 Leica ConX for further information on the different functions.</p>
Import / Export / Delete	<ul style="list-style-type: none"> Import data from a connected USB memory device. Export data to a connected USB memory device. Delete data stored on the instrument. Available options to delete: Base point list, Support logs, and Coordinate systems.
Licenses	<ul style="list-style-type: none"> View active licenses. Upload license file from a connected USB memory device. Enter license key. Delete all licenses stored on the instrument.

Settings Menu: System Information

Functions	Description
System Information	<ul style="list-style-type: none"> Instrument Type and Serial Number. Active firmware version. Information about the Measurement Engine, the Internal Radio, and the Internal Cell Modem.

Settings Menu: System Configuration

Functions	Description
Upload Firmware	Single Firmware file selectable to upgrade the instrument's firmware. Firmware file must be placed in a folder called system on a USB memory device.
GNSS Settings	<ul style="list-style-type: none"> Configure GNSS tracking settings GPS L2C, GPS L5, GLONASS, Galileo and BeiDou To activate or deactivate Smartlink Fill. <ul style="list-style-type: none"> Smartlink Fill is available for all RTK formats and independently from the xRTK configuration. Smartlink Fill is a correction service delivered via Satellite to bridge RTK corrections outages for up to 10 minutes. <p> The Smartlink Fill functionality is licenced.</p>
Coordinate systems	To set the Coordinate system used. Choose from WGS84 , Via Network or any loaded coordinate system files.

Functions	Description
Reset Options	<p>Reset options are available for the Memory, the External Port Configurations, the Instrument, Almanac, and the Antenna list.</p> <p> The Almanac is a set of data that every GNSS satellite transmits, and it includes information about the state of the entire satellite constellation, and coarse data on every satellite's orbit. When the iCON gps 160 instrument has current almanac data in memory, it can acquire satellite signals and determine initial position more quickly.</p>
Choose Language	Change system language.
Screen Settings	<ul style="list-style-type: none"> Set display Backlight options: <ul style="list-style-type: none"> Auto: Ambient light sensor is used to automatically adjust screen backlight for best display. Full: Screen backlight is set to full brightness. Off: Backlight is turned off. Set display Power Saver options: <ul style="list-style-type: none"> Off: Screen backlight will not turn off. 5 s, 30 s, 1 min., ...: Screen backlight remains on for the time period set following the last key press.
Startup & Shut-down	<ul style="list-style-type: none"> When Start on Pulse to Port is set to On: The instrument will automatically start up after receiving a pulse signal on port P1. When Start on Power to Port is set to On: The instrument will automatically start up when power is available on port P1.
Date & Time	Define Time Zone and Daylight Saving Time .
Units & Formats	<ul style="list-style-type: none"> Set the Unit used for Distance. Define Date and Time format.
Network Settings	<ul style="list-style-type: none"> Select the Internet device: Modem or Ethernet. Define Modem Settings. Define Ethernet Settings.

Functions	Description
User Defined Antennas	<p>Create or edit up to 50 user defined antennas.</p> <ul style="list-style-type: none"> • Give the antenna a user defined Name. • Enter values for H_z offset, V_{rt} offset, and the phase centre offset values L₁ ph.off. and L₂ ph.off. • Enter the IGS name and a Serial nr. IGS stands for International GNSS Service. It is possible to register antennas and receivers at IGS, and these items are then kept in an official list. <p>All input fields, but the Serial nr., must be completed. Therefore a list showing these values for the user defined antenna should be present.</p> <p> Copy add. corr. allows to copy an existing additive constant.</p> <p>User defined antennas are available in the antenna fields for selection, for example in wizards or sub-menus. When a user defined antenna was used for a Base Station setup it is also shown in the Base Point List.</p>
iCON Analytics	<ul style="list-style-type: none"> • Use Usage Report to enable/disable this feature. • Use About iCON Analytics to view detailed information about the matters and capacity of this feature. Further information can be found below.
Upload ME Firmware	<p>Single ME (Measurement Engine) files selectable to upgrade the ME(s). ME file must be placed in a folder called system on a USB memory device</p>

iCON Analytics - detailed information

Leica Geosystems would like your help to improve this product. Your iCON device can automatically collect diagnostic and usage info from your device and send it to Leica Geosystems for analysis. Diagnostic and usage information may include details about hardware and operating system specifications, performance statistics, and data about how you use your devices and applications. The collected information may also contain the location and serial number of the hardware. This collected information is stored on a cloud based server and will be used for troubleshooting and for shaping future development of the product. We encourage users to maintain this setting. You may also, at any time, choose to turn off the monitoring of usage altogether. To do so, open **System Configuration > iCON Analytics** and choose **Don't send**.

Settings Menu: Service

Functions	Description
Service	Password protected - for Service & Support staff only.

Settings Menu: Copyrights

Functions	Description
Copyrights	Includes Open Source Software License information.

This software contains copyright-protected software that is licensed under various open source licenses.

- Press **Settings** > **Copyrights** to view the copyright information and a link to download the source code and license text.

And/Or

- The according copyright statements and license texts are part of the documentation delivered with this product.

If foreseen in the corresponding open source licence, you may obtain the source code, license texts and other related data on the open source centre website of Leica Geosystems, <http://opensource.leica-geosystems.com>.

6 Software Tools

6.1 Base Setup

6.1.1 Base Setup Description

Setup iCON gps 160 SmartAntenna as Base Station

The iCON gps 160 SmartAntenna can be setup and used as Base Station. Measured Base Points can be recorded in the instrument and a Base Point list can be imported and used for future Base Setups.

There are different options to setup the iCON gps 160 SmartAntenna as Base Station:

Manual Base Setup

When no Base Setup has been performed and recorded before to the iCON gps 160 SmartAntenna and no Base Point List has been imported, it is necessary to perform a manual Base Setup.

The instrument can be manually set up as a stand-alone base station without a controller. This can be done in three different ways using the Base Setup wizard:

- **Find nearest:**
Searches through the **Base Point List for a known base point** within a radius of 20 m of the current instrument position.
- **Smart Get here:**
Instrument determines position and **uses current position as a new base point**.
- **Edit:**
Manual input of coordinates to **generate a new base point**.

 Manual Base Setup is always possible, also with a imported Base Point List or a previously recorded Base Setup.

Base Setup using BasePilot

iCON gps 160 SmartAntenna features a tool for automatic Base Setup called **BasePilot**.

- BasePilot is enabled automatically when the iCON gps 160 SmartAntenna is configured in Base mode and powered up on an **existing base point**.
- BasePilot recognises that the instrument is in base mode, is over a known point and automatically loads the previously stored base configuration.

Using the Base Point List

The Base Point List comprises a list of known base points with all corresponding base system configuration data. It is used with the BasePilot functionality for fast automatic base configuration.

 The Base Point List can be exported, imported and deleted via the **Import / Export / Delete** submenu. Refer to [6.6 Import, Export, or Delete Data](#) for further information.

No stored positions nearby

If no base point in the Base Point List is close to the current instrument position a message is displayed:

- Select **Continue** and confirm the message by pressing ENTER.



- Use the **Edit** or **Smart Get here** function to set up the base station.

6.1.2

Manual Base Setup

Find nearest step-by-step

The **Find nearest** function searches through the Base Point List for base points in the vicinity.

1. According to your needs, set up the hardware needed at the desired base point position. Refer to [4 Setups with Accessories](#) for further information about hardware setup.
2. Access the wizard via **Settings > Tools > Base Setup**.
3. In the **Position** screen select **Modify** and press ENTER.



4. Select **Find nearest** and press ENTER to start the wizard.



The instrument searches for base points within a 20 m radius, which are stored in the Base Point List. The closest base point is selected automatically.

If a base point is found within a 20m radius of the current position a message is displayed:

5.
 - Select **Saved setup** to load the saved Base point setup, including Antenna and Communication settings.
 - Select **Current** to keep the current configuration.

Press ENTER to confirm your selection.



6. Back in the **Position** screen, re-check the selected base point information.

7. Use the RIGHT navigation key to proceed to the **Communication** setup screen, in order to configure a Corr. Source, if needed.





It is possible to configure three communication devices running in parallel:

- a) **Internal Radio**
For step-by-step instructions see: [Configuration of Internal Radio](#)
- b) **External Radio P1**
For step-by-step instructions see: [Configuration of External Radio P1](#)
- c) **Network**
For step-by-step instructions see: [Configuration of Int. Modem/Configuration of Ethernet](#)





Configuration of communication devices is optional and can be skipped if no correction source is needed or configured already.

8. Use the RIGHT navigation key to proceed to the **Antenna 1** screen and check the active Antenna information. Refer to [3.6 Antenna Heights](#) for information about Antenna Heights. 

9. Use the RIGHT navigation key to proceed to the final step. 

10. To save and apply the new Base Station settings select **Save** and press ENTER to confirm. 

-  To discard the new Base Station settings select **Undo** and press ENTER. Confirm the following Warning message by pressing ENTER again. 

If no base point is found within a 20 m radius of the current position a message is displayed:

-  Continue with **Smart Get here** or with **Edit** in order to setup your base station. For step-by-step instructions see:
 - [Smart Get here step-by-step](#)
 - [Edit step-by-step](#)

Smart Get here step-by-step

The **Smart Get here** function determines the current coordinates of the instrument and uses this position as the base point.

1. According to your needs, set up the hardware needed at the desired base point position. Refer to [4 Setups with Accessories](#) for further information about hardware setup.

2. Access the wizard via **Settings > Tools > Base Setup**.

3. In the **Position** screen select **Modify** and press ENTER. 

4. Select **Smart Get here** and press ENTER to start the wizard. 

In the Antenna screen:

5. Select the active **Antenna**, its **Height** and the **Measure** mode. Refer to [3.6 Antenna Heights](#) for information about Antenna Heights. 

6. Select **Continue** and press ENTER to confirm. 

In the Measure Setup screen:

7. Set the **Meas. Time** according to your needs and press ENTER to confirm. 

8. If needed, select **Corr. Source** and press ENTER to confirm. 



You will be forwarded to the **Communication** setup screen.

Select the device to be used or configure it.

-  For information on how to configure a Corr. Source see:
- [Configuration of Internal Radio](#)
 - [Configuration of External Radio P1](#)
 - [Configuration of Int. Modem](#)
 - [Configuration of Ethernet](#)

-
9. Continue with determining the current position. Select **Measure** and press ENTER to confirm. 

The instrument measures the current position. Subsequently it searches the Base Point List for stored base points in the vicinity.

-  If necessary, select **Re-Measure** and press ENTER to confirm. When the measurement is satisfactory, select **OK** and press ENTER to continue. 



If an existing base point is found within a 40 m radius of the measured point stored in the instrument a message is displayed.

-
10. Select:
- **Overwrite** to use the newly measured position
 - **Use existing** to use the known point
- If **Use existing** has been chosen, a second message is displayed. Choose between:
- **Saved setup** in order to load the saved Base point setup, including Antenna and Communication settings
 - **Current** in order to keep the current configuration
- Otherwise, continue with using the newly measured position.

In the Edit Position screen:

-
11. Select **Pt. ID** and press ENTER to confirm. 

Enter a Point ID and press ENTER to confirm.

-  If needed, position and height values can be changed. 

When finished, select **Continue** and press ENTER to confirm. 

*If no existing base point is found within a 40 m radius of the measured position the instrument returns you to the **Position** screen.*

-
12. Select **Modify** and **Edit** in case the Point ID and/or coordinates of the new point shall be adapted and press ENTER to confirm your selection. 
-

Else select **Continue** and press ENTER to confirm.



*New Point ID, position and height values are stored and the instrument returns to the **Position** screen.*

13. Use the RIGHT navigation key to proceed to the **Communication** setup screen, in order to configure a Corr. Source, if needed.



In the Communication screen:

14. It is possible to configure three communication devices running in parallel:
- a) **Internal Radio**
For step-by-step instructions see: [Configuration of Internal Radio](#)
 - b) **External Radio P1**
For step-by-step instructions see: [Configuration of External Radio P1](#)
 - c) **Network**
For step-by-step instructions see: [Configuration of Int. Modem/Configuration of Ethernet](#)



Configuration of communication devices is optional and can be skipped if no correction source is needed or configured already (see step **8.**).

15. Use the RIGHT navigation key to be returned to the **Antenna 1** screen.



The active **Antenna**, its **Height**, the **Measure** mode and the **Ref.Stn.ID** (Reference Station Identification) can be changed again. Refer to [3.6 Antenna Heights](#) for information about Antenna Heights.



16. Use the RIGHT navigation key to proceed to the final step.



17. To save and apply the new Base Station settings select **Save** and press ENTER to confirm.



To discard the new Base Station settings select **Undo** and press ENTER. Confirm the following Warning message by pressing ENTER again.



Edit step-by-step

The **Edit** function can be used to enter a set of coordinates manually.

1. According to your needs, set up the hardware needed at the desired base point position. Refer to [4 Setups with Accessories](#) for further information about hardware setup.
2. Access the wizard via **Settings > Tools > Base Setup**.
3. In the **Position** screen select **Modify** and press ENTER.
4. Select **Edit** and press ENTER to to start the wizard.



In the Edit Position screen:

5. Enter:
 - a Point ID
 - a Set of Coordinates
 - the Height of the desired Base Station
6. Select **Continue** and press ENTER to confirm.



The instrument searches for base points in the vicinity, which are stored in the Base Point List.

If there is an existing a base point within a 40 m radius of the entered point coordinates a message is displayed:

7. Select:
 - **Overwrite** to use the newly entered coordinates
 - **Use existing** to use the known point coordinates

If **Use existing** has been chosen, a second message is displayed. Choose between:

- **Saved setup** in order to load the saved Base point setup, including Antenna and Communication settings
- **Current** in order to keep the current configuration

 If there is no existing base point found within a 40 m radius a message is displayed and the newly entered information is stored as base point (using the currently loaded configuration).

 Once configured the Internal Radio can be switched **On** or **Off**. To configure the Internal Radio proceed as follows:

1. Select **Edit** and press ENTER to confirm.





In the Internal Radio (1) screen:

The Model is displayed.

In the Internal Radio (2) screen:

2. Select:
 - **Channel**
 - **Frequency**
 - **Bandwidth**In the **Advanced Settings page**, **Protocol** and **FEC** can be defined.

 Some settings are only applicable for the 400MHz frequency band.

 If a frequency is required that is not given as part of a channel, the frequency can be typed in manually. If required the bandwidth can be changed accordingly.

In the RTK Settings screen:

Configuration of Internal Radio

3. Select a **Corr.Format**:
 - **Leica**
 - **Leica4G**
 - **CMR**
 - **RTCM3.1/ RTCM3.2 MSM3/ RTCM3.2 MSM5.**

 For further information refer to [RTK correction format](#).

In the Save Settings screen:

4. Confirm to enable the device.

Configuration of External Radio P1

 Once configured the External Radio P1 can be switched **On** or **Off**.
To configure the External Radio P1 proceed as follows:

1. Select **Edit** and press ENTER to confirm.



In the External Radio (1) screen:

2. For model **Generic RS232** select:
 - **Baud rate**
 - **Parity**
 - **Flow contr.**

In the RTK Settings screen:

3. Select a **Corr.Format**:
 - **Leica**
 - **Leica4G**
 - **CMR**
 - **RTCM3.1/ RTCM3.2 MSM3/ RTCM3.2 MSM5.**

 For further information refer to [RTK correction format](#).

In the Save Settings screen:

4. Confirm to enable the device.

Configuration of Int. Modem

 Network usage can be switched **On** or **Off**.
To configure the Network using the Int. Modem proceed as follows:

1. Select **Edit** and press ENTER to confirm.



In the Internet conn. screen:

2. Select **Modem**.

In the Int. Modem screen:

3. Select as **Mode**:
 - Either **NTRIP Base** and continue with [Configuration of NTRIP Base](#).
 - Or **NTRIP Source** and continue with [Configuration of NTRIP Source](#).
 - Or **TCP Server** and continue with [Configuration of TCP Server](#).

Configuration of Ethernet

 Network usage can be switched **On** or **Off**.
To configure the Network using the Ethernet proceed as follows:

1. Select **Edit** and press ENTER to confirm.



In the Internet conn. screen:

2. Select **Ethernet**.
-

In the Ethernet screen:

3. Select as **Mode**:
 - Either **NTRIP Base** and define the **NTRIP Settings**.
For a step-by-step description see topic [Configuration of NTRIP Base](#) and continue with step **5**.
 - Or **NTRIP Source and define the Caster Settings**.
For a step-by-step description see topic [Configuration of NTRIP Source](#) and continue with step **3**.
 - Or **TCP Server** and define the **TCP Server**.
For a step-by-step description see topic [Configuration of TCP Server](#) and continue with step **5**.
-



Set **DHCP** to **On** in order to use the DHCP (Dynamic Host Configuration Protocol) to automatically get IP address and networking parameters requested from a DHCP server.

Use the RIGHT navigation key to proceed to the next step.



Set **DHCP** to **Off** in order to manually enter IP address and networking parameters.

Use the RIGHT navigation key to proceed to the next step.

In the **DNS Servers** screen, enter the primary and, if needed, secondary DNS server parameters.



Configuration of NTRIP Base

1. Select **NTRIP Base** as **Mode** and enter/select:
 - **PIN**
 - **APN** (Access Point Name)
 - **Use/Don't use** for the **APN ID**

If **Use** is selected:

- Use the RIGHT navigation key to proceed to the **APN ID** screen.
- And enter **User ID** and **Password**.



2. Use the RIGHT navigation key to proceed to the next step.
-



In the DynDNS Settings screen:

3. Select/Enter:
 - **Provider**
 - **Host**
 - **Username**
 - **Password**
-



The fixed IP functionality for a SIM card must explicitly be ordered at the network provider.

4. Use the RIGHT navigation key to proceed to the next step.



In the NTRIP Settings screen:

5. Enter:
 - **Port** number
 - **Username**
 - **Password**



The port number entered must be accessible from outside your local cell network.

6. Use the RIGHT navigation key to proceed to the next step.



In the Save Settings screen:

7. Select the **Corr.Format** (Correction Format). For details refer to descriptions in topic "Configuration of Internal Radio", step **3**.

8. Use the RIGHT navigation key to save the settings and enable the device.



Configuration of NTRIP Source

1. Select **NTRIP Source** as **Mode** and enter/select:
 - **PIN**
 - **APN** (Access Point Name)
 - **Use/Don't use** for the **APN ID**

IF **Use** is selected:

- Use the RIGHT navigation key to proceed to the **APN ID** screen.
- And enter **User ID** and **Password**.



2. Use the RIGHT navigation key to proceed to the next step.



In the Caster Settings screen:

3. Select **Mode** and enter:
 - **Address**
 - **Port**
 - **Mnt.Pt.** (mount point)
 - **Password**



Address mode WWW allows the entry of a web address.



Address mode IP allows the entry of an IP address.

4. Use the RIGHT navigation key to proceed to the next step.



In the Save Settings screen:

5. Select the **Corr.Format** (Correction Format). For details refer to descriptions in topic "Configuration of Internal Radio", step **3**.

6. Use the RIGHT navigation key to save the settings and enable the device. 

Configuration of TCP Server

1. Select **TCP Server** as **Mode** and enter/select:
 - **PIN**
 - **APN** (Access Point Name)
 - **Use/Don't use** for the **APN ID**IF **Use** is selected:
 - Use the RIGHT navigation key to proceed to the **APN ID** screen. 
 - And enter **User ID** and **Password**.

2. Use the RIGHT navigation key to proceed to the next step. 

In the DynDNS Settings screen:

3. Select/Enter:
 - **Provider**
 - **Host**
 - **Username**
 - **Password**

 When using a SIM card with a fixed IP, set **DynDNS** to **Off**.

 The fixed IP functionality for a SIM card must explicitly be ordered at the network provider.

4. Use the RIGHT navigation key to proceed to the next step. 

In the TCP Server screen:

5. Enter:
 - a **Port** number
 - a number for **Max. clients**

 The port number entered must be accessible from outside your local cell network.

6. Use the RIGHT navigation key to proceed to the next step. 

In the Save Settings screen:

7. Select the **Corr.Format** (Correction Format).
For details refer to descriptions in topic "Configuration of Internal Radio", step **3**.
8. Use the RIGHT navigation key to save the settings and enable the device. 

6.1.3

Base Setup using BasePilot

BasePilot setup

BasePilot is a feature which configures and starts the iCON gps 160 SmartAntenna running as a Base when the instrument (antenna) is setup over a known base point. Predefined base configurations are automatically loaded.

1. According to your needs, setup the hardware needed over a known base point.
Refer to [4 Setups with Accessories](#) for further information about hardware setup.

*If iCON gps 160 SmartAntenna is in **Base** mode **BasePilot** starts up automatically.*



If iCON gps 160 SmartAntenna is in **Rover** mode go to **Settings > Tools > Base Setup** and choose **Find nearest**.
For step-by-step instructions see: [Find nearest step-by-step](#)

2. Press ENTER to confirm.



*While **BasePilot** is setting up the setup-in-progress icon is displayed.*



*After the **BasePilot** has been completed the operating-as-base icon is displayed.*



The radio/modem now starts transmitting corrections.



On the **RTK Mode** page, in the **Position** submenu the line **BasePilot** shows: **Successful**.



When using BasePilot, always confirm in the **Position** submenu that the iCON gps 160 SmartAntenna has selected the correct base point! **Using the wrong base point can lead to an error of more than 20 m for a rover!**



6.1.4

Base Coordinates

Import of user-defined base points

Base coordinates is a feature which allows the import of user-defined base points from a text file.

1. Create a text file with the points to be imported. Save the text file as *.csv file.
 - Each point should have five parameters:
 - **ID:** Point number in the database, from 0 to 99 (maximum of 100 points).
 - **E:** Easting coordinate in metres
 - **N:** Northing coordinate in metres
 - **H:** Height in metres
 - **Code:** Base point name (optional)
 - All parameters must be in the same line and separated either by comma, semicolon, space or by a tab.
 - Different points must be separated by a new line.





- Enter all coordinates based on a **local** coordinate system.
- 2. Copy the *.csv file to the [System] folder on a USB flash drive. Insert the USB flash drive into the USB host port of the iCON antenna.
- 3. To open the Import menu for Base Coordinates, select **Settings > Tools > Import / Export / Delete > Import from USB > Base Coordinates**.
- Make sure that a **local** coordinate system is active.
- 4. Choose the order of parameters for coordinates and units. 
- For 2D coordinates, you can switch the order of parameters:
ID, E, N, H, Code or **ID, N, E, H, Code**
- 5. Press the RIGHT navigation key to proceed to the next step.
- Press the RIGHT navigation key to confirm import. 

6.2

Rover Setup

Rover setup description

The instrument can be manually set up as a stand-alone Rover without a controller, using the Rover Setup wizard.

- 1. Access the wizard via **Settings > Tools > Rover Setup**.
- 2. In the **Communication** screen press ENTER. 
- 3. Use the LEFT/RIGHT navigation keys in order to select the communication device.  
 - **Int. Radio:**
Select this option to use the internal radio. A slot-in-radio must be inserted into its slot.
 - **Ext. Radio P1:**
Select this option to use an external radio connected to Port P2.
 - **Int. Modem:**
Select this option to use the internal modem. A SIM card must be inserted in the card slot. Refer to [3.3 Installing a SIM Card](#) for further information.
 - **Ethernet:**
Select this option to use Ethernet.
- 4. Press ENTER to confirm your selection. 
- 5. Use the RIGHT navigation key to proceed to the next step. 
- The following step-by-step descriptions explain the different options in detail.

Rover setup with internal radio step-by-step

In the Communication screen:

1. Select **Int. Radio**.
2. Use the RIGHT navigation key to proceed to the next step. 

In the Internal Radio (1) screen:

The Model is displayed.

In the Internal Radio (2) screen:

3. Select:
 - **Channel**
 - **Frequency**
 - **Bandwidth**In the **Advanced Settings** page, **Protocol** and **FEC** can be defined.

 If a frequency is required that is not given as part of a channel, the frequency can be typed in manually. If required the bandwidth can be changed as well.

 Some settings are only applicable for the 400MHz frequency band.

4. Use the RIGHT navigation key to proceed to the next step. 

In the RTK Settings screen:

5. Select:
 - **Corr.Format** (Correction Format)
 - **Ref.Rec.** (Reference Receiver)
 - **Ref.Ant.** (Reference Antenna)
 - **Accept Ref.** (Accepted References)

 Refer to [RTK correction format](#) for further information about the correction formats.

6. Use the RIGHT navigation key to proceed to the next step. 

In the Antenna screen:

7. Select the active **Antenna**, its **Height** and the **Measure** mode.
Refer to [3.6 Antenna Heights](#) for information about Antenna Heights.

8. Use the RIGHT navigation key to proceed to the final step. 

In the Save Settings screen:

*The signal waves will flash if the **Channel** and the **Corr.Format** are correctly set.*

9. Use the RIGHT navigation key to save and apply the rover settings. 

 To discard the changes press ESCAPE.
A warning message is displayed.



Select **Continue** and press ENTER to confirm .



Rover setup with external radio step-by-step

In the Communication screen:

1. Select **Ext. Radio P1**.
2. Use the RIGHT navigation key to proceed to the next step.



In the External Radio (1) screen:

3. For model **Generic RS232** select:
 - **Baud rate**
 - **Parity**
 - **Flow contr.**
4. Use the RIGHT navigation key to proceed to the next step.



In the RTK Settings screen:

5. Select:
 - **Corr.Format** (Correction Format)
 - **Ref.Rec.** (Reference Receiver)
 - **Ref.Ant.** (Reference Antenna)
 - **Accept Ref.** (Accepted Reference ID)

 Refer to [RTK correction format](#) for further information about the correction formats.

6. Use the RIGHT navigation key to proceed to the next step.



7. Select the active **Antenna**, its **Height** and the **Measure** mode.
Refer to [3.6 Antenna Heights](#) for information about Antenna Heights.

8. Use the RIGHT navigation key to proceed to the next step.



In the Save Settings screen:

*The signal waves will flash if the **Channel** and the **Corr.Format** are correctly set.*

9. Use the RIGHT navigation key to save and apply the rover settings.



-  To discard the changes press ESCAPE.
A warning message is displayed.



Select **Continue** and press ENTER to confirm .



Rover setup with internal modem using NTRIP Client step-by-step

In the Communication screen:

1. Select **Int. Modem**.
2. Use the RIGHT navigation key to proceed to the next step.





In the **Int. Modem** screen:

3. Select **NTRIP Client** as **Mode** and enter/select:
 - **PIN**
 - **APN** (Access Point Name)
 - **Use/Don't use** for the **APN ID**

If **Use** is selected:

- Use the RIGHT navigation key to proceed to the **APN ID** screen. 
- And enter **User ID** and **Password**.

4. Use the RIGHT navigation key to proceed to configuring the NTRIP Client.
For detailed instructions see: [Configuration of NTRIP Client](#) 

5. When the NTRIP Client is configured use the RIGHT navigation key to proceed to the next step. 

In the Antenna screen:

6. Select the active **Antenna**, its **Height** and the **Measure** mode.
Refer to [3.6 Antenna Heights](#) for information about Antenna Heights. 

7. Use the RIGHT navigation key to proceed to the final step. 

In the Save Settings screen:

*The signal waves will flash if the **Channel** and the **Corr.Format** are correctly set.*

8. Use the RIGHT navigation key to save and apply the rover settings. 

 To discard the changes press ESCAPE.
A warning message is displayed.



Select **Continue** and press ENTER to confirm .



Rover setup with internal modem using TCP Client step-by-step

In the Communication screen:

1. Select **Int. Modem**.
2. Use the RIGHT navigation key to proceed to the next step. 

In the **Int. Modem** screen:

3. Select **TCP Client** as **Mode** and enter/select:
 - **PIN**
 - **APN** (Access Point Name)
 - **Use/Don't use** for the **APN ID**

If **Use** is selected:

- Use the RIGHT navigation key to proceed to the **APN ID** screen. 

- And enter **User ID** and **Password**.

4. Use the RIGHT navigation key to proceed to configuring the TCP Client.
For detailed instructions see: [Configuration of TCP Client](#)



5. When the TCP Client is configured use the RIGHT navigation key to proceed to the next step.



In the Antenna screen:

6. Select the active **Antenna**, its **Height** and the **Measure** mode.
Refer to [3.6 Antenna Heights](#) for information about Antenna Heights.



7. Use the RIGHT navigation key to proceed to the final step.



In the Save Settings screen:

*The signal waves will flash if the **Channel** and the **Corr.Format** are correctly set.*

8. Use the RIGHT navigation key to save and apply the rover settings.



 To discard the changes press ESCAPE.
A warning message is displayed.



Select **Continue** and press ENTER to confirm .



Rover setup with Ethernet using NTRIP Client step-by-step

In the Communication screen:

1. Select **Ethernet**.

2. Use the RIGHT navigation key to proceed to the next step.



In the Ethernet screen:

3. Select **NTRIP Client** as **Mode**.

 Set **DHCP** to **On** in order to use the DHCP (Dynamic Host Configuration Protocol) to automatically get IP address and networking parameters requested from a DHCP server.

Use the RIGHT navigation key to proceed to the next step.











 Set **DHCP** to **Off** in order to manually enter IP address and networking parameters.

Use the RIGHT navigation key to proceed to the next step.







In the **IP Address** screen enter:

- **IP**
- **Netmask**
- **Gateway**

	Use the RIGHT navigation key to proceed to the next step. In the DNS Servers screen, enter the primary and, if needed, the secondary DNS server parameters.	
4.	Use the RIGHT navigation key to proceed to configuring the NTRIP Client. For detailed instructions see: Configuration of NTRIP Client	
5.	When the NTRIP Client is configured use the RIGHT navigation key to proceed to the next step.	
In the Antenna screen:		
6.	Select the active Antenna , its Height and the Measure mode. Refer to 3.6 Antenna Heights for information about Antenna Heights.	
7.	Use the RIGHT navigation key to proceed to the final step.	
In the Save Settings screen:		
<i>The signal waves will flash if the Channel and the Corr.Format are correctly set.</i>		
8.	Use the RIGHT navigation key to save and apply the rover settings.	
	To discard the changes press ESCAPE. <i>A warning message is displayed.</i>	
	Select Continue and press ENTER to confirm .	

Rover setup via Ethernet using TCP Client step-by-step

In the Communication screen:		
1.	Select Ethernet .	
2.	Use the RIGHT navigation key to proceed to the next step.	
In the Ethernet screen:		
3.	Select TCP Client as Mode .	
	Set DHCP to On in order to use the DHCP (Dynamic Host Configuration Protocol) to automatically get IP address and networking parameters requested from a DHCP server.	
	Use the RIGHT navigation key to proceed to the next step.	
	Set DHCP to Off in order to manually enter IP address and networking parameters.	
	Use the RIGHT navigation key to proceed to the next step.	

In the **IP Address** screen enter:

- **IP**
- **Netmask**
- **Gateway**

Use the RIGHT navigation key to proceed to the next step.

In the **DNS Servers** screen, enter the primary and, if needed, the secondary DNS server parameters.



-
4. Use the RIGHT navigation key to proceed to configuring the TCP Client.
For detailed instructions see: [Configuration of TCP Client](#)



-
5. When the TCP Client is configured use the RIGHT navigation key to proceed to the next step.



In the Antenna screen:

-
6. Select the active **Antenna**, its **Height** and the **Measure** mode.
Refer to for information about Antenna Heights.



-
7. Use the RIGHT navigation key to proceed to the final step.



In the Save Settings screen:

*The signal waves will flash if the **Channel** and the **Corr.Format** are correctly set.*

-
8. Use the RIGHT navigation key to save and apply the rover settings.



To discard the changes press ESCAPE.
A warning message is displayed.



Select **Continue** and press ENTER to confirm .



Configuration of NTRIP Client

Configuration of an NTRIP Client requires configuration of:

- NTRIP Settings
- Mount Point
- RTK Settings

In the NTRIP Settings screen:

-
1. Select the Address **Mode** and enter:
- **Address**
 - **Port** number
 - **User**
 - **Password**



Address mode WWW allows the entry of a web address.



Address mode IP allows the entry of an IP address.

-
2. Use the RIGHT navigation key to proceed to the next step.



In the Mount Point screen:

3. Select the **Method**.
Choose between:
 - **Source Table:**
 - In the **Search** line select **Start** in order to start the mount point search.
 - Once the source table has been downloaded, select the desired mount point from the list available in the **Mountpoint** line.
 - **Manual** in order to manually enter the mount point name
-
4. Use the RIGHT navigation key to proceed to the next step. 

In the RTK Settings screen:

Select:

- **Corr.Format** (Correction Format)
- **Network** type
- **Ref.Rec.** (Reference Receiver)
- **Ref.Ant.** (Reference Antenna)



Refer to [RTK correction format](#) for further information about the correction formats.

Configuration of TCP Client

Configuration of a TCP Client requires configuration of:

- Server Settings
- RTK Settings

In the **Server Settings** screen:

1. Select the Address **Mode** and enter:
 - **Address**
 - **Port** number



Address mode WWW allows the entry of a web address.



Address mode IP allows the entry of an IP address.

2. Use the RIGHT navigation key to proceed to the next step. 

In the RTK Settings screen:

Select:



- **Corr.Format** (Correction Format)
- **Network** type
- **Ref.Rec.** (Reference Receiver)
- **Ref.Ant.** (Reference Antenna)



Refer to [RTK correction format](#) for further information about the correction formats.

RTK correction format

Option	Description
Leica	The proprietary Leica real-time GPS data format supporting GPS L1/L2 and GLONASS L1/ L2.

Option	Description
Leica 4G	The proprietary Leica real-time GNSS data format supporting GPS L1/ L2/ L5, GLONASS L1/ L2, Galileo E1/E5a/E5b/AltBOC and BeiDou B1/B2. This format is recommended when working exclusively with Leica instruments.
CMR / CMR+	CMR and CMR+ are compacted formats used to broadcast data for third-party instruments.
RTCM 3.1 / 3.2 MSM RTCM 2.3 18/19 RTCM 2.3 20/21	<p>Use RTCM when rover units from a different manufacturer are to be used, in order to decode the standard RTCM v3 and the RTCM v3 (MSM) messages from the base.</p> <p>RTCM 3.2 MSM supports GPS L1/ L2/ L5, GLONASS L1/ L2, Galileo E1/E5a/E5b/AltBOC and BeiDou B1/B2. Message according to RTCM version 3. A new standard format for transmission of Global Navigation Satellite System correction information. Higher efficiency than RTCM v2.x. Supports real-time services with significantly reduced bandwidth.</p> <p> Both RTCM MSM3 and RTCM MSM5 are supported. RTCM MSM3 is a compact version of the format and is suitable for low bandwidth transmission. RTCM MSM5 is an extended version of the format.</p> <p> RTCM v3 is a new standard format for transmission of Global Navigation Satellite System correction information with higher efficiency than RTCM v2.x; supports real-time services with significantly reduced bandwidth.</p>

6.3

ORP and NMEA Output

NMEA Output description

To transmit data using the NMEA standard protocol, the instrument must be configured accordingly.

 The appropriate position rate licences must be installed to access all output rates.

Configuration of NMEA Output step-by-step

1. Access the wizard via **Settings > Tools > NMEA Output**.

In the NMEA Output screen:

2. Select **On**, **Off** or **Edit** for each NMEA interface.

 Once configured usage of the NMEA interfaces can be switched **On** or **Off**.

Press ENTER to confirm your selection.



Then press ESC to be returned to the **Tools** menu.



To configure the NMEA Output for an NMEA interface proceed as follows:

3. Select **Edit**.
-
4. Press ENTER to confirm your selection and start the NMEA Output wizard. 
-

5. As **Port** for the NMEA output choose between:
- **P1**
 - **TCP Server**
 - **UDP Client**
 - **Bluetooth**
-

If P1 shall be used as Port:

Select:

- **Baud rate**
 - **Parity**
 - **Flow contr.**
-

If TCP Server shall be used as Port:

Select:

- **TCP Port**
 - **Max. clients**
-

If UDP Client shall be used as Port:

Select **Manage Hosts** in order to define Host settings.

6. For the **Talker ID** select:
- Either **Auto**
 - Or **User**
- And set the **User Talker ID** additionally.
-

If **CQ Control** is required, choose between:

- **Pos. only**
- **Pos. & Height**
- **Height only**

And set the **CQ Limit** additionally.

7. Use the RIGHT navigation key to proceed to the next step. 
-

8. For **ORP** select **Off** or set a rate.
-

To configure the ORP Output for an NMEA interface proceed as follows:

9. Select **Edit** and set:
- **Rate**
 - **Coords** (coordinate format) to be sent
- The **Height** method is set automatically according to the coordinate system used, that is either **Ellipsoidal** for WGS84 or **Orthometric** for *Local Grid*.
-  Refer to [B ORP – Orientation and Position](#) for further information about ORP.
-

10. Use the RIGHT navigation key to proceed to the next step. 
-

11. For **GGA**, **GGK**, **GGQ** and **GLL** select **Off** or set a rate. Use the RIGHT navigation key to proceed to the next step. 
-

12. For **GNS, GSA, GSV, GST** and **HDT** select **Off** or set a rate.

Proceed to the next step.



13. For **LLK, LLQ** and **PJK** select **Off** or set a rate.

Use the RIGHT navigation key to proceed to the next step.



14. For **RMC, VTG** and **ZDA** select **Off** or set the rate.

Use the RIGHT navigation key to proceed to the next step.



15. For **INF, RTD** and **SVP** select **Off** or set the rate.

Use the RIGHT navigation key to proceed to the final step.



For information on the different NMEA message formats refer to [A NMEA Message Formats](#).

16. To save and apply the NMEA Output settings select **Save** and press ENTER to confirm.



To discard your changes in the NMEA Output settings select **Undo** and press ENTER.



ORP Output

The ORP output differs from standard NMEA messages:

- The ORP message is a Leica proprietary message and delivers position information of one or two antennas.

Configurable values

- **Rate:** Define the output rate.
- **Output:** It is possible to stream one position.
- **Coords** and **Height:** The available Height format depends on the selected Coordinate format. For local coordinates a "*.lok" or an "*.xml" file is required.

ORP settings can be accessed via **Settings > Tools > NMEA Output**. Toggle to **Edit** for **NMEA Out 1** or **NMEA Out 2**. ORP is available on the second page of the wizard.

Refer to [B ORP – Orientation and Position](#) for further information about ORP.

6.4

Raw Data Logging

Raw Data logging

To log RINEX data the instrument must be configured for Raw Data logging. Access the settings via **Settings > Tools > Raw Data Logging**.



RINEX is used for post processing when high accurate coordinates are required.

Description

With a connection between the instrument and the Leica ConX web page, **Leica ConX** offers:

- **View:** Enables a remote user to access the instrument to view or control it.
- **Sync:** To exchange data between the instrument and a remote web page.
- **Track:** Enables a remote user to track the current position of the instrument.
- **Remote firmware upgrade:** Allows new instrument firmware files to be downloaded and installed remotely.



To use this functionality an account is needed for the Leica ConX web page. The license is handled on the instrument. Ask your agency or your Leica Geosystems representative for information about licensing and how to get an account.



An Internet connection on the instrument is needed, using a 4G modem. Refer to [3.3 Installing a SIM Card](#) for information about SIM card installation.

Leica ConX first setup step-by-step

In order to use Leica ConX for the first time:

1. Establish an Internet connection on the instrument
For step-by-step instructions refer to: [Configuration of the Internet Connection](#)
2. Pair the instrument to the Leica ConX web page
For step-by-step instructions refer to: [Pairing of the instrument with Leica ConX Web Unit](#)

Configuration of the Internet Connection

Refer to [3.3 Installing a SIM Card](#) for information about SIM card installation.

1. Access the wizard via **Settings > Tools > Leica ConX > Leica ConX Setup.**

In the Internet conn. screen:

2. Select as device:
 - Either **Modem**
For step-by-step instructions refer to [Internet Connection using Modem](#)
 - Or **Ethernet**
For step-by-step instructions refer to [Internet Connection using Ethernet](#)

3. Ensure that **Server** is set to:
conx.leica-geosystems.com

Select **Start pairing ...** and press ENTER to confirm.



The software starts connecting to the selected Web page. After a successful connection the pairing code is displayed.

4. Note down the code or leave this screen open.



In case of failure, check **PIN** and **APN**.

Internet Connection using Modem

1. In the **Int. Modem** screen enter/select:
 - **PIN**
 - **APN** (Access Point Name)
 - **Use/Don't use** for the **APN ID**

If **Use** is selected:

- Use the **RIGHT** navigation key to proceed to the **APN ID** screen. 
- And enter **User ID** and **Password**.

-
2. Use the **RIGHT** navigation key to proceed to the next step. 

Internet Connection using Ethernet

1. Set **DHCP** to:
 - **On:**
The DHCP (Dynamic Host Configuration Protocol) will be used to **automatically** get IP address and networking parameters requested from a DHCP server.
 - **Off:**
IP address and networking parameters need to be entered **manually**.

If DHCP is On:

2. Use the **RIGHT** navigation key to proceed to the next step. 

If DHCP is Off:

3. Use the **RIGHT** navigation key to proceed to the next step. 

In the **IP Address** screen enter:

- **IP**
- **Netmask**
- **Gateway**

Use the **RIGHT** navigation key to proceed to the next step. 

In the **DNS Servers** screen, enter the primary and, if needed, the secondary DNS server parameters.

-
4. Use the **RIGHT** navigation key to proceed to the next step. 

Pairing of the instrument with Leica ConX Web Unit



This is only necessary for the first time the instrument is connected to the Leica ConX web page.

On the remote computer:

1. Start a web-browser. Google Chrome is recommended for best performance.
2. Go to the Leica ConX web page: conx.leica-geosystems.com.
3. Use your **User name** and **Password** to login.

 An account is needed for the Leica ConX web page. The license is handled on the instrument. Ask your agency or your Leica Geosystems representative for information about licensing and how to get an account.

4. Create a Web Unit.
For step-by step instructions refer to: [Create a Leica ConX Web Unit](#)
5. Pair your instrument and the created Unit.
6. Enter the pairing code and tap **Pair**.

On the instrument:

The screen with the pairing code should have been replaced by a confirmation that the instrument is paired with the server. The device is now paired/registered on the web page, and ready to connect.

1. Use the RIGHT navigation key to proceed to the next step. 

In the Leica ConX Project screen:

*The selected **Project** is highlighted.*

2. If needed, select another project from the list.
3. Use the RIGHT navigation key to proceed to the next step. 

In the Leica ConX Track screen:

4. Set **Track** to **Yes**, if required.
5. Select the **Interval**.

The position of the paired instrument can now be sent to the Leica ConX web page.

6. Use the RIGHT navigation key to proceed to the next step. 

In the Save Settings screen:

7. Use the RIGHT navigation key to save the settings and exit the setup and successfully connect your instrument to the Leica ConX web page. 

Create a Leica ConX Web Unit

1. Select your **Company** or create a new one.
2. Select the **Project**, that the Unit shall be assigned to. If no project is available, create a project first.
3. Tap **Configure** and select **Units**.
4. Tap the **+** icon.
5. Enter the desired **Unit Name** and select the **Unit Type**. If desired, use **Note** to enter additional information. .
6. Tap **Next**.
7. Set **Device** to **iCON gps 160**.
8. Tap **Add Device** to create a Unit with the current settings.

Leica ConX Status

Use **Settings > Tools > Leica ConX > Leica ConX Status** to:

- enable or disable the **Share screen** function so that the user can view the instrument's screen from remote
- view the status of **Leica ConX** and its functions:
 - **View**
 - **Track**
 - **Sync**

Leica ConX Sync Download

1. To download data from the Leica ConX web page to the instrument select **Settings > Tools > Leica ConX > Leica ConX Sync Download**.

2. Select the **Type** of file to be downloaded:

- **System Config**
- **Coord. Systems**
- **Antenna List**
- **Licenses**
- **User Files**

3. Use the DOWN navigation key to highlight **Start Sync**.



And press ENTER to confirm.



The base point list, system configuration, antenna list and licences are automatically available after download on the instrument. One of the downloaded coordinate systems can be selected as the active coordinate system under **Settings > System Configuration > Coordinate systems**.



When copying files to the Leica ConX server via the web page, it is important that the files are copied to the following folders:

- **Base Point List, Antenna List** and **Licenses** to [System] folder
- **Coordinate Systems** (*.csys) to [CoordinateSystems]
- **User Files** to [User]



User Files support generic files of any type. The files to be downloaded must be placed in the [User] folder within the project on Leica ConX. All User Files within the [User] folder will be downloaded at the same time. The User Files can then be exported to a USB flash drive attached to the iCON antenna.

Leica ConX Sync Upload

1. To upload data from the instrument to the Leica ConX web page select **Settings > Tools > Leica ConX > Leica ConX Sync Upload**.

2. Select the **Type** of file to be uploaded:

- **System Config**
- **Coord. Systems**
- **Support Logs**
- **User Files**

3. Use the DOWN navigation key to highlight **Start Sync**.



And press ENTER to confirm.



Uploaded data will be stored to the assigned root folder on the Leica ConX web page:

- The System Configuration will be stored to [System/iCG160-SN.cfg]
- Coordinate Systems will be stored to [CoordinateSystems/*.csys]
- Support Logs will be stored to the path [Logging/logs-iCG160-SN/]; with 'SN' standing for the Serial Number of the instrument. Support Logs are **deleted from the instrument** after successful upload.
- User Files will be stored to the path [User/].
All User Files given on the iCON gps 160 will be uploaded at the same time.
User Files are **kept on the instrument** after successful upload.

Leica ConX Firmware

1. To download a firmware version from the Leica ConX web page and install it on the instrument select **Settings > Tools > Leica ConX > Leica ConX Firmware.**

 Download and installation of the new firmware can also be started from within the **Leica ConX** sub-menu, entered from the Main Menu.

The software searches for available firmware versions on the Leica ConX web page.

2. If successful, select the intended firmware version.

Then select **Start download ...** and press ENTER to confirm.



3. When download is completed, select **Install** and press ENTER to start installation.



 Ensure that a proper power supply is available as the instrument will restart after the firmware installation.

 If **Leica ConX** is enabled, the icon on the Main Menu automatically informs you when a new firmware is available.



Using Leica ConX step-by-step

 If you use Leica ConX for the first time see: [Leica ConX first setup step-by-step](#)

1. Access the wizard via **Settings > Tools > Leica ConX > Leica ConX Setup.**

2. In the **Internet conn.** screen use the RIGHT navigation key to proceed to the next step.



In the Int. Modem screen:

3. Establish an internet connection. For step-by step instructions refer to: [Internet Connection using Modem](#)

4. Ensure that **Server** is set to: conx.leica-geosystems.com.

5. If required, select **Pair again ...** and press ENTER to confirm.



If connection is successful, a message is displayed.

- Use the RIGHT navigation key to proceed to the next step.



In the Leica ConX Project screen:

- Select a **Project** from the list.
 System configuration, coordinate systems, support logs and raw data logfiles are stored within the project on the Leica ConX web page when using **Leica ConX Sync Upload**.

- Use the RIGHT navigation key to proceed to the next step.



In the Leica ConX Track screen:

- Set **Track** to **Yes**.

- Select the **Interval**.

The position of the paired instrument can now be sent to the Leica ConX web page.

- Use the RIGHT navigation key to proceed to the next step.



In the Save Settings screen:

- Use the RIGHT navigation key to save the settings and exit the setup and successfully connect your instrument to the Leica ConX web page.



6.6

Import, Export, or Delete Data

Access the Import / Export / Delete function

Select **Settings > Tools > Import / Export / Delete**, in order to:

- import or export data from/to a USB flash drive installed in the USB port of your instrument
- delete data from the internal memory

Import data from USB

Select **Settings > Tools > Import / Export / Delete > Import from USB** to import data from a USB flash drive installed in the USB port of your instrument.

Import options	Description
Base point list	imports a list of base points
Antenna list	imports a list of external antennas
System configuration	imports a system configuration and overwrites the existing one
Coordinate systems	imports coordinate system files
User Files	imports user-defined files
Base Coordinates	imports user-defined base point coordinates from a text file

To import data from a USB flash drive to the instrument, appropriate folders must be created on the USB device and the files must be placed in the correct folders:

- Coordinate systems in a folder called [CoordinateSystems]
- User Files in a folder called [User]
- Base Point list, Antenna list and System Configuration in a folder called [System]

Export data to USB

Select **Settings > Tools > Import / Export / Delete > Export to USB** to export data to a USB flash drive installed in the USB port of your instrument.

Export options	Description
Base point list	exports a list of stored base points
System configuration	generates a backup of the current system configuration, for example to restore it in the future or to share settings with other instruments
Support logs	instrument related error messages are stored in the log file and can be exported
Coordinate systems	exports coordinate system files
User Files	exports user-defined files.



To export data to a USB flash drive no folders must be created on the device manually. If not yet existing, the appropriate folders are automatically created upon export.

Delete data on the instrument

Select **Settings > Tools > Import / Export / Delete > Delete on instrument** to delete data from the internal memory.

Delete options	Description
Base point list	deletes the list of stored base points
Support logs	removes all entries from the Support Log Files
Coordinate systems	removes all Coordinate systems stored on the instrument
User Files	deletes user-defined files

6.7

Licensing

Licences

In the **Licensing** menu active licenses can be viewed or deleted, licenses can be uploaded and a license key entered. Access the settings via **Settings > Tools > Licenses**.

Licenses can be ordered at your local sales representative. The following options are available for iCON gps 160 SmartAntenna:



Option	Description
CSW967	Galileo
CSW968	BeiDou
CSW972	enables Base Station
CSW973	enables position update with 20Hz
CSW974	enables raw data RINEX logging

Option	Description
CSW975	enables NMEA streaming
CSW976	Open Interface
CSW1025	400 MHz radio
CSW1026	900 MHz radio
CSW977	Leica ConX 1 year
CSW978	Leica ConX 2 years
CSW979	Leica ConX 3 years
CSW996	Leica ConX 5 years
CSW980	Leica ConX 1 day
CSW981	Leica ConX add. 1 year
CSW982	1 year SmartLink Fill

7 Configuration of the gps 160 SmartAntenna using the Web Interface

Getting connected to the Web Interface

Connection to the web interface is established via Bluetooth.

-  The following instructions are based on using Windows.
- 1. Power on the iCG160.
 -  If you intend to use the Web Interface with iCG160 make sure the external Bluetooth antenna is attached.

- 2. On your computer go to **Start Menu > Settings > Devices**.
 -  Activate Bluetooth if not yet switched on.



- 3. Click "Add Bluetooth or other devices".
 -  Make sure that computer and sensor are in reach for a Bluetooth connection.

- 4. Click Bluetooth and select the sensor from the list. Wait for the connection to be established.
 -  The sensor can be identified by its serial number.

- 5. Go to **Start Menu > Settings > Network & Internet**. Under **Advanced Network Settings** click "Change Adapter Options". In the **Network Connections** page double-click on "Bluetooth Network Connection". Finally, right-click on the sensor that you have just added and select **Connect using > Access Point** from the context menu.

- 6. Open a browser on your computer and enter the URL: <http://www.icgsetup.leica-geosystems.com> User name is "leica", as password enter the serial number of the sensor.
 -  Alternatively you can enter the IP address: 172.16.0.1

- 7. Start configuring the iCG160 using the Web Interface.
 -  For mobile devices it is only required to pair the sensor via Bluetooth.

Description	<p>GNSS measured points are always stored based on the global geocentric datum known as WGS 1984. Most surveys require coordinates in a local grid system. For example, based on a country's official mapping datum or an arbitrary grid system used in a particular area such as a construction site. To convert the WGS 1984 coordinates into local coordinates a coordinate system must be created. Part of the coordinate system is the transformation used to convert coordinates from the WGS 1984 datum to the local datum.</p> <p>A coordinate system</p> <ul style="list-style-type: none"> • allows the conversion from WGS 1984 geodetic or cartesian coordinates to local grid coordinates and back. • can be directly received from a reference network. • can be uploaded from a USB Memory device. • can be exported to a USB Memory device. <p> Refer to 6.6 Import, Export, or Delete Data for information about importing, exporting, or deleting coordinate systems.</p>
Default coordinate systems	<p>The default coordinate system is WGS 1984. It cannot be deleted. It is not possible to create a coordinate system called WGS 1984.</p> <p>Additional default coordinate systems may be available for certain countries.</p>
Active coordinate system	<p>The active coordinate system is the one selected under Settings > System Configuration > Coordinate systems. One coordinate system is always considered as the active coordinate system.</p>
Automatic coordinate system (RTCM transformation parameters)	<p>When Via Network is selected under Settings > System Configuration > Coordinate systems, the coordinate system is directly received from the reference network via RTCM correction data.</p> <p> Reference networks do not always provide a coordinate system. This will depend on how the network provider has chosen to configure their data streams.</p>
Coordinate system components	<p>The iCON gps 160 SmartAntenna supports the same coordinate system formats as other Leica iCON products including iCON 3D, iCON Office, iCON-struct field software, as well as Leica RedLine and GNSS Leica Viva sensors.</p> <p>Coordinate systems can be made up of up to three linked files:</p> <ul style="list-style-type: none"> • .lok: Localisation file, contains all the needed parameters and settings, for example datum, map projection and local transformation. • .ccg: Correction grid (Country Specific Coordinate System model). Refer to CSCS model (*.ccg) for information about CSCS. • .grd: Geoid model. Refer to Geoid model for further information. • .csc: Correction grid (Country Specific Coordinate System model). • .gem: Geoid model.

9 Care and Transport

9.1 Transport

Transport in the field	<p>When transporting the equipment in the field, always make sure that you</p> <ul style="list-style-type: none">• either carry the product in its original container,• or carry the tripod with its legs splayed across your shoulder, keeping the attached product upright.
Transport in a road vehicle	<p>Never carry the product loose in a road vehicle, as it can be affected by shock and vibration. Always carry the product in its container and secure it.</p> <p>For products for which no container is available use the original packaging or its equivalent.</p>
Shipping	<p>When transporting the product by rail, air or sea, always use the complete original Leica Geosystems packaging, container and cardboard box, or its equivalent, to protect against shock and vibration.</p>
Shipping, transport of batteries	<p>When transporting or shipping batteries, the person responsible for the product must ensure that the applicable national and international rules and regulations are observed. Before transportation or shipping, contact your local passenger or freight transport company.</p>

9.2 Storage

Product	<p>Respect the temperature limits when storing the equipment, particularly in summer if the equipment is inside a vehicle. Refer to 10 Technical Data for information about temperature limits.</p>
Li-Ion batteries	<ul style="list-style-type: none">• Refer to Environmental specifications for information about storage temperature range• Remove batteries from the product and the charger before storing• After storage recharge batteries before using• Protect batteries from damp and wetness. Wet or damp batteries must be dried before storing or use• A storage temperature range of 0 °C to +30 °C / +32 °F to +86 °F in a dry environment is recommended to minimize self-discharging of the battery• At the recommended storage temperature range, batteries containing a 40% to 50% charge can be stored for up to one year. After this storage period the batteries must be recharged

9.3 Cleaning and Drying

Product and accessories	<ul style="list-style-type: none">• Use only a clean, soft, lint-free cloth for cleaning. If necessary, moisten the cloth with water or pure alcohol. Do not use other liquids; these may attack the polymer components.
Damp products	<p>Dry the product, the transport container, the foam inserts and the accessories at a temperature not greater than 40 °C/104 °F and clean them. Remove the battery cover and dry the battery compartment. Do not repack until everything is dry. Always close the transport container when using in the field.</p>

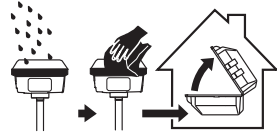

Cables and plugs

Keep plugs clean and dry. Blow away any dirt lodged in the plugs of the connecting cables.

Connectors with dust caps

Wet connectors must be dry before attaching the dust cap.

10

Technical Data

10.1

Technical Data iCON gps 160 SmartAntenna

10.1.1

Tracking Characteristics

Instrument technology

SmartTrack

Satellite reception

Multi-frequency

Instrument channels



Depending on the satellite systems and signals configured, a maximum number of 555 channels is allocated.

Supported codes and phases

GPS

L1	L2	L5
Carrier phase, C/A-code	Carrier phase, C code (L2C) and P2-code	Carrier phase, code

GLONASS

L1	L2
Carrier phase, C/A-code	Carrier phase, C/A-code and P-code

Galileo

E1	E5a	E5b	Alt-BOC
Carrier phase, code	Carrier phase, code	Carrier phase, code	Carrier phase, code

BeiDou

B1	B2	B3
Carrier phase, code	Carrier phase, code	Carrier phase, I-code



Carrier phase and code measurements on L1, L2 and L5 (GPS) are fully independent with AS on or off.

10.1.2

Accuracy



Accuracy is dependent upon various factors including the number of satellites tracked, constellation geometry, observation time, ephemeris accuracy, ionospheric disturbance, multipath and resolved ambiguities.

The following accuracies, given as **root mean square**, are based on measurements processed using LGO and on real-time measurements.

The use of multiple GNSS systems can increase accuracy by up to 30% relative to GPS only.

Differential code

The baseline precision of a differential code solution for static and kinematic surveys is 25 cm.

Differential phase in post-processing

Static and rapid static

Static		Kinematic	
Horizontal	Vertical	Horizontal	Vertical
5 mm + 0.5 ppm	10 mm + 0.5 ppm	10 mm + 1 ppm	20 mm + 1 ppm

Static with long observations

Static		Kinematic	
Horizontal	Vertical	Horizontal	Vertical
3 mm + 0.1 ppm	3.5 mm + 0.4 ppm	10 mm + 1 ppm	20 mm + 1 ppm

Differential phase in real-time

Type	Horizontal	Vertical
Single Baseline (<30 km)	8 mm + 1 ppm	15 mm + 1 ppm
Network RTK	8 mm + 0.5 ppm	15 mm + 0.5 ppm

10.1.3

General Technical Data of the Product

Dimensions

The overall dimensions are given for the housing including the sockets.

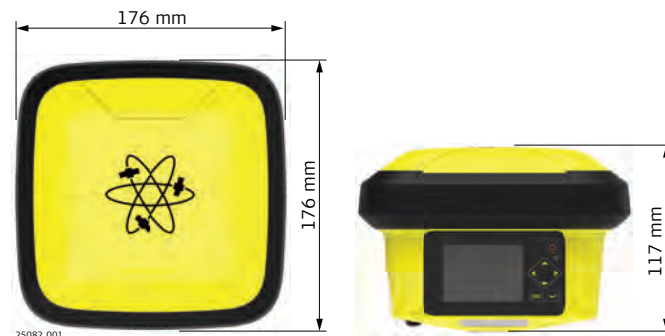

Type	Length [mm]	Width [mm]	Thickness [mm]
iCON gps 160 SmartAntenna	176	176	117

Weight

Instrument weight without battery:

Type	Weight [kg]/[lbs]
iCON gps 160 SmartAntenna	1.48/3.27 (including internal LTE modem)

☞ Modem and radio are integrated (according to the variant).

Recording

Data (LeicaGNSS raw data and RINEX data) can be recorded on the internal memory.

Capacity [GB]: 8

Power	Power consumption:	iCON gps 160 SmartAntenna: 6 W typically, 500 mA
	External supply voltage:	Nominal 12 V DC, GEV71 car battery cable to a 12 V car battery), voltage range 9 V-35 V DC

Internal battery	Type:	Li-Ion
	Nominal Voltage:	10.8 V
	Capacity:	GEB334: 3.45 Ah

Battery external	Type:	NiMH
	Voltage:	13 V
	Capacity:	GEB373: 16.6 Ah

Operating times

The given operating times are valid for

- iCON gps 160 SmartAntenna: fully charged GEB334 battery.
- room temperature. Operating times will be shorter when working in cold weather.

Equipment			Operating time
Type	Radio	Digital cellular phone	
Static	-	-	up to 8 h continuously
Rover	SATELLINE TR489	-	up to 7 h continuously
Rover	-	built-in LTE Modem	up to 6:45 h continuously
Rover (controller modem)	-	-	up to 7:45 h continuously

Electrical data	Type	iCON gps 160 SmartAntenna	
	Voltage	Nominal 12 V	
	Current	6.0 W typically, 12 V @ 500 mA	
	Frequency	GPS L1	1575.42 MHz
		GPS L2	1227.60 MHz
		GPS L5	1176.45 MHz
		GLONASS L1	1602.5625 MHz - 1611.5 MHz
		GLONASS L2	1246.4375 MHz - 1254.3 MHz
		Galileo E1	1575.42 MHz
Galileo E5a		1176.45 MHz	
Galileo E5b	1207.14 MHz		
Galileo AltBOC	1191.795 MHz		
BeiDou B1	1561.098 MHz		
BeiDou B2	1207.14 MHz		

Type	iCON gps 160 SmartAntenna
	BeiDou B3 1268.52 MHz Bluetooth 2400 MHz - 2483.5 MHz
Gain	Typically 27 dBi
Noise Figure	Typically < 2 dBi

 For corresponding information for optional, internal radios refer to their specifications.



Galileo AltBOC covers bandwidth of Galileo E5a and E5b.

Environmental specifications

Temperature

Type	Operating temperature [°C]	Storage temperature [°C]
Instrument	-40 to +65	-40 to +85
Battery internal	-20 to +60	-40 to +70

Protection against water, dust and sand

Type	Protection
Instrument	IP66/IP68 (IEC 60529) Dust tight Waterproof for continuous immersion

Humidity

Type	Protection
Instrument	Up to 95 % To avoid the effects of condensation, periodically dry out the instrument.

Vibration/Shock

Type	iCON gps 160 SmartAntenna
Vibration	MIL-STD 810G, Fig. 514.6E-1, Cat24 IEC 60068-2-6, 5 G, 5-500 Hz
Shock	45 g - 6 msec; in compliance with IEC 60068-2-27 No loss of lock to satellite signal when used on a pole set-up and submitted to pole bumps up to 150 mm
Drops Withstands	1.2 m drop onto hard surfaces
Topple over Withstands	Topple over from a 2 m pole onto hard surfaces

10.2

Antennas Technical Data

Description and use

The GNSS antenna is selected for use based upon the application. The table gives a description and the intended use of the antenna.

Type	Description	Use
CGA100	GPS, GLONASS, Galileo, BeiDou SmartRack+ antenna with built-in ground plane.	Machine Control, RTK Base Station, RTK Rover and Network RTK applications.

Dimensions

Type	CGA100
Height	60 mm
Diameter	165 mm

Connector

TNC female

Mounting

5/8" Whitworth

Weight

0.4 kg

Electrical data

Type	CGA100
Voltage	3.8 V to 18 V DC
Current	35 mA typical
Frequency	
GPS L1	1575.42 MHz
GPS L2	1227.60 MHz
GPS L5	1176.45 MHz
GLONASS L1	1602.5625 - 1611.5 MHz
GLONASS L2	1246.4375 - 1254.3 MHz
GLONASS L3	1207.14 MHz
Galileo E1	1575.42 MHz
Galileo E5a	1176.45 MHz
Galileo E5b	1207.14 MHz
Galileo E6	1278.75 MHz
Galileo AltBOC	1191.795 MHz
BeiDou B1	1561.098 MHz
BeiDou B2	1207.14 MHz
BeiDou B3	1268.52 MHz
QZSS	L1 1575.42 MHz
QZSS	L2 1227.6 MHz
QZSS	L5 1176.45 MHz
QZSS	L6 1278.75 MHz
Gain (typically)	29 dB
Noise Figure (typically)	2 dB



Galileo AltBOC covers bandwidth of Galileo E5a and E5b.

Environmental specifications

Temperature

Type	Operating temperature [°C]	Storage temperature [°C]
CGA100	-40 to +85	-55 to +85

Protection against water, dust and sand

Type	Protection
CGA100	IP68, IP69K Dust tight Protected against water jets Waterproof to 1 m temporary immersion

Humidity

Type	Protection
CGA100	IEC60068-2-30 98% r.H. / 25°C 93% r.H. / 55°C The effects of condensation are to be effectively counteracted by periodically drying out the antenna.

Vibration/shock

Type	CGA100
Vibration	IEC 60068-2-6: 5 - 500 Hz, 15 g, ±15 mm MIL-STD-810G: Fig.514.6E-1: Category 24 (20 - 2000 Hz, 7.7 grms)
Shock	IEC 60068-2-27 (special): 60 g, 6 ms IEC 60068-2-27: 100 g, 2 ms

Cable length

Separation distance from instrument ...	to antenna	Optional cable lengths [m]
iCON gps 160	CGA100	2.8, 5, 10

10.3

Pin Assignments and Sockets

Expert knowledge required

Modification or adaption on base of the pin assignments and socket descriptions need expert knowledge.

Changes or modifications not expressly approved by Leica Geosystems for compliance could void the user's authority to operate the equipment.

Port 1- Lemo

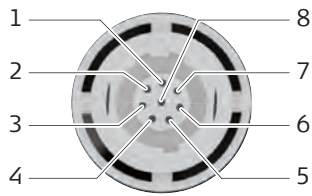

25083.001

Pin	Name	Function	Direction
1	RTS	RS232, R esult T o S end	Out
2	CTS	RS232, C lear T o S end	In
3	GND	Ground	-
4	RxD	RS232, receive data	In
5	TxD	RS232, transmit data	Out
6	ID	Identification pin	In
7	PWR in	Power in, 9 to 35 V DC	In
8	+12 V out	12 V DC power supply out	Out

ANT

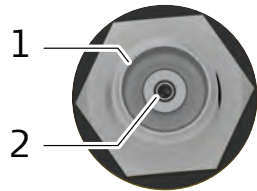

0024280.001

Pin	Description
1	Shield/Ground
2	Antenna signal and antenna power

USB 2.0 host connector



Type: USB-A receptacle

Pin	Name	Description	Direction
1	+5V	+5V Power supply	Out
2	D-	Data signal negative	In/Out
3	D+	Data signal positive	In/Out
4	GND	Power supply return and signals reference	In

Picture: Receptacle viewed from mating side.

10.4 Conformity Declarations

10.4.1 iCON gps 160

Labelling iCON gps 160 SmartAntenna



25019.001

Model: iCG160
Equip. No.: 1234567
Art.No.: 123456
S. No.: 1234567
Manufactured MM/YYYY



Leica Geosystems AG
CH-9435 Heerbrugg
Made in Switzerland
Power: 9-35V / ---1A max.
IP66/68



Contains transmitter module FCC ID / IC:
N7NEM75 / 2417C-EM75



This device complies with part 15 of the FCC Rules.
Operation is subject to the following two conditions:
(1) This device may not cause harmful interference, and
(2) This device must accept any interference received, including interference that may cause undesired operation.

FCC ID: RFD-ICG160
IC: 3177A-ICG160



GB Importer: Leica Geosystems Ltd.
Hexagon House, Michigan Drive,
Tongwell, Milton Keynes, MK15 8HT

Labelling internal battery GEB334



0023497.001



Model 型號: GEB334 Art. No.: 954518
Rechargeable Li-ion Battery 二次可充電電池
Nominal Voltage: 10.8 V-n 額定電壓: 3.1V x 3
Rated Capacity: 3.45Ah/37.26Wh 額定容量: 1.2 A R3C319
Manufactured For: Leica Geosystems AG, CH-9435 Heerbrugg
Made in China 中國製造

This device complies with part 15 of the FCC Rules.
Operation is subject to the following two conditions:
(1) This device may not cause harmful interference,
and (2) This device must accept any interference received, including interference that may cause undesired operation.



Antenna

Type	Antenna type	Connector	Frequency band [MHz]
Bluetooth	Integrated antenna	-	2402 - 2480
UMTS/LTE	Integrated antenna	-	698 - 960 1710 - 2170 2300 - 2400 2500 - 2690

Frequency band

Type	Frequency band [MHz]
Bluetooth	2402 - 2480
Radio	403 - 473 (TR489) 902 - 928 (TR489)

EM7565

Type	Frequency band [MHz]	
WCDMA	Band 1 Tx: 1920 - 1980 Rx: 2110 - 2170	
	Band 2 Tx: 1850 - 1910 Rx: 1930 - 1990	
	Band 4 Tx: 1710 - 1755 Rx: 2110 - 2155	
	Band 5 Tx: 824 - 849 Rx: 869 - 894	
	Band 6 Tx: 830 - 840 Rx: 875 - 885	
	Band 8 Tx: 880 - 915 Rx: 925 - 960	
	Band 9 Tx: 1749.9 - 1784.9 Rx: 1844.9 - 1879.9	
	Band 19 Tx: 830 - 845 Rx: 875 - 890	
	LTE	Band 1 Tx: 1920 - 1980 Rx: 2110 - 2170
		Band 2 Tx: 1850 - 1910 Rx: 1930 - 1990
Band 3 Tx: 1710 - 1785 Rx: 1805 - 1880		
Band 4 Tx: 1710 - 1755 Rx: 2110 - 2155		
Band 5 Tx: 824 - 849 Rx: 869 - 894		
Band 7 Tx: 2500 - 2570 Rx: 2620 - 2690		
Band 8 Tx: 880 - 915 Rx: 925 - 960		

Type	Frequency band [MHz]
	Band 9 Tx: 1749.9 - 1784.9 Rx: 1844.9 - 1879.9
	Band 12 Tx: 699 - 716 Rx: 729 - 746
	Band 13 Tx: 777 - 787 Rx: 746 - 756
	Band 18 Tx: 815 - 830 Rx: 860 - 875
	Band 19 Tx: 830 - 845 Rx: 875 - 890
	Band 20 Tx: 832 - 862 Rx: 791 - 821
	Band 26 Tx: 814 - 849 Rx: 859 - 894
	Band 28 Tx: 703 - 748 Rx: 758 - 803
	Band 29 Tx: n/a Rx: 717 - 728
	Band 30 Tx: 2305 - 2315 Rx: 2350 - 2360

Output power

Type	Output power [mW]
Bluetooth	3.0
UMTS	Band 1, 2, 4, 5, 6, 8, 9, 19: 200
LTE	Band 1, 2, 3, 4, 5, 8, 9, 12, 13, 18, 19, 20, 26, 28: 200 Band 7: 160

Radiation Exposure Statement

The radiated output power of the instrument is below the radio frequency exposure limits. Nevertheless, the instrument should be used in such a manner that the potential for human contact during normal operation is minimised. To avoid the possibility of exceeding the radio frequency exposure limits, keep a distance of at least 31 cm between you (or any other person in the vicinity) and the instrument.

Specific Absorption Rate (SAR)

The product meets the limits for the maximum permissible exposure of the guide-lines and standards which are force in this respect. The product must be used with the recommended antenna. A separation distance of at least 31

centimetres should be kept between the antenna and the body of the user or nearby person within the intended application.

SAR limits

Country	Head	Body	Limb
EU	0.5 W/Kg, 10-gram	0.5 W/Kg, 10-gram	n/a
France	0.5 W/Kg, 10-gram	0.5 W/Kg, 10-gram	0.5 W/Kg, 10-gram
USA & Canada	1.492 W/Kg, 1-gram	1.6 W/Kg, 1-gram	n/a

EU



Hereby, Leica Geosystems AG declares that the radio equipment type iCON gps 160 is in compliance with Directive 2014/53/EU and other applicable European Directives. The full text of the EU declaration of conformity is available at the following Internet address: <http://www.leica-geosystems.com/ce>.

USA

FCC ID: XXX-ICG160
FCC Part 15, 22, 24, 27 and 90

This device complies with part 15 of the FCC Rules. Operation is subject to the following two conditions:

1. This device may not cause harmful interference, and
2. This device must accept any interference received, including interference that may cause undesired operation.

This equipment has been tested and found to comply with the limits for a Class B digital device, pursuant to part 15 of the FCC Rules.

These limits are designed to provide reasonable protection against harmful interference in a residential installation.

This equipment generates, uses, and can radiate radio frequency energy and, if not installed and used in accordance with the instructions, it may cause harmful interference to radio communications.

However, there is no guarantee that interference does not occur in a particular installation.

If this equipment does cause harmful interference to radio or television reception, which can be determined by turning the equipment off and on, the user is encouraged to try to correct the interference by one or more of the following measures:

- Reorient or relocate the receiving antenna.
- Increase the separation between the equipment and the receiver.
- Connect the equipment into an outlet on a circuit different from that to which the receiver is connected.
- Consult the dealer or an experienced radio/TV technician for help.

Changes or modifications not expressly approved by Leica Geosystems for compliance could void the user's authority to operate the equipment.

Canada

CAN ICES-003 Class B/NMB-003 Class B
IC: XXXXX-ICG160

Canada Compliance Statement

This device contains licence-exempt transmitter(s)/receiver(s) that comply with Innovation, Science and Economic Development Canada's licence-exempt RSS(s). Operation is subject to the following two conditions:

1. This device may not cause interference
2. This device must accept any interference, including interference that may cause undesired operation of the device

Canada Déclaration de Conformité

L'émetteur/récepteur exempt de licence contenu dans le présent appareil est conforme aux CNR d'Innovation, Sciences et Développement économique Canada applicables aux appareils radio exempts de licence. L'exploitation est autorisée aux deux conditions suivantes:

1. L'appareil ne doit pas produire de brouillage
2. L'appareil doit accepter tout brouillage radioélectrique subi, même si le brouillage est susceptible d'en compromettre le fonctionnement

WARNING

This device complies with Industry Canada's licence-exempt RSSs. Operation is subject to the following two conditions:

1. This device may not cause interference; and
2. This device must accept any interference, including interference that may cause undesired operation of the device.

Japan

- This device is granted pursuant to the Japanese Radio Law (電波法) and the Japanese Telecommunications Business Law (電気通信事業法).
- This device should not be modified (otherwise the granted designation number will become invalid).

Others

The conformity for countries with other national regulations has to be approved prior to use and operation.

10.4.2

CGA100

Labelling CGA100

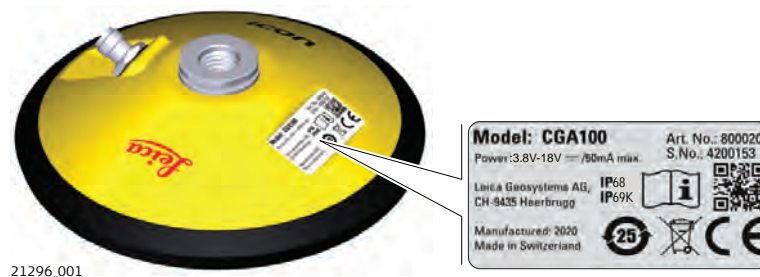

Frequency band

Type	CGA100
GPS L1	1575.42 MHz
GPS L2	1227.60 MHz
GPS L5	1176.45 MHz
GLONASS L1	1602.5625 - 1611.5 MHz
GLONASS L2	1246.4375 - 1254.3 MHz

Type	CGA100
GLONASS L3	1207.14 MHz
Galileo E1	1575.42 MHz
Galileo E5a	1176.45 MHz
Galileo E5b	1207.14 MHz
Galileo E6	1278.75 MHz
Galileo AltBOC	1191.795 MHz
BeiDou B1	1561.098 MHz
BeiDou B2	1207.14 MHz
BeiDou B3	1268.52 MHz
QZSS	L1 1575.42 MHz
QZSS	L2 1227.6 MHz
QZSS	L5 1176.45 MHz
QZSS	L6 1278.75 MHz

Output power

Receive only

EU



Hereby, Leica Geosystems AG declares that the product/s is/are in compliance with the essential requirements and other relevant provisions of the applicable European Directives.

The full text of the EU declaration of conformity is available at the following Internet address:

<http://www.leica-geosystems.com/ce>.

CAUTION

This equipment is not intended for use in residential environments and may not provide adequate protection to radio reception in such environments.

USA

FCC Part 15, 22, 24, 27 and 90

This equipment has been tested and found to comply with the limits for a Class B digital device, pursuant to part 15 of the FCC Rules.

These limits are designed to provide reasonable protection against harmful interference in a residential installation.

This equipment generates, uses, and can radiate radio frequency energy and, if not installed and used in accordance with the instructions, it may cause harmful interference to radio communications.

However, there is no guarantee that interference does not occur in a particular installation.

If this equipment does cause harmful interference to radio or television reception, which can be determined by turning the equipment off and on, the user is encouraged to try to correct the interference by one or more of the following measures:

- Reorient or relocate the receiving antenna.
- Increase the separation between the equipment and the receiver.
- Connect the equipment into an outlet on a circuit different from that to which the receiver is connected.
- Consult the dealer or an experienced radio/TV technician for help.

Changes or modifications not expressly approved by Leica Geosystems for compliance could void the user's authority to operate the equipment.

Canada

CAN ICES-003 Class B/NMB-003 Class B

Others

The conformity for countries with other national regulations has to be approved prior to use and operation.

10.5

Dangerous Goods Regulations

Dangerous Goods Regulations

Many products of Leica Geosystems are powered by Lithium batteries.

Lithium batteries can be dangerous under certain conditions and can pose a safety hazard. In certain conditions, Lithium batteries can overheat and ignite.



When carrying or shipping your Leica product with Lithium batteries onboard a commercial aircraft, you must do so in accordance with the **IATA Dangerous Goods Regulations**.



Leica Geosystems has developed **Guidelines** on "How to carry Leica products" and "How to ship Leica products" with Lithium batteries. Before any transportation of a Leica product, we ask you to consult these guidelines on our web page ([IATA Lithium Batteries](#)) to ensure that you are in accordance with the IATA Dangerous Goods Regulations and that the Leica products can be transported correctly.



Damaged or defective batteries are prohibited from being carried or transported onboard any aircraft. Therefore, ensure that the condition of any battery is safe for transportation.

Software Licence Agreement

This product contains software that is preinstalled on the product, or that is supplied to you on a data carrier medium, or that can be downloaded by you online according to prior authorisation from Leica Geosystems. Such software is protected by copyright and other laws and its use is defined and regulated by the Leica Geosystems Software Licence Agreement, which covers aspects such as, but not limited to, Scope of the Licence, Warranty, Intellectual Property Rights, Limitation of Liability, Exclusion of other Assurances, Governing Law and Place of Jurisdiction. Please make sure, that at any time you fully comply with the terms and conditions of the Leica Geosystems Software Licence Agreement.

Such agreement is provided together with all products and can also be referred to and downloaded at the Leica Geosystems home page at [Hexagon – Legal Documents](#) or collected from your Leica Geosystems distributor.

You must not install or use the software unless you have read and accepted the terms and conditions of the Leica Geosystems Software Licence Agreement. Installation or use of the software or any part thereof, is deemed to be an acceptance of all the terms and conditions of such Licence Agreement. If you do not agree to all or some of the terms of such Licence Agreement, you must not download, install or use the software and you must return the unused software together with its accompanying documentation and the purchase receipt to the distributor from whom you purchased the product within ten (10) days of purchase to obtain a full refund of the purchase price.

Open source information

The software on the product may contain copyright-protected software that is licensed under various open source licences.

Copies of the corresponding licences

- are provided together with the product (for example in the About panel of the software)
- can be downloaded on <http://opensource.leica-geosystems.com/icon>

If foreseen in the corresponding open source licence, you may obtain the corresponding source code and other related data from the iCON section on <http://opensource.leica-geosystems.com>.

Contact opensource@leica-geosystems.com in case you need additional information.

Appendix A NMEA Message Formats

A.1 Overview

Description National Marine Electronics Association is a standard for interfacing marine electronic devices. This chapter describes all NMEA-0183 messages which can be output by the instrument.

Access Select **Settings > Tools > NMEA Output**.



A Talker ID appears at the beginning of the header of each NMEA message. The Talker ID can be user defined or standard (based on the NMEA 4.0). The standard is normally GP for GPS but can be changed in **Settings > Tools > NMEA Output**.



When enabling CQ Control, the coordinate quality is being checked. If the coordinate quality of the position and/or the height component exceeds the defined limit, no NMEA messages are output.

A.2 Symbols Used for Describing the NMEA Formats

Description NMEA messages consist of various fields. The fields are:

- Header
- Special format fields
- Numeric value fields
- Information fields
- Null fields

Certain symbols are used as identifier for the field types. These symbols are described in this section.

Header

Symbol	Field	Description	Example
\$	-	Start of sentence	\$
--ccc	Address	<ul style="list-style-type: none">• -- = alphanumeric characters identifying the talker Options: GN = G lobal N avigation S atellite S ystem GP = GPS only GL = GLONASS GA = Galileo GB = BeiDou GQ = QZSS	GNGGA GPGGA GLGGA GAGGA GBGGA GQGGA

Symbol	Field	Description	Example
		<ul style="list-style-type: none"> ccc = alphanumeric characters identifying the data type and string format of the successive fields. Usually the name of the message. 	

Special format fields

Symbol	Field	Description	Example
A	Status	<ul style="list-style-type: none"> A = Yes, Data Valid, Warning Flag Clear V = No, Data Invalid, Warning Flag Set 	V
lll.ll	Latitude	<ul style="list-style-type: none"> Degreesminutes.decimal Two fixed digits of degrees, two fixed digits of minutes and a variable number of digits for decimal fraction of minutes. Leading zeros are always included for degrees and minutes to maintain fixed length. 	4724.538950
yyyyy.yy	Longitude	<ul style="list-style-type: none"> Degreesminutes.decimal Three fixed digits of degrees, two fixed digits of minutes and a variable number of digits for decimal fraction of minutes. Leading zeros are always included for degrees and minutes to maintain fixed length. 	00937.046785
eeeeee.eee	Grid Easting	At the most six fixed digits for metres and three fixed digits for decimal fractions of metres.	195233.507
nnnnnn.nnn	Grid Northing	At the most six fixed digits for metres and three fixed digits for decimal fractions of metres.	127223.793
hhmmss.ss	Time	<ul style="list-style-type: none"> hoursminuteseconds.decimal Two fixed digits of hours, two fixed digits of minutes, two fixed digits of seconds and a variable number of digits for decimal fraction of seconds. 	115744.00

Symbol	Field	Description	Example
		<ul style="list-style-type: none"> Leading zeros are always included for hours, minutes and seconds to maintain fixed length. 	
mmddy	Date	<ul style="list-style-type: none"> Monthdayyear - two fixed digits of month, two fixed digits of day, two fixed digits of year. Leading zeros always included for month, day and year to maintain fixed length. 	093003
No specific symbol	Defined field	<ul style="list-style-type: none"> Some fields are specified to contain predefined constants, most often alpha characters. Such a field is indicated by the presence of one or more valid characters. Excluded from the list of valid characters are the following that are used to indicate other field types: A, a, c, x, hh, hhmss.ss, lll.ll, yyyyy.yy. 	M

Numeric value fields

Symbol	Field	Description	Example
x.x	Variable numbers	<ul style="list-style-type: none"> Integer or floating numeric field Optional leading and trailing zeros. Decimal point and associated decimal-fraction are optional if full resolution is not required. 	73.10 = 73.1 = 073.1 = 73
hh_	Fixed HEX field	Fixed length HEX numbers	3F

Information fields

Symbol	Field	Description	Example
c--c	Variable text	Variable length valid character field	A
aa_	Fixed alpha field	Fixed length field of upper case or lower case alpha characters	N
xx_	Fixed number field	Fixed length field of numeric characters	1

Null fields

Symbol	Field	Description	Example
No symbol	Information unavailable for output	Null fields do not contain any information.	„



Fields are always separated by a comma. Before the Checksum field there is never a comma.



When information for a field is not available, the position in the data string is empty.

A.3

GGA - Global Positioning System Fix Data

Syntax

```
$--GGA,hhmmss.ss,llll.ll,a,yyyyy.yy,a,x,xx,x.x,x.x,M,x.x,M,x.x,xxxx*hh<CR><LF>
```

Description of fields

Field	Description
\$--GGA	Header including Talker ID
hhmmss.ss	UTC time of position
llll.ll	Latitude (WGS 1984)
a	Hemisphere, N orth or S outh
yyyyy.yy	Longitude (WGS 1984)
a	E ast or W est
x	Position quality indicator 0 = Fix not available or invalid 1 = No real-time position, navigation fix 2 = Real-time position, ambiguities not fixed 3 = Valid fix for GNSS P recise P ositioning S ervice mode, for example WAAS 4 = Real-time position, ambiguities fixed
xx	Number of satellites in use. For \$GNGGA messages: The combined GPS, GLONASS, Galileo and BeiDou satellites used in the position.
x.x	HDOP
x.x	Altitude of position marker above/below mean sea level in metres. If no orthometric height is available the local ellipsoidal height will be exported. If the local ellipsoidal height is not available either, the WGS 1984 ellipsoidal height will be exported.
M	Units of altitude as fixed text M
x.x	Geoidal separation in metres. The Geoidal separation is the difference between the WGS 1984 earth ellipsoid surface and mean sea level.
M	Units of geoidal separation as fixed text M
x.x	Age of differential GNSS data, empty when DGPS not used
xxxx	Differential base station ID, 0000 to 1023

Field	Description
*hh	Checksum
<CR>	Carriage Return
<LF>	Line Feed

Examples

For NMEA v4.0 and v4.1:

Standard Talker ID = GPS only

```
$GPGGA,141909.00,4724.5294609,N,00937.0836236,E,1,09,1.0,366.745,M,100.144,M,,*52
```

Standard Talker ID = GNSS

```
$GNGGA,142309.00,4724.5296834,N,00937.0832766,E,1,16,0.7,366.740,M,100.144,M,,*4E
```

A.4

GGK - Real-Time Position with DOP

Syntax

```
$--GGK,hhmmss.ss,mmddy,lll.ll,a,yyyyy.yy,a,x,xx,x.x,EHTx.x,M*hh<CR><LF>
```

Description of fields

Field	Description
\$--GGK	Header including Talker ID
hhmmss.ss	UTC time of position
mmddy	UTC date
lll.ll	Latitude (WGS 1984)
a	Hemisphere, N orth or S outh
yyyyy.yy	Longitude (WGS 1984)
a	E ast or W est
x	Position quality indicator 0 = Fix not available or invalid 1 = No real-time position, navigation fix 2 = Real-time position, ambiguities not fixed 3 = Real-time position, ambiguities fixed 5 = Real-time position, float
xx	Number of satellites in use. For \$GNGGK messages: The combined GPS, GLONASS, Galileo and BeiDou satellites used in the position.
x.x	GDOP
EHT	Ellipsoidal height
x.x	Altitude of position marker as local ellipsoidal height. If the local ellipsoidal height is not available, the WGS 1984 ellipsoidal height will be exported.
M	Units of altitude as fixed text M
*hh	Checksum
<CR>	Carriage Return

Field	Description
<LF>	Line Feed

Examples

For NMEA v4.0 and v4.1:

Standard Talker ID = GPS only

```
$GPGGK,142804.00,111414,4724.5292267,N,00937.0832394,E,1,09,2.3,EHT4
66.919,M*46
```

Standard Talker ID = GNSS

```
$GNGGK,142629.00,111414,4724.5295910,N,00937.0831490,E,1,16,1.6,EHT
467.089,M*5C
```

A.5

GGQ - Real-Time Position with CQ

Syntax

```
$--GGQ,hhmmss.ss,mmddy,lll.ll,a,yyyy.yy,a,x,xx,x.x,x.x,M*hh<CR><LF>
```

Description of fields

Field	Description
\$--GGQ	Header including talker ID
hhmmss.ss	UTC time of position
mmddy	UTC date
lll.ll	Latitude (WGS 1984)
a	Hemisphere, N orth or S outh
yyyy.yy	Longitude (WGS 1984)
a	E ast or W est
x	Position quality indicator 0 = Fix not available or invalid 1 = No real-time position, navigation fix 2 = Real-time position, ambiguities not fixed 3 = Real-time position, ambiguities fixed 5 = Real-time position, float
xx	Number of satellites in use. For \$GNGGQ messages: The combined GPS, GLONASS, Galileo and BeiDou satellites used in the position.
x.x	Coordinate quality in metres
x.x	Altitude of position marker above/below mean sea level in metres. If no orthometric height is available the local ellipsoidal height will be exported. If the local ellipsoidal height is not available either, the WGS 1984 ellipsoidal height will be exported.
M	Units of altitude as fixed text M
*hh	Checksum
<CR>	C arriage R eturn
<LF>	L ine F eed

Examples

For NMEA v4.0:

Standard Talker ID = GPS only

```
$GPGGQ,144419.00,111414,4724.5290370,N,00937.0833037,E,1,10,3.894,3  
66.261,M*01
```

Standard Talker ID = GNSS

```
$GNGGQ,144054.00,111414,4724.5294512,N,00937.0834677,E,1,21,3.679,3  
66.584,M*12
```

```
$GPGGQ,144054.00,111414,,,,,,10,,, *45
```

```
$GLGGQ,144054.00,111414,,,,,,07,,, *5F
```

```
$GBGGQ,144054.00,111414,,,,,,04,,, *51
```

For NMEA v4.1:

Standard Talker ID = GPS only

```
$GPGGQ,144339.00,111414,4724.5290715,N,00937.0833826,E,1,10,4.060,3  
66.339,M*03
```

Standard Talker ID = GNSS

```
$GNGGQ,144224.00,111414,4724.5293821,N,00937.0835717,E,1,22,3.673,3  
66.944,M*12
```

 When more than one GNSS is active only \$GNGGQ is output.

A.6

GLL - Geographic Position Latitude/Longitude

Syntax

```
$--GLL,IIII.II,a,yyyyy.yy,a,hhmmss.ss,A,a*hh<CR><LF>
```

Description of fields

Field	Description
\$--GLL	Header including talker ID
IIII.II	Latitude (WGS 1984)
a	Hemisphere, N orth or S outh
yyyyy.yy	Longitude (WGS 1984)
a	E ast or W est
hhmmss.ss	UTC time of position
A	Status A = Data valid V = Data not valid
a	Mode indicator A = Autonomous mode D = Differential mode N = Data not valid
*hh	Checksum
<CR>	C arriage R eturn
<LF>	L ine F eed



The Mode indicator field supplements the Status field. The Status field is set to A for the Mode indicators A and D. The Status field is set to V for the Mode indicator N.

Examples

For NMEA v4.0 and v4.1:

Standard Talker ID = GPS only

```
$GPGLL,4724.5289712,N,00937.0834834,E,144659.00,A,A*68
```

Standard Talker ID = GNSS

```
$GNGLL,4724.5294325,N,00937.0836915,E,144839.00,A,A*72
```

A.7

GNS - GNSS Fix Data

Syntax

```
$--GNS,hhmmss.ss,lll.ll,a,yyyyy.yy,a,c--c,xx,x.x,x.x,x.x,x.x,xxxx,h*hh<CR><LF>
```

Description of fields

Field	Description
\$--GNS	Header including talker ID
hhmmss.ss	UTC time of position
lll.ll	Latitude (WGS 1984)
a	Hemisphere, N orth or S outh
yyyyy.yy	Longitude (WGS 1984)
a	E ast or W est
c--c	Four character mode indicator for each GNSS constellation used in the position where the <ul style="list-style-type: none"> • First character is for GPS • Second character is for GLONASS • Third character is for Galileo • Fourth character is for BeiDou <p>N = Satellite system not used in position fix or fix not valid P = Precise, for example no deliberate degradation such as SA A = Autonomous; navigation fix, no real-time fix D = Differential; real-time position, ambiguities not fixed R = Real-time kinematic; ambiguities fixed F = Float real-time kinematic</p>
xx	Number of satellites in use. For \$GNNGGA messages: The combined GPS, GLONASS, Galileo and BeiDou satellites used in the position.
x.x	HDOP
x.x	Altitude of position marker above/below mean sea level in metres. If no orthometric height is available the local ellipsoidal height is exported. If the local ellipsoidal height is not available either, the WGS 1984 ellipsoidal height is exported.
x.x	Geoidal separation in metres
x.x	Age of differential data

Field	Description
xxxx	Differential base station ID, 0000 to 1023
h	For NMEA v4.1. Navigation Status Indicator S = Safe C = Caution U = Unstable V = Navigation status not valid
*hh	Checksum
<CR>	Carriage Return
<LF>	Line Feed

Examples

For NMEA v4.0:

Standard Talker ID = GPS only

```
$GPGNS,150254.00,4724.5290110,N,00937.0837286,E,A,10,0.8,366.282,100.143,,*33GNSS
```

Standard Talker ID = GNSS

```
$GNGNS,145309.00,4724.5293077,N,00937.0838953,E,AANA,22,0.5,367.326,100.144,,*64
```

 When more than one GNSS is active only \$GNGNS is output.

For NMEA v4.1:

Standard Talker ID = GPS only

```
$GPGNS,150219.00,4724.5290237,N,00937.0837225,E,A,10,0.8,366.329,100.143,,,V*4FGNSS
```

Standard Talker ID = GNSS

```
$GNGNS,145339.00,4724.5292786,N,00937.0838968,E,AANA,22,0.5,367.334,100.143,,,V*19
```

 When more than one GNSS is active only \$GNGNS is output.

A.8

GSA - GNSS DOP and Active Satellites

Syntax

```
$--GSA,a,x,xx,xx,xx,xx,xx,xx,xx,xx,xx,xx,x,x,x,x,h*hh<CR><LF>
```

Description of fields

Field	Description
\$--GSA	Header including talker ID
a	Mode M = Manual, forced to operate in 2D or 3D mode A = Automatic, allowed to change automatically between 2D and 3D
x	Mode 1 = Fix not available 2 = 2D

Field	Description																																				
	3 = 3D																																				
xx	<p>PRN numbers of the satellites used in the solution.</p> <p>For NMEA v4.0: This field is repeated 12 times.</p> <p>For NMEA v4.1: This field is repeated 16 times.</p> <p> A new GSA message is sent for each GNSS constellation tracked.</p> <p>For NMEA v4.0 and v4.1:</p> <table> <tr> <td>GPS</td> <td>1 to 32</td> <td>GPS satellites</td> </tr> <tr> <td></td> <td>33 to 64</td> <td>SBAS satellites</td> </tr> <tr> <td></td> <td>65 to 99</td> <td>Undefined</td> </tr> <tr> <td>GLONASS</td> <td>1 to 32</td> <td>Undefined</td> </tr> <tr> <td></td> <td>33 to 64</td> <td>SBAS satellites</td> </tr> <tr> <td></td> <td>65 to 99</td> <td>GLONASS satellites</td> </tr> </table> <p>For NMEA v4.1 also:</p> <table> <tr> <td>Galileo</td> <td>1 to 36</td> <td>Galileo satellites</td> </tr> <tr> <td></td> <td>37 to 64</td> <td>Galileo SBAS</td> </tr> <tr> <td></td> <td>65 to 99</td> <td>Undefined</td> </tr> <tr> <td>BeiDou</td> <td>1 to 37</td> <td>BeiDou satellites</td> </tr> <tr> <td></td> <td>38 to 64</td> <td>BeiDou SBAS</td> </tr> <tr> <td></td> <td>65 to 99</td> <td>Undefined</td> </tr> </table>	GPS	1 to 32	GPS satellites		33 to 64	SBAS satellites		65 to 99	Undefined	GLONASS	1 to 32	Undefined		33 to 64	SBAS satellites		65 to 99	GLONASS satellites	Galileo	1 to 36	Galileo satellites		37 to 64	Galileo SBAS		65 to 99	Undefined	BeiDou	1 to 37	BeiDou satellites		38 to 64	BeiDou SBAS		65 to 99	Undefined
GPS	1 to 32	GPS satellites																																			
	33 to 64	SBAS satellites																																			
	65 to 99	Undefined																																			
GLONASS	1 to 32	Undefined																																			
	33 to 64	SBAS satellites																																			
	65 to 99	GLONASS satellites																																			
Galileo	1 to 36	Galileo satellites																																			
	37 to 64	Galileo SBAS																																			
	65 to 99	Undefined																																			
BeiDou	1 to 37	BeiDou satellites																																			
	38 to 64	BeiDou SBAS																																			
	65 to 99	Undefined																																			
x.x	PDOP																																				
x.x	HDOP																																				
x.x	VDOP																																				
h	<p>For NMEA v4.1. GNSS System ID</p> <p>1 = GPS</p> <p>2 = GLONASS</p> <p>3 = Galileo</p> <p>4 = BeiDou</p>																																				
*hh	Checksum																																				
<CR>	Carriage Return																																				
<LF>	Line Feed																																				

Examples

For NMEA v4.0:

Standard Talker ID = GPS only

```
$GPGSA,A,3,01,04,06,09,11,17,20,23,31,,,,,1.5,0.8,1.3*31
```

Standard Talker ID = GNSS

```
$GNGSA,A,3,01,04,06,09,11,17,20,23,31,,,,,1.1,0.5,1.0*25
```

```
$GNGSA,A,3,65,71,72,73,74,80,86,87,88,,,,,1.1,0.5,1.0*26
```

For NMEA v4.1:

Standard Talker ID = GPS only

\$GPGSA,A,3,01,04,06,09,11,17,20,23,31,,,,,,,,,1.5,0.8,1.3,1*2C

Standard Talker ID = GNSS

\$GNGSA,A,3,01,04,06,09,11,17,20,23,31,,,,,,,,,1.1,0.5,1.0,1*38

\$GNGSA,A,3,65,71,72,73,74,80,86,87,88,,,,,,,,,1.1,0.5,1.0,2*38

\$GNGSA,A,3,05,07,10,11,,,,,,,,,,,,,1.1,0.5,1.0,4*33

A.9

GSV - GNSS Satellites in View

Syntax

\$--GSV,x,x,xx,xx,xx,xxx,xx,.....,h*hh<CR><LF>

Description of fields

Field	Description																																				
\$--GSV	Header including talker ID																																				
x	Total number of messages, 1 to 9																																				
x	Message number, 1 to 9																																				
xx	Number of theoretically visible satellites according to the current almanac.																																				
xx	PRN numbers of the satellites used in the solution.																																				
	<table border="0"> <tr> <td>GPS</td> <td>1 to 32</td> <td>GPS satellites</td> </tr> <tr> <td></td> <td>33 to 64</td> <td>SBAS satellites</td> </tr> <tr> <td></td> <td>65 to 99</td> <td>Undefined</td> </tr> <tr> <td>GLONASS</td> <td>1 to 32</td> <td>Undefined</td> </tr> <tr> <td></td> <td>33 to 64</td> <td>SBAS satellites</td> </tr> <tr> <td></td> <td>65 to 99</td> <td>GLONASS satellites</td> </tr> <tr> <td>Galileo</td> <td>1 to 36</td> <td>Galileo satellites</td> </tr> <tr> <td></td> <td>37 to 64</td> <td>Galileo SBAS</td> </tr> <tr> <td></td> <td>65 to 99</td> <td>Undefined</td> </tr> <tr> <td>BeiDou</td> <td>1 to 37</td> <td>BeiDou satellites</td> </tr> <tr> <td></td> <td>38 to 64</td> <td>BeiDou SBAS</td> </tr> <tr> <td></td> <td>65 to 99</td> <td>Undefined</td> </tr> </table>	GPS	1 to 32	GPS satellites		33 to 64	SBAS satellites		65 to 99	Undefined	GLONASS	1 to 32	Undefined		33 to 64	SBAS satellites		65 to 99	GLONASS satellites	Galileo	1 to 36	Galileo satellites		37 to 64	Galileo SBAS		65 to 99	Undefined	BeiDou	1 to 37	BeiDou satellites		38 to 64	BeiDou SBAS		65 to 99	Undefined
GPS	1 to 32	GPS satellites																																			
	33 to 64	SBAS satellites																																			
	65 to 99	Undefined																																			
GLONASS	1 to 32	Undefined																																			
	33 to 64	SBAS satellites																																			
	65 to 99	GLONASS satellites																																			
Galileo	1 to 36	Galileo satellites																																			
	37 to 64	Galileo SBAS																																			
	65 to 99	Undefined																																			
BeiDou	1 to 37	BeiDou satellites																																			
	38 to 64	BeiDou SBAS																																			
	65 to 99	Undefined																																			
xx	Elevation in degrees, 90 maximum, empty when not tracking																																				
xxx	Azimuth in degrees true north, 000 to 359, empty when not tracking																																				
xx	Signal to Noise Ration C/No in dB, 00 to 99 of L1 signal, null field when not tracking.																																				
...	Repeat set PRN / Slot number, elevation, azimuth and SNR up to four times																																				
h	For NMEA v4.1. Signal ID																																				
	<table border="0"> <tr> <td>GPS</td> <td>0</td> <td>All signals</td> </tr> <tr> <td></td> <td>1</td> <td>L1 C/A</td> </tr> <tr> <td></td> <td>2</td> <td>L1 P(Y)</td> </tr> </table>	GPS	0	All signals		1	L1 C/A		2	L1 P(Y)																											
GPS	0	All signals																																			
	1	L1 C/A																																			
	2	L1 P(Y)																																			

Field	Description
	3 L1M
	4 L2 P(Y)
	5 L2C-M
	6 L2C-L
	7 L5-I
	8 L5-Q
	9-F Reserved
	GLONASS 0 All signals
	1 G1 C/A
	2 G1 P
	3 G2 C/A
	4 GLONASS (M) G2 P
	5-F Reserved
	Galileo 0 All signals
	1 E5a
	2 E5b
	3 E5a+b
	4 E6-A
	5 E6-BC
	6 L1-A
	7 L1-BC
	8-F Reserved
	BeiDou 0 All signals
	1-F Reserved
*hh	Checksum
<CR>	Carriage Return
<LF>	Line Feed



Satellite information can require the transmission of multiple messages, specified by the total number of messages and the message number.



The fields for the PRN / Slot number, Elevation, Azimuth and SNR form one set. A variable number of these sets are allowed up to a maximum of four sets per message.

Examples

For NMEA v4.0:

Standard Talker ID = GPS only

```
$GPGSV,3,1,09,01,31,151,45,06,37,307,47,09,47,222,49,10,14,279,44*7D
```

```
$GPGSV,3,2,09,17,29,246,47,20,69,081,49,23,79,188,51,31,18,040,41*76
```

```
$GPGSV,3,3,09,32,23,087,42,,,,,,,,,,,,,*49
```

Standard Talker ID = GNSS

```
$GPGSV,3,1,09,01,34,150,47,06,34,308,47,09,44,220,48,10,11,277,43*7B
$GPGSV,3,2,09,17,31,248,49,20,71,076,48,23,76,192,50,31,19,042,42*7A
$GPGSV,3,3,09,32,25,085,40,,,,,,,,,,,,*4F
$GLGSV,3,1,09,65,24,271,45,71,37,059,47,72,67,329,49,73,31,074,45*66
$GLGSV,3,2,09,74,17,127,44,80,15,022,41,86,12,190,44,87,49,239,48*66
$GLGSV,3,3,09,88,38,314,46,,,,,,,,,,,,*53
$GBGSV,1,1,04,05,18,123,38,07,23,044,39,10,35,068,45,11,29,224,45*61
```

For NMEA v4.1:

Standard Talker ID = GPS only

```
$GPGSV,3,1,09,01,31,151,46,06,36,307,47,09,46,222,49,10,13,278,44,0*64
$GPGSV,3,2,09,17,29,246,48,20,69,080,49,23,79,189,51,31,18,040,42,0*66
$GPGSV,3,3,09,32,23,087,42,,,,,,,,,,,,0*55
```

Standard Talker ID = GNSS

```
$GPGSV,3,1,09,01,32,151,46,06,35,308,47,09,45,221,49,10,12,278,42,0*6C
$GPGSV,3,2,09,17,30,247,47,20,70,078,49,23,77,191,51,31,19,041,41,0*6B
$GPGSV,3,3,09,32,24,086,41,,,,,,,,,,,,0*50
$GLGSV,3,1,09,65,25,272,46,71,36,060,47,72,68,333,49,73,31,073,45,0*73
$GLGSV,3,2,09,74,18,126,47,80,15,021,38,86,11,190,45,87,48,238,50,0*71
$GLGSV,3,3,09,88,38,312,46,,,,,,,,,,,,0*49
$GBGSV,1,1,04,05,18,123,38,07,23,044,40,10,35,067,45,11,28,224,46,0*7E
```

A.10

GST - Position Error Statistics

Syntax

```
$--GST,hhmmss.ss,x.xxx,x.xxx,x.xxx,xxx.x,x.xxx,x.xxx,x.xxx*hh
```

Description of fields

Field	Description
\$--GST	Message ID; varies depending on the satellite system used for the position solution: <ul style="list-style-type: none">• \$GPGST: GPS only• \$GLGST: GLONASS only• \$GN: Combined
hhmmss.ss	UTC of position fix
x.xxx	RMS value of the pseudo-range residuals; includes carrier phase residuals during periods of RTK (float) and RTK (fixed) processing
x.xxx	Error ellipse semi-major axis 1 sigma error, in meters
x.xxx	Error ellipse semi-minor axis 1 sigma error, in meters
xxx.x	Error ellipse orientation, degrees from true north
x.xxx	Latitude 1 sigma error, in meters
x.xxx	Longitude 1 sigma error, in meters
x.xxx	Height 1 sigma error, in meters

Field	Description
*hh	Checksum; data always begins with *

Example

\$GPGST,172814.0,0.006,0.023,0.020,273.6,0.023,0.020,0.031*6A

A.11

HDT - Heading, True

Syntax

\$--HDT,x.x,T*hh<CR><LF>

Description of fields

Field	Description
\$--HDT	Header including talker ID
x.x	Heading, degrees True
T	Fixed text T for true north
*hh	Checksum
<CR>	Carriage Return
<LF>	Line Feed

Examples

Standard Talker ID

\$GNHDT,11.4,T,00*4B

A.12

LLK - Leica Local Position and GDOP

Syntax

\$--LLK,hhmmss.ss,mmddy,eeeeee.eee,M,nnnnn.nnn,M,x,xx,x.x,x.x,M*hh<CR><LF>

Description of fields

Field	Description
\$--LLK	Header including talker ID
hhmmss.ss	UTC time of position
mmddy	UTC date
eeeeee.eee	Grid Easting in metres
M	Units of grid Easting as fixed text M
nnnnn.nnn	Grid Northing in metres
M	Units of grid Northing as fixed text M
x	Position quality 0 = Fix not available or invalid 1 = No real-time position, navigation fix 2 = Real-time position, ambiguities not fixed 3 = Real-time position, ambiguities fixed 5 = Real-time position, float
xx	Number of satellites in use. For \$GNLLK messages: The combined GPS, GLONASS, Galileo and BeiDou satellites used in the position.
x.x	GDOP

Field	Description
x.x	Altitude of position marker above/below mean sea level in metres. If no orthometric height is available the local ellipsoidal height will be exported.
M	Units of altitude as fixed text M
*hh	Checksum
<CR>	Carriage Return
<LF>	Line Feed

Examples

For NMEA v4.0:

Standard Talker ID = GPS only

```
$GPLLK,153254.00,111414,546628.909,M,5250781.888,M,1,09,1.8,366.582,M*15
```

Standard Talker ID = GNSS

```
$GNLLK,153819.00,111414,546629.154,M,5250782.866,M,1,20,1.3,367.427,M*05
```

```
$GPLLK,153819.00,111414,,,,,09,,,*50
```

```
$GLLLK,153819.00,111414,,,,,07,,,*42
```

```
$GBLLK,153819.00,111414,,,,,04,,,*4C
```

For NMEA v4.1:

Standard Talker ID = GPS only

```
$GPLLK,153254.00,111414,546628.909,M,5250781.888,M,1,09,1.8,366.582,M*15
```

Standard Talker ID = GNSS

```
$GNLLK,153504.00,111414,546629.055,M,5250782.977,M,1,20,1.3,367.607,M*05
```

 When more than one GNSS is active only \$GNLLK is output.

A.13

LLQ - Leica Local Position and Quality

Syntax

```
$--LLQ,hhmmss.ss,mmddy,eeeeee.eee,M,nnnnn.nnn,M,x,xx,x.x,x.x,M*hh<CR><LF>
```

Description of fields

Field	Description
\$--LLQ	Header including talker ID
hhmmss.ss	UTC time of position
mmddy	UTC date
eeeeee.eee	Grid Easting in metres
M	Units of grid Easting as fixed text M
nnnnn.nnn	Grid Northing in metres
M	Units of grid Northing as fixed text M

Field	Description
x	Position quality 0 = Fix not available or invalid 1 = No real-time position, navigation fix 2 = Real-time position, ambiguities not fixed 3 = Real-time position, ambiguities fixed 5 = Real-time position, float
xx	Number of satellites in use. For \$GNLLQ messages: The combined GPS, GLONASS, Galileo and BeiDou satellites used in the position.
x.x	Coordinate quality in metres
x.x	Altitude of position marker above/below mean sea level in metres. If no orthometric height is available the local ellipsoidal height will be exported.
M	Units of altitude as fixed text M
*hh	Checksum
<CR>	Carriage Return
<LF>	Line Feed

Examples

For NMEA v4.0:

Standard Talker ID = GPS only

```
$GPRLLQ,154324.00,111414,546629.232,M,5250781.577,M,1,09,3.876,366.549,M*05
```

Standard Talker ID = GNSS

```
$GNLLQ,154119.00,111414,546629.181,M,5250782.747,M,1,20,3.890,367.393,M*1D
```

```
$GPRLLQ,154119.00,111414,,,,,09,,, *44
```

```
$GLLLQ,154119.00,111414,,,,,07,,, *56
```

```
$GBLLQ,154119.00,111414,,,,,04,,, *58
```

For NMEA v4.1:

Standard Talker ID = GPS only

```
$GPRLLQ,154324.00,111414,546629.232,M,5250781.577,M,1,09,3.876,366.549,M*05
```

Standard Talker ID = GNSS

```
$GNLLQ,154149.00,111414,546629.191,M,5250782.727,M,1,20,3.880,367.387,M*1B
```



When more than one GNSS is active only \$GNLLQ is output.

A.14

RMC - Recommended Minimum Specific GNSS Data

Syntax

```
$--RMC,hhmmss.ss,A,llll.ll,a,yyyyy.yy,a,x.x,x.x,xxxxx,x.x,a,a*hh<CR><LF>
```

Description of fields

Field	Description
\$--RMC	Header including talker ID
hhmmss.ss	UTC time of position fix
A	Status A = Data valid V = Navigation instrument warning
llll.ll	Latitude (WGS 1984)
a	Hemisphere, North or South
yyyyy.yy	Longitude (WGS 1984)
a	East or West
x.x	Speed over ground in knots
x.x	Course over ground in degrees
xxxxxx	Date: ddmmyy
x.x	Magnetic variation in degrees
a	East or West
*hh	Mode Indicator A = Autonomous mode D = Differential mode N = Data not valid
<CR>	Carriage Return
<LF>	Line Feed

Examples**For NMEA v4.0 and v4.1:****Standard Talker ID = GPS only and GNSS**

```
$GNRMC,154706.00,A,4724.5288205,N,00937.0842621,E,0.01,144.09,141114,0.00,E,A*10
```

A.15**VTG - Course Over Ground and Ground Speed****Syntax**

```
$--VTG,x.x,T,x.x,M,x.x,N,x.x,K,a*hh<CR><LF>
```

Description of fields

Field	Description
\$--VTG	Header including talker ID
x.x	Course over ground in degrees true north, 0.0 to 359.9
T	Fixed text T for true north
x.x	Course over ground in degrees magnetic North, 0.0 to 359.9
M	Fixed text M for magnetic North
x.x	Speed over ground in knots
N	Fixed text N for knots
x.x	Speed over ground in km/h
K	Fixed text K for km/h
a	Mode Indicator

Field	Description
	A = Autonomous mode D = Differential mode N = Data not valid
*hh	Checksum
<CR>	Carriage Return
<LF>	Line Feed

Examples

For NMEA v4.0 and v4.1:

Standard Talker ID = GPS only

\$GPVTG,152.3924,T,152.3924,M,0.018,N,0.034,K,A*2D

Standard Talker ID = GNSS

\$GNVTG,188.6002,T,188.6002,M,0.009,N,0.016,K,A*33

A.16

ZDA - Time and Date

Syntax

\$--ZDA,hhmmss.ss,xx,xx,xxxx,xx,xx*hh<CR><LF>

Description of fields

Field	Description
\$--ZDA	Header including talker ID
hhmmss.ss	UTC time
xx	UTC day, 01 to 31
xx	UTC month, 01 to 12
xxxx	UTC year
xx	Local zone description in hours, 00 to ±13
xx	Local zone description in minutes, 00 to +59
*hh	Checksum
<CR>	Carriage Return
<LF>	Line Feed



This message is given high priority and is output as soon as it is created. Latency is therefore reduced to a minimum.

Examples

For NMEA v4.0 and v4.1:

Standard Talker ID = GPS only and GNSS

\$GPZDA,155404.05,14,11,2014,01,00*61

A.17

PJK - Local Coordinate Position Output

Syntax

\$PTNL,PJK,hhmmss.ss,mmddy,nnnnnn.nnn,N,eeeeee. ee,E,xx,xx,x.x,-HTxx.xxx,M*hh



The PTNL,PJK message is longer than the NMEA-0183 standard of 80 characters.

Description of fields

Field	Description
\$PTNL,PJK	Message ID \$PTNL,PJK
hhmmss.ss	UTC of position fix
mmddy	Date
nnnnnn.nnn	Northing, in metres
N	Direction of Northing is always N (North)
eeeeee.ee	Easting, in metres
E	Direction of Easting is always E (East)
xx	GPS quality indicator 0 = Fix not available or invalid 1 = Autonomous GPS fix 2 = RTK float solution 3 = RTK fix solution 4 = Differential, code phase only solution (DGPS) 5 = SBAS solution 6 = RTK Float 3D network solution 7 = RTK Fixed 3D network solution 8 = RTK Float 2D network solution 9 = RTK Fixed 2D network solution 10 = OmniSTAR HP/XP solution 11 = OminSTAR VBS solution 12 = Location RTK 13 = Beacon DGPS
xx	Number of satellites in fix
x.x	DOP of fix
-HTxx.xxx	Height of Antenna Phase Center GHT: If a user-defined geoid model or an inclined plane is loaded into the receiver, the NMEA PJK string always reports the orthometric height EHT: If the latitude/longitude of the receiver is outside the user-defined geoid model bounds, the height is shown as ellipsoidal height
M	M = height is measured in metres
*hh	Checksum; data always begins with *



If the receiver does not have a coordinate system loaded, this string returns nothing in fields **nnnnnn.nn,N,eeeeee.ee,E** and **-HTxx.xxx**.

Examples

- \$PTNL,PJK,202831.50,011112,+805083.350,N,+388997.346,E,10,09,1.5,GHT+25.478,M*77
- \$PTNL,PJK,010717.00,081796,+732646.511,N,+1731051.091,E,1,05,2.7,EHT+28.345,M*7C

Appendix B

ORP – Orientation and Position

Description

This proprietary Leica message provides the current Position and Quality in either Geodetic or Grid coordinates for one or two antennas plus the resulting orientation.



Information regarding the second antenna is not applicable for the iCON gps 160 SmartAntenna.

Access

Select **Settings > Tools > NMEA Output**. Toggle to **Edit** for **NMEA Out 1** or **NMEA Out 2**. ORP is available on the second page of the wizard

Description of fields

Message type	Format	Description
RESPONSE:	\$PLEIR,	Header, message sent from instrument
Position and Quality	ORP,	Message Identifier
	xxxx,	ControlType ¹
	x,	Coordinate System ²
	The following block is available if Control Type = 1 or = 2 (Single or Dual GNSS)	
	x,	Position Status Flag - 1st Antenna ³
	If Position Status Flag - 1st Antenna != "0" (not computed yet) and != 4 (not used)	
	hhmmss.ss,	UTC time
	ddmmyy,	UTC date
	xx,	Latency ⁴ [milliseconds]
	xx.xx,	Quality Latitude/Northing [metres]
	xx.xx,	Quality Longitude/Easting [metres]
	xx.xx,	Quality Height [metres]
	xx.xx,	GDOP – Value for first Antenna
	x,	Number of Satellites used in Computation (GPS)
	x,	Number of Satellites used in Computation (GG)
If Coordinate System = 0 (Geodetic) the following block is present:		
lll.ll,	Latitude (+: North -: South)	
yyyyy.yy,	Longitude (+: East -: West)	
xxxx.xxxx,	Altitude of position marker ⁵ [metres]	
If Coordinate System = 1 (Grid) the following block is present:		
xxxx.xxxx,	Grid Northing [metres]	
xxxx.xxxx,	Grid Easting [metres]	
xxxx.xxxx,	Altitude of position marker [metres]	
x,	Height type ⁶	

Message type	Format	Description
		The following block is only available if Control Type = 2 (Dual GNSS)
	x,	Position Status Flag - 2nd antenna ³
		If Position Status Flag - 2nd Antenna != "0" (not computed yet) and != 4 (not used)
	hhmmss.ss,	UTC time
	ddmmyy,	UTC date
	xx,	Latency ⁴ [milliseconds]
	xx.xx,	Quality Latitude/Northing [metres]
	xx.xx,	Quality Longitude/Easting [metres]
	xx.xx,	Quality Height [metres]
		If Coordinate System = 0 (Geodetic) the following block is present:
	llll.ll,	Latitude (+: North -: South)
	yyyyy.yy,	Longitude (+: East -: West)
	xxxx.xxxx,	Altitude of position marker ⁵ [metres]
		If Coordinate System = 1 (Grid) the following block is present:
	xxxx.xxxx,	Grid Northing [metres]
	xxxx.xxxx,	Grid Easting [metres]
	xxxx.xxxx,	Altitude of position marker [metres]
	x,	Height type ⁶
		The following block is only available if Control Type = 3
	hhmmss.ss,	UTC time
	ddmmyy,	UTC date
	xx,	Latency ⁴ [milliseconds]
	xxxx.xxxx,	Orientation Angle ⁷ [degrees], 0.0° to 359.9°
	xx.xx,	Quality of calculated Orientation [degrees]
	*hh	Checksum
	<CR>	Carriage Return
	<LF>	Line Feed

1 Control Type

- 1: Antenna1 Position Information
- 2: Antenna1 and Antenna2 Information
- 3: Antenna1 and Antenna2 Information + Orientation

2 Coordinate System

- 0: WGS Geodetic
- 1: Local Grid

3 Position Status

- 0: Computed Position not yet available
- 1: Differential code Position
- 2: Differential phase Position
- 3: Non-differential Position
- 4: xRTK

4 Latency given is defined as the difference in time between the UTC of the measurements used in the computation and the UTC of the first Message byte sent out the instrument port.

5 Ellipsoidal height is forced for Geodetic coordinates.
Orthometric height is forced for Grid coordinates.

6 Height

- 0: Ellipsoidal height
- 1: Orthometric height

7 Orientation is available for Local Grid and WGS84.

Example

\$PLEIR,ORP,3,1,2,084709.25,310713,50,0.006,0.005,0.016,1.847,5,7,525078
1.241,546672.161,371.528,1,254,084709.25,310713,100,0.005,0.004,0.012,
5250781.277,546671.390,371.497,1,084709.25,310713,100,272.683,0.592*
23

C.1

C

Coordinate system - elements

The five elements which define a coordinate system are:

- a transformation
- a projection
- an ellipsoid
- a geoid model
- a **C**ountry **S**pecific **C**oordinate **S**ystem model

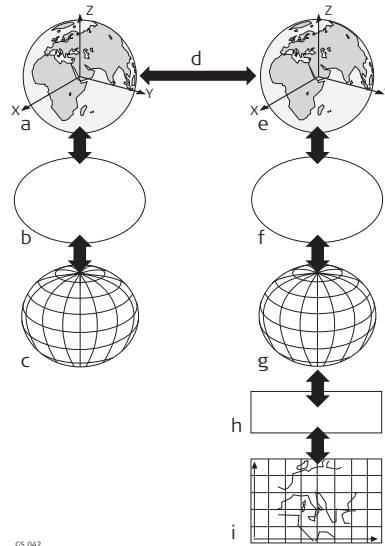

- a WGS 1984 cartesian: X, Y, Z
- b WGS 1984 ellipsoid
- c WGS 1984 geodetic: Latitude, longitude, ellipsoidal height
- d 7 parameter transformation: dX, dY, dZ, rx, ry, rz, scale
- e Local cartesian: X, Y, Z
- f Local ellipsoid
- g Local geodetic: Latitude, longitude, ellipsoidal height
- h Local projection
- i Local grid: Easting, Northing, orthometric height

All these elements can be specified when creating a coordinate system.

CSCS model (*.ccg)

Description

Country Specific Coordinate System models

- are tables of correction values to convert coordinates directly from WGS 1984 to local grid without the need of transformation parameters.
- take the distortions of the mapping system into account.
- are an addition to an already defined coordinate system.

Types of CSCS models

The correction values of a CSCS model can be applied at different stages in the coordinate conversion process. Depending on this stage, a CSCS model works differently. Three types of CSCS models are supported. Their conversion

process is as explained in the following table. Any suitable geoid model can be combined with a geodetic CSCS model.

Type	Description
Grid	1 Determination of preliminary grid coordinates by applying the specified transformation, ellipsoid and map projection.
	2 Determination of the final local grid coordinates by applying a shift in Easting and Northing interpolated in the grid file of the CSCS model.
Cartesian	1 Performing the specified transformation.
	2 Determination of local cartesian coordinates by applying a 3D shift interpolated in the grid file of the CSCS model.
	3 Determination of the final local grid coordinates by applying the specified local ellipsoid and map projection.
Geodetic	1 Determination of local geodetic coordinates by applying a correction in latitude and longitude interpolated from the file of the CSCS model.
	2 Determination of the final local grid coordinates by applying the local map projection.
	Using a geodetic CSCS model excludes the use of a transformation in a coordinate system.

C.2

Geoid model

G

Description

GPS operates on the WGS 1984 ellipsoid and all heights obtained by measuring baselines are ellipsoidal heights. Existing heights are usually orthometric heights, also called height above the geoid, height above mean sea level or levelled height. The mean sea level corresponds to a surface known as the geoid. The relation between ellipsoidal height and orthometric height is

Orthometric Height = Ellipsoidal Height - Geoid Separation N

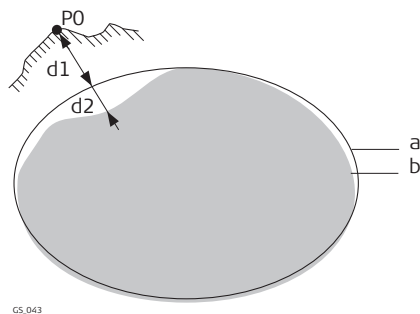

- a WGS 1984 ellipsoid
- b Geoid
- P0 Measured point
- d1 Ellipsoidal height
- d2 Geoid separation N, is negative when the geoid is below the ellipsoid

N value and geoid model

The geoid separation (N value) is the distance between the geoid and the reference ellipsoid. It can refer to the WGS 1984 or to the local ellipsoid. It is not a constant except over maybe small flat areas such as 5 km x 5 km.

Therefore it is necessary to model the N value to obtain accurate orthometric heights. The modelled N values form a geoid model for an area. With a geoid model attached to a coordinate system, N values for the measured points can be determined. Ellipsoidal heights can be converted to orthometric heights and back.

Geoid models are an approximation of the N value. In terms of accuracy, they can vary considerably and global models in particular should be used with caution. If the accuracy of the geoid model is not known, it can be safer to use local control points with orthometric heights and apply a transformation to approximate the local geoid.

Geoid field file

The geoid separations in a geoid field file can be used in the field to change between ellipsoidal and orthometric heights.

Creation:	Export onto a USB Memory device or the internal memory of the instrument.
Extension:	*.grd

C.3

N

Ntrip

Networked Transport of RTCM via Internet Protocol

- is a protocol streaming real-time corrections over the Internet.
- is a generic protocol based on the Hypertext Transfer Protocol HTTP/1.1.
- is used to send differential correction data or other kinds of streaming data to stationary or mobile users over the Internet. This process allows simultaneous computer, laptop, PDA, or instrument connections to a broadcasting host.
- supports wireless Internet access through mobile IP networks like digital cellular phones or modems.

The Ntrip Server could be the GPS instrument itself. This setup means the GPS instrument is both the Ntrip Source generating the real-time data and also the NTRIP Server transferring this data to the Ntrip Caster.

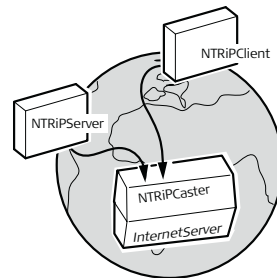

GS_044

Ntrip and its role in the Internet

Ntrip Caster

The Ntrip Caster

- is an Internet server handling various data streams to and from the Ntrip Servers and Ntrip Clients.
- checks the requests from Ntrip Clients and Ntrip Servers to see if they are registered to receive or provide real-time corrections.
- decides whether there is streaming data to be sent or to be received.

Ntrip Client

The Ntrip Client receives data streams. This setup could be, for example a real-time rover receiving real-time corrections.

In order to receive real-time corrections, the Ntrip Client must first send

- a user ID
- a password
- an identification name, the so-called Mountpoint, from which real-time corrections are to be received

to the Ntrip Caster.

Ntrip Server

The Ntrip Server transfers data streams.

In order to send real-time corrections, the Ntrip Server must first send

- a password
- an identification name, the so-called Mountpoint, where the real-time corrections come from

to the Ntrip Caster.

Before sending real-time corrections to the Ntrip Caster for the first time, a registration form must be completed. This form is available from the Ntrip Caster administration centre. Refer to the website of the Ntrip Caster administration centre.

Ntrip Source

The Ntrip Source generates data streams. This setup could be base sending out real-time corrections.

Ntrip system components

Ntrip consists of three system components:

- Ntrip Clients
- Ntrip Servers
- Ntrip Caster

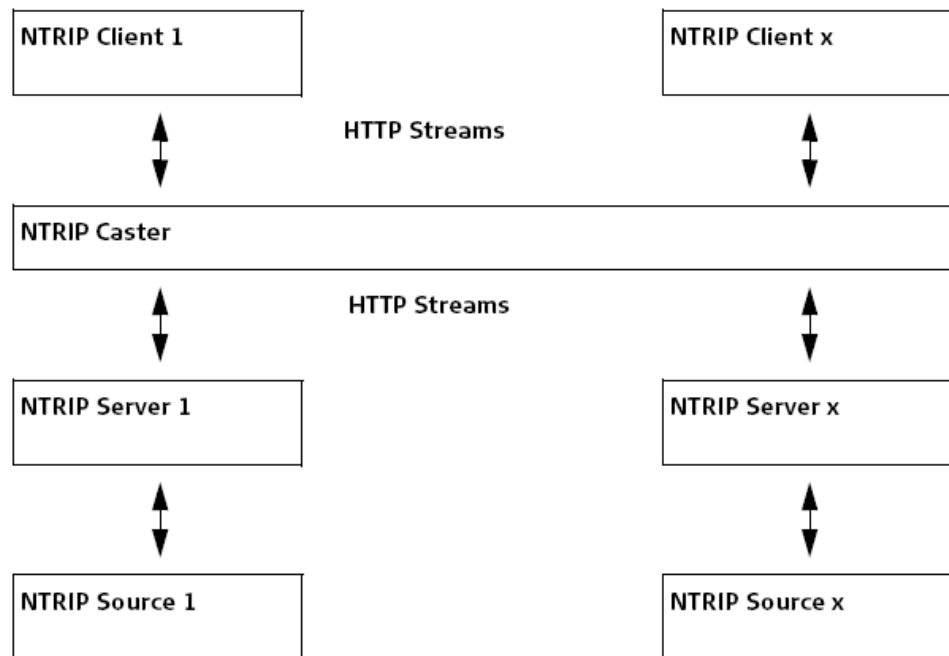

C.4

W

WGS 1984

WGS 1984 is the global geocentric datum to which all GNSS positioning information is referred to.



970438-1.1.0en

Original text (970438-1.1.0en)

Published in Switzerland, © 2023 Leica Geosystems AG



- when it has to be **right**



Leica Geosystems AG

Heinrich-Wild-Strasse
9435 Heerbrugg
Switzerland

www.leica-geosystems.com

