

Leica GR30/GM30/GR50



User Manual
Version 3.1
English

- when it has to be **right**

Leica
Geosystems

PART OF
HEXAGON

Introduction

Purchase

Congratulations on the purchase of the Leica GR30/GM30/GR50.

Product identification

The model and serial number of your product are indicated on the type label. Always refer to this information when contacting your agency or Leica Geosystems authorised service centre.



This manual contains important safety directions as well as instructions for setting up the product and operating it. Refer to [1 Safety Directions](#) for further information.

Read carefully through the User Manual before you switch on the product.



The content of this document is subject to change without prior notice. Ensure that the product is used in accordance with the latest version of this document.

Updated versions are available for download at the following Internet address: <https://myworld-portal.leica-geosystems.com/> > myDownloads

Trademarks



- Windows® is a registered trademark of Microsoft Corporation in the United States and other countries
- SD Logo is a trademark of SD-3C, LLC.
- *Bluetooth*® is a registered trademark of Bluetooth SIG, Inc.



All other trademarks are the property of their respective owners.

Validity of this manual

This manual applies to the GR30/GM30/GR50.

Available documentation

Name	Description/Format		
GR30/GM30/GR50 Quick Guide	Provides an overview of the product together with technical data and safety directions. Intended as a quick reference guide.	✓	✓
GR30/GM30/GR50 User Manual	All instructions required in order to operate the product to a basic level are contained in the User Manual. Provides an overview of the product together with technical data and safety directions.	-	✓
GR/GM Series Operational Manual (Online Help)	Comprehensive guide to the product and the operation. Includes a description of the hardware installation and common accessories. Software setup is described in detail, along with the technical specifications. The complete manual can be viewed online via the GR/GM series web interface.	-	✓
GNSS Reference Station and Networks - An Introductory Guide	Offers practical advice on how to set up and run individual GNSS reference stations and networks of stations and to provide the services that are required.	✓	✓

Name	Description/Format		
GNSS Networks and Reference Stations Equipment List	Detailed list of equipment available for GNSS reference stations including hardware and software.	-	✓
Monitoring Equipment List	Detailed list of equipment available for monitoring sites including hardware and software.	-	✓

Refer to the following resources for documentation/software:

- the Leica USB documentation card
- <https://myworld-portal.leica-geosystems.com/>



<https://myworld-portal.leica-geosystems.com/> offers a wide range of services, information and training material.

With direct access to myWorld, you are able to access all relevant services whenever it is convenient for you.

The availability of services depends on the instrument model.

Service	Description
My Products	Register all products that you and your company own and explore your world of Leica Geosystems: View detailed information on your products and update your products with the latest software and keep up-to-date with the latest documentation.
My Service	View the current service status and full service history of your products in Leica Geosystems service centres. Access detailed information on the services performed and download your latest calibration certificates and service reports.
My Support	Create new support requests for your products that will be answered by your local Leica Geosystems support team. View your complete support history and view detailed information on all your support requests.
My Knowledge	Enter key words and start searching in our knowledge base. You can find FAQs (Frequently asked questions) as well as Knowledge articles for Leica Geosystems products.
My Downloads	Downloads of software, manuals, tools, training material and news for Leica Geosystems products. Download the latest documentation and software to keep yourself and your products up-to-date. You can access downloads of software, manuals, tools, and training material.
Online Learning	Welcome to the home of Leica Geosystems online learning! There are numerous online courses – available to all customers with products that have valid CCPs (Customer Care Packages).

Service	Description
My SmartNet	Add and view your HxGN SmartNet subscriptions and user information. HxGN SmartNet delivers high-precision and high-availability GNSS network correction services in real-time and around the globe. The HxGN SmartNet Global family offers Network RTK with RTK bridging and Precise Point Positioning (PPP) services. These services work exclusively with Leica Geosystems GS smart antennas and receivers, providing the highest accuracy. Combined, they ensure HxGN SmartNet coverage everywhere.
My Trusted Services	Leica Geosystems Trusted Services offer you increased productivity while at the same time providing maximum security. New software services and state-of-the-art IT infrastructure offer a vast potential to optimise your workflow and increase your efficiency and productivity, both now and in the future.
My Security	Leica Geosystems Security delivers you total peace-of-mind in knowing that if your instrument is ever stolen, a locking mechanism is available to ensure that the instrument is disabled and can no longer be used.

Table of Contents

1	Safety Directions	7
1.1	General Introduction	7
1.2	Definition of Use	8
1.3	Limits of Use	8
1.4	Responsibilities	9
1.5	Hazards of Use	9
	1.5.1 General	9
	1.5.2 Additionally for the Power Supplies	13
	1.5.3 Additionally for the Car Battery	14
	1.5.4 Lightning Protection	15
1.6	Electromagnetic Compatibility (EMC)	19
2	Description of the System	22
2.1	General Information	22
2.2	GNSS Reference Station Components	24
2.3	Unpacking the Instrument	26
2.4	Instrument Components	26
2.5	Operation	27
2.6	Software	29
2.7	Power Supply	30
3	Installation	32
3.1	Before Installation	32
3.2	Installation Options	32
4	GR30/GM30 User Interface	35
4.1	LED Indicators on GR30/GM30	35
4.2	Keyboard	37
4.3	USB and SD Card Cover	39
5	GR50 User Interface	41
5.1	LED Indicators on GR50	41
5.2	Keyboard and Display	44
5.3	USB and SD Card Cover	45
6	Equipment Setup	46
6.1	Basic Setup	46
6.2	Set up by Web Interface Over Ethernet and DHCP	47
6.3	Set up in a Non-DHCP Network	48
6.4	Install USB drivers	50
	6.4.1 General	50
	6.4.2 Setup via Web Interface over USB	50
6.5	Setup via Web Interface over Bluetooth (GR50)	51
7	Operation	52
7.1	Using the Web Interface	52
7.2	Batteries	53
	7.2.1 Operating Principles	53
	7.2.2 Changing the Battery	54
	7.2.3 Using the GR50 Internal Battery and Charger	54
7.3	Working with the Memory Device	55
7.4	Working with Radio, Modem and GSM Devices	56
	7.4.1 General	56
	7.4.2 Serial Devices	56
	7.4.3 Slot-in Devices	59

8	Care and Transport	62
8.1	Transport	62
8.2	Storage	62
8.3	Cleaning and Drying	62
9	Technical Data	63
9.1	Labelling	63
9.2	GR30/GM30/GR50 Technical Data	67
	9.2.1 Tracking Characteristics	67
	9.2.2 Measurement Precision and Position Accuracy	68
	9.2.3 Technical Data	71
9.3	Environmental Specifications	76
9.4	Antennas Technical Data	76
9.5	Conformity to National Regulations	81
	9.5.1 For GR30, GM30 and GR50	81
	9.5.1.1 For GR50 only	81
	9.5.1.2 For GR30 and GM30 only	82
	9.5.2 GFU31, Cinterion LTE PLS63-W	83
	9.5.3 SLG31, Cinterion LTE PLS63-W	85
	9.5.4 Dangerous Goods Regulations	87
10	Software Licence Agreement/Warranty	88
Appendix A	Directory Structure of the Memory Device	89
Appendix B	Pin Assignments and Sockets	90
	B.1 GR30/GM30	90
	B.2 GR50	91

1 Safety Directions

1.1 General Introduction

Description

The following directions enable the person responsible for the product, and the person who actually uses the equipment, to anticipate and avoid operational hazards.

The person responsible for the product must ensure that all users understand these directions and adhere to them.

About warning messages





Warning messages are an essential part of the safety concept of the instrument. They appear wherever hazards or hazardous situations can occur.

Warning messages...

- make the user alert about direct and indirect hazards concerning the use of the product.
- contain general rules of behaviour.

For the users' safety, all safety instructions and safety messages shall be strictly observed and followed! Therefore, the manual must always be available to all persons performing any tasks described here.

DANGER, WARNING, CAUTION and **NOTICE** are standardised signal words for identifying levels of hazards and risks related to personal injury and property damage. For your safety, it is important to read and fully understand the following table with the different signal words and their definitions! Supplementary safety information symbols may be placed within a warning message as well as supplementary text.

Type	Description
 DANGER	Indicates an imminently hazardous situation which, if not avoided, will result in death or serious injury.
 WARNING	Indicates a potentially hazardous situation or an unintended use which, if not avoided, could result in death or serious injury.
 CAUTION	Indicates a potentially hazardous situation or an unintended use which, if not avoided, may result in minor or moderate injury.
NOTICE	Indicates a potentially hazardous situation or an unintended use which, if not avoided, may result in appreciable material, financial and environmental damage.
	Important paragraphs which must be adhered to in practice as they enable the product to be used in a technically correct and efficient manner.

Additional symbols



Warning against explosive material.



Warning against flammable substances.



Product must not be opened or modified or tampered with.



Indicates the temperature limits at which the product may be stored, transported or used.

1.2

Definition of Use

Intended use

- Carrying out measurement tasks using various GNSS measuring techniques.
- Recording GNSS and point related data.
- Data communication with external appliances.
- Measuring raw data and computing coordinates using carrier phase and code signal from GNSS satellites.

Reasonably foreseeable misuse

- Use of the product without instruction
- Use outside of the intended use and limits
- Disabling safety systems
- Removal of hazard notices
- Opening the product using tools, for example screwdriver, unless this is permitted for certain functions
- Modification or conversion of the product
- Use after misappropriation
- Use of products with recognisable damage or defects
- Use with accessories from other manufacturers without the prior explicit approval of Leica Geosystems
- Inadequate safeguards at the working site
- Controlling of machines, moving objects or similar monitoring application without additional control and safety installations

1.3

Limits of Use

Environment

Suitable for use in an atmosphere appropriate for permanent human habitation: not suitable for use in aggressive or explosive environments.

For the Power Supply:

Suitable for use in dry environments only and not under adverse conditions.



WARNING

Working in hazardous areas or close to electrical installations or similar situations

Life Risk.

Precautions:

- ▶ Local safety authorities and safety experts must be contacted by the person responsible for the product before working in such conditions.

1.4

Responsibilities

Manufacturer of the product

Leica Geosystems AG, CH-9435 Heerbrugg, hereinafter referred to as Leica Geosystems, is responsible for supplying the product, including the User Manual and original accessories, in a safe condition.

Person responsible for the product

The person responsible for the product has the following duties:

- To understand the safety instructions on the product and the instructions in the User Manual
- To ensure that the product is used in accordance with the instructions
- To be familiar with local regulations relating to safety and accident prevention
- To stop operating the system and inform Leica Geosystems immediately if the product and the application become unsafe
- To ensure that the national laws, regulations and conditions for the operation of the products are respected

1.5

Hazards of Use

1.5.1

General

NOTICE

Dropping, misusing, modifying, storing the product for long periods or transporting the product

Watch out for erroneous measurement results.

Precautions:

- ▶ Periodically carry out test measurements and perform the field adjustments indicated in the User Manual, particularly after the product has been subjected to abnormal use as well as before and after important measurements.

DANGER

Risk of electrocution

Because of the risk of electrocution, it is dangerous to use poles, levelling staffs and extensions in the vicinity of electrical installations such as power cables or electrical railways.

Precautions:

- ▶ Keep at a safe distance from electrical installations. If it is essential to work in this environment, first contact the safety authorities responsible for the electrical installations and follow their instructions.



WARNING

Distraction/loss of attention

During dynamic applications, for example stakeout procedures, there is a danger of accidents occurring if the user does not pay attention to the environmental conditions around, for example obstacles, excavations or traffic.

Precautions:

- ▶ The person responsible for the product must make all users fully aware of the existing dangers.

WARNING

Inadequate securing of the working site

This can lead to dangerous situations, for example in traffic, on building sites and at industrial installations.

Precautions:

- ▶ Always ensure that the working site is adequately secured.
- ▶ Adhere to the regulations governing safety, accident prevention and road traffic.

CAUTION

Not properly secured accessories

If the accessories used with the product are not properly secured and the product is subjected to mechanical shock, for example blows or falling, the product may be damaged or people can sustain injury.

Precautions:

- ▶ When setting up the product, make sure that the accessories are correctly adapted, fitted, secured, and locked in position.
- ▶ Avoid subjecting the product to mechanical stress.

DANGER

If the product is used with accessories, for example on masts, poles, you may increase the risk of being struck by lightning. Danger from high voltages also exists near power lines. Lightning, voltage peaks, or the touching of power lines can cause damage, injury and death.

Precautions:

- ▶ Be sure to remain at a safe distance from electrical installations. Do not use the product directly under or close to power lines. If it is essential to work in such an environment contact the safety authorities responsible for electrical installations and follow their instructions.
- ▶ If the product has to be permanently mounted in an exposed location, it is advisable to provide a lightning protection system. Refer to [1.5.4 Lightning Protection](#) for a suggestion on how to design a lightning protection system for the product. Always follow the regulations in force in your country regarding the design and installation of such a system. The installation must be carried out by an authorised specialist.
- ▶ To prevent damages due to indirect lightning strikes (voltage spikes) cables, for example for antenna, power source or modem should be protected with appropriate protection elements, like a lightning arrester. These installations must be carried out by an authorised specialist.

WARNING

Inappropriate mechanical influences to batteries

During the transport, shipping or disposal of batteries it is possible for inappropriate mechanical influences to constitute a fire hazard.

Precautions:

- ▶ Before shipping the product or disposing it, discharge the batteries by the product until they are flat.
- ▶ When transporting or shipping batteries, the person in charge of the product must ensure that the applicable national and international rules and regulations are observed.
- ▶ Before transportation or shipping, contact your local passenger or freight transport company.

WARNING

Exposure of batteries to high mechanical stress, high ambient temperatures or immersion into fluids

This can cause leakage, fire or explosion of the batteries.

Precautions:

- ▶ Protect the batteries from mechanical influences and high ambient temperatures. Do not drop or immerse batteries into fluids.

WARNING

Short circuit of battery terminals

If battery terminals are short circuited e.g. by coming in contact with jewellery, keys, metallised paper or other metals, the battery can overheat and cause injury or fire, for example by storing or transporting in pockets.

Precautions:

- ▶ Make sure that the battery terminals do not come into contact with metallic/conductive objects.

WARNING

Incorrect fastening of the external antenna

Incorrect fastening of the external antenna to vehicles or transporters poses the risk of the equipment being broken by mechanical influence, vibration or airstream. This may result in accident and physical injury.

Precautions:

- ▶ Attach the external antenna professionally. The external antenna must be secured additionally, for example by use of a safety cord. Ensure that the mounting device is correctly mounted and able to carry the weight of the external antenna (>1 kg) safely.

WARNING

Improper disposal

If the product is improperly disposed of, the following can happen:

- If polymer parts are burnt, poisonous gases are produced which may impair health.
- If batteries are damaged or are heated strongly, they can explode and cause poisoning, burning, corrosion or environmental contamination.
- By disposing of the product irresponsibly you may enable unauthorised persons to use it in contravention of the regulations, exposing themselves and third parties to the risk of severe injury and rendering the environment liable to contamination.

Precautions:

▶



The product must not be disposed with household waste. Dispose of the product appropriately in accordance with the national regulations in force in your country. Always prevent access to the product by unauthorised personnel.

Product-specific treatment and waste management information can be received from your Leica Geosystems distributor.



Applies only for California. The product contains CR Lithium Cell(s) with perchlorate material inside – special handling may apply. Refer to [Department of Toxic Substances Control - Perchlorate](#) for more details.

⚠ WARNING

Improperly repaired equipment

Risk of injuries to users and equipment destruction due to lack of repair knowledge.

Precautions:

- ▶ Only authorised Leica Geosystems Service Centres are entitled to repair these products.

1.5.2

Additionally for the Power Supplies

⚠ WARNING

Electric shock due to missing ground connection

If unit is not connected to ground, death or serious injury can occur.

Precautions:

- ▶ The power cable and power outlet must be grounded!



⚠ WARNING

Unauthorised opening of the product

Either of the following actions may cause you to receive an electric shock:

- Touching live components
- Using the product after incorrect attempts were made to carry out repairs

Precautions:

- ▶ Do not open the product!
- ▶ Only authorised Leica Geosystems Service Centres are entitled to repair these products.

⚠ WARNING

Electric shock due to use under wet and severe conditions

If unit becomes wet, it may cause you to receive an electric shock.

Precautions:

- ▶ If the product becomes humid, it must not be used!
- ▶ Use the product only in dry environments, for example in buildings or vehicles.



- ▶ Protect the product against humidity.

⚠ CAUTION**Exposure to rain or water**

Direct rain or water may damage and/or reduce lifetime of the battery.

Precautions:

- ▶ During outdoor use keep the battery in a rain protected place.
-

⚠ CAUTION**Long-term storage**

Long-term storage may reduce lifetime or damage the battery.

Precautions:

- ▶ During long-term storage, maintain battery life by periodic recharge.
-

⚠ WARNING**Explosion hazard during charging**

A highly explosive oxyhydrogen gas mixture occurs when charging batteries. Risk of injuries and environmental damage.

Precautions:

- ▶ Only charge the battery in well-ventilated areas.
- ▶ Only connect the battery to the battery charger when the charger is turned off.



Fires, sparks, naked lights and smoking are prohibited: Avoid causing sparks when dealing with cables and electrical equipment, and beware of electrostatic discharges. Avoid short-circuits.

⚠ WARNING**Charging or operating battery outside temperature limits**

Charging or operating the battery at temperatures below 0 °C/+32 °F or above +40 °C/+104 °F is not allowed since it may damage the battery.

Precautions:

- ▶ Respect the temperature limits when charging or operating the battery.
-

 DANGER

Lightning strikes can cause severe damage to structures, devices, services and human life. Therefore it is essential to consult an authorised specialist to design and install a means for reliable and efficient lightning protection.

The protection must consider all elements of your receiver installation, that is:

- Devices, for example receiver, GNSS antenna, meteo stations, radio communications (cellular mobile, terrestrial), switches, routers
- Power lines
- Signal lines, for example from an antenna
- Communication and data lines, for example Ethernet or serial
- Structures, for example building, mast, cabinet
- Solar panels

Warranty exclusion

Lightning may ignore every defence man can conceive. A systematic hazard mitigation approach to lightning safety is a prudent course of action.

The warranty of the receiver does not apply to, and Leica Geosystems is not responsible for defects, malfunctioning or performance issues resulting from:

- Damage caused by lightning or any other electrical discharge.

Lightning Protection Zones

Lightning Protection Zones (LPZ) can be divided into:

Zone	Description
External LPZ 0A, LPZ 0B	Zones which are at risk from direct lightning strikes, from impulse currents up to the whole lightning current and from the whole electromagnetic field of the flash of lightning.
Internal LPZ 1...n	Zones where impulse currents are limited by splitting the current and by Surge Protective Devices (SPDs) at the zones boundaries. The electromagnetic field of the lightning flash can be attenuated by spatial shielding.

At the boundary of each internal zone, the equipotential bonding must be carried out for all metal components and utility lines entering the building or structure. Equipotential bonding is done directly or with suitable SPDs.

Lightning protection zones concept according to IEC 62305-4 (EN 62305-4)

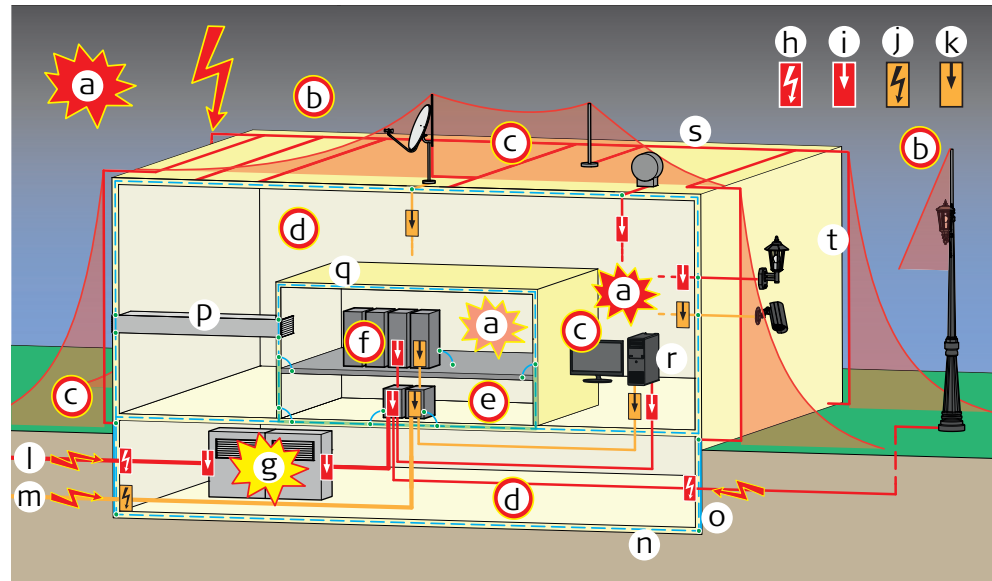

007128.001

- a Lightning electromagnetic pulse (LEMP)
- b Lightning protection zone 0A (LPZ 0A)
- c Lightning protection zone 0B (LPZ 0B)
- d Lightning protection zone 1 (LPZ 1)
- e Lightning protection zone 2 (LPZ 2)
- f Lightning protection zone 3 (LPZ 3)
- g Switching electromagnetic pulse (SEMP)
- h Lightning equipotential bonding
Lightning current arrester (SPD Type 1)
- i Local equipotential bonding
Surge arrester (SPD Type 2, SPD Type 3)
- j Lightning equipotential bonding
Lightning current arrester
- k Local equipotential bonding
Surge arrester
- l Low voltage power supply system
- m IT system
- n Steel reinforcement
- o Foundation earth electrode
- p Ventilation
- q Spatial shield
- r Terminal device
- s Air-termination system
- t Down conductor system

Lightning Protection Systems

Leica Geosystems recommends installing a **Lightning Protection System (LPS)** at continuously operating reference stations.

An LPS consists of an external and an internal system.

External system

Component	Example	Purpose
Air termination system	Lightning rods	Interception of direct strikes
Down-conductor system Bonding network	-	Conduction of lightning current safely towards earth
Earth-termination system	Grounding	Dispersion of the current into the earth

Internal system

Component	Purpose
Equipotential Bonding Bar (EBB)	Equipotentialisation between all electric conducting parts and the protective earth conductor
Metal partition panel Suitable cable routing No crossed cables coming from different LPZ's	Attenuate transient and magnetic induced fields
Surge Protective Device (SPD)	Equipotential bonding for all metal components and utility lines entering the building or structure Examples for utility lines: Communication lines, antenna cables
Magnetic shields	Attenuation of the inducing magnetic field
Suitable routing of wiring	Reduction of the induction loop

Example: External system installation on a building

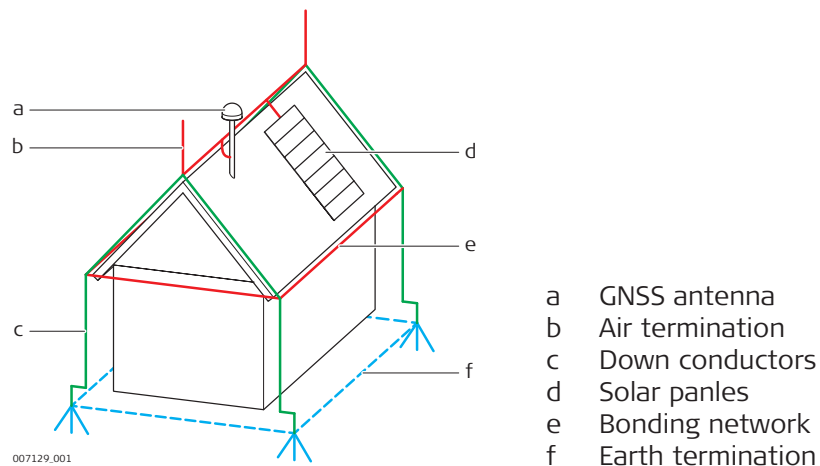

Example: External and internal system installation on a pillar

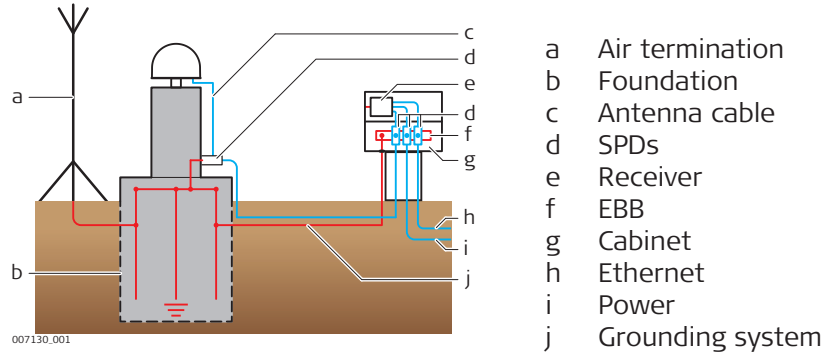

Example: Internal system installation in a cabinet

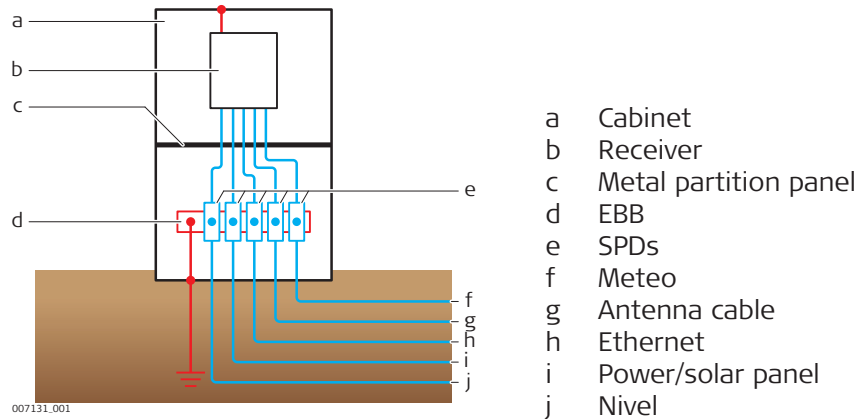

Active Lightning Protection System

An Active Lightning Protection (ALP) System combines protection with lightning detection.

Functionality

- Carrying out preventive measures in advance
- Triggering an early streamer of ionised air. The streamer intercepts lightning discharges for the safe passage to a low impedance down-conductor.

Leica customers reported successful application using products from:

- Lightning Protection International Pty Ltd (www.lpi.com.au)

Passive Lightning Protection System

A Passive Lightning Protection (PLP) System and an ALP are similar.

The PLP System has no detection (preventive measures) or triggers for an early streamer.

Leica customers reported successful application using products from:

- Huber and Suhner (www.hubersuhner.com)
- Polyphaser (www.protectiongroup.com)

Down conductor system

A down conductor system consists of a bonding network that covers the outer face of a structure, for example building.

In a steel-reinforced concrete structure, the reinforcement of the outer walls can be used as natural components.

Structures made of insulating material, for example wood or bricks, need an extra bonding network as down conductor system.

Grounding

As part of the external LPS, an earth termination system for grounding must address low earth impedance.

Suitable for grounding are poles or depths/plate/ring earth counterpoises.

Disadvantages

- Corrosions depending on the soil conditions
- Damage due to excavation

Corrective measure

Use a foundation grounding rod. Such a rod is required for electric facilities in and at structures, for example building, pillar or mast.

The foundation grounding rod is built into the concrete foundation of the structure.

Equipotentialisation

Any incoming connection into a building that can transfer an electrical potential from outside to inside must be protected against electrical discharge.

Recommendation

Deploy an EBB which is properly connected to the grounding system at the building and/or cabinet entry point.

Part	Example
Incoming connection into a building	Water, gas, communication, data or power line
Electrical discharge	Lightning surge

Structural separation in a cabinet

Case

A cabinet box is used to protect the receiver and electronic against environmental impacts.

Recommendation

Use a structural separation with a metal partition panel within the cabinet.

Purpose of a structural separation

- Separation of lightning protected and not protected part of the cabinet
- Avoiding crossed cables originating from the lightning protected and not protected part of the cabinet
- Attenuation of transient and magnetic induced fields

1.6

Electromagnetic Compatibility (EMC)

Description

The term Electromagnetic Compatibility is taken to mean the capability of the product to function smoothly in an environment where electromagnetic

radiation and electrostatic discharges are present, and without causing electromagnetic disturbances to other equipment.

 **CAUTION**

Electromagnetic radiation

Electromagnetic radiation can cause disturbances in other equipment.

Precautions:

- ▶ Although the product meets the strict regulations and standards which are in force in this respect, Leica Geosystems cannot completely exclude the possibility that other equipment may be disturbed.
-

 **CAUTION**

Use of the product with accessories from other manufacturers. For example, field computers, personal computers or other electronic equipment, non-standard cables or external batteries

This may cause disturbances in other equipment.

Precautions:

- ▶ Use only the equipment and accessories recommended by Leica Geosystems.
 - ▶ When combined with the product, other accessories must meet the strict requirements stipulated by the guidelines and standards.
 - ▶ When using computers, two-way radios or other electronic equipment, pay attention to the information about electromagnetic compatibility provided by the manufacturer.
-

 **CAUTION**

Intense electromagnetic radiation. For example, near radio transmitters, transponders, two-way radios or diesel generators

Although the product meets the strict regulations and standards which are in force in this respect, Leica Geosystems cannot completely exclude the possibility that the function of the product may be disturbed in such an electromagnetic environment.

Precautions:

- ▶ Check the plausibility of results obtained under these conditions.
-

 **CAUTION**

Electromagnetic radiation due to improper connection of cables

If the product is operated with connecting cables, attached at only one of their two ends, the permitted level of electromagnetic radiation may be exceeded and the correct functioning of other products may be impaired. For example, external supply cables or interface cables.

Precautions:

- ▶ While the product is in use, connecting cables, for example product to external battery or product to computer, must be connected at both ends.
-

 **WARNING**

Use of product with radio or digital cellular phone devices

Electromagnetic fields can cause disturbances in other equipment, installations, medical devices, for example pacemakers or hearing aids, and aircrafts. Electromagnetic fields can also affect humans and animals.

Precautions:

- ▶ Although the product meets the strict regulations and standards which are in force in this respect, Leica Geosystems cannot completely exclude the possibility that other equipment can be disturbed or that humans or animals can be affected.
 - ▶ Do not operate the product with radio or digital cellular phone devices in the vicinity of filling stations or chemical installations, or in other areas where an explosion hazard exists.
 - ▶ Do not operate the product with radio or digital cellular phone devices near medical equipment.
 - ▶ Do not operate the product with radio or digital cellular phone devices in aircrafts.
 - ▶ Do not operate the product with radio or digital cellular phone devices for long periods with the product immediately next to your body.
-

2

Description of the System

2.1

General Information

Design

The instrument

- is designed for various permanent and semi-permanent reference station applications, including network RTK, single base station, scientific, campaign, monitoring and seismic studies.
 - collects, stores and disseminates GNSS data.
 - is highly suited to system integration.
 - supports various external devices including communication, meteo and tilt.
-

Satellite tracking

The instrument can track

- GPS
- GLONASS
- Galileo
- BeiDou
- QZSS
- NavIC
- SBAS

Refer to [Tracking satellite signals](#).

Special features GR30/GM30/GR50

The instruments are equipped with several special features:

- 50 Hz data logging and streaming
- SmartTrack+ measurement engine with advanced frequency power spectrum analysis, automatic interference detection and interference mitigation options for higher accuracy and availability
- Up to 12 multiple logging sessions and 20 data streams
- Multiple data storage formats including MDB, RINEX and Hatanaka
- Supports high capacity storage up to 32 GB and intelligent Smart clean-up
- Multiple data output formats including Leica, Leica 4G, RTCM 2.x,3.x, LB2, BINEX, CMR, CMR+
- Modern, user friendly web interface GUI, available in different languages
- Site monitor to calculate a fixed position for structural monitoring and reference station integrity applications
- Leica VADASE to allow the detection of fast movements without any external correction data
- Configurable fully automated firmware update process
- Seamless integration with Leica GNSS Spider
- Robust lightweight metal housing
- Fully ruggedised to IP68, including a ruggedised Ethernet port
- Simple mounting for IT rack, cabinet and wall mount, unit is also stackable
- Built in communications module slot-in port
- Integrated device management for external devices
- Supports DHCP, DNS, DynDNS and mobile internet

- Ntrip Server/Client/Caster
 - Improved security including IP filtering, access management and HTTPS with custom SSL certificate
 - Out of the box plug and play hostname setup
 - Wide supply voltage 10.5-28 V
 - Low-power consumption, with 3.0-3.5 W typical
 - External oscillator port
 - USB client port
-

Special features GR50 only

In addition, the GR50 instruments are equipped with several special features:

- Integrated display and keypad.
 - Internal battery and charger.
 - USB host port.
 - Power over Ethernet.
 - Bluetooth or WLAN.
 - PPS and event port.
-

2.2

GNSS Reference Station Components

Component overview

The following diagram shows a variety of reference station and monitoring setups and the most common accessories that can be used with a GR30/GM30/GR50.

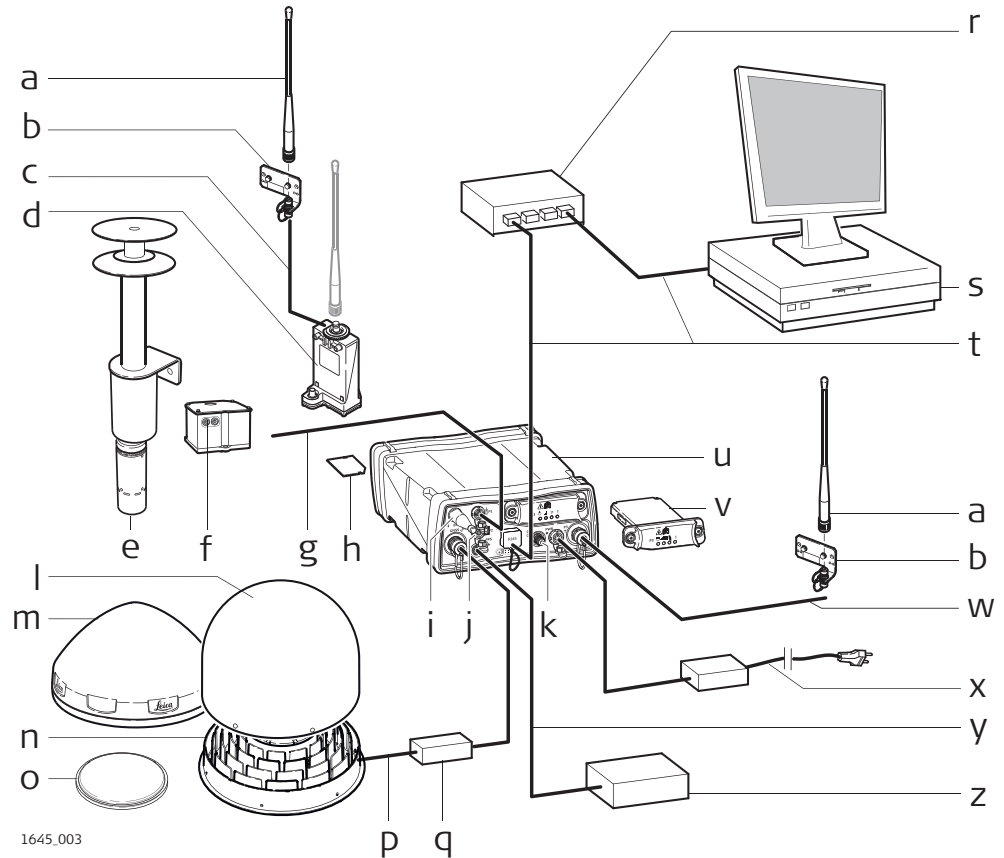

1645_003

- | | | | |
|---|------------------------------------|---|---|
| a | Radio/GSM antenna | n | GNSS antenna, AR25 |
| b | Antenna bracket | o | GNSS antenna, AS11 |
| c | Antenna cable | p | Antenna cable |
| d | GFU housing incl. Radio/GSM device | q | Optional lightning protection |
| e | Meteo sensor | r | Ethernet hub |
| f | Tilt sensor | s | Computer running GNSS Spider or web interface |
| g | Serial cable | t | Ethernet cable |
| h | SD card | u | GR30/GM30/GR50 |
| i | Bluetooth/WLAN antenna* | v | Slot-in device |
| j | Serial port 2/Event port* | w | Antenna cable |
| k | Connector for external oscillator | x | Power supply |
| l | Optional radome for AR20/AR25 | y | PPS cable* |
| m | GNSS antenna, AR10/AR20 | z | Device receiving electric pulse* |

* GR50 only

Minimum setup components

The following diagram shows the minimum components required to operate a GR30/GM30/GR50.

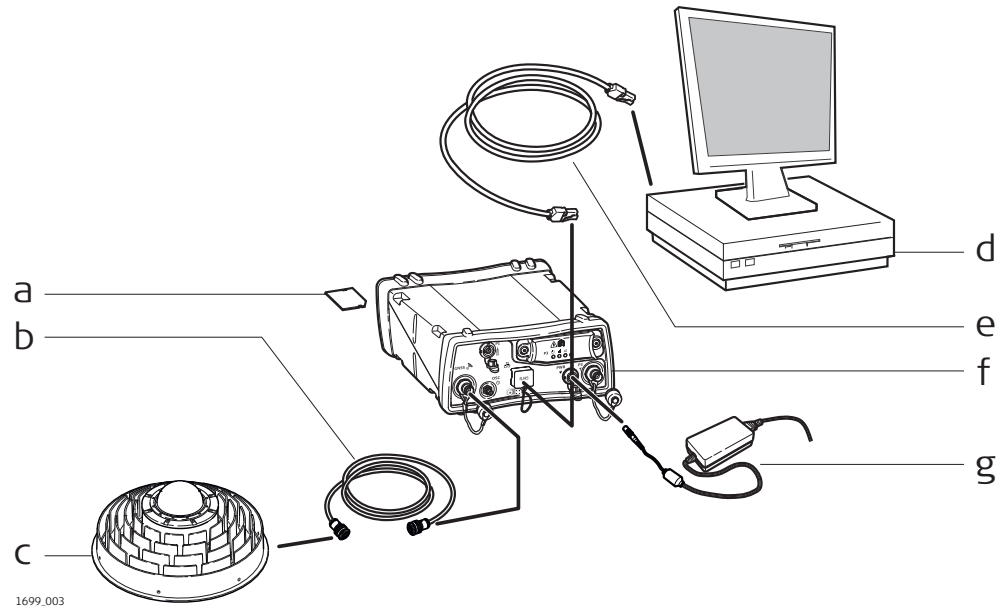

- a SD card*
- b Antenna cable
- c GNSS antenna
- d Computer running web interface or Leica GNSS Spider
- e Ethernet or USB cable
- f GR30/GM30/GR50
- g Power supply

* The instrument can be operated without the SD card but only data streaming will be possible. A new firmware update will not be possible.

Main components

Component	Description
GR30/GM30/GR50	To provide the storage and streaming of raw satellite data.
Antenna	To receive the satellite signals from the GNSS (Global Navigation Satellite System) satellites
Web interface	Web-based tool to configure the GR Series instrument.  The GR50 features a display and buttons which can be used for initial instrument setup or minor configuration changes in the field.
Leica GNSS Spider	The reference station office software including comprehensive instrument control and configuration, file download and firmware upload functions which support working with Leica GR Series instruments. Supports the connection to single or multiple reference instruments simultaneously.

2.3

Unpacking the Instrument

Delivery box

The minimum items delivered with the GR30/GM30/GR50 include:

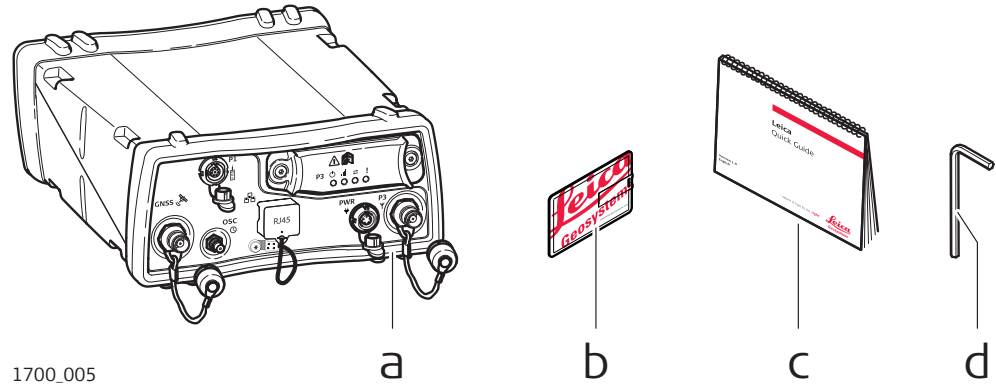

- a GR30/GM30/GR50
- b Leica USB documentation card
- c GR30/GM30/GR50 Quick Guide
- d Allen key (GR50 only)

Accessories

Additional equipment such as cables, antennas and power supply required for a complete reference station installation are delivered with the GR30/GM30/GR50 when ordered. For an overview of a typical reference station installation and the accessories that can be used with the instrument go to [GNSS Reference Station Components](#).

For further information on accessories, please refer to the "GR/GM Series Operational Manual (Online Help)" and the "Leica Spider Equipment List" available on the Leica myWorld portal for your registered product.

2.4

Instrument Components

GR30/GM30 components

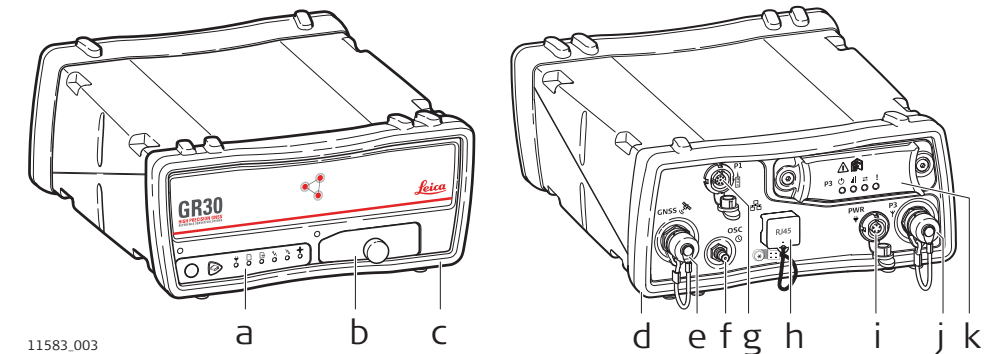

- a User interface
- b USB and SD card cover
- c Front rubber bumper
- d Back rubber bumper
- e GNSS antenna port
- f External oscillator port
- g Serial port (P1)
- h Ruggedised Ethernet port
- i Power port
- j Communication slot-in port antenna (P3)
- k Communication slot-in port (P3)

GR50 components

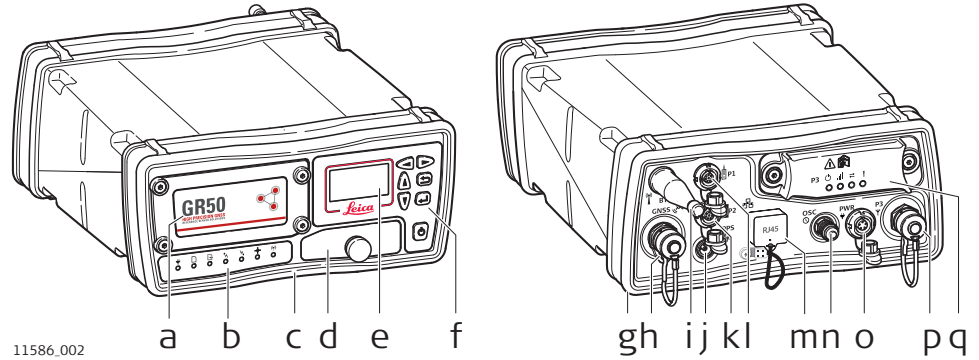

11586_002

- | | | | |
|---|------------------------|---|---|
| a | Battery cover | j | PPS out port |
| b | LEDs | k | Serial and Event in port (P2) |
| c | Front rubber bumper | l | Serial port (P1) |
| d | USB and SD card cover | m | Ruggedised Ethernet port |
| e | Display | n | External oscillator port |
| f | Buttons | o | Power port |
| g | Back rubber bumper | p | Communication slot-in port antenna (P3) |
| h | GNSS antenna port | q | Communication slot-in port (P3) |
| i | Bluetooth/WLAN antenna | | |

2.5

Operation

Overview

The instrument can be operated by:

- Pressing its buttons
- The web interface
- Leica GNSS Spider software
- With the Outside World Interface (OWI). Contact your local Leica Geosystems representative for information on OWI documentation.

The instrument is delivered with default settings which cover the needs of the typical use case. Use the web interface or Leica GNSS Spider to adjust the instrument settings.

Operation by web interface

The web interface is the main component used to configure and operate the instrument.

Refer to the "GR/GM Series Operational Manual (Online Help)" for a detailed description of the web interface.

Supported operating systems for web interface setup over USB

- Windows 7 (32 bit and 64 bit)
- Windows 8 (32 bit and 64 bit)
- Windows 10 (32 bit and 64 bit)

Supported web browsers for the web interface

All current versions of the following web browsers are supported and tested:

- Internet Explorer/Edge
- Firefox
- Chrome

Other web browsers, such as Opera or Safari, can work but are not regularly tested for compatibility.



The web interface is the primary interface between the user and the instrument. To use the web interface correctly make sure that the web browser allows JavaScript to be run. Check the web browser settings if you have problems using the web interface.

Web interface security

When accessing the web interface for the first time, or after the settings have been formatted, use the default **User name** (Admin) and **Password** (12345678) to log in.



For security reasons, it is recommended to create a new administrator account when logging in for the first time. After creating the new administrator, log out and relogin with the new user credentials. The default user account can then be deleted. Refer to the "GR/GM Series Operational Manual (Online Help)" for a step-by-step guide.



A **Personal Unblocking Key** is a PIN unlock key. The pre-installed PUK user has administrator rights and is based on the receiver's serial number. It can be used to access the receiver in case all other user credentials have been lost.

User name: PUK

Password: Your Personal Unblocking Key
Refer to the document accompanying the shipment of the receiver. Contact your local Leica Geosystems representative in case this document has been lost.

Operation by Leica GNSS Spider

The reference station software Leica GNSS Spider provides comprehensive instrument functionality, like the web interface.



Many configuration settings are available both in the web interface and in Leica GNSS Spider. If such settings are configured in the web interface, and then an **Upload Settings** or **Start** is done from Leica GNSS Spider, the settings are overwritten. In this case use the web interface exclusively for settings that are not available in Leica GNSS Spider.

To operate Leica GNSS Spider, refer to the

- "GR/GM Series Operational Manual (Online Help)" for basic information.
- "Leica GNSS Spider Online Help" for advanced information.

Requirement

- GR30/GM30/GR50: Leica GNSS Spider v6.0 or later must be installed.



The version requirement applies to active instrument connections to configure the instrument by Leica GNSS Spider. It does not apply to passive connections for data streaming only.

GNSS Spider features

GNSS Spider features:

- Simultaneous configuration and communication with one or many instruments.
- Monitoring and messaging on instrument key parameters such as power voltage level, data storage availability, instruments internal temperature or events logged on the instrument.
- Visualisation of satellite tracking status.
- Transfer of raw data automatically from the instrument to a central data storage.
- Perform RINEX conversion manually or automatically at different decimation rates and file lengths.
- FTP push archived data to multiple locations.
- Perform automatic quality control of archived RINEX data.
- Manage an entire network of reference stations.
- Supply single base or network RTK corrections to many users using various communication methods, including for example, Ntrip .
- Protect and manage access to RTK correction services using the Spider Business Center advanced user access management.

Connecting the GR30/GM30/GR50 to Leica GNSS Spider:

Connect to Leica GNSS Spider in the following ways:

- TCP/IP Ethernet over LAN, WAN, WLAN or Internet
- TCP/IP Mobile Internet using GPRS, EDGE or UMTS
- USB client connection to a PC/Laptop
- RS232 Lemo serial connection to a PC/Laptop



For TCP/IP connections, both Active and Passive connections are supported by direct TCP/IP. Active and Passive connections to Leica GNSS Spider are also supported using Ntrip with GR30/GM30/GR50 firmware v2.5 onwards. Bluetooth connections to Leica GNSS Spider are also possible, but not recommended.

2.6

Software

Description

All instruments use the same software concept.

GR/GM series software

Software type	Description
GR/GM firmware (GR30_x.xx.xxx.fw/.zip) (GM30_x.xx.xxx.fw/.zip) (GR50_x.xx.xxx.fw/.zip)	The GR/GM Series firmware is called RefWorx. This system software covers all functions of the instrument. The onboard web interface is integrated into the firmware and cannot be deleted. The English language is integrated into the firmware and cannot be deleted.
Language software (REF_LANG.sxx)	Numerous languages are available for the instrument's web server. Language software is also referred to as system language.

Software type	Description
	The system software enables a maximum of three languages which can be stored at any one time - the English language and two other languages. The English language is the default language and cannot be deleted. One language is chosen as active language.

Software upload

Software for	Description
All GR/GM models	<p>All software is stored in the System RAM of the instrument.</p> <p>A new firmware file must be uploaded to the SD card before installation. The file can be uploaded via:</p> <ul style="list-style-type: none"> the web interface. direct copy to the SD card using a computer. FTP access to the SD card. <p>After uploading, the firmware must be installed via the web interface. Refer to the "GR/GM Series Operational Manual (Online Help)" for further information.</p> <p>Leica GNSS Spider can also be used to install the firmware. Loading the firmware to the SD card and installing it on the instrument is done in one step when using GNSS Spider. Refer to the "Leica GNSS Spider Online Help" for more information.</p>

2.7

Power Supply

General

Use the Leica Geosystems power supplies, batteries, chargers and accessories or accessories recommended by Leica Geosystems to ensure the correct functionality of the instrument.

Power options

Power for the instrument can be supplied either by power supply or batteries. Up to two external power supplies can be connected using a Y-cable.

Model	Power supply
Internally	<ul style="list-style-type: none"> For the GR50 only, GEB242 (793975) battery for internal power supply. Battery can be charged from an external power source.
Externally	<ul style="list-style-type: none"> GEV242 (774437), 110 V/240 V AC to 24 V DC power supply unit, supplied by Leica Geosystems, or GEV270 (807696) 90-264 V AC to 13.2 V DC 40 W power supply unit with GEV97 cable, supplied by Leica Geosystems, or GEB171 (439038)/GEB373 (905305) battery connected via a cable, or Car battery connected via a converter cable supplied by Leica Geosystems, or For GR50 only, Power over Ethernet via a category 5 Ethernet cable or higher to supply 13 W of power over Ethernet.

Model	Power supply
Y-cable	<ul style="list-style-type: none"> • GEV243 (774438), dual power Y-cable can be used with one GEV242 24 V power supply and one other external power supply, such as an external battery GEB171/GEB373 or a GEV270 13.2 V power supply with GEV97 cable. The black Lemo connector on this cable only supports the use of the GEV242 power supply, or • GEV172 (733298), Y-cable can be used with any combination of 90-264 V AC to 13.2 VDC 40 W power supply GEV270 (807696) or a GEB171/GEB373 battery.



When using the GR30/GM30/GR50 for permanent operations use **Uninterruptible Power Supply** units as a back-up in case of a main power failure.

Example: Use the external battery GEB373 together with the GEV277 Y-cable. Refer to [Using GEB373/GEV277 as UPS for GR30/GM30/GR50](#).

The GR50 has a built-in battery and charger that can act as a short term **Uninterruptible Power Supply**. For long-term protection against power failure, an external **Uninterruptible Power Supply** can also be used.

Using GEB373/GEV277 as UPS for GR30/GM30/GR50

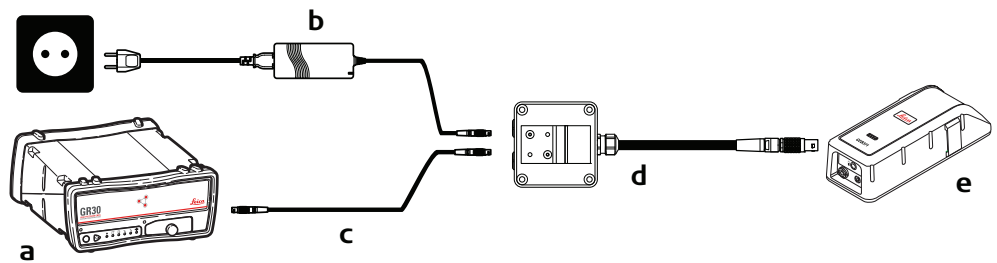

011641.001

- a GR30/GM30
- b GEV242 power supply
- c Power cable
- d GEV277 Y-cable
- e GEB373 battery

3 Installation

3.1 Before Installation

Installation location

It is recommended that the instrument is installed so that it is

- protected from mechanical influences and lightning
- within 70 m of the antenna, without the need to use inline amplifiers.
- located sufficiently far enough away from potential sources of radio frequency interference. High-power signals from nearby radio, radar or GSM/GPRS/UMTS cell towers can cause problems with GNSS tracking. Such interference is not harmful to the instrument but could cause a loss of GNSS data.

Installation orientation

- For inside assembly, the instrument can be installed in any direction
- When installing the instrument outside, orientate the instrument vertically so that the connector points are pointing downwards

Cable installation

Ensure that the cables between the instrument and antenna are positioned to prevent them from becoming bent, stretched or squeezed. For the installation of the cables, the general rules for the installation of electrical wiring apply.



Please consider that a well-planned and thoroughly carried out electric installation not only protects the cables against damage, but also looks professional.



For detailed installation information, refer to the "GNSS Reference Station and Networks - An Introductory Guide".

Using the wireless slot in device port

When using the wireless slot in device port with any slot in radio/GSM/3G/CDMA module it is recommended to use an antenna extension cable and mounting bracket to correctly position the antenna vertically, and away from the Bluetooth/WLAN antenna, as shown in the following installation options.

3.2 Installation Options

Description

GR/GM Series instruments are designed for various installation cases. Below is a short description of four installation cases for the instrument. Please note that the diagrams do not show all the equipment required for a complete reference station installation. For full installation details, please refer to the

- GNSS Reference Station and Networks - An Introductory Guide.
- Leica Spider Networks and Reference Stations Equipment List

Rack Mount

Together with the rack mount accessory kit the instrument can be easily mounted into a standard 19 inch IT rack.

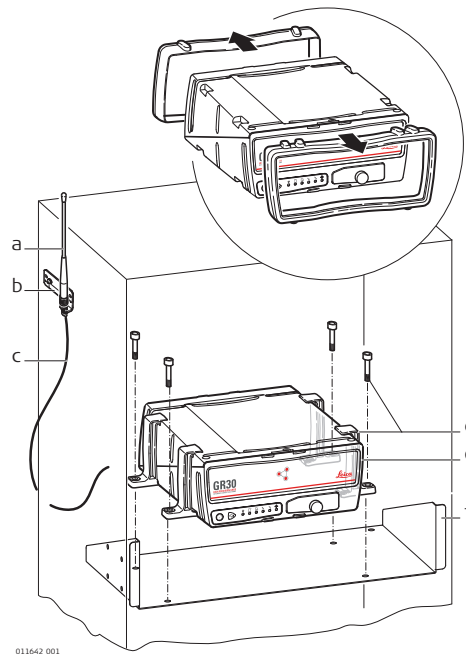

- a Radio/GSM antenna
- b Antenna bracket
- c Radio/ GSM antenna cable
- d Rack mount kit
- e GR30/GM30/GR50
- f Rack mount kit



If space in the rack is limited, then the rubber bumpers on the instrument can be removed. The total height of the rack kit and instrument is then 2U. If the bumpers are removed, please remove the small feet from the mounting brackets.



The radio/GSM antenna must be installed on the outside of the rack if a slot-in or serial device is used.

Wall / Cabinet Mount

Together with the wall mount accessory kit the instrument can be easily mounted onto an existing wall or structure, or inside an environmental case.

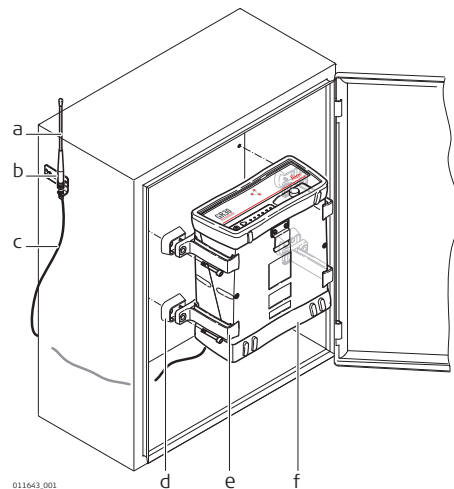

- a Radio/GSM antenna
- b Antenna bracket
- c Radio/GSM antenna cable
- d Wall mount kit - feet
- e Wall mount kit - bracket
- f Rubber bumper



If space in the cabinet is limited, then the rubber bumpers on the instrument can be removed. If the bumpers are removed, please remove the small feet from the mounting brackets.



The radio/GSM antenna must be installed on the outside of the rack if a slot-in or serial device is used.

Free Standing / Stacking

The instrument is designed to allow stable free standing installation and stacking for easy configuration of multiple receivers.

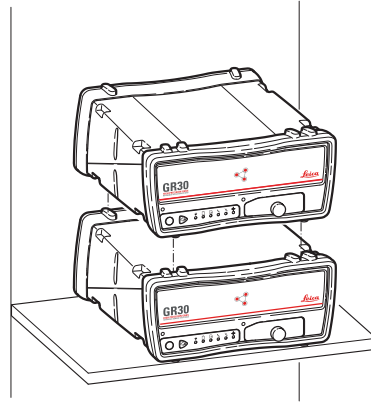

When stacking multiple instruments on top of each other, the rubber bumpers must be on.

Tripod

The instrument has a built-in Tripod mount to allow attachment to all Leica Geosystems Tripods.

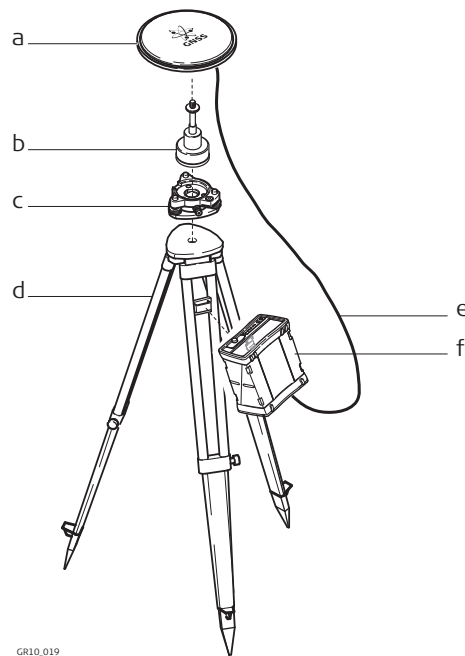

- a AR10/AS11 (shown)
- b GNSS antenna carrier with 5/8 inch screw
- c Tribrach
- d Tripod
- e Antenna cable
- f GR30/GM30/GR50



When using the instrument on a tripod, the rubber bumpers must be on.

LED indicators

Description





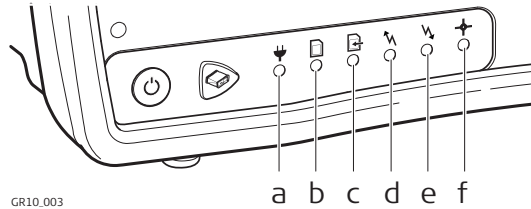

The GR30/GM30 has Light Emitting Diode indicators. They indicate the basic instrument status.





Diagram



- a Power LED
- b SD card LED
- c Raw data logging LED
- d RT out data stream LED
- e RT in data stream LED
- f Position LED

Description of the LEDs

IF the	is	THEN
Power LED 	off	The instrument is turned off.
	green	The instrument is turned on.
SD card LED 	off	No SD card inserted or power is off.
	green	SD card is inserted. The free space on the SD card is greater than 20%.
	yellow	The free space on the SD card is below 20%.  Recommended user action: Activate the Smart clean-up or the automatic file delete for each logging session.
	red	SD card is full. Data logging has stopped.  Recommended user action: Immediately activate the Smart clean-up or the automatic file delete for each logging session.
Raw data logging LED 	off	No active logging sessions or power is off.
	green	Active logging sessions are configured on the instrument and data is being logged.
	yellow	Active logging sessions are configured and Smart clean-up is deleting data from all or some of the configured logging sessions. OR Active logging sessions are configured but no position is available.  Recommended user action: Check the remaining space of the SD card and delete old data if necessary. Check the tracking and position status.

IF the	is	THEN
	red	Active logging sessions are configured but the SD card is full or no satellites are tracked.  Recommended user action: Check the SD card and the tracking status.
RT out data stream LED 	off	No active data stream is configured or power is off.
	green	One or more data streams are configured and active. Data is being streamed.
	red	Data streams are active but no data is streamed.  Recommended user action: Check that satellites are tracked and a navigated position is available. Check that the correct reference position is entered.
RT in data stream LED 	off	No active real time in data stream or power is off.
	green	A real time in data stream is configured and active, data is received and a fixed position is available.
	flashing green	A real time in data stream is configured and active, data is received and a DGPS position is available.
	yellow	A real time in data stream is configured and active, data is received but no fixed or DGPS position is available.
	red	Incoming data streams are active but no data is received. OR Incoming data stream is configured and active but the instrument is not tracking satellites and/or no navigated position is available. Recommended user action: Check that the incoming data connection is set up correctly. Check the tracking and position of the instrument.
Position LED 	off	The instrument is switched off.
	flashing green	The instrument is tracking satellites but no position is available.
	green	A navigated position is available.
	red	No satellites are tracked and no navigated position is available.

4.2

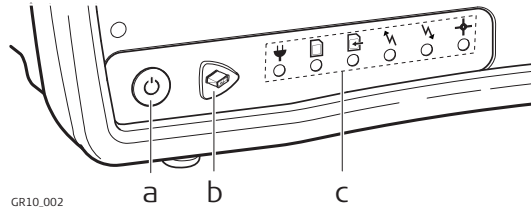

Keyboard

GR30/GM30 keyboard





- a ON/OFF button
- b Function button
- c LEDs



ON/OFF button









Button	Function
ON/OFF 	<p>If GR30/GM30 already off: Turns on GR30/GM30 when held for 3 s.</p> <p>If GR30/GM30 already on: Turns off GR30/GM30 when held for 3 s.</p>
	Hold the ON/OFF button for 10 s, to force the instrument to turn off. Instrument settings and some data can be lost when using this method.





Function button

	All the following functions described assume the GR30/GM30 is already on.
Button	Function
Function 	<p>The Function and ON/OFF button work in combination and allow a number different functions as described in Button combinations.</p> <p>The Function button switches between these different functions.</p>

Button combinations

Buttons	How to
 + 	<p>Activate dual button functionality</p> <p>Press and hold both buttons until all LEDs are flashing. Then release both buttons. After 1 s, the  Raw data logging LED starts flashing.</p> <p>The following instrument commands are now activated. After any of the instrument commands in this table was used, the dual button functionality is turned off automatically. You must turn on the dual button functionality every time before using the instrument commands.</p> <p>Start/Stop all logging sessions</p> <p>Activate the dual button functionality.</p> <p>If all logging sessions had been off, the Raw data logging LED is flashing green.</p>

Buttons	How to
	<p>3 s</p> <ul style="list-style-type: none"> Press and hold the Function button until the LED flashes quickly to START all configured logging sessions if the Raw data logging LED is flashing green. <p>OR</p> <p>If any logging session had been active, the Raw data logging LED is flashing red.</p> <ul style="list-style-type: none"> Press and hold the Function button until the LED flashes quickly to STOP all active logging sessions if the Raw data logging LED is flashing red. <p>After logging has been started or stopped, the LED and instrument functionality goes back to general behaviour.</p>
Start/Stop all data streams	
Activate the dual button functionality.	
	<p>1 X</p> <p>Press the Function button once until the  RT out data streams LED starts flashing slowly. If all data streams had been off, the RT out data stream LED is flashing green.</p>
	<p>3 s</p> <ul style="list-style-type: none"> Press and hold the Function button until the LED flashes quickly to START all configured data streams if the RT out data stream LED is flashing green. <p>If any data stream had been active, the RT out data stream LED is flashing red.</p> <p>OR</p> <ul style="list-style-type: none"> Press and hold the Function button until the LED flashes quickly to STOP all active data streams if the RT out data stream LED is flashing red. <p>After data streams have been started or stopped, the LED and instrument functionality goes back to general behaviour.</p>
Initialise the measurement engine	
Activate the dual button functionality.	
	<p>2 X</p> <p>Press the Function button twice until the  Position LED starts flashing slowly.</p>
	<p>3 s</p> <ul style="list-style-type: none"> Press and hold the Function button until the LED flashes quickly to reset the measurement engine. This action will delete all almanac and ephemeris information and the instrument will take a few minutes to restart tracking satellites. <p>After the measurement engine has been initialised, the LED and instrument functionality goes back to general behaviour.</p>
Format receiver settings	
Activate the dual button functionality.	
	<p>3 X</p> <p>Press the Function button three times until the  Power LED starts flashing slowly:</p>

Buttons	How to
 3 s	<ul style="list-style-type: none"> Press and hold the Function button until the LED flashes quickly to set all configured instrument settings back to factory default values. <p>After the system format is completed, the LED and instrument functionality goes back to general behaviour.</p>
<p>Format the SD card</p> <p>Activate the dual button functionality.</p>	
 4 X	<p>Press the Function button four times until the  SD card LED starts flashing slowly:</p>
 3 s	<ul style="list-style-type: none"> Press and hold the Function button until the LED flashes quickly to format the SD card. <p>After the SD card format is completed, the LED and instrument functionality goes back to general behaviour.</p>
<p>Exit combined button functionality</p> <ul style="list-style-type: none"> Use the button functionality as described above. <p>OR</p>	
 5 X	<ul style="list-style-type: none"> To return to normal instrument functionality, press the Function button five times until all LEDs stop flashing.

4.3

USB and SD Card Cover

USB port and SD card slot

Description

The GR30/GM30 has a USB port and an SD card slot.

Diagram

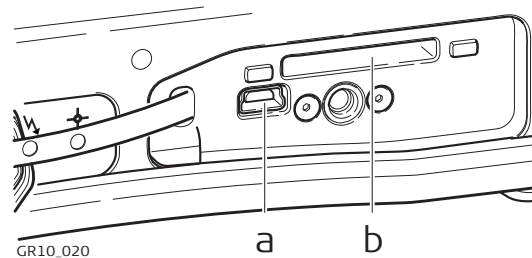

- a USB client port
- b SD card slot

USB client port

The USB client port can be used to:





- connect the GR30/GM30 to a computer and access the GR30/GM30 web interface and FTP server.
- connect the GR30/GM30 to a CS10/CS15/CS20 field controller and access the GR30/GM30 web interface.

SD card slot

Data is stored on a removable SD card.

For more information on how to work with the SD card, refer to [7.3 Working with the Memory Device](#)

 If no SD card is inserted, data storage is not possible.

-  Unplugging connection cables or removing the SD card during data logging or streaming can cause loss of data. Switch off the instrument before removing the SD card.
-  While other SD cards can be used, Leica Geosystems recommends only using Leica SD cards. Leica Geosystems is not responsible for data loss or any other error that can occur while using a non-Leica card.
-  SD cards can directly be used in the Leica USB Card Reader (767895 MCR7). Other computer card drivers can require an adaptor.
-  If formatting the SD card is necessary, we highly recommend formatting the SD card on the instrument. Refer to the "GR/GM Series Operational Manual (Online Help)" for detailed instructions.

SD card capacity

Maximum supported capacity: 32 GB.

5

GR50 User Interface

5.1

LED Indicators on GR50

LED indicators

Description

The GR50 has Light Emitting Diode indicators. They indicate the basic instrument status.



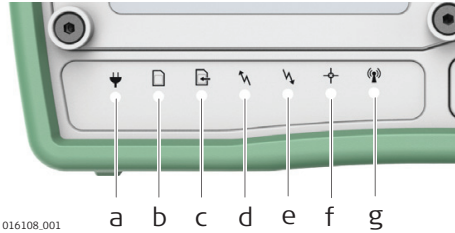

Diagram

















- a Power LED
- b SD card LED
- c Raw data logging LED
- d RT out data stream LED
- e RT in data stream LED
- f Position LED
- g Bluetooth LED

016108_001

Description of the LEDs

IF the	is	THEN
Power LED 	off	The instrument is turned off.
	green	The instrument is turned on.
	flashing green	The instrument is on but has switched to a backup power source. If an internal battery is used, indicates that the remaining battery capacity is high.
	yellow	Only shown if using an internal battery. The remaining battery capacity is low.  Recommended user action: Provide an alternative power source.
	red	Only shown if using an internal battery. The remaining battery capacity is critical.  Recommended user action: Switch to a new power source immediately.
	flashing yellow	The internal battery is charging.  Charging is only indicated by LEDs when the instrument is turned off. When the instrument is on, the LEDs indicate the current power level.

IF the	is	THEN
	flashing red	<p>Charging of the internal battery is activated but there is an error in charging the battery.</p> <p> Recommended user action: Check and reattach the battery. If the problem does not disappear, please send the battery to Leica Geosystems Service.</p> <p> Charging is only indicated via LEDs when the instrument is turned off. When the instrument is on, the LEDs indicate the current power level.</p>
SD card LED	off	No SD card inserted or power is off.
	green	SD card is inserted. The free space on the SD card is greater than 20%.
	yellow	<p>The free space on the SD card is below 20%.</p> <p> Recommended user action: Activate the Smart clean-up or the automatic file delete for each logging session.</p>
	flashing green	Use of external USB drive is configured but the device is not available. Data is written to the SD card. The free space on the SD card is greater than 20%.
	flashing yellow	Use of external USB drive is configured but the device is not available. Data is written to the SD card. The free space on the SD card is below 20%.
	red	<p>SD card is full. Data logging has stopped.</p> <p> Recommended user action: Immediately activate the Smart clean-up or the automatic file delete for each logging session.</p>
Raw data logging LED	off	No active logging sessions or power is off.
	green	Active logging sessions are configured on the instrument and data is being logged
	yellow	<p>Active logging sessions are configured and Smart clean-up is deleting data from all or some of the configured logging sessions. OR Active logging sessions are configured but no position is available.</p> <p> Recommended user action: Check the remaining space of the SD card and delete old data if necessary. Check the tracking and position status.</p>

IF the	is	THEN
	red	Active logging sessions are configured but the SD card is full or no satellites are tracked.  Recommended user action: Check the SD card and the tracking status.
RT out data stream LED 	off	No active data stream is configured or power is off.
	green	One or more data streams are configured and active. Data is being streamed.
	red	Data streams are active but no data is streamed.  Recommended user action: Check that data is tracked and a navigated position is available. Check that the correct reference position is entered.
RT in data stream LED 	off	No active real-time in data stream or power is off.
	green	A real-time in data stream is configured and active, data is received and a fixed position is available.
	flashing green	A real-time in data stream is configured and active, data is received, a DGPS position is available.
	yellow	A real-time in data stream is configured and active, data is received but no fixed or DGPS position is available.
	red	Incoming data streams are active but no data is received. OR Incoming data stream is configured and active but the instrument is not tracking satellites and/or no position is available.  Recommended user action: Check that the incoming data connection is set up correctly. Check the tracking and position of the instrument.
Position LED 	off	The instrument is switched off.
	flashing green	The instrument is tracking satellites but no position is available.
	green	A navigated position is available.
	red	No satellites are tracked and no navigated position is available.
Bluetooth LED 	off	No Bluetooth wireless signal (not configured or no connection established).

IF the	is	THEN
	blue	Bluetooth connection configured and connected.

 Please note the Bluetooth LED is only available on GR50 Bluetooth enabled versions. GR50 with WLAN do not support Bluetooth.

5.2

Keyboard and Display

GR50 keyboard and display





- a Left button
- b Right button
- c Up button
- d Cancel button
- e Down button
- f Enter button
- g Display
- h ON/OFF button

ON/OFF button

Button	Function
ON/OFF 	If GR50 is already off: Turns on GR50 when held for 3 s. If GR50 is already on: Turns off GR50 when held for 3 s.

 Hold the ON/OFF button for 10 s, to force the instrument to turn off. Instrument settings and some data can be lost when using this method.

Arrow buttons

Button	Function
Left/Right 	To scroll through menus and configuration options.
Up/Down 	For editable fields use the arrow buttons for scrolling and selecting alphanumeric fields.

Cancel button

Button	Function
Cancel 	To exit pages without storing changes.

Enter button

Button	Function
Enter 	To select menu items, open new pages and select options.

5.3

USB and SD Card Cover

USB port and SD card slot

Description

The GR50 has a USB host port, USB client port and an SD card slot.

Diagram

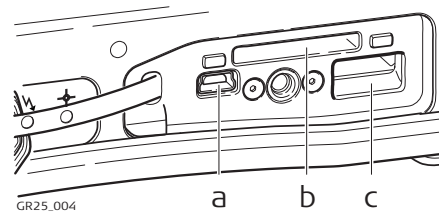

- a USB client port
- b SD card slot
- c USB host port

USB client port

The USB client port can be used to:

- connect the GR50 to a computer and access the web interface and FTP server.
- connect the GR50 to a CS10/CS15/CS20 field controller and access the web interface.

USB host port





The USB host port can be used to:

- connect a USB mass storage device to the GR50 and push MDB and RINEX data from the SD card.

SD card slot

Data is stored on a removable SD card.

For more information on how to work with the SD card, refer to [7.3 Working with the Memory Device](#)

-  If no SD card is inserted, data storage is not possible.
-  Unplugging connection cables or removing the SD card during data logging or streaming can cause loss of data. Switch off the instrument before removing the SD card.
-  While other SD cards can be used, Leica Geosystems recommends only using Leica SD cards. Leica Geosystems is not responsible for data loss or any other error that can occur while using a non-Leica card.
-  SD cards can directly be used in the Leica USB Card Reader (767895 MCR7). Other computer card drivers can require an adaptor.
-  If formatting the SD card is necessary, we highly recommend formatting the SD card on the instrument. Refer to the "GR/GM Series Operational Manual (Online Help)" for detailed instructions.

SD card capacity

Maximum supported capacity: 32 GB.

6 Equipment Setup

6.1 Basic Setup

Description

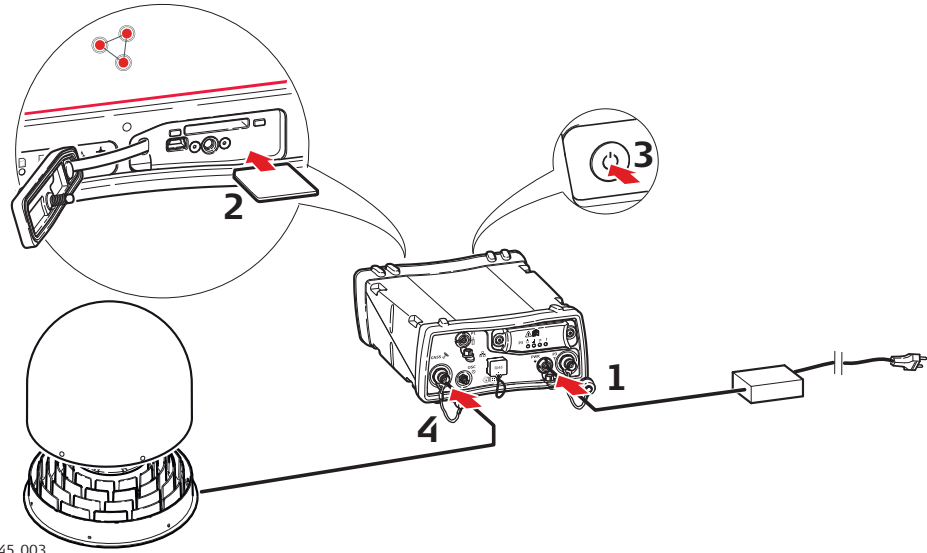

11645_003

Step	Description
1.	Plug the power cable/power supply into the GR30/GM30/GR50.
2.	Insert the SD card into the SD card slot. For more information on how to work with the SD card, refer to 7.3 Working with the Memory Device .
3.	Turn on the GR30/GM30/GR50.
4.	Attach the antenna cable, for example the GEV194, 1.8 m antenna cable, to the instrument's antenna port and to the connector on the antenna.
	To access the instrument via Ethernet or USB refer to: <ul style="list-style-type: none">• 6.2 Set up by Web Interface Over Ethernet and DHCP• 6.3 Set up in a Non-DHCP Network• GR50 setup in a non-DHCP network using display and buttons• 6.4 Install USB drivers• 6.4.2 Setup via Web Interface over USB Refer to the "GR/GM Series Operational Manual (Online Help)" for detailed information on the web interface.

6.2

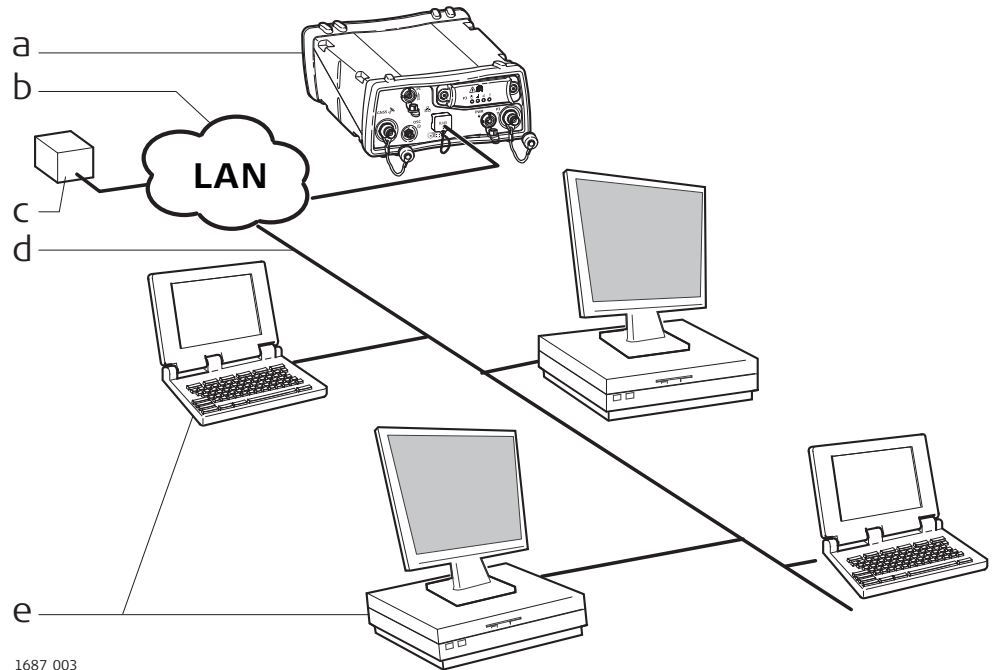

Set up by Web Interface Over Ethernet and DHCP

Setup via web Interface over Ethernet and DHCP



1687_003

- a GR30/GM30/GR50
- b Local network (LAN)
- c DHCP server
- d Ethernet cable
- e Computers with web interface

Step	Description
1.	Start the computer.
2.	To connect the instrument to the local LAN supporting DHCP, plug an Ethernet cable into the Ethernet port on the back of the GR30/GM30/GR50.
3.	Turn on the GR30/GM30/GR50.
4.	Open a browser window on your computer.
5.	Type "GR*****" into the browser's address field, where ***** is the serial number of the instrument. For example, GR1700001.
6.	The web interface will now be accessible.
7.	Use the default User name (Admin) and Password (12345678).  After logging in the first time you must create a new user account, including a new user name and password. The default user account can then be deleted. Refer to the GR Series Operational Manual (Online Help) for a step-by-step guide.
8.	Configure the GR30/GM30/GR50 for all required settings.  Refer to the "GR/GM Series Operational Manual (Online Help)" for further details on using the instrument's web interface.

6.3

Set up in a Non-DHCP Network

Setup in a non-DHCP network

If the instrument is setup in a non-DHCP network, the web interface can still be accessed using a crossed Ethernet cable.

Setup for Windows 10

1. Start the computer.
2. Connect the crossed Ethernet cable to the computer and the Ethernet port on the back of the GR30/GM30/GR50.
3. Turn on the GR30/GM30/GR50.
4. On the computer go **Start / Control Panel / Network and Internet / Network Connections**.
5. Select the Network connection used with the crossed Ethernet cable, right click and select **Properties**.

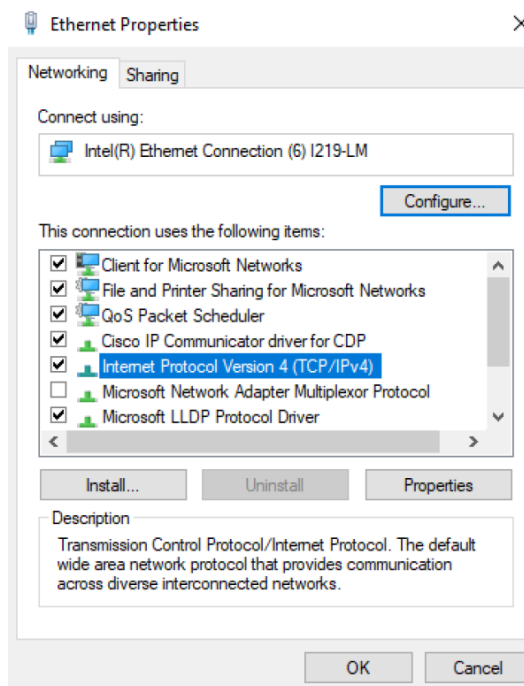

6. In the **General** tab, highlight **Internet Protocol** and press **Properties**
7. Select **Use the following IP address** and enter
 - **IP address:** 192.168.0.1
 - **Subnet mask:** 255.255.255.0

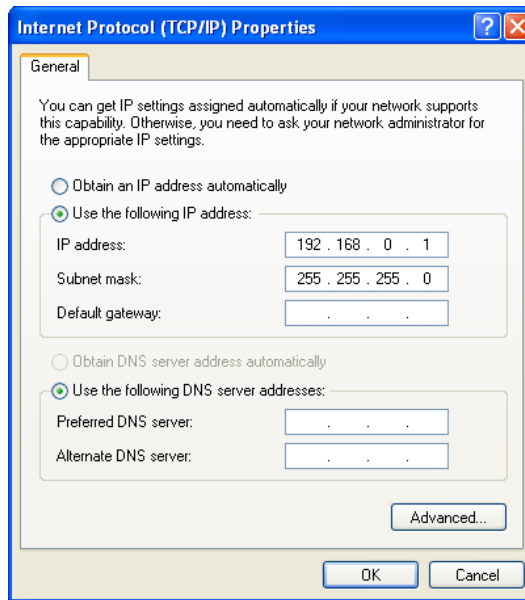

8. Press **OK**.
 9. Open a browser window and enter 192.168.0.3 to open the web interface.
-  Per default, the GR30/GM30/GR50 instrument is configured to obtain an IP address automatically from a DHCP network. To use the default static IP address 192.168.0.3, reboot the GR30/GM30/GR50 once it is connected to the crossed Ethernet cable.

GR50 setup in a non-DHCP network using display and buttons

In a field campaign the GR50 can be configured through the display and buttons, to start or stop pre-configured data streams and logging sessions.

For initial setup, the GR50 IT configuration for setup in a non-DHCP network can be done through the display and buttons.

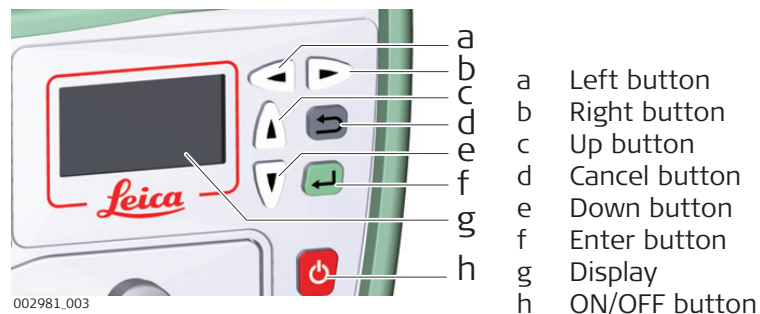

1. Turn on the GR50.
2. Use the arrow buttons, go to **Configuration, Site Config**. Enter the coordinates, antenna type and site code.
3. Press **Enter** to store all changes.
4. Use the arrow buttons go to **Configuration, Network Config**. Enter the IP address, Subnet mask and gateway of the network to connect the instrument to.
5. Press **Enter** to store all changes.

6. For a field campaign setup, select **Logging/Streaming** and start or stop pre-configured data streams and logging sessions.
7. Press **Enter** to store all changes.
8. Refer to the "GR Series Operational Manual (Online Help) for further details on using the instrument.

6.4 Install USB drivers

6.4.1 General

Before you begin

Before connecting the instrument to a computer using a USB cable, you must first install USB drivers. To install the USB drivers refer to the GR/GM USB Driver Installation Guide available on myWorld.



Only one instrument can be connected to the computer via USB at a time.

6.4.2 Setup via Web Interface over USB

Setup via web interface over USB

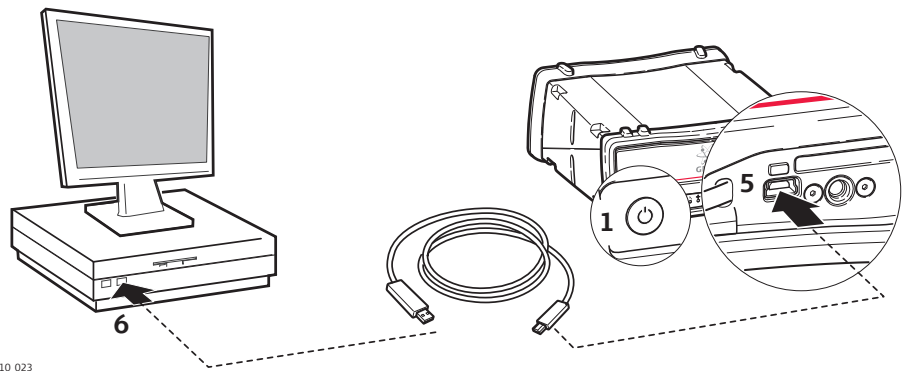



1. Turn on the instrument.
 2. Start the computer.
 3. Loosen the screw on the SD card/USB port cover.
 4. Open the SD card/USB port cover.
 5. Plug the USB cable into the USB port on the instrument.
 6. Plug the USB cable into the USB port of the computer.
 7. Open a browser and type in the IP address: 192.168.254.2 to access the instruments web interface.
 8. Use the default **User name** (Admin) and **Password** (12345678).
 - After logging in the first time you must create a new user account, including a new user name and password. The default user account can then be deleted. Refer to the "GR/GM Series Operational Manual (Online Help)" for a step-by-step guide.
 9. Configure the instrument for all required settings.
-

6.5

Setup via Web Interface over Bluetooth (GR50)

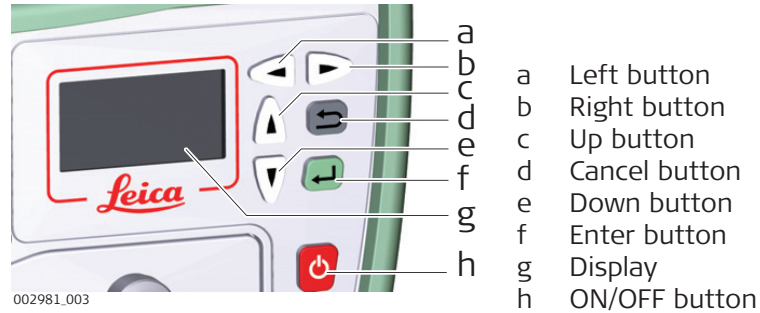
Setup via web interface over Bluetooth (GR50 Bluetooth version only)



1. Turn on the GR50.
2. Use the arrow buttons, go to **Configuration, Network Config**. Scroll down to the Bluetooth field and use the left button to enable Bluetooth.
3. Activate bluetooth on your computer and search for Bluetooth devices. The instruments hostname will be listed.
4. Pair the Bluetooth connection of your computer with the instrument. The default pairing code is 0000. The pairing code can be changed later in the web interface.
5. Once the pairing is finished, right click on the GR device listed in your Bluetooth devices panel and select **Connect**.
6. Go to the **Network connections** panel of your computer and select the Bluetooth network connection connected to the GR instrument. Right click and open the properties.
7. Highlight the **TCP/IP connection** and click on the **Properties** button.
8. Enter the IP address **192.168.253.x** and subnet mask **255.255.255.0**.
9. Open a browser and type in the IP address: 192.168.253.2 to access the web interface.
10. Use the default **User name** (Admin) and **Password** (12345678).
 After logging in the first time you must create a new user account, including a new user name and password. The default user account can then be deleted. Refer to the "GR/GM Series Operational Manual (Online Help)" for a step-by-step guide.
11. Configure the instrument for all required settings.

Web Interface login

Entering the instruments IP address or host name in a browser window displays the web interface login page.

- The home page is also shown after user login.
- For a partially restricted web interface access, the login as guest button can be used. This allows access to all instrument status information.



The login page is not shown if the web interface access level is set to **unrestricted**. The web interface home page is opened directly. For security reasons it is not recommended to set the web interface access to **Unrestricted**. To change the access setting, go to **Receiver Setup / Access Management / Access settings**.

Web Interface - User Interface

The default appearance of the web interface consists of the following main components.

The screenshot shows the Leica Geosystems web interface. At the top, there is a header with the Leica Geosystems logo and the slogan "when it has to be right". Below the header is a navigation menu with links for Home, Status, GNSS management, Receiver setup, Help, and Support. The main content area is divided into several sections:

- Status:** View the status of important receiver information, such as the configured logging sessions, the satellite tracking, an overview of the ports in use and the power and memory available.
- Receiver setup:** Configure all receiver related settings such as network connections, FTP push locations and the user management. Or use the tools to upgrade the receiver firmware, add new option keys or switch to your preferred language.
- GNSS management:** Configure all GNSS data related settings, such as logging sessions, data streams and the tracking settings. Or enter site specific information such as the site name, position and antenna details.
- Support:** Send receiver information and questions to your Leica support contact, stay informed about new firmware releases or browse the Leica FAQs to quickly find a solution for common questions.

On the right side, there is a **Tracking** section showing a table of tracking data:

General	Tracking
24.3 V	GPS 10 / 11
6.78 GB (87.68%) free	GLO 9 / 10
No USB drive	GAL 5 / 6
1 active data stream(s)	BDS 10 / 11
1 active log session(s)	QZSS 2 / 2
5d 22h 35min	NavIC 6 / 6
Smart clean-up not active	SBAS 2
	OSC Internal

Below the tracking table is an **Event log** section showing a list of events with timestamps and descriptions:

- 13:05:58 Navigated position available.
- 13:05:34 Antenna not connected or antenna not powered by the receiver.
- 13:05:23 Navigated position lost.
- 09:45:31 TCP/IP server connection closed : 2001
- 09:44:08 TCP/IP server accepted connection : 5555
- 09:44:05 TCP/IP server connection closed : 5555
- 09:44:05 TCP/IP server data receive timeout detected : 5555
- 09:43:14 TCP/IP server accepted connection : 2001

At the bottom left of the screenshot, the text "002729_00" is visible.

- a Header
- b Menu Bar
- c Status: General

- d Status: Tracking
- e Status: Event log

Header

The header contains general information about the instrument.

- Instrument type
- Loaded firmware version
- Site code
- Current system date and time

Menu Bar

The menu bar at the top of the display contains links to the home page, all status information, GNSS management pages, receiver setup, help and support. The menus are extended when the mouse is moved over a menu item. If a link is not available to a logged in user, it is greyed out and not accessible. Which menu items are available is dependent on

- the selected **Access to web interface** level, and
- the selected **Web interface user level** of the logged in user.

Status: General

Provides an overview of the current status of the instrument. The icons correspond to the LED indicators on the instrument.





Status: Tracking

Provides an overview of the current tracking status of the instrument.

Status: Event log

Displays the latest eight messages from the **Status / Event log** page.

Online Help

Access	Description
	Press the help menu to open the complete online help.
	Press to open context-sensitive help.
	Press to activate hints on the active Web interface page.
	Refer to the "GR/GM Series Operational Manual (Online Help)" for detailed information on the web interface.

7.2

Batteries

7.2.1

Operating Principles

Charging / first-time use

- The battery must be charged before using it the first time, because it is delivered with an energy content as low as possible or might be in sleep mode.
- The permissible temperature range for charging is from 0 °C to +40 °C/ +32 °F to +104 °F. For optimal charging, we recommend charging the batteries at a low ambient temperature of +10 °C to +20 °C/+50 °F to +68 °F if possible
- It is normal for the battery to become warm during charging. Using the chargers recommended by Leica Geosystems, it is not possible to charge the battery once the temperature is too high
- For new batteries or batteries that have been stored for a long time (> three months), it is effectual to make a discharge/charge cycle
- For Li-Ion batteries, a single discharge/charge cycle is sufficient. We recommend carrying out the process when the battery capacity indicated on the charger or on a Leica Geosystems product deviates significantly from the actual battery capacity available.

Operation/discharging

- The batteries can be operated from -20 °C to +65 °C/-4 °F to +149 °F
- Low operating temperatures reduce the capacity that can be drawn; high operating temperatures reduce the service life of the battery

7.2.2

Changing the Battery

Insert and remove the battery on the GR50 step-by-step

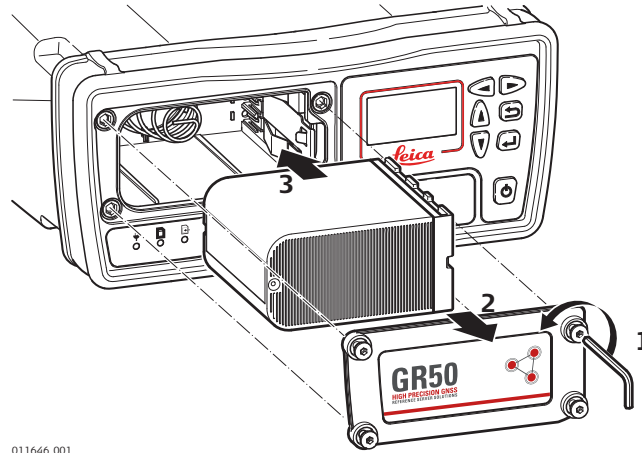

011646.001

Step	Description
	The battery is inserted in the front of the instrument.
1.	Loosen the screws on the battery compartment with the Allen key provided with the GR50.
2.	Remove the battery cover.
3.	With the arrow facing forward, slide the battery into the battery compartment and push so that it locks into position.
4.	Replace the cover of the battery compartment and tighten the screws.
5.	To remove the battery, loosen the screws and remove the cover of the battery compartment.
6.	Push the ledge on the right side of the battery compartment to the right until it releases the battery.
7.	Pull out the battery.
8.	Replace the cover of the battery compartment and tighten the screws.

7.2.3

Using the GR50 Internal Battery and Charger

Charging

- Battery charging can be enabled in the GR50 web interface. Refer to the "GR/GM Series Operational Manual (Online Help)" for further information. Note: When charging the GEB242 battery with the GR50 internal charger, it is technically possible to charge the GEB242 battery between -20°C to +65°C/-4°F to +149°F. Please note the internal temperature reading on the GR50 web interface.
- When the GR50 is turned on, the battery charging status is indicated in the GR50 web interface.
- When the GR50 is powered down, battery charging is indicated via the LEDs. For further information refer to [5.1 LED Indicators on GR50](#).

7.3

Working with the Memory Device



- Keep the card dry.
- Use it only within the specified temperature range.
- Do not bend the card.
- Protect the card from direct impacts.

NOTICE

The SD card must not be removed while the instrument is writing data to the card. To remove the SD card safely, turn off the instrument beforehand.

NOTICE

Ensure that the instrument is off before inserting the SD card. Switching on the instrument will ensure the necessary folder structure is available on the SD card.



Failure to follow these instructions could result in data loss and/or permanent damage to the card.

Insert and remove an SD card into instrument step-by-step

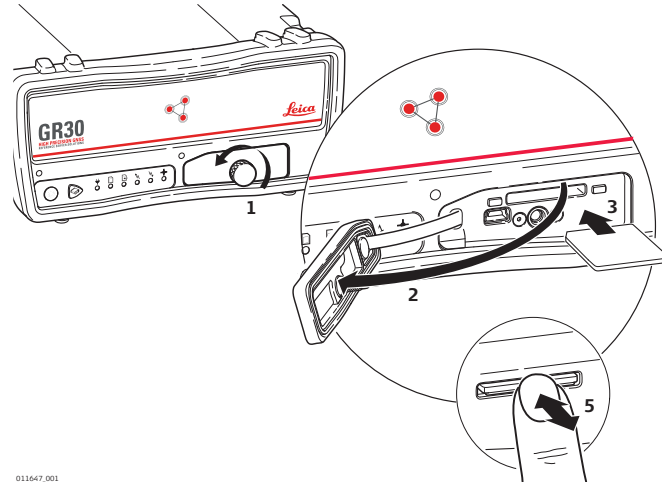

011647.001

Step	Description
	The SD card is inserted into a slot inside the SD card/USB port cover on the front of the instrument.
1.	Loosen the screw on the SD card/USB port cover.
2.	Open the SD card/USB port cover.
3.	Place the SD card into the slot. The card should be held with the contacts downwards and facing the slot.
	Do not touch the contacts.
4.	Slide the card firmly into the slot until it clicks into position.
5.	To remove the SD card, gently press inwards on the card to release it from the slot.
6.	Place the SD card/USB port cover back over the slot and tighten the cover screw.

7.4

Working with Radio, Modem and GSM Devices

7.4.1

General

Description

Various devices can be used with the instrument, including

- GSM/Radio GFU devices connected via a serial port
- Slot-in devices
- External Modems connected via a serial port
- External Radios connected via a serial port

7.4.2

Serial Devices

Devices fitting into a GFU housing

For an up to date list of supported GFU devices, please refer to the latest Spider Equipment list, or ask your local Leica Geosystems representative.

Connecting a GFU device to a GR30/GM30/GR50

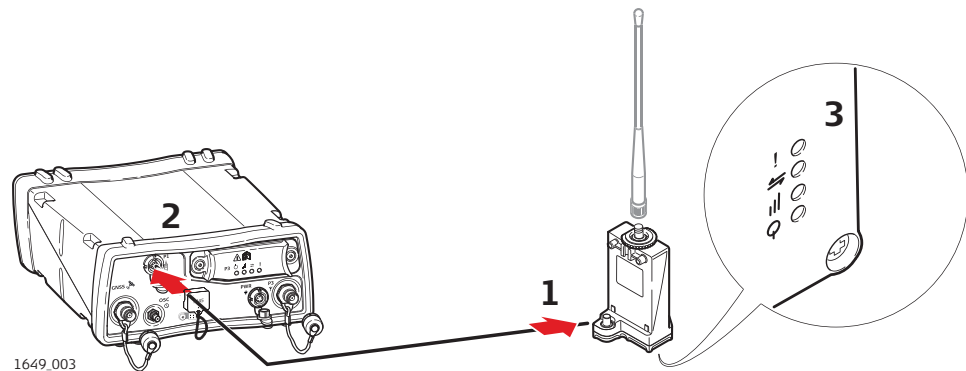

1. Connect the GEV232 or GEV233 GFU cable to the serial port on the GFU housing.
2. Connect the GEV232 or GEV233 GFU cable to the serial port on the GR30/GM30/GR50.
3. The GFU device is successfully connected to the instrument when the LEDs on the GFU are on.

Insert and remove a SIM card step-by-step for an external GFU device

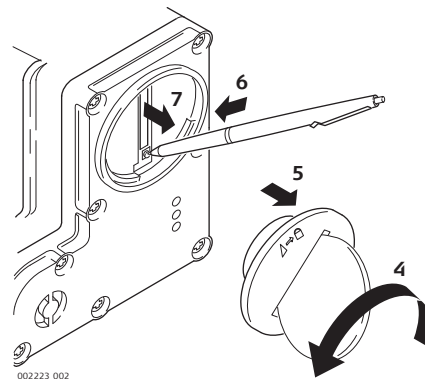

☞ The SIM card is inserted into a slot on the bottom of the GFU housing.

1. Take the SIM card, a coin and a pen.
2. Locate the SIM card screw, that covers the SIM card slot, on the bottom of the GFU housing.
3. Insert the coin into the groove of the SIM card screw.

4. Turn the coin anticlockwise to loosen the SIM card screw.
5. Remove the SIM card screw from the housing.
6. Using the pen, press the small button of the SIM card slot to eject the SIM card holder.
7. Take the SIM card holder out of the housing.
8. Put the SIM card into the SIM card holder, the chip facing up.
9. Insert the SIM card holder into the SIM card slot, the chip facing the connectors inside the slot.
10. Place the SIM card screw back on the housing.
11. Insert the coin into the groove of the SIM card screw.
12. Turn the coin clockwise to tighten the SIM card screw.

LED indicators

Description

Each GFU housing for a radio or digital cellular phones has Light Emitting Diode (LED) indicators on the bottom side. They indicate the basic device status.

Diagram

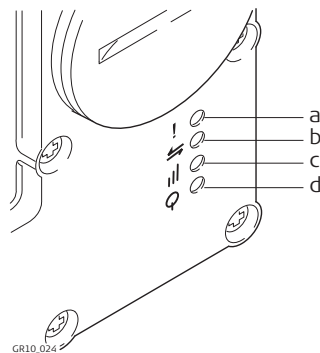

- a Mode LED, available for Satel-
line radios
- b Data transfer LED
- c Signal strength LED
- d Power LED

Description of the LEDs

IF the	on	is	THEN
Mode LED	GFU14 with Satel- line radios GFU27 with Satel- line M3- TR1 GFU30 with Satel- line M3- TR4/TR4+	red	the device is in the configur- ation mode controlled from the PC via cable.
Data transfer LED	any device	off green or flashing green	data is not being transferred. data is being transferred.

IF the	on	is	THEN
Signal strength LED	GFU19 (US) GFU25 (CAN) GFU26 (US)	red	device is on, not registered on the network.
	GFU24 with Siemens MC75	red	call is in progress.
		red: long flash, long break	no SIM card inserted, no PIN entered or network search, user authentication or network login in progress.
		red: short flash, long break	logged onto network, no call in progress.
		red: flashing red, long break	GPRS PDP context activated.
		red: long flash, short break	Packet switched data transfer is in progress.
	GFU29 with Cinterion PXS8	off	device is off.
		500 ms on and 500 ms off	LED has not been activated by the GR30/GM30/GS25.
		Flashing every 4 s	network searching or limited service due to missing SIM or PIN.
	GFU31 with Cinterion LTE PLS63-W	Flashing every 4 s	registered to network, but no data transfer in progress.
		Flashing every 2 s	packet service data transfer in progress.
		Flashing every 1 s	circuit switched data transfer in progress (GSM/UMTS only).
	GFU14 with Satelline radios	red or flashing red	the communication link, Data Carrier Detection (DCD), is okay on the roving receiver.
off		the DCD is not okay.	
GFU27 with Satelline M3-TR1			
GFU30 with Satelline M3-TR4/TR4+			
Power LED	GFU29 with Cinterion PXS8	off	power is completely off OR GSM module is shut down. 10 s power down are required to restart.
		green	power is on AND GSM module is ready.

IF the	on	is	THEN
	any other device	off	power is off.
		green	power is okay.

7.4.3

Slot-in Devices

Devices fitting into the GR30/GM30/GR50

Digital cellular phones fitting into the slot-in port (P3)



Digital cellular phone	Device
Telit 3G GSM/GPRS/UMTS	SLG12
Cinterion LTE PLS63-W	SLG31

Radios fitting into the slot-in port (P3)

Radio	Device
Satellite TA11 (TX only)	SLR-12
Satellite M3-TR1 (TX/RX)	SLR-51
Satellite M3-TR4/TR4+	SLR-61

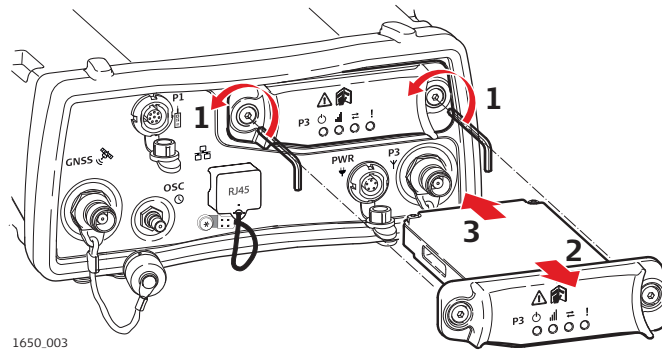
Insert and remove a slot-in-device in a GR30/GM30/GR50



- Loosen the screws of the communication slot-in port (P3) with the Allen key that is supplied with the slot-in device.
- Remove the compartment cover and attach it to the slot-in device.
- Insert the slot-in device into the P3 slot-in port.
 The LEDs on the device must point downwards.
- Tighten the screws.
 All screws have to be tightened to ensure that the instrument is waterproof.
- Attach the antenna for the slot-in device to communication slot-in port antenna (P3), which is located below the slot-in port next to the power port (PWR).

Insert and remove a SIM card step-by-step

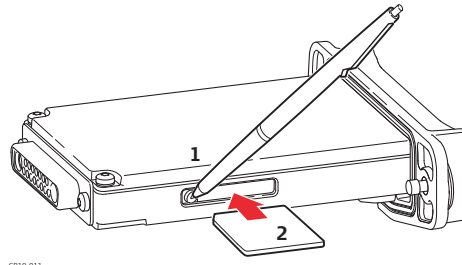

GR10_011

☞ The SIM card is inserted into a slot on the side of the slot-in-device.

☞ Take the SIM card and a pen.

1. Using the pen, press the small button of the SIM card slot to eject the SIM card holder.
2. Take the SIM card holder out of the slot-in-device.
3. Place the SIM card into the SIM card holder, the chip facing up.
4. Insert the SIM card holder into the SIM card slot, the chip facing the connectors inside the slot.

LED indicators

Description

Each slot-in-device for a radio or digital cellular phones has Light Emitting Diode (LED) indicators on the bottom side. They indicate the basic device status.

Diagram

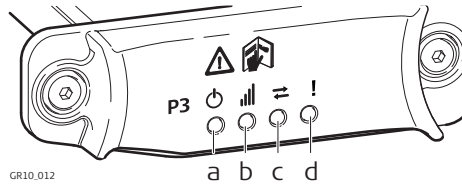

GR10_012

- a Power LED
- b Signal strength LED
- c Data transfer LED
- d Mode LED, available for Satellite TA11 (SLR1-2)

Description of the LEDs

IF the	on	is	THEN
Mode LED	SLR-12 with Satellite TA11 SLR-51 with Satellite M3-TR1	red	the device is in the programming mode controlled from the PC via cable.
Data transfer LED	any device	off flashing green	data is not being transferred. data is being transferred.
Signal strength LED	SLG12 with Telit 3G	red	call is in progress.

IF the	on	is	THEN
		red: long flash, long break	no SIM card inserted, no PIN entered or network search, user authentication or network login in progress.
		red: short flash, long break	logged on to network, no call in progress.
		red: flashing red, long break	GPRS PDP context activated.
		red: long flash, short break	Packet switched data transfer is in progress.
		off	device is off.
	SLG31 with Cinterion LTE PLS63-W	off	LED has not been activated by the GR/GM.
		500 ms on and 500 ms off	network searching or limited service due to missing SIM or PIN.
		flashing every 4 s	registered to network but no data transfer in progress.
		flashing every 2 s	packet service data transfer in progress.
		flashing every 1 s	circuit switched data transfer in progress (GSM/UMTS only).
	SLR-12 with Satellite TA11	red	the communication link, Data Carrier Detection (DCD), is okay on the roving instrument.
	SLR-51 with Satellite M3- TR1	flashing red	the communication link, Data Carrier Detection (DCD), is okay on the roving instrument, but signal is weak.
	SLR-61 with Satellite M3- TR4/TR4+	off	the DCD is not okay.
Power LED	any device	off	power is off.
		green	power is okay.

8 Care and Transport

8.1 Transport

Transport in a road vehicle

Never carry the product loose in a road vehicle, as it can be affected by shock and vibration. Always carry the product in its container and secure it.

For products for which no container is available use the original packaging or its equivalent.

Shipping

When transporting the product by rail, air or sea, always use the complete original Leica Geosystems packaging, container and cardboard box, or its equivalent, to protect against shock and vibration.

8.2 Storage

Product

Respect the temperature limits when storing the equipment, particularly in summer if the equipment is inside a vehicle. Refer to [9 Technical Data](#) for information about temperature limits.

Li-Ion batteries

- Refer to [9 Technical Data](#) for information about storage temperature range
 - Remove batteries from the product and the charger before storing
 - After storage recharge batteries before using
 - Protect batteries from damp and wetness. Wet or damp batteries must be dried before storing or use
 - A storage temperature range of 0 °C to +30 °C / +32 °F to +86 °F in a dry environment is recommended to minimize self-discharging of the battery
 - At the recommended storage temperature range, batteries containing a 40% to 50% charge can be stored for up to one year. After this storage period the batteries must be recharged
-

8.3 Cleaning and Drying

Product and accessories

- Use only a clean, soft, lint-free cloth for cleaning. If necessary, moisten the cloth with water or pure alcohol. Do not use other liquids; these may attack the polymer components.

For power supplies and chargers:

- Use only a clean, soft, lint-free cloth for cleaning.
-

Damp products

Dry the product, the transport container, the foam inserts and the accessories at a temperature not greater than 40 °C/104 °F and clean them. Remove the battery cover and dry the battery compartment. Do not repack until everything is dry. Always close the transport container when using in the field.

Cables and plugs

Keep plugs clean and dry. Blow away any dirt lodged in the plugs of the connecting cables.

Connectors with dust caps

Wet connectors must be dry before attaching the dust cap.

9

Technical Data

9.1

Labelling

Labelling GR30

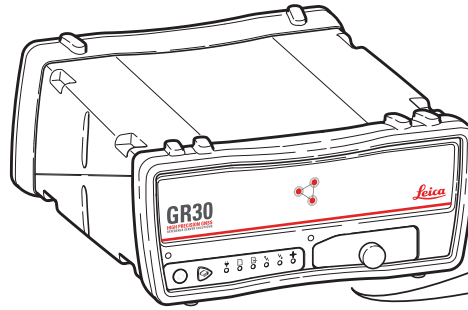

11637.003

Model: GR30 Art.No.: 123456
 Equip. No.: 12345678 S.No.: 1234567
 Leica Geosystems AG
 CH-9435 Heerbrugg
 Manufactured:
 Made in

Power: 12V - 24V --- nominal / 2.4A max.
 ETH MAC: 00 - 00 - 00 - 00 - 00 - 00 **IP68**



This device complies with part 15 of the FCC Rules. Operation is subject to the following two conditions:
 (1) This device may not cause harmful interference, and
 (2) This device must accept any interference received, including interference that may cause undesired operation.

UK CA Importer: Leica Geosystems Ltd
 Hexagon House, Michigan Drive
 Tongwell, Milton Keynes, MK15 8HT

25

Labelling GM30

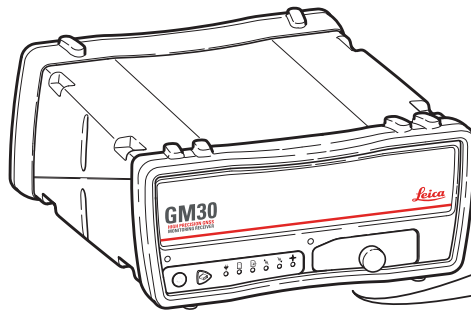

11638.003

Model: GM30 Art.No.: 123456
 Equip. No.: 12345678 S.No.: 1234567
 Leica Geosystems AG
 CH-9435 Heerbrugg
 Manufactured:
 Made in

Power: 12V - 24V --- nominal / 2.4A max.
 ETH MAC: 00 - 00 - 00 - 00 - 00 - 00 **IP68**



This device complies with part 15 of the FCC Rules. Operation is subject to the following two conditions:
 (1) This device may not cause harmful interference, and
 (2) This device must accept any interference received, including interference that may cause undesired operation.

UK CA Importer: Leica Geosystems Ltd
 Hexagon House, Michigan Drive
 Tongwell, Milton Keynes, MK15 8HT

25

Labelling GR50 (Bluetooth)

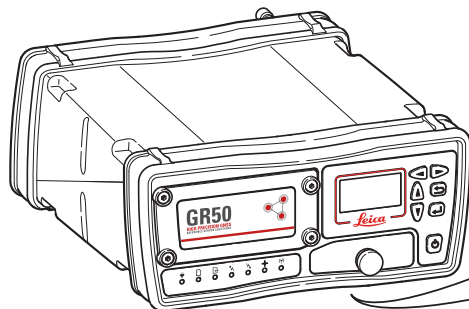

11639_003

Model: GR50 Art.No.: 123456
 Equip. No.: 12345678 S.No.: 1234567
 Leica Geosystems AG
 CH-9435 Heerbrugg
 Manufactured:
 Made in



Power: 12V - 24V --- nominal / 2.4A max.

ETH MAC: 00 - 00 - 00 - 00 - 00 - 00
 BT MAC: 00 - 00 - 00 - 00 - 00 - 00

IP68

FCC ID: RFD-GR50BT
 IC: 3177A-GR50BT



Importer: Leica Geosystems Ltd
 Hexagon House, Michigan Drive
 Tongwell, Milton Keynes, MK15 8HT



Contains transmitter module: MIC ID



R 202-LSD080
 T D15-0032 202



Labelling GR50 (WLAN)

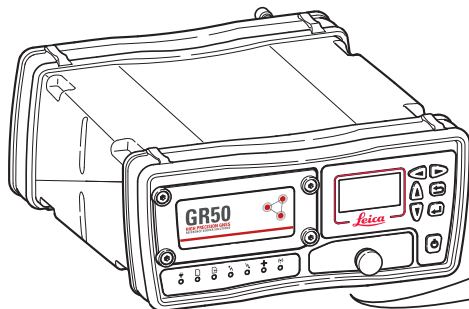

11640_004

Model: GR50 Art.No.: 123456
 Equip. No.: 12345678 S.No.: 1234567
 Leica Geosystems AG
 CH-9435 Heerbrugg
 Manufactured:
 Made in



Power: 12V - 24V --- nominal / 2.4A max.

ETH MAC: 00 - 00 - 00 - 00 - 00 - 00
 WLAN MAC: 00 - 00 - 00 - 00 - 00 - 00

IP68

FCC ID: RFD-GR50W
 IC: 3177A-GR50W



Importer: Leica Geosystems Ltd
 Hexagon House, Michigan Drive
 Tongwell, Milton Keynes, MK15 8HT



Contains transmitter module: MIC ID



R 204-810001



Labelling internal battery GEB242



004729.002

This device complies with part 15 of the FCC Rules. Operation is subject to the following two conditions: (1) This device may not cause harmful interference, and (2) this device must accept any interference received, including interference that may cause undesired operation.



Antenna

Type	Antenna	Gain [dBi]	Connector	Frequency band [MHz]
GNSS	External GNSS antenna element (receive only)	-	-	-

Frequency band

Type	Frequency band [MHz]
GR30/GM30/GR50	GPS L1: 1575.42
	GPS L2: 1227.60
	GPS L5: 1176.45
	GLONASS L1: 1598.0625 - 1609.3125
	GLONASS L2: 1242.9375 - 1251.6875
	GLONASS L3: 1202.025
	Galileo E1: 1575.42
	Galileo E5a: 1176.45
	Galileo E5b: 1207.14
	Galileo AltBOC: 1191.795
	Galileo E6: 1278.75 MHz
	BeiDou B1I: 1561.098
	BeiDou B1C: 1575.42
	BeiDou B2I: 1207.14
	BeiDou B2a: 1176.45
BeiDou B2b: 1207.14	
BeiDou B3I: 1268.52	
QZSS L1: 1575.42	
QZSS L2: 1227.60	
QZSS L5: 1176.45	
L-Band: 1545 to 1560	

Output power

Type	Output power [mW]
GNSS	Receive only

Changes or modifications not expressly approved by Leica Geosystems for compliance could void the user's authority to operate the equipment.

Canada

CAN ICES-003 Class B/NMB-003 Class B

WARNING

This Class (B) digital apparatus complies with Canadian ICES-003. Cet appareil numérique de la classe (B) est conforme à la norme NMB-003 du Canada.

Canada Compliance Statement

This device contains licence-exempt transmitter(s)/receiver(s) that comply with Innovation, Science and Economic Development Canada's licence-exempt RSS(s). Operation is subject to the following two conditions:

1. This device may not cause interference.
2. This device must accept any interference, including interference that may cause undesired operation of the device.

Canada Déclaration de Conformité

L'émetteur/récepteur exempt de licence contenu dans le présent appareil est conforme aux CNR d'Innovation, Sciences et Développement économique Canada applicables aux appareils radio exempts de licence. L'exploitation est autorisée aux deux conditions suivantes:

1. L'appareil ne doit pas produire de brouillage;
2. L'appareil doit accepter tout brouillage radioélectrique subi, même si le brouillage est susceptible d'en compromettre le fonctionnement.

Japan

- This device is granted pursuant to the Japanese Radio Law (電波法).
- This device should not be modified (otherwise the granted designation number will become invalid).

Others

The conformity for countries with other national regulations has to be approved prior to use and operation.

Instrument technology

Leica patented SmartTrack+ technology

- Advanced measurement engine generation 7 (555 universal tracking channels, flexible number of signals per satellite, more than 140 satellites multifrequency)
- Resilient signal tracking and interference mitigation technology ensuring consistent, accurate and reliable GNSS multi-frequency measurements even in challenging environments
- Automatically detects and notifies about relevant signal interference
- Industry leading Pulse Aperture Correlator (PAC) multipath mitigation technology for superior quality measurements
- Excellent low elevation tracking
- Very low noise GNSS carrier phase measurements with < 0.5 mm precision
- Minimum acquisition time

Tracking satellite signals

The following satellite signals are tracked¹⁾:

- GPS²⁾: L1 C/A, L1C, L2P(Y), L2C, L5
- GLONASS²⁾: L1, L2P, L2C, L3
- Galileo: E1, E5a, E5b, E5ab (AltBOC), E6
- BeiDou: B1I, B1C, B2I, B2a, B2b, B3I
- QZSS²⁾: L1 C/A, L1C, L2C, L5
- NavIC: L5
- SBAS: L1²⁾ from WAAS, EGNOS, GAGAN, MSAS

Time for initial acquisition of signals

Cold start³⁾ < 39 s (typical)

Hot start⁴⁾ < 20 s (typical)

Time for reacquisition of signals

L1 < 0.5 s (typical)

L2 < 1.0 s (typical)

¹⁾ The hardware is prepared for new signals and is designed for BeiDou Phase 2, Phase 3, B1, B2, B3 and Galileo commercial service compatibility. The firmware will be enhanced to support new signals as soon as the officially published signal interface control documentation (ICD) becomes available and the systems operational constellation allows for commercial practical use. Generally, the tracking capability for a specific satellite system is based on publicly available information. For cases where public information is subject to change or not yet available, Leica Geosystems cannot guarantee that these receivers will be fully compatible with a future generation of satellites or signals.

²⁾ GPS L1P(Y), GLONASS L1P, L5 CDMA, QZSS L6 and SBAS L5 can be provided through future firmware upgrade.

³⁾ Typical value. No almanac or ephemerides and no approximate position or time.

⁴⁾ Typical value. Almanac and recent ephemerides saved and approximate position and time entered.

Sensitivity

Initial acquisition (cold): 35⁵⁾ dB-Hz

Initial acquisition (hot): 35⁶⁾ dB-Hz

Reacquisition: 31 dB-Hz

Tracking GNSS: 28⁷⁾ dB-Hz

GPS Carrier tracking

Condition	GR30/GM30/GR50
L1, AS off or on	Reconstructed carrier phase via C/A-code.
L2, AS off	Reconstructed carrier phase via P2-code.
L2, AS on	Switches automatically to patented P-code aided technique providing full L2 reconstructed carrier phase.

GPS code measurements

Condition	GR30/GM30/GR50
L1, AS off	Code measurements: C/A-code.
L1, AS on	
L2, AS off	Code measurements: P2-code and/or L2C code.
L2, AS on	Code measurements: Patented P-code aided code and/or L2C code.

Code smoothing using carrier phase measurements is optional.

Interference monitoring and mitigation

The receiver continuously measures and monitors the relevant frequency spectrum for unwanted interference at user definable sensitivity. The automatic detection and notification about potential interference assist the administrator to take informed decisions.

The SmartTrack+ Advanced Interference Mitigation option offers resilient signal tracking ensuring reliable GNSS multi-frequency operation even in challenging environments.

The radio frequency power spectrum levels can be measured and output at configurable density and update rate for all GNSS bands.

Leica Interference Toolbox desktop software allows to easily monitor, quantify and enable mitigation options on the receiver to remove interference sources impacting the receiver performance.

9.2.2

Measurement Precision and Position Accuracy



Measurement precision, accuracy in position and height, reliability and time for initialisation are dependent upon various factors including the number of satellites tracked, the observation time, the ephemeris accuracy, the atmo-

⁵⁾ Applies to GPS, for all other 41 dB-Hz

⁶⁾ Applies to GPS, for all other 39 dB-Hz

⁷⁾ Applies to Non-Galileo, for Galileo 31 dB-Hz

spheric conditions, multipath and resolved ambiguities. Figures quoted assume normal to favourable conditions.

The following accuracies, given as root mean square (rms), are based on measurements processed using receiver firmware, LEICA Geo Office, LEICA Infinity and the Bernese Software.

The use of multiple GNSS systems can increase accuracy by up to 30% relative to GPS only.

GNSS measurements

Fully independent code and phase measurements of all frequencies.

	Phase	Code
Precision ⁸⁾ GPS L1/L2/L5	0.2 mm rms	20 mm rms
Resolution	0.01 mm	0.0005 m

Resolution of Carrier to Noise ratio (C/No): 0.05 dB-Hz

Accuracy (rms) single receiver navigation mode

Navigation accuracy 5-10 m rms for each coordinate.

Degradation possible due to Selective Availability.

Leica VADASE - Velocity & Displacement Engine

- Velocity accuracy: 0.003 m/s rms horizontal, 0.005 m/s rms vertical.
- Typical velocity derived displacement sensitivity: 1 cm/s horizontal, 2 cm/s vertical.
- Velocity Limit: 515 m/s.
(Export licensing restricts operation to a maximum of 515 m/s)

Accuracy in differential code mode

Typical position accuracy of a differential code solution for static and kinematic surveys:

- SBAS (GPS-only): 0.6 m
- DGNSS: 0.25 m + 1 ppm (horizontal), 0.5 m + 1 ppm (vertical)

Accuracy in differential phase mode

Accuracy (rms) with Post-Processing⁹⁾		
	Horizontal	Vertical
Static (phase) with long observations	3 mm + 0.1 ppm	3.5 mm + 0.4 ppm
Static and rapid static (phase)	3 mm + 0.5 ppm	5 mm + 0.5 ppm
Kinematic (phase)	8 mm + 1 ppm	15 mm + 1 ppm

Accuracy (rms) with Real-Time (RTK)⁹⁾	
Standard of compliance	Compliance with ISO17123-8

⁸⁾ For satellites with C/No higher than 42 dB-Hz; Galileo and BeiDou values are expected to be similar.

⁹⁾ Additional signals from modernised GNSS and a full constellation of emerging satellites such as BeiDou and Galileo will further increase measurement performance and accuracy.

Accuracy (rms) with Real-Time (RTK)¹¹⁾						
Site Monitor Positioning Modes ¹⁰⁾	Reference Station		Monitoring		Network RTK Rover	
(Horizontal/Vertical)	H	V	H	V	H	V
Single Baseline (<30 km)	6 mm + 1 ppm	10 mm + 1 ppm	8 mm + 1 ppm	15 mm + 1 ppm	8 mm + 1 ppm	15 mm + 1 ppm
Network RTK	6 mm + 0.5 ppm	10 mm + 0.5 ppm	8 mm + 0.5 ppm	15 mm + 0.5 ppm	8 mm + 0.5 ppm	15 mm + 0.5 ppm
Sampling	Smoothed		Instantaneous		Instantaneous	
On-the-fly (OTF) initialisation						
RTK technology	Leica SmartCheck technology					
Reliability of OTF initialisation ¹¹⁾	≥ 99.999%		≥ 99.999%		≥ 99.99%	
Time for initialisation (typ.) ¹²⁾	10 seconds		10 seconds		4 seconds	
OTF range ¹²⁾	Up to 80 km		Up to 70 km		Up to 70 km	
Network RTK						
Network technology	Leica SmartRTK technology					
Supported RTK network solutions	VRS, FKP, i-MAX					
Supported RTK network standards	MAC (Master Auxiliary Concept) approved by RTCM SC104					

¹¹⁾ Additional signals from modernised GNSS and a full constellation of emerging satellites such as BeiDou and Galileo will further increase measurement performance and accuracy.

¹⁰⁾ Three positioning modes are available:

–**Reference Station:** This mode is designed for monitoring the stability of the antenna position of a reference station. It is optimized for long baselines as used within RTK networks. Movements will be detected with a high reliability while the positioning results are smoothed to prevent outliers from triggering false alarms.

–**Monitoring:** In this mode the position calculation is optimized for monitoring applications with short baselines. Positioning results are less smoothed than in Reference Station mode as outliers are less likely. Therefore, a position change may be detected slightly faster than in Reference Station mode.

–**Network RTK:** In this mode the position calculation will behave as on a real rover.

¹²⁾ Might vary due to atmospheric conditions, signal multipath, obstructions, signal geometry and number of tracked signals.



The mentioned accuracy values for post-processing are based on using the LEICA Geo Office and LEICA Infinity. Using specialist scientific software (Bernese) available from Leica Geosystems, the following accuracies can be achieved in static post-processing mode, even on very long baselines:

- 2–4 mm in plan
- 3–6 mm in height

9.2.3

Technical Data

Dimensions

The dimensions are given for the housing without the sockets.

GR30/ GM30/GR50	Length [cm]	Width [cm]	Thickness [cm]
Without bumpers	21.0	19.0	7.8
With bumpers	22.0	20.0	9.4

Drill hole dimensions for holder

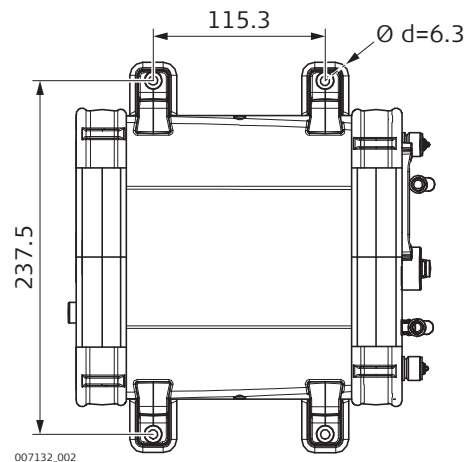

Weight

GR30/GM30 weight:

Type	Weight [kg]
Without bumpers	1.50
With bumpers	1.67

GR50 weight:

Type	Weight [kg]
Without battery*	1.84
With battery*	2.29

* With bumpers

Data capacity all receivers

Data can be recorded on the SD cards.

The figures shown are accurate to about 1%. They depend on the tracking settings configured on the instrument and are valid for all receivers.

8 GB card, GPS (L1+L2), 12 satellites

Rate [s]	MDB only [h]	RINEX v2 only [h]	RINEX v2 Hatanaka only [h]	RINEX v3 only [h]	RINEX v3 Hatanaka only [h]
1	6000	1430	5200	1450	5200
	9000*	5000*	14300*	5000*	14400*
30	169200	41500	112200	42100	119300
	222200*	130400*	312200*	130300*	316600*

* Size when zipped

8 GB card, GPS + GLONASS (L1+L2), 12/10 satellites

Rate [s]	MDB only [h]	RINEX v2 only [h]	RINEX v2 Hatanaka only [h]	RINEX v3 only [h]	RINEX v3 Hatanaka only [h]
1	3300	780	2900	800	2900
	4900*	2700*	7800*	2700*	7900*
30	92600	22400	63900	23100	64800
	119500*	70800*	168200*	70700*	170300*

* Size when zipped

8 GB card, GPS + GLONASS + BDS (B1+B2), 12/10/12 satellites

Rate [s]	MDB only [h]	RINEX v2 only [h]	RINEX v2 Hatanaka only [h]	RINEX v3 only [h]	RINEX v3 Hatanaka only [h]
1	2100	-	-	520	1900
	3200*			1750*	5100*
30	59800	-	-	14900	42000
	77700*			45800*	110700*

* Size when zipped

8 GB card, GPS + GLONASS + Galileo (E1+E5a+E5b+AltBOC), 12/10/10 satellites

Rate [s]	MDB only [h]	RINEX v2 only [h]	RINEX v2 Hatanaka only [h]	RINEX v3 only [h]	RINEX v3 Hatanaka only [h]
1	1840	420	1590	430	1610
	2600*	1460*	4200*	1460*	4300*
30	50300	12200	34700	12500	35200
	64900*	38500*	91400*	38400*	92500*

* Size when zipped

8 GB card, GPS + GLONASS + Galileo + BDS (B1+B2), 12/10/10/12 satellites

Rate [s]	MDB only [h]	RINEX v2 only [h]	RINEX v2 Hatanaka only [h]	RINEX v3 only [h]	RINEX v3 Hatanaka only [h]
1	1410 2000*	–	–	330 1130*	1230 3300*
30	38700 50200*	–	–	9600 29600*	27200 71600*

* Size when zipped

Power

24 V Power supply

GR30/GM30 power consumption: 3.5 W typically, 24 V@145 mA

GR50 power consumption: 3.1 W typically, 24 V@130 mA

External supply voltage: Nominal 24 V DC, voltage range 10.5 V to 28 V DC

Batteries

	GR30	GR50
Battery internal	–	●
Battery external	●	●
Internal charger	–	●
Type	–	GEB242

Internal

Type (GEB242) Rechargeable Li-Ion battery.
 Voltage 14.8 V
 Capacity GEB242: 5.8 Ah/85.8 Wh
 Weight 0.41 kg
 Operation time Powers receiver plus antenna for up to 22/27 hours.

External

	GEB171	GEB373
Type	Rechargeable NiCd	Rechargeable Li-Ion
Voltage	12 V	14.4 V
Capacity	9.0 Ah/108 Wh	20.1 Ah/298 Wh
Weight	2.1 kg	2.0 kg
Operation time	Powers receiver plus antenna for about 27–35 hours.	Powers receiver plus antenna for about 75–93 hours.
Uninterruptible Power Supply (UPS)		Use with 833 864 GEV277 Y-cable and 774 437 GEV242 charger

Connector types

Port	Description
PWR	LEMO-1 female, 5 pin
Serial P1	LEMO-1 female, 8 pin
Serial P2 / Event *	LEMO-1 female, 8 pin
GNSS antenna	TNC female
P3 slot-in antenna	TNC female
Oscillator	MMCX female, 24QMA-50 2-3/133, 5/10 MHz
Ethernet	RJ45 ruggedised, 10/100 Mbit
PPS *	LEMO ERN.OS.250.CTL
USB client	Type Mini B
Bluetooth/WLAN antenna *	RP-SMA Female
USB host *	Standard Type A

* GR50 only

Power port

All receivers

Description	5 pin LEMO supporting dual power inputs
Connector	LEMO-1, 5 pin, LEMO HMG.1B.305.CLNP

Serial ports

Port	Description	Default setting
P1	Baud rates 2400-115200 baud, incl. RTS/CTS	115200/N/8/1/N
P2 (GR50 only)	Baud rates 2400-115200 baud, incl. RTS/CTS	115200/N/8/1/N

Data output

- Raw Data
- Almanac
- Ephemeris
- Position data

USB client port

Support:	USB 2.0
Speed:	Full speed, 12 Mbit/s (1,5 MB/s)

USB host port

GR50 only:

Support:	USB 2.0 *
Speed:	High speed, 480 Mbit/s (60 MB/s)
Output power:	500 mA (5 V) => Support devices up to 2.5 W

* If USB 3.0 data mass storage devices do fully comply with USB 2.0 standard, they are also supported.

External oscillator

Frequency:	5 MHz or 10 MHz
Input impedance:	50 Ω nominal
Input VSWR:	2:1 maximum

Signal level:	0 dBm minimum to +10.0 dBm maximum
Frequency stability:	±0.5 ppm maximum
Wave shape:	Sinusoidal
Connector:	MMCX female - 24QMA-50-2-3/133

 On the GR30/GR50, remove the External oscillator port cover before connecting the cable.

 Internal Oscillator aligned to GPS time within 20 ns.

Pulse Per Second (PPS)*

GR50 only

Peak	5 V DC = High
Impedance	50 Ω nominal
Pulse length	1 ms
	Leading edge coinciding with the beginning of each epoch
Positive/negative edge	Selectable via Web interface.
Cable connectivity	Matched with an appropriate impedance of 50 Ω
Connector	LEMO ERN.OS.250.CTL

* PPS pulse typically accurate to 20 ns

Ethernet network interface

All receivers

IEEE Standards:	802.3 10BASE-T Ethernet 802.3u 100BASE-TX Fast Ethernet 802.3 Auto-negotiation
Link Speed:	10/100 MB, Half/Full Duplex
Protocol:	CSMA/CD
Connector:	Ruggedised RJ45

Simple Network Management Protocol (SNMP)

SNMP is an Internet-standard protocol for managing devices on IP networks. It can be used in network management systems to monitor receivers for conditions that warrant administrative attention. It can also be used to monitor other IP based network devices like routers, switches or modems, as many modern network devices support the SNMP protocol. This means that by using SNMP protocol all the devices of the network infrastructure (communication devices and GNSS receivers) can be monitored if they support SNMP. This may help in tracking down network issues, like malfunctioning routers, bandwidth issues and other problems that may affect the availability and reliability of GNSS network services.

GR/GM receivers support SNMP versions v1, v2p and v2c.

Bluetooth

Type:	Bluetooth 2.0
Enhanced Data Rate:	EDR maximum 2.1 Mbits/s
Connector:	SMA male

WLAN

Type (single stream):	IEEE 802.11 b/d/g/n
Band support:	Station Mode: 2.4 GHz, channel 1-13*
Network authentication:	Open, Shared, WPA-PSK (no server), WPA2-PSK (no server)
Encryption type:	Disabled, WEP, TKIP, AES
Maximum radiated output power:	17 dBi EIRP**
Connector:	SMA male

* Maximum supported channels for IEEE82.11 d depends on region.

** RF power including maximum antenna gain (2 dBi).

9.3

Environmental Specifications

Environmental specifications

Temperature

Type	Operating temperature [°C]	Storage temperature [°C]
Instrument	-40 to +65	-40 to +80
Leica SD cards	-40 to +85	-40 to +100
GEB242	-20 to +75	-40 to +70
GEV242	-20 to +60	-40 to +85

Protection against water, dust and sand

Type	Protection
Instrument	IP68 (IEC 60529) Dust tight Protected against continuous immersion in water. Tested for 2 h in 1.40 m depth.
GEB242	IP54 (IEC 60529) Dust protected Protection against splashing water from any direction
GEV242	For indoor use only

Humidity

Type	Protection
Instrument	Up to 100% The effects of condensation are to be effectively counteracted by periodically drying out the instrument.
GEV242	For indoor use only

9.4

Antennas Technical Data

Description and use

The antenna is selected for use based upon the application. The table gives a description and the intended use of the individual antennas.

Type	Description	Use
AR25	GPS, GLONASS, Galileo, BeiDou, QZSS, NavIC, L-Band antenna, using a classical Dorne & Margoline element with a 3D choke ring ground plane. Optional protective radome.	High end applications, including all reference station and monitoring. Especially good for scientific studies where excellent low elevation tracking is required.
AR20	GPS, GLONASS, Galileo, BeiDou, QZSS, NavIC, L-Band reference station and monitoring antenna using an innovative planar quad-feed radiating element with a gold choke ring ground plane. Optional protective radome.	High end applications, including all reference station and monitoring. Especially suited for Network RTK, where excellent multipath rejection and the best phase centre stability is required.
AR10	GPS, GLONASS, Galileo, BeiDou, QZSS, NavIC, L-Band reference station and monitoring antenna using an innovative planar quad-feed radiating element with a large ground plane and built-in radome.	General use for standard and high accuracy reference station and monitoring applications.
AS11	Compact geodetic GPS, GLONASS, Galileo, BeiDou, QZSS, NavIC antenna with a built-in ground plane.	Standard Network RTK and monitoring applications.

Dimensions

Type	AR25	AR20	AR10	AS11
Height [cm]	20.0	16.3	14.0	6.0
Diameter [cm]	38.0	32.0	24.0	16.5

Connector

AR25:	N-Type female, with TNC adapter supplied
AR20:	N-Type female, with TNC adapter supplied
AR10:	TNC female
AS11:	TNC female

Mounting

All antennas:	5/8" Whitworth Thread
---------------	-----------------------

SECO 2072-33 Adjustable Tilt Monument Mount accessory characteristics:

- Suitable for Male 5/8 × 11 TPI screw thread
- Diameter: 3.20 inch (8.19 cm)
- Overall heights: 3.036 inch (7.71 cm)
- Weight: 6.32 lb (2.87 kg)
- Includes a removable brass 5/8 × 11 male stud adjustable in azimuth and held in location by two set screws
- Allow levelling by three screws with a tilt range $\pm 7^\circ$
- Height above the pivot point to the stud shoulder is 1.37 inch (3.50 cm)
- Height below the brass 5/8 stud to the shoulder is 0.463 inch (1.18 cm)
- Axis height is engraved on the outside of the monuments

Weight

AR25:	8.1 kg, radome 1.1 kg
AR20	5.9 kg, radome 0.9 kg
AR10:	1.1 kg
AS11:	0.44 kg

Electrical data and characteristics

Type	AR25	AR20	AR10	AS11
Voltage ¹³⁾ [V DC]	3.3–12	3.3–12	3.3–12	3.8–18
Current max (@5V) [mA]	150 (100 mA typical)	100	100	60
Nominal impedance [Ω]	50	50	50	50
Frequency:				
GPS	L1, L2 (including L2C), L5	L1, L2 (including L2C), L5	L1, L2 (including L2C), L5	L1, L2 (including L2C), L5
GLONASS	L1, L2, L3, L5	L1, L2, L3, L5	L1, L2, L3, L5	L1, L2, L3, L5
Galileo	E2-L1-E1, E5a, E5b, E5a+b (AltBOC), E6	E2-L1-E1, E5a, E5b, E5a+b (AltBOC), E6	E2-L1-E1, E5a, E5b, E5a+b (AltBOC), E6	E2-L1-E1, E5a, E5b, E5a+b (AltBOC), E6
BeiDou	B1, B2, B3	B1, B2, B3	B1, B2, B3	B1, B2, B3
QZSS:	L1, L1C, L2C, L5, L1-SAIF, L6	L1, L1C, L2C, L5, L1-SAIF, L6	L1, L1C, L2C, L5, L1-SAIF, L6	L1, L1C, L2C, L5, L1-SAIF, L6
NavIC	L5	L5	L5	L5
L-Band	SBAS, OmniSTAR, Veripos, CDSGPS	SBAS, OmniSTAR, Veripos, CDSGPS	SBAS, OmniSTAR, Veripos, CDSGPS	SBAS, OmniSTAR, Veripos, CDSGPS
Minimum tracking elevation [degree]	0	0	0	0

¹³⁾ Typically supplied directly from the GNSS receiver or through a powered antenna splitter, using an antenna cable connection.

Type	AR25	AR20	AR10	AS11
Practical tracking elevation [degree]	> 3	> 5	> 3	> 3
LNA Gain [dB] (typ.)	40	29/40 ¹⁴⁾	29/40 ¹⁴⁾	29
Noise Figure [dB] (typ.)	< 1.2 max	< 2	< 1.8	< 2
Phase Center Repeatability [mm] (typ.)	< 1	< 1	< 1	< 1
Phase Center Accuracy [mm] (typ.)	< 2	< 1	< 2	< 2
Axial ratio [dB] (at zenith)	< 1.5	< 1.2	< 1.4	< 0.8
Group Delay Variation [ns] (typ.)	< 6	< 7	< 7	≤ 5
VSWR	1.5:1	1.8:1	2.0:1	2.0:1
Polarisation	RHCP	RHCP ¹⁵⁾	RHCP	RHCP
Mounting thread ["] (female)	5/8	5/8	5/8	5/8
Connector	N ¹⁶⁾	N ¹⁶⁾	TNC	TNC

Lightning protection

Type	Protection
AR10 & AR20	Integrated three stages surge protector to comply with at least 4 kV surge waveform (IEC 61000-4-5 class 4 voltage level)
	In-line surge protectors close to the antenna and the receiver are still recommended and required.

Environmental specifications

Temperature

Type	Operating temperature [°C]	Storage temperature [°C]
AR25	-55 to +85	-55 to +90
AR20	-55 to +85	-55 to +85
AR10	-40 to +70	-55 to +85
AS11	-40 to +70	-55 to +85

Operating temperatures in compliance with ISO9022-10-08, ISO9022-11-05 and MIL-STD-810G, Method 502.5-II, MIL-STD-810G, Method 501.5-II

Storage temperatures in compliance with ISO9022-10-08, ISO9022-11-06 and MIL-STD-810G, Method 502.5-I, MIL-STD-810G, Method 501.5-I

¹⁴⁾ Optionally available as sales variant on request.

¹⁵⁾ LHCP-Variant available on demand.

¹⁶⁾ N to TNC adapter is included.

Protection against water, dust and sand

Type	Protection
AR25, AR20, AR10	IP67 (IEC 60529) Dust tight, protected against water jets Waterproof to 1 m temporary immersion
AS11	Rain, dust, sand and wind: IP68 and IP69K

Humidity

Type	Protection
AR25, AR20, AR10	Up to 100 % Compliance with ISO9022-13-06, ISO9022-12-04 and MIL-STD-810G Method 507.5-I
AS11	95% (IEC 60068-2-30:1999)

Cable length

	Available cable lengths for all antennas [m]	Attenuation [dB/100 m]
Coaxial (5 mm)	1.2, 2.8 and 10	71.00 ¹⁷⁾
Coaxial (11 mm)	2, 10, 30, 50 and 70	16.60 ¹⁸⁾

 The Leica AR20/AR10 antennas are suitable for use with antenna cables of up to 70 m length without the need for an in-line amplifier. The AR25 antenna and 40 dB variants of AR20/AR10 antennas can be used with even longer cables, depending on the type of cable. For information about custom type and length cables, attenuator or amplifier please contact your local Leica Geosystems representative.

¹⁷⁾ Frequency 1,5 GHz, nominal, sea level 25 °C ambient temperature.

¹⁸⁾ Frequency 1,5 GHz, nominal, sea level 20 °C ambient temperature.

9.5 Conformity to National Regulations

9.5.1 For GR30, GM30 and GR50

EU



Hereby, Leica Geosystems AG declares that the radio equipment type GR30, GR50, GM30, AR10, AR20, AR25, AS11 is in compliance with Directive 2014/53/EU and other applicable European Directives.

The full text of the EU declaration of conformity is available at the following Internet address: <http://www.leica-geosystems.com/ce>.

9.5.1.1 For GR50 only

USA

FCC ID: For GR50BT: RFD-GR50BT
For GR50W: RFD-GR50W

FCC Part 15, Part 15B, 15C

This equipment has been tested and found to comply with the limits for a Class B digital device, pursuant to part 15 of the FCC Rules.

These limits are designed to provide reasonable protection against harmful interference in a residential installation.

This equipment generates, uses, and can radiate radio frequency energy and, if not installed and used in accordance with the instructions, it may cause harmful interference to radio communications.

However, there is no guarantee that interference does not occur in a particular installation.

If this equipment does cause harmful interference to radio or television reception, which can be determined by turning the equipment off and on, the user is encouraged to try to correct the interference by one or more of the following measures:

- Reorient or relocate the receiving antenna.
 - Increase the separation between the equipment and the receiver.
 - Connect the equipment into an outlet on a circuit different from that to which the receiver is connected.
 - Consult the dealer or an experienced radio/TV technician for help.
-

Changes or modifications not expressly approved by Leica Geosystems for compliance could void the user's authority to operate the equipment.

Canada

CAN ICES-003 Class B/NMB-003 Class B

IC: For GR50BT: IC: 3177A-GR50BT
For GR50W: IC: 3177A-GR50W

Canada Compliance Statement

This device contains licence-exempt transmitter(s)/receiver(s) that comply with Innovation, Science and Economic Development Canada's licence-exempt RSS(s). Operation is subject to the following two conditions:

1. This device may not cause interference
2. This device must accept any interference, including interference that may cause undesired operation of the device

Canada Déclaration de Conformité

L'émetteur/récepteur exempt de licence contenu dans le présent appareil est conforme aux CNR d'Innovation, Sciences et Développement économique Canada applicables aux appareils radio exempts de licence. L'exploitation est autorisée aux deux conditions suivantes:

1. L'appareil ne doit pas produire de brouillage
2. L'appareil doit accepter tout brouillage radioélectrique subi, même si le brouillage est susceptible d'en compromettre le fonctionnement

Japan

- This device is granted pursuant to the Japanese Radio Law (電波法).
- This device should not be modified (otherwise the granted designation number will become invalid).

Others

The conformity for countries with other national regulations has to be approved prior to use and operation.

9.5.1.2

For GR30 and GM30 only

Conformity to national regulations

For products without radio transmitter or receiver:

- FCC Part 15B (applicable in US)

This equipment has been tested and found to comply with the limits for a Class B digital device, pursuant to part 15 of the FCC Rules.

These limits are designed to provide reasonable protection against harmful interference in a residential installation.

This equipment generates, uses, and can radiate radio frequency energy and, if not installed and used in accordance with the instructions, it may cause harmful interference to radio communications.

However, there is no guarantee that interference does not occur in a particular installation.

If this equipment does cause harmful interference to radio or television reception, which can be determined by turning the equipment off and on, the user is encouraged to try to correct the interference by one or more of the following measures:

- Reorient or relocate the receiving antenna.
- Increase the separation between the equipment and the receiver.
- Connect the equipment into an outlet on a circuit different from that to which the receiver is connected.
- Consult the dealer or an experienced radio/TV technician for help.

Changes or modifications not expressly approved by Leica Geosystems for compliance could void the user's authority to operate the equipment.

Canada

CAN ICES-003 Class B/NMB-003 Class B

Others

The conformity for countries with other national regulations has to be approved prior to use and operation.

Labelling

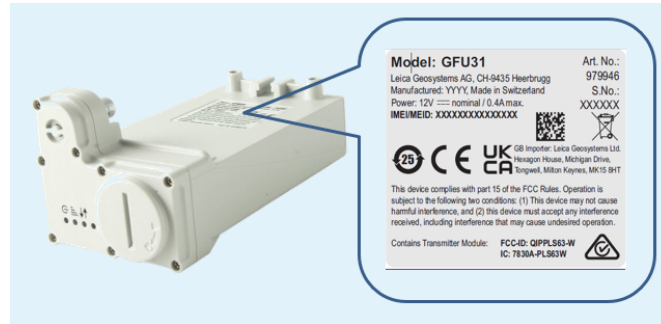

Antenna

GAT33 ¹⁹⁾	
Frequency band [MHz]	698 – 960 1710 - 2400 2496 - 2690
Type	Detachable $\lambda/2$ antenna
Connector	TNC

Frequency bands, output power

Type	Frequency band [MHz]	Output power ²⁰⁾ [dBm]	Country restrictions
LTD-FDD	700 / 800 / 850 / 900 / 1800 / 1900 / 2100 / 2600	Typ. 0.20 W	
LTD-TDD	2300 / 2500 / 2600	Typ. 0.20 W	
UMTS/HSPA (WCDMA/FDD)	850 / 900 / 1800 / 1900 / 2100	Typ. 0.22 W	
EGSM Quad Band	850 / 900	Typ. 2 W (EDGE: 0.5 W)	
GSM Quad Band	1800 / 1900	Typ. 1 W (EDGE: 0.4 W)	
GPRS/EDGE	Multi-slot class 12	-	

Specific Absorption Rate (SAR)

The product meets the limits for the maximum permissible exposure of the guide-lines and standards which are force in this respect. The product must be used with the recommended antenna. A separation distance of at least 20 cm centimetres should be kept between the antenna and the body of the user or nearby person within the intended application.

¹⁹⁾ When using the GAT33 antenna stand-alone, i.e. not mounted directly to the device but used with extension cable, the user shall ensure that the cable has a minimum of 2 dB attenuation for regulatory compliance.

²⁰⁾ Conducted power for mobile technologies and EIRP for other technologies.

EU



Hereby, Leica Geosystems AG declares that the radio equipment type GFU31 is in compliance with Directive 2014/53/EU and other applicable European Directives.
The full text of the EU declaration of conformity is available at the following Internet address: <http://www.leica-geosystems.com/ce>.

USA

Contains FCC ID: QIPPLS63-W
FCC Part 15B, 22H, 24E, 27, 90

This equipment has been tested and found to comply with the limits for a Class B digital device, pursuant to part 15 of the FCC Rules.

These limits are designed to provide reasonable protection against harmful interference in a residential installation.

This equipment generates, uses, and can radiate radio frequency energy and, if not installed and used in accordance with the instructions, it may cause harmful interference to radio communications.

However, there is no guarantee that interference does not occur in a particular installation.

If this equipment does cause harmful interference to radio or television reception, which can be determined by turning the equipment off and on, the user is encouraged to try to correct the interference by one or more of the following measures:

- Reorient or relocate the receiving antenna.
- Increase the separation between the equipment and the receiver.
- Connect the equipment into an outlet on a circuit different from that to which the receiver is connected.
- Consult the dealer or an experienced radio/TV technician for help.

Changes or modifications not expressly approved by Leica Geosystems for compliance could void the user's authority to operate the equipment.

Canada

CAN ICES-003 Class B/NMB-003 Class B
IC: 7830A-PLS63W

Canada Compliance Statement

This device contains licence-exempt transmitter(s)/receiver(s) that comply with Innovation, Science and Economic Development Canada's licence-exempt RSS(s). Operation is subject to the following two conditions:

1. This device may not cause interference
2. This device must accept any interference, including interference that may cause undesired operation of the device

Canada Déclaration de Conformité

L'émetteur/récepteur exempt de licence contenu dans le présent appareil est conforme aux CNR d'Innovation, Sciences et Développement économique Canada applicables aux appareils radio exempts de licence. L'exploitation est autorisée aux deux conditions suivantes:

1. L'appareil ne doit pas produire de brouillage
2. L'appareil doit accepter tout brouillage radioélectrique subi, même si le brouillage est susceptible d'en compromettre le fonctionnement

Others

The conformity for countries with other national regulations has to be approved prior to use and operation.

9.5.3

SLG31, Cinterion LTE PLS63-W

Labelling

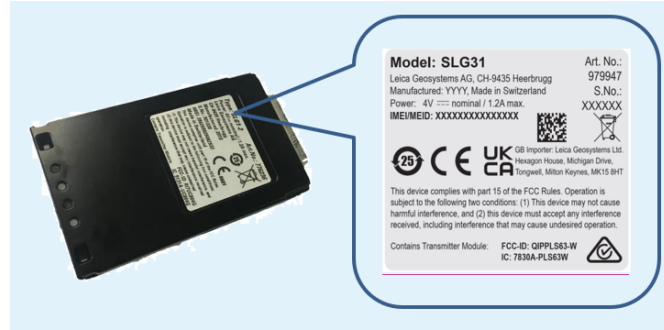

Antenna

GAT33²¹⁾	
Frequency band [MHz]	698 – 960 1710 - 2400 2496 - 2690
Type	Detachable $\lambda/2$ antenna
Connector	TNC

Frequency bands, output power

Type	Frequency band [MHz]	Output power²²⁾ [dBm]	Country restrictions
LTD-FDD	700 / 800 / 850 / 900 / 1800 / 1900 / 2100 / 2600	Typ. 0.20 W	
LTD-TDD	2300 / 2500 / 2600	Typ. 0.20 W	
UMTS/HSPA (WCDMA/FDD)	850 / 900 / 1800 / 1900 / 2100	Typ. 0.22 W	
EGSM Quad Band	850 / 900	Typ. 2 W (EDGE: 0.5 W)	
GSM Quad Band	1800 / 1900	Typ. 1 W (EDGE: 0.4 W)	
GPRS/EDGE	Multi-slot class 12	-	

Specific Absorption Rate (SAR)

The product meets the limits for the maximum permissible exposure of the guide-lines and standards which are force in this respect. The product must be used with the recommended antenna. A separation distance of at least 20 cm

²¹⁾ When using the GAT33 antenna stand-alone, i.e. not mounted directly to the device but used with extension cable, the user shall ensure that the cable has a minimum of 2 dB attenuation for regulatory compliance.

²²⁾ Conducted power for mobile technologies and EIRP for other technologies.

centimetres should be kept between the antenna and the body of the user or nearby person within the intended application.

EU



Hereby, Leica Geosystems AG declares that the radio equipment type SLG31 is in compliance with Directive 2014/53/EU and other applicable European Directives.
The full text of the EU declaration of conformity is available at the following Internet address: <http://www.leica-geosystems.com/ce>.

USA

Contains FCC ID: QIPPLS63-W
FCC Part 15B, 22H, 24E, 27, 90

This equipment has been tested and found to comply with the limits for a Class B digital device, pursuant to part 15 of the FCC Rules.

These limits are designed to provide reasonable protection against harmful interference in a residential installation.

This equipment generates, uses, and can radiate radio frequency energy and, if not installed and used in accordance with the instructions, it may cause harmful interference to radio communications.

However, there is no guarantee that interference does not occur in a particular installation.

If this equipment does cause harmful interference to radio or television reception, which can be determined by turning the equipment off and on, the user is encouraged to try to correct the interference by one or more of the following measures:

- Reorient or relocate the receiving antenna.
- Increase the separation between the equipment and the receiver.
- Connect the equipment into an outlet on a circuit different from that to which the receiver is connected.
- Consult the dealer or an experienced radio/TV technician for help.

Changes or modifications not expressly approved by Leica Geosystems for compliance could void the user's authority to operate the equipment.

Canada

CAN ICES-003 Class B/NMB-003 Class B
IC: 7830A-PLS63W

Canada Compliance Statement

This device contains licence-exempt transmitter(s)/receiver(s) that comply with Innovation, Science and Economic Development Canada's licence-exempt RSS(s). Operation is subject to the following two conditions:

1. This device may not cause interference
2. This device must accept any interference, including interference that may cause undesired operation of the device

Canada Déclaration de Conformité

L'émetteur/récepteur exempt de licence contenu dans le présent appareil est conforme aux CNR d'Innovation, Sciences et Développement économique Canada applicables aux appareils radio exempts de licence. L'exploitation est autorisée aux deux conditions suivantes:

1. L'appareil ne doit pas produire de brouillage
2. L'appareil doit accepter tout brouillage radioélectrique subi, même si le brouillage est susceptible d'en compromettre le fonctionnement

Others

The conformity for countries with other national regulations has to be approved prior to use and operation.



9.5.4

Dangerous Goods Regulations

Dangerous Goods Regulations

Many products of Leica Geosystems are powered by Lithium batteries.

Lithium batteries can be dangerous under certain conditions and can pose a safety hazard. In certain conditions, Lithium batteries can overheat and ignite.

-  When carrying or shipping your Leica product with Lithium batteries onboard a commercial aircraft, you must do so in accordance with the **IATA Dangerous Goods Regulations**.
 -  Leica Geosystems has developed **Guidelines** on "How to carry Leica products" and "How to ship Leica products" with Lithium batteries. Before any transportation of a Leica product, we ask you to consult these guidelines on our web page ([IATA Lithium Batteries](#)) to ensure that you are in accordance with the IATA Dangerous Goods Regulations and that the Leica products can be transported correctly.
 -  Damaged or defective batteries are prohibited from being carried or transported onboard any aircraft. Therefore, ensure that the condition of any battery is safe for transportation.
-

Software Licence Agreement

This product contains software that is preinstalled on the product, or that is supplied to you on a data carrier medium, or that can be downloaded by you online according to prior authorisation from Leica Geosystems. Such software is protected by copyright and other laws and its use is defined and regulated by the Leica Geosystems Software Licence Agreement, which covers aspects such as, but not limited to, Scope of the Licence, Warranty, Intellectual Property Rights, Limitation of Liability, Exclusion of other Assurances, Governing Law and Place of Jurisdiction. Please make sure, that at any time you fully comply with the terms and conditions of the Leica Geosystems Software Licence Agreement.

Such agreement is provided together with all products and can also be referred to and downloaded at the Leica Geosystems home page at [Hexagon – Legal Documents](#) or collected from your Leica Geosystems distributor.

You must not install or use the software unless you have read and accepted the terms and conditions of the Leica Geosystems Software Licence Agreement. Installation or use of the software or any part thereof, is deemed to be an acceptance of all the terms and conditions of such Licence Agreement. If you do not agree to all or some of the terms of such Licence Agreement, you must not download, install or use the software and you must return the unused software together with its accompanying documentation and the purchase receipt to the distributor from whom you purchased the product within ten (10) days of purchase to obtain a full refund of the purchase price.

Appendix A Directory Structure of the Memory Device

Directory structure (SD card)

-- DATA	Storing raw data logging data
-- Session1*	
-- Session2*	
-- Session3*	
-- Transfer	Upload and download files
-- Antenna	Upload antenna files
-- Firmware	Upload firmware files
-- Options	Upload option files
-- Language	Upload language files
-- Settings	Upload system configuration

Directory structure (via FTP access)

When accessing the GR30/GM30/GR50 via FTP, the folder structure is as follows:

-- SD Card	
-- DATA	Storing raw data logging data
-- Session1*	
-- Session2*	
-- Session3*	
-- Transfer	Upload and download files
-- Antenna	Upload antenna files
-- Firmware	Upload firmware files
-- Options	Upload option files
-- Language	Upload language files
-- Settings	Upload system configuration

Directory structure (USB Disks)

-- USB Disks**	
-- DATA	Storing raw data logging data
-- Session1*	
-- Session2*	
-- Session3*	

* The name of the directory shown will be the configured Logging session name. For example an MDB, RINEX or Hatanaka raw data logging session. Refer to the "GR/GM Series Operational Manual (Online Help)" for further information.

**For GR50 only

Appendix B

Pin Assignments and Sockets

B.1

GR30/GM30

Description

Some applications require knowledge of the pin assignments for the GR30/GM30 ports. In this chapter, the pin assignments and sockets for the ports of the GR30/GM30 are explained.

Ports on the instrument rear panel

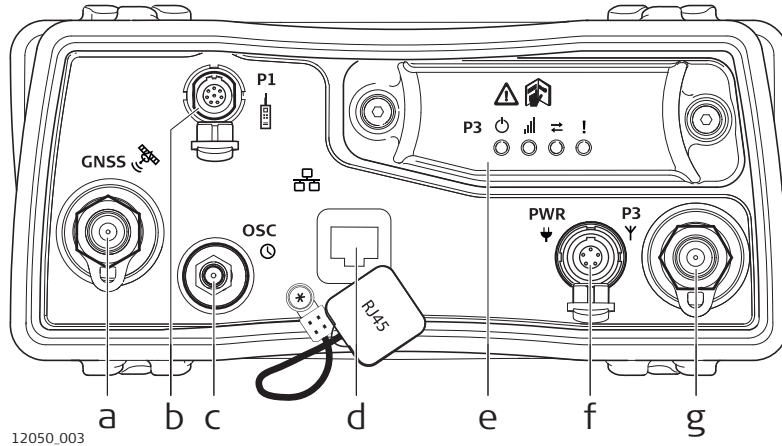

- a **GNSS:** GNSS antenna port TNC
- b **P1:** Serial port, 8 pin LEMO
- c **OSC:** Oscillator port
- d **Ethernet port:** Ruggedised RJ45
- e **P3:** Communication slot-in port
- f **PWR:** Power port, 5 pin LEMO, dual input
- g **P3:** Communication slot-in port antenna, TNC

Pin assignments for P1: Serial

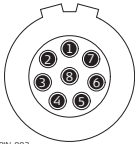

Port PIN.003

Pin	Signal Name	Function	Direction
1	RTS	RS232, ready to send	Out
2	CTS	RS232, clear to send	In
3	GND	Signal ground	-
4	RxD	RS232, receive data	In
5	TxD	RS232, transmit data	Out
6	ID	Identification pin	In or out
7	GPIO	RS232, configurable function	In or out
8	+12 V	12 V power supply out	Out

Pin assignments for PWR: Power

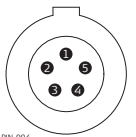

port PIN.004

Pin	Signal Name	Function	Direction
1	PWR1	Power input, 10.5-28 V	In
2	ID1	Identification pin	In
3	GND	Signal ground	-
4	PWR2	Power input, 10.5-28 V	In
5	ID2	Identification pin	In

Sockets

Port P1: LEMO-1, 8 pin, LEMO HMA.1B.308.CLN

Port PWR:

LEMO-1, 5 pin, LEMO HMG.1B.305.CLNP

B.2

GR50

Description

Some applications require knowledge of the pin assignments for the GR50 ports. In this chapter, the pin assignments and sockets for the ports of the GR50 are explained.

Ports on the instrument rear panel

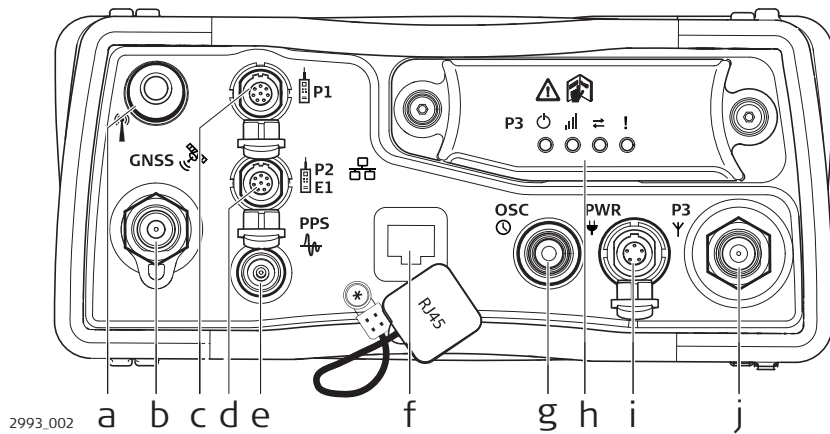

- | | | | |
|---|--|---|--|
| a | BT/WLAN: BT/WLAN antenna | g | OSC: Oscillator port |
| b | GNSS: GNSS antenna port TNC | h | P3: Communication slot-in port |
| c | P1: Serial port, 8 pin LEMO | i | PWR: Power port, 5 pin LEMO, dual input |
| d | P2: Serial/Event port, 8 pin LEMO | j | P3: Communication slot-in port antenna, TNC |
| e | PPS: Pulse per second output | | |
| f | Ethernet port: Ruggedised RJ45 | | |

Pin assignments for P1: Serial

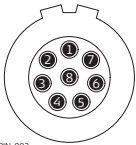

Port_{PIN.003}

Pin	Signal Name	Function	Direction
1	RTS	RS232, ready to send	Out
2	CTS	RS232, clear to send	In
3	GND	Signal ground	-
4	RxD	RS232, receive data	In
5	TxD	RS232, transmit data	Out
6	ID	Identification pin	In or out
7	GPIO	RS232, configurable function	In or out
8	+12 V	12 V power supply out	Out

Pin assignments for P2: Serial

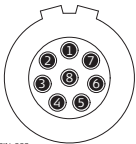

Port_{PIN.003}

Pin	Signal Name	Function	Direction
1	RTS	RS232, ready to send	Out
2	CTS	RS232, clear to send	In
3	GND	Signal ground	-
4	RxD	RS232, receive data	In
5	TxD	RS232, transmit data	Out
6	ID	Identification pin	In or out
7	GPIO / EVT IN	RS232, general purpose input/output	In or out

**Pin assignments
for PWR: Power**

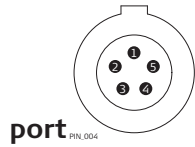

Pin	Signal Name	Function	Direction
8	+12 V	12 V power supply out	Out

Pin	Signal Name	Function	Direction
1	PWR1	Power input, 10.5–28 V	In
2	ID1	Identification pin	In
3	GND	Signal ground	–
4	PWR2	Power input, 10.5–28 V	In
5	ID2	Identification pin	In

Sockets

Port P1:	LEMO-1, 8 pin, LEMO HMA.1B.308.CLN
Port P2:	LEMO-1, 8 pin, LEMO HMA.1B.308.CLN
Port PWR:	LEMO-1, 5 pin, LEMO HMG.1B.305.CLNP
PPS:	LEMO REN.OS.250.CTL
OSC:	MMCX female - 24QMA-50-2-3/133



842720-3.1.0en

Original text (842720-3.1.0en)

Published in Switzerland, © 2023 Leica Geosystems AG



- when it has to be **right**



Leica Geosystems AG

Heinrich-Wild-Strasse
9435 Heerbrugg
Switzerland

www.leica-geosystems.com

