

# Leica DD120, DD130, DD175 Series Locators & Accessories



User Manual  
Version 3.0  
English

- when it has to be **right**

**Leica**  
Geosystems

PART OF  
**HEXAGON**

# Introduction

## Purchase

Congratulations on the purchase of a Leica Detection product.



This manual contains important safety directions as well as instructions for setting up the product and operating it. Refer to [1 Safety Directions](#) for further information.

Read carefully through the User Manual before you switch on the product.



The content of this document is subject to change without prior notice. Ensure that the product is used in accordance with the latest version of this document.

Updated versions are available for download at the following Internet address: <https://myworld.leica-geosystems.com> > myDownloads

## Product identification

The model and serial number of your product are indicated on the type label. Always refer to this information when contacting your agency or Leica Geosystems authorised service centre.

## Validity of this manual

This manual applies to the Leica Detection DD120, DD130, DD175 Series Locators, DA Series Transmitters and Detection Accessories. Differences between the models are marked and described.

## Available documentation

Name	Description/Format		
Leica DD120, DD130, DD175 Series Locators & Accessories Quick Guide	Provides an overview of the product together with technical data and safety directions. Intended as a quick reference field guide.	✓	✓
Leica DD120, DD130, DD175 Series Locators & Accessories User Manual	All instructions required in order to operate the product to a basic level are contained in the User Manual. Provides an overview of the product together with technical data and safety directions.		✓

### Refer to the following resources for all Leica DD120, DD130, DD175 documentation/software:

- The Leica USB documentation card
- <https://myworld.leica-geosystems.com>



<https://myworld.leica-geosystems.com> offers a wide range of services, information and training material.

With direct access to myWorld, you are able to access all relevant services whenever it is convenient for you.

The availability of services depends on the instrument model.

Service	Description
myProducts	Add all products that you and your company own and explore your world of Leica Geosystems: View detailed information on your products and update your products with the latest software and keep up-to-date with the latest documentation.
myService	View the current service status and full service history of your products in Leica Geosystems service centres. Access detailed information on the services performed and download your latest calibration certificates and service reports.
mySupport	Create new support requests for your products that will be answered by your local Leica Geosystems Support Team. View the complete history of your support requests and view detailed information on each request in case you want to refer to previous support requests.
myLearning	Welcome to the home of Leica Geosystems online learning! There are numerous online courses – available to all customers with products that have valid CCPs (Customer Care Packages).
myTrustedServices	Add your subscriptions and manage users for Leica Geosystems Trusted Services, the secure software services, that assist you to optimise your workflow and increase your efficiency.
mySmartNet	Add and view your HxGN SmartNet subscriptions and user information. HxGN SmartNet delivers high-precision and high-availability GNSS network correction services in real time. The HxGN SmartNet Global family offers Network RTK with RTK bridging and Precise Point Positioning (PPP) services. These services work exclusively with Leica Geosystems GS sensors, providing the highest accuracy. Combined, they ensure HxGN SmartNet coverage everywhere.
myDownloads	Downloads of software, manuals, tools, training material and news for Leica Geosystems products.

# Table of Contents

<b>1</b>	<b>Safety Directions</b>	<b>6</b>
1.1	General	6
1.2	Definition of Use	7
1.3	Limits of Use	7
1.4	Responsibilities	8
1.5	Hazards of Use	8
	1.5.1 General	8
	1.5.2 Using the Product with a Signal Transmitter	12
1.6	Electromagnetic Compatibility (EMC)	13
<b>2</b>	<b>Description of the System</b>	<b>15</b>
2.1	System Information	15
2.2	System Components	15
2.3	Locator Components	16
2.4	Signal Transmitter Components	16
<b>3</b>	<b>Operation of the Locator</b>	<b>17</b>
3.1	Display Panel Overview	17
3.2	Locator Setup and Information	17
3.3	Hazard Zone	20
3.4	How to Locate a Utility	21
3.5	Search Modes	21
3.6	Wireless Data Communication, where applicable	22
3.7	Memory & Communication	24
3.8	Internal GPS	24
<b>4</b>	<b>Operation of the Transmitter</b>	<b>26</b>
4.1	Keyboard	26
4.2	Turning On / Turning Off	26
<b>5</b>	<b>Applications</b>	<b>27</b>
5.1	How to Pinpoint a Utility	27
5.2	How to Trace a Utility	28
5.3	How to Conduct a Sweep Search	28
5.4	Using the Transmitter in Induction Mode	30
	5.4.1 General Information	30
	5.4.2 Induction Mode: Nulling-Out Method	31
	5.4.3 Induction Mode: Parallel-Sweep Method	32
	5.4.4 Induction Mode: Radial-Sweep Method	33
5.5	Using the Transmitter in Connection Mode	34
	5.5.1 General Information	34
	5.5.2 Direct Connection Mode	35
5.6	How to Use the Trace Rod	37
	5.6.1 General Information	37
	5.6.2 Locating a Utility Using the Trace Rod	37
5.7	How to Use the Transmitter Clamps	40
	5.7.1 General Information	40
	5.7.2 Using a Transmitter Clamp to connect to Cable Utilities	40
5.8	How to Use the Property Plug Connector	41
	5.8.1 General Information	41
	5.8.2 Locating a Utility Using the Property Plug Connector	42
5.9	How to Use the Sondes	43
	5.9.1 General Information	43
<b>6</b>	<b>Estimating Depth and Current of a Utility</b>	<b>45</b>
6.1	Utility Line Depth	45

6.2	Sonde Depth	46
6.3	Depth Code Information	46
6.4	Utility Current Measurement	47
<b>7</b>	<b>Batteries</b>	<b>50</b>
7.1	Locator Batteries	50
7.2	Transmitter Batteries	50
<b>8</b>	<b>Functional Checks</b>	<b>52</b>
8.1	Locator Health Check	52
8.2	Locator Functional Check	52
8.3	Transmitter Functional Check	53
8.4	Functional Check of the Trace Rod	55
8.5	Functional Check of the Sonde	56
<b>9</b>	<b>Care and Transport</b>	<b>57</b>
9.1	Transport	57
9.2	Storage	57
9.3	Cleaning and Drying	57
<b>10</b>	<b>Technical Data</b>	<b>58</b>
10.1	Conformity to National Regulations	58
10.1.1	Products without radio (USA: Only valid for DD120/DD130)	59
10.1.2	Products with radio (USA: DD175/DA175; EU: All instruments)	60
10.2	Transmitter Technical Data	61
10.3	Locator Technical Data	62
10.4	Conductive Rod Technical Data	64
10.5	Property Plug Connector Technical Data	65
<b>Appendix A</b>	<b>World Frequency Zones</b>	<b>66</b>

# 1 Safety Directions

## 1.1 General

### DANGER

#### Incorrect power setting

The locator may fail to detect electrical services in power mode.

#### Precautions:

- ▶ Before use, verify the locator is setup to be compatible with mains frequency supply in your country. Options are 50 or 60 Hz.
- ▶ Refer to [A World Frequency Zones](#) for more information.
- ▶ Contact your agency or Leica Geosystems authorised service workshop if your unit is incorrectly configured for your region.

### Description

The following directions enable the person responsible for the product, and the person who actually uses the equipment, to anticipate and avoid operational hazards.

The person responsible for the product must ensure that all users understand these directions and adhere to them.

### About warning messages



Warning messages are an essential part of the safety concept of the instrument. They appear wherever hazards or hazardous situations can occur.

#### Warning messages...

- make the user alert about direct and indirect hazards concerning the use of the product.
- contain general rules of behaviour.





For the users' safety, all safety instructions and safety messages shall be strictly observed and followed! Therefore, the manual must always be available to all persons performing any tasks described here.

**DANGER, WARNING, CAUTION** and **NOTICE** are standardised signal words for identifying levels of hazards and risks related to personal injury and property damage. For your safety, it is important to read and fully understand the following table with the different signal words and their definitions! Supplementary safety information symbols may be placed within a warning message as well as supplementary text.

Type	Description
 DANGER	Indicates an imminently hazardous situation which, if not avoided, will result in death or serious injury.
 WARNING	Indicates a potentially hazardous situation or an unintended use which, if not avoided, could result in death or serious injury.
 CAUTION	Indicates a potentially hazardous situation or an unintended use which, if not avoided, may result in minor or moderate injury.

Type	Description
<b>NOTICE</b>	Indicates a potentially hazardous situation or an unintended use which, if not avoided, may result in appreciable material, financial and environmental damage.
	Important paragraphs which must be adhered to in practice as they enable the product to be used in a technically correct and efficient manner.

#### Additional symbols

	Warning against explosive material.
	Warning against flammable substances.
	Product must not be opened or modified or tampered with.
	Indicates the temperature limits at which the product may be stored, transported or used.

## 1.2

### Definition of Use

#### Intended use

The products are intended to be used for the following applications:

- Detection, localisation and estimation of the depth of underground utilities with the use of approved accessories
- Localisation, recording and storage of product usage
- Data transfer with Bluetooth
- Data communication with external appliances

#### Reasonably foreseeable misuse

- Use of the product without instructions
- Use outside of the intended use and limits
- Disabling of safety systems
- Removal of hazard notices
- Opening the product using tools, for example a screwdriver, unless this is permitted for certain functions
- Modification or conversion of the product
- Use after misappropriation
- Use of products with recognisable damage or defects
- Use with accessories from other manufacturers without the prior explicit approval of Leica Geosystems

## 1.3

### Limits of Use

#### Environment

Suitable for use in an atmosphere appropriate for permanent human habitation. Not suitable for use in aggressive or explosive environments.

## **WARNING**

### **Working in hazardous areas or close to electrical installations or similar situations**

Life Risk.

#### **Precautions:**

- ▶ Local safety authorities and safety experts must be contacted by the person responsible for the product before working in such conditions.

## **1.4**

### **Responsibilities**

#### **Manufacturer of the product**

Leica Geosystems AG, CH-9435 Heerbrugg, hereinafter referred to as Leica Geosystems, is responsible for supplying the product, including the User Manual and original accessories, in a safe condition.

#### **Person responsible for the product**

The person responsible for the product has the following duties:

- To understand the safety instructions on the product and the instructions in the User Manual
- To ensure that the product is used in accordance with the instructions
- To be familiar with local regulations relating to safety and accident prevention
- To stop operating the system and inform Leica Geosystems immediately if the product and the application become unsafe
- To ensure that the national laws, regulations and conditions for the operation of the products are respected

## **1.5**

### **Hazards of Use**

#### **1.5.1**

#### **General**

## **NOTICE**

### **Dropping, misusing, modifying, storing the product for long periods or transporting the product**

Watch out for erroneous measurement results.

#### **Precautions:**

- ▶ Periodically carry out test measurements and perform the field adjustments indicated in the User Manual, particularly after the product has been subjected to abnormal use as well as before and after important measurements.



## DANGER

### Risk of electrocution

Because of the risk of electrocution, it is dangerous to use poles, levelling staffs and extensions in the vicinity of electrical installations such as power cables or electrical railways.

#### Precautions:

- ▶ Keep at a safe distance from electrical installations. If it is essential to work in this environment, first contact the safety authorities responsible for the electrical installations and follow their instructions.



## WARNING

### Electric shock though working on or near live electrical utilities

This can lead to dangerous situations which may result in damage or personal injury.

#### Precautions:

- ▶ Do not exceed equipment's recommended ratings and instructions of use.
- ▶ Inspect equipment's cables and accessories for damage, do not use if faulty.
- ▶ Do not work on electrically live power utilities unless you are properly qualified.
- ▶ Use personal protective equipment rated for the utilities voltage and current.
- ▶ Familiarise yourself with National and Work regulations governing safety and accident prevention.

## WARNING

### Distraction/loss of attention

During dynamic applications, for example stakeout procedures, there is a danger of accidents occurring if the user does not pay attention to the environmental conditions around, for example obstacles, excavations or traffic.

#### Precautions:

- ▶ The person responsible for the product must make all users fully aware of the existing dangers.

## WARNING

### Presence of utilities without a detectable signal

The absence of a positive indication does not guarantee the non-existence of a utility.

Without the use of appropriate accessories, the locators cannot locate non-metallic utilities such as plastic pipes, typically used by the water and gas utilities.

#### Precautions:

- ▶ Always excavate with care.

 **WARNING**

**Depth reading on locator might differ from actual depth of utility**

When taking a depth reading, the depth is calculated as distance to the centre of a utility or to a sonde within the utility. Depending on the diameter of a utility, the depth reading might differ from the actual depth of the utility. This specifically applies when the signal for depth estimation is produced by a sonde lying in a large-diameter pipe or duct.

**Precautions:**

- ▶ Always take into account allowances for the diameter of a utility.

 **WARNING**

A hazardous signal can be present at the transmitter output when used in connection mode and on the attached accessories and live utility itself.

**Precautions:**

- ▶ Take care when handling exposed or non-insulated connections. Notify others who may be working on or around the utility.

 **WARNING**

**Inadequate securing of the working site**

This can lead to dangerous situations, for example in traffic, on building sites and at industrial installations.

**Precautions:**

- ▶ Always ensure that the working site is adequately secured.
- ▶ Adhere to the regulations governing safety, accident prevention and road traffic.

 **WARNING**

**Inappropriate mechanical influences to batteries**

During the transport, shipping or disposal of batteries it is possible for inappropriate mechanical influences to constitute a fire hazard.

**Precautions:**

- ▶ Before shipping the product or disposing it, discharge the batteries by the product until they are flat.
- ▶ When transporting or shipping batteries, the person in charge of the product must ensure that the applicable national and international rules and regulations are observed.
- ▶ Before transportation or shipping, contact your local passenger or freight transport company.

### **WARNING**

#### **Exposure of batteries to high mechanical stress, high ambient temperatures or immersion into fluids**

This can cause leakage, fire or explosion of the batteries.

##### **Precautions:**

- ▶ Protect the batteries from mechanical influences and high ambient temperatures. Do not drop or immerse batteries into fluids.

### **WARNING**

#### **Short circuit of battery terminals**

If battery terminals are short circuited e.g. by coming in contact with jewellery, keys, metallised paper or other metals, the battery can overheat and cause injury or fire, for example by storing or transporting in pockets.

##### **Precautions:**

- ▶ Make sure that the battery terminals do not come into contact with metallic/conductive objects.

### **WARNING**

#### **Unauthorised opening of the product**

Either of the following actions may cause you to receive an electric shock:

- Touching live components
- Using the product after incorrect attempts were made to carry out repairs

##### **Precautions:**

- ▶ Do not open the product!
- ▶ Only authorised Leica Geosystems Service Centres are entitled to repair these products.

### **WARNING**

#### **Improper disposal**

If the product is improperly disposed of, the following can happen:

- If polymer parts are burnt, poisonous gases are produced which may impair health.
- If batteries are damaged or are heated strongly, they can explode and cause poisoning, burning, corrosion or environmental contamination.
- By disposing of the product irresponsibly you may enable unauthorised persons to use it in contravention of the regulations, exposing themselves and third parties to the risk of severe injury and rendering the environment liable to contamination.

##### **Precautions:**

- ▶  The product must not be disposed with household waste. Dispose of the product appropriately in accordance with the national regulations in force in your country. Always prevent access to the product by unauthorised personnel.

Product-specific treatment and waste management information can be received from your Leica Geosystems distributor.

 **WARNING**

**Improperly repaired equipment**

Risk of injuries to users and equipment destruction due to lack of repair knowledge.

**Precautions:**

- ▶ Only authorised Leica Geosystems Service Centres are entitled to repair these products.

**1.5.2**

**Using the Product with a Signal Transmitter**

 **DANGER**

**Clipping a transmitter clamp around a live utility**

When a transmitter clamp is clipped around a live utility, a hazardous signal might be present on the utility or at the transmitter plug connector, causing you to receive an electric shock.

**Precautions:**

- ▶ Do not clip a transmitter clamp around live utilities that have impaired or no insulation.
- ▶ Always ensure that the transmitter plug connector is connected to the transmitter before you clip the transmitter clamp around a live utility.

 **DANGER**

**Connecting the cable set of the transmitter to a live utility**

Connecting the cable set of the transmitter directly to a live utility can cause you to receive an electric shock.

**Precautions:**

- ▶ Never connect the cable set of the transmitter directly to a live electrical utility.

 **DANGER**

**Power output of signal transmitter**

The signal transmitter can output potentially lethal voltages!

**Precautions:**

- ▶ Take care when using the maximum power output of the signal transmitter.
- ▶ Take care when handling exposed or non-insulated connections, including the transmitter's cable set, the earth pin and the connection to the utility.
- ▶ Notify others who may be working on or around the utility.

 **WARNING**

**Battery pack of the signal transmitter may get hot after prolonged use**

Risk of burning injuries.

**Precautions:**

- ▶ Avoid touching the hot battery pack.
- ▶ Allow the battery pack to cool down before removing it.

## 1.6

## Electromagnetic Compatibility (EMC)

### Description

The term Electromagnetic Compatibility is taken to mean the capability of the product to function smoothly in an environment where electromagnetic radiation and electrostatic discharges are present, and without causing electromagnetic disturbances to other equipment.

#### CAUTION

##### **Electromagnetic radiation**

Electromagnetic radiation can cause disturbances in other equipment.

##### **Precautions:**

- ▶ Although the product meets the strict regulations and standards which are in force in this respect, Leica Geosystems cannot completely exclude the possibility that other equipment may be disturbed.

#### CAUTION

##### **Use of the product with accessories from other manufacturers. For example, field computers, personal computers or other electronic equipment, non-standard cables or external batteries**

This may cause disturbances in other equipment.

##### **Precautions:**

- ▶ Use only the equipment and accessories recommended by Leica Geosystems.
- ▶ When combined with the product, other accessories must meet the strict requirements stipulated by the guidelines and standards.
- ▶ When using computers, two-way radios or other electronic equipment, pay attention to the information about electromagnetic compatibility provided by the manufacturer.

#### CAUTION

##### **Intense electromagnetic radiation. For example, near radio transmitters, transponders, two-way radios or diesel generators**

Although the product meets the strict regulations and standards which are in force in this respect, Leica Geosystems cannot completely exclude the possibility that the function of the product may be disturbed in such an electromagnetic environment.

##### **Precautions:**

- ▶ Check the plausibility of results obtained under these conditions.

 **CAUTION**

**Electromagnetic radiation due to improper connection of cables**

If the product is operated with connecting cables, attached at only one of their two ends, the permitted level of electromagnetic radiation may be exceeded and the correct functioning of other products may be impaired. For example, external supply cables or interface cables.

**Precautions:**

- ▶ While the product is in use, connecting cables, for example product to external battery or product to computer, must be connected at both ends.

 **WARNING**

**Use of product with radio or digital cellular phone devices**

Electromagnetic fields can cause disturbances in other equipment, installations, medical devices, for example pacemakers or hearing aids, and aircrafts. Electromagnetic fields can also affect humans and animals.

**Precautions:**

- ▶ Although the product meets the strict regulations and standards which are in force in this respect, Leica Geosystems cannot completely exclude the possibility that other equipment can be disturbed or that humans or animals can be affected.
- ▶ Do not operate the product with radio or digital cellular phone devices in the vicinity of filling stations or chemical installations, or in other areas where an explosion hazard exists.
- ▶ Do not operate the product with radio or digital cellular phone devices near medical equipment.
- ▶ Do not operate the product with radio or digital cellular phone devices in aircrafts.
- ▶ Do not operate the product with radio or digital cellular phone devices for long periods with the product immediately next to your body.

## 2

## Description of the System

### 2.1

### System Information

#### General description

Locators are used to detect buried conductive utilities that emit an electromagnetic signal. Such a signal is generated as an electrical current passes through the utility.

Signal transmitters are used to apply a distinct signal to utilities with the following intention:

- To improve the detection success.
- To trace the route of a utility.
- To make a depth or current measurement.

Accessories are used with the locator and transmitter to localise the position of utilities, including some that are non-metallic.

The locators and transmitters described within this manual greatly facilitate the search process and help to reduce the dangers and costs associated with utility strikes. However, electromagnetic location depends on the utilities being conductive (metallic) and emitting a signal as current passes through them.

☞ Keep in mind that a locator on its own cannot detect all utilities. Take care when excavating. We recommend that you adopt a safe system which includes the planning of the search process in advance, the use of utility maps, the use of locators and transmitters, and the use of safe digging practices.

### 2.2

### System Components



The delivered components depend on the package ordered.

#### Available system components

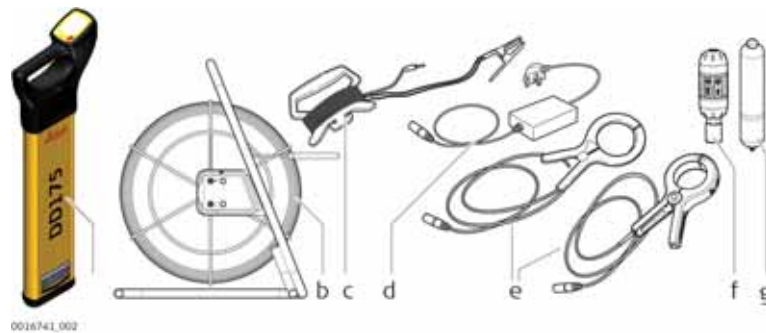

- a DD120, DD130, DD175 Locators
- b Trace Rod (non-metallic utility tracer)
- c Transmitter Cable Set Extension
- d Property Plug Connector
- e Transmitter Clamp 2 ×
- f Sonde
- g Sonde

## 2.3

## Locator Components

Description of components  
DD120, DD130,  
DD175 locators



- a **Display panel**  
Contains the operational controls.
- b **Speakers**  
(mounted internally left and right)  
Active at power on and when a signal is detected.
- c **On/Off trigger**  
Press and hold the trigger to activate the Locator.  
Release the trigger to deactivate.
- d **Battery hatch release**  
Pressing the release button unlocks the battery hatch allowing access to the battery compartment.
- e **Battery compartment**  
6 x LR6 (AA) alkaline batteries are used.  
Replace all batteries when indicated.
- f **Case foot**  
The case foot can be replaced if it is worn.  
Contact your agency or Leica Geosystems authorised service workshop.

## 2.4

## Signal Transmitter Components

Description of transmitter components



- a Accessory compartment
- b Connection socket
- c 4 x LR20 alkaline batteries compartment
- d Signal transmitter keyboard
- e Speaker
- f Induction arrow



## 3

## Operation of the Locator

### 3.1

### Display Panel Overview

DD120, DD130,  
DD175 panel over-  
view

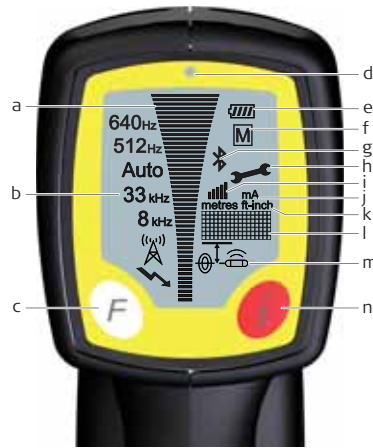

- a **Signal Strength Indicator**  
Indicates the response of the Locator to a signal (utility).
- b **Mode Indicators**  
Displays the selected mode: Power, Radio, 8 kHz, 33 kHz, Auto, (512 Hz and 640 Hz on DD130 and DD175). As shown, from bottom to top.
- c **Function Button**  
Selects operating mode.
- d **Light Sensor**  
Automatically switches the displays backlight on or off to suit light conditions.
- e **Battery Indicator**  
Indicates the battery condition. Segment illumination decreases as battery condition declines. Replace the batteries when the battery indicator is empty.
- f **GPS**  
Only for the DD175.
- g **Bluetooth**  
Only for the DD175.
- h **Wrench**  
Indicates the Locator requires periodic service or unit is faulty.
- i **Numeric Signal Strength Indicator (SSI)**  
**Symbol Static:** SSI is enabled.  
SSI is disabled.
- j **Current Indicator (DD130 and DD175)**-Indicates the amount current flowing through a service which is applied by the Transmitter. This is measured in milliamperes (mA).
- k **Measurement Unit**  
Indicates depth indication is in metric or feet and inches.
- l **Display Readout**  
Alpha numeric matrix indicates system set up and depth indication.
- m **Depth Mode Indicators**  
Indicates a depth reading to a utility or a Sonde. Depth icon used to indicate Hazard Zone status.
- n **i Button**  
Used to access the user settings and to provide a depth readout for Depth locators.

### 3.2

### Locator Setup and Information

Turning on and off  
the DD120, DD130,  
DD175

Only at the first use to start the locator:

1. Press and hold the trigger until the word SET appears on the display.

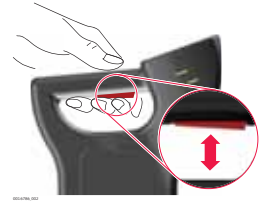

2. Then press and hold the **Function key** for five seconds. The locator can be operated now.



#### Normal use:

1. Press and hold the trigger to turn on and operate the locator.
2. Release the trigger to turn off the locator.



## Locator settings

The DD120, DD130, DD175 locators offer a range of settings which the operator can adjust to their own preference. It also displays additional service and contact information as detailed.

#### For DD120, DD130 and DD175:

Setting	Description
EST	Performs a function check on the locators hardware and software, displaying <b>PAS</b> if the Locator is within predefined tolerance or <b>ERR</b> if the locator is not.
H.Z	Switches hazard zone on or off.
VOL	Adjust volume level (0 to 10).
HLD	Adjust peak hold duration (0 to 5 seconds).
SSI	Displays a numeric signal strength indicator.
CST	Adjusts display's contrast (0 to 15).
M/I	Displays unit of measurement.
CAL	Displays the next service date DD/MM/YY.
CON	Displays supplier/company name.
TEL	Displays supplier/company telephone number.
I.D	Displays the operator's name.

Setting	Description
<b>PWR</b>	Displays the power mode regional setting. Refer to <a href="#">World Frequency Zones</a> for more information.
<b>SR#</b>	Displays unit serial number.
<b>VER</b>	Displays software version.
<b>LST (DD130 and DD175)</b>	Sets the Locators start up mode. <b>On:</b> The Locator starts in the last mode of operation used. <b>Off:</b> The Locator starts in Power mode.

#### Additional settings – for DD175 only:

Setting	Description
<b>CLK</b>	Displays the date and time held within the locators memory. Format: DD/MM/YY/HH/MM/SS
<b>LOG</b>	Displays the last stored log number 001 to 999.
<b>COM</b>	Adjusts the locators Bluetooth or GPS settings: <ul style="list-style-type: none"> <li>• PC: Enables Bluetooth communication to DX Softwares.</li> <li>• BT1: Enables Bluetooth option 1 (refer to section xxx)</li> <li>• BT2: Enables Bluetooth option 2 (refer to section xxx)</li> <li>• OFF: Disables Bluetooth</li> </ul>

#### Accessing and adjusting the settings

1. Switch the Locator on.
2. Ensure the Locator is in Power mode.  
If required, press Function Button to select mode.
3. Depress the **i** Button until the user settings are displayed in the display readout.
4. Press Function Button to toggle through to desired setting.
5. Press **i** Button to select the setting.
6. Press Function Button to activate/adjust.
7. Press **i** Button to store and exit.

#### DANGER

##### Incorrect power setting

The locator may fail to detect electrical services in power mode.

##### Precautions:

- ▶ Before use, verify the locator is setup to be compatible with mains frequency supply in your country. Options are 50 or 60 Hz.
- ▶ Refer to [A World Frequency Zones](#) for more information.
- ▶ Contact your agency or Leica Geosystems authorised service workshop if your unit is incorrectly configured for your region.

### Changing the battery

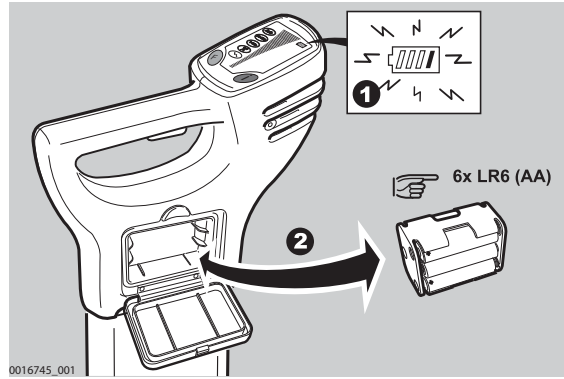

1. Replace or Recharge the batteries when the battery status indicator is empty.

---

2. Press the release button to unlock the Battery Hatch. Remove the battery holder from the Locator.

---

3. Replace all batteries with six new LR6 (AA) type alkaline batteries, or remove and recharge the battery pack if rechargeable batteries are fitted.



### 3.3 Hazard Zone

#### Description

Provides an additional warning to the close proximity of buried services and functions in the following modes:

- Power
- 8 kHz
- 33 kHz
- Auto Mode (Power mode only)
- 512 Hz & 640 Hz (DD130 and DD175 model only)

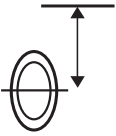
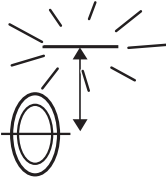
#### Description

Status indicator	Description
	Hazard zone is switched on.
	Hazard zone on and is alarming.
	Hazard zone is switched off.

### 3.4

### How to Locate a Utility

Status indicator	Test pattern	Info on label
Audio Output	On throughout test sequence	
Signal Strength indicator	Scrolls through in sequence once	
Mode indicators	Briefly illuminated	
Indicator Icons	Briefly illuminated	
Battery indicator	On throughout test sequence	

### 3.5

### Search Modes

#### How to select a search mode



Press the Function key on the locator keyboard to select a search mode.

#### Available search modes

Search Mode	Description
Auto mode	<p>Combined detection of Power and Radio modes.</p> <p> This mode facilitates a one-step sweep search process.</p>
Power mode	<p>This mode is used to detect electrical cables.</p> <p> Power mode is dependent on an electrical current flowing through a cable. Keep in mind that not all electrical cables carry a detectable signal and thus pose a serious risk, for example supplies to unilluminated street lights, unoccupied buildings or balanced three-phase cables.</p>
Radio mode	<p>This mode is used to detect metallic pipes or cables, including telecoms and electrical.</p> <p> Radio mode is dependent on reradiated radio waves originating from radio masts. Keep in mind that signal availability can vary or be restricted depending on factors including line of site, signal application or routine mast maintenance.</p>

Search Mode	Description
Signal Transmitter mode	<p>Used in conjunction with a signal transmitter:</p> <ul style="list-style-type: none"> <li>To improve the detectability of utilities.</li> <li>To trace a specific utility.</li> <li>To make a depth or current measurement.</li> </ul> <p>☞ Keep in mind the following:</p> <ul style="list-style-type: none"> <li>Higher frequencies couple onto utilities more easily than lower frequencies.</li> <li>Higher frequencies travel shorter distances; the higher the frequency the less the distance travelled.</li> <li>Higher frequencies are likely to couple onto other utilities; the higher the frequency the greater the spread.</li> <li>Higher frequencies are useful for avoidance activities.</li> </ul> <p>Example: A 33 kHz frequency has a greater ability to couple onto other utilities.</p>
Sonde	<p>Used in conjunction with a sonde:</p> <ul style="list-style-type: none"> <li>To trace the route of a pipe or duct, including non-metallic variants.</li> <li>To locate a blockage or collapse.</li> <li>To make a depth measurement.</li> </ul> <p>☞ Keep in mind that various sondes are available for specific task-based applications:</p> <ul style="list-style-type: none"> <li>Sondes with higher frequencies are used for generic pipe or duct tracing.</li> <li>Lower frequencies (512 Hz, 640 Hz) work best for metal pipes.</li> </ul>

### **WARNING**

#### **Presence of utilities without a detectable signal**

The absence of a positive indication does not guarantee the non-existence of a utility.

Without the use of appropriate accessories, the locators cannot locate non-metallic utilities such as plastic pipes, typically used by the water and gas utilities.

#### **Precautions:**

- ▶ Always excavate with care.

## 3.6

### **Wireless Data Communication, where applicable**

#### **Bluetooth**

Bluetooth status is indicated on the Locators display, the Bluetooth symbol will be illuminated on all locators with Bluetooth connectivity. Data can be wirelessly transferred from a Bluetooth enabled Locator to a suitable data logging device, enabling the operator to capture information about the Locator's status and the service depth.

When the Locator is paired to a suitable device:

- The Bluetooth symbol flashes
- The unit transmits data periodically

Important information for pairing:

- The Locator must be switched on throughout the process
- Follow the instructions on the device for pairing  
Refer to the manufacturer's instructions

### Pairing information

Locator Name: 'Model Number' - 'Serial Number'  
for example: DD175-00001

Pass key: 12345



- The Bluetooth symbol will flash continually when the devices have successfully paired
- When a depth reading has been taken: The Locator will display LOG  
To transfer the information to the data logger: Press the i button whilst LOG is displayed
- Whilst the Locator is calculating depth the data output stops
- If there is no wireless communication then the LOG function will not be displayed and the unit will function as a Locator
- The Locator will output ASCII text  
Refer to "ASCII text description" for more information

### ASCII text description

ASCII output pattern:

- BT1 (standard on all Bluetooth enabled locators):  
DVxxxSNxxxxxSVxxxxTMxxxxDTdd/mm/yyCMxxSTxBTxMDxSSxxUMxDPxxxx
- BT2 (model dependent):  
DPxxxxUMxMDxSSxxDVxxxSNxxxxxCMxxBTxSTxSVxxxxDTxxxxxxxxTMxxxx

Data Output	Range	Example Value	Description
DV	000 to 999	550	Model identifier
SN	000000 to 999999	123456	Serial number
SV	0.00 to 9.99	3.01	Software version
TM	00:00 to 23:59	08:30	Time: hh:mm (default = 00:00; no RTC fitted)
DT	00/00/00 to 31/12/99	01/12/10	Date: dd/mm/yy (default = 00/00/00; no RTC fitted)
CM	00 to 15	12	Number of months until next calibration (00 to 15)
ST	0 or 1	0	Self test: 0 = Pass, 1 = Fail
BT	0 to 9	7	Battery level: 0 = Empty, 9 = Good
MD	0 to 4	3	Mode: 0 = Power, 1 = Radio, 2 = 8 kHz, 3 = 33 kHz, 4 = Auto
SS	01 to 48	16	Signal strength: 01 to 48

Data Output	Range	Example Value	Description
UM	M or I	M	Units of measurements: M or I (Metres or Imperial)
DP	0.30 to 3.00 or ---	125	Depth value displayed depends on value for UM.

### 3.7

### Memory & Communication

#### Data records

The DD175 locators record and store information whilst they are in use. The locators start to record information every second after completion of the initial start-up routine. These records (logs) are stored in the locators memory and can be retrieved and transferred via Bluetooth to a PC for analysis.



The records are sequentially stored, once the locator's memory is full the oldest records will be overwritten.

### 3.8

### Internal GPS

#### Data records

The DD175 locators have an internal GPS module which is used to record the geographical position of use. The geographical position (latitude and longitude) is stored in the log file and provides information on where the locator was used.

The **M** icon is used to display the GPS status as follows:

- **M flashing:** GPS fix available and the geographical position is being recorded to the locators log files.
- **M static:** No GPS fix and the geographical position is not being recorded to the locators log files

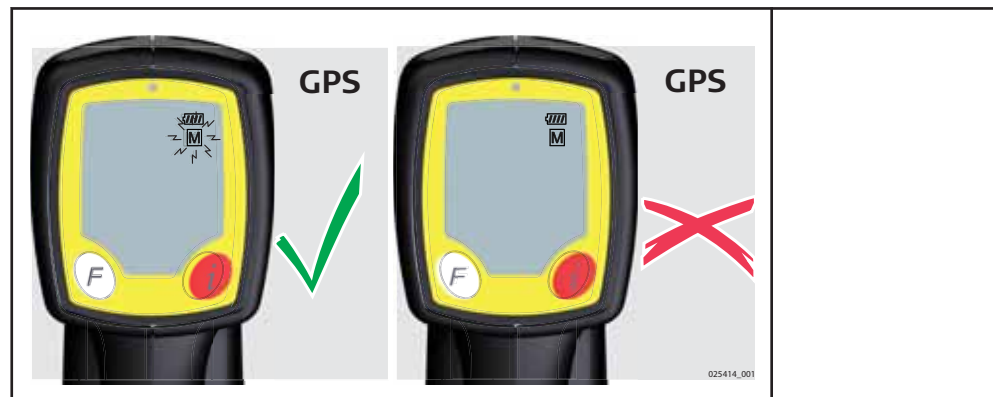

#### GPS Search Mode (DD175)

A GPS search mode is activated as part of the start up test allowing the internal GPS module time to search for a GPS position. GPS search mode is active following the start up test even if the locator is off, the search mode will stop when a GPS position is obtained or a seven minutes search period has elapsed.

GPS search mode does not affect the locator's performance and the locator can be used as normal throughout this search mode.





When retrieving log files from the DD175 "P.C" must be selected from the "COM" setting as described in section [Locator Setup and Information](#).

**COM Setting Options**

PC: Enables Bluetooth communication to DX Office Shield Software

BT1: Enables Bluetooth option 1 (refer to [Wireless Data Communication, where applicable](#))

BT2: Enables Bluetooth option 2 (refer to [Wireless Data Communication, where applicable](#))

GPS: Switches GPS on following use with BT1 or BT2 settings



BT1 and BT2 connections will be maintained for a three hour period when selected, during this period the GPS will be off. The GPS will automatically activate after the three hour period has elapsed or GPS is selected from the COM Setting.

---

## 4 Operation of the Transmitter

### 4.1 Keyboard

#### Transmitter keyboard

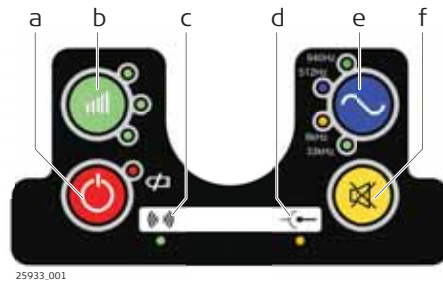

- a Power key
- b Power Output key and LED indicators
- c Induction Mode LED indicator
- d Connection Mode LED indicator
- e Frequency key and LED indicators
- f Mute key

### 4.2 Turning On / Turning Off

#### Turning on and off the transmitter

Press the Power key to turn the transmitter on or off.

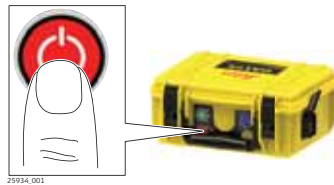

## 5

## Applications

### 5.1

### How to Pinpoint a Utility

#### Pinpointing process

To help you pinpoint a utility, the locator provides a visual and an audible response.

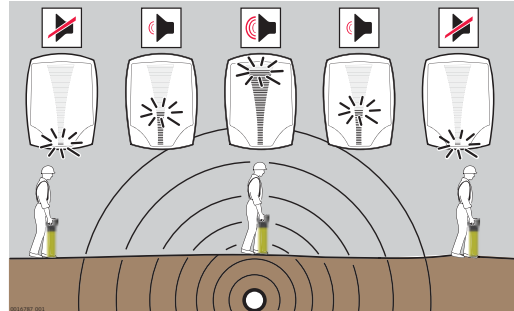

#### Visual response

When the locator is positioned directly over a utility and at 90° to it, the Locate screen displays a peak reading. Refer to [3.1 Display Panel Overview](#).

##### Locate Scale



- Increases when approaching a utility or sonde and decreases when moving away.
- Provides a peak reading when directly over the utility or sonde.
- Decreases when moving away from the utility.

##### Peak Indicator



- Indicates the highest peak reading on the locate scale.
- Remains at the peak position for a short period of time before falling back.

##### Numeric Peak Indicator



- Increases when approaching a utility or sonde and decreases when moving away.
- Provides the highest peak reading when directly over the utility or sonde.
- Decreases when moving away from the utility.
- Can be used to distinguish between utilities when a signal transmitter is used.

#### Audible response

To assist in the pinpointing process, the audio output automatically adjusts over the peak reading to provide a narrower response.



Mark the position of a utility with marker paint, pegs, flags or something similar. Never drive pegs into the ground over the utility!

- ☞ The signal strength indicators do not indicate the size, depth or type of a utility.
- ☞ To ascertain an estimated depth of the utility, use a signal transmitter or a sonde. Refer to [6 Estimating Depth and Current of a Utility](#).

## 5.2 How to Trace a Utility

### Tracing process

1. Pinpoint a utility by finding the peak reading. The peak reading is found when the locator is positioned directly over a utility and at 90° to it.

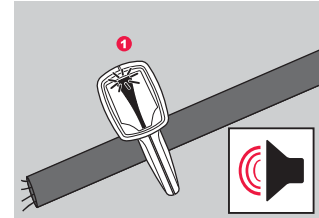

2. Rotate the Locator around its axis until the signal strength indicators are at a minimum.

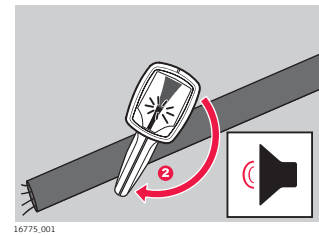

3. When the signal strength indicators are at a minimum, the blade of the locator is in line with the utility and indicates its direction.

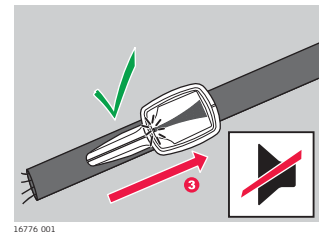

4. Trace the route of the utility by repeating the following process:
  - Pinpoint the utility.
  - Determine the direction of the utility.
  - Follow the direction of the utility.

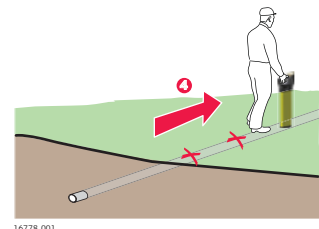

## 5.3 How to Conduct a Sweep Search

### Sweep Search Process

Before the sweep search, define the work area to be excavated and inspect this area for signs of buried utilities, such as:

- Recent trenching
- Buried utility marker posts
- Overhead lines that run down poles and underground
- Access chamber covers

1. Set the locator to Power mode.

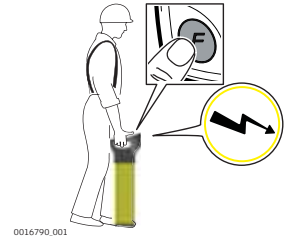

Ensure that the locator is held upright and close to the ground. Take care not to swing the locator.

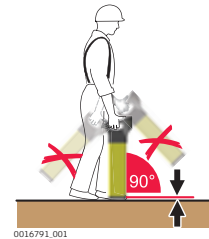

2. Cross the site from left to right until the defined area is covered.

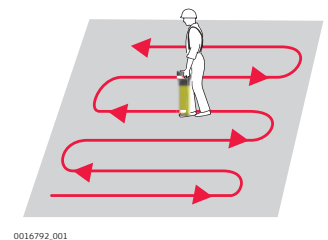

3. Turn through 90 ° and repeat the process.

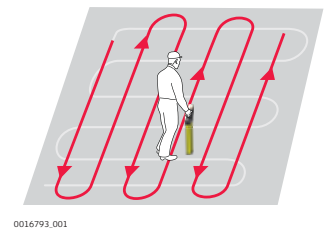

4. Pinpoint a utility by finding the peak reading. The peak reading is found when the locator is positioned directly over a utility and at 90° to it. Mark the position of a utility with marker paint, pegs, flags or something similar.



Never drive pegs into the ground over the utility!



Activate the Hazard Zone alert to indicate the presence of buried utilities which may be close to the surface.

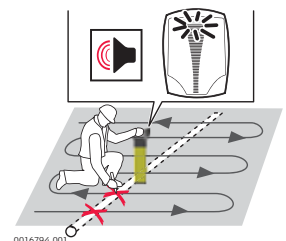

5. Set the locator to Radio mode and repeat the sweep search process. Continue with this process until either a signal is detected or you are satisfied that the area has been adequately tested.

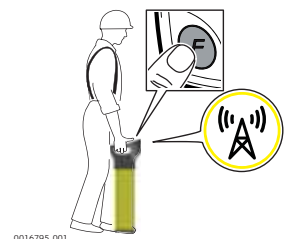



To conduct a one-step Sweep Search process or to provide a fast scan for large work areas, the locator can be used in Auto mode. To obtain an improved definition of a detected utility, use the locator in an individual mode.

## 5.4

## Using the Transmitter in Induction Mode

### 5.4.1

### General Information

#### Induction mode

Induction is a quick and simple way to apply a signal to a utility without the need to make any physical connection to it. The transmitter uses an internal aerial to transmit the signal to the utility.

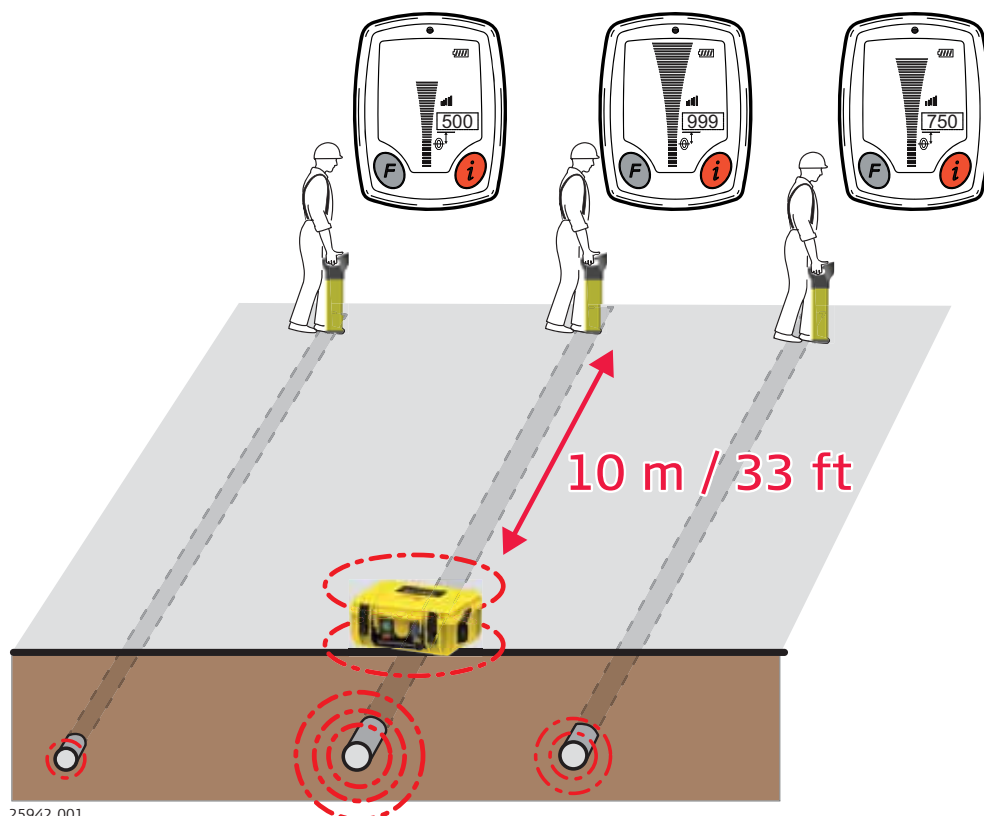

Work at least 10 m/33 ft away from the transmitter to avoid airborne signals. Reposition the Transmitter if necessary.



Coupling efficiency is best at 33 kHz.



The signal can also apply itself to other utilities within close proximity to the transmitter, depending on their depth and direction.







To increase the battery life and to reduce the possibility that the signal is applied to adjacent utilities, reduce the signal output.

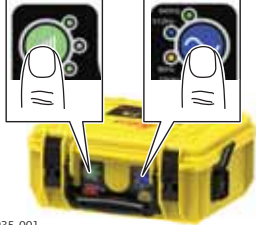
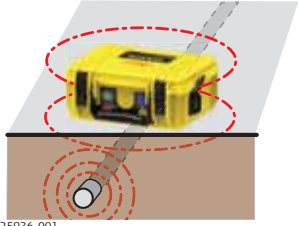
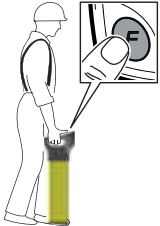
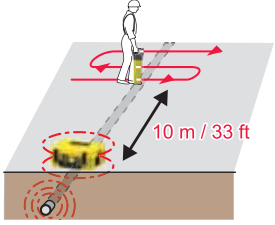

The Numeric Peak Indicator can be used to indicate multiple utilities or to assist tracing. The utility with the maximum value is typically the one closest to the transmitter or the one directly connected to.

## Standard process for Induction mode

1. Turn on the transmitter.  
 Ensure that any connection cables or accessories are disconnected and the battery level is adequate.  

2. Select the required power output and frequency.  
  
25935\_001
3. Place the transmitter over the utility with the arrows running in line with the suspected direction of the utility. The internal aerial directly induces the tracing signal onto the utility.  
  
25936\_001
4. Set the locator to the required Signal Transmitter frequency.  
  
0016797\_001
5. Using the Sweep Search process, search the work area until either a signal is detected or you are satisfied that the area has been adequately tested. Refer to [5.3 How to Conduct a Sweep Search](#). Trace a utility as required. Refer to [5.2 How to Trace a Utility](#).  
  
25943\_001  
 Maintain a distance of 10 m/33 ft from the transmitter to avoid airborne signals and a decline in the search process. Reposition the transmitter if required.

### 5.4.2

## Induction Mode: Nulling-Out Method

### Nulling-Out method

Use the Nulling-Out method to confirm that the locator and transmitter are on the same utility or to identify hidden utilities in close proximity to each other.

-  The transmitter and locator need to be set for use in induction mode. Refer to [5.4 Using the Transmitter in Induction Mode](#).

1. Position the locator over the utility with the highest numeric signal strength.

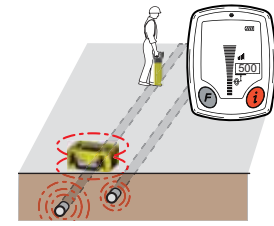

2. To confirm that the transmitter and the locator are on the same utility, place the signal transmitter upright and directly over the utility.



Either the speaker or the connection socket should be on the ground.

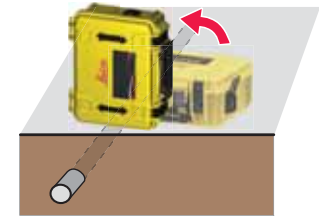

3. If the transmitter and the locator are on the same utility, the Numeric Peak Indicator on the locator significantly decreases.

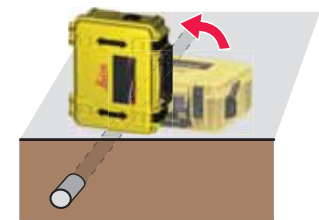

The Numeric Peak Indicator on the locator can be used to correct the position of the transmitter. Slightly move the transmitter left or right over the utility until the locate screen of the locator shows the lowest reading. It is possible to obtain the value "000".

4. Using the Sweep Search process, search the work area to identify previously hidden utilities.



Pinpoint and trace utilities until you are satisfied that the area has been adequately tested.

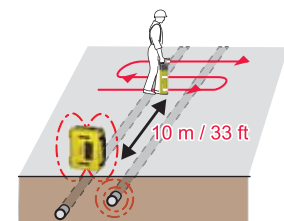

### 5.4.3

### Induction Mode: Parallel-Sweep Method

#### Parallel-Sweep method

Use the Parallel-Sweep method to cover a large area or to verify the presence of utilities before using the standard process for induction mode.



Two people are required for this process: one for operating the locator and one for operating the transmitter.



Set the transmitter and locator to 33 kHz.



- Person operating the transmitter:**  
Hold the transmitter close to the ground with the arrows on the lid vertical and with the lid facing the person who operates the locator.

**Person operating the locator:**  
Position the locator at a minimum distance of 10 m/33 ft away from the transmitter.

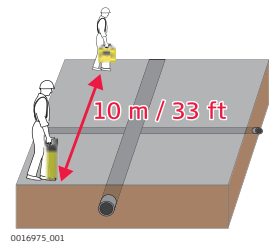

- Both persons:**  
Start walking parallel to each other.

☞ The tracing signal is induced directly onto the utility and indicated on the locator.

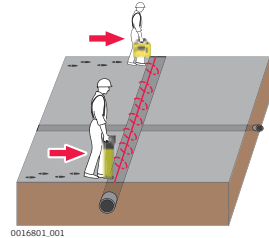

- In the presence of a detectable utility, the locator emits a tone and the signal strength indicators rise and fall as you pass over the utility. Return to the position where the Locate screen shows a peak reading. Mark the position of a utility with marker paint, pegs, flags or something similar.

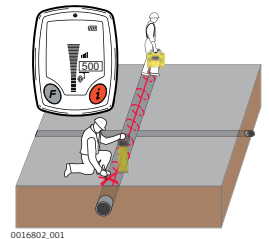

- ☞ Never drive pegs into the ground over the utility!
- ☞ To trace a specific utility, use the pinpointing and tracing methods. Refer to [5.1 How to Pinpoint a Utility](#) and [5.2 How to Trace a Utility](#).

- Turn through 90 ° and repeat the process.

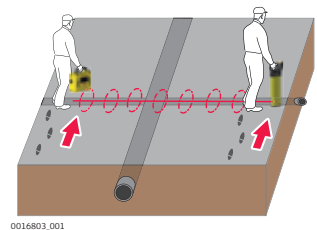

- ☞ Pinpoint and trace utilities until you are satisfied that the area has been adequately tested.

#### 5.4.4

### Induction Mode: Radial-Sweep Method

#### Radial-Sweep method

Use the Radial-Sweep method to discover utilities coming from a known point such as a telecommunications chamber.

- ☞ Two people are required for this process: one for operating the locator and one for operating the transmitter.
- ☞ Set the transmitter and locator to 33 kHz.

- Person operating the transmitter:**  
Hold the transmitter close to the ground with the arrows on the lid vertical and with the lid facing the person who operates the locator.

**Person operating the locator:**  
Position the locator at a minimum distance of 10 m/33 ft away from the transmitter.

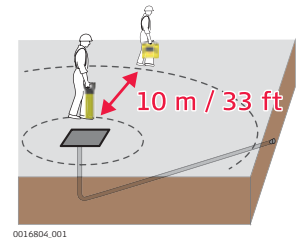

- Both persons:**  
Start walking parallel to each other, circling the target area.

- The tracing signal is induced directly onto the utility and indicated on the locator.

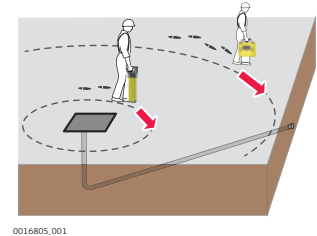

- In the presence of a detectable utility, the locator emits a tone and the signal strength indicators rise and fall as you pass over the utility. Return to the position where the Locate screen shows a peak reading. Mark the position of a utility with marker paint, pegs, flags or something similar.

- Never drive pegs into the ground over the utility!
- To trace a specific utility, use the pinpointing and tracing methods. Refer to [5.1 How to Pinpoint a Utility](#) and [5.2 How to Trace a Utility](#).

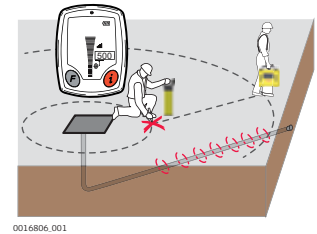

- Pinpoint and trace utilities until you are satisfied that the area has been adequately tested.

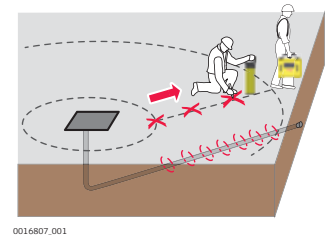

## 5.5

## Using the Transmitter in Connection Mode

### 5.5.1

### General Information

#### Connection mode

Connection mode is the most efficient way to apply a signal to a utility. The cable set of the transmitter or any of the available accessories are connected to the utility which is to be traced or identified.

- Whenever possible, use the transmitter in connection mode, especially for taking a depth reading.
- The Numeric Peak Indicator can be used to indicate multiple utilities or to assist tracing. The utility with the maximum value is typically the one connected to.

- ☞ The black connection cable can be connected to other metallic structures which go into the ground, such as iron grids or metal covers of access chambers.
- ☞ In dry conditions it may be necessary to add water around the earth point to get a good connection.
- ☞ When using the connection cable set, examine the connection points and remove contamination if a continuous audible output is not achieved.
- ☞ An extension cable is available to extend either the red or black cables on the connection cable set.
- ☞ Reducing the signal output helps to extend the battery life and to reduce the amount of signal applied to adjacent utilities.

## 5.5.2

### Direct Connection Mode

#### Using the transmitter in Direct Connection mode

1. Plug the transmitters cable set into the connection socket.



14341.001

2. Ensuring that no utilities are below, push the Earth Pin into the ground and connect the black cable to the Earth Pin.

- ☞ For more safety, we recommend pushing the Earth pin into the ground at an angle of 45 degrees.

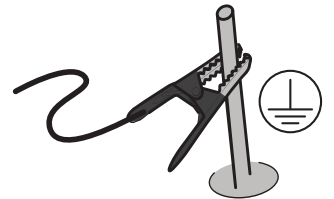

14343.002

- ☞ For best performance, position the Earth pin and black cable at 90 degrees to the suspected direction of the utility.

3. Connect the red cable to the utility.

- ☞ Never connect the red cable directly to an electrical cable!

- ☞ Connecting the red cable to the metal framework of earth-bonded electrical installations such as street lights, pumps or motorised gate housings, improves the detectability of low-loaded electrical cables. For best performance, connect to bare metal.

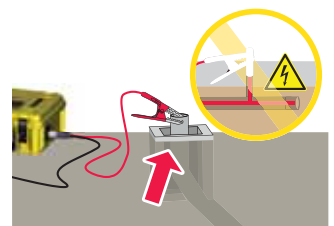

14345.001

4. Turn on the transmitter.
- ☞ Ensure that the Connection Mode LED indicator is on and the battery level is adequate.

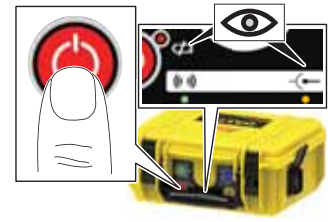

25937.001

5. Select the required frequency and power output.  
To indicate that the tracing signal reaches a good level, the Power Output LED indicator and the audible tone change from pulsed to continuous.

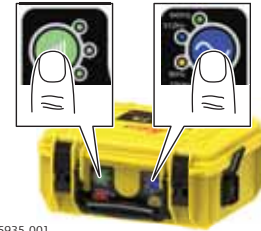

25935.001

6. Set the locator to the required Signal Transmitter frequency.

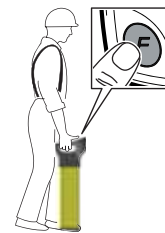

0016797.001

7. At a distance of 5 m (16 ft) to the connection point, circle around the connection point.

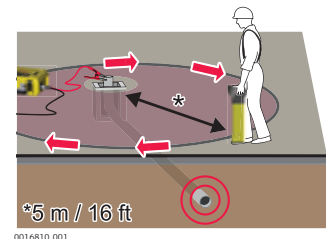

0016810.001

8. In the presence of a detectable utility, the locator emits a tone and the signal strength indicators rise and fall as you pass over the utility. Return to the position where the Locate screen shows a peak reading. Mark the position of a utility with marker paint, pegs, flags or something similar.

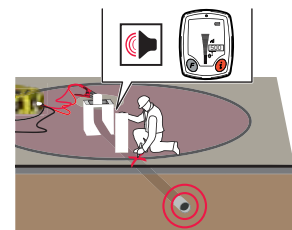

0016811.001

- ☞ Never drive pegs into the ground over the utility!
- ☞ To trace a specific utility, use the pinpointing and tracing methods. Refer to [5.1 How to Pinpoint a Utility](#) and [5.2 How to Trace a Utility](#).

- ☞ Pinpoint and trace utilities until you are satisfied that the area has been adequately tested.

## 5.6 How to Use the Trace Rod

### 5.6.1 General Information

#### Description

The Trace Rod is a utility tracer enabling small diameter non-conductive pipes, ducts, conduit or drains to be traced. It can be used in Line mode to find the route of the duct or Sonde mode to find a blockage.

#### Description of components

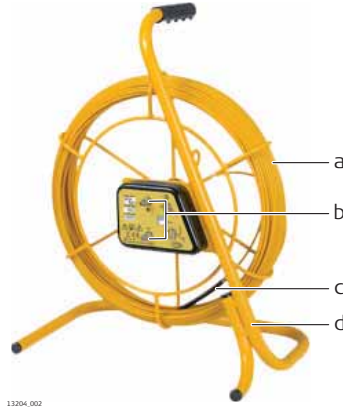

- a **Sonde** – Using Sonde mode, the sonde helps to pinpoint the end point of the trace rod.
- b **Line** – Flexible, glass-fibre sheathed rod, which incorporates copper wires to conduct the signal. Using Line mode, the rod helps to trace the route of a utility.
- c **Connection terminals** – Used to connect to the signal transmitter.
- d **Frame** – Houses the flexible rod. Can be used in both vertical (as in illustration) and horizontal orientation.

### 5.6.2 Locating a Utility Using the Trace Rod

#### Using the trace rod in Line mode

1. Insert the rod into the pipe until the desired length is in place.

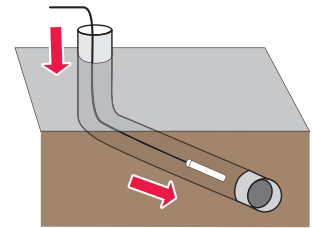

2. Plug the transmitters cable set into the connection socket.



3. Ensuring that no utilities are below, push the Earth Pin into the ground and connect the black cable to the Earth Pin.



For more safety, we recommend pushing the Earth pin into the ground at an angle of 45 degrees.



For best performance, position the Earth pin and black cable at 90 degrees to the suspect direction of the utility.

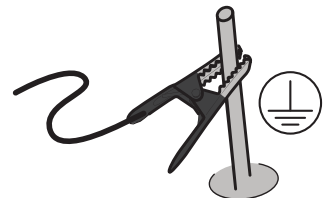

4. Connect the red cable to the positive (+) terminal on the trace rod.



5. Turn on the transmitter.
  - ☞ Ensure that the Connection Mode LED indicator is on and the battery level of the transmitter is adequate.

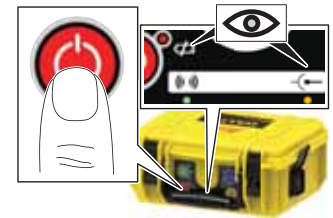

6. Select the required frequency and power output. To indicate that the tracing signal reaches a good level, the Power Output LED indicator and the audible tone change from pulsed to continuous.

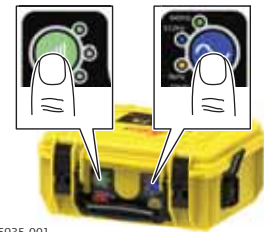

7. Set the locator to the required Signal Transmitter frequency.

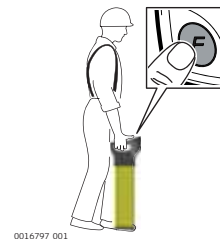

8. Sweep the area until a signal is detected. Pinpoint and trace the utility.
  - ☞ Use the Numeric Peak Indicator to identify the exact position of the rod. The position is typically indicated by the maximum value.

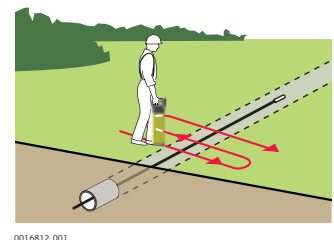

### Using the trace rod in Sonde mode

- ☞ For ease of use practice the process above ground.
- ☞ For ease and convenience mark the ground every 3 to 4 metres.

1. Insert the rod into the pipe, duct or conduit until the desired length is in place.

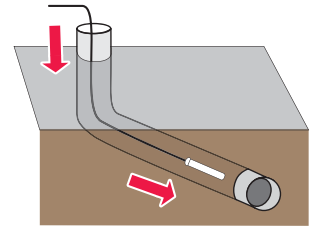

14356.001

2. Plug the transmitters cable set into the connection socket.



14341.001

3. Connect the red cable to the positive (+) terminal on the trace rod. Connect the black cable to the negative (-) terminal.



14359.002

4. Turn on the transmitter.  
 Ensure that the Connection Mode LED indicator is on and the battery level of the transmitter is adequate.

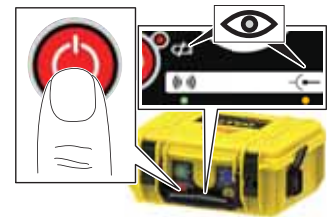

25937.001

5. Select the required frequency and power output.  
To indicate that the tracing signal reaches a good level, the Power Output LED indicator and the audible tone change from pulsed to continuous.



25935.001

6. Set the locator to the required Signal Transmitter frequency.

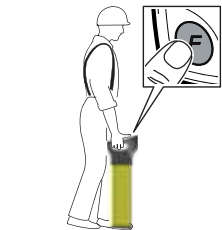

0016797.001

- Walk in line with the suspected direction of travel observing the display. The signal strength indicator rises and falls as you pass over the ghost signal at the back of the sonde, the peak signal directly over the sonde and the ghost signal at the front. The Numeric Peak Indicator displays its highest value when detecting the peak signal.

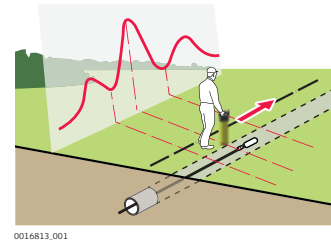

0016813.001

- Retrace your steps and position the locator directly over the peak signal. Move the locator left and right until the highest numeric reading is obtained. This reading indicates the precise location of the sonde. Pinpoint and trace the utility.

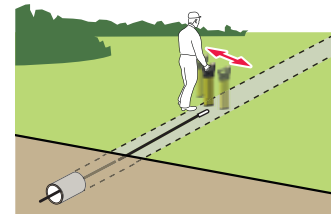

0016814.001

## 5.7

## How to Use the Transmitter Clamps

### 5.7.1

### General Information

#### Description

A Transmitter Clamp provides a safe technique of applying a signal to utilities such as telecom cables, electric cables, etc. It is connected to the Transmitter and then clipped around the utility. Supply is not interrupted by the applied signal.

#### Description of components



- a Transmitter plug connector
- b Jaws
- c Handle
- d Cable

### 5.7.2

### Using a Transmitter Clamp to connect to Cable Utilities

#### Connecting to a cable utility

- Connect the plug of the transmitter clamp to the transmitter.



14342\_001

- Open the jaws of the transmitter clamp and place it around the utility to be traced.



Ensure that the jaws are fully engaged.

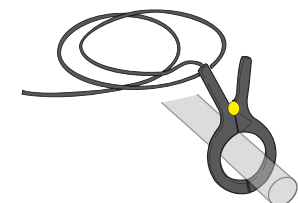

14438\_001



3. Turn on the transmitter.  
 ☞ Ensure that the battery level of the transmitter is adequate.

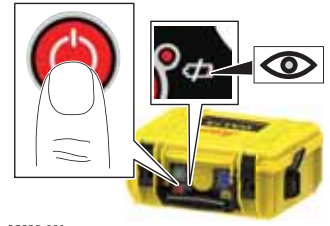

25938\_001

4. Select the required frequency and power output.  
 ☞ For compatible frequencies check the type plate of the transmitter clamp.

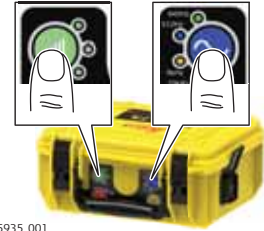

25935\_001

To indicate that the tracing signal reaches a good level, the Power Output LED indicator and the audible tone change from pulsed to continuous.

5. Set the locator to the required Signal Transmitter frequency.

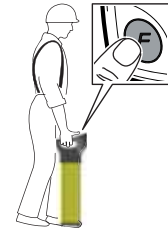

0016797\_001

6. Trace the route of the utility. Refer to [5.2 How to Trace a Utility](#).

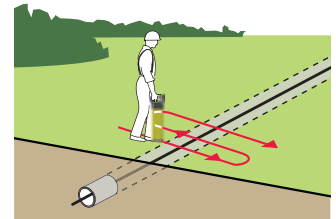

0016815\_001

## 5.8

## How to Use the Property Plug Connector

### 5.8.1

### General Information

#### Description

The Property Plug Connector provides a safe technique of applying a traceable signal to live electricity cables. The applied signal does not interrupt mains supply and the risk of serious injury is greatly reduced.

#### Description of components

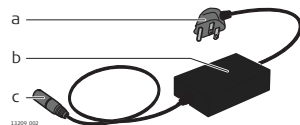

11209\_002

- a Mains plug connector
- b In-line isolator
- c Transmitter plug connector

## 5.8.2

## Locating a Utility Using the Property Plug Connector

### Using the property plug connector

1. Connect the property plug connector to the transmitter.



2. Connect the property plug connector to a live mains outlet.



Ensure that the mains connection is switched on and live.

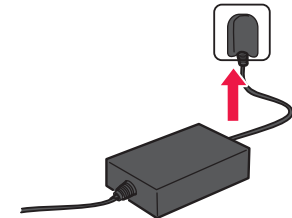

3. Turn on the transmitter.



Ensure that the battery level of the transmitter is adequate.

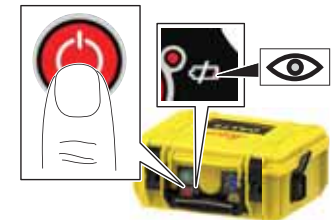

4. Select the required frequency and power output.



Ensure that the frequency output of the transmitter is comparable to that of the property plug connector. Check the type plate of the property plug connector for the frequency rating.

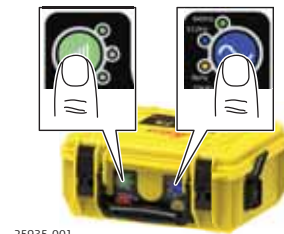

To indicate that the tracing signal reaches a good level, the Power Output LED indicator and the audible tone change from pulsed to continuous.

5. Set the locator to the required Signal Transmitter frequency.

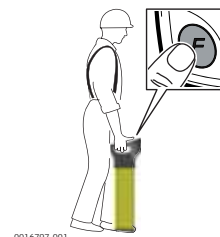

- Trace the length of the utility. Refer to [5.2 How to Trace a Utility](#).

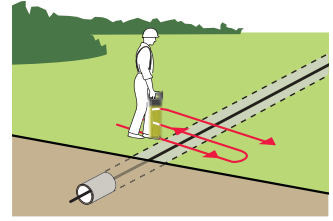

0016815\_001

## 5.9

## How to Use the Sondes

### 5.9.1

### General Information

#### Description

The sondes are signal transmitters used to trace pipes, ducts, conduit or drains. A sonde can be attached to a range of equipment including drain rods, boring tools and inspection cameras. It is powered by its own battery supply, so unlike other accessories this does not require a connection to the transmitter.

The signal pattern transmitted from a sonde is different to that which is radiated from a utility and requires tracing in its own unique method. The sonde transmits a peak signal over its main body, with a ghost signal at its front and back.

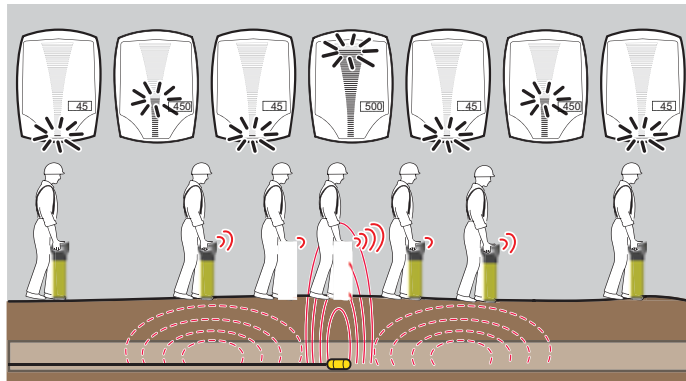

0016816\_001



The Locator features a Numeric Peak Indicator which is used to identify the peak reading. Refer to [3.1 Display Panel Overview](#).

#### How to trace a utility using a sonde



For ease of use practice the process above ground.



For ease and convenience mark the ground every 3 to 4 metres.

- Set the locator and sonde to the same frequency and verify their performance.

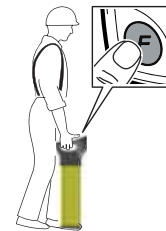

0016797\_001

2.  Once the function of the sonde has been verified, connect it to drain rods or other means of guiding it.

Insert the sonde into the pipe, duct, conduit or drain.

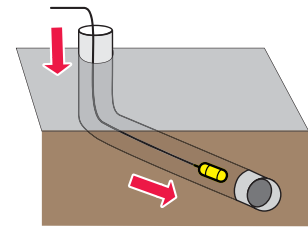

16441.001

3. Walk in line with the suspected direction of travel observing the display. The signal strength indicator rises and falls as you pass over the ghost signal at the back of the sonde, the peak signal over the sonde and the ghost signal at the front. The Numeric Peak Indicator displays its highest value when detecting the peak signal.

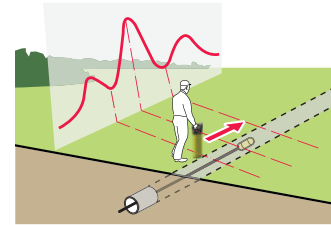

0016817.001

4. Retrace your steps and position the locator directly over the peak signal. Move the locator left and right until the highest numeric reading is obtained. This reading indicates the location of the sonde.

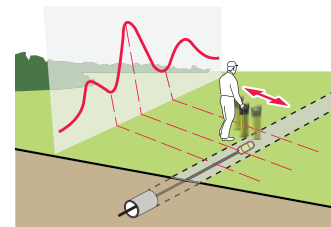

0016818.001

## 6

## Estimating Depth and Current of a Utility

### 6.1

### Utility Line Depth

#### Taking a depth reading

- ☞ For utility line depth, the locator needs to be used in conjunction with a signal transmitter. Refer to [5.4 Using the Transmitter in Induction Mode](#) and [5.5 Using the Transmitter in Connection Mode](#).

1. Set the locator to the required Signal Transmitter frequency.

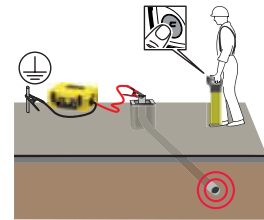

2. Position the locator directly over and at 90° to the direction of the utility.

☞ Ensure that the locator foot is directly on the ground.

☞ Hold the locator upright and take care not to move it.

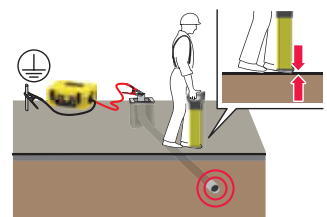

3. Press and release the Depth Estimation key.

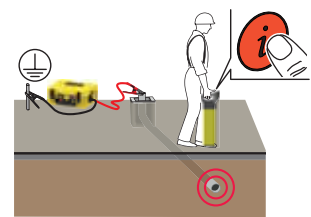

4. The Line Depth screen displays the measured depth.  
*DD130 and DD175: The measured current (mA) is subsequently displayed.*

☞ Lift the locator off the ground by approximately 15 cm/6 in and take a second depth reading. This depth reading should confirm the added height.

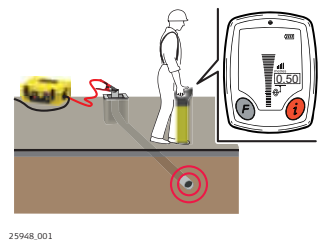

5. The depth is calculated as distance to the centre of the utility! Allowances should be taken into account.

**Note the difference between a and b!**

- a) Actual depth of the utility.
- b) Displayed depth reading: Depth to the centre of the utility.

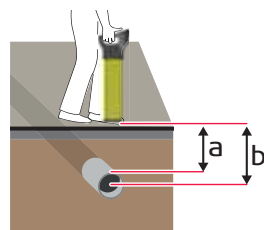

## 6.2

## Sonde Depth

### Taking a depth reading

☞ For sonde depth, the locator needs to be used in conjunction with a sonde. Refer to [5.9 How to Use the Sondes](#).

1. Set the locator to the required Sonde frequency.

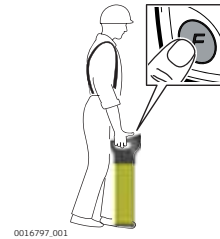

2. Position the locator directly over and in line with the sonde.

- ☞ Ensure that the locator foot is directly on the ground.
- ☞ Hold the locator upright and take care not to move it.

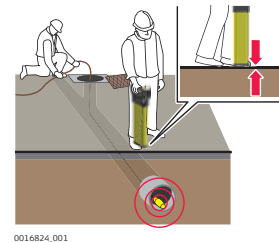

3. Press and hold the Depth Estimation key.

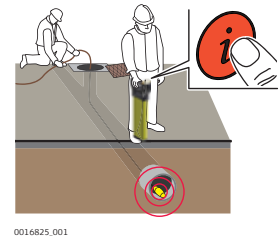

4. The Sonde Depth screen displays the measured depth.

- ☞ Lift the locator off the ground by approximately 15 cm/6 in and take a second depth reading. This depth reading should confirm the added height.

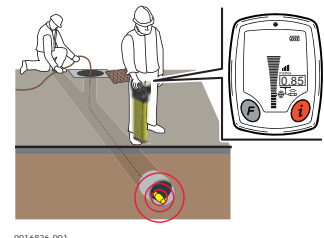

5. The depth is calculated as distance to the sonde within the pipe or duct! Take into account allowances for the diameter of the pipe or duct.

**Note the difference between a and b!**

- a) Actual depth of the utility.
- b) Displayed depth reading: Depth to the sonde.

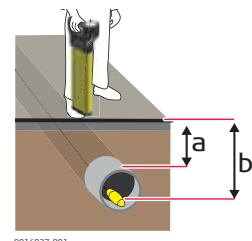

## 6.3

## Depth Code Information

### Depth Code Screens

☞ If it is not possible to take a depth reading, a depth code is displayed as detailed.



### Identifying a utility

The signal transmitter is used to apply a signal (current) to the utility to be traced. The signal can couple onto additional utilities making it difficult to distinguish by conventional locating techniques.

Current measurement helps to identify the utility to which the transmitter is attached by providing the highest current reading (mA). Unlike the Numeric Peak reading, the current reading is not effected by changing depth levels.

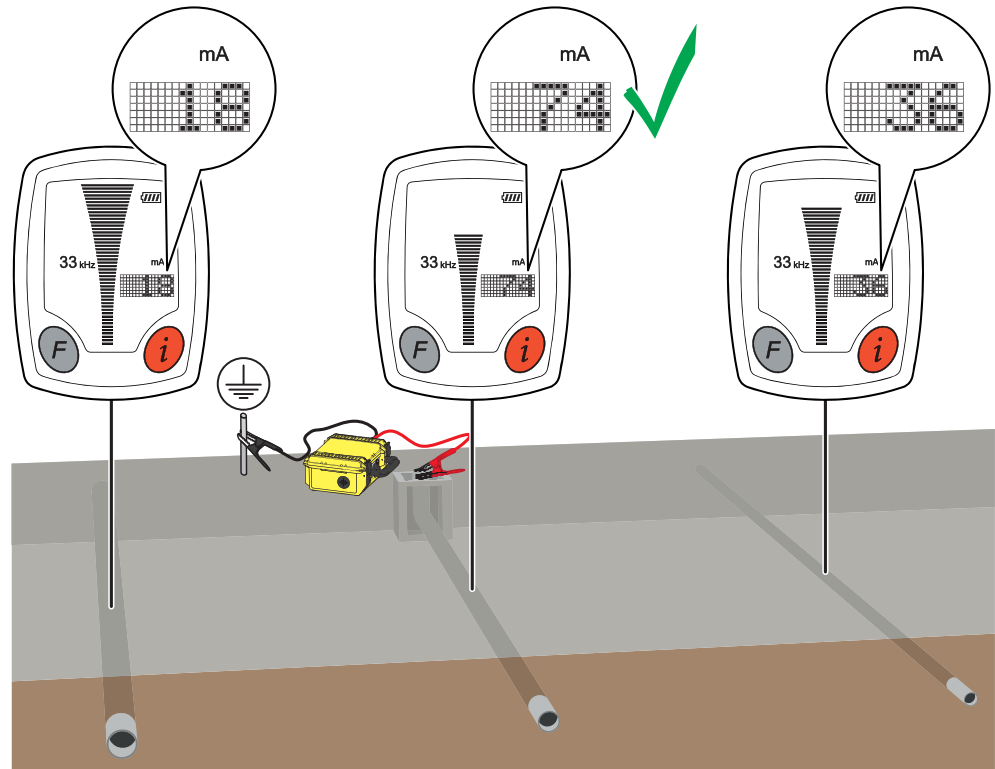

0016949\_001

### Identifying the utility layout and condition

The signal (current) applied by the transmitter decreases at a uniform rate as it travels along the utility. This can help to identify the utility layout and condition.

A sudden reduction in current may indicate a fault in the utility, a damage to the insulation, or a connection off the utility.



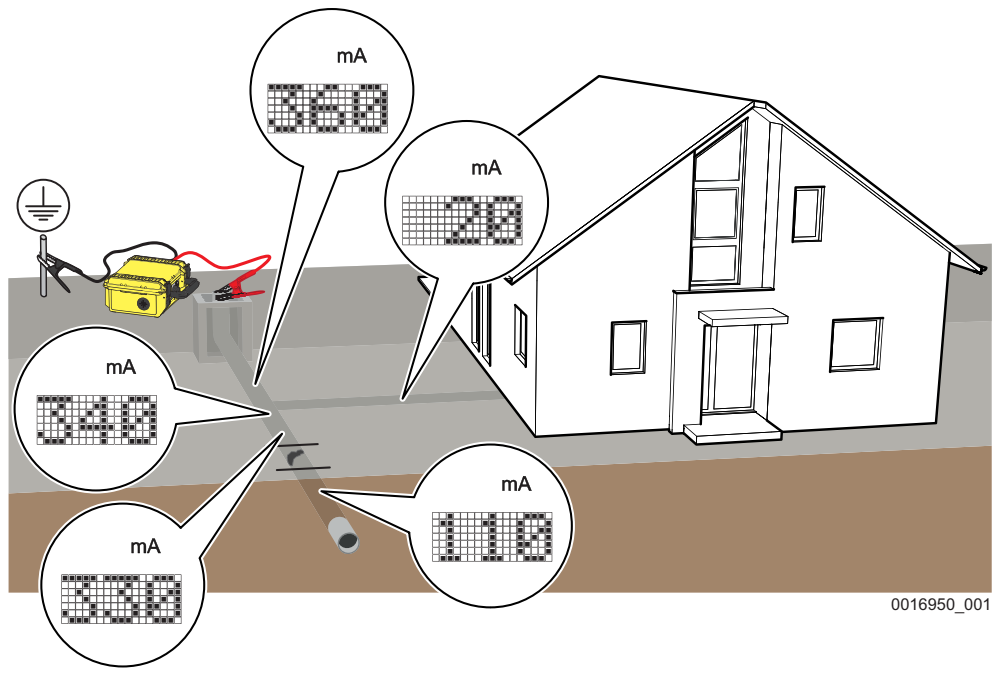

0016950\_001

**⚠ WARNING****Short circuit of battery terminals**

If battery terminals are short circuited e.g. by coming in contact with jewellery, keys, metallised paper or other metals, the battery can overheat and cause injury or fire, for example by storing or transporting in pockets.

**Precautions:**

- ▶ Make sure that the battery terminals do not come into contact with metallic/conductive objects.

Use the transmitters with an authorised rechargeable Li-Ion battery pack.

**7.1****Locator Batteries****Locator Batteries**

The DD120, DD130 and DD175 Locators are fitted with six LR6 (AA) alkaline batteries

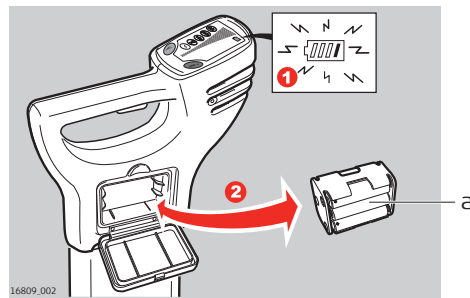
**Changing the Battery**

1. Replace or recharge the batteries when the battery status indicator is empty.
2. Press the release button to unlock the Battery Hatch. Remove the battery holder from the Locator.
3. Replace all batteries with six new LR6 (AA) type alkaline batteries, or remove and recharge the battery pack if rechargeable batteries are fitted.

**7.2****Transmitter Batteries****Changing the batteries**

The DA175 Transmitter is fitted with four LR20 (D) alkaline batteries



1. Unscrew the fastener and open the cover.
2. Replace all batteries with four new LR20 (D) type alkaline batteries. If rechargeable batteries are fitted: Remove and recharge the batteries.

 **WARNING**

**Battery pack of the signal transmitter may get hot after prolonged use**

Risk of burning injuries.

**Precautions:**

- ▶ Avoid touching the hot battery pack.
  - ▶ Allow the battery pack to cool down before removing it.
- 

 **WARNING**

**Removing the batteries of the transmitter**

Risk of electric shock.

**Precautions:**

- ▶ Before, removing the batteries switch off the transmitter and remove any cable set or accessories from the connection socket.
-

## 8 Functional Checks

---

### 8.1 Locator Health Check

---

**Checking the function** Leica Geosystems accepts no responsibility for maintenance and calibration conducted by unauthorised persons.

**Locator depth test**  If the depth reading deviates from known depth of the test utility or if an error code is displayed, return the locator for service.

---

### 8.2 Locator Functional Check

---

**Checking the function** Before any tests can be carried out it is vital to check the status of the unit, its batteries and basic functionality.

The following list is used to achieve this.

#### 1. Inspection

- **Casing:** The casing should be free of significant damage.
- **Labels:** Body labels must be legible and intact. Display label must be free of damage and tears.
- **Battery hatch:** The hatch must lock into place.
- **Battery holder:** All the battery contacts and springs on the holder must be free of corrosion and the holder in good condition.
- **Battery contacts:** The battery contacts must be free of corrosion.

Once the general condition of the Locator is established the Audio Visual test can be performed.

#### 2. Audio/Visual display test

Upon depressing the trigger the Locator should test the display and speakers by illuminating each segment in the bar display, the mode and function indicators and depth display, the battery indicator light will illuminate throughout the display test. All LCDs must be operative and an audible output must be heard.

#### 3. Battery/Functional self check

If there is no response when the trigger is activated or the low battery illuminates (or flashes) after the Audio / Visual display test, the batteries will have to be replaced. Use alkaline batteries. Replace all of the batteries at the same time.

#### Checking the performance

The purpose of the following procedure is to verify the performance of the Locator. It is important that the test is conducted away from areas of electromagnetic interference or over buried services with a large signal radiating off them.

1. Switch the Locator on.
  2. Whilst in Power mode hold down the i Button, until the settings are displayed.
  3. Using the Function Button toggle through the settings until **EST** is displayed.
  4. Press the i Button to activate the test.
-

5. Observe the displayed output:
  - **PAS** means unit is within set tolerances.
  - **ERR** means unit is outside set tolerances and may need servicing.



- Repeat the test in a different location if the units displays **ERR**.
- The Locator will automatically repeat the function test if it fails.
- Repeated failure will indicate a faulty unit, which must be returned for service.

### Checking depth indication (DD120, DD130, DD175)

This test can be carried out provided the depth of a service on the test area is known.

1. Switch the Locator on and ensure that it is in 33 kHz mode.
2. Position the Locator directly over and at right angle to the service.
3. Press and release the i Button to activate the depth measurement.
4. Record the depth.
5. If the depth reading deviates from the normal value or an error code is displayed, the Locator should be returned for service.



**If any of these tests give no response or a significantly different response from normal, the Locator should be returned for service.**

## 8.3

### Transmitter Functional Check

#### Checking the function

The purpose of the following procedure is to verify the performance of the signal Transmitter.

Before any tests can be carried out it is vital to check the status of the unit, its batteries and basic functionality.

To carry out this test the following are required:

- The Transmitters' cable Set
- Fully charged batteries

#### 1. Inspection

• <b>Casing</b>	The casing should be free of significant damage.
• <b>Cable Set</b>	The cable set should be free of damage to the cable's insulation and clip shrouds. The terminals should be free of corrosion.
• <b>Labels</b>	Body labels must be legible and intact. Display label must be free of damage and tears.
• <b>Battery hatch</b>	The hatch must lock into place.
• <b>Battery holder</b>	All the battery contacts and springs on the holder must be free of corrosion and the holder in good condition.
• <b>Battery contact</b>	The battery contacts must be free of corrosion.

Once the general condition of the Transmitter is established the Audio/ Visual test can be performed.

- |    |                                  |   |
|----|----------------------------------|---|
| 2. | <b>Audio/Visual display test</b> | Turn on the Transmitter.<br>All LED's will illuminate and the speaker will emit a tone.<br>All LEDs must be operative and an audible output must be heard.  |
| 3. | <b>Battery check</b>             | The battery indicator flashes to indicate a poor battery condition.<br>Replace all batteries with four new LR20 (D) type alkaline batteries.<br>If rechargeable batteries are fitted:<br>Remove and recharge the battery pack |

 **WARNING**

**Output of potentially lethal voltages from the transmitter**

Risk of electric shock.



**Precautions:**

- ▶ Care should be taken, when handling exposed or non-insulated connections, including the connection cables sets, the earth pin and the connection to the service. Notify others who may be working on or around the service.

**Checking the performance**

The purpose of the following procedure is to verify the performance of the transmitter.

- |   |  |   |               |                             |                    |   |               |                     |
|---|--|---|---------------|-----------------------------|--------------------|---|---------------|---------------------|
|  | Conduct the test away from areas of electromagnetic interference or over buried utilities with a large signal radiating off them.  |   |               |                             |                    |   |               |                     |
| 1.  | Plug the transmitters cable set into the connection socket.  |   |               |                             |                    |   |               |                     |
| 2.  | Connect the black and red cable clips together, ensuring good metal to metal contact.  |   |               |                             |                    |   |               |                     |
| 3.  | Press and hold the Frequency key and switch on the transmitter. Keep holding the Frequency key until the extended self test commenced.   |   |               |                             |                    |   |               |                     |
| 4.  | Observe the displayed output during the performance check:<br>The Frequency LED indicators light up one after the other, showing the frequency on test.<br>The Connection Mode LED indicator lights up. The Frequency LED indicators light up, showing the frequencies on test. The Connection Mode LED indicator turns off. |   |               |                             |                    |   |               |                     |
|   | <b>Induction Mode Test:</b>  | <table border="1"> <tr> <td>Mode Display:</td> <td>Induction LED illuminated.</td> </tr> <tr> <td>Frequency Display:</td> <td>Frequency LED illuminates showing the frequency on test.</td> </tr> <tr> <td>Mode Display:</td> <td>Induction LED off.</td> </tr> </table>    | Mode Display: | Induction LED illuminated.  | Frequency Display: | Frequency LED illuminates showing the frequency on test.  | Mode Display: | Induction LED off.  |
| Mode Display:   | Induction LED illuminated.   |   |               |                             |                    |   |               |                     |
| Frequency Display:  | Frequency LED illuminates showing the frequency on test.   |   |               |                             |                    |   |               |                     |
| Mode Display:   | Induction LED off.   |   |               |                             |                    |   |               |                     |
|   | <b>Connection Mode Test:</b>   | <table border="1"> <tr> <td>Mode Display:</td> <td>Connection LED illuminated.</td> </tr> <tr> <td>Frequency Display:</td> <td>Frequency LEDs illuminates showing the frequency on test.</td> </tr> <tr> <td>Mode Display:</td> <td>Connection LED off.</td> </tr> </table> | Mode Display: | Connection LED illuminated. | Frequency Display: | Frequency LEDs illuminates showing the frequency on test. | Mode Display: | Connection LED off. |
| Mode Display:   | Connection LED illuminated.  |   |               |                             |                    |   |               |                     |
| Frequency Display:  | Frequency LEDs illuminates showing the frequency on test.  |   |               |                             |                    |   |               |                     |
| Mode Display:   | Connection LED off.  |   |               |                             |                    |   |               |                     |



5.	After the performance check, the transmitter displays the result:	
<b>Pass</b>	Battery indicator:	LED flashes - if tested with poor batteries.
	Audible Output:	High - low pulsed tone emitted three times.
<b>Fail</b>	Battery indicator:	LED flashes - if tested with poor batteries.
	Audible Output:	Low pitch tone emitted.
	Mode Display:	Induction or Connection LED illuminated to show failure mode.
	Frequency Display:	Frequency LED illuminated to show frequency failure.
	If the performance check fails, ensure that the cable set of the transmitter is fully engaged and the clips are connected.	
	If the performance check fails: Transmitter automatically repeats the check. Repeated failure indicates a faulty unit. Return Transmitter for service.	
	If any of these tests give no response or a significantly different response from normal, the Transmitter should be returned for service.	

## 8.4

### Functional Check of the Trace Rod

#### Checking the performance

The purpose of the following procedure is to verify the performance of the trace rod.

- |   |   |
|---|---|
|  | For this procedure, the following system components are required: <ul style="list-style-type: none"> <li>• A transmitter for generating the signal in the Sonde and Line mode tests.</li> <li>• The cable set for the transmitter.</li> </ul> |
| 1.  | Plug the transmitters cable set into the connection socket.   |
| 2.  | Connect the red cable to the positive (+) terminal on the trace rod and the black cable to the negative (-) terminal.   |
| 3.  | Turn on the transmitter.  |
| 4.  | Use the Power Output key on the transmitter to adjust the power output to minimum.<br>The transmitter should emit a constant tone.  |
| 5.  | Disconnect the black cable from the negative (-) terminal.<br>The transmitter should emit a pulsed tone.  |
|  | If for any of these tests no output or a significantly different output is displayed, return the trace rod for service.   |

## 8.5

### Functional Check of the Sonde

#### Checking the function

Before you carry out any tests, it is vital to check the status of the unit, its batteries and its basic functionality. To achieve this, carry out the following procedure:

1. **Inspect the general condition of the sonde.**
  - The casing should be free of significant damage.
  - The sealing ring and the screw thread should be intact.
2. **Once the general condition of the sonde is established, perform the LED test.**

Turn on the sonde. The LED indicator should light up.
3. **Perform a Battery check.**

If the LED indicator lights up faintly or if the sonde does not transmit a signal, the batteries are probably low. Replace the batteries if necessary.

#### Checking the performance

The purpose of the following procedure is to verify the performance of the sonde.

- ☞ For this procedure, the following system components are required:
- A locator to detect the signal of the sonde.
  - A work area free of utilities (as illustrated).

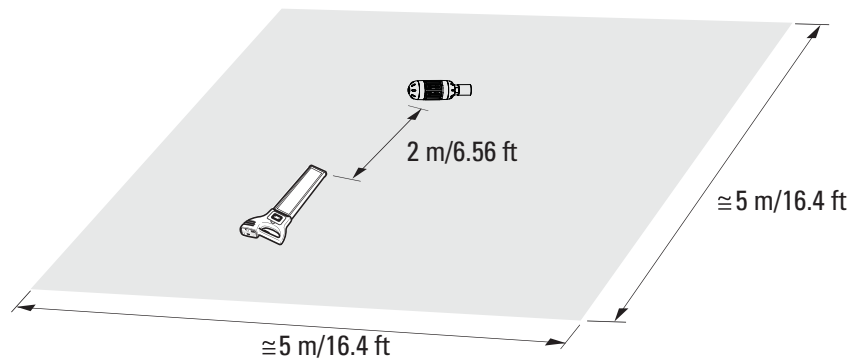

0016948\_001

1. Set up the sonde for use at 33 kHz.
  2. Turn on the locator. Set the locator to 33 kHz.
  3. Aim the locator foot at the sonde.

☞ At a distance of 2 m/6.56 ft, the signal strength indicators should display a peak reading.
  4. Set up the sonde for use at 8 kHz.
  5. Turn on the locator. Set the locator to 8 kHz.
  6. Aim the locator foot at the sonde.

☞ At a distance of 2 m/6.56 ft, the signal strength indicators should display a peak reading.
- ☞ If for any of these tests no output or a significantly different output is displayed, return the sonde for service.



## 9 Care and Transport

---

### 9.1 Transport

---

**Transport in the field** When transporting the equipment in the field, always make sure that you carry the product in its original packaging or equivalent, and protect the equipment against shock and vibration.

---

**Transport in a road vehicle** Never carry the product loose in a road vehicle, as it can be affected by shock and vibration. Always carry the product in its container and secure it.  
For products for which no container is available use the original packaging or its equivalent.

---

**Shipping** When transporting the product by rail, air or sea, always use the complete original Leica Geosystems packaging, container and cardboard box, or its equivalent, to protect against shock and vibration.

---

**Shipping, transport of batteries** When transporting or shipping batteries, the person responsible for the product must ensure that the applicable national and international rules and regulations are observed. Before transportation or shipping, contact your local passenger or freight transport company.

---

### 9.2 Storage

---

**Product** Respect the temperature limits when storing the equipment, particularly in summer if the equipment is inside a vehicle. Refer to [10 Technical Data](#) for information about temperature limits.

---

**Storing** Long-term battery storage is not recommended. If storage is necessary:

- Refer to [10 Technical Data](#) for information about storage temperature range
- Remove batteries from the product and the charger before storing
- After storage recharge batteries before using
- Protect batteries from damp and wetness. Wet or damp batteries must be dried before storing or use
- A storage temperature range of 0 °C to +30 °C/+32 °F to +86 °F in a dry environment is recommended to minimise self-discharging of the battery
- At the recommended storage temperature range, batteries containing a 40% to 50% charge can be stored for up to one year. After this storage period the batteries must be recharged
- Always try to use a 'first-in first-out' approach to minimise storage time

---

### 9.3 Cleaning and Drying

---

**Damp products** Dry the product, the transport container, the foam inserts and the accessories at a temperature not greater than 40°C/104°F and clean them. Do not repack until everything is dry. Always close the transport container when using in the field.

---

**Cables and plugs** Keep plugs clean and dry. Blow away any dirt lodged in the plugs of the connecting cables.

---

Labelling  
DD120, DD130,  
DD175 locators

DD120:



Model:	Art No:	S.No.:	YYYY
DD120	872938	XXXXXX	2022

Power:

Ex I/RS0AA Alkaline  
 BV  $\leq$  nominal / 200mA max.  
 Leica Geosystems AG  
 Hirschle-Weg-Strasse  
 CH-6405 Heerbrugg  
 Made in the UK

This device complies with part 15 of the FCC Rules. Operation is subject to the following conditions: (1) This device may not cause harmful interference, and (2) this device must accept any interference received, including interference that may cause undesired operation.

CE UK CA

CB Importer: Leica Geosystems Ltd.  
 Leica Geosystems AG  
 Hirschle-Weg-Strasse  
 CH-6405 Heerbrugg  
 Made in the UK

25423\_001

DD130:



Model:	Art No:	S.No.:	YYYY
DD130	872940	XXXXXX	2022

Power:

Ex I/RS0AA Alkaline  
 BV  $\leq$  nominal / 200mA max.  
 Leica Geosystems AG  
 Hirschle-Weg-Strasse  
 CH-6405 Heerbrugg  
 Made in the UK

This device complies with part 15 of the FCC Rules. Operation is subject to the following conditions: (1) This device may not cause harmful interference, and (2) this device must accept any interference received, including interference that may cause undesired operation.

CE UK CA

CB Importer: Leica Geosystems Ltd.  
 Leica Geosystems AG  
 Hirschle-Weg-Strasse  
 CH-6405 Heerbrugg  
 Made in the UK

25424\_001

DD175:



Model:	Art No:	S.No.:	YYYY
DD175	949120	XXXXXX	2022

Power:

Ex I/RS0AA Alkaline  
 BV  $\leq$  nominal / 200mA max.  
 Leica Geosystems AG  
 Hirschle-Weg-Strasse  
 CH-6405 Heerbrugg  
 Made in the UK

This device complies with part 15 of the FCC Rules. Operation is subject to the following conditions: (1) This device may not cause harmful interference, and (2) this device must accept any interference received, including interference that may cause undesired operation.

CE UK CA

CB Importer: Leica Geosystems Ltd.  
 Leica Geosystems AG  
 Hirschle-Weg-Strasse  
 CH-6405 Heerbrugg  
 Made in the UK

16740\_002

**Labelling DA series transmitters**

**DA175:**



Leica Geosystems  
Hansch-Wild-Strasse  
CH-9435 Heerbrugg  
Made in the UK

Power: 3  
Std. 920 (2) Alkaline  
EV normal / 2A Max.

GB Importer: Leica Geosystems Ltd.  
Garage House, Michigan Drive,  
Kingsthorpe, Northampton, NN16 9JT

Model:	Art No:	S.No.:	YYYY
DA175	949121	XXXXXX	2022

FCC ID: RFD-DA175  
IC: 3176-DA175

112708\_002

**10.1.1**

**Products without radio (USA: Only valid for DD120/DD130)**

**USA**

FCC Part 15, Part 15 B

This equipment has been tested and found to comply with the limits for a Class B digital device, pursuant to part 15 of the FCC Rules.

These limits are designed to provide reasonable protection against harmful interference in a residential installation.

This equipment generates, uses, and can radiate radio frequency energy and, if not installed and used in accordance with the instructions, it may cause harmful interference to radio communications.

However, there is no guarantee that interference does not occur in a particular installation.

If this equipment does cause harmful interference to radio or television reception, which can be determined by turning the equipment off and on, the user is encouraged to try to correct the interference by one or more of the following measures:

- Reorient or relocate the receiving antenna.
- Increase the separation between the equipment and the receiver.
- Connect the equipment into an outlet on a circuit different from that to which the receiver is connected.
- Consult the dealer or an experienced radio/TV technician for help.

Changes or modifications not expressly approved by Leica Geosystems for compliance could void the user's authority to operate the equipment.

**Canada**

CAN ICES-003 Class B/NMB-003 Class B

**Others**

The conformity for countries with other national regulations has to be approved prior to use and operation.

## 10.1.2

## Products with radio (USA: DD175/DA175; EU: All instruments)

---

### EU



Hereby, Leica Geosystems AG declares that the radio equipment type DD120/DD130/DD175/DA175 is in compliance with Directive 2014/53/EU and other applicable European Directives. The full text of the EU declaration of conformity is available at the following Internet address: <http://www.leica-geosystems.com/ce>.

---

### USA

Contains FCC ID: DD175: XPYNINAW15; DA175: RFD-DA175

FCC Part 15, Part 15 B/C

This device complies with part 15 of the FCC Rules. Operation is subject to the following two conditions:

1. This device may not cause harmful interference, and
2. This device must accept any interference received, including interference that may cause undesired operation.

This equipment has been tested and found to comply with the limits for a Class B digital device, pursuant to part 15 of the FCC Rules.

These limits are designed to provide reasonable protection against harmful interference in a residential installation.

This equipment generates, uses, and can radiate radio frequency energy and, if not installed and used in accordance with the instructions, it may cause harmful interference to radio communications.

However, there is no guarantee that interference does not occur in a particular installation.

If this equipment does cause harmful interference to radio or television reception, which can be determined by turning the equipment off and on, the user is encouraged to try to correct the interference by one or more of the following measures:

- Reorient or relocate the receiving antenna.
  - Increase the separation between the equipment and the receiver.
  - Connect the equipment into an outlet on a circuit different from that to which the receiver is connected.
  - Consult the dealer or an experienced radio/TV technician for help.
- 

Changes or modifications not expressly approved by Leica Geosystems for compliance could void the user's authority to operate the equipment.

---

### Canada

CAN ICES-003 Class B/NMB-003 Class B

Contains IC: DD175: 8595A-NINAW15; DA175: 3177A-DA175

---

#### Canada Compliance Statement

This device contains licence-exempt transmitter(s)/receiver(s) that comply with Innovation, Science and Economic Development Canada's licence-exempt RSS(s). Operation is subject to the following two conditions:

1. This device may not cause interference
2. This device must accept any interference, including interference that may cause undesired operation of the device

### Canada Déclaration de Conformité

L'émetteur/récepteur exempt de licence contenu dans le présent appareil est conforme aux CNR d'Innovation, Sciences et Développement économique Canada applicables aux appareils radio exempts de licence. L'exploitation est autorisée aux deux conditions suivantes:

1. L'appareil ne doit pas produire de brouillage
2. L'appareil doit accepter tout brouillage radioélectrique subi, même si le brouillage est susceptible d'en compromettre le fonctionnement

---

### Radio Frequency (RF) Exposure Compliance Statement

The radiated RF output power of the instrument is below the Health Canada's Safety Code 6 exclusion limit for portable devices (radiated element separation distance between the radiating element and user and/or bystander is below 20 cm).

### Others

The conformity for countries with other national regulations has to be approved prior to use and operation.

## 10.2

### Transmitter Technical Data

#### DA series signal transmitters

<b>Induction</b>	Up to 1 Watt max.
<b>Connection mode</b>	1 Watt, when connected to a buried utility with an impedance of 300 Ohms
<b>Operating transmission frequencies</b>	32.768 (33) kHz 8.192 (8) kHz 512 Hz (DD130, DD175 models) 640 Hz (DD130, DD175 models)
<b>Display panel</b>	LED Indicators: Battery low indicator Connection mode Frequency indicator Power Output indicator
<b>Keypad</b>	4 membrane push buttons
<b>Audio</b>	85 dBA @ 30 cm Induction mode: Pulsed output with a differing rate for each frequency Connection mode: Low - No output: pulsed output, differing rate for each frequency Good Connection output: constant tone, pitch dependent on power output
<b>Battery type</b>	4 × LR20 Alkaline batteries, supplied
<b>Typical operating time 1 Watt</b>	15 hours at power level 2 connection mode
<b>Dimensions</b>	250 × 206 × 113 mm/9.84 × 8.11 × 4.45 inches
<b>Weight (incl. standard accessories and batteries)</b>	2.5 kg with batteries
<b>Temperature</b>	Operating -20 °C to +50 °C -4 °F to +122 °F

	Storage	-40 °C to +70 °C	-40 °F to +158 °F
<b>Protection against water, dust and sand</b>	DA175	Open: IP65 (IEC 60529)	Closed: IP67 (IEC 60529)
<b>Pollution degree</b>	4	Electrical equipment for outdoor use	
<b>Humidity</b>	95% RH non condensing The effects of condensation are to be effectively counteracted by periodically drying out the product.		
<b>Altitude</b>	Operation	0 m to 5500 m	0 ft to 18000 ft
	Storage	0 m to 12000 m	0 ft to 39500 ft
<b>Sound level</b>	< 80 dB(A)		
<b>Approvals</b>	CE, FCC		

## Dimensions



## 10.3

DD120, DD130,  
DD175 locators

## Locator Technical Data

### Operating frequencies

Mode	Frequency
<b>Power</b>	50 Hz or 60 Hz mains electrical and harmonics
<b>Radio</b>	15 kHz to 60 kHz
<b>Auto</b>	Power, Radio, 33 kHz
<b>Transmitter</b>	32.768 (33) kHz 8.192 (8) kHz 512 Hz (DD130, DD175 models) 640 Hz (DD130, DD175 models)

### Depth estimation

Locator	DD120	DD130	DD175
<b>Depth range</b>	Line 0.3 m to 3 m	Line 0.3 m to 3 m	Line 0.3 m to 3 m
	Sonde 0.3 m to 3 m	Sonde 0.1 m to 9.99 m	Sonde 0.1 m to 9.99 m
<b>Depth accuracy</b> Undistorted signal	10%	10%	10%

### General technical data

Mode	Output
<b>Display panel</b>	Monochrome
<b>Keypad</b>	2 membrane push buttons
<b>Audio</b>	85 dBA @ 30 cm Power, Radio and Auto mode: Continuous tone (different pitch for each mode). 8 kHz and 33 kHz mode: All tones are different. Pulsed tone (different pitch for each mode). 512 Hz and 640 Hz mode: Pulsed tone (different pitch for each mode). All tones are different.
Internal data storage (DD175 model)	64 MB
Data logging (DD175 model)	Yes
Connectivity (DD175 model)	Bluetooth
Internal GPS (GPS model)	Yes
<b>Battery type</b>	6 × LR6 (AA) alkaline
<b>Typical operating time</b>	15 hours constant use at 20 °C/68 °F
<b>Dimensions</b>	85 × 250 × 760 mm/3.4 × 10 × 30 inches
<b>Weight (incl. batteries)</b>	2.7 kg with batteries
<b>Temperature</b>	Operating -20 °C to +50 °C -4 °F to +122 °F
	Storage -40 °C to +70 °C -40 °F to +158 °F
<b>Protection against water, dust and sand</b>	DD120, IP54 (IEC 60529) DD130, DD175
<b>Pollution degree</b>	4 Electrical equipment for outdoor use

Mode	Output
Humidity	95% RH non condensing The effects of condensation are to be effectively counteracted by periodically drying out the product.
Altitude	Operation 0 m to 5500 m 0 ft to 18000 ft
	Storage 0 m to 12000 m 0 ft to 39500 ft
Sound level	< 80 dB(A)

## Dimensions



## 10.4

### Conductive Rod Technical Data

#### Conductive rod

Description	Value
Typical detection range	Both modes, line and sonde: Typical 3.0 m/ 10 ft
Tracing distance	50 m/165 ft; 80 m/263 ft (maximum). Reel length dependant.
Operating transmission frequencies	Dependent on transmitter
Dimensions	440 x 210 x 490 mm/ 17.3 x 8.3 x 19.3 inches
Weight	50 m: 4 kg/8.8 lbs 80 m: 4.7 kg/10.4 lbs



## Dimensions

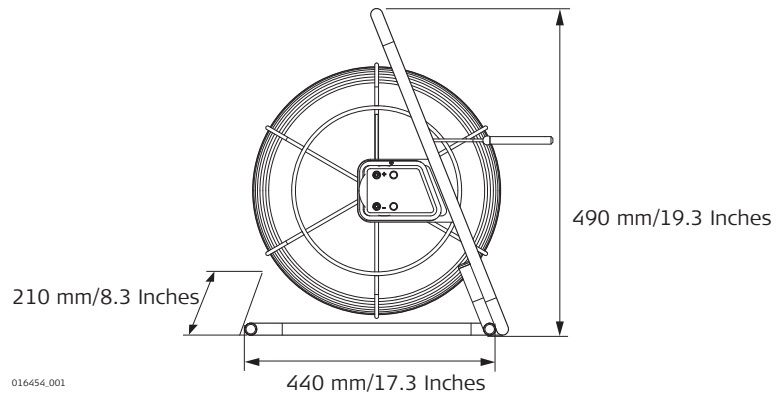

## 10.5

### Property Plug Connector Technical Data

#### Property plug connector

<b>Operating transmission frequencies</b>	32.768 (33) kHz
<b>Temperature</b>	Operating -20 °C to +50 °C -4 °F to +122 °F
	Storage -40 °C to +70 °C -40 °F to +158 °F
<b>Protection against water, dust and sand</b>	IP54 (IEC 60529) Dust-protected
<b>Humidity</b>	95% RH non condensing The effects of condensation are to be effectively counteracted by periodically drying out the product.
<b>Dimensions</b>	100 × 80 mm/3.9 × 3.1 inches
<b>Weight</b>	0.15 kg/0.3 lbs

## Dimensions

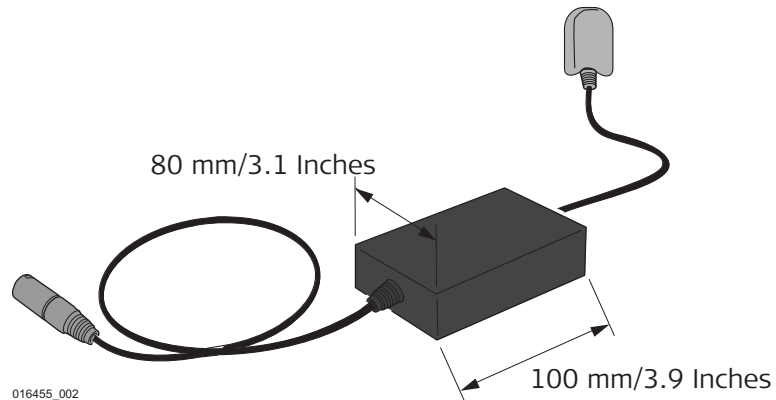

## Appendix A World Frequency Zones

---

### World Frequency Zones

#### North America

Canada	120 V / 60 Hz
United States	120 V / 60 Hz
Mexico	120 V / 50 Hz, 60 Hz

#### Central America

Bahamas	115 V / 60 Hz
Barbados	115 V / 50 Hz
Belize	110-220 V / 60 Hz
Bermuda	115 V / 60 Hz
Costa Rica	120 V / 60 Hz
Cuba	115-120 V / 60 Hz
Dominican Republic	110-220 V / 60 Hz
El Salvador	120-240 V / 60 Hz
Guatemala	115-230 V / 60 Hz
Haiti	110-220 V / 60 Hz
Honduras	110-220 V / 60 Hz
Jamaica	220 V / 50 Hz
Netherland Antilles	110-127 V / 50 Hz
Nicaragua	120 V / 60 Hz
Panama	120 V / 60 Hz
Puerto Rico	120 V / 60 Hz
Trinidad & Tobago	115-230 V / 60 Hz
Virgin Islands	120 V / 60 Hz

#### South America

Argentina	230 V / 50 Hz
Bolivia	110 V / 50 Hz
Brazil	110-127-220 V / 60 Hz
Chile	220 V / 50 Hz
Colombia	110-220 V / 60 Hz
Ecuador	110-220 V / 60 Hz
French Guiana	220 V / 50 Hz
Guyana	110-240 V / 60 Hz
Paraguay	220 V / 60 Hz
Peru	220 V / 60 Hz
Surinam	110-127 V / 60
Uruguay	220 V / 50 Hz
Venezuela	120-240 V / 60 Hz

#### Australia, Oceania

Australia	240 V / 50
Fiji Islands	240 V / 50
New Zealand	230 V / 50 H
Solomon Island	240 V / 50
Tonga	230 V / 50 H

**Europe**

Albania	230 V / 50 Hz
Austria	230 V / 50 Hz
Belgium	230 V / 50 Hz
Belarus	230 V / 50 Hz
Croatia	230 V / 50 Hz
Cyprus	240 V / 50 Hz
Czech Republic	230 V / 50 Hz
Denmark	230 V / 50 Hz
Estonia	230 V / 50 Hz
Finland	230 V / 50 Hz
France	230 V / 50 Hz
Germany	230 V / 50 Hz
Greece	230 V / 50 Hz
Hungary	230 V / 50 Hz
Iceland	230 V / 50 Hz
Ireland	230 V / 50 Hz
Italy	230 V / 50 Hz
Latvia	230 V / 50 Hz
Lithuania	230 V / 50 Hz
Luxemburg	230 V / 50 Hz
Moldavia	230 V / 50 Hz
Netherlands	230 V / 50 Hz
Norway	230 V / 50 Hz
Poland	230 V / 50 Hz
Portugal	230 V / 50 Hz
Romania	230 V / 50 Hz
Russia	230 V / 50 Hz
Slovakia	230 V / 50 Hz
Slovenia	230 V / 50 Hz
Spain	230 V / 50 Hz
Sweden	230 V / 50 Hz
Switzerland	230 V / 50 Hz
Ukraine	230 V / 50 Hz
United Kingdom	230 V / 50 Hz

**Africa**

Algeria	127-220 V / 50 Hz
Angola	220 V / 50 Hz
Benin	220 V / 50 Hz
Botswana	220 V / 50 Hz
Burkina Faso	220 V / 50 Hz
Burundi	220 V / 50 Hz
Cameroon	127-220 V / 50 Hz
Central Africa Republic	220 V / 50 Hz
Chad	220 V / 50 Hz
Congo	220 V / 50 Hz
Dahomey	220 V / 50 Hz
Egypt	220 V / 50 Hz
Ethiopia	220 V / 50 Hz
Gabon	220 V / 50 Hz
Gambia	230 V / 50 Hz
Ghana	240 V / 50 Hz
Ivory Coast	220 V / 50 Hz
Kenya	240 V / 50 Hz
Lesotho	220-240 V / 50 Hz
Liberia	120 V / 60 Hz
Libya	115-220 V / 50 Hz
Malawi	230 V / 50 Hz
Mali	220 V / 50 Hz
Mauritania	220 V / 50 Hz
Mauritius	230 V / 50 Hz
Marocco	127-220 V / 50 Hz
Mozambique	220 V / 50 Hz
Namibia	220 V / 50 Hz
Niger	220 V / 50 Hz
Nigeria	230 V / 50 Hz
Rwanda	220 V / 50 Hz
Senegal	110 V / 50 Hz
Sierra Leone	230 V / 50 Hz
Somalia	220 V / 50 Hz
South Africa	220-240 V / 50 Hz
Sudan	240 V / 50 Hz
Swaziland	220 V / 50 Hz
Tanzania	230 V / 50 Hz
Togo	127-220 V / 50 Hz
Tunesia	127-220 V / 50 Hz
Uganda	240 V / 50 Hz
Zaire	220 V / 50 Hz
Zambia	220 V / 50 Hz
Zimbabwe	220 V / 50 Hz

## Asia

Abu Dhabi	230 V / 50 Hz
Afghanistan	220 V / 50 Hz
Armenia	220 V / 50 Hz
Azerbaijan	220 V / 50 Hz
Bahrain	110-230 V / 50 Hz, 60 Hz
Bangladesh	230 V / 50 Hz
Brunei	240 V / 50 Hz
Cambodia	220 V / 50 Hz
China	220 V / 50 Hz
Georgia	220 V / 50 Hz
Hong Kong	220 V / 50 Hz
India	230-250 V / 50 Hz, 60 Hz
Indonesia	127-220 V / 50 Hz
Iran	220 V / 50 Hz
Iraq	220 V / 50 Hz
Israel	230 V / 50 Hz
Japan	110-220 V / 50 Hz, 60 Hz
Jordan	220 V / 50 Hz
Kazakhstan	220 V / 50 Hz
Kirgizstan	220 V / 50 Hz
Korea (North)	220 V / 50 Hz
Korea (South)	110-220 V / 60 Hz
Kuwait	240 V / 50 Hz
Laos	220 V / 50 Hz
Lebanon	110-220 V / 50 Hz
Malaysia	240 V / 50 Hz
Myanmar	240 V / 50 Hz
Oman	240 V / 50 Hz
Pakistan	230 V / 50 Hz
Philippines	110-220 V / 60 Hz
Qatar	240 V / 50 Hz
Saudi Arabia	127-220 V / 50 Hz
Singapore	230 V / 50 Hz
Sri Lanka	230 V / 50 Hz
Syria	220 V / 50 Hz
Taiwan	110-220 V / 60 Hz
Tajikistan	220 V / 50 Hz
Thailand	220 V / 50 Hz
Turkey	220 V / 50 Hz
Turkmenistan	220 V / 50 Hz
United Arab Emirates	220 V / 50 Hz
Uzbekistan	220 V / 50 Hz
Vietnam	110-220 V / 50 Hz
Yemen	220 V / 50 Hz



**976157-3.0.0en**

Original text

Published in Switzerland, © 2022 Leica Geosystems AG



- when it has to be **right**



**Leica Geosystems AG**

Heinrich-Wild-Strasse  
9435 Heerbrugg  
Switzerland

[www.leica-geosystems.com](http://www.leica-geosystems.com)

