



# Leica CS10/CS15

## User Manual



Version 4.0  
English

- when it has to be **right**

*Leica*  
Geosystems

---

## Introduction

---

### Purchase



Congratulations on the purchase of a Leica CS10/CS15.

---

This manual contains important safety directions as well as instructions for setting up the product and operating it. Refer to "5 Safety Directions" for further information.

Read carefully through the User Manual before you switch on the product.

---

### Product identification

The type and serial number of your product are indicated on the type plate. Enter the type and serial number in your manual and always refer to this information when you need to contact your agency or Leica Geosystems authorised service workshop.





Type: \_\_\_\_\_

Serial No.: \_\_\_\_\_

---

## Symbols

The symbols used in this manual have the following meanings:

Type	Description
 <b>Danger</b>	Indicates an imminently hazardous situation which, if not avoided, will result in death or serious injury.
 <b>Warning</b>	Indicates a potentially hazardous situation or an unintended use which, if not avoided, could result in death or serious injury.
 <b>Caution</b>	Indicates a potentially hazardous situation or an unintended use which, if not avoided, may result in minor or moderate injury and/or appreciable material, financial and environmental damage.
	Important paragraphs which must be adhered to in practice as they enable the product to be used in a technically correct and efficient manner.

**Trademarks**



- Windows is a registered trademark of Microsoft Corporation in the United States and other countries
- CompactFlash and CF are trademarks of SanDisk Corporation
- Bluetooth is a registered trademark of Bluetooth SIG, Inc.
- SD is a trademark of the SD Card Association



All other trademarks are the property of their respective owners.



**Validity of this manual**

This manual applies to the CS10 and CS15 field controllers. Differences between the various models are marked and described.

**Available documentation**

Name	Description/Format		
CS10/CS15 User Manual	All instructions required in order to operate the product to a basic level are contained in the User Manual. Provides an overview of the product together with technical data and safety directions.	✓	✓

Name	Description/Format		
Viva GNSS Getting Started Guide	Describes the general working of the product in standard use. Intended as a quick reference field guide.	✓	✓

Name	Description/Format		
Viva TPS Getting Started Guide	Describes the general working of the product in standard use. Intended as a quick reference field guide.	✓	✓
Viva Series Technical Reference Manual	Overall comprehensive guide to the product and application functions. Included are detailed descriptions of special software/hardware settings and software/hardware functions intended for technical specialists.		✓

**Refer to the following resources for all CS10/CS15 documentation/software:**

- the Leica Viva Series DVD
- <https://myworld.leica-geosystems.com>



myWorld@Leica Geosystems (<https://myworld.leica-geosystems.com>) offers a wide range of services, information and training material. With direct access to myWorld, you are able to access all relevant services whenever it is convenient for you, 24 hours a day, 7 days per week. This increases your efficiency and keeps you and your equipment instantly updated with the latest information from Leica Geosystems.

---

Service	Description
myProducts	Simply add all Leica Geosystems products that you and your company own. View detailed information on your products, buy additional options or Customer Care Packages (CCPs), update your products with the latest software and keep up-to-date with the latest documentation.
myService	View the service history of your products in Leica Geosystems Service Centers and detailed information on the services performed on your products. For your products that are currently in Leica Geosystems Service Centers view the current service status and the expected end date of service.
mySupport	Create new support requests for your products that will be answered by your local Leica Geosystems Support Team. View the complete history of your Support and view detailed information on each request in case you want to refer to previous support requests.
myTraining	Enhance your product knowledge with the Leica Geosystems Campus - Information, Knowledge, Training. Study the latest online training material or download training material on your products. Keep up-to-date with the latest News on your products and register for Seminars or Courses in your country.

---

# Table of Contents

---

In this manual	Chapter	Page
	<b>1 Description of the System</b>	<b>11</b>
	1.1 Overview	11
	1.2 Terminology	12
	1.3 System Concept	14
	1.3.1 Software Concept	14
	1.3.2 Power Concept	18
	1.3.3 Data Storage Concept	20
	1.4 CS Components	22
	1.4.1 CS10	22
	1.4.2 CS15	24
	1.5 Docking Station Components	26
	<b>2 User Interface</b>	<b>27</b>
	2.1 Keyboard	27
	2.2 Operating Principles	33
	<b>3 Operation</b>	<b>34</b>
	3.1 Equipment Setup	34

---

3.1.1	Fixing the Display Foil to the CS	34
3.1.2	Fixing a Hand Strap to the CS	36
3.1.3	Fixing the Slot Cover to the CS	38
3.1.4	Inserting and Removing a SIM Card	39
3.1.5	Setting up the Docking Station	41
3.1.6	Setting up as Handheld GNSS	42
3.1.7	Setting up as Robotic	44
3.1.8	Connecting to a Personal Computer	45
3.2	Power Functions	51
3.3	Batteries	53
3.3.1	Operating Principles	53
3.3.2	Changing the Battery	54
3.3.3	Charging the Battery	57
3.4	Working with the Memory Device	59
3.5	LED Indicators on CS10 /CS15	63
3.6	LED Indicators on CTR16	66
3.7	LED Indicators on GS08 /GS12	68
3.8	Using the Digital Camera	70
<b>4</b>	<b>Care and Transport</b>	<b>72</b>

---

4.1	Transport	72
-----	-----------	----



4.2	Storage	73
4.3	Cleaning and Drying	74
<b>5</b>	<b>Safety Directions</b>	<b>76</b>
5.1	General Introduction	76
5.2	Intended Use	77
5.3	Limits of Use	79
5.4	Responsibilities	80
5.5	Hazards of Use	82
5.6	Electromagnetic Compatibility EMC	88
5.7	FCC Statement, Applicable in U.S.	91
<b>6</b>	<b>Technical Data</b>	<b>96</b>
6.1	CS10 /CS15 Technical Data	96
6.2	GS05 /GS06 Technical Data	101
6.2.1	Tracking Characteristics	101
6.2.2	Accuracy	103
6.2.3	Technical Data	104
6.3	CTR16 Technical Data	107
6.4	GS08 /GS12 Technical Data	109
6.4.1	Tracking Characteristics	109
6.4.2	Accuracy	112

<b>CS10/CS15, Table of Contents</b>	<b>10</b>
6.4.3 Technical Data	114
6.5 Antennas Technical Data	118
6.6 Conformity to National Regulations	121
6.6.1 CS10	121
6.6.2 CS15	125
6.6.3 CTR16	128
6.6.4 GS08	130
6.6.5 GS12	132
<b>7 International Limited Warranty, Software Licence Agreement</b>	<b>134</b>
<b>Appendix A Pin Assignments and Sockets</b>	<b>136</b>
A.1 CS10 /CS15	136
A.2 GS08 /GS12	139
<b>Index</b>	<b>141</b>

# 1 Description of the System

## 1.1 Overview

### System components

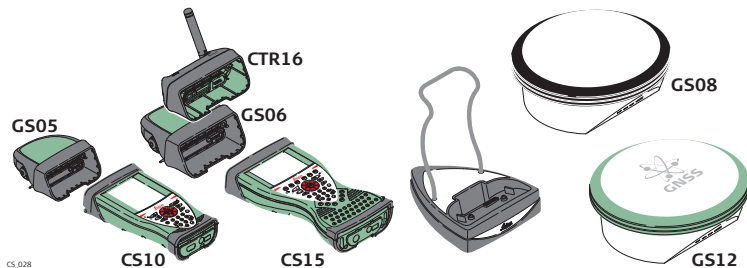

## 1.2 Terminology

### CS general description

CS is a collective term describing the various models (CS10/CS15) of the multi-purpose field controller which is used with GNSS and TPS instruments.

### CS available models

Model	Touch screen	Colour display	Internal radio modem	Internal 3.5 GSM/UMTS modem	Internal battery*1	SD card	CompactFlash card	Bluetooth	Wireless LAN 802.11b/g	Windows CE
Basic (CS10/CS15)	✓	✓	-	-	✓	✓	✓	✓	-	✓
Radio (CS10/CS15)	✓	✓	✓	-	✓	✓	✓	✓	✓	✓
3.5G (CS10/CS15)	✓	✓	-	✓	✓	✓	✓	✓	✓	✓
3.5G + Radio (CS15)	✓	✓	✓	✓	✓	✓	✓	✓	✓	✓
 Use the supplied stylus on the screens of the touch screen.										

\*1 removable

**CS available radios    Radios for remote control (RCS) are available for the following devices:**

Radio Modem	Description
CS10	Field controller with an integrated radio modem. This field controller has a colour display.
CS15	Field controller with an integrated radio modem. This field controller has a colour display.
	All devices contain the same spread spectrum transceiver radio modem.

## 1.3 System Concept

### 1.3.1 Software Concept

#### Software for all CS models

---

Software type	Description
CS firmware (CS_xx.fw)	This software includes: <ul style="list-style-type: none"><li>- The language-specific version of Windows CE.</li><li>- The basic functionality of the CS.</li></ul>

#### Software for the GS05/GS06

---

Software type	Description
GS firmware (GS_xx.fw)	This software includes: <ul style="list-style-type: none"><li>- The firmware for the measurement engine.</li></ul>

#### Software for the GS08/GS12

---

Software type	Description
ME firmware (ME_xx.fw)	This software includes: <ul style="list-style-type: none"><li>- The firmware for the measurement engine.</li></ul>

---

## Software upload



Uploading firmware can take some time. Ensure that the battery is at least 75% full before beginning the upload, and do not remove the battery during the upload process.

Software for	Description
All CS models	<p>The software is stored in the flash RAM of the CS field controller.</p> <p><b>CS firmware update instructions</b></p> <ul style="list-style-type: none"><li>• Download the most recent CS firmware file from <a href="https://myworld.leica-geosystems.com">https://myworld.leica-geosystems.com</a>. Refer to "Introduction".</li><li>• Connect the CS field controller to your PC. Refer to "3.1.8 Connecting to a Personal Computer".</li><li>• Copy CS firmware file onto a folder on the Leica SD card, Leica CompactFlash card or USB stick.</li><li>• Tap the Loader icon from the desktop, to run the Loader application.</li><li>• Browse to the directory into which you copied CS firmware file, select it and start the upload.</li><li>• A message will appear when the upload is complete.</li></ul> <p> Ensure that a Leica SD card or a Leica CF card is inserted into the CS field controller before starting the upload.</p>

Software for	Description
GS05/GS06	<p>The software is stored in the flash RAM of the GS05/GS06.</p> <p><b>GS firmware update instructions</b></p> <ul style="list-style-type: none"><li>• Download the most recent GS firmware file from <a href="https://myworld.leica-geosystems.com">https://myworld.leica-geosystems.com</a>. Refer to "Introduction".</li><li>• Connect the CS field controller to your PC. Refer to "3.1.8 Connecting to a Personal Computer".</li><li>• Copy GS firmware file into the /SYSTEM directory of the Leica SD card or Leica CompactFlash card.</li><li>• Connect the GS05/GS06 to the CS field controller. Refer to "3.1.6 Setting up as Handheld GNSS".</li><li>• Establish a connection between the GS05/GS06 and the CS field controller. Refer to the Leica Viva TechRef (Connections.. - GPS connection wizard).</li><li>• Start the upload. Refer to the Leica Viva GNSS Getting Started Guide (Appendix B Uploading System Files).</li><li>• A message will appear when the upload is complete.</li></ul>



Software for	Description
GS08/GS12	<p>The software is stored in the flash RAM of the GS08/GS12.</p> <p><b>ME firmware update instructions</b></p> <ul style="list-style-type: none"> <li>• Download the most recent ME firmware file from <a href="https://myworld.leica-geosystems.com">https://myworld.leica-geosystems.com</a>. Refer to "Introduction".</li> <li>• Connect the CS field controller to your PC. Refer to "3.1.8 Connecting to a Personal Computer".</li> <li>• Copy ME firmware file into the /SYSTEM directory of the Leica SD card or Leica CompactFlash card.</li> <li>• Connect the GS08/GS12 with the GEV234/GEV237 cable to the CS field controller and establish a connection between the GS08/GS12 and the CS field controller. Refer to the Leica Viva TechRef (Connections.. - GPS connection wizard).</li> <li>• Start the upload. Refer to the Leica Viva GNSS Getting Started Guide (Appendix B Uploading System Files).</li> <li>• A message will appear when the upload is complete.</li> </ul>

### 1.3.2 Power Concept

#### General

Use the Leica Geosystems batteries, chargers and accessories or accessories recommended by Leica Geosystems to ensure the correct functionality of the instrument.

#### Power options

Model	Power supply
all CS models	Internally by GEB211/GEB212 battery, OR Externally by docking station, OR Externally by GEV235 cable, OR Externally by GEV219 cable (only CS models with LEMO CBC01 connector module), OR Externally by GDC221 car adapter  If an external power supply is connected and the internal battery is inserted, then the external power is used.
CTR16	Externally by CS field controller
GS05/GS06	Externally by CS field controller
GS08/GS12	Internally by GEB211/GEB212 battery, OR Externally by GEV219 cable

Model	Power supply
	If an external power supply is connected and the internal battery is inserted, then the external power is used.

---

### 1.3.3 Data Storage Concept

---

**Description**

Data is stored on a memory device. The memory device can be an SD card, CompactFlash card, USB stick or internal memory.

---

**Memory device**

SD card:	All CS field controllers have an SD card slot fitted as standard. An SD card can be inserted and removed. Available capacity: 1 GB.
CompactFlash card:	All CS field controllers have a CF card slot fitted as standard. A CompactFlash card can be inserted and removed. Available capacity: 256 MB, 1 GB.
USB stick:	All CS field controllers have a USB port fitted as standard.
Internal memory:	All CS field controllers have an internal memory fitted as standard. Available capacity: 1 GB.



While other SD cards or CompactFlash cards can be used, Leica Geosystems recommends to only use Leica SD cards or Leica CompactFlash cards and is not responsible for data loss or any other error that can occur while using a non-Leica card.

---



Removing the SD card, CompactFlash card or USB stick while the CS field controller is turned on can cause loss of data. Only remove the SD card, CompactFlash card or USB stick or unplug connecting cables when the CS field controller is switched off.

---

## Transfer data



Data can be transferred in various ways. Refer to "3.1.8 Connecting to a Personal Computer".

---

CompactFlash cards and SD cards can directly be used in an OMNI drive as supplied by Leica Geosystems. Other PC card drives can require an adaptor.

---

## 1.4 CS Components

### 1.4.1 CS10

#### Upside of CS10

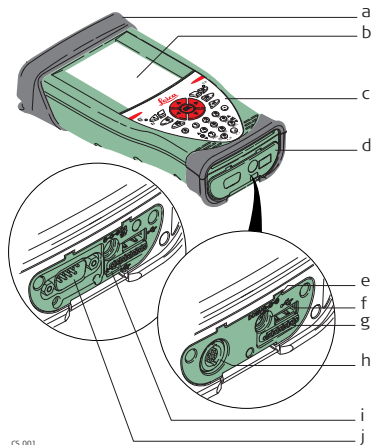

- a) Slot Cover
- b) Screen
- c) Keyboard
- d) Port cover
- e) Power socket
- f) USB A Host port
- g) Docking station contacts
- h) LEMO port (USB and serial)
- i) USB Mini port
- j) DSUB9 port

CS\_001

## Underside of CS10

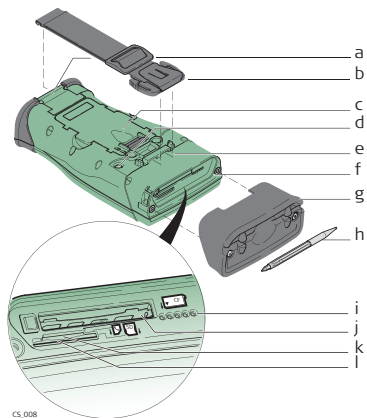

- a) Hand strap bottom clips
- b) Hand strap
- c) Battery compartment
- d) Digital camera
- e) Hand strap top clips
- f) Slots
- g) Slot cover
- h) Stylus
- i) GS05 contacts
- j) CompactFlash card slot
- k) SIM card slot
- l) SD card slot

CS\_008

## 1.4.2

## CS15

## Upside of CS15

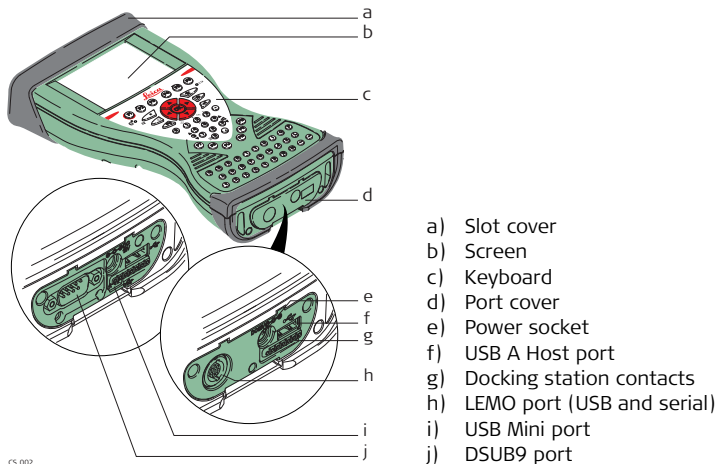

CS\_002



## Underside of CS15

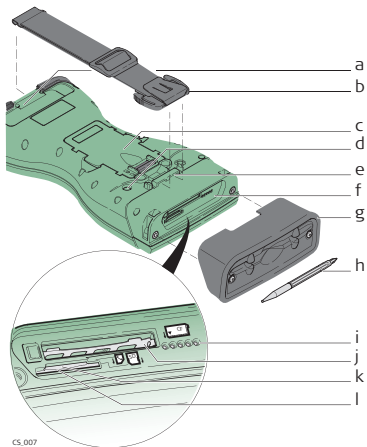

- a) Hand strap bottom clips
- b) Hand strap
- c) Battery compartment
- d) Digital camera
- e) Hand strap top clips
- f) Slots
- g) Slot cover
- h) Stylus
- i) GS06 contacts
- j) CompactFlash card slot
- k) SIM card slot
- l) SD card slot

CS\_007

## 1.5 Docking Station Components

---

### Docking station

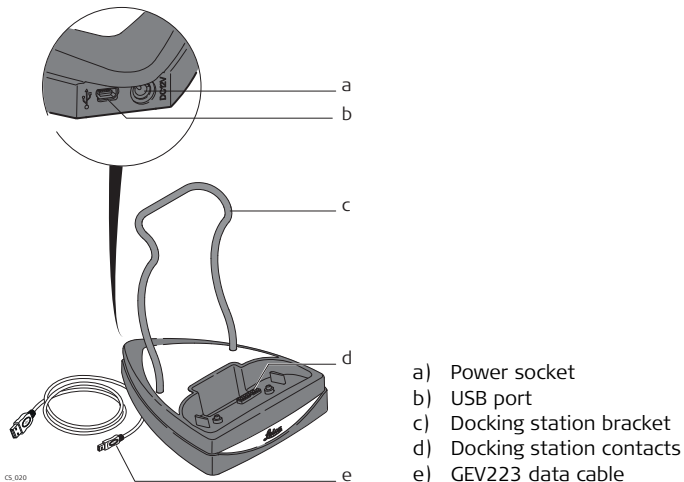

## 2

### 2.1

## User Interface

### Keyboard

#### Keyboard display CS10

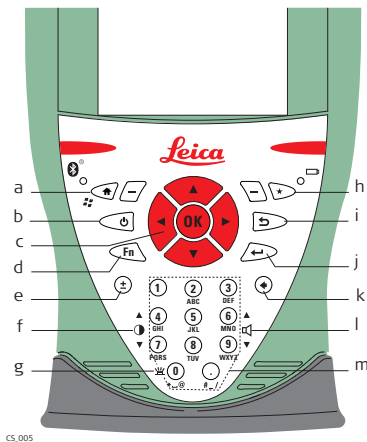





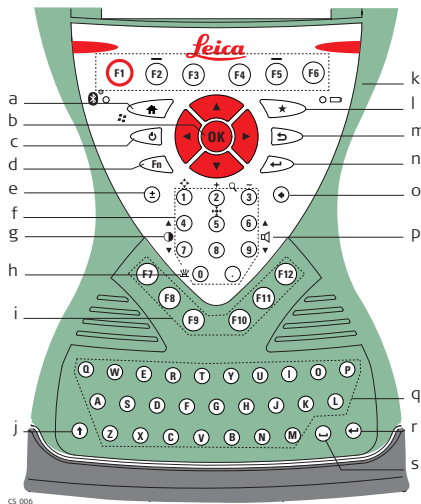



- a) Home
- b) ON/OFF
- c) Arrow keys, **OK**
- d) **Fn**
- e) ± key
- f) Brightness
- g) Keyboard illumination
- h) Favourites
- i) ESC
- j) Enter
- k) Backspace
- l) Volume
- m) Numeric keys





## Keyboard display CS15



- a) Home
- b) Arrow keys, **OK**
- c) ON/OFF
- d) **Fn**
- e)  $\pm$  key
- f) Numeric keys
- g) Brightness
- h) Keyboard illumination
- i) Function keys **F7 - F12**
- j) CAPS Lock
- k) Function keys **F1 - F6**
- l) Favourites
- m) ESC
- n) ENTER
- o) Backspace
- p) Volume
- q) Alpha keys
- r) ENTER
- s) SPACE











## Keys

Key		Function
Function keys <b>F1-F6</b>		Correspond to six softkeys that appear on the bottom of the screen when the screen is activated.
Function keys <b>F7-F12</b>		User definable keys to execute chosen commands or access chosen screens.
Alpha keys		To type letters.
Numeric keys		To type numbers.
Caps Lock		Switches between upper case and lower case letters.
Backspace		Clears all entry at the beginning of user input.  Clears the last character during user input.
Esc		Leaves the current screen without storing any changes.
<b>Fn</b>		Switches between the first and second level of function keys.
Space		Enters a blank.

Key	Function
Enter 	<p>Selects the highlighted line and leads to the next logical menu/ dialog.</p> <p>Starts the edit mode for editable fields.</p> <p>Opens a selectable list.</p>
ON/OFF 	<p>If CS10/CS15 already off: Turns on CS10/CS15 when held for 2 s.</p> <p>If CS10/CS15 in stand-by mode: Turns on CS10/CS15 when held &lt; 2 s.</p> <p>If CS10/CS15 already on:</p> <ul style="list-style-type: none"> <li>• Puts CS10/CS15 into stand-by mode when held &lt; 2 s. Refer to "Stand-by".</li> <li>• Turns to Power Options menu when held for 2 s. Refer to "Power Options menu".</li> <li>• Turns off CS10/CS15 when held for 5 s.</li> </ul>
Favourites 	Goes to a website by simply clicking its name.
Home 	Switches to the Windows CE Start Menu.

Key	Function
Arrow keys	Move the focus on the screen.
OK	Selects the highlighted line and leads to the next logical menu/ dialog. Starts the edit mode for editable fields. Opens a selectable list.

## Key combinations

Key	Function
 + 	Hold <b>Fn</b> while pressing <b>4</b> . Increase the screen brightness.
 + 	Hold <b>Fn</b> while pressing <b>7</b> . Decrease the screen brightness.
 + 	Hold <b>Fn</b> while pressing <b>6</b> . Increase the volume for acoustic warning signals, beeps and keypresses on the CS field controller.
 + 	Hold <b>Fn</b> while pressing <b>9</b> . Decrease the volume for acoustic warning signals, beeps and keypresses on the CS field controller.
 + 	Hold <b>Fn</b> while pressing <b>0</b> . If keyboard illumination is already off: Turns on keyboard illumination. If keyboard illumination is already on: Turns off keyboard illumination.



## 2.2

## Operating Principles

---

### Keyboard and touch screen

The user interface is operated either by the keyboard or by the touch screen with supplied stylus. The workflow is the same for keyboard and touch screen entry, the only difference lies in the way information is selected and entered.

#### Operation by keyboard

Information is selected and entered using the keys. Refer to "2.1 Keyboard" for a detailed description of the keys on the keyboard and their function.

#### Operation by touch screen

Information is selected and entered on the screen using the supplied stylus.

Operation	Description
To select an item	Tap on the item.
To start the edit mode in editable fields	Tap on the editable field.
To highlight an item or parts of it for editing	Drag the supplied stylus from the left to the right.
To accept data entered into an editable field and exit the edit mode	Tap on the screen outside of the editable field.
To open a context-sensitive menu	Tap on the item and hold for 2 s.

---

## 3 Operation



### 3.1 Equipment Setup

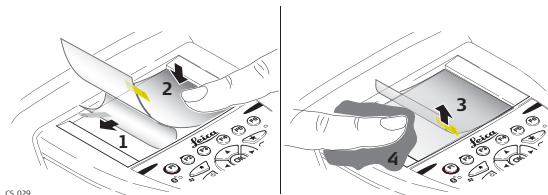

#### 3.1.1 Fixing the Display Foil to the CS

Fixing the display foil to the CS step-by-step



CS\_029

Step	Description
	Ensure that the display of the CS is free of dust and grease.
	The non-reflecting display foil has a silver-coloured sticker to peel away the carrier foil from the actual display foil.
1.	Touch the silver-coloured sticker with two fingers and pull it slowly upwards. The carrier foil is peeling away.  Do not peel the carrier foil more than 2 cm - 3 cm away.

Step	Description
2.	Fix the laid open adhesive underside of the display foil at the display border.  Pay attention that the display foil is not fixed between display and display frame.
3.	Peel away the carrier foil bit by bit and smooth it out slowly onto the display.
4.	Potential air bubbles between display and display foil have to be smoothed out using the included microfibre cloth.  Do not use sharp objects!

---

### 3.1.2 Fixing a Hand Strap to the CS

Fixing the CS to a hand strap step-by-step

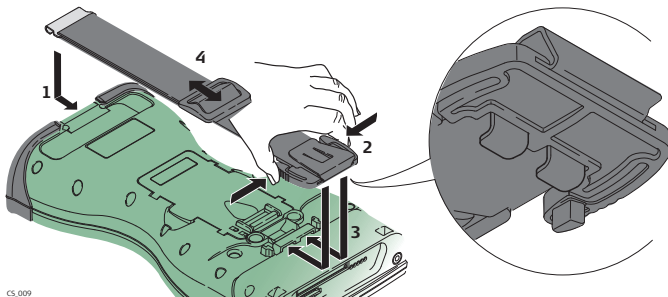

CS\_009

Step	Description
	Turn the CS field controller over.
1.	Take the end of the hand strap and clip it to the base of CS field controller.
2.	Compress the clips of the main hook.
3.	Lower the main hook onto the pivot knob of the CS field controller. A click can be felt when the clip is secure.

Step	Description
4.	Adjust the length of the hand strap.

---

### 3.1.3

## Fixing the Slot Cover to the CS

Fixing the slot cover to the CS step-by-step

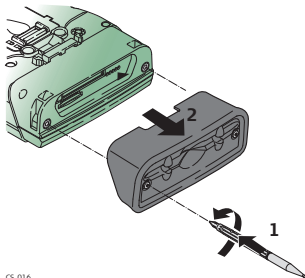

CS.016

Step	Description
1.	Press the screwdriver end of the supplied stylus on the quarter-turn screws and loosen them.
2.	Remove the slot cover.
	Reattach the slot cover with the stylus, making sure the quarter-turn screws are seated.

### 3.1.4

## Inserting and Removing a SIM Card

Insert and remove a SIM card step-by-step

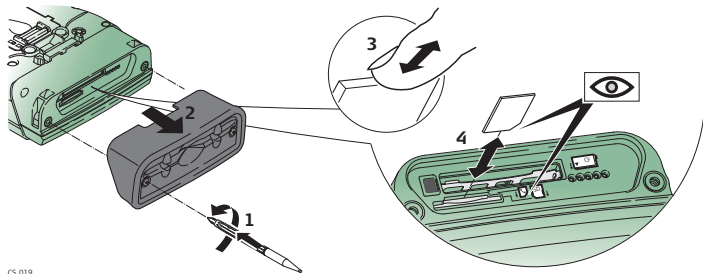

CS.019

	Description
	The SIM card is inserted into a slot inside the top of the CS10/CS15.
1.	Loosen the screws inside the slot cover on top of the CS10/CS15 using the screwdriver end of the stylus.
2.	Detach the slot cover from the CS10/CS15.
3.	Slide the card firmly into the slot until it clicks into position.

---

	Description
	 Do not force the card into the slot. The card should be held with the contacts facing the slot.
4.	Attach the slot cover and tighten the screws.
5.	To remove the card, detach the slot cover of the CS10/CS15.
6.	Gently press the top of the card to release it from the slot.
7.	Remove the SIM card and attach the slot cover.

---



### 3.1.5

## Setting up the Docking Station

### Mounting components of the docking station step-by-step

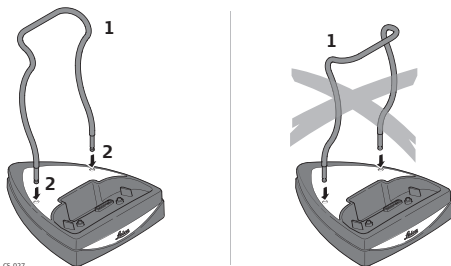

Step	Description
1.	Hold the docking station bracket as shown in the illustration in relation to the docking station rack.
2.	Slightly press the holder into the docking station rack. A click can be felt when the holder is secure.

### 3.1.6 Setting up as Handheld GNSS



The setup GS05/CS10 is identical to the setup GS06/CS15. For simplicity, the setup GS05/CS10 is used in the following.

#### Attaching the GS05 to the CS10 step-by-step

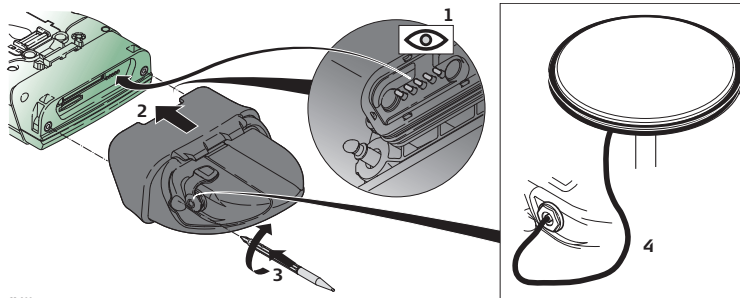

CS\_011

Step	Description
	Detach the slot cover from the CS10. Refer to "3.1.3 Fixing the Slot Cover to the CS".
1.	Check the position of the contacts in the inner surface of the GS05.

<b>Step</b>	<b>Description</b>
2.	Attach the GS05 to the CS10.
3.	Press the screwdriver end of the supplied stylus on the quarter-turn screws and tighten them.
4.	To achieve the optimal satellite tracking performance, mount the AS05 (external GNSS antenna) on the GS05.

---

## 3.1.7

## Setting up as Robotic

Attaching the  
CTR16 to the CS15  
step-by-step

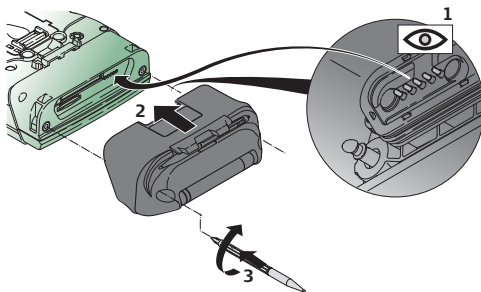

CS\_031

Step	Description
	Detach the slot cover from the CS15. Refer to "3.1.3 Fixing the Slot Cover to the CS".
1.	Check the position of the contacts in the inner surface of the CTR16.
2.	Attach the CTR16 to the CS15.
3.	Press the screwdriver end of the supplied stylus on the quarter-turn screws and tighten them.

### 3.1.8

## Connecting to a Personal Computer



Microsoft ActiveSync (for PCs with Windows XP operating system) or Windows Mobile Device Center (for PCs with Windows Vista or Windows 7 operating system) is the synchronisation software for Windows mobile-based pocket PCs. Microsoft ActiveSync or Windows Mobile Device Center enables a PC and a Windows mobile-based pocket PC to communicate.

### Install Leica Viva USB drivers

Step	Description
1.	Start the PC.
2.	Insert the Leica Viva Series DVD.
3.	Run the <b>SetupViva&amp;GR_USB_XX.exe</b> to install the drivers necessary for Leica Viva devices. Depending on the version (32bit or 64bit) of the operating system on your PC, you have to select between the three setup files following: <ul style="list-style-type: none"><li>• SetupViva&amp;GR_USB_32bit.exe</li><li>• SetupViva&amp;GR_USB_64bit.exe</li><li>• SetupViva&amp;GR_USB_64bit_itanium.exe</li></ul>  The setup has to be run only once for all Leica Viva devices.

---

Step	Description
4.	The <b>Welcome to InstallShield Wizard for Leica Viva &amp; GR USB drivers</b> window appears.  Ensure that all Leica Viva devices are disconnected from your PC before you continue!
5.	<b>Next&gt;</b> .
6.	The <b>Ready to Install the Program</b> window appears.
7.	<b>Install.</b> The drivers will be installed on your PC.  For PCs with Windows Vista or Windows 7 operating system: If not already installed, Windows Mobile Device Center will be installed additionally.
8.	The <b>InstallShield Wizard Completed</b> window appears.
9.	Check <b>I have read the instructions</b> and click <b>Finish</b> to exit the wizard.

---

**Connect USB cable to PC for the first time step-by-step**

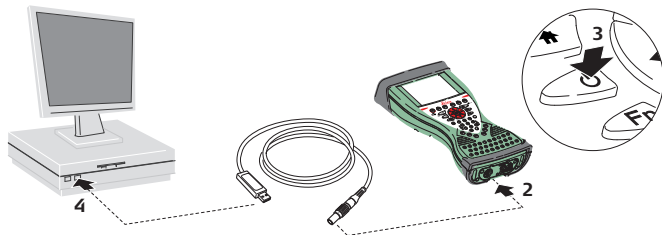

CS.026

Step	Description
1.	Start the PC.
2.	Plug the GEV234 cable into CS field controller.  For CS field controllers with DSUB9 connector, the GEV223 cable has to be used.
3.	Turn on the CS field controller.
4.	Plug the GEV234 cable into the USB port of the PC. The <b>Found New Hardware Wizard</b> starts up automatically.
5.	Check <b>Yes, this time only. Next&gt;</b> .

---

Step	Description
6.	Check <b>Install the software automatically (Recommended). Next&gt;</b> . The software for <b>Remote NDIS based LGS CS Device</b> will be installed on your PC.
7.	<b>Finish.</b>
8.	The <b>Found New Hardware Wizard</b> starts up automatically a second time.
9.	Check <b>Yes, this time only. Next&gt;</b> .
10.	Check <b>Install the software automatically (Recommended). Next&gt;</b> . The software for <b>LGS CS USB Device</b> will be installed on your PC.
11.	<b>Finish.</b>
	For PCs with Windows XP operating system:
12.	Run the ActiveSync installation program if not already installed.
13.	Allow USB connections inside the <b>Connection Settings</b> window of Active-Sync.
	For PCs with Windows Vista or Windows 7 operating system:
14.	Windows Mobile Device Center starts up automatically. If does not start automatically, start Windows Mobile Device Center.



---



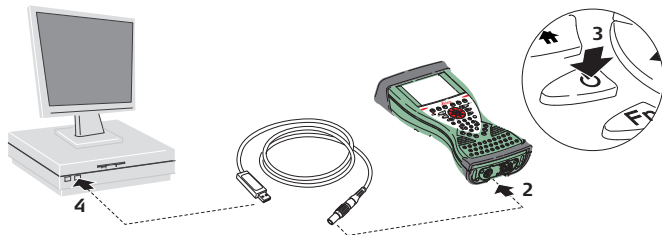

## Connect to PC via USB cable step-by-step



CS.026

Step	Description
1.	Start the PC.
2.	Plug the GEV234 cable into CS field controller.  For CS field controllers with DSUB9 connector, the GEV223 cable has to be used.
3.	Turn the CS field controller on.
4.	Plug the GEV234 cable into the USB port of the PC.
	For PCs with Windows XP operating system:  ActiveSync starts up automatically. If does not start automatically, start ActiveSync. If not already installed, run the ActiveSync installation program.

---

Step	Description
5.	Allow USB connections inside the <b>Connection Settings</b> window of ActiveSync.
6.	Click <b>Explore</b> in ActiveSync.  The folders on the CS field controller are displayed under <b>Mobile Devices</b> . The folders of the data storage device can be found in <b>StorageCard</b> .
	For PCs with Windows Vista or Windows 7 operating system:  Windows Mobile Device Center starts up automatically. If does not start automatically, start Windows Mobile Device Center.



---

## 3.2

## Power Functions



---

### Turning CS field controller on

Press and hold power key () for 2 s.  
 CS field controller must have a power supply.



---

### Turning CS field controller off

Press and hold power key () for 5 s.  
 CS field controller must be on.



---

### Putting CS field controller into stand-by

Press and hold power key () < 2 s.  
 CS field controller must be on.

---

### Power Options menu

Press and hold power key () for 2 s to open **Power Options** menu.  
 CS field controller must be on.

---

Option	Description
Turn off	Turn CS field controller off.
Stand-by	Put CS field controller into stand-by mode.  In stand-by mode, CS field controller shuts down and reduces power consumption. Rebooting from stand-by mode is quicker than a cold start after turning off.

---

Option	Description
<b>Lock keyboard</b>	Lock the keyboard. Option turns to <b>Unlock keyboard</b> .
<b>Turn off touch screen</b>	Disable touch screen. Option turns to <b>Turn on touch screen</b> .
<b>Reset...</b>	Perform one of the following options: <ul style="list-style-type: none"><li>• <b>Restart</b> (restarts Windows CE)</li><li>• <b>Reset Windows CE</b> (resets Windows CE and communication settings to factory defaults)</li><li>• <b>Reset installed software</b> (resets settings of all installed software)</li><li>• <b>Reset Windows CE and installed software</b> (resets Windows CE and settings of all installed software)</li></ul>

---

## 3.3

### 3.3.1

## Batteries

### Operating Principles

---

#### Charging / first-time use

- The battery must be charged prior to using it for the first time because it is delivered with an energy content as low as possible.
  - The permissible temperature range for charging is between 0°C to +40°C/ +32°F to +104°F. For optimal charging, we recommend charging the batteries at a low ambient temperature of +10°C to +20°C/+50°F to +68°F if possible.
  - It is normal for the battery to become warm during charging. Using the chargers recommended by Leica Geosystems, it is not possible to charge the battery if the temperature is too high.
  - For new batteries or batteries that have been stored for a long time (> three months), it is effectual to make only one charge/discharge cycle.
  - For Li-Ion batteries, a single discharging and charging cycle is sufficient. We recommend carrying out the process when the battery capacity indicated on the charger or on a Leica Geosystems product deviates significantly from the actual battery capacity available.
- 

#### Operation / Discharging

- The batteries can be operated from -20°C to +55°C/-4°F to +131°F.
  - Low operating temperatures reduce the capacity that can be drawn; high operating temperatures reduce the service life of the battery.
-

### 3.3.2 Changing the Battery

Insert and remove the battery on the CS field controller step-by-step

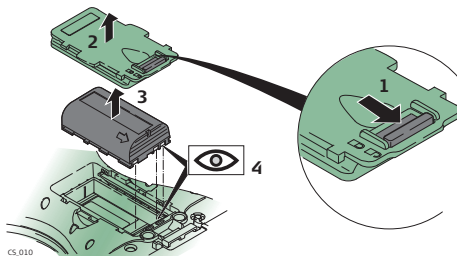

Step	Description
	Turn CS field controller over to gain access to the battery compartment.
1.	Push the slide fastener in the direction of the arrow with the open-lock symbol.
2.	Open the battery compartment.
3.	Pull the battery from the battery compartment.
4.	Place the battery into the battery compartment with the Leica logo facing to the top.

Step	Description
5.	Close the battery compartment by pushing the slide fastener in the direction of the arrow with the close-lock symbol.

**Insert and remove the battery on the GS08/GS12 step-by-step**

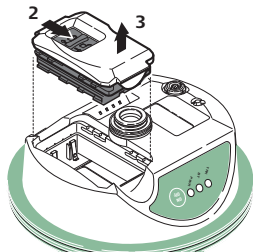

GS 121

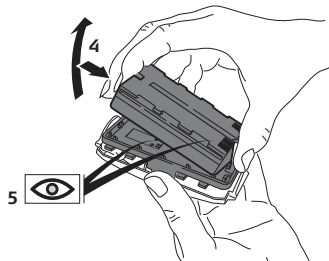

Step	Description
1.	Turn GS08/GS12 over to gain access to the battery compartment.
2.	Open the battery compartment by pushing the slide fastener in the direction of the arrow with the open-lock symbol.
3.	Pull out the battery housing. The battery is attached to the housing.

---

Step	Description
4.	Hold the battery housing and pull the battery from the battery housing.
5.	A polarity of the battery is displayed inside the battery housing. This is a visual aid to assist in placing the battery correctly.
6.	Place the battery onto the battery housing, ensuring that the contacts are facing outward. Click the battery into position.
7.	Close the battery compartment by pushing the slide fastener in the direction of the arrow with the close-lock symbol.

---



### 3.3.3

## Charging the Battery

### Charge battery step-by-step

A



B

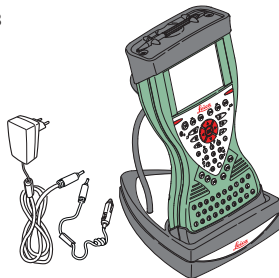

CS.024

Step	Description
1.	Connect the GEV235 power adapter or GDC221 car adapter with the CS field controller (A) or the docking station (B) and an A/C plug.
2.	The power LED on the CS field controller switches on. When CS field controller's battery is fully charged the LED switches off again.  Refer to "LED indicators" for information about the power LED.



The following advice is only valid for battery charger, power adapter and car adapter.

---

**Warning**

If you open the product, either of the following actions may cause you to receive an electric shock.

- Touching live components
- Using the product after incorrect attempts were made to carry out repairs

**Precautions:**

Do not open the product. Only Leica Geosystems authorised service workshops are entitled to repair these products.

---



The following advice is only valid for batteries, power adapter or docking station.

---

**Caution**

The product is not designed for use under wet and severe conditions. If unit becomes wet it may cause you to receive an electric shock.

**Precautions:**

Use the product only in dry environments, for example in buildings or vehicles. Protect the product against humidity. If the product becomes humid, it must not be used!



## 3.4

## Working with the Memory Device





- Keep the card dry.
- Use it only within the specified temperature range.
- Do not bend the card.
- Protect the card from direct impacts.

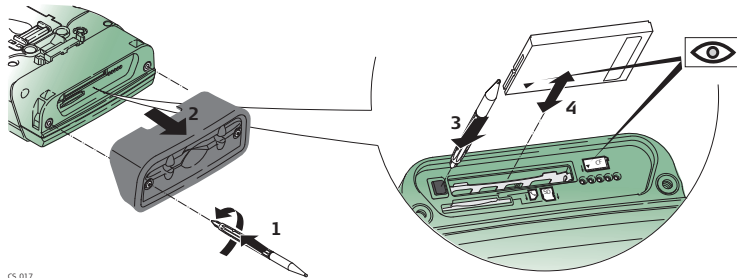

Failure to follow these instructions could result in data loss and/or permanent damage to the card.

### Insert and remove a CompactFlash card step-by-step



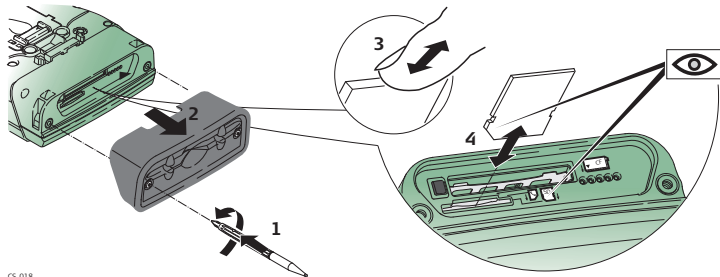

Step	Description
	The CompactFlash card is inserted into a slot inside the top of the CS10/CS15.
1.	Refer to "Fixing the slot cover to the CS step-by-step". Loosen the screws inside the slot cover on top of the CS10/CS15 using the screwdriver end of the stylus.
2.	Detach the slot cover from the CS10/CS15.
3.	Slide the card firmly into the slot until it clicks into position.  Do not force the card into the slot.
4.	The card must be held with the contacts facing the slot.
5.	Attach the slot cover and tighten the screws.
6.	To remove the card, detach the slot cover of the CS10/CS15.
7.	Press the eject button next to the card slot twice.
8.	Remove the CompactFlash card and attach the slot cover.

## Insert and remove an SD card step-by-step



CS.018

Step	Description
	The SD card is inserted into a slot inside the top of the CS10/CS15.
1.	Refer to "Fixing the slot cover to the CS step-by-step". Loosen the screws inside the slot cover on top of the CS10/CS15 using the screwdriver end of the stylus.
2.	Detach the slot cover from the CS10/CS15.
3.	Slide the card firmly into the slot until it clicks into position.  Do not force the card into the slot.
4.	The card must be held with the contacts facing the slot.

---

Step	Description
5.	Attach the slot cover and tighten the screws.
6.	To remove the card, detach the slot cover of the CS10/CS15.
7.	Gently press the top of the card to release it from the slot.
8.	Remove the SD card and attach the slot cover.

---

## 3.5

## LED Indicators on CS10/CS15

---

### LED indicators

#### Description

The CS field controller has **L**ight **E**mitting **D**iode indicators. They indicate the basic field controller status.

#### Diagram

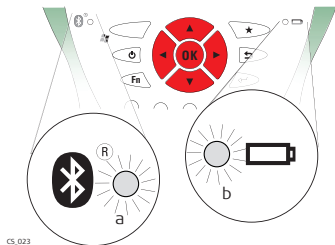

- a) Bluetooth LED
- b) Power LED

**Description of the LEDs**

<b>IF the</b>	<b>is</b>	<b>THEN</b>
Bluetooth LED	green	Bluetooth is in data mode and ready for connecting.
	purple	Bluetooth is connecting.
	blue	Bluetooth has connected.
	flashing blue	data is being transferred
Power LED	off	power is off.
	green	power is okay.
	flashing green	power is okay. The battery is being charged.
	yellow	power is low. The remaining time for which enough power is available depends on the use of wireless modules, the temperature and the age of the battery.
	flashing yellow	power is low. The remaining time for which enough power is available depends on the use of wireless modules, the temperature and the age of the battery. The battery is being charged.
	red	power is very low. The battery should be changed.



<b>IF the</b>	<b>is</b>	<b>THEN</b>
	flashing red	power is very low. The battery is being charged.

---

## 3.6 LED Indicators on CTR16

### LED indicators

#### Description

The CTR16 has a Light Emitting Diode indicator. It indicates the basic radio status.

#### Diagram

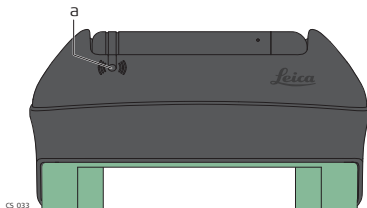

a) TPS radio LED

#### Description of the LEDs

IF the	is	THEN
TPS radio LED	green	radio is in data mode and ready for connecting.
	orange	the CTR16 is in configuration mode

<b>IF the</b>	<b>is</b>	<b>THEN</b>
	purple	radio is connecting.
	blue	radio has connected.
	flashing blue	data is being transferred.
	red	the CTR16 is not ready to be used.

---

## 3.7

## LED Indicators on GS08/GS12

### LED indicators

#### Description

The GS08/GS12 instrument has **L**ight **E**mitting **D**iode indicators. They indicate the basic instrument status.

#### Diagram

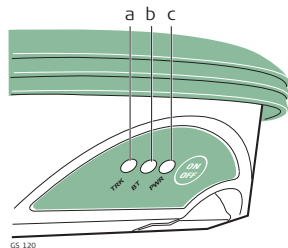

- a) Tracking LED (TRK)
- b) BT - Bluetooth LED (BT)
- c) Power LED (PWR)

## Description of the LEDs

IF the	is	THEN
TRK LED	off	No satellites are tracked.
	flashing green	Less than four satellites are tracked, a position is not yet available.
	green	Enough satellites are tracked to compute a position.
	red	GS08/GS12 instrument is initialising.
BT LED	green	Bluetooth is in data mode and ready for connecting.
	purple	Bluetooth is connecting.
	blue	Bluetooth has connected.
	flashing blue	Data is being transferred.
PWR LED	off	Power is off.
	green	Power is okay.
	flashing green	Power is low. The remaining time for which enough power is available depends on the type of survey, the temperature and the age of the battery.

## 3.8 Using the Digital Camera

---

### Overview

Both CS field controllers are equipped with a digital camera located at the underside (refer to "1.4 CS Components"). If a hand strap or pole holder plate is mounted, the camera view is not limited. The camera application can be started from the desktop icon **Camera** or from the Start menu **Start - Programs - Camera**.

---

### Taking a picture step-by-step

Step	Description
1.	Aim the camera to the desired target.
2.	Check the view at the display.
3.	Press <b>OK</b> or click <b>Capture</b> to take the picture.  <b>Capture</b> changes to <b>Save</b> .
4.	Press <b>OK</b> again or click <b>Save</b> to open the <b>Save As</b> dialog.
5.	Click <b>Discard</b> to reject the picture.

---

## Storing a picture step-by-step

Step	Description
	The <b>Save As</b> dialog is Windows CE standard and allows to name the picture, choose the location or to create a folder.
1.	Browse to the desired folder or create a new one.
2.	Name the picture.
3.	Press <b>OK</b> to save it and return to the camera view.
4.	Press <b>Cancel</b> to reject the picture and to return to the camera view without saving the picture.

---

---

## 4 Care and Transport

### 4.1 Transport

---

#### **Transport in a road vehicle**

Never carry the product loose in a road vehicle, as it can be affected by shock and vibration. Always carry the product in its transport container and secure it.

---

#### **Shipping**

When transporting the product by rail, air or sea, always use the complete original Leica Geosystems packaging, transport container and cardboard box, or its equivalent, to protect against shock and vibration.

---

#### **Shipping, transport of batteries**

When transporting or shipping batteries, the person in charge of the product must ensure that the applicable national and international rules and regulations are observed. Before transportation or shipping, contact your local passenger or freight transport company.

---



## 4.2

## Storage

---

### Product

Respect the temperature limits when storing the equipment, particularly in summer if the equipment is inside a vehicle. Refer to "6 Technical Data" for information about temperature limits.

---

### Li-Ion batteries

- Refer to "6 Technical Data" for information about storage temperature range.
  - At the recommended storage temperature range, batteries containing a 10% to 50% charge can be stored for up to one year. After this storage period the batteries must be recharged.
  - Remove batteries from the product and the charger before storing.
  - After storage recharge batteries before using.
  - Protect batteries from damp and wetness. Wet or damp batteries must be dried before storing or use.
  - A storage temperature range of -20°C to +30°C/-4°F to 86°F in a dry environment is recommended to minimise self-discharging of the battery.
-

## 4.3 Cleaning and Drying

### Product and accessories

- Use only a clean, soft, lint-free cloth for cleaning. If necessary, moisten the cloth with water or pure alcohol. Do not use other liquids; these may attack the polymer components.

### Damp products

Dry the product, the transport container, the foam inserts and the accessories at a temperature not greater than 40°C/104°F and clean them. Do not repack until everything is dry. Always close the transport container when using in the field.

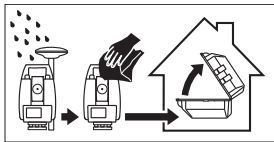
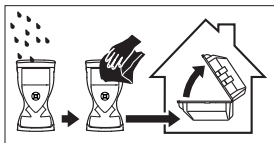

**Cables and plugs**

Keep plugs clean and dry. Blow away any dirt lodged in the plugs of the connecting cables.

---

**Connectors with dust caps**

Wet connectors must be dry before attaching the dust cap.

---

---

## 5 Safety Directions

### 5.1 General Introduction

---

#### **Description**

The following directions enable the person responsible for the product, and the person who actually uses the equipment, to anticipate and avoid operational hazards.

The person responsible for the product must ensure that all users understand these directions and adhere to them.

---

## 5.2

## Intended Use

---

### Permitted use

- Remote control of product.
  - Data communication with external appliances.
- 

### Adverse use

- Use of the product without instruction.
- Use outside of the intended limits.
- Disabling safety systems.
- Removal of hazard notices.
- Opening the product using tools, for example screwdriver, unless this is permitted for certain functions.
- Modification or conversion of the product.
- Use after misappropriation.
- Use of products with recognisable damages or defects.
- Use with accessories from other manufacturers without the prior explicit approval of Leica Geosystems.
- Inadequate safeguards at the working site, for example when measuring on roads.
- Controlling of machines, moving objects or similar monitoring application without additional control- and safety installations.



**Warning**

Adverse use can lead to injury, malfunction and damage.

It is the task of the person responsible for the equipment to inform the user about hazards and how to counteract them. The product is not to be operated until the user has been instructed on how to work with it.

---

## 5.3

## Limits of Use

---

### Environment

Suitable for use in an atmosphere appropriate for permanent human habitation: not suitable for use in aggressive or explosive environments.

---



### Danger

Local safety authorities and safety experts must be contacted before working in hazardous areas, or close to electrical installations or similar situations by the person in charge of the product.

---



The following advice is only valid for battery charger, power adapter and car adapter.

---

### Environment

Suitable for use in dry environments only and not under adverse conditions.



---

## 5.4

## Responsibilities

---

### **Manufacturer of the product**

Leica Geosystems AG, CH-9435 Heerbrugg, hereinafter referred to as Leica Geosystems, is responsible for supplying the product, including the user manual and original accessories, in a safe condition.

---

### **Manufacturers of non Leica Geosystems accessories**

The manufacturers of non Leica Geosystems accessories for the product are responsible for developing, implementing and communicating safety concepts for their products, and are also responsible for the effectiveness of those safety concepts in combination with the Leica Geosystems product.

---

### **Person in charge of the product**

The person in charge of the product has the following duties:

- To understand the safety instructions on the product and the instructions in the user manual.
  - To be familiar with local regulations relating to safety and accident prevention.
  - To inform Leica Geosystems immediately if the product and the application becomes unsafe.
  - To ensure that the national laws, regulations and conditions for the operation of radio transmitters are respected.
-



 **Warning**

The person responsible for the product must ensure that it is used in accordance with the instructions. This person is also accountable for the training and the deployment of personnel who use the product and for the safety of the equipment in use.

---

## 5.5

Hazards of Use

---

**Warning**

The absence of instruction, or the inadequate imparting of instruction, can lead to incorrect or adverse use, and can cause accidents with far-reaching human, material, financial and environmental consequences.

**Precautions:**

All users must follow the safety directions given by the manufacturer and the directions of the person responsible for the product.

---

**Danger**

Because of the risk of electrocution, it is dangerous to use poles and extensions in the vicinity of electrical installations such as power cables or electrical railways.

**Precautions:**

Keep at a safe distance from electrical installations. If it is essential to work in this environment, first contact the safety authorities responsible for the electrical installations and follow their instructions.



 **Warning**

During dynamic applications, for example stakeout procedures there is a danger of accidents occurring if the user does not pay attention to the environmental conditions around, for example obstacles, excavations or traffic.

**Precautions:**

The person responsible for the product must make all users fully aware of the existing dangers.

---

 **Warning**

Inadequate securing of the working site can lead to dangerous situations, for example in traffic, on building sites, and at industrial installations.

**Precautions:**

Always ensure that the working site is adequately secured. Adhere to the regulations governing safety and accident prevention and road traffic.

---



 **Warning**

If computers intended for use indoors are used in the field there is a danger of electric shock.

**Precautions:**

Adhere to the instructions given by the computer manufacturer regarding field use with Leica Geosystems products.

---

- 
-  **Caution** If the accessories used with the product are not properly secured and the product is subjected to mechanical shock, for example blows or falling, the product may be damaged or people can sustain injury.
- Precautions:**  
When setting-up the product, make sure that the accessories are correctly adapted, fitted, secured, and locked in position.  
Avoid subjecting the product to mechanical stress.
- 
-  **Warning** If the product is used with accessories, for example masts, staffs, poles, you may increase the risk of being struck by lightning.
- Precautions:**  
Do not use the product in a thunderstorm.
- 
-  **Warning** Using a battery charger not recommended by Leica Geosystems can destroy the batteries. This can cause fire or explosions.
- Precautions:**  
Only use chargers recommended by Leica Geosystems to charge the batteries.
-

 **Caution**

During the transport, shipping or disposal of batteries it is possible for inappropriate mechanical influences to constitute a fire hazard.

**Precautions:**

Before shipping the product or disposing of it, discharge the batteries by running the product until they are flat.

When transporting or shipping batteries, the person in charge of the product must ensure that the applicable national and international rules and regulations are observed. Before transportation or shipping contact your local passenger or freight transport company.

---

 **Warning**

High mechanical stress, high ambient temperatures or immersion into fluids can cause leakage, fire or explosions of the batteries.

**Precautions:**

Protect the batteries from mechanical influences and high ambient temperatures. Do not drop or immerse batteries into fluids.

---

 **Warning**

If battery terminals come in contact with jewellery, keys, metallised paper or other metals, short circuited battery terminals can overheat and cause injury or fire, for example by storing or transporting in pockets.

**Precautions:**

Make sure that the battery terminals do not come into contact with metallic objects.

---



The following advice is only valid for battery charger, power adapter and car adapter.

---

**Warning**

If you open the product, either of the following actions may cause you to receive an electric shock.

- Touching live components
- Using the product after incorrect attempts were made to carry out repairs

**Precautions:**

Do not open the product. Only Leica Geosystems authorised service workshops are entitled to repair these products.

---



The following advice is only valid for batteries, power adapter or docking station.

---

**Caution**

The product is not designed for use under wet and severe conditions. If unit becomes wet it may cause you to receive an electric shock.

**Precautions:**

Use the product only in dry environments, for example in buildings or vehicles. Protect the product against humidity. If the product becomes humid, it must not be used!



 **Warning**

If the product is improperly disposed of, the following can happen:

- If polymer parts are burnt, poisonous gases are produced which may impair health.
- If batteries are damaged or are heated strongly, they can explode and cause poisoning, burning, corrosion or environmental contamination.
- By disposing of the product irresponsibly you may enable unauthorised persons to use it in contravention of the regulations, exposing themselves and third parties to the risk of severe injury and rendering the environment liable to contamination.

**Precautions:**

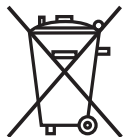

The product must not be disposed with household waste. Dispose of the product appropriately in accordance with the national regulations in force in your country. Always prevent access to the product by unauthorised personnel.

Product-specific treatment and waste management information can be downloaded from the Leica Geosystems home page at <http://www.leica-geosystems.com/treatment> or received from your Leica Geosystems dealer.

---

 **Warning**

Only Leica Geosystems authorised service workshops are entitled to repair these products.

---

## 5.6 Electromagnetic Compatibility EMC

---

### Description

The term Electromagnetic Compatibility is taken to mean the capability of the product to function smoothly in an environment where electromagnetic radiation and electrostatic discharges are present, and without causing electromagnetic disturbances to other equipment.

---



### Warning

Electromagnetic radiation can cause disturbances in other equipment.

Although the product meets the strict regulations and standards which are in force in this respect, Leica Geosystems cannot completely exclude the possibility that other equipment may be disturbed.

The product is a class A product when operated with the internal batteries. In a domestic environment this product may cause radio interference in which case the user may be required to take adequate measures.

---



### Caution

There is a risk that disturbances may be caused in other equipment if the product is used with accessories from other manufacturers, for example field computers, personal computers, two-way radios, non-standard cables or external batteries.

#### **Precautions:**

Use only the equipment and accessories recommended by Leica Geosystems. When combined with the product, they meet the strict requirements stipulated by the



guidelines and standards. When using computers and two-way radios, pay attention to the information about electromagnetic compatibility provided by the manufacturer.

---

 **Caution**

Disturbances caused by electromagnetic radiation can result in erroneous measurements.

Although the product meets the strict regulations and standards which are in force in this respect, Leica Geosystems cannot completely exclude the possibility that the product may be disturbed by intense electromagnetic radiation, for example, near radio transmitters, two-way radios or diesel generators.

**Precautions:**

Check the plausibility of results obtained under these conditions.

---

 **Warning**

If the product is operated with connecting cables attached at only one of their two ends, for example external supply cables, interface cables, the permitted level of electromagnetic radiation may be exceeded and the correct functioning of other products may be impaired.

**Precautions:**

While the product is in use, connecting cables, for example product to external battery, product to computer, must be connected at both ends.

---

**Radios or digital cellular phones****Warning**

Use of product with radio or digital cellular phone devices:

Electromagnetic fields can cause disturbances in other equipment, in installations, in medical devices, for example pacemakers or hearing aids and in aircraft. It can also affect humans and animals.

**Precautions:**

Although the product meets the strict regulations and standards which are in force in this respect, Leica Geosystems cannot completely exclude the possibility that other equipment can be disturbed or that humans or animals can be affected.

- Do not operate the product with radio or digital cellular phone devices in the vicinity of filling stations or chemical installations, or in other areas where an explosion hazard exists.
  - Do not operate the product with radio or digital cellular phone devices near to medical equipment.
  - Do not operate the product with radio or digital cellular phone devices in aircraft.
-

## 5.7

## FCC Statement, Applicable in U.S.

---



### Warning

The greyed paragraph below is only applicable for products without radio.

---

This equipment has been tested and found to comply with the limits for a Class B digital device, pursuant to part 15 of the FCC rules.

These limits are designed to provide reasonable protection against harmful interference in a residential installation.

This equipment generates, uses and can radiate radio frequency energy and, if not installed and used in accordance with the instructions, may cause harmful interference to radio communications. However, there is no guarantee that interference will not occur in a particular installation.

If this equipment does cause harmful interference to radio or television reception, which can be determined by turning the equipment off and on, the user is encouraged to try to correct the interference by one or more of the following measures:

- Reorient or relocate the receiving antenna.
  - Increase the separation between the equipment and the receiver.
  - Connect the equipment into an outlet on a circuit different from that to which the receiver is connected.
  - Consult the dealer or an experienced radio/TV technician for help.
-

 **Warning**

Changes or modifications not expressly approved by Leica Geosystems for compliance could void the user's authority to operate the equipment.

**Labelling CS10**

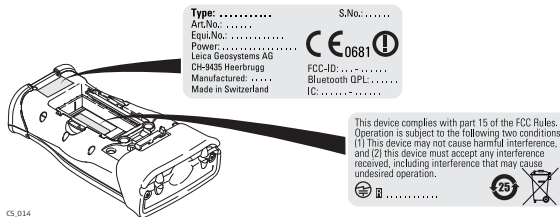

CS\_014

**Labelling CS15**

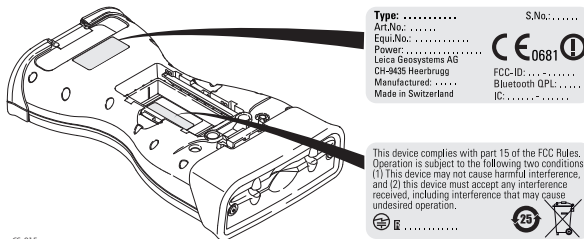

CS\_015

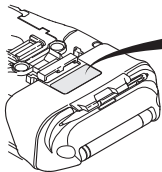

## Labelling CTR16



CS\_032

Type: ..... Art.No.: .....  
Equi.No.: ..... S.No.: .....

Leica Geosystems AG  
CH-9435 Heerbrugg  
Manufactured: .....  
Made in .....



## Labelling GS05, GS06

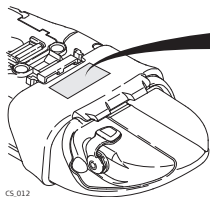

CS\_012

Type: ..... Art.No.: .....  
Equi.No.: ..... S.No.: .....

Leica Geosystems AG  
CH-9435 Heerbrugg  
Manufactured: .....  
Made in Canada



Labelling GS08,  
GS12

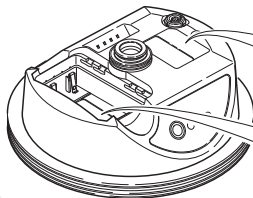

GS.123

*This device complies with part 15 of the FCC Rules. Operation is subject to the following two conditions: (1) This device may not cause harmful interference, and (2) this device must accept any interference received, including interference that may cause undesired operation.*

Type: GS..... Art.No.: .....  
 Equip.No.: XXXXXX S.No.: .....  
 Power: 12V<sup>nom</sup>, nominal 1/0.5A max.  
 Leica Geosystems AG  
 CH-9435 Heerbrugg  
 Manufactured: 2004  
 Made in Switzerland S.No.: .....



Labelling internal  
battery GEB211,  
GEB212



GEB.001

*This device complies with part 15 of the FCC Rules. Operation is subject to the following two conditions: (1) This device may not cause harmful interference, and (2) this device must accept any interference received, including interference that may cause undesired operation.*



**Exposure to radio frequency (RF) signals**

The wireless device is a radio transmitter and receiver. It is designed and manufactured not to exceed the emission limit for exposure to radio frequency (RF) energy set by the OET Bulletin 65 Supplement C / Ministry of Health (Canada), Safety Code 6. These limits are part of comprehensive guidelines and established permitted levels of RF energy for the general population. These guidelines are based on the safety standards previously set by international standard bodies. These standards include a substantial safety margin designed to assure the safety of all persons, regardless of age and health.

This device and its antenna must not be co-located or operating in conjunction with any other antenna or transmitter.

This device has been shown to be capable of compliance for localised specific absorption rate (SAR) for uncontrolled environment / general public exposure limits specific in ANSI/IEEE C95.1-1992 and had been tested in accordance with the measurement procedures specified in IEEE Std. 1528-2003.

SAR compliance for body-worn operating configurations is limited to specific belt-clips, holsters or similar accessory configurations that have no metallic component in the assembly providing at least 1.0 cm separation distance between the device and the body of the user.

---

## 6 Technical Data

### 6.1 CS10/CS15 Technical Data

---

**Design** Glass reinforced polymer housing with optional integrated battery and radio modem.

---

#### Control unit

##### CS10

Display: VGA (480 x 640 pixels), graphics capable LCD, illumination, touch screen, colour

Keyboard: 26 keys, illumination

Touch screen: Toughened film on glass

Sound: Integrated sealed speaker and microphone

Digital camera: Resolution: 1600 x 1200 pixels, fixed focus lens, image capture: JPEG

##### CS15

Display: VGA (640 x 480 pixels), graphics capable LCD, illumination, touch screen, colour

Keyboard: 65 keys including 12 function keys, illumination

Touch screen: Toughened film on glass

Sound: Integrated sealed speaker and microphone



Digital camera: Resolution: 1600 x 1200 pixels, fixed focus lens, image capture: JPEG

#### Dimensions

---

Type	Length [m]	Width [m]	Thickness [m]
CS10	0.200	0.102	0.045
CS15	0.245	0.125	0.045

#### Weight

---

Type	Weight [kg]/[lbs]
CS10, with battery, internal radio and WLAN	0.720/1.587
CS15, with battery, internal radio and WLAN	0.870/1.918

#### Recording

Data can be recorded on the SD card, CompactFlash card, USB stick or in the internal memory.

#### Power

---

Type	Consumption [W]	External supply voltage
CS10/CS15	2.0	Nominal voltage 12 V DC (---) Voltage range 10.5 V-28 V

---

**Internal battery**

Type	Battery	Voltage	Capacity	Operating time, typical*
CS10/CS15	Li-Ion	7.4 V	GEB212: 2.6 Ah	10 h

\* Operating time depends on use of wireless communication devices.

**Environmental specifications****Temperature**

Type	Operating temperature [°C]	Storage temperature [°C]
CS10/CS15	-30 to +60	-40 to +80
Internal battery	-20 to +55	-40 to +70

**Protection against water, dust and sand**

Type	Protection
CS10/CS15	IP67 (IEC60529) Dust tight Waterproof to 1 m temporary immersion

## Humidity

Type	Protection
CS10/CS15	Up to 100 % The effects of condensation are to be effectively counteracted by periodically drying out CS10/CS15.

## Interfaces

Type	RS232	USB Host	USB OTG	Bluetooth	WLAN
CS10/CS15	LEMO port or DSUB9	LEMO port or USB A	LEMO port, USB Mini-AB or docking station contacts	Class 2	802.11b/g

## Data format for RS232

The default values are:

Baud rate:	115200
Parity:	None
Terminator:	CR/LF
Data bits:	8
Stop bits:	1

## Ports

Type	8 pin LEMO-1	DSUB9	USB A Host	USB Mini	Docking station contacts
CS10/CS15	For power and/or communication	For communication			For power and/or communication

---

## 6.2

## GS05/GS06 Technical Data

### 6.2.1

### Tracking Characteristics

---

**Instrument technology**

SmartTrack+

---

**Satellite reception**

Single frequency

---

**Instrument channels**

GS05/GS06: Up to 14 channels continuous tracking on L1 (GPS); up to 14 channels continuous tracking on L1 (GLONASS); one channel tracking SBAS.



Depending on the satellite systems and signals configured, a maximum number of 14 channels is allocated.

---

**Supported codes and phases****GPS**

Type	L1
GS05/GS06	Carrier phase, C/A-code

**GLONASS**

Type	L1
GS05/GS06	Carrier phase, C/A-code



Carrier phase and code measurements on L1 (GPS) are fully independent with AS on or off.

**Satellites tracked**

GS05/GS06: Up to 14 simultaneously on L1 (GPS) + up to 14 simultaneously on L1 (GLONASS) + up to one SBAS

## 6.2.2

### Accuracy

---



Accuracy is dependent upon various factors including the number of satellites tracked, constellation geometry, observation time, ephemeris accuracy, ionospheric disturbance, multipath and resolved ambiguities.

The following accuracies, given as **root mean square**, are based on measurements processed using LGO and on real-time measurements.

The use of multiple GNSS systems can increase accuracy by up to 30% relative to GPS only.

---

#### Differential code

The baseline precision of a differential code solution for static and kinematic surveys is 40 cm. The measurement of accuracy is compliant with ISO 17123-8.

---

#### Differential phase in post-processing

Static		Kinematic	
Horizontal	Vertical	Horizontal	Vertical
5 mm + 0.5 ppm	10 mm + 0.5 ppm	10 mm + 1 ppm	20 mm + 1 ppm

---

### 6.2.3

## Technical Data

#### Description and use

The table gives a description and the intended use of the GS05/GS06.

Type	Description	Use
GS05	L1 GPS, GLONASS SmartTrack+ antenna.	With CS10 field controller.
GS06	L1 GPS, GLONASS SmartTrack+ antenna.	With CS15 field controller.

#### Dimensions

Type	Length [m]	Width [m]	Thickness [m]
GS05 with CS10	0.278	0.102	0.045
GS06 with CS15	0.323	0.125	0.045

#### Connector

5 pin interface port



**Weight**

Type	Weight [kg]/[lbs]
GS05 with CS10	0.750/1.653
GS06 with CS15	0.910/2.006

**Power**

---

Power consumption:	0.5 W typically, 45 mA
External supply voltage:	Nominal 12 V DC (---), voltage range 5 V-28 V DC

---

**Electrical data**

Type	GS05/GS06
Voltage	-
Current	-
Frequency	GPS L1 1575.42 MHz GLONASS L1 1602.5625 MHz-1611.5 MHz
Gain	Typically 27 dBi
Noise Figure	Typically < 2 dBi

---

**Environmental specifications****Temperature**

Operating temperature [°C]	Storage temperature [°C]
-30 to +60	-40 to +80

**Protection against water, dust and sand**

Protection
IP67 (IEC 60529) Dust tight Protected against water jets Waterproof to 1 m temporary immersion

**Humidity**

Protection
Up to 100 % The effects of condensation are to be effectively counteracted by periodically drying out the antenna.

## 6.3

### CTR16 Technical Data

---

#### Description and use

The CTR16 is a high performance wireless data transfer device operating in the 2.4 GHz frequency band. The CTR16 meets the IP67 standard and provides a high level of protection against environmental influences. CTR16 can be used on CS15 controller only.

---

#### Dimensions

Type	Length [m]	Width [m]	Thickness [m]
CTR16	0.131	0.069	0.053

---

#### Connector

5 pin interface port

---

#### Weight

0.155 kg / 0.342 lbs

---

#### Power

Type	CTR16
Power consumption	100 mA nominal (5 V), 200 mA max.
Power supply	From instrument

---

**Environmental specifications****Temperature**

Operating temperature [°C]	Storage temperature [°C]
-30 to +60	-40 to +80

**Protection against water, dust and sand**

Protection
IP67 (IEC 60529) Dust tight Protected against water jets Waterproof to 1 m temporary immersion

**Humidity**

Protection
Up to 100 % The effects of condensation are to be effectively counteracted by periodically drying out the CTR16.

## 6.4

## GS08/GS12 Technical Data

### 6.4.1

### Tracking Characteristics

---

#### Instrument technology

SmartTrack+

---

#### Satellite reception

GS08: Dual frequency.  
GS12: Triple frequency.

---

#### Instrument channels

GS08: Up to 14 channels continuous tracking on L1, L2 (GPS); up to 12 channels continuous tracking on L1 and L2 (GLONASS); two channels tracking SBAS (EGNOS, WAAS, MSAS, GAGAN).  
GS12: Up to 16 channels continuous tracking on L1, L2 and L5 (GPS); up to 14 channels continuous tracking on L1 and L2 (GLONASS); up to 14 channels continuous tracking on E1, E5a, E5b and Alt-BOC (Galileo); four channels tracking SBAS (EGNOS, WAAS, MSAS, GAGAN).



Depending on the satellite systems and signals configured, a maximum number of 72 (GS08) or 120 (GS12) channels is allocated.

---

Supported codes  
and phases

## GPS

Type	L1	L2	L5
GS08	Carrier phase, C/A-code	Carrier phase, C code (L2C) and P2-code	-
GS12	Carrier phase, C/A-code	Carrier phase, C code (L2C) and P2-code	Carrier phase, code

## GLONASS

Type	L1	L2
GS08	Carrier phase, C/A-code	Carrier phase, P2-code
GS12	Carrier phase, C/A-code	Carrier phase, P2-code

## Galileo

Type	E1	E5a	E5b	Alt-BOC
GS12	Carrier phase, code	Carrier phase, code	Carrier phase, code	Carrier phase, code



---

Carrier phase and code measurements on L1, L2 and L5 (GPS) are fully independent with AS on or off.

---

<b>Satellites tracked</b>	GS08:	Up to 14 simultaneously on L1, L2 (GPS) + up to twelve simultaneously on L1 and L2 (GLONASS)+ up to two SBAS (EGNOS, WAAS, MSAS, GAGAN)
	GS12:	Up to 16 simultaneously on L1, L2 and L5 (GPS) + up to 14 simultaneously on L1 and L2 (GLONASS) + up to 14 simultaneously on E1, E5a, E5b and Alt-BOC (Galileo) + up to four SBAS (EGNOS, WAAS, MSAS, GAGAN)

---

## 6.4.2

## Accuracy



Accuracy is dependent upon various factors including the number of satellites tracked, constellation geometry, observation time, ephemeris accuracy, ionospheric disturbance, multipath and resolved ambiguities.

The following accuracies, given as **root mean square**, are based on measurements processed using LGO and on real-time measurements.

The use of multiple GNSS systems can increase accuracy by up to 30% relative to GPS only.

## Differential code

The baseline precision of a differential code solution for static and kinematic surveys is 25 cm.

Differential phase  
in post-processing

## Static and rapid static

Static		Kinematic	
Horizontal	Vertical	Horizontal	Vertical
5 mm + 0.5 ppm	10 mm + 0.5 ppm	10 mm + 1 ppm	20 mm + 1 ppm



### Static with long observations

Static		Kinematic	
Horizontal	Vertical	Horizontal	Vertical
3 mm + 0.5 ppm (GS08) 3 mm + 0.1 ppm (GS12)	6 mm + 0.5 ppm (GS08) 3.5 mm + 0.4 ppm (GS12)	10 mm + 1 ppm	20 mm + 1 ppm

### Differential phase in real-time

Static		Kinematic	
Horizontal	Vertical	Horizontal	Vertical
5 mm + 0.5 ppm	10 mm + 0.5 ppm	10 mm + 1 ppm	20 mm + 1 ppm

### 6.4.3 Technical Data

#### Description and use

The table gives a description and the intended use of the GS08/GS12.

Type	Description	Use
GS08	L1, L2 GPS, GLONASS SmartTrack+ antenna.	With CS10 field controller.
GS12	L1, L2, L5 GPS, GLONASS, Galileo SmartTrack+ antenna.	With CS10 or CS15 field controller.

#### Dimensions

Height: 0.089 m  
Diameter: 0.186 m

#### Connector

- 8 pin LEMO-1
- 5 pin SmartStation clip-on-contacts (GS12 only)

#### Mounting

5/8" Whitworth

#### Weight

1.1 kg including internal battery

#### Power

Power consumption: 1.8 W typically  
External supply voltage: Nominal 12 V DC (≡≡≡), voltage range 10.5 V-28 V

**Battery internal**

---

Type:	Li-Ion
Voltage:	7.4 V
Capacity:	GEB211: 2.2 Ah GEB212: 2.6 Ah
Typical operating time:	7 h

The given operating times are valid for

- one fully charged GEB212 battery.
- 25°C. Operating times will be shorter when working in cold weather.

**Electrical data**

---

Type	GS08	GS12
Frequency		
GPS L1 1575.42 MHz	✓	✓
GPS L2 1227.60 MHz	✓	✓
GPS L5 1176.45 MHz	-	✓
GLONASS L1 1602.5625-1611.5 MHz	✓	✓
GLONASS L2 1246.4375-1254.3 MHz	✓	✓
Galileo E1 1575.42 MHz	-	✓
Galileo E5a 1176.45 MHz	-	✓

Type	GS08	GS12
Galileo E5b 1207.14 MHz	-	✓
Galileo Alt-BOC 1191.795 MHz	-	✓
Gain	Typically 27 dBi	Typically 27 dBi
Noise Figure	Typically < 2 dBi	Typically < 2 dBi

### Environmental specifications

#### Temperature

Operating temperature [°C]	Storage temperature [°C]
-40 to +65	-40 to +80
Bluetooth: -30 to +65	

#### Protection against water, dust and sand

Protection
IP67 (IEC 60529)
Dusttight
Protected against water jets
Waterproof to 1 m temporary immersion

## Humidity

Protection
Up to 100 % The effects of condensation are to be effectively counteracted by periodically drying out the antenna.

## 6.5 Antennas Technical Data

---

### Description and use

The table gives a description and the intended use of the antenna.

Type	Description	Use
AS05	L1 GPS, GLONASS SmartTrack+ antenna with built-in ground plane.	With CS10/GS05, CS15/GS06.

---

### Dimensions

Type	AS05
Height	6.2 cm
Diameter	17.0 cm

---

### Connector

AS05: TNC female

---

### Mounting

AS05: 5/8" Whitworth

---

### Weight

AS05: 0.4 kg

---

**Electrical data**

Type	AS05
Voltage	4.5 V to 18 V DC
Current	35 mA typical
Frequency	GPS L1 1575.42 MHz GLONASS L1 1602.5625 MHz-1611.5 MHz
Gain (typically)	27 dBi
Noise Figure (typically)	< 2 dBi

**Environmental specifications****Temperature**

Type	Operating temperature [°C]	Storage temperature [°C]
AS05	-40 to +70	-55 to +85

**Protection against water, dust and sand**

Type	Protection
AS05	IP67 (IEC 60529) Dust tight Protected against water jets

---

Type	Protection
	Waterproof to 1 m temporary immersion

**Humidity**

Type	Protection
AS05	Up to 100 % The effects of condensation are to be effectively counteracted by periodically drying out the antenna.

**Cable length**

---

Separation distance from instrument ...	to antenna	Supplied cable lengths [m]
GS05/GS06	AS05	1.2

---



## 6.6

## Conformity to National Regulations

---

### Conformity to national regulations

For products which do not fall under R&TTE directive:



Hereby, Leica Geosystems AG, declares that the product/s is/are in compliance with the essential requirements and other relevant provisions of Directive 1999/5/EC. The declaration of conformity can be consulted at <http://www.leica-geosystems.com/ce>.

---

### 6.6.1

### CS10

---

### Conformity to national regulations

- FCC Part 15 (applicable in US)
- Hereby, Leica Geosystems AG, declares that the product CS10 is in compliance with the essential requirements and other relevant provisions of Directive 1999/5/EC. The declaration of conformity can be consulted at <http://www.leica-geosystems.com/ce>.



Class 2 equipment according European Directive 1999/5/EC (R&TTE) for which following EEA Member States apply restrictions on the placing on the market or on the putting into service or require authorisation for use:

- France
  - Italy
  - Norway (if used in the geographical area within a radius of 20km from the centre of Ny-Ålesund)
- The conformity for countries with other national regulations not covered by the FCC part 15 or European directive 1999/5/EC has to be approved prior to use and operation.

### Frequency band

Type	Frequency band [MHz]
CS10, Bluetooth	2402 - 2480
CS10, RCS	2402 - 2452
CS10, 3.5G GSM/UMTS	UMTS/HSDPA (WCDMA/FDD) 850 / 1900 / 2100 Quad-Band EGSM 850 / 900 / 1800 / 1900 GPRS multi-slot class 12 EDGE multi-slot class 12
CS10, WLAN	2400 - 2484

**Output power**

Type	Output power [mW]
CS10, Bluetooth	2.5
CS10, RCS	< 100
CS10, 3.5G GSM/UMTS EGSM850/900	2
CS10, 3.5G GSM/UMTS GSM1800/1900	1
CS10, 3.5G GSM/UMTS UMTS2100	0.25
CS10, 3.5G GSM/UMTS EDGE850/900	0.5
CS10, 3.5G GSM/UMTS EDGE1800/1900	0.4
CS10, WLAN (802.11b)	50
CS10, WLAN (802.11g) 6 Mbit/s-36 Mbit/s	50
CS10, WLAN (802.11b) 48 Mbit/s-56 Mbit/s	31.6

**Antenna**

Type	Antenna	Gain [dBi]	Connector	Frequency band [MHz]
CS10, Bluetooth	Integrated antenna	-	-	-

---

Type	Antenna	Gain [dBi]	Connector	Frequency band [MHz]
CS10, RCS	Integrated antenna	-	-	-
CS10, 3.5G GSM/UMTS	Integrated antenna	-	-	-
CS10, WLAN	Integrated antenna	-	-	-
GS05	Internal GNSS antenna element (receive only)	-	-	-

---

## 6.6.2

## CS15

### Conformity to national regulations

- FCC Part 15 (applicable in US)
- Hereby, Leica Geosystems AG, declares that the product CS15 is in compliance with the essential requirements and other relevant provisions of Directive 1999/5/EC. The declaration of conformity can be consulted at <http://www.leica-geosystems.com/ce>.



Class 2 equipment according European Directive 1999/5/EC (R&TTE) for which following EEA Member States apply restrictions on the placing on the market or on the putting into service or require authorisation for use:

- France
  - Italy
  - Norway (if used in the geographical area within a radius of 20km from the centre of Ny-Ålesund)
- The conformity for countries with other national regulations not covered by the FCC part 15 or European directive 1999/5/EC has to be approved prior to use and operation.

### Frequency band

Type	Frequency band [MHz]
CS15, Bluetooth	2402 - 2480
CS15, RCS	2402 - 2452

Type	Frequency band [MHz]
CS15, 3.5G GSM/UMTS	UMTS/HSDPA (WCDMA/FDD) 850 / 1900 / 2100 Quad-Band EGSM 850 / 900 / 1800 / 1900 GPRS multi-slot class 12 EDGE multi-slot class 12
CS15, WLAN	2400 - 2484

## Output power

Type	Output power [mW]
CS15, Bluetooth	2.5
CS15, RCS	< 100
CS15, 3.5G GSM/UMTS EGSM850/900	2
CS15, 3.5G GSM/UMTS GSM1800/1900	1
CS15, 3.5G GSM/UMTS UMTS2100	0.25
CS15, 3.5G GSM/UMTS EDGE850/900	0.5
CS15, 3.5G GSM/UMTS EDGE1800/1900	0.4
CS15, WLAN (802.11b)	50
CS15, WLAN (802.11g) 6 Mbit/s-36 Mbit/s	50

Type	Output power [mW]
CS15, WLAN (802.11b) 48 Mbit/s-56 Mbit/s	31.6

## Antenna

Type	Antenna	Gain [dBi]	Connector	Frequency band [MHz]
CS15, Bluetooth	Integrated antenna	-	-	-
CS15, RCS	Integrated antenna	-	-	-
CS15, 3.5G GSM/UMTS	Integrated antenna	-	-	-
CS15, WLAN	Integrated antenna	-	-	-
GS06	Internal GNSS antenna element (receive only)	-	-	-

### 6.6.3

### CTR16

---

#### Conformity to national regulations

- FCC Part 15 (applicable in US)
- Hereby, Leica Geosystems AG, declares that the CTR16 is in compliance with the essential requirements and other relevant provisions of Directive 1999/5/EC. The declaration of conformity may be consulted at <http://www.leica-geosystems.com/ce>.



Class 2 equipment according European Directive 1999/5/EC (R&TTE) for which following EEA Member States apply restrictions on the placing on the market or on the putting into service or require authorisation for use:

- France
  - Italy
  - Norway (if used in the geographical area within a radius of 20km from the centre of Ny-Ålesund)
- The conformity for countries with other national regulations not covered by the FCC part 15 or European directive 1999/5/EC has to be approved prior to use and operation.

#### Frequency band

---

CTR16:	Limited to 2402 - 2480 MHz
CTR16 (France):	Limited to 2402 - 2452 MHz

---



**Output power**

< 100 mW (e. i. r. p.)

---

**Antenna**

Type:  $\lambda/2$  antenna  
Gain: 2. dBi maximal  
Connector: None (internal)

---

## 6.6.4

## GS08

**Conformity to national regulations**

- FCC Part 15, 22 and 24 (applicable in US)
- Hereby, Leica Geosystems AG, declares that the product GS08 is in compliance with the essential requirements and other relevant provisions of Directive 1999/5/EC. The declaration of conformity can be consulted at <http://www.leica-geosystems.com/ce>.



Class 1 equipment according European Directive 1999/5/EC (R&TTE) can be placed on the market and be put into service without restrictions in any EEA member state.

- The conformity for countries with other national regulations not covered by the FCC part 15, 22 and 24 or European directive 1999/5/EC has to be approved prior to use and operation.

**Frequency band**

Type	Frequency band [MHz]
GS08	1227.60 1575.42 1246.4375 - 1254.3 1602.4375 - 1611.5
Bluetooth	2402 - 2480

**Output power**

Type	Output power [mW]
GNSS	Receive only
Bluetooth	5 (Class 1)

**Antenna**

---

GNSS	Internal GNSS antenna element (receive only)
Bluetooth	Type: Internal Microstrip antenna Gain: 1.5 dBi

---

## 6.6.5

## GS12

**Conformity to national regulations**

- FCC Part 15, 22 and 24 (applicable in US)
- Hereby, Leica Geosystems AG, declares that the product GS12 is in compliance with the essential requirements and other relevant provisions of Directive 1999/5/EC. The declaration of conformity can be consulted at <http://www.leica-geosystems.com/ce>.



Class 1 equipment according European Directive 1999/5/EC (R&TTE) can be placed on the market and be put into service without restrictions in any EEA member state.

- The conformity for countries with other national regulations not covered by the FCC part 15, 22 and 24 or European directive 1999/5/EC has to be approved prior to use and operation.

**Frequency band**

Type	Frequency band [MHz]
GS12	1176.45 1191.795 1207.14 1227.60 1246.4375 - 1254.3 1575.42 1602.4375 - 1611.5

---

Type	Frequency band [MHz]
Bluetooth	2402 - 2480

---

### Output power

Type	Output power [mW]
GNSS	Receive only
Bluetooth	5 (Class 1)

---

### Antenna

GNSS	Internal GNSS antenna element (receive only)
Bluetooth	Type: Internal Microstrip antenna Gain: 1.5 dBi

---

## 7 International Limited Warranty, Software Licence Agreement

---

### **International Limited Warranty**

This product is subject to the terms and conditions set out in the International Limited Warranty which you can download from the Leica Geosystems home page at <http://www.leica-geosystems.com/internationalwarranty> or collect from your Leica Geosystems distributor. The foregoing warranty is exclusive and is in lieu of all other warranties, terms or conditions, expressed or implied, either in fact or by operation of law, statutory or otherwise, including warranties, terms or conditions of merchantability, fitness for a particular purpose, satisfactory quality and non-infringement, all which are expressly disclaimed.

---

### **Software Licence Agreement**

This product contains software that is preinstalled on the product, or that is supplied to you on a data carrier medium, or that can be downloaded by you online according to prior authorisation from Leica Geosystems. Such software is protected by copyright and other laws and its use is defined and regulated by the Leica Geosystems Software Licence Agreement, which covers aspects such as, but not limited to, Scope of the Licence, Warranty, Intellectual Property Rights, Limitation of Liability, Exclusion of other Assurances, Governing Law and Place of Jurisdiction. Please make sure, that at any time you fully comply with the terms and conditions of the Leica Geosystems Software Licence Agreement.

Such agreement is provided together with all products and can also be referred to and downloaded at the Leica Geosystems home page at <http://www.leica-geosystems.com/swlicense> or collected from your Leica Geosystems distributor.

You must not install or use the software unless you have read and accepted the terms and conditions of the Leica Geosystems Software Licence Agreement. Installation or use of the software or any part thereof, is deemed to be an acceptance of all the terms and conditions of such Licence Agreement. If you do not agree to all or some of the terms of such Licence Agreement, you must not download, install or use the software and you must return the unused software together with its accompanying documentation and the purchase receipt to the distributor from whom you purchased the product within ten (10) days of purchase to obtain a full refund of the purchase price.

---

## Appendix A Pin Assignments and Sockets

### A.1 CS10/CS15

#### Description

Some applications require knowledge of the pin assignments for the CS10/CS15 ports.

In this chapter, the pin assignments and sockets for the ports of the CS10/CS15 are explained.

#### Ports at the instrument bottom panel - DSUB9 connector

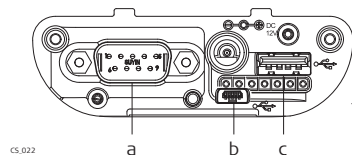

- a) DSUB9 port
- b) USB Mini port
- c) USB A Host port

#### Ports at the instrument bottom panel - Lemo connector

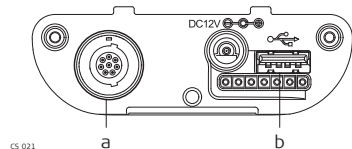

- a) Lemo port (USB and serial)
- b) USB A Host port



### Pin assignments for RS232 serial port



PIN\_002

Pin	Signal Name	Function	Direction
1	NC	Not connected	-
2	RxD	RS232, receive data	In
3	TxD	RS232, transmit data	Out
4	NC	Not connected	-
5	GND	Signal Ground	-
6	NC	Not connected	-
7	RTS	RS232, request to send	Out
8	CTS	RS232, clear to send	In
9	NC	Not connected	-

### Pin assignments for 8 pin LEMO-1

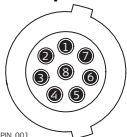

PIN\_001

Pin	Signal Name	Function	Direction
1	USB_D+	USB data line	In or out
2	USB_D-	USB data line	In or out
3	GND	Signal ground	-
4	RxD	RS232, receive data	In

---

Pin	Signal Name	Function	Direction
5	TxD	RS232, transmit data	Out
6	ID	Identification pin	In or out
7	PWR	Power input, 10.5 V-28 V	In
8	TRM_ON/USB_ID	RS232, general purpose signal	In or out

---

**Sockets**

9 pin RS232:

RS232, 9 pin, DE9

8 pin LEMO-1:

LEMO-1, 8 pin, LEMO EGI.1B.308.CLN

## A.2

## GS08/GS12

---

### Description

Some applications require knowledge of the pin assignments for the GS08/GS12 ports. In this chapter, the pin assignments and sockets for the ports of the GS08/GS12 are explained.

---

### Ports at the instrument underside

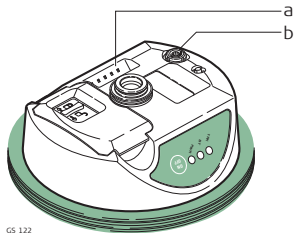

- a) Clip on contacts (only GS12)
  - b) Lemo port (USB and serial)
-

**Pin assignments  
for 8 pin LEMO-1**

PIN\_001

Pin	Signal Name	Function	Direction
1	USB_D+	USB data line	In or out
2	USB_D-	USB data line	In or out
3	GND	Signal ground	-
4	RxD	RS232, receive data	In
5	TxD	RS232, transmit data	Out
6	ID	Identification pin	In or out
7	PWR	Power input, 10.5 V-28 V	In
8	TRM_ON/USB_ID	RS232, general purpose signal	In or out

**Sockets**

8 pin LEMO-1:

LEMO-1, 8 pin, LEMO EGI.1B.308.CLN

# Index

---

## A

ActiveSync .....	45
Antenna	
CTR15 .....	129
Antennas .....	118
GS08 .....	131
GS12 .....	133
Operating Temperature .....	119
Storing Temperature .....	119
Type .....	118

## B

Batteries	
Charge in CS10/CS15 .....	57
Charging, first-time use .....	53
Operation, Discharging .....	53
Battery	
Change in CS10/CS15 .....	54
Charge in CS10/CS15 .....	57
Internal, GS08 .....	115
Internal, GS12 .....	115
Storage temperature .....	98

## Bluetooth

LED on CS10 .....	63
LED on CS15 .....	63
LED on GS08 .....	68
LED on GS12 .....	68

## C

### CompactFlash card

Insert .....	59
Memory device .....	20
Remove .....	59

### Connector

GS05 .....	104, 107
GS06 .....	104, 107
GS08 .....	114
GS12 .....	114

### Connector, antennas .....

## CS

Available models .....	12
Display foil .....	34
Docking Station .....	26, 41
Firmware for all CS models .....	14

---

Lock keyboard .....	52	Description of the system .....	11
Operating principles .....	33	Digital Camera .....	70
Power Options menu .....	51	Dimensions	
Stand-by mode .....	51	Antennas .....	118
System components .....	11	GS08 .....	114
Unlock keyboard .....	52	GS12 .....	114
CS10		SmartAntenna .....	104
Operating temperature .....	98	Display foil .....	34
Status .....	63	Docking Station	
Storage temperature .....	98	Components .....	26
Underside .....	23	Mounting .....	41
Upside .....	22	Documentation .....	4
CS15		Drive	
Operating temperature .....	98	PC card, on office computer .....	21
Status .....	63	<b>E</b>	
Storage temperature .....	98	Electrical data	
Underside .....	25	GS08 .....	115
Upside .....	24	GS12 .....	115
CTR16		Electrical Data	
Operating Temperature .....	108	GS05 .....	105
Storage Temperature .....	108	GS06 .....	105
<b>D</b>		Electrical data, antennas .....	119
Data transfer .....	21		

Environmental specifications		Storage Temperature .....	106
Antenna .....	119	GS06	
GS05 .....	106	Operating Temperature .....	106
GS06 .....	106	Storage Temperature .....	106
GS08 .....	116	GS08	
GS12 .....	116	Status .....	68
<b>F</b>		GS12	
FCC Statement .....	91	Status .....	68
Frequency band		<b>H</b>	
GS08 .....	130	Hand strap .....	36
GS12 .....	132	Handheld GNSS .....	42
Frequency Band		<b>I</b>	
CTR16 .....	128	Indicators, LED	
<b>G</b>		CS10 .....	63
GEB211 (internal battery)		CS15 .....	63
Operating temperature .....	98	CTR16 .....	66
GEB212 (internal battery)		GS08 .....	68
Operating temperature .....	98	GS12 .....	68
GS		Insert	
Firmware for GS05/GS06 .....	14	CompactFlash card .....	59
Firmware for GS08/GS12 .....	14	SD card .....	61
GS05		SIM card .....	39
Operating Temperature .....	106	Intended Use .....	77

Internal memory		Function keys .....	29
Memory device .....	20	Home .....	30
International Limited Warranty .....	134	Hot keys .....	29
<b>K</b>		Numeric keys .....	29
Key combinations		OK .....	31
Description of .....	32	ON/OFF .....	30
Keyboard		SPACE key .....	29
CS10 Graphical overview .....	27	<b>L</b>	
CS15 Graphical overview .....	28	Labelling	
Operating principles .....	33	CS10 .....	92
Keyboard illumination		CS15 .....	92
Turn off .....	32	CTR16 .....	93
Turn on .....	32	GEB211 .....	94
Keys		GEB212 .....	94
Alpha keys .....	29	GS05 .....	93
Arrow keys .....	31	GS06 .....	93
Backspace key .....	29	GS08 .....	94
Caps Lock .....	29	GS12 .....	94
Description of .....	29	LED	
ENTER key .....	30	CS10, description .....	64
ESC key .....	29	CS15, description .....	64
Favourites .....	30	CTR15, description .....	66
Fn key .....	29	GS08, description .....	69



GS12, description .....	69	GEB212 (internal battery) .....	98
Light Emitting Diode		GS05 .....	106
CS10 .....	63	GS06 .....	106
CS15 .....	63	GS08 .....	116
CTR16 .....	66	GS12 .....	116
GS08 .....	68	Output power	
GS12 .....	68	GS08 .....	131
Li-Ion battery .....	115	GS12 .....	133
Storage .....	73	Output Power	
		CTR15 .....	129
<b>M</b>			
Memory device		<b>P</b>	
Available .....	20	PC card drive on office computer .....	21
Microsoft ActiveSync .....	45	Pin Assgiment .....	136
Mount, antennas .....	118	Power	
Mount, GS08 .....	114	GS05 .....	105
Mount, GS12 .....	114	GS06 .....	105
		GS08 .....	114
<b>O</b>		GS12 .....	114
Operating Temperature		Power LED	
Antennas .....	119	CS10 .....	63
CS10 .....	98	CS15 .....	63
CS15 .....	98	GS08 .....	68
CTR16 .....	108	GS12 .....	68
GEB211 (internal battery) .....	98		

Power supply .....	18	SIM card	
<b>R</b>		Insert .....	39
Radio Modem		Remove .....	39
Available radios .....	13	Slot Cover .....	38
Recording .....	97	Socket .....	136
Remove		Software	
CompactFlash card .....	59	Upload .....	15
SD card .....	61	Software Licence Agreement .....	134
SIM card .....	39	Specifications, environmental	
Reset		Antennas .....	119
Options .....	52	CTR16 .....	108
Responsibilities .....	80	GS05 .....	106
Robotic setup .....	44	GS06 .....	106
<b>S</b>		Status, CS10 .....	63
Safety Directions .....	76	Status, CS15 .....	63
Satellite reception .....	109	Status, CTR16 .....	66
Screen brightness		Status, GS08 .....	68
Decrease .....	32	Status, GS12 .....	68
Increase .....	32	Storage Temperature	
SD card		CS10 .....	98
Insert .....	61	CS15 .....	98
Memory device .....	20	CTR16 .....	108
Remove .....	61	For internal battery GEB211 .....	98
		For internal battery GEB212 .....	98

GS05 .....	106	Weight .....	97
GS06 .....	106	Temperature range	
GS08 .....	116	Product, drying .....	74
GS12 .....	116	Temperature, charging internal battery .....	53
Storing Temperature		Touch screen	
Antennas .....	119	Turn off .....	52
		Turn on .....	52
<b>T</b>		Touch Screen, operating principles .....	33
Technical Data		TPS radio LED on CTR15 .....	66
CS10 .....	96	Tracking LED	
CS15 .....	96	GS08 .....	68
CTR16 .....	107	GS12 .....	68
Dimensions .....	97	Transfer data .....	21
Display and keyboard .....	96		
Environmental specifications .....	98	<b>U</b>	
GS05 .....	101	Upload software .....	15
GS06 .....	101	USB stick	
GS08 .....	109	Memory device .....	20
GS12 .....	109	User Interface .....	27
Interface .....	99	User Manual	
Internal battery GEB211 .....	98	Validity of .....	4
Internal battery GEB212 .....	98		
Ports .....	100	<b>V</b>	
Power supply .....	97	Volume	
		Decrease .....	32

---

Increase ..... 32

**W**

## Weight

Antennas ..... 118

GS05 ..... 105

GS06 ..... 105

GS08 ..... 114

GS12 ..... 114

## Windows CE

Reset registry ..... 52

Restart ..... 52

Windows Mobile Device Center ..... 45

WLAN ..... 12



**Total Quality Management: Our commitment to total customer satisfaction.**



Leica Geosystems AG, Heerbrugg, Switzerland, has been certified as being equipped with a quality system which meets the International Standards of Quality Management and Quality Systems (ISO standard 9001) and Environmental Management Systems (ISO standard 14001).

**Ask your local Leica Geosystems dealer for more information about our TQM program.**

**Leica Geosystems AG**

Heinrich-Wild-Strasse  
CH-9435 Heerbrugg  
Switzerland  
Phone +41 71 727 31 31

[www.leica-geosystems.com](http://www.leica-geosystems.com)

- when it has to be **right**

**Leica**  
**Geosystems**

**772386-4.0.0en**

Original text  
Printed in Switzerland  
© 2011 Leica Geosystems AG, Heerbrugg, Switzerland