

Leica CSX8

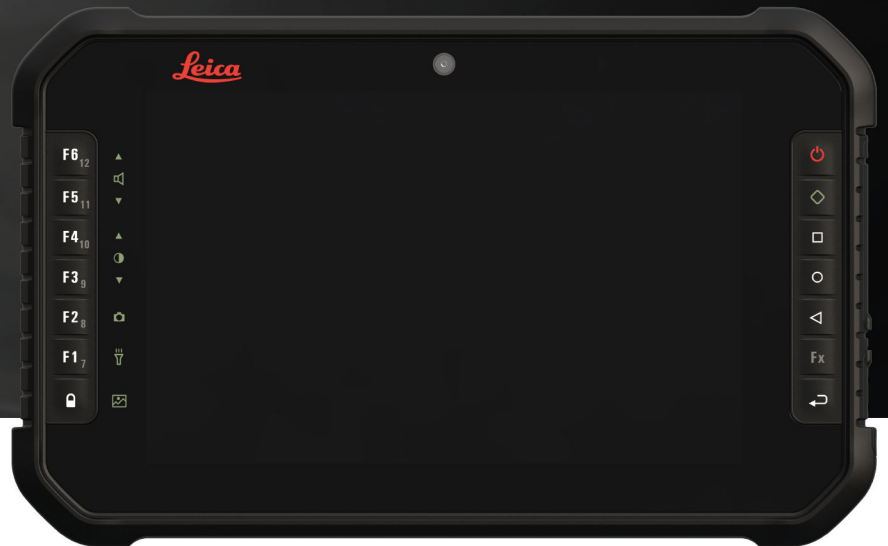

User Manual
Version 1.0
English

- when it has to be **right**

Leica
Geosystems

PART OF
HEXAGON

Introduction

Purchase

Congratulations on the purchase of the Leica CSX8.



This manual contains important safety directions as well as instructions for setting up the product and operating it. Refer to **1 Safety Directions** for further information.

Read carefully through the User Manual before you switch on the product.



The content of this document is subject to change without prior notice. Ensure that the product is used in accordance with the latest version of this document.

Updated versions are available for download at the following Internet address:
<https://myworld-portal.leica-geosystems.com/> > myDownloads

Product identification



The model and serial number of your product are indicated on the type label. Always refer to this information when contacting your agency or Leica Geosystems authorised service centre.

Trademarks and Licenses

- Android™ is a trademark of Google Inc.
- Bluetooth® is a registered trademark of Bluetooth SIG, Inc.
- SD Logo is a trademark of SD-3C, LLC.

All other trademarks are the property of their respective owners.

Available documentation

Name	Description/Format		
Leica CSX8 Quick Guide	Provides an overview of the product together with technical data and safety directions. Intended as a quick reference guide.	✓	✓
Leica CSX8 User Manual	All instructions required in order to operate the product to a basic level are contained in the User Manual. Provides an overview of the product together with technical data and safety directions.	-	✓

Refer to the following resources for all CSX8 documentation/software:

- <https://myworld-portal.leica-geosystems.com/>

Leica Geosystems address book

On the last page of this manual, you can find the address of Leica Geosystems headquarters. For a list of regional contacts, please visit http://leica-geosystems.com/contact-us/sales_support.



<https://myworld-portal.leica-geosystems.com/> offers a wide range of services, information and training material.

With direct access to myWorld, you are able to access all relevant services whenever it is convenient for you.

The availability of services depends on the instrument model.

Service	Description
My Products	Register all products that you and your company own and explore your world of Leica Geosystems: View detailed information on your products and update your products with the latest software and keep up-to-date with the latest documentation.
My Service	View the current service status and full service history of your products in Leica Geosystems service centres. Access detailed information on the services performed and download your latest calibration certificates and service reports.
My Support	Create new support requests for your products that will be answered by your local Leica Geosystems support team. View your complete support history and view detailed information on all your support requests.
My Knowledge	Enter key words and start searching in our knowledge base. You can find FAQs (Frequently asked questions) as well as Knowledge articles for Leica Geosystems products.
My Downloads	Downloads of software, manuals, tools, training material and news for Leica Geosystems products. Download the latest documentation and software to keep yourself and your products up-to-date. You can access downloads of software, manuals, tools, and training material.
Online Learning	Welcome to the home of Leica Geosystems online learning! There are numerous online courses – available to all customers with products that have valid CCPs (Customer Care Packages).
My SmartNet	Add and view your HxGN SmartNet subscriptions and user information. HxGN SmartNet delivers high-precision and high-availability GNSS network correction services in real-time and around the globe. The HxGN SmartNet Global family offers Network RTK with RTK bridging and Precise Point Positioning (PPP) services. These services work exclusively with Leica Geosystems GS smart antennas and receivers, providing the highest accuracy. Combined, they ensure HxGN SmartNet coverage everywhere.
My Trusted Services	Leica Geosystems Trusted Services offer you increased productivity while at the same time providing maximum security. New software services and state-of-the-art IT infrastructure offer a vast potential to optimise your workflow and increase your efficiency and productivity, both now and in the future.
My Security	Leica Geosystems Security delivers you total peace-of-mind in knowing that if your instrument is ever stolen, a locking mechanism is available to ensure that the instrument is disabled and can no longer be used.

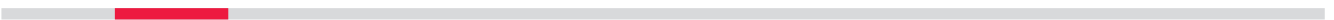

Table of Contents

1	Safety Directions	6
1.1	General Introduction	6
1.2	Definition of Use	7
1.3	Limits of Use	7
1.4	Responsibilities	8
1.5	Hazards of Use	8
1.6	Electromagnetic Compatibility (EMC)	13
2	Box Content	16
3	Description of the System	17
3.1	Overview	17
3.2	Terminology	17
3.3	System Concept	17
3.3.1	Power Concept	17
3.3.2	Data Storage Concept	17
3.4	CSX8 Components	18
3.5	Battery Charger	20
4	First-time Use	21
5	User Interface	24
5.1	Keyboard	24
5.2	Operating Principles	27
5.3	System Main Interface	28
6	Operation	32
6.1	Equipment Setup	32
6.1.1	Fixing the Tablet to a Holder and Pole	32
6.1.2	Replacing the Display Foil on the CSX8	34
6.2	Batteries	35
6.2.1	Operating Principles	35
6.2.2	Changing the Battery	36
6.2.3	Charging the Battery	37
6.3	Power Functions	37
6.4	Working with the Memory Device	37
6.4.1	Working with the microSD Card and Nano SIM Card	37
6.4.2	Working with a USB Memory Stick	38
6.5	Working under different environmental conditions	39
7	Care and Transport	40
7.1	Transport	40
7.2	Storage	40
7.3	Cleaning and Drying	40
8	Technical Data	42
8.1	CSX8	42
8.2	Conformity to National Regulations	44
8.3	Environmental Specifications	48
9	Software Licence Agreement/Warranty	50
Appendix A	Appendix	51
A.1	Appendix A: Operating Frequencies EU (CE)	51
A.2	Appendix B: Operating Frequencies US/CAN	55

1 Safety Directions

1.1 General Introduction

Description

The following directions enable the person responsible for the product, and the person who actually uses the equipment, to anticipate and avoid operational hazards.

The person responsible for the product must ensure that all users understand these directions and adhere to them.

About warning messages





Warning messages are an essential part of the safety concept of the instrument. They appear wherever hazards or hazardous situations can occur.

Warning messages...

- make the user alert about direct and indirect hazards concerning the use of the product.
- contain general rules of behaviour.

For the users' safety, all safety instructions and safety messages shall be strictly observed and followed! Therefore, the manual must always be available to all persons performing any tasks described here.

DANGER, WARNING, CAUTION and **NOTICE** are standardised signal words for identifying levels of hazards and risks related to personal injury and property damage. For your safety, it is important to read and fully understand the following table with the different signal words and their definitions! Supplementary safety information symbols may be placed within a warning message as well as supplementary text.

Type	Description
 DANGER	Indicates an imminently hazardous situation which, if not avoided, will result in death or serious injury.
 WARNING	Indicates a potentially hazardous situation or an unintended use which, if not avoided, could result in death or serious injury.
 CAUTION	Indicates a potentially hazardous situation or an unintended use which, if not avoided, may result in minor or moderate injury.
NOTICE	Indicates a potentially hazardous situation or an unintended use which, if not avoided, may result in appreciable material, financial and environmental damage.
	Important paragraphs which must be adhered to in practice as they enable the product to be used in a technically correct and efficient manner.

Additional symbols



Warning against explosive material.



Warning against flammable substances.



Product must not be opened or modified or tampered with.



Indicates the temperature limits at which the product may be stored, transported or used.

1.2

Definition of Use

Intended use

- Remote control of product
- Data communication with external appliances
- Recording measurements
- Computing with software

Reasonably foreseeable misuse

- Use of the product without instructions
- Use outside of the intended use and limits
- Disabling of safety systems
- Removal of hazard notices
- Opening the product using tools, for example a screwdriver, unless this is permitted for certain functions
- Modification or conversion of the product
- Use after misappropriation
- Use of products with recognisable damage or defects
- Use with accessories from other manufacturers without the prior explicit approval of Leica Geosystems
- Inadequate safeguards at the working site
- Controlling of machines, moving objects or similar monitoring applications without additional control and safety installations

1.3

Limits of Use

Environment

Suitable for use in an atmosphere appropriate for permanent human habitation. Not suitable for use in aggressive or explosive environments.

WARNING

Working in hazardous areas or close to electrical installations or similar situations

Life Risk.

Precautions:

- ▶ Local safety authorities and safety experts must be contacted by the person responsible for the product before working in such conditions.



The following advice is only valid for battery charger and power adapter.

Environment

Suitable for use in dry environments only and not under adverse conditions.



1.4

Responsibilities

Manufacturer of the product

Leica Geosystems AG, CH-9435 Heerbrugg, hereinafter referred to as Leica Geosystems, is responsible for supplying the product, including the User Manual and original accessories, in a safe condition.

Person responsible for the product

The person responsible for the product has the following duties:

- To understand the safety instructions on the product and the instructions in the User Manual
- To ensure that the product is used in accordance with the instructions
- To be familiar with local regulations relating to safety and accident prevention
- To stop operating the system and inform Leica Geosystems immediately if the product and the application become unsafe
- To ensure that the national laws, regulations and conditions for the operation of the product are respected
- To ensure that radio modems are not operated without the permission of the local authorities on frequencies and/or output power levels other than those specifically reserved and intended for use without a specific permit. The internal and external radio modems have been designed to operate on frequency ranges and output power ranges, the exact use of which differs from one region and/or country to another.
- This product must be installed on building and construction machinery only by an appropriately trained and qualified specialist.

1.5

Hazards of Use

DANGER

Risk of electrocution

Because of the risk of electrocution, it is dangerous to use poles, levelling staffs and extensions in the vicinity of electrical installations such as power cables or electrical railways.

Precautions:

- ▶ Keep at a safe distance from electrical installations. If it is essential to work in this environment, first contact the safety authorities responsible for the electrical installations and follow their instructions.



WARNING

Distraction/loss of attention

During dynamic applications, for example stakeout procedures, there is a danger of accidents occurring if the user does not pay attention to the environmental conditions around, for example obstacles, excavations or traffic.

Precautions:

- ▶ The person responsible for the product must make all users fully aware of the existing dangers.

WARNING

Inadequate securing of the working site

This can lead to dangerous situations, for example in traffic, on building sites and at industrial installations.

Precautions:

- ▶ Always ensure that the working site is adequately secured.
- ▶ Adhere to the regulations governing safety, accident prevention and road traffic.

CAUTION

Not properly secured accessories

If the accessories used with the product are not properly secured and the product is subjected to mechanical shock, for example blows or falling, the product may be damaged or people can sustain injury.

Precautions:

- ▶ When setting up the product, make sure that the accessories are correctly adapted, fitted, secured, and locked in position.
- ▶ Avoid subjecting the product to mechanical stress.

CAUTION

Dropping the product

Risk of personal injury and/or mechanical damage.

Precautions:

- ▶ Secure the CSX8 properly during operation.

NOTICE

Remote control of product

With the remote control of products, it is possible that extraneous targets will be picked out and measured.

Precautions:

- ▶ When measuring in remote control mode, always check your results for plausibility.

NOTICE

Improper shut down of the system

This could lead to a loss of essential system information.

Precautions:

- ▶ Always ensure proper shut down of the system. Do not force shut down of the system.
- ▶ Release the power switch as soon as the shut-down splash screen appears.

NOTICE

Removal of battery during operation or shutdown

This can result in a file system error and data loss!

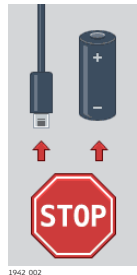

Precautions:

- ▶ Do **NOT** remove the battery during operation of the instrument, or during the shutdown procedure.
- ▶ Always switch off the instrument by pressing the On/Off key, and wait until the instrument has shutdown completely before removing the battery.

⚠ CAUTION

Keeping the device too close to the human body during operation

Health risk

Precautions:

- ▶ Use the device at least 10 mm apart from the human body.
- ▶ This device has been tested for typical operations near the human body, for example handheld mode, with the device kept at 10 mm from the user's body.

⚠ WARNING

Lightning strike

If the product is used with accessories, for example masts, staffs, poles, you may increase the risk of being struck by lightning.

Precautions:

- ▶ Do not use the product in a thunderstorm.

DANGER

Risk of being struck by lightning

If the product is used with accessories, for example on masts, staffs, poles, you may increase the risk of being struck by lightning. Danger from high voltages also exists near power lines. Lightning, voltage peaks, or the touching of power lines can cause damage, injury and death.

Precautions:

- ▶ Do not use the product in a thunderstorm as you can increase the risk of being struck by lightning.
- ▶ Be sure to remain at a safe distance from electrical installations. Do not use the product directly under or close to power lines. If it is essential to work in such an environment contact the safety authorities responsible for electrical installations and follow their instructions.
- ▶ If the product has to be permanently mounted in an exposed location, it is advisable to provide a lightning conductor system. A suggestion on how to design a lightning conductor for the product is given below. Always follow the regulations in force in your country regarding grounding antennas and masts. These installations must be carried out by an authorised specialist.
- ▶ To prevent damages due to indirect lightning strikes (voltage spikes) cables, for example for antenna, power source or modem should be protected with appropriate protection elements, like a lightning arrester. These installations must be carried out by an authorised specialist.
- ▶ If there is a risk of a thunderstorm, or if the equipment is to remain unused and unattended for a long period, protect your product additionally by unplugging all systems components and disconnecting all connecting cables and supply cables, for example, instrument - antenna.

WARNING

Inappropriate mechanical influences to batteries

During the transport, shipping or disposal of batteries it is possible for inappropriate mechanical influences to constitute a fire hazard.

Precautions:

- ▶ Before shipping the product or disposing it, discharge the batteries by the product until they are flat.
- ▶ When transporting or shipping batteries, the person in charge of the product must ensure that the applicable national and international rules and regulations are observed.
- ▶ Before transportation or shipping, contact your local passenger or freight transport company.

WARNING

Exposure of batteries to high mechanical stress, high ambient temperatures or immersion into fluids

This can cause leakage, fire or explosion of the batteries.

Precautions:

- ▶ Protect the batteries from mechanical influences and high ambient temperatures. Do not drop or immerse batteries into fluids.

⚠ WARNING

Short circuit of battery terminals

If battery terminals are short circuited e.g. by coming in contact with jewellery, keys, metallised paper or other metals, the battery can overheat and cause injury or fire, for example by storing or transporting in pockets.

Precautions:

- ▶ Make sure that the battery terminals do not come into contact with metallic/conductive objects.

⚠ WARNING

Electric shock due to use under wet and severe conditions

If unit becomes wet, it may cause you to receive an electric shock.

Precautions:

- ▶ If the product becomes humid, it must not be used!
- ▶ Use the product only in dry environments, for example in buildings or vehicles.



- ▶ Protect the product against humidity.



The following advice is only valid for battery charger and power adapter.

⚠ WARNING

Unauthorised opening of the product

Either of the following actions may cause you to receive an electric shock:

- Touching live components
- Using the product after incorrect attempts were made to carry out repairs

Precautions:

- ▶ Do not open the product!
- ▶ Only authorised Leica Geosystems Service Centres are entitled to repair these products.

⚠ WARNING

Damaged battery

If batteries are damaged or are heated strongly, they can explode and cause poisoning, burning, corrosion or environmental contamination.

Precautions:

- ▶ Protect the battery against mechanical damages.

⚠ WARNING

Damaged battery housing

There is a risk of fire. In case skin or eyes have come into direct contact with electrolytes leaking from the battery, rinse them thoroughly with clear water. Immediately contact a doctor.

Precautions:

- ▶ Stop using the battery.
- ▶ Turn off any charging in action.
- ▶ If any electrolytes should leak from a damaged battery, avoid skin contact and direct inhalation of gases.

⚠ WARNING

Improperly battery handling

Risk of fire, explosion or burn.

Precautions:

- ▶ Only replace battery with supported type.
- ▶ Prevent heating the battery above 70 °C.
- ▶ Never throw battery into fire.
- ▶ Do not disassemble, crush, or modify the battery.

⚠ WARNING

Improperly repaired equipment

Risk of injuries to users and equipment destruction due to lack of repair knowledge.

Precautions:

- ▶ Only authorised Leica Geosystems Service Centres are entitled to repair these products.

NOTICE

Rooting your Android device will void your right for any warranty services and support by Leica!

1.6

Electromagnetic Compatibility (EMC)

Description

The term Electromagnetic Compatibility is taken to mean the capability of the product to function smoothly in an environment where electromagnetic radiation and electrostatic discharges are present, and without causing electromagnetic disturbances to other equipment.

 **CAUTION**

Electromagnetic radiation

Electromagnetic radiation can cause disturbances in other equipment.

Precautions:

- ▶ Although the product meets the strict regulations and standards which are in force in this respect, Leica Geosystems cannot completely exclude the possibility that other equipment may be disturbed.

 **CAUTION**

Use of the product with accessories from other manufacturers. For example, field computers, personal computers or other electronic equipment, non-standard cables or external batteries

This may cause disturbances in other equipment.

Precautions:

- ▶ Use only the equipment and accessories recommended by Leica Geosystems.
- ▶ When combined with the product, other accessories must meet the strict requirements stipulated by the guidelines and standards.
- ▶ When using computers, two-way radios or other electronic equipment, pay attention to the information about electromagnetic compatibility provided by the manufacturer.

 **CAUTION**

Intense electromagnetic radiation. For example, near radio transmitters, transponders, two-way radios or diesel generators

Although the product meets the strict regulations and standards which are in force in this respect, Leica Geosystems cannot completely exclude the possibility that the function of the product may be disturbed in such an electromagnetic environment.

Precautions:

- ▶ Check the plausibility of results obtained under these conditions.

 **CAUTION**

Electromagnetic radiation due to improper connection of cables

If the product is operated with connecting cables, attached at only one of their two ends, the permitted level of electromagnetic radiation may be exceeded and the correct functioning of other products may be impaired. For example, external supply cables or interface cables.

Precautions:

- ▶ While the product is in use, connecting cables, for example product to external battery or product to computer, must be connected at both ends.

 **WARNING**

Use of product with radio or digital cellular phone devices

Electromagnetic fields can cause disturbances in other equipment, installations, medical devices, for example pacemakers or hearing aids, and aircrafts. Electromagnetic fields can also affect humans and animals.

Precautions:

- ▶ Although the product meets the strict regulations and standards which are in force in this respect, Leica Geosystems cannot completely exclude the possibility that other equipment can be disturbed or that humans or animals can be affected.
 - ▶ Do not operate the product with radio or digital cellular phone devices in the vicinity of filling stations or chemical installations, or in other areas where an explosion hazard exists.
 - ▶ Do not operate the product with radio or digital cellular phone devices near medical equipment.
 - ▶ Do not operate the product with radio or digital cellular phone devices in aircrafts.
 - ▶ Do not operate the product with radio or digital cellular phone devices for long periods with the product immediately next to your body.
-

2

Box Content

Container for CSX8 instrument and accessories



- a USB cable
- b USB charger
- c Country specific AC plugs
- d Hand strap

- e CSX8 Box
- f CSX8 Quick guide
- g GEB256 Battery
- h CSX8

3 Description of the System

3.1 Overview

System components



26662_001

3.2 Terminology

CSX8 general description CSX8 is a collective term describing the various models of the tablet.

3.3 System Concept

3.3.1 Power Concept

General Use the batteries, chargers and accessories recommended by Leica Geosystems to ensure the correct functionality of the instrument.

Power options

Power supply

Internally by GEB256 battery, OR

Externally by GEV295 power supply, OR

If an external power supply is connected and the internal battery is inserted, then the external power is used. The internal battery is charged.

Charging Modes

The main charging method for the tablet is by USB-C.

Alternatively, USB-A can also be used for charging but will be at a slower rate.

3.3.2 Data Storage Concept

Memory device

Device	Description
microSD card	All tablets have a microSD card slot fitted as standard. A microSD card can be inserted and removed. Available capacity: 256 GB.

Device	Description
USB stick	All tablets have an USB type A and type C port fitted as standard. Only 1 port can be used for USB-Data at a time. If a USB-Data device such as a USB Flash Drive is fitted into the USB-A port and also into the USB-C port, then USB-C will be prioritized.
Internal memory	All tablets have an internal memory fitted as standard. Available capacity: 256 GB.

 While other microSD cards can be used, Leica Geosystems recommends to only use Leica microSD cards and is not responsible for data loss or any other error that can occur while using a non-Leica card.



Removing the microSD card or USB stick while the tablet is turned on can cause loss of data. Only remove the microSD card or USB stick or unplug connecting cables when the tablet is switched off.

3.4

CSX8 Components

Upside

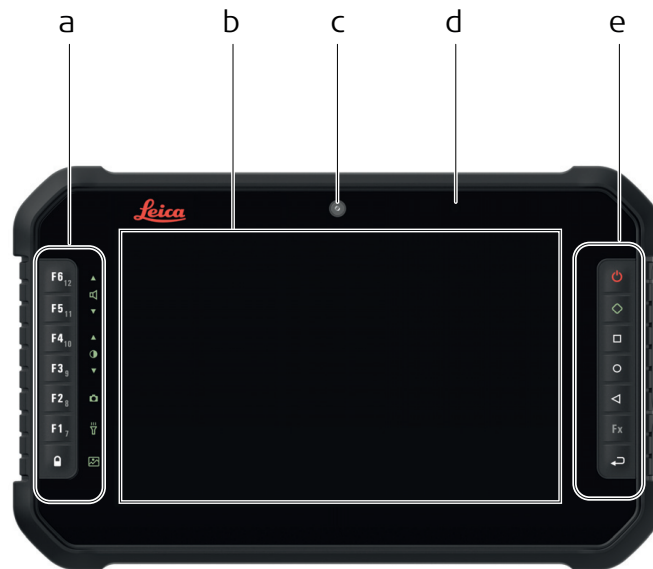

26664.001

- a Keypad: Function keys, System keys, Touch panel lock
- b Screen
- c Front camera
- d Light sensor
- e Keypad: Main keys

Side

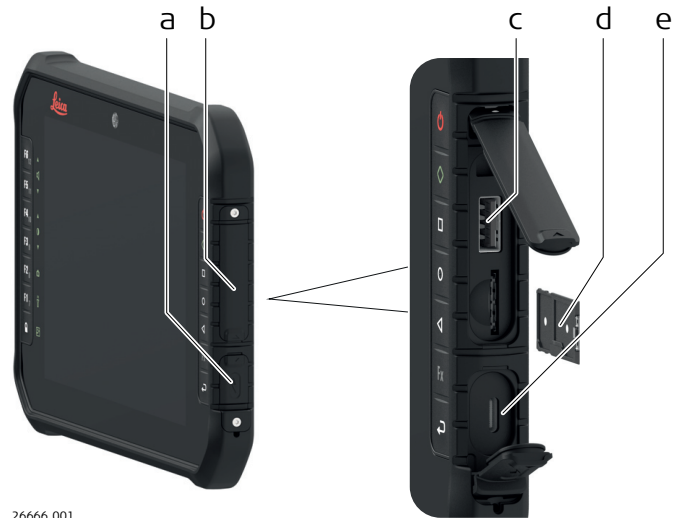

26666.001

- a Protection cap for USB-C port
- b Protection cap for USB-A port and microSD/SIM card slot
- c USB-A port
- d microSD/SIM card slot with card frame
- e USB-C port

Underside



26665.001

- a Microphone
- b Camera
- c LED flash
- d Battery cover
- e Battery cover lock (6 ×)
- f Battery
- g Speaker
- h Battery lock (2 ×)
- i Battery locking lever

3.5

Battery Charger

Components

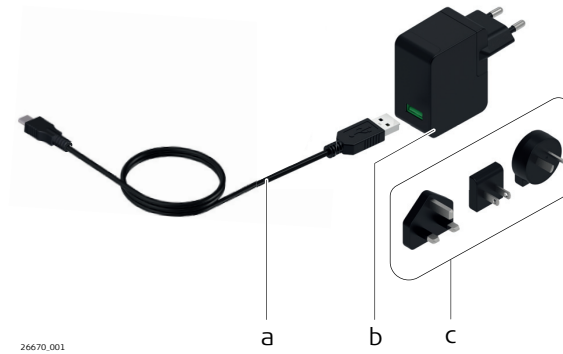

- a USB-C to USB-A cable
- b Power supply
- c Country specific AC plugs

4

First-time Use

General

Use this checklist to set up your new Android tablet.

Insert battery

Please refer to [6.2.1 Operating Principles](#) and [6.2.2 Changing the Battery](#) for further information.

Insert SIM card

The SIM card is a removable chip that stores identification information to access a specific mobile network. Typically, the SIM card is provided by the service provider.

For most Android users, a SIM card lets the tablet:

- Have internet services and other functions that rely on an internet connection, like features for specific apps and services.
- Receive Android OS updates when the tablet is not connected to Wi-Fi or a tethered device.
- Send or receive text messages.
- Synchronize or share data among others with the help of a cloud service.
- Keep applications up to date.

How to insert the SIM card.

 Many devices will automatically approve the carrier services after the SIM card is inserted. If the device shows an error message or if there are any issues with the SIM card or carrier services, please contact your service provider.

1. Find the SIM card.
2. Open the SIM tray on the device.
3. Place the SIM card in the SIM tray.
4. Put the SIM tray back into the device.

 Please refer to [6.4.1 Working with the microSD Card and Nano SIM Card](#) for further information.

Turning on the CSX8 step-by-step



 Place the CSX8 on a flat and stable surface or hold the device in your hand. Ensure that either the device is connected with the AC power adapter or the battery is charged up.

1. Press and hold Power key until the CSX8 boot screen appears.
2. When the lock screen is displayed, the CSX8 is ready to use. The operating system needs usually about 30 seconds for booting up.

Connect to Wi-Fi

Set the tablet to automatically turn on Wi-Fi and connect to a trusted network if needed. When Wi-Fi is turned on, the tablet connects to nearby networks

which have been connected to before. If Wi-Fi is turned off, the device can only connect to the internet through the mobile carrier.

Connect to the internet to get internet services and other functions like:

- Android OS updates, when the device is not connected to the mobile carrier's internet service or a tethered device.
- Features for specific apps and services that rely on an internet connection.

How to turn on and connect to Wi-Fi

 Some of these steps require to tap the screen.

1. Open the device's **Settings** app.

2. Tap **Network & internet** and then **Internet**.

3. Tap a listed network. Networks that require a password have a Lock.

 After connecting, the network is "Saved". When the tablet is near and Wi-Fi is on, the tablet automatically connects to this network.

Copy apps and data

To personalize your new device, copy apps, text messages, contacts, photos, and other info from your old device. Verify your Google Account during this process if needed.

To copy apps and data, backup and restore data on your old device first.

Tips:

- Copy apps and data may take several hours. Apps and data are not removed from the old device.
- Apps that are only available on iOS are not copied to the Android.
- If your transfer apps and data:
 - Wirelessly: The device must be connected to the internet the entire time.
 - With a cord: The device must be connected to the old device for the entire transfer process.
- If you don't copy your apps and data:
 - Download and install apps manually from the Play Store.
 - Text messages sent and received on the old device are not saved.
 - Manually add the saved contacts.
 - Photos are not transferred.

Add a Google Account

The Google Account enables to automatically sync photos, messages, email, and data with other devices that are signed in to with the Google Account.

Sign in to the Google Account to:

- Download apps, books, movies, and shows via Google Play.
- Set up backup and restore.
- Set up other Google apps and services like Gmail and Google Pay.

You can add multiple Google Accounts to your device.

 It is advised that if the device is used among multiple users or in rental situations to create an administrator account to avoid having a locked device in case passwords or pin codes are lost.

Create a screen lock

Set up a screen lock to help secure the Android device if needed.

Each time the device is switched on or the screen is woken up, a prompt appears to unlock the unit using a PIN, pattern or password. On some devices, it's possible to unlock with your fingerprint.

 Some of these steps require to tap the screen.

Set or change a screen lock

Important: To ensure the automatic and manual backups are encrypted with the screen lock, use a PIN, pattern, or a password.

- Open the tablet's **Settings** app.
- Tap **Security**.
- To pick a kind of screen lock, tap **Screen lock**.
If a lock is already set, enter the PIN, pattern, or password before picking a different lock.
- Tap the desired screen lock option. Follow the on-screen instructions.

Screen lock options

- No lock
 - **None:** The tablet stays unlocked. This gives no protection, but allows getting to the Home screen quickly.
 - **Swipe:** Swipe with a finger across the screen. This gives no protection, but allows getting to the Home screen quickly.
- Standard locks
 - **Pattern:** Draw a simple pattern with the finger.
 - **PIN:** Enter 4 or more numbers. Longer PINs tend to be more secure.
 - **Password:** Enter 4 or more letters or numbers. A strong password is the most secure screen lock option.

Add the tablet manufacturer or carrier account

Some carriers offer specific apps and services to users who are signed in to their carrier account. For more info, get help from your service provider.







5 User Interface

5.1 Keyboard

Main keys



25644_001

Key	Function
	Touch Panel Lock
	Power
	ALT key
	Android Overview
	Android Home
	Android Back
Fx	2nd Function
	Enter key

Function keys



Key	Key Combination
F6	F6₁₂ (Fx + F6 = F12)
F5	F5₁₁ (Fx + F5 = F11)
F4	F4₁₀ (Fx + F4 = F10)
F3	F3₉ (Fx + F3 = F9)
F2	F2₈ (Fx + F2 = F8)
F1	F1₇ (Fx + F1 = F7)

Usability

Quick Links	While being in the HOME screen, the function keys can be linked to applications for quick access. Go to Settings - System - Key map to define which application should be linked to each individual key.
Application	When an application is open, the function keys work the same way as you would normally press the F1 to F12 keys on a physical keyboard. The functionality for each key will depend on the implementation of those keys within the application.
Webbrowser	Most web-browsers on an Android platform have some support for function keys. The most common function keys that are supported are: <ul style="list-style-type: none">• F3: Search for text on page• F5: Refresh Page

System keys



25451_001

Icon	Key Combination	Description
	◇ + F6	Volume Up
	◇ + F5	Volume Down
	◇ + F4	Brightness Up
	◇ + F3	Brightness Down
	◇ + F2	Camera
	◇ + F1	Flashlight/Torch
	◇ +	Screenshot

5.2

Operating Principles

Turning on the CSX8 step-by-step



Place the CSX8 on a flat and stable surface or hold the device in your hand.

Ensure that either the device is connected with the AC power adapter or the battery is charged up.

1. Press and hold Power key until the CSX8 boot screen appears.
2. When the lock screen is displayed, the CSX8 is ready to use. The operating system needs usually about 30 seconds for booting up.

Turning off the CSX8 step-by-step

1. Press the Power key for at least 1 second to open the Power off menu.
Within the menu, the following options are available:
 - **Power off:** The operating system shuts down and the CSX8 is turned off.
 - **Restart:** The operating systems shuts down and will restart the system again.
 - **Emergency mode:** Make an emergency call.

2. To turn off the device, select the option **Power off**.



After turning off the CSX8, wait for at least 5 seconds before turning on the device again.

Resetting the CSX8 step-by-step

If the CSX8 stops responding and does not respond when you press any key, it is necessary to start a hard reset. To start a hard reset, do the following:

1. Press and hold the Power key for 14 seconds to switch off the CSX8.
2. After turning off the CSX8, wait for at least 5 seconds before turning on the device again.
3. Press and hold the Power key for 14 seconds to switch on the CSX8 again.

Standby mode activation step-by-step

To activate the standby mode of CSX8 do the following:



The CSX8 must be switched on.

1. Press the Power key.
The CSX8 enters the sleep mode.
2. Press the Power key again to resume operation.
3. Swipe upwards on the screen to unlock the CSX8.



Any incoming call ends the standby mode.



If the CSX8 has been idle for a time, the screen automatically turns off and goes into standby mode.

Working with the touchscreen

Action	Description
Tap	Touch the screen once to open items and select options.
Select and hold	Select and hold an item. <i>A pop up menu with a list of available sub-folders or options opens.</i> Tap the subfolder you want to open or the action you want to perform.
Flick	Flick the stylus or finger to scroll a page or a list up and down.

5.3

System Main Interface

Home screen

The home screen with multiple panels is the starting place for accessing all functionalities of the CSX8.

Access

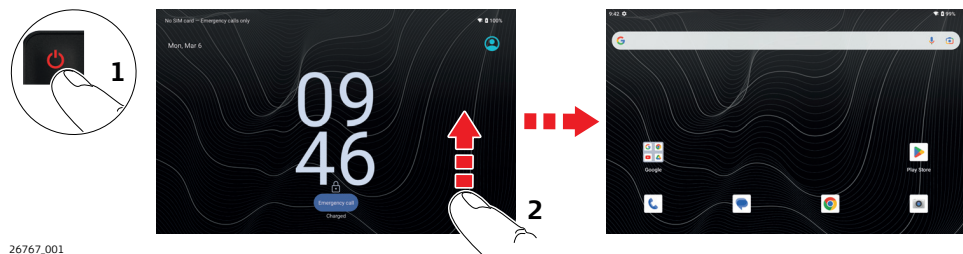

1. Turn on the CSX8. Refer to [5.2 Operating Principles](#).
The boot screen appears.

2. Slide the screen upward to unlock and access the home screen.



If the touch screen does not respond to swiping from bottom to top, then please verify that the LOCK SCREEN functionality is not active by pressing the LOCK button.

Areas of the home screen

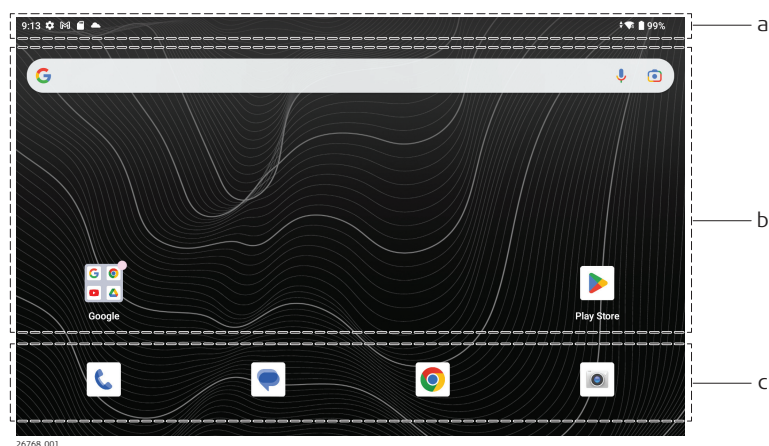

- a Status bar
- b Display area
- c Shortcut panel

Using the notification panel

Action	Description
Open the notification panel	When new notification icons appear in the notification area of the status bar, hold the status bar and drag down to open the notification panel.
Hide the notification panel	Drag the bottom border of the panel upwards to hide the panel again.

Customise the shortcut panel

Action	Description
Remove a shortcut icon	Tap and hold the shortcut icon and drag it to the top of the screen to remove
Add a shortcut icon	Tap and hold the icon on the home screen and drag it to the shortcut panel.

Expanding the home screen

Action	Description
View the multiple panels of the home screen	Swipe left or right on the screen to view the multiple panels with all the included applications.
Return to the home screen	Press the Home screen key to close it and return to the home screen.







Icons and directories on the home screen

Action	Description
Add an icon	Tap and hold the icon and drag it to an empty area on the home screen.
Move an icon	Tap and hold the icon on the home screen and drag the icon to the desired location on the home screen.
Remove an icon	Tap and hold the icon on the home screen and drag the icon to the top of the screen to remove.
Create and open a directory	To create a directory, drag an icon onto another icon. Tap the new directory to open it.
Rename a directory	Tap the label of the directory to rename it.



Status icons

The icons within the status bar indicate the current status of the main system functions.





Battery status icons





Icon	Description
	Battery has full charge: 100%
	Battery has high charge: 80%
	Battery has medium charge: 50%
	Battery has low charge: 20%
	Battery has less than 15% charge.
	Connected to AC. Battery is charging.

Speaker status icons

Icon	Description
	Volume on.
	Volume off.
	Volume mute.

Network and modem status icons

Icon	Description
	Bluetooth connected.
	Bluetooth disabled.
	Bluetooth searching.
	Wi-Fi radio on.

Icon	Description
	Wi-Fi radio off.
	Maximum signal strength of cellular modem.
	Cellular modem OFF.
	No cellular service available.
	No SIM card.

Application screen

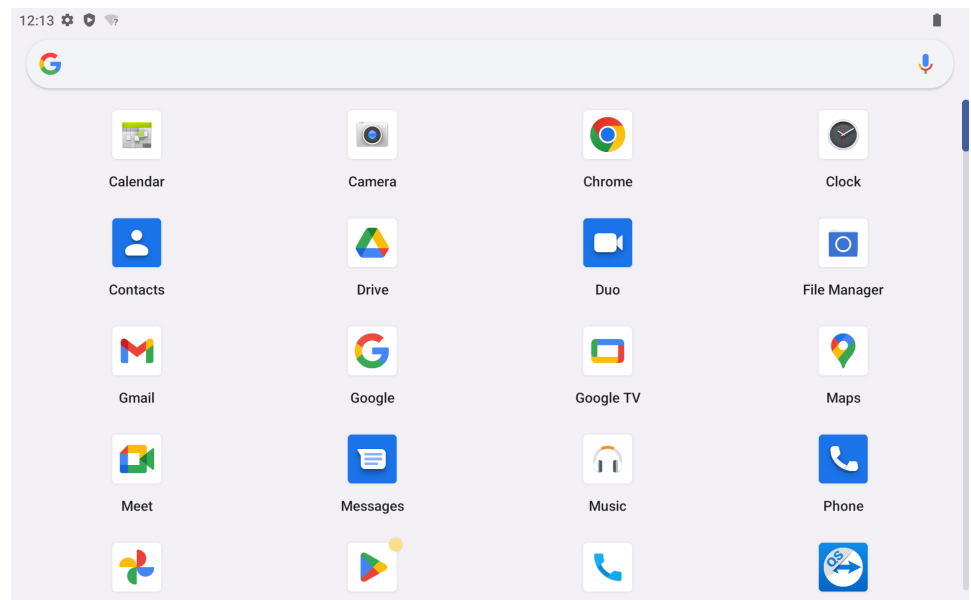

The appearance of the application screen depends on the installed applications and is subject to change.

Access

1. Swipe up from the bottom of the screen to the application screen.
2. Tap and hold a program icon to open an application-related menu.

6 Operation

6.1 Equipment Setup

6.1.1 Fixing the Tablet to a Holder and Pole

Components of the GHT87 holder

The GHT87 holder consists of the following components:

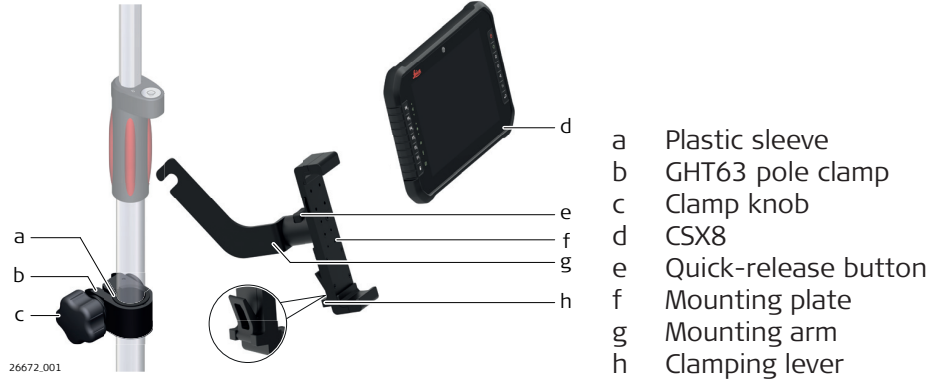

Rubbers for use with GHT87 holder

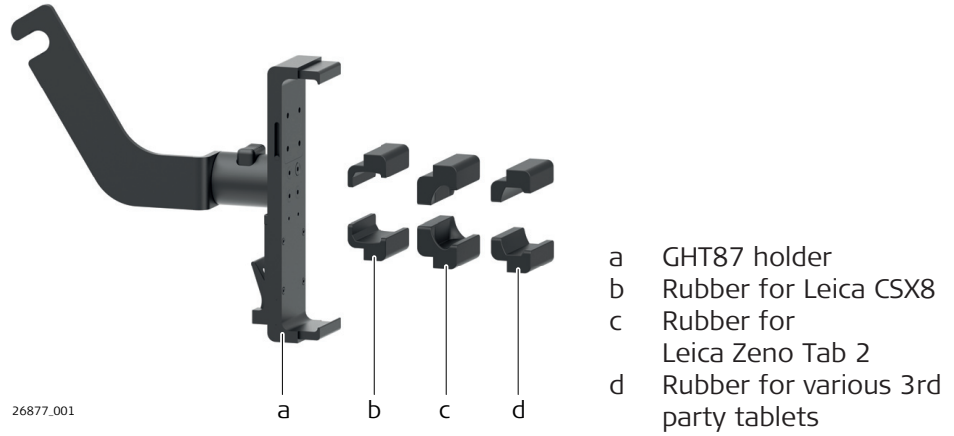

How to attach the rubbers step-by-step

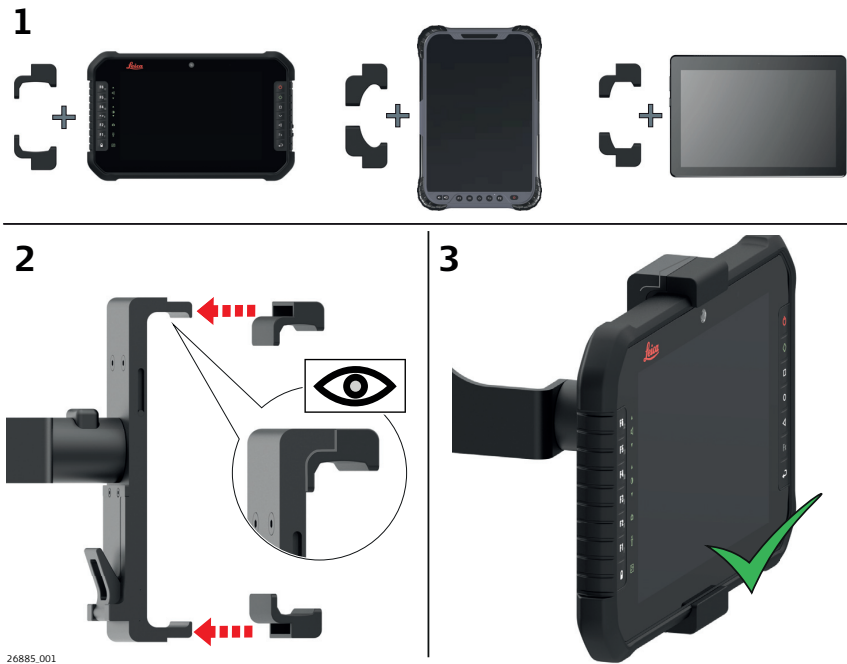

Attach the correct rubber to the GHT87 holder before use.

1. Choose the correct rubber.

2. Attach the rubbers.

Make sure that the rubbers are correctly attached to ensure that the tablet can not fall off.

3. Tablet correctly attached.

Fixing the tablet to a pole step-by-step

For an aluminium pole, fit the plastic sleeve to the pole clamp.

1. Insert the pole into the clamp hole.

2. Attach the holder to the clamp using the clamp knob.

3. Adjust the angle and the height of the holder on the pole to a comfortable position.

4. Tighten the clamp with the clamp knob.

5. Hold the CSX8 tablet above the holder and lower the end of the CSX8 tablet into the mounting plate.

6. Apply slight pressure in a downward direction and then lower the top part of the CSX8 tablet until the unit is clicked into the holder. Tighten the holder with the clamping lever at the bottom of the unit.

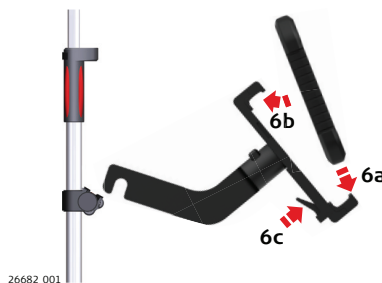

Detaching the tablet from a pole step-by-step

1. Release the clamping lever.
2. Place your palm over the bottom of the tablet.
3. While in this position, lift the bottom of the tablet from the holder.

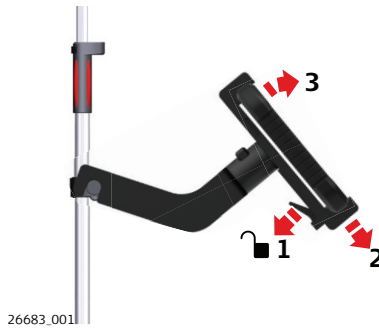

6.1.2

Replacing the Display Foil on the CSX8



On delivery, the display of the CSX8 is covered by a foil to protect the display against scratches and dirt and to guarantee a trouble-free function of the touchscreen in extreme and humid weather conditions. We strongly recommend to use this display foil and to replace it with a SPF11 screen protection foil for CSX8, if necessary.

Preparation

- Remove the old display foil.
- Ensure that the display is free of dust and grease.
- Use the provided microfibre cloth to clean the display.
- Look for a dust free and dry atmosphere surrounding while fixing the display foil. The recommended conditions are:
Temperature: approx. 21°C
Humidity: < 55%

Fixing the display foil step-by-step

The display foil lies between two thin carrier foils. The display foil has a silver-coloured sticker to peel away the carrier foil from the actual display foil.

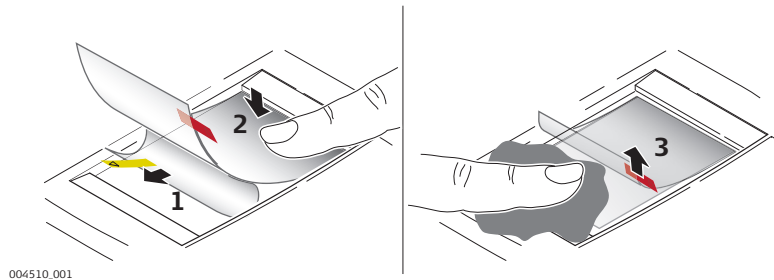

1. Touch the yellow-coloured sticker with two fingers and pull it slowly upwards. The carrier foil is peeling away.
 Do not peel the carrier foil more than 2 cm - 3 cm away.
2. Fix the adhesive underside of the display foil on the display edge. Peel away the carrier foil slowly and smooth it out gently onto the display.
3. Remove the additional layer foil which has a red-coloured sticker.

4. Potential air bubbles between display and display foil have to be smoothed out using the included microfibre cloth.

 Do not use sharp objects!

5. In case of remaining dust or grease under the display foil or the need to replace the display foil, lift it again with some adhesive tape.

6.2

Batteries

6.2.1

Operating Principles

First-time use/ charging batteries

- The battery must be charged before using it the first time, because it is delivered with an energy content as low as possible or might be in sleep mode.
- The permissible temperature range for charging is from 0 °C to +40 °C/ +32 °F to +104 °F. For optimal charging, we recommend charging the batteries at a low ambient temperature of +10 °C to +20 °C/+50 °F to +68 °F if possible
- It is normal for the battery to become warm during charging. Using the chargers recommended by Leica Geosystems, it is not possible to charge the battery once the temperature is too high

Operation/discharging

- The batteries can be operated from -20 °C to +55 °C/-4 °F to +131 °F.
 - Low operating temperatures reduce the capacity that can be drawn; high operating temperatures reduce the service life of the battery.
-