



RADIO REPORT FCC 47 CFR Part 15C ISED Canada RSS-247 Frequency hopping systems operating within the 2400 – 2483.5 MHz band	
Report Reference No	G0M-1812-7889-TFC247BT-V02
Testing Laboratory	Eurofins Product Service GmbH
Address	Storkower Str. 38c 15526 Reichenwalde Germany
Accreditation	 <p>A2LA Accredited Testing Laboratory, Certificate No.: 1983.01 FCC Test Firm Designation Number: DE0008 ISED Testing Laboratory site: 3470A-2</p>
Applicant	Leica Geosystems AG
Address	Heinrich Wild Strasse 9435 Heerbrugg SWITZERLAND
Test Specification	According to FCC/ISED rules
Standard	47 CFR Part 15C RSS-247, Issue 2, 2017-02 RSS-Gen, Issue 5, 2018-04
Non-Standard Test Method	None
Equipment under Test (EUT):	
Product Description	Field Controller Win EC7
Model(s)	CS20
Additional Model(s)	None
Brand Name(s)	Leica Geosystems
Hardware Version(s)	V1.00
Software Version(s)	V4.97
FCC-ID	RFD-CSNGV
IC	3177A-CSNGV
Test Result	PASSED

Possible test case verdicts:		
required by standard but not tested	N/T	
not required by standard	N/R	
not applicable to EUT	N/A	
test object does meet the requirement	P(PASS)	
test object does not meet the requirement	F(FAIL)	
Testing:		
Test Lab Temperature	20 - 23 °C	
Test Lab Humidity	32 – 38 %	
Date of receipt of test item	2019-01-07	
Report:		
Compiled by	Wilfried Treffke	
Tested by (+ signature) (Responsible for Test)	Wilfried Treffke	
Approved by (+ signature) (Head of Lab)	Christian Weber	
Date of Issue	2019-05-17	
Total number of pages	72	
General Remarks:		
<p>The test results presented in this report relate only to the object tested.</p> <p>The results contained in this report reflect the results for this particular model and serial number. It is the responsibility of the manufacturer to ensure that all production models meet the intent of the requirements detailed within this report.</p> <p>This report shall not be reproduced, except in full, without the written approval of the Issuing testing laboratory.</p>		
Additional Comments:		
<p>The EUT can operate with different power requirements. (120V AC/DC adaptor and 11.1V DC Li- battery)</p> <p>Test mode selection is based on comparative tests. The 120V AC power port was selected for compliance tests.</p>		

VERSION HISTORY

Version History			
Version	Issue Date	Remarks	Revised By
01	2019-03-15	Initial Release	
02	2019-05-17	Page 1 and 6: Brand Name corrected Page 9: Picture of Bluetooth Module corrected.	W. Treffke

ABBREVIATIONS AND ACRONYMS

Acronyms	
Acronym	Description
BR	Bluetooth Basic Rate mode
EDR	Bluetooth Enhanced Data Rate mode
EUT	Equipment Under Test
FCC	Federal Communications Commission
ISED	Innovation, Science and Economic Development Canada
RBW	Resolution bandwidth
RMS	Root mean square
VBW	Video bandwidth
V _{NOM}	Nominal supply voltage

REPORT INDEX

1	Equipment (Test Item) Under Test.....	6
1.1	Photos – Equipment External.....	7
1.2	Photos – Equipment Internal.....	9
1.3	Photos – Test Setup.....	12
1.4	Support Equipment.....	13
1.5	Test Modes	14
1.6	Test Frequencies.....	15
1.7	Sample emission level calculation.....	16
2	Result Summary.....	17
3	Test Conditions and Results.....	18
3.1	Test Conditions and Results - Occupied bandwidth.....	18
3.2	Test Conditions and Results - AC powerline conducted emissions.....	21
3.3	Test Conditions and Results - Transmitter radiated emissions	24
3.4	Test Conditions and Results - Receiver radiated emissions	28
ANNEX A	Transmitter spurious emissions	31
ANNEX B	Receiver spurious emissions	63

1 Equipment (Test Item) Under Test

Description	Field Controller Win EC7	
Model	CS20	
Additional Model(s)	None	
Brand Name(s)	Leica Geosystems	
Serial Number(s)	2400557	
Hardware Version(s)	V1.00	
Software Version(s)	V4.97	
PMN	CS20	
HVIN	CS20	
FVIN	-/-	
HMN	-/-	
FCC-ID	RFD-CSNGV	
IC	3177A-CSNGV	
Equipment type	End Product	
Radio type	Transceiver	
Assigned frequency bands	2400 - 2483.5 MHz	
Radio technology	Bluetooth	
Modulation	GFSK, PI/4-DQPSK, 8-DPSK	
Number of antenna ports	1	
Radio Module	Type	Integrated Transceiver Modules for WLAN 802.11 b/g/n, Bluetooth, Bluetooth Low Energy (BLE)
	Model	TIWI-BLE
	Manufacturer	Laird Technologies (LSR)
	HW Version	unspecified
	SW Version	unspecified
	FCC-ID	RFD-BTWCO
	IC	3177A-BTWCO
Antenna	Type	Integrated
	Model	W3008C
	Manufacturer	Pulse Electronics
	Gain	1 dBi (manufacturer declaration)
Supply Voltage 1	V_{NOM}	120 VAC (adaptor)
Supply Voltage 2	V_{NOM}	11.1 VAC (Lithium Battery)
Operating Temperature	T_{NOM}	25 °C
AC/DC-Adaptor	Model	GEV276
	Vendor	Leica Geosystems
	Input	100 – 240; 50 / 60 Hz
	Output	15 VDC
Manufacturer	Leica Geosystems AG Heinrich Wild Strasse 9435 Heerbrugg SWITZERLAND	

1.1 Photos – Equipment External

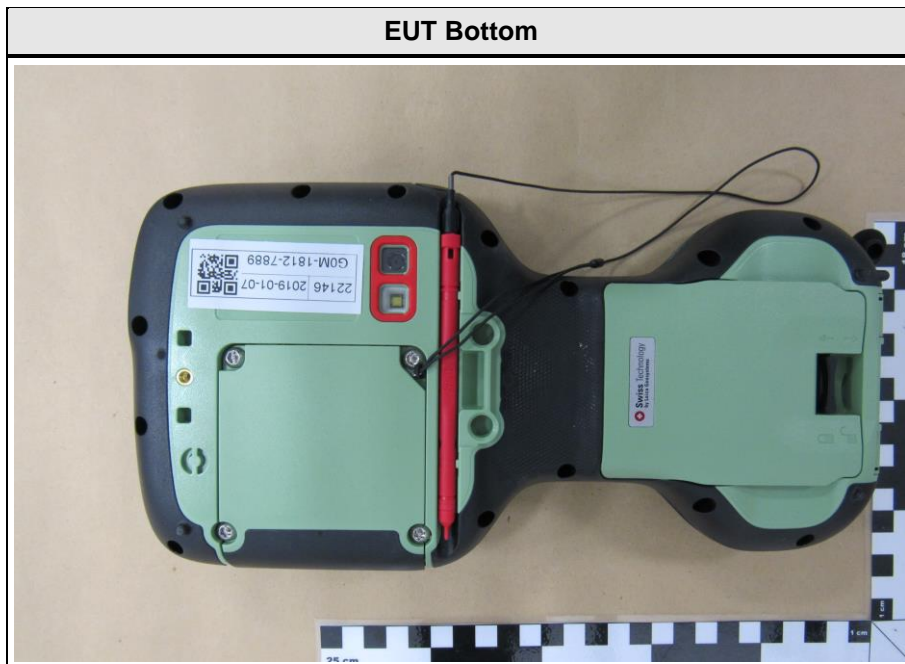

1.2 Photos – Equipment Internal

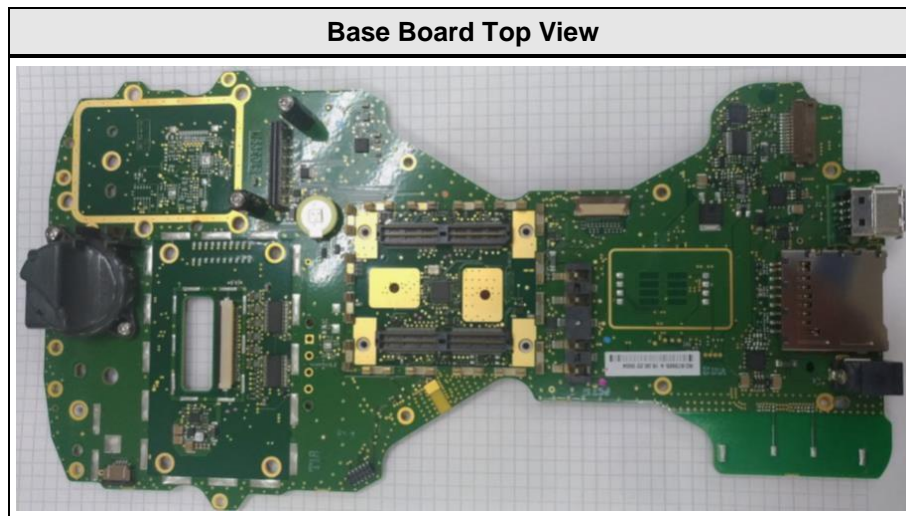

Core Module Top View

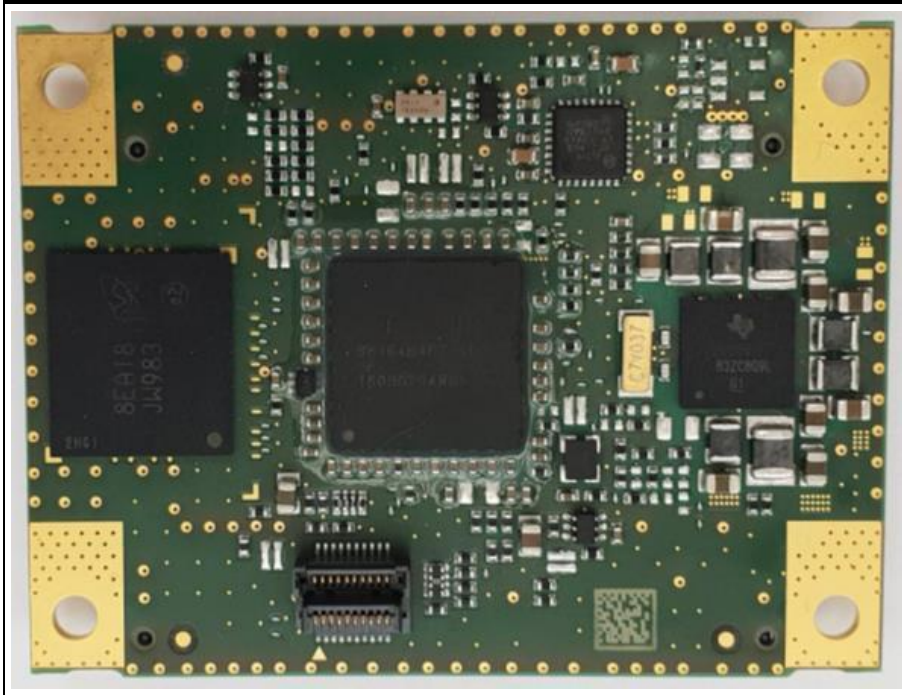

Core Module Bottom View

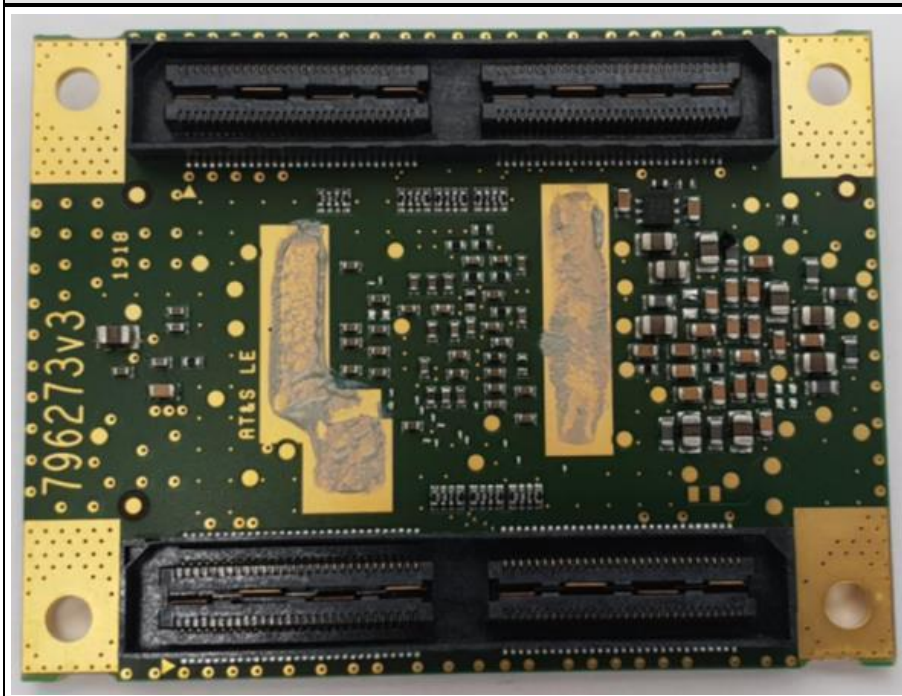

Camera Board Top View

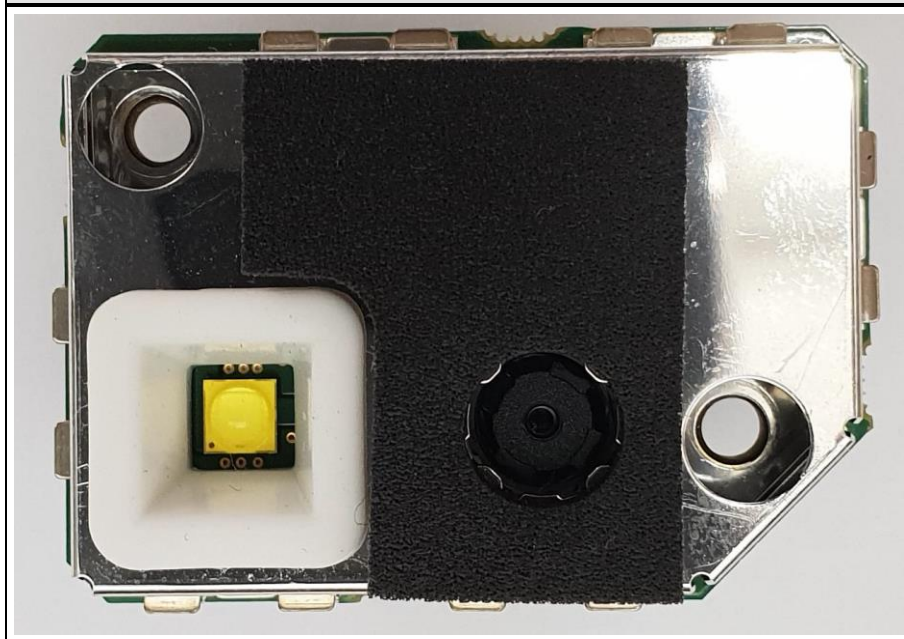

Camera Board Bottom View

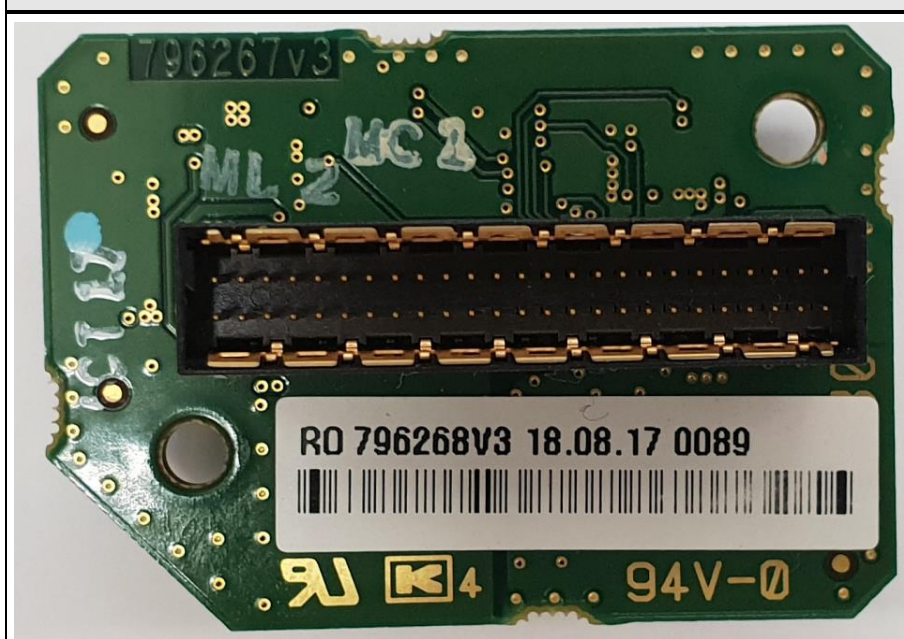

1.3 Photos – Test Setup

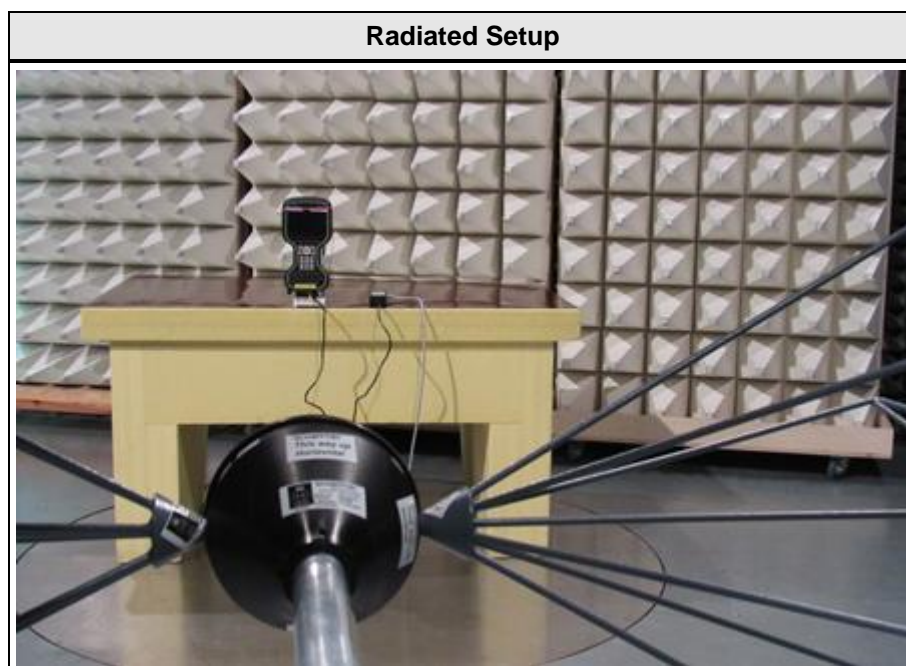
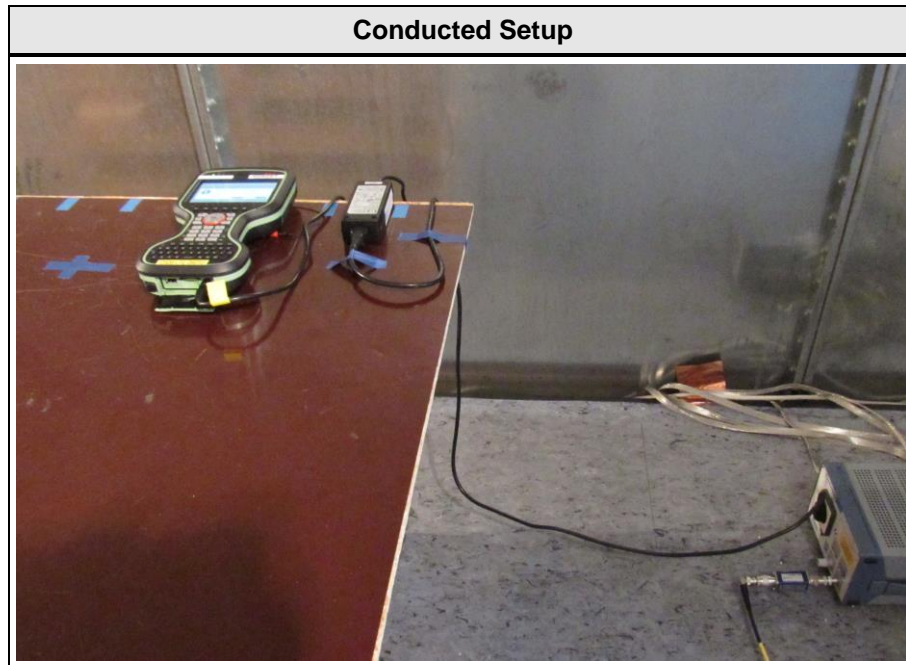

1.4 Support Equipment

Product Type	Device	Manufacturer	Model	Comment
SIM	Communication Tester	R&S	CBT	Signalling
AE	Laptop	Dell	Latitude E6420	S/N HPJ4R1
Description:				
AE	Auxiliary Equipment			
SIM	Simulator			
CBL	Connecting Cable			
Comment:				

1.5 Test Modes

Mode	Description
DH5 Single	Mode = Transmit Modulation = GFSK Spreading = None Packet type = DH5 Duty cycle = 78%
2-DH5 Single	Mode = Transmit Modulation = PI/4-DQPSK Spreading = None Packet type = 2-DH5 Duty cycle = 78%
3-DH5 Single	Mode = Transmit Modulation = 8-DPSK Spreading = None Packet type = 3-DH5 Duty cycle = 78%
Receive	Mode = scan mode
Comment:	

1.6 Test Frequencies

Designator	Mode	Channel	Frequency [MHz]
F1	Tx / Rx	0	2402
F2	Tx / Rx	39	2441
F3	Tx / Rx	78	2480

1.7 Sample emission level calculation

The following is a description of terms and a sample calculation, as appears in the radiated emissions data table. The numbers used in the calculation are for example only. There is no direct correlation to the specific data taken for the product described in this document:

Reading:

This is the reading obtained on the spectrum analyzer in dBµV. Any external preamplifiers used are taken into account through internal analyzer settings.

A.F.:

This is the antenna factor for the receiving antenna. It is a conversion factor, which converts electric fields strengths to voltages, which can be measured directly on the spectrum analyzer. It is treated as a loss in dB. Cable losses have been included with the A.F. to simplify the calculations. The antenna factor is used in calculations as follows:

$$\text{Reading on Analyzer (dB}\mu\text{V)} + \text{A.F. (dB/m)} = \text{Net field strength (dB}\mu\text{V/m)}$$

Net:

This is the net field strength measurement (as shown above).

Limit:

This is the FCC Class B radiated emission limit (in units of dBµV/m). The FCC limits are given in units of µV/m. The following formula is used to convert the units of µV/m to dBµV/m:

$$\text{Limit (dB}\mu\text{V/m)} = 20 \cdot \log(\mu\text{V/m})$$

Margin:

This is the margin of compliance below the FCC limit. The units are given in dB. A negative margin indicates the emission was below the limit. A positive margin indicates that the emission exceeds the limit.

Example only:

Reading + AF	=	Net Reading	:	Net reading - FCC limit	=	Margin
+21.5 dBµV + 26 dB/m		= 47.5 dBµV/m		47.5 dBµV/m - 57.0 dBµV/m		= -9.5 dB

2 Result Summary

FCC 47 CFR Part 15C, ISED RSS-247				
Product Standard Reference	Requirement	Reference Method	Result	Remarks
ISED RSS-Gen, Issue 5 (section 6.6)	Occupied Bandwidth	ANSI C63.10-2013	N/R	Informational only
FCC § 15.247(a)(1) ISED RSS-247 § 5.1 Issue 2	20 dB Bandwidth	ANSI C63.10-2013	N/T	
FCC § 15.247(a)(1)(iii) ISED RSS-247, Issue 2 (section 5.1)	Number of hopping frequencies	ANSI C63.10-2013	N/T	
FCC § 15.247(a)(1) ISED RSS-247, Issue 2 (section 5.1)	Frequency hopping channel separation	ANSI C63.10-2013	N/T	
FCC § 15.247(a)(1)(iii) ISED RSS-247, Issue 2 (section 5.1)	Time of occupancy (Dwell time)	ANSI C63.10-2013	N/T	
FCC § 15.247(b)(1) ISED RSS-247, Issue 2 (section 5.4)	Maximum peak conducted power	ANSI C63.10-2013	N/T	
FCC § 15.207 ISED RSS-247, Issue 2 (section 3.1)	AC power line conducted emissions	ANSI C63.10-2013	PASS	
FCC § 15.247(d) ISED RSS-247, Issue 2 (section 5.5)	Band edge compliance	ANSI C63.10-2013	N/T	
FCC § 15.247(d) ISED RSS-247, Issue 2 (section 5.5)	Conducted spurious emissions	ANSI C63.10-2013	N/T	
FCC § 15.247(d) FCC § 15.209 ISED RSS-Gen, Issue 5 (section 6.13)	Transmitter radiated spurious emissions	ANSI C63.10-2013	PASS	
ISED RSS-247, Issue 2 (section 3.1)	Receiver radiated spurious emissions	ANSI C63.10-2013	PASS	
Comment:				

Possible Test Case Verdicts	
PASS	Test object does meet the requirements
FAIL	Test object does not meet the requirements
N/T	Required by standard but not tested
N/R	Not required by standard for the test object

3 Test Conditions and Results

3.1 Test Conditions and Results - Occupied bandwidth

3.1.1 Information

Test Information	
Reference	ISED RSS-Gen, Issue 5 (section 6.6)
Measurement Method	ANSI C63.10 6.9.3
Operator	Wilfried Treffke
Date	2019-02-07

3.1.2 Limits

Limits
None (Informational only)

3.1.3 Setup

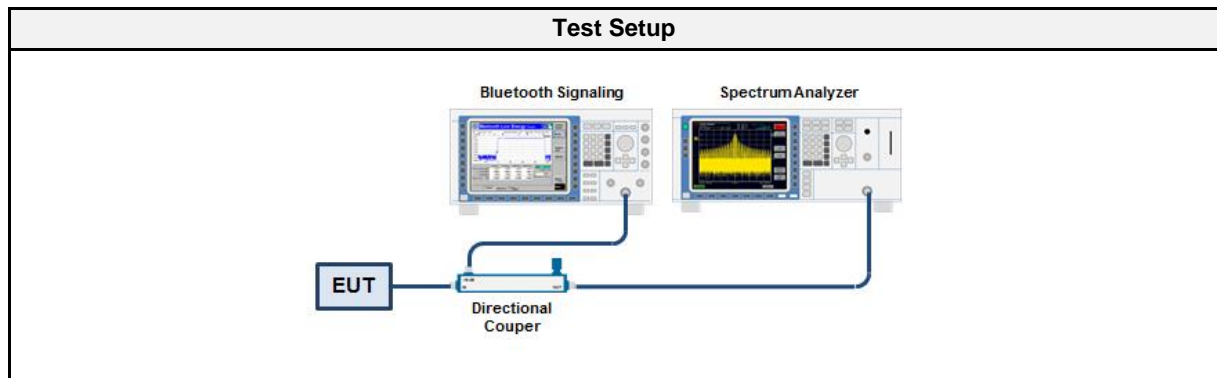

3.1.4 Equipment

Test Equipment					
Description	Manufacturer	Model	Identifier	Cal. Date	Cal. Due
Spectrum Analyzer	R&S	FSU 26	EF01407	2018-12	2019-12

3.1.5 Procedure

Test Procedure
<ol style="list-style-type: none"> 1. EUT transmitter is activated in test mode under normal conditions 2. The spectrum analyzer is set to peak detection and maximum hold with a span twice the emission spectrum 3. The resolution bandwidth is set to the range of 1 % to 5 % of the occupied bandwidth 4. The occupied bandwidth is measured with the build-in analyzer function

3.1.6 Results

Test Results		
Mode	Frequency [MHz]	Bandwidth [MHz]
3-DH5	2441	1.200
Comment	worst case	

Occupied Bandwidth

Project Number: G0M-1812-7889
 Applicant: Leica Geosystems AG
 Model Description: Field Controller Win EC7
 Model: CS20
 Test Sample ID: 22146
 Reference Standards: FCC 15.247, RSS-247
 Reference Method: ANSI C63.10:2013, Section 6.9.3
 Operational Mode: 3-DH5, Channel: 39, 2441 MHz
 Operating Conditions: Tnom/Vnom
 Operator: Wilfried Treffke
 Test Site: Eurofins Product Service GmbH
 Test Date: 2019-02-07
 Occupied Bandwidth [MHz]: 1.200

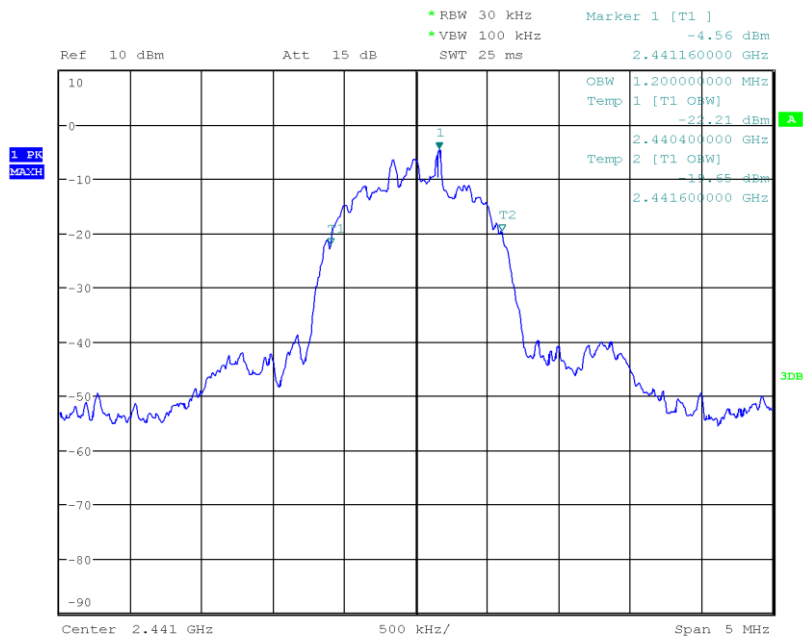

Date: 7.FEB.2019 14:02:14

3.2 Test Conditions and Results - AC powerline conducted emissions

3.2.1 Information

Test Information	
Reference	FCC § 15.207; ISED RSS-247, Issue 2 (section 3.1)
Measurement Method	ANSI C63.10 6.2
Operator	Wilfried Treffke
Date	2019-02-08

3.2.2 Limits

Limits		
Frequency [MHz]	Quasi-Peak [dBµV]	Average [dBµV]
0.15 - 0.5	66 - 56*	56 - 46*
0.5 - 5	56	46
5 - 30	60	50

* Limit decreases linearly with the logarithm of the frequency

3.2.3 Setup

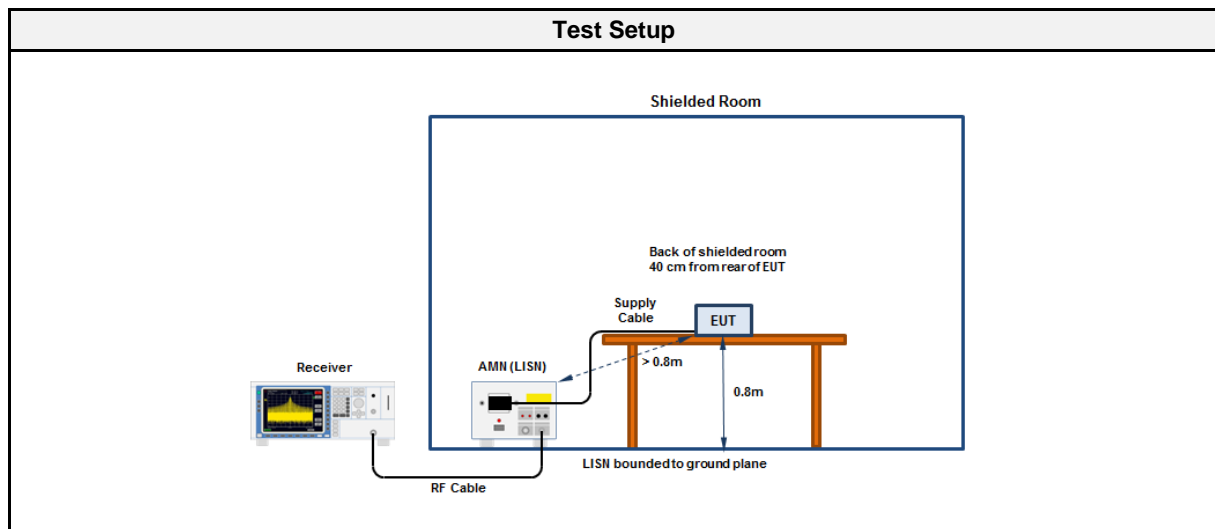

3.2.4 Equipment

Test Software			
Description	Manufacturer	Name	Version
EMC Software	DARE Instruments	RadiMation	2016.1.10

Test Equipment					
Description	Manufacturer	Model	Identifier	Cal. Date	Cal. Due
EMI Test Receiver	R&S	ESR7	EF00943	2018-07	2019-07
LISN	R&S	ESH3-Z5	EF00036	2017-01	2019-07

EMI voltage test in the ac-mains according to FCC part 15B

Project number: G0M-1812-7889

Applicant: Leica Geosystems AG
 EUT Name: Field Controller Win EC7
 Model: CS20
 Test Site: Eurofins Product Service GmbH
 Operator: Mr. Treffke
 Test Conditions: Tnom: 24°C, Unom: 120 VAC / 60Hz
 LISN: ESH3-Z5 (N)
 Mode: Tx, BT, 2441 MHz
 Test Date: 2019-02-08
 Note:

Index 1

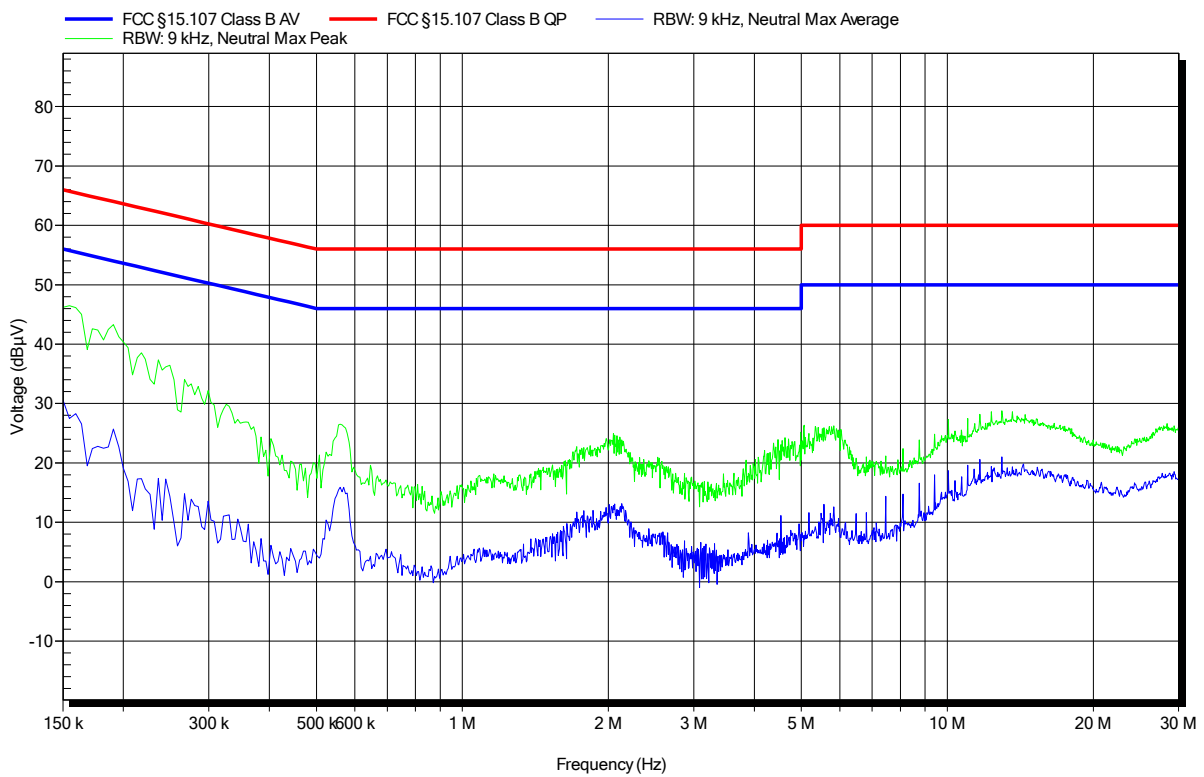

EMI voltage test in the ac-mains according to FCC part 15B

Project number: G0M-1812-7889

Applicant: Leica Geosystems AG
 EUT Name: Field Controller Win EC7
 Model: CS20
 Test Site: Eurofins Product Service GmbH
 Operator: Mr. Treffke
 Test Conditions: Tnom: 24°C, Unom: 120 VAC / 60Hz
 LISN: ESH3-Z5 (L)
 Mode: Tx, BT, 2441 MHz
 Test Date: 2019-02-08
 Note:

Index 2

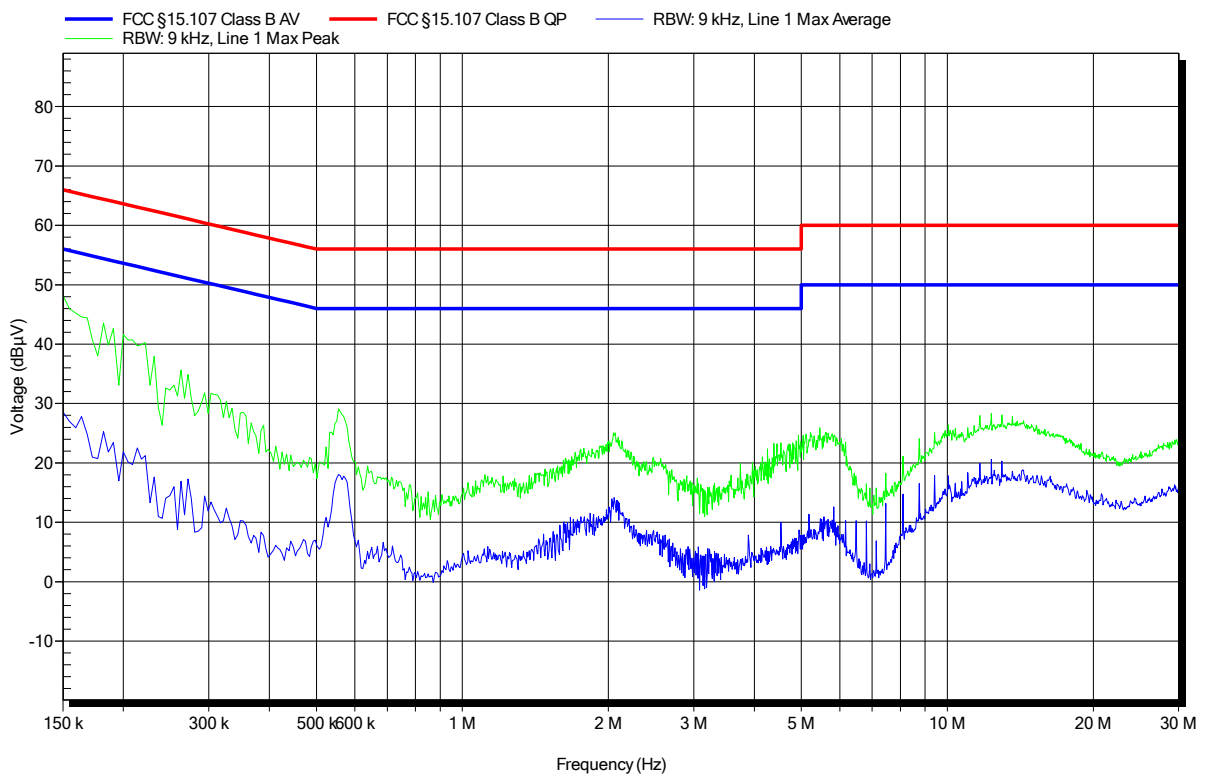

3.3 Test Conditions and Results - Transmitter radiated emissions

3.3.1 Information

Test Information	
Reference	FCC § 15.247(d); FCC § 15.209; ISED RSS-Gen, Issue 5 (section 6.13)
Measurement Method	ANSI C63.10 6.4, 6.5, 6.6
Operator	Wilfried Treffke
Date	2019-02-06

3.3.2 Limits

Limits			
Frequency [MHz]	Detector	Field strength [$\mu\text{V}/\text{m}$]	Measurement distance [m]
0.009 - 0.09	Average	2400/F[kHz]	300
0.09 - 0.110	Quasi-Peak	2400/F[kHz]	300
0.110 - 0.490	Average	2400/F[kHz]	300
0.490 - 1.705	Quasi-Peak	24000/F[kHz]	30
1.705 - 30.0	Quasi-Peak	30	30
30 - 88	Quasi-Peak	100	3
88 - 216	Quasi-Peak	150	3
216 - 960	Quasi-Peak	200	3
960 - 1000	Quasi-Peak	500	3
>1000	Average	500	3

3.3.3 Setup

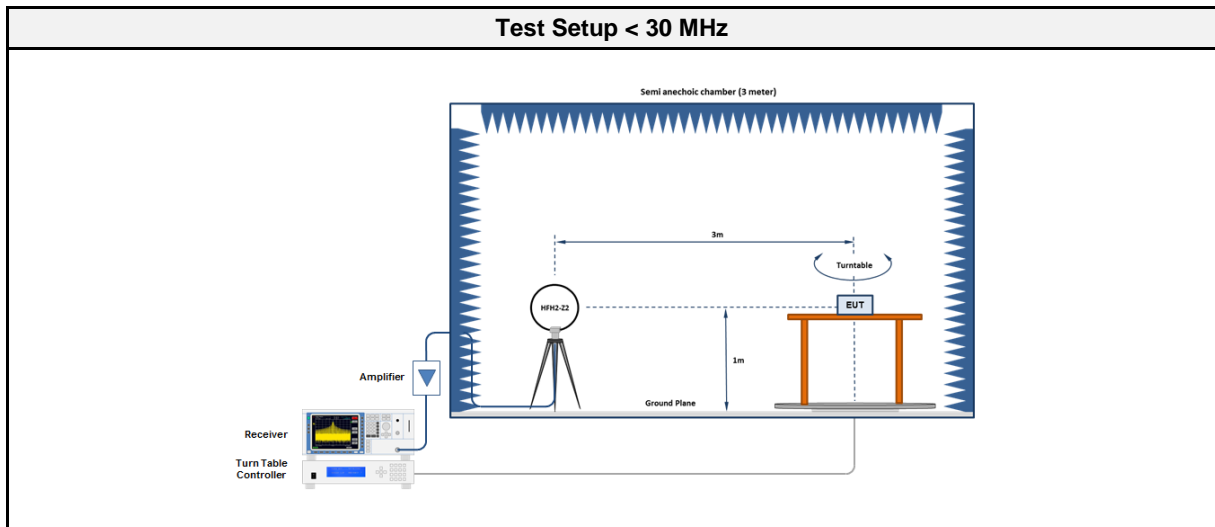

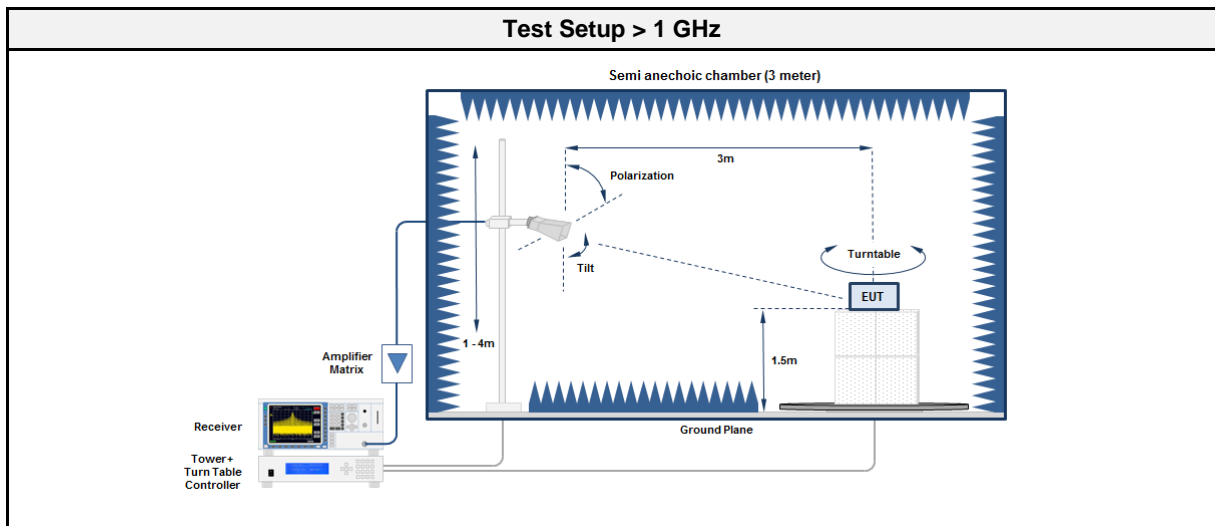
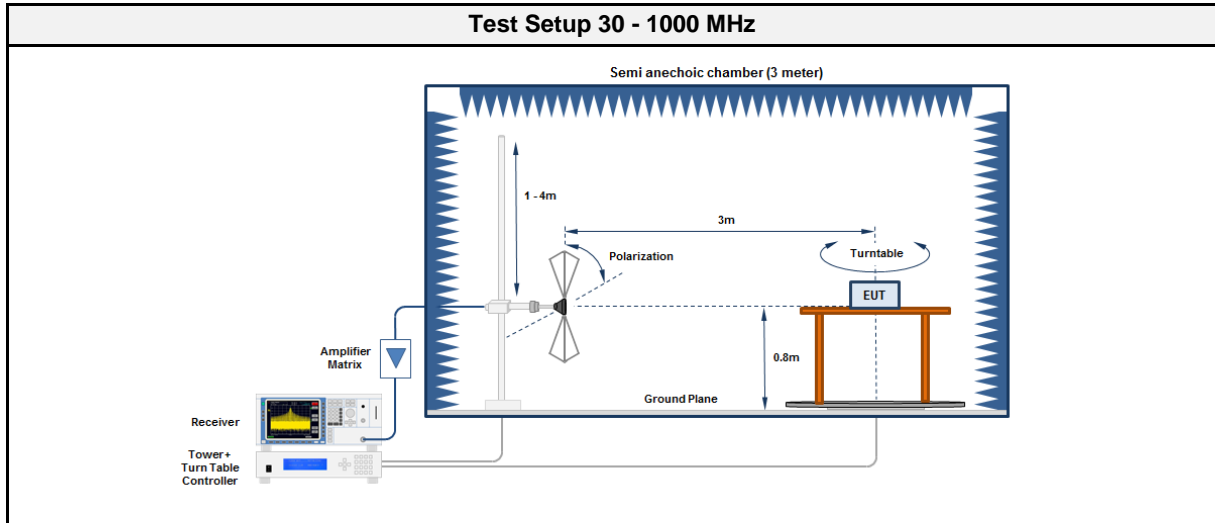

3.3.4 Equipment

Test Software			
Description	Manufacturer	Name	Version
EMC Software	DARE Instruments	RadiMation	2015.2.4

Test Equipment 30 - 1000 MHz					
Description	Manufacturer	Model	Identifier	Cal. Date	Cal. Due
Anechoic Chamber	Frankonia	AC1	EF00062	2018-07	2021-07
Measurement Receiver	Agilent	N9038A-526/WXP	EF01070	2018-08	2019-08
Antenna	R&S	VULB 9162	EF00978	2016-11	2019-11
Antenna	R&S	HK 116	EF00030	2016-04	2019-04
Antenna	R&S	HL 223	EF00187	2016-05	2019-05

Test Equipment > 1 GHz					
Description	Manufacturer	Model	Identifier	Cal. Date	Cal. Due
Anechoic Chamber	Frankonia	AC1	EF00062	2018-07	2021-07
Measurement Receiver	Agilent	N9038A-526/WXP	EF01070	2018-08	2019-08
Antenna	Schwarzbeck	BBHA 9120D	EF00018	2016-09	2019-09
Antenna	Amplifier Research	AT4560	EF00302	2018-04	2019-04
Antenna	Amplifier Research	AT4560	EF01152	2018-10	2019-10

3.3.5 Procedure

Test Procedure < 30 MHz
<ol style="list-style-type: none"> EUT is placed on a non conducting support at the center of a turn table 0.8 m above the ground EUT set to test mode The EUT is rotated through 360° The emissions are measured with peak detector and max hold All significant emissions are measured again using the corresponding final detector

Test Procedure 30 - 1000 MHz
<ol style="list-style-type: none"> EUT is placed on a non conducting support at the center of a turn table 0.8 m above the ground EUT set to test mode The receiver is set to peak detection with max hold The EUT is rotated through 360° and the height of the antenna is varied from 1 m to 4 m All significant emissions are measured again using the corresponding final detector

Test Procedure > 1 GHz
<ol style="list-style-type: none"> EUT is placed on a non conducting support at the center of a turn table 1.5 m above the ground EUT set to test mode The receiver is set to peak detection with max hold The EUT is rotated through 360° and the height of the antenna is varied from 1 m to 4 m All significant emissions are measured again using the corresponding final detector

3.3.6 Results

Test Results - DH5						
Channel [MHz]	Emission [MHz]	Level [dB μ V/m]	Det.	Pol.	Limit [dB μ V/m]	Margin [dB]
2402	240.96	23.65	pk	hor	46.00	-22.35
2402	4800	38.10	pk	ver	74.00	-35.90
2441	4717	39.42	pk	ver	74.00	-34.58
2441	4877	40.38	pk	ver	74.00	-33.62
2480	4960	39.63	pk	hor	74.00	-34.37
2480	4960	41.67	pk	ver	74.00	-32.33

Test Results - 2-DH5						
Channel [MHz]	Emission [MHz]	Level [dB μ V/m]	Det.	Pol.	Limit [dB μ V/m]	Margin [dB]
2402	Emission level corresponds to ambient noise floor					
2441						
2480						
Comment	Only plots containing spurious emission are shown in this annex. All missing plots only contain noise.					

Test Results - 3-DH5						
Channel [MHz]	Emission [MHz]	Level [dB μ V/m]	Det.	Pol.	Limit [dB μ V/m]	Margin [dB]
2402	Emission level corresponds to ambient noise floor					
2441						
2480						
Comment	Only plots containing spurious emission are shown in this annex. All missing plots only contain noise.					

3.4 Test Conditions and Results - Receiver radiated emissions

3.4.1 Information

Test Information	
Reference	ISED RSS-247, Issue 2 (section 3.1)
Measurement Method	ANSI C63.10 6.5, 6.6
Operator	Wilfried Treffke
Date	2019-02-07

3.4.2 Limits

Limits			
Frequency [MHz]	Detector	Field strength [dB μ V/m]	Measurement distance [m]
30 - 88	Quasi-Peak	100	3
88 - 216	Quasi-Peak	150	3
216 - 960	Quasi-Peak	200	3
960 - 1000	Quasi-Peak	500	3
>1000	Average	500	3

3.4.3 Setup

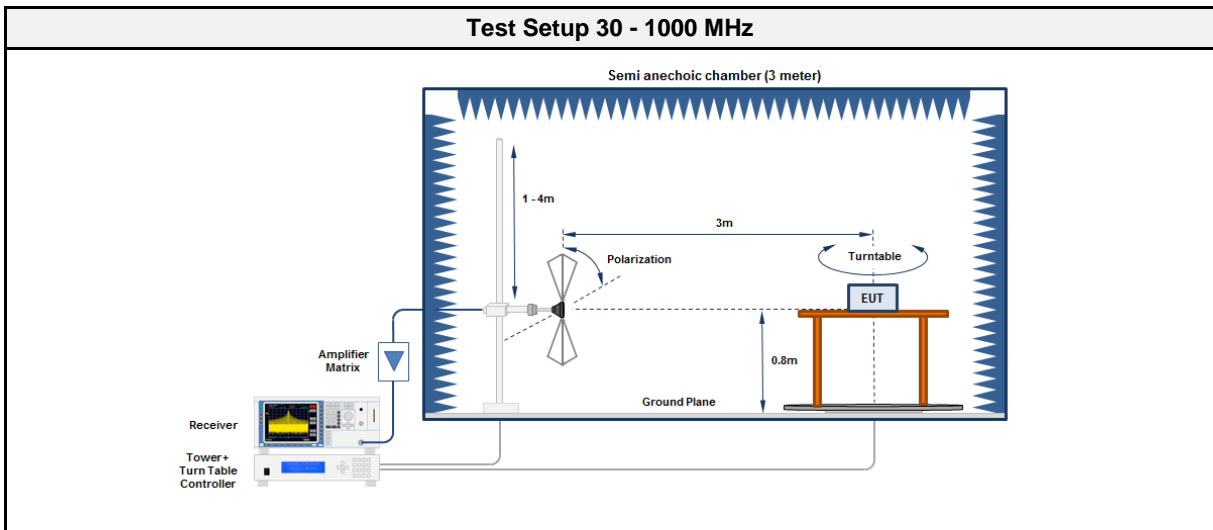

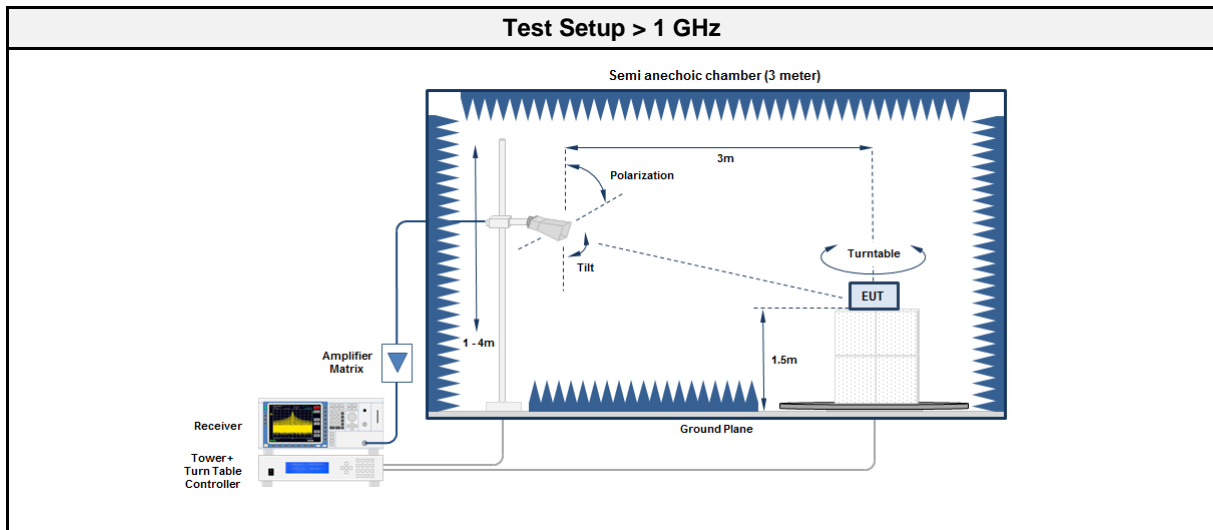

3.4.4 Equipment

Test Software			
Description	Manufacturer	Name	Version
EMC Software	DARE Instruments	RadiMation	2015.2.4

Test Equipment 30 - 1000 MHz					
Description	Manufacturer	Model	Identifier	Cal. Date	Cal. Due
Anechoic Chamber	Frankonia	AC1	EF00062	2018-07	2021-07
Measurement Receiver	Agilent	N9038A-526/WXP	EF01070	2018-08	2019-08
Antenna	R&S	VULB 9162	EF00978	2016-11	2019-11
Antenna	R&S	HK 116	EF00030	2016-04	2019-04
Antenna	R&S	HL 223	EF00187	2016-05	2019-05

Test Equipment > 1 GHz					
Description	Manufacturer	Model	Identifier	Cal. Date	Cal. Due
Anechoic Chamber	Frankonia	AC1	EF00062	2018-07	2021-07
Measurement Receiver	Agilent	N9038A-526/WXP	EF01070	2018-08	2019-08
Antenna	Schwarzbeck	BBHA 9120D	EF00018	2016-09	2019-09
Antenna	Amplifier Research	AT4560	EF00302	2018-04	2019-04
Antenna	Amplifier Research	AT4560	EF01152	2018-10	2019-10

3.4.5 Procedure

Test Procedure 30 - 1000 MHz
<ol style="list-style-type: none"> 1. EUT is placed on a non conducting support at the center of a turn table 0.8 m above the ground 2. EUT set to test mode 3. The receiver is set to peak detection with max hold 4. The EUT is rotated through 360° and the height of the antenna is varied from 1 m to 4 m 5. All significant emissions are measured again using the corresponding final detector

Test Procedure > 1 GHz

1. EUT is placed on a non conducting support at the center of a turn table 1.5 m above the ground
2. EUT set to test mode
3. The receiver is set to peak detection with max hold
4. The EUT is rotated through 360° and the height of the antenna is varied from 1 m to 4 m
5. All significant emissions are measured again using the corresponding final detector

3.4.6 Results

Test Results

Channel [MHz]	Emission [MHz]	Level [dB μ V/m]	Det.	Pol.	Limit [dB μ V/m]	Margin [dB]
scan mode	31.335	30.40	qpk	ver	40.00	-09.60
scan mode	237.12	23.38	pk	hor	46.00	-22.62

ANNEX A Transmitter spurious emissions

Spurious emissions according to FCC 15.247

Project number: G0M-1812-7889
 Applicant: Leica Geosystems AG
 EUT Name: Field Controller Win EC7
 Model: CS20
 Test Site: Eurofins Product Service GmbH
 Operator: Wilfried Treffke
 Test Conditions: Tnom: 22°C, Vnom: 120V AC (intern 11.1 V DC)
 Antenna: Rohde & Schwarz HK 116, Horizontal
 Measurement distance: 3 m
 Mode: TX; GFSK; DH5; 2402 MHz
 Test Date: 2019-02-06
 Note:

Index 39

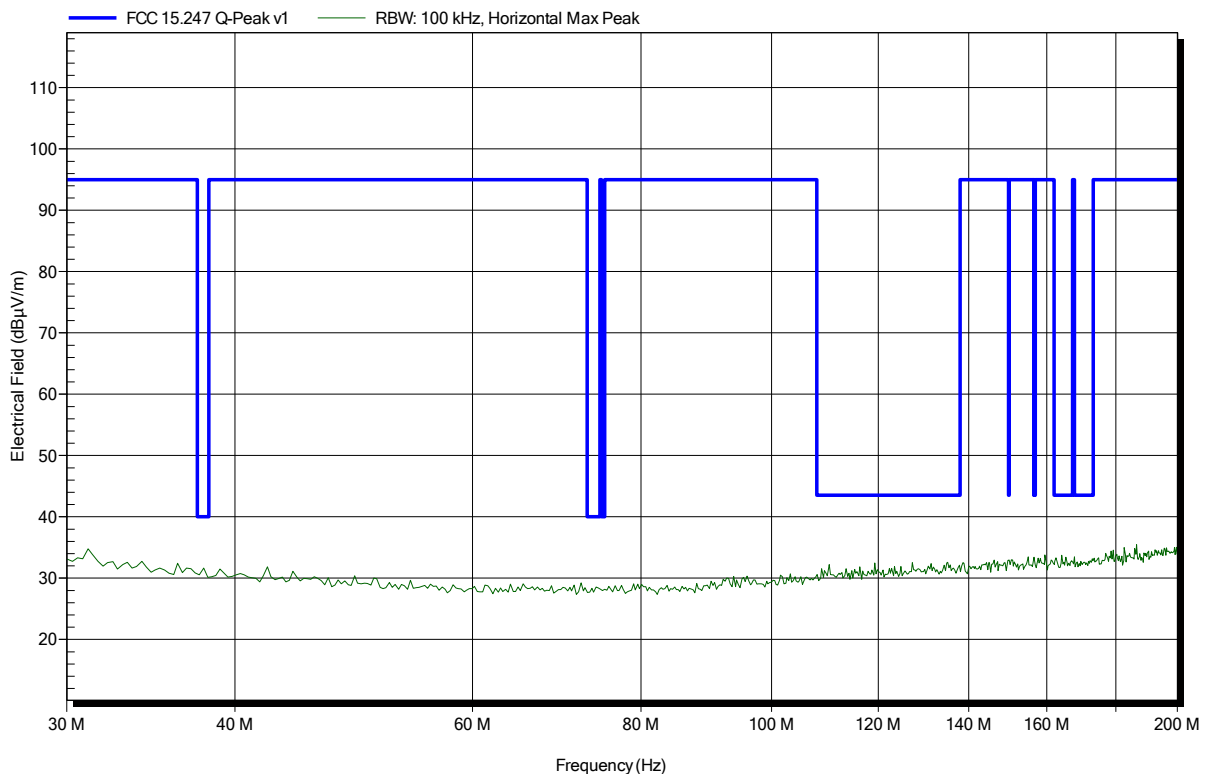

Spurious emissions according to FCC 15.247

Project number: G0M-1812-7889
 Applicant: Leica Geosystems AG
 EUT Name: Field Controller Win EC7
 Model: CS20
 Test Site: Eurofins Product Service GmbH
 Operator: Wilfried Treffke
 Test Conditions: Tnom: 22°C, Vnom: 120V AC (intern 11.1 V DC)
 Antenna: Rohde & Schwarz HK 116, Vertical
 Measurement distance: 3 m
 Mode: TX; GFSK; DH5; 2402 MHz
 Test Date: 2019-02-06
 Note:

Index 40

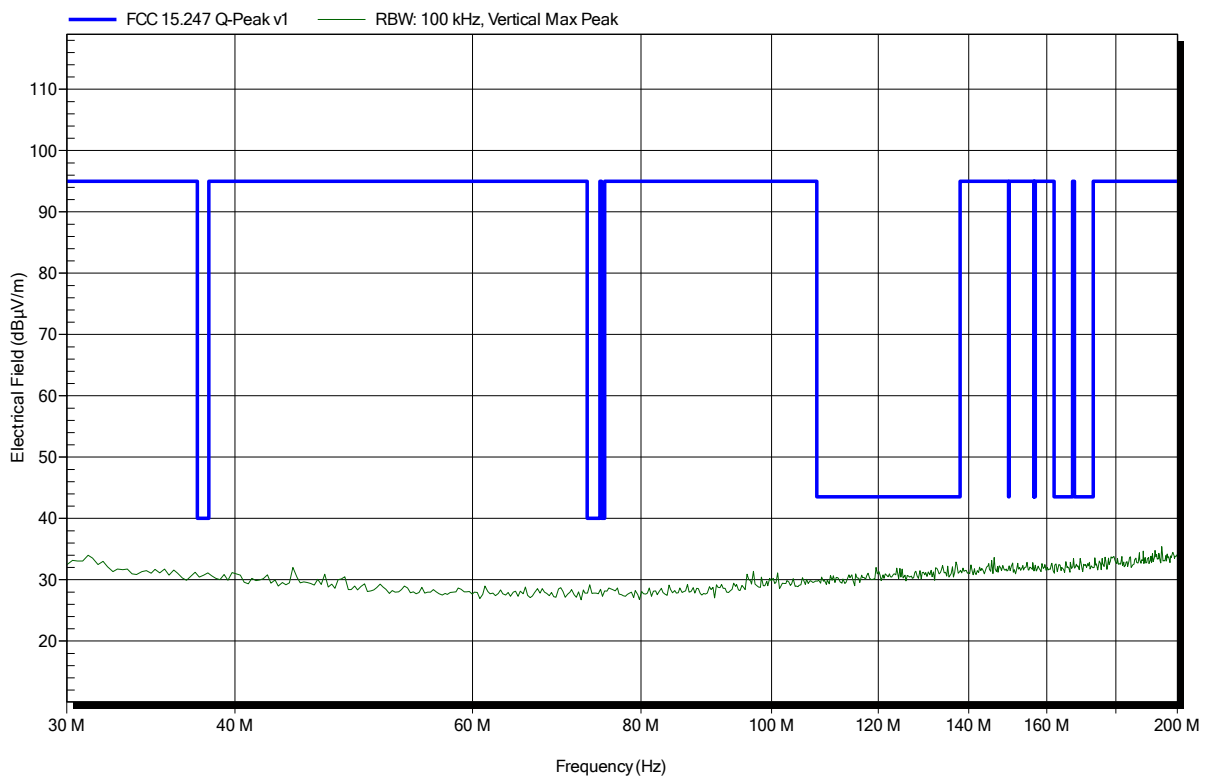

Spurious emissions according to FCC 15.247

Project number: G0M-1812-7889
 Applicant: Leica Geosystems AG
 EUT Name: Field Controller Win EC7
 Model: CS20
 Test Site: Eurofins Product Service GmbH
 Operator: Wilfried Treffke
 Test Conditions: Tnom: 22°C, Vnom: 120V AC (intern 11.1 V DC)
 Antenna: Rohde & Schwarz HL 223, Horizontal
 Measurement distance: 3 m
 Mode: TX; GFSK; DH5; 2402 MHz
 Test Date: 2019-02-06
 Note:

Index 37

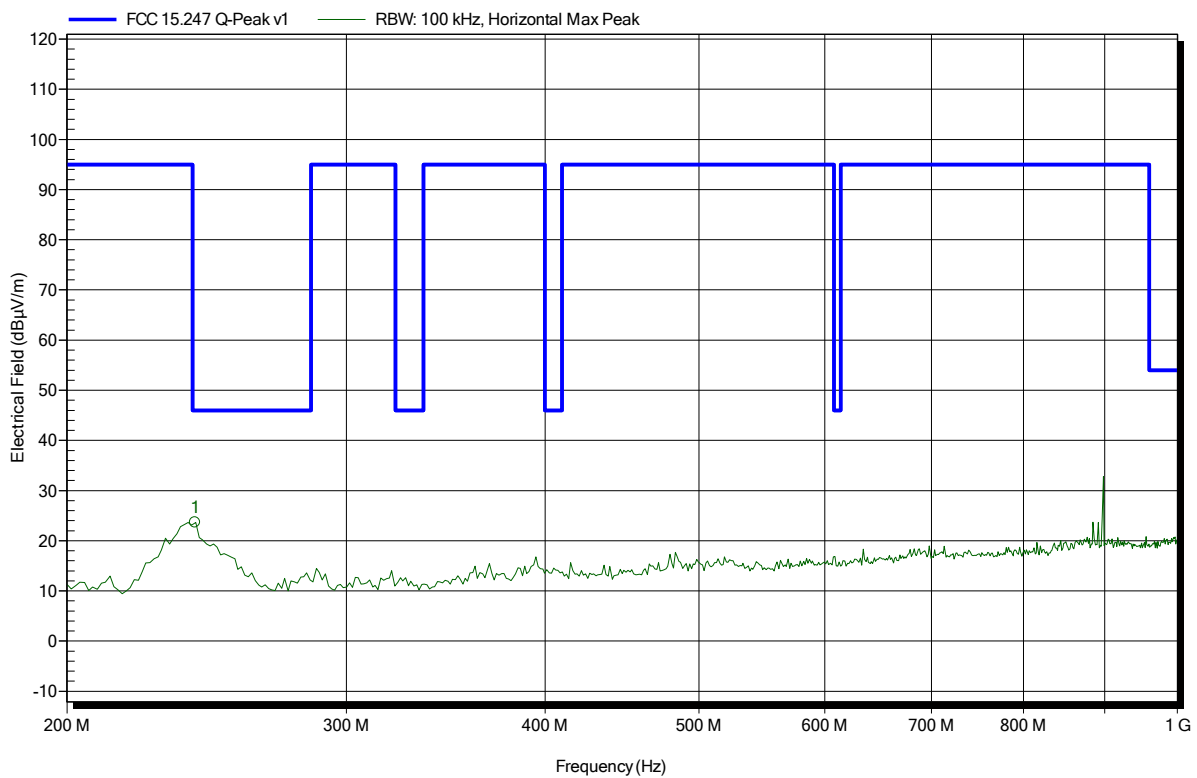

Frequency	Peak	Peak Limit	Peak Difference	Peak Status
240.96 MHz	23.65 dBµV/m	46 dBµV/m	-22.35 dB	Pass

Spurious emissions according to FCC 15.247

Project number: G0M-1812-7889
 Applicant: Leica Geosystems AG
 EUT Name: Field Controller Win EC7
 Model: CS20
 Test Site: Eurofins Product Service GmbH
 Operator: Wilfried Treffke
 Test Conditions: Tnom: 22°C, Vnom: 120V AC (intern 11.1 V DC)
 Antenna: Rohde & Schwarz HL 223, Vertical
 Measurement distance: 3 m
 Mode: TX; GFSK; DH5; 2402 MHz
 Test Date: 2019-02-06
 Note:

Index 38

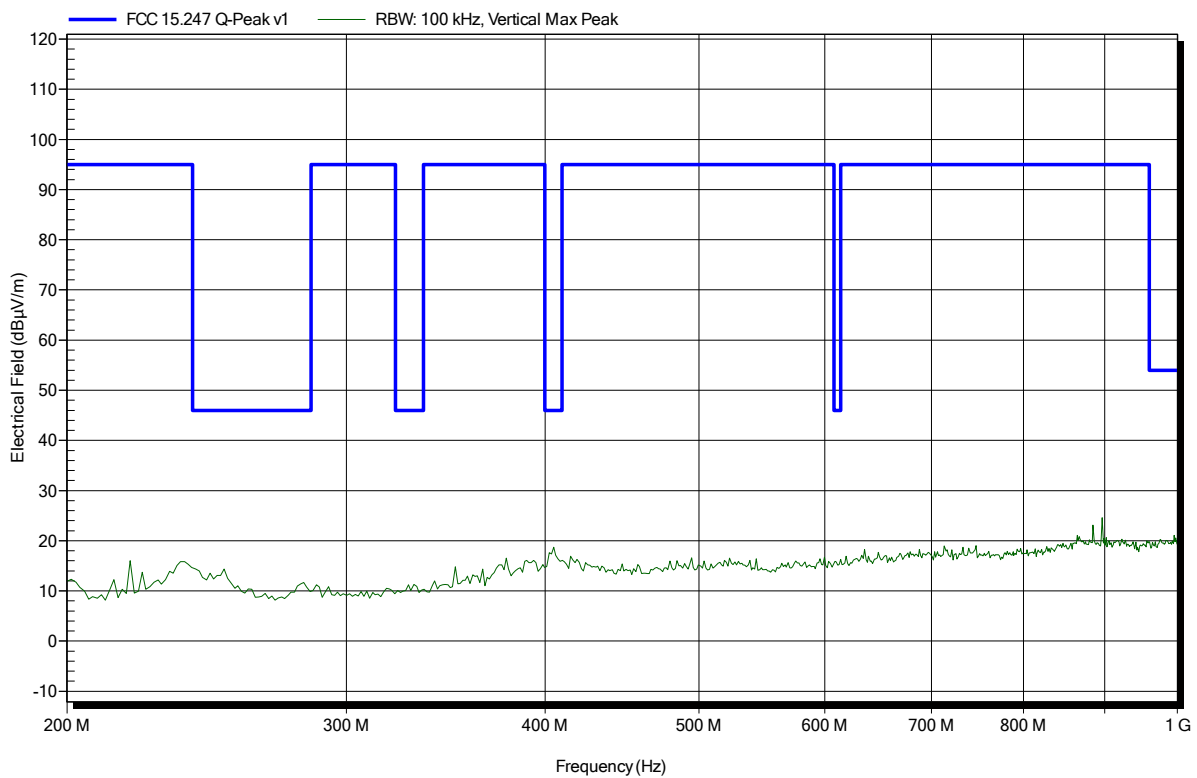

Spurious emissions according to FCC 15.247

Project number: G0M-1812-7889
 Applicant: Leica Geosystems AG
 EUT Name: Field Controller Win EC7
 Model: CS20
 Test Site: Eurofins Product Service GmbH
 Operator: Wilfried Treffke
 Test Conditions: Tnom: 22°C, Vnom: 120V AC (intern 11.1 V DC)
 Antenna: Schwarzbeck BBHA 9120D, Horizontal
 Measurement distance: 1 m converted to 3m
 Mode: TX; GFSK; DH5;2402 MHz
 Test Date: 2019-02-01
 Note:

Index 2

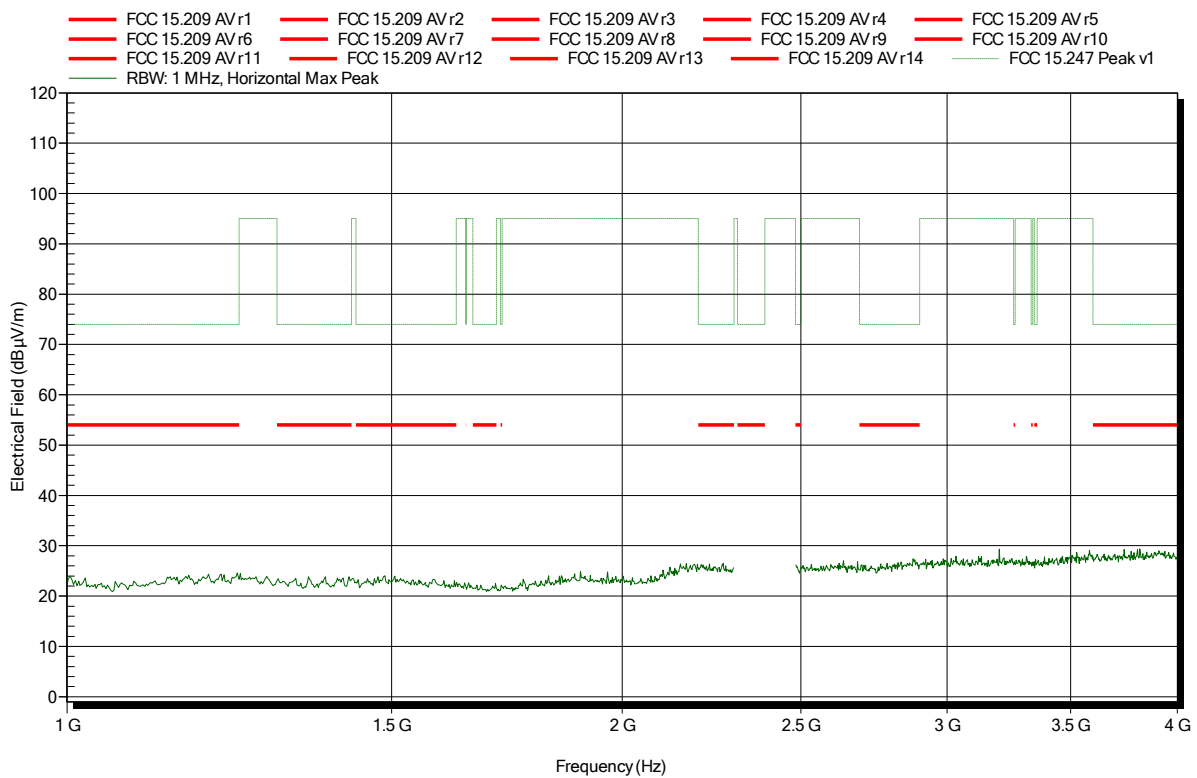

Spurious emissions according to FCC 15.247

Project number: G0M-1812-7889
 Applicant: Leica Geosystems AG
 EUT Name: Field Controller Win EC7
 Model: CS20
 Test Site: Eurofins Product Service GmbH
 Operator: Wilfried Treffke
 Test Conditions: Tnom: 22°C, Vnom: 120V AC (intern 11.1 V DC)
 Antenna: Schwarzbeck BBHA 9120D, Vertical
 Measurement distance: 1 m converted to 3m
 Mode: TX; GFSK; DH5;2402 MHz
 Test Date: 2019-02-01
 Note:

Index 8

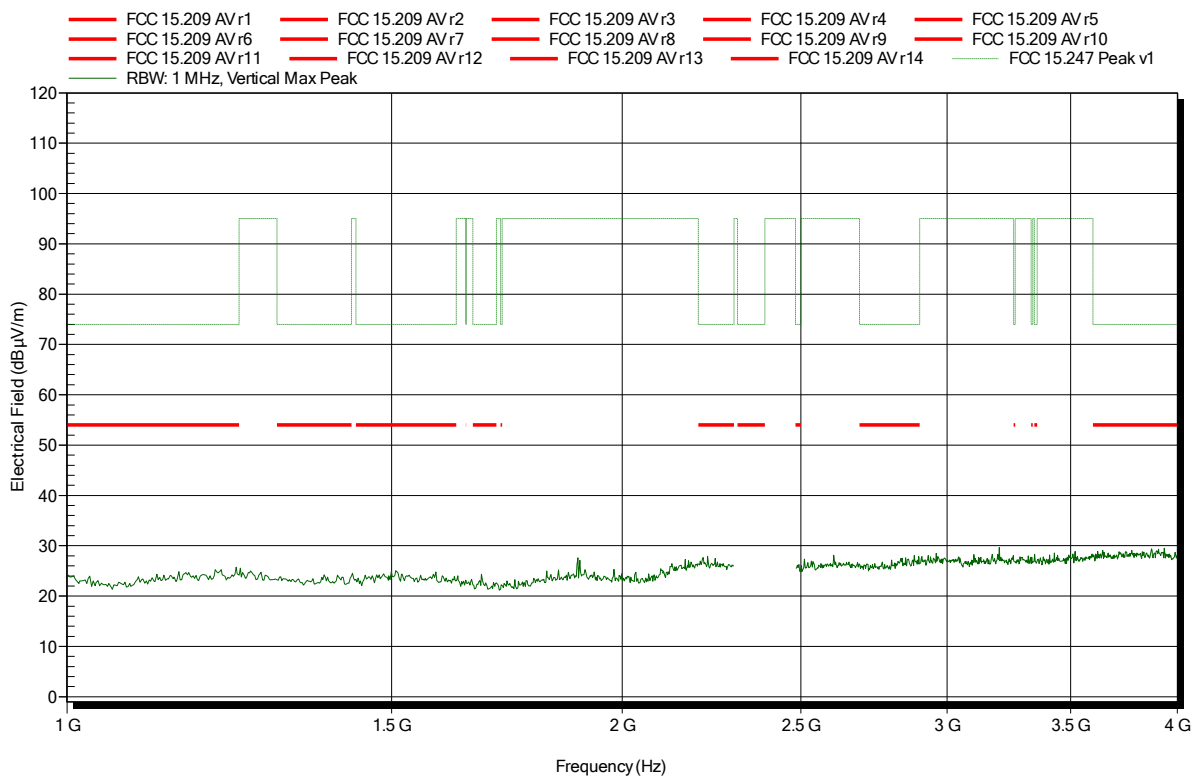

Spurious emissions according to FCC 15.247

Project number: G0M-1812-7889
 Applicant: Leica Geosystems AG
 EUT Name: Field Controller Win EC7
 Model: CS20
 Test Site: Eurofins Product Service GmbH
 Operator: Wilfried Treffke
 Test Conditions: Tnom: 22°C, Vnom: 120V AC (intern 11.1 V DC)
 Antenna: Schwarzbeck BBHA 9120D, Horizontal
 Measurement distance: 1 m converted to 3m
 Mode: TX; GFSK; DH5;2402 MHz
 Test Date: 2019-02-01
 Note: lower bandedge

Index 3

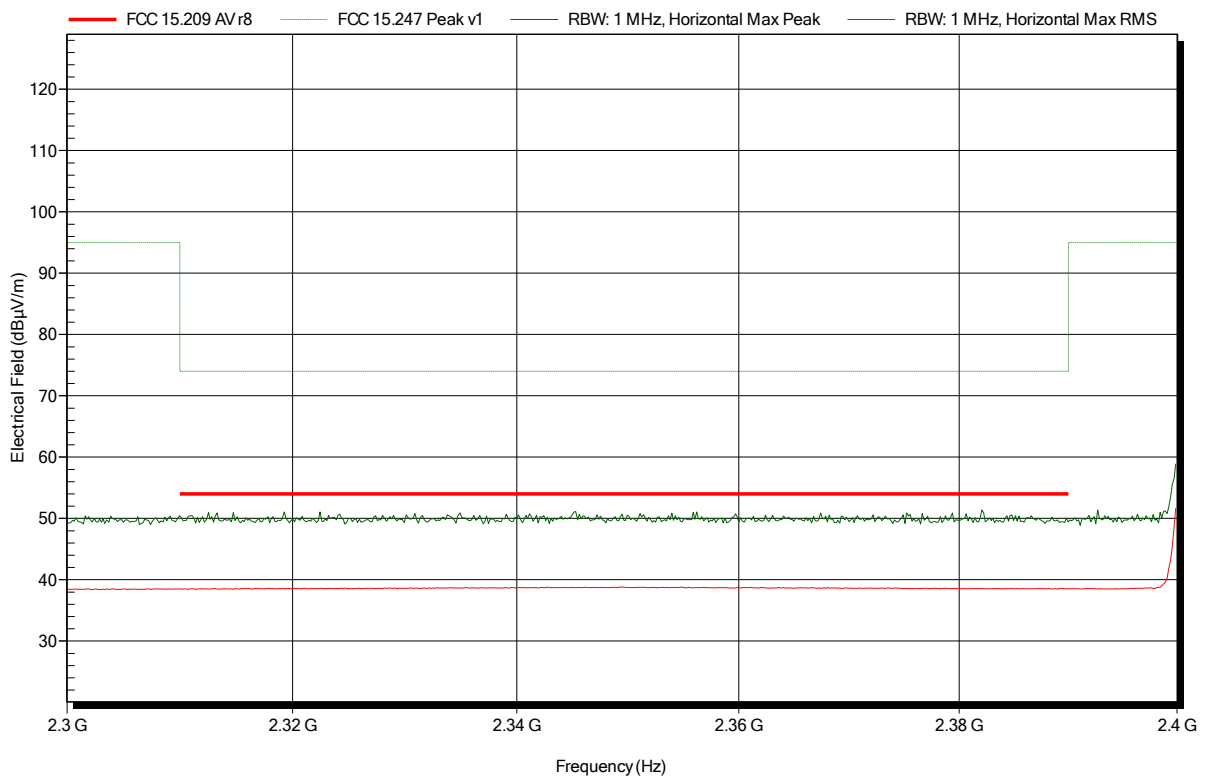

Spurious emissions according to FCC 15.247

Project number: G0M-1812-7889
 Applicant: Leica Geosystems AG
 EUT Name: Field Controller Win EC7
 Model: CS20
 Test Site: Eurofins Product Service GmbH
 Operator: Wilfried Treffke
 Test Conditions: Tnom: 22°C, Vnom: 120V AC (intern 11.1 V DC)
 Antenna: Schwarzbeck BBHA 9120D, Vertical
 Measurement distance: 1 m converted to 3m
 Mode: TX; GFSK; DH5;2402 MHz
 Test Date: 2019-02-01
 Note: lower bandedge

Index 9

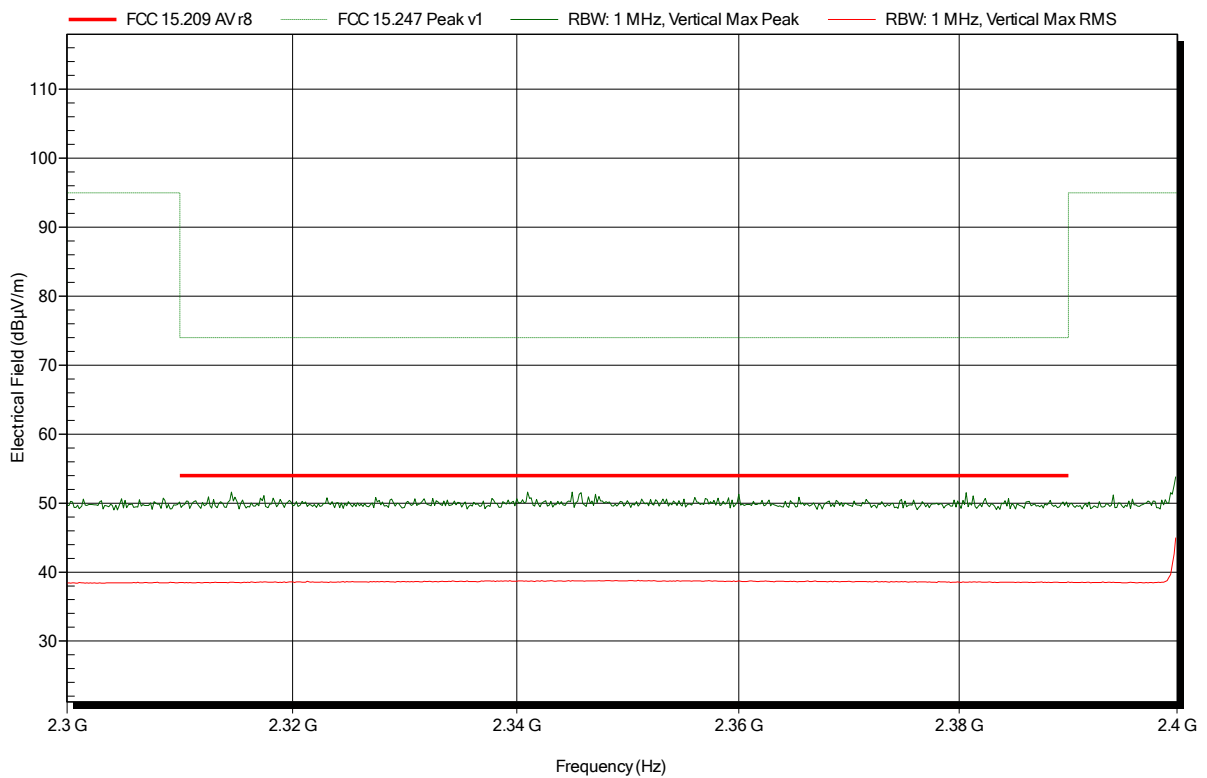

Spurious emissions according to FCC 15.247

Project number: G0M-1812-7889
 Applicant: Leica Geosystems AG
 EUT Name: Field Controller Win EC7
 Model: CS20
 Test Site: Eurofins Product Service GmbH
 Operator: Wilfried Treffke
 Test Conditions: Tnom: 22°C, Vnom: 120V AC (intern 11.1 V DC)
 Antenna: Schwarzbeck BBHA 9120D, Horizontal
 Measurement distance: 1 m converted to 3m
 Mode: TX; GFSK; DH5;2402 MHz
 Test Date: 2019-02-01
 Note:

Index 4

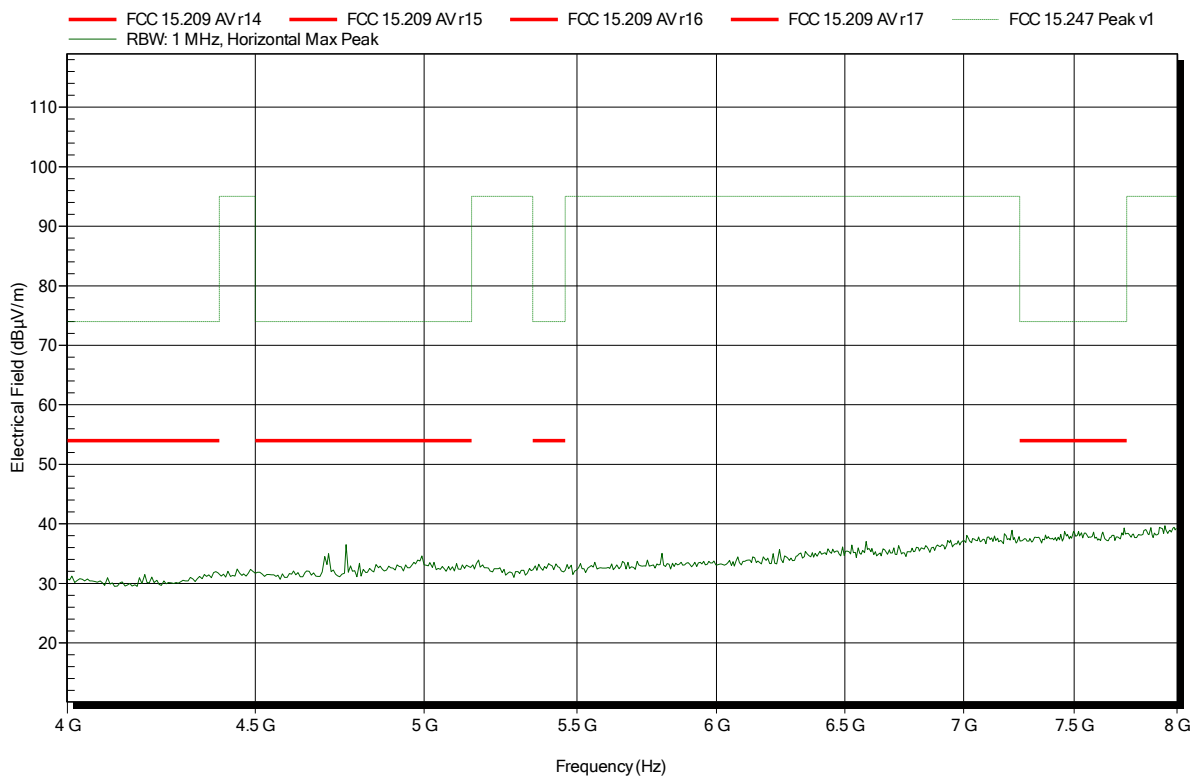

Spurious emissions according to FCC 15.247

Project number: G0M-1812-7889
 Applicant: Leica Geosystems AG
 EUT Name: Field Controller Win EC7
 Model: CS20
 Test Site: Eurofins Product Service GmbH
 Operator: Wilfried Treffke
 Test Conditions: Tnom: 22°C, Vnom: 120V AC (intern 11.1 V DC)
 Antenna: Schwarzbeck BBHA 9120D, Vertical
 Measurement distance: 1 m converted to 3m
 Mode: TX; GFSK; DH5;2402 MHz
 Test Date: 2019-02-01
 Note:

Index 10

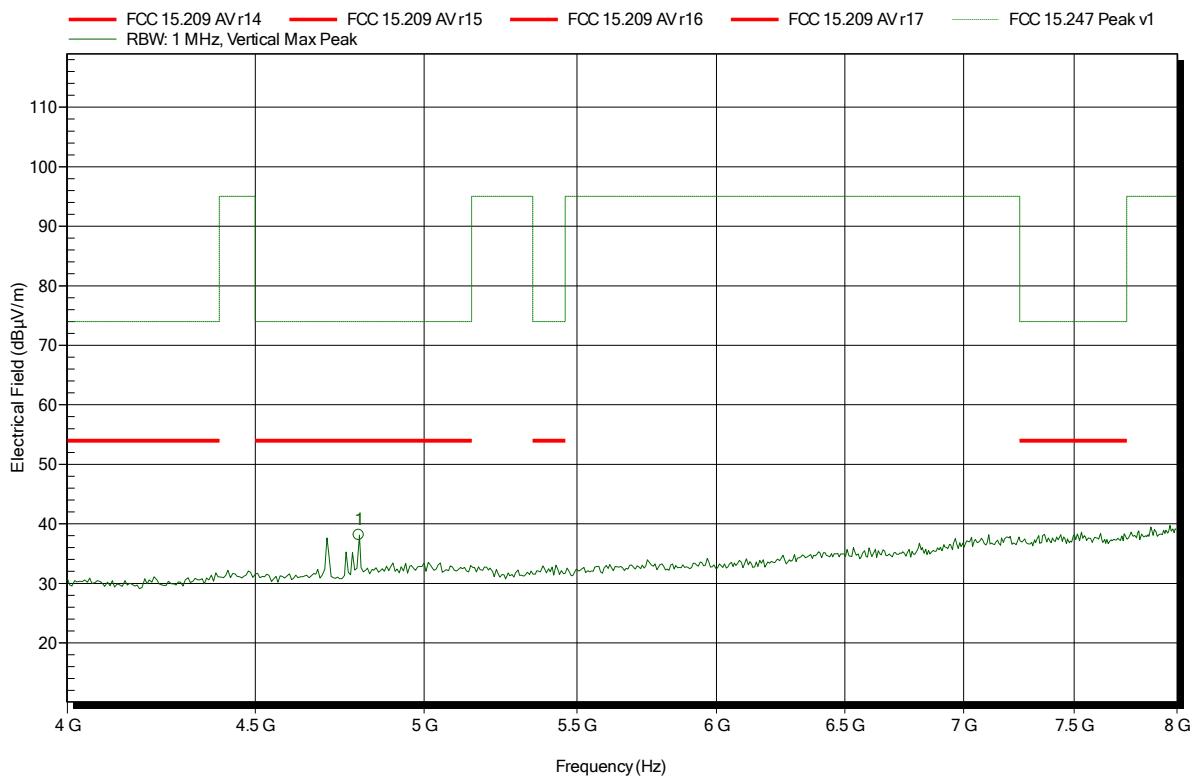

Frequency	Peak	Peak Limit	Peak Difference	Peak Status
4.8 GHz	38.1 dBµV/m	74 dBµV/m	-35.9 dB	Pass

Spurious emissions according to FCC 15.247

Project number: G0M-1812-7889
 Applicant: Leica Geosystems AG
 EUT Name: Field Controller Win EC7
 Model: CS20
 Test Site: Eurofins Product Service GmbH
 Operator: Wilfried Treffke
 Test Conditions: Tnom: 22°C, Vnom: 120V AC (intern 11.1 V DC)
 Antenna: Schwarzbeck BBHA 9120D, Horizontal
 Measurement distance: 1 m converted to 3m
 Mode: TX; GFSK; DH5;2402 MHz
 Test Date: 2019-02-01
 Note:

Index 5

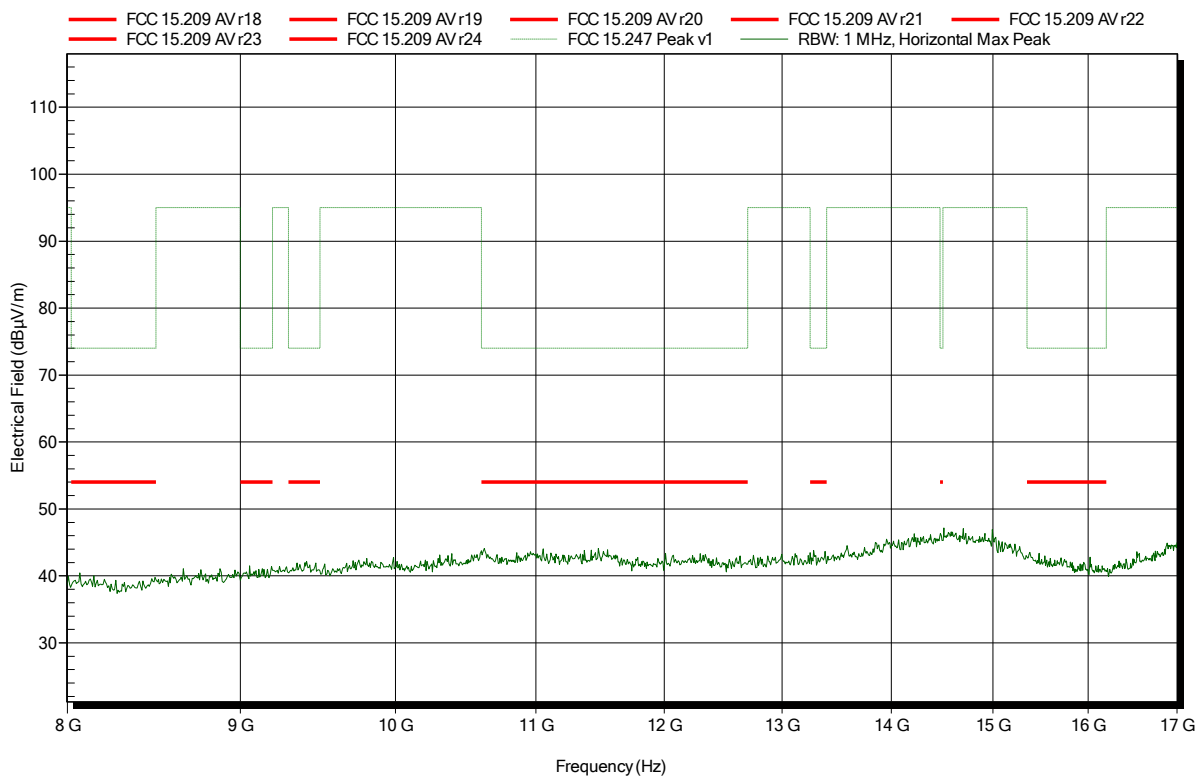

Spurious emissions according to FCC 15.247

Project number: G0M-1812-7889
 Applicant: Leica Geosystems AG
 EUT Name: Field Controller Win EC7
 Model: CS20
 Test Site: Eurofins Product Service GmbH
 Operator: Wilfried Treffke
 Test Conditions: Tnom: 22°C, Vnom: 120V AC (intern 11.1 V DC)
 Antenna: Schwarzbeck BBHA 9120D, Vertical
 Measurement distance: 1 m converted to 3m
 Mode: TX; GFSK; DH5;2402 MHz
 Test Date: 2019-02-01
 Note:

Index 11

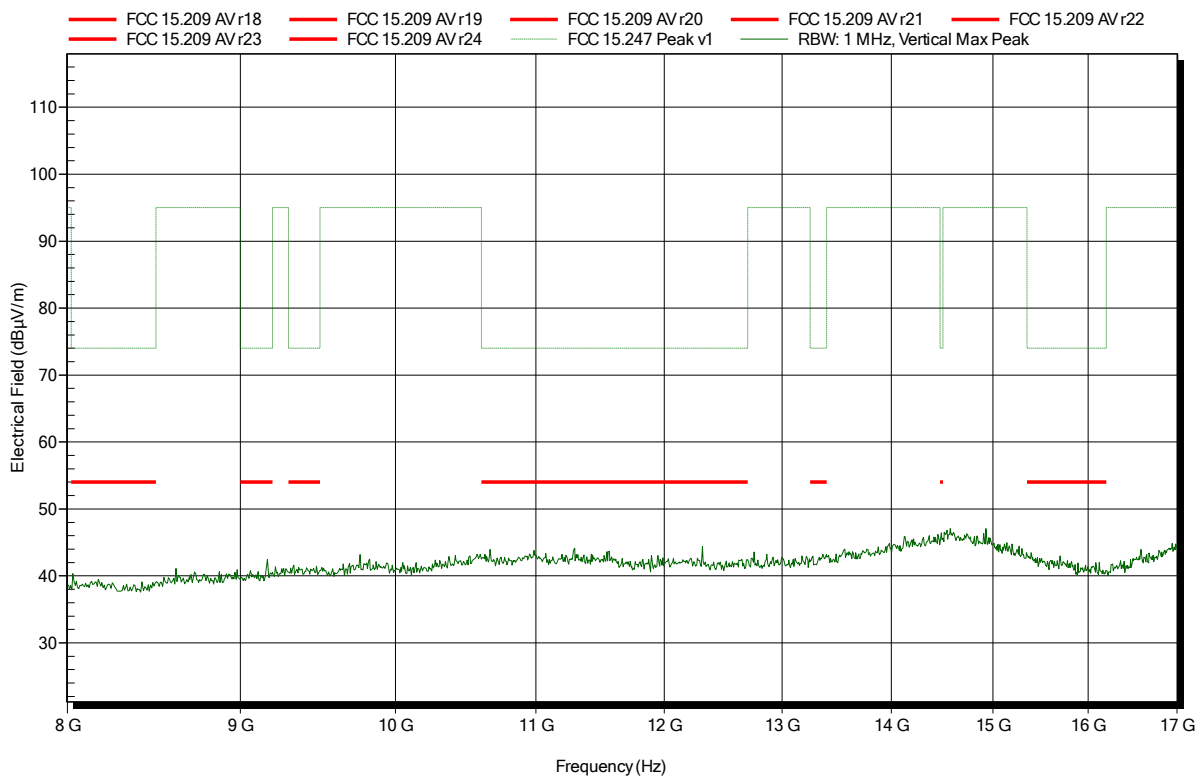

Spurious emissions according to FCC 15.247

Project number: G0M-1812-7889
 Applicant: Leica Geosystems AG
 EUT Name: Field Controller Win EC7
 Model: CS20
 Test Site: Eurofins Product Service GmbH
 Operator: Wilfried Treffke
 Test Conditions: Tnom: 22°C, Vnom: 120V AC (intern 11.1 V DC)
 Antenna: Amplifier Research AT4560, Horizontal
 Measurement distance: 1 m converted to 3m
 Mode: TX; GFSK; DH5;2402 MHz
 Test Date: 2019-02-01
 Note:

Index 6

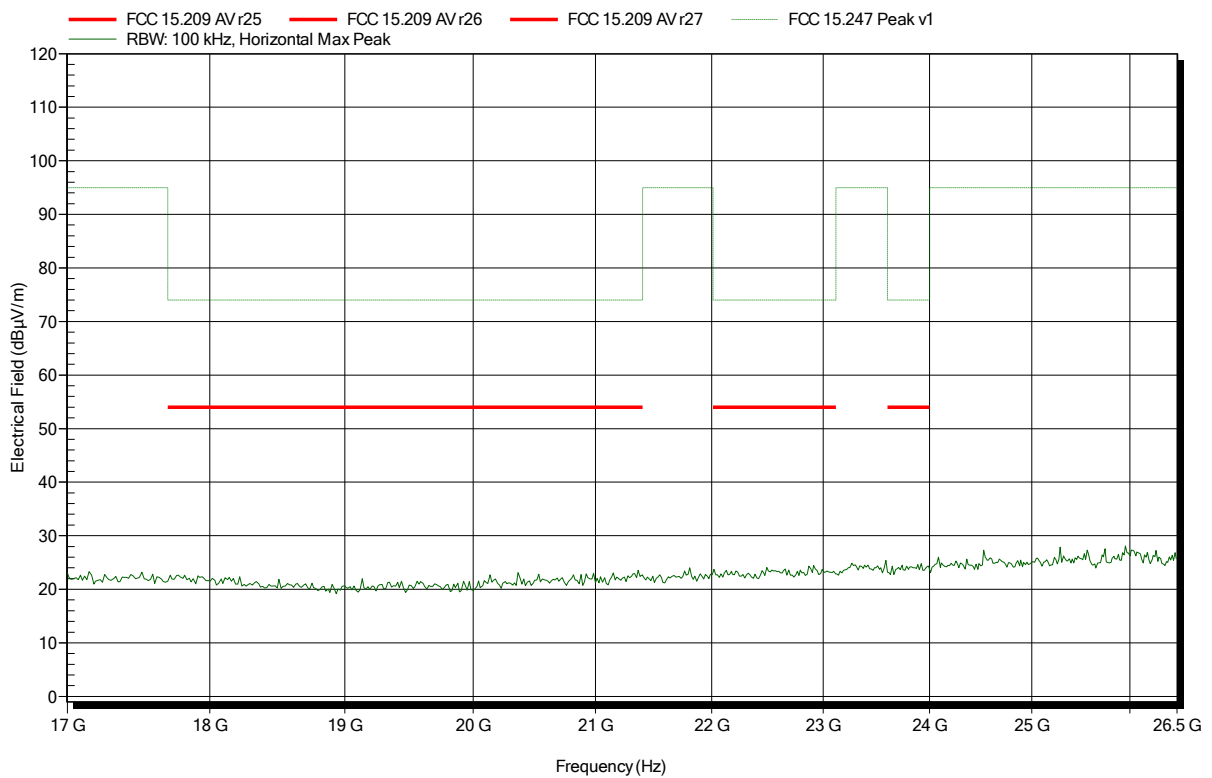

Spurious emissions according to FCC 15.247

Project number: G0M-1812-7889
 Applicant: Leica Geosystems AG
 EUT Name: Field Controller Win EC7
 Model: CS20
 Test Site: Eurofins Product Service GmbH
 Operator: Wilfried Treffke
 Test Conditions: Tnom: 22°C, Vnom: 120V AC (intern 11.1 V DC)
 Antenna: Amplifier Research AT4560, Vertical
 Measurement distance: 1 m converted to 3m
 Mode: TX; GFSK; DH5;2402 MHz
 Test Date: 2019-02-01
 Note:

Index 12

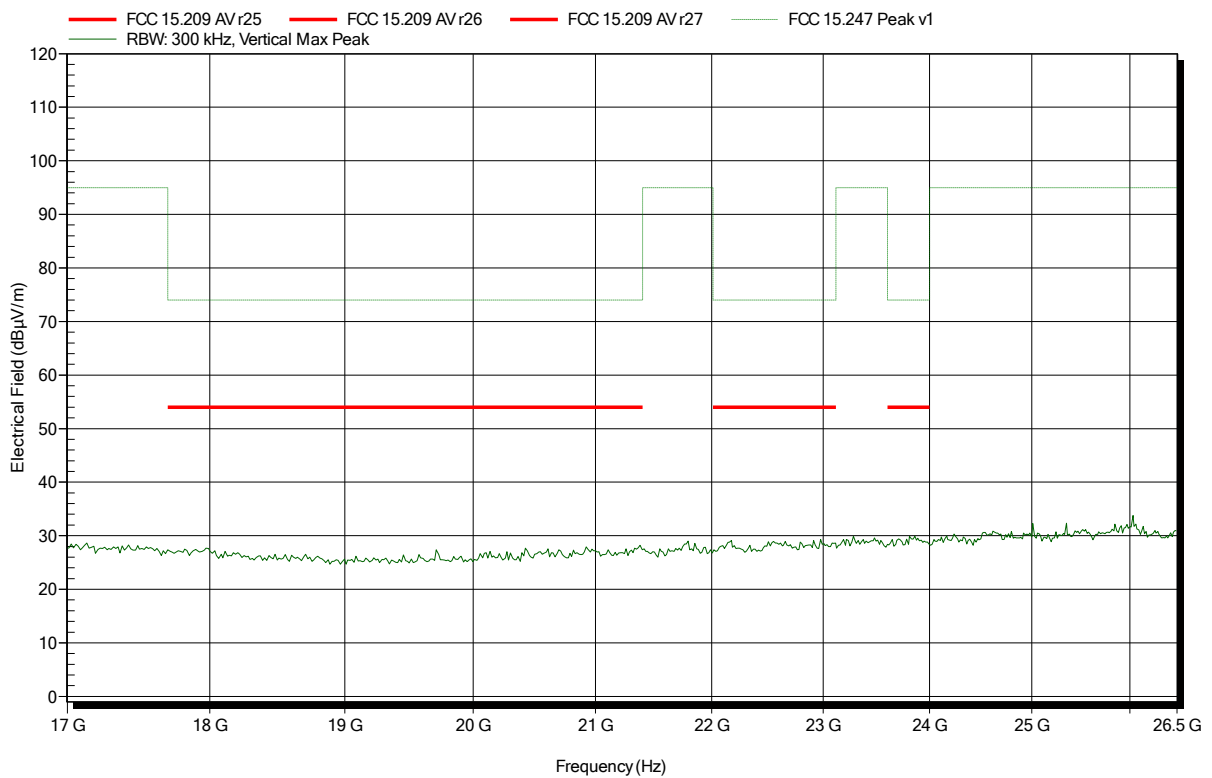

Spurious emissions according to FCC 15.247

Project number: G0M-1812-7889
 Applicant: Leica Geosystems AG
 EUT Name: Field Controller Win EC7
 Model: CS20
 Test Site: Eurofins Product Service GmbH
 Operator: Wilfried Treffke
 Test Conditions: Tnom: 22°C, Vnom: 120V AC (intern 11.1 V DC)
 Antenna: Schwarzbeck BBHA 9120D, Horizontal
 Measurement distance: 1 m converted to 3m
 Mode: TX; GFSK; DH5;2441 MHz
 Test Date: 2019-02-06
 Note:

Index 19

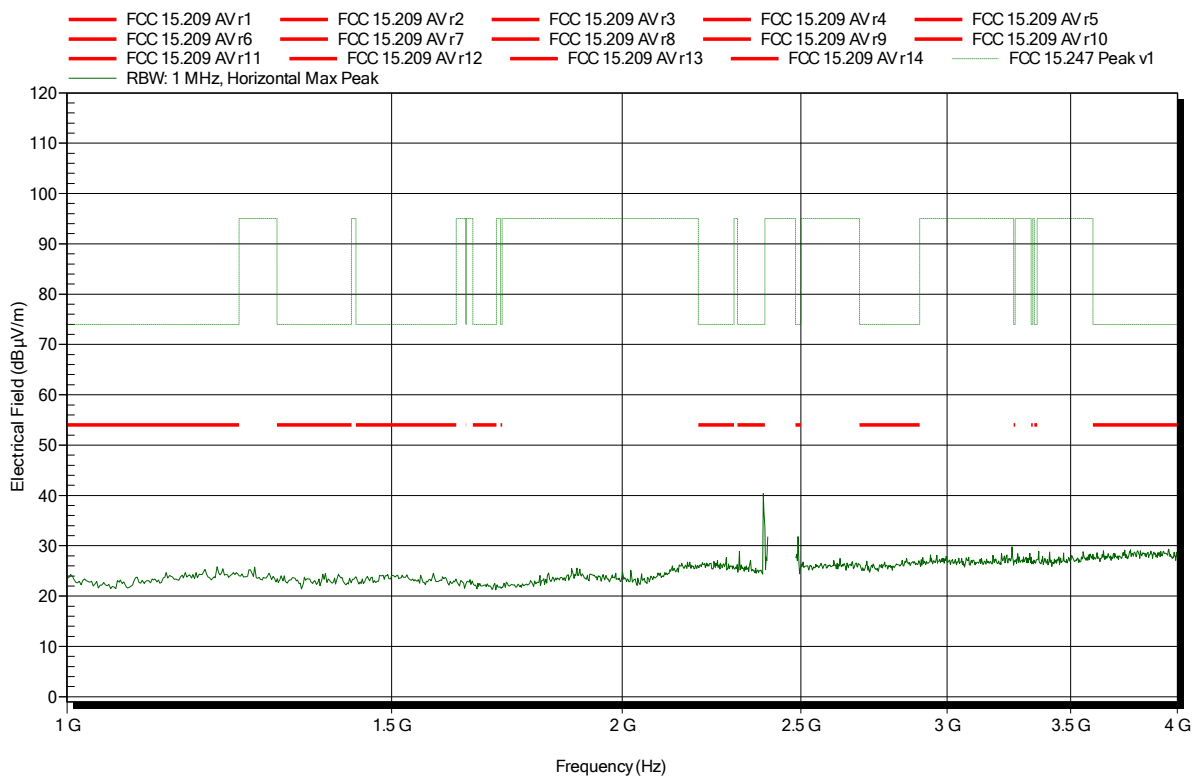

Spurious emissions according to FCC 15.247

Project number: G0M-1812-7889
 Applicant: Leica Geosystems AG
 EUT Name: Field Controller Win EC7
 Model: CS20
 Test Site: Eurofins Product Service GmbH
 Operator: Wilfried Treffke
 Test Conditions: Tnom: 22°C, Vnom: 120V AC (intern 11.1 V DC)
 Antenna: Schwarzbeck BBHA 9120D, Vertical
 Measurement distance: 1 m converted to 3m
 Mode: TX; GFSK; DH5;2441 MHz
 Test Date: 2019-02-06
 Note:

Index 23

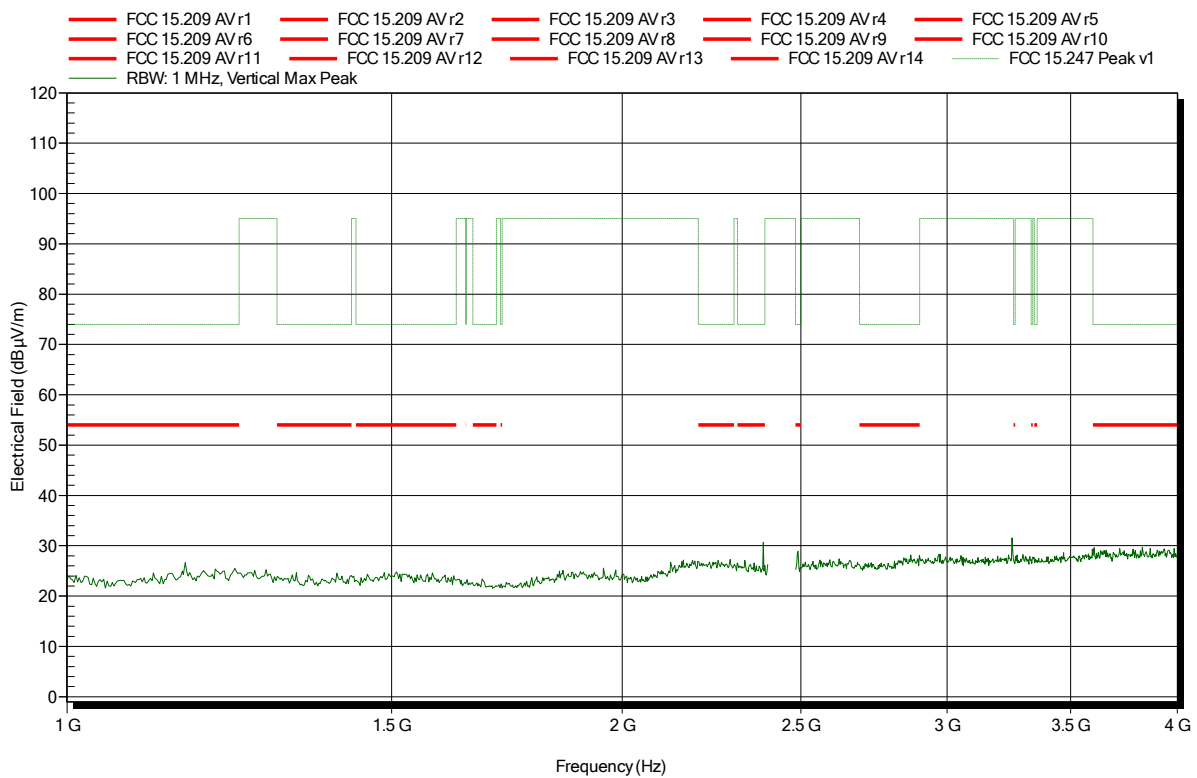

Spurious emissions according to FCC 15.247

Project number: G0M-1812-7889
 Applicant: Leica Geosystems AG
 EUT Name: Field Controller Win EC7
 Model: CS20
 Test Site: Eurofins Product Service GmbH
 Operator: Wilfried Treffke
 Test Conditions: Tnom: 22°C, Vnom: 120V AC (intern 11.1 V DC)
 Antenna: Schwarzbeck BBHA 9120D, Horizontal
 Measurement distance: 1 m converted to 3m
 Mode: TX; GFSK; DH5;2441 MHz
 Test Date: 2019-02-06
 Note:

Index 20

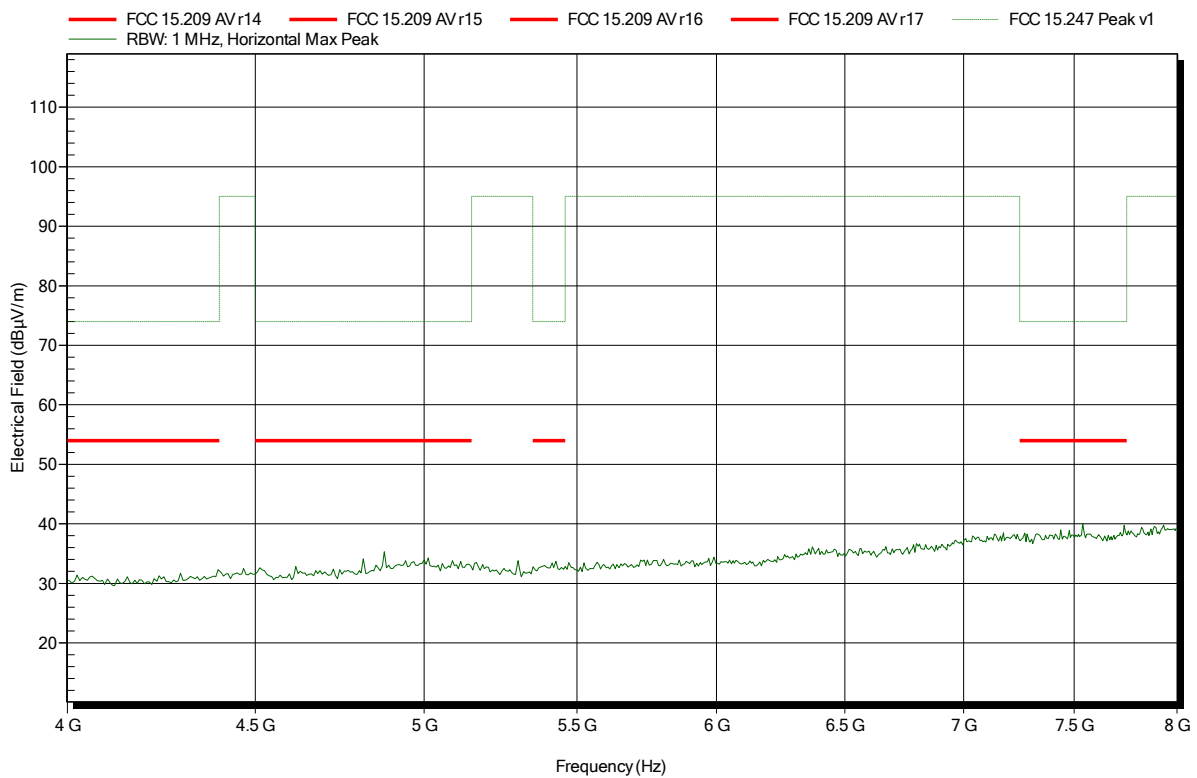

Spurious emissions according to FCC 15.247

Project number: G0M-1812-7889
 Applicant: Leica Geosystems AG
 EUT Name: Field Controller Win EC7
 Model: CS20
 Test Site: Eurofins Product Service GmbH
 Operator: Wilfried Treffke
 Test Conditions: Tnom: 22°C, Vnom: 120V AC (intern 11.1 V DC)
 Antenna: Schwarzbeck BBHA 9120D, Vertical
 Measurement distance: 1 m converted to 3m
 Mode: TX; GFSK; DH5;2441 MHz
 Test Date: 2019-02-06
 Note:

Index 24

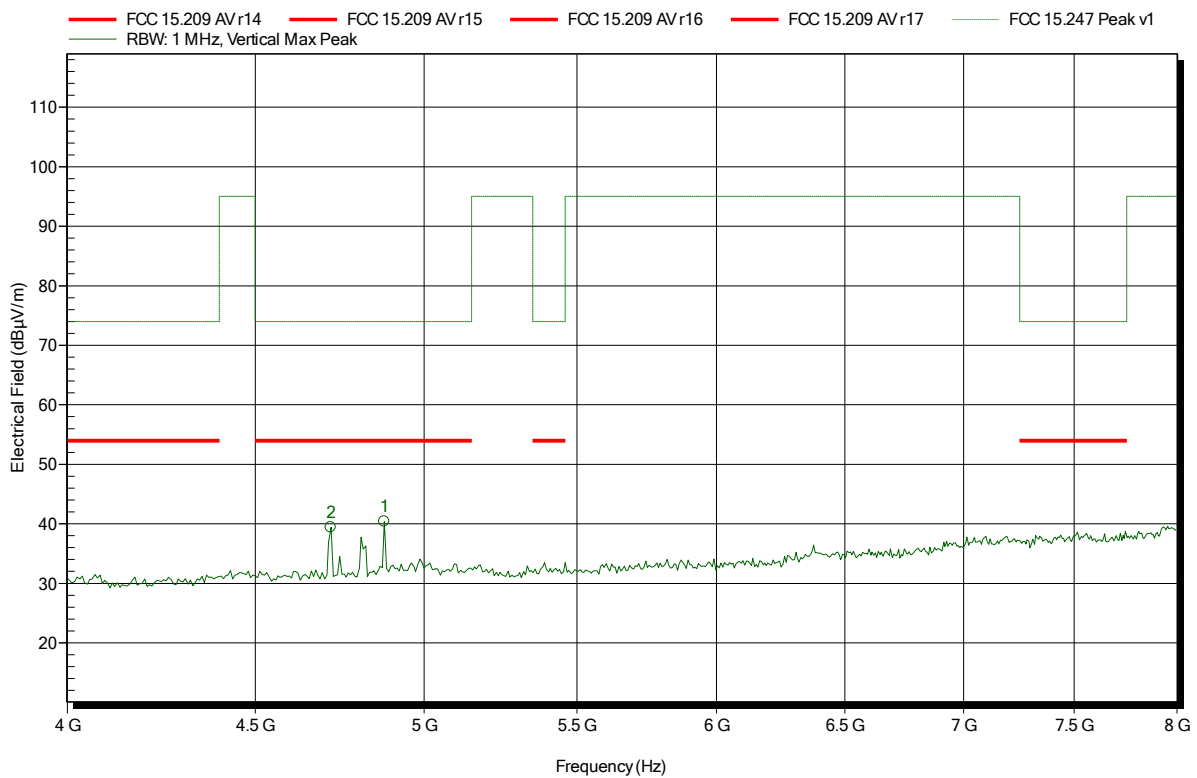

Frequency	Peak	Peak Limit	Peak Difference	Peak Status
4.717 GHz	39.42 dBµV/m	74 dBµV/m	-34.58 dB	Pass
4.877 GHz	40.38 dBµV/m	74 dBµV/m	-33.62 dB	Pass

Spurious emissions according to FCC 15.247

Project number: G0M-1812-7889
 Applicant: Leica Geosystems AG
 EUT Name: Field Controller Win EC7
 Model: CS20
 Test Site: Eurofins Product Service GmbH
 Operator: Wilfried Treffke
 Test Conditions: Tnom: 22°C, Vnom: 120V AC (intern 11.1 V DC)
 Antenna: Schwarzbeck BBHA 9120D, Horizontal
 Measurement distance: 1 m converted to 3m
 Mode: TX; GFSK; DH5;2441 MHz
 Test Date: 2019-02-06
 Note:

Index 21

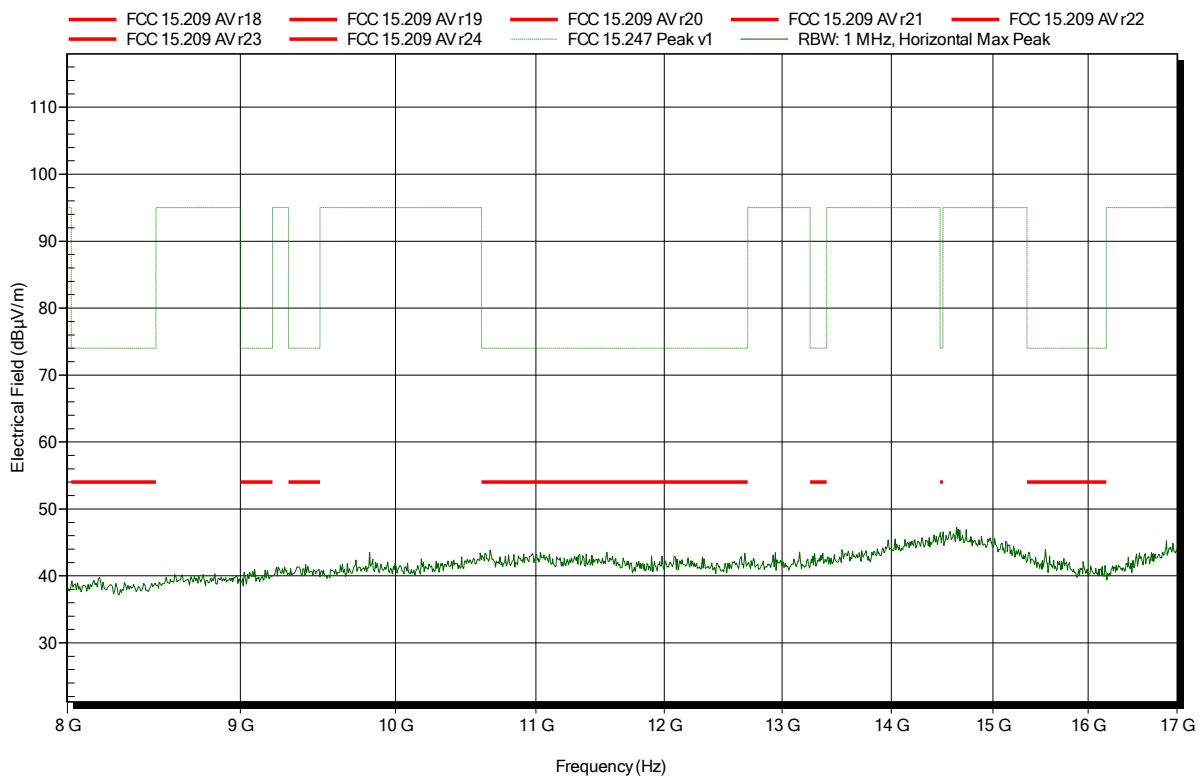

Spurious emissions according to FCC 15.247

Project number: G0M-1812-7889
 Applicant: Leica Geosystems AG
 EUT Name: Field Controller Win EC7
 Model: CS20
 Test Site: Eurofins Product Service GmbH
 Operator: Wilfried Treffke
 Test Conditions: Tnom: 22°C, Vnom: 120V AC (intern 11.1 V DC)
 Antenna: Schwarzbeck BBHA 9120D, Vertical
 Measurement distance: 1 m converted to 3m
 Mode: TX; GFSK; DH5;2441 MHz
 Test Date: 2019-02-06
 Note:

Index 25

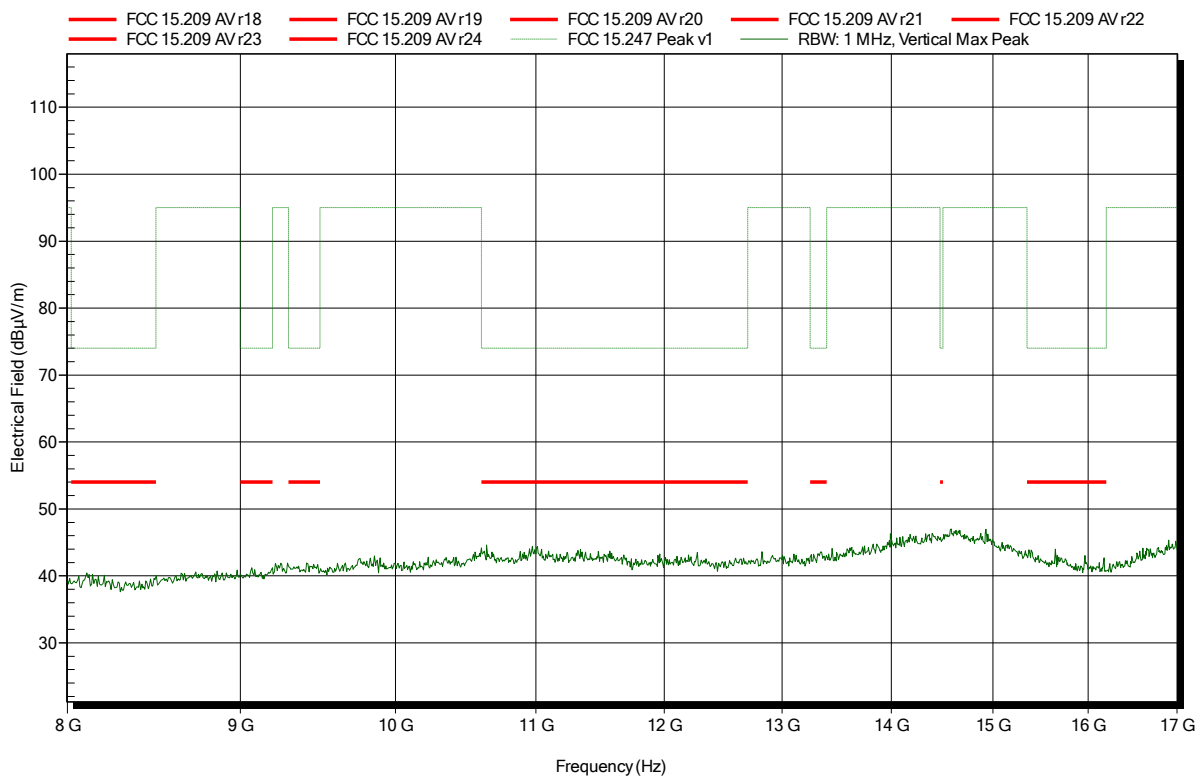

Spurious emissions according to FCC 15.247

Project number: G0M-1812-7889
 Applicant: Leica Geosystems AG
 EUT Name: Field Controller Win EC7
 Model: CS20
 Test Site: Eurofins Product Service GmbH
 Operator: Wilfried Treffke
 Test Conditions: Tnom: 22°C, Vnom: 120V AC (intern 11.1 V DC)
 Antenna: Amplifier Research AT4560, Horizontal
 Measurement distance: 1 m converted to 3m
 Mode: TX; GFSK; DH5;2441 MHz
 Test Date: 2019-02-06
 Note:

Index 22

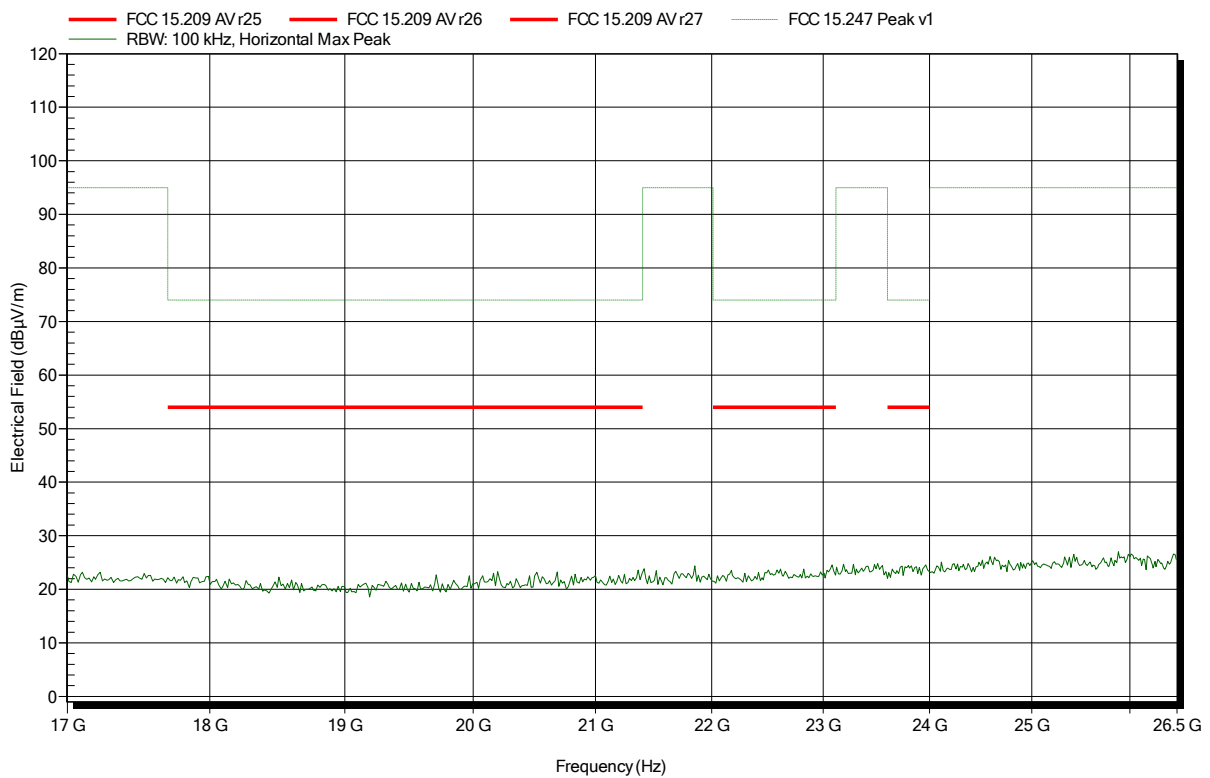

Spurious emissions according to FCC 15.247

Project number: G0M-1812-7889
 Applicant: Leica Geosystems AG
 EUT Name: Field Controller Win EC7
 Model: CS20
 Test Site: Eurofins Product Service GmbH
 Operator: Wilfried Treffke
 Test Conditions: Tnom: 22°C, Vnom: 120V AC (intern 11.1 V DC)
 Antenna: Amplifier Research AT4560, Vertical
 Measurement distance: 1 m converted to 3m
 Mode: TX; GFSK; DH5;2441 MHz
 Test Date: 2019-02-06
 Note:

Index 26

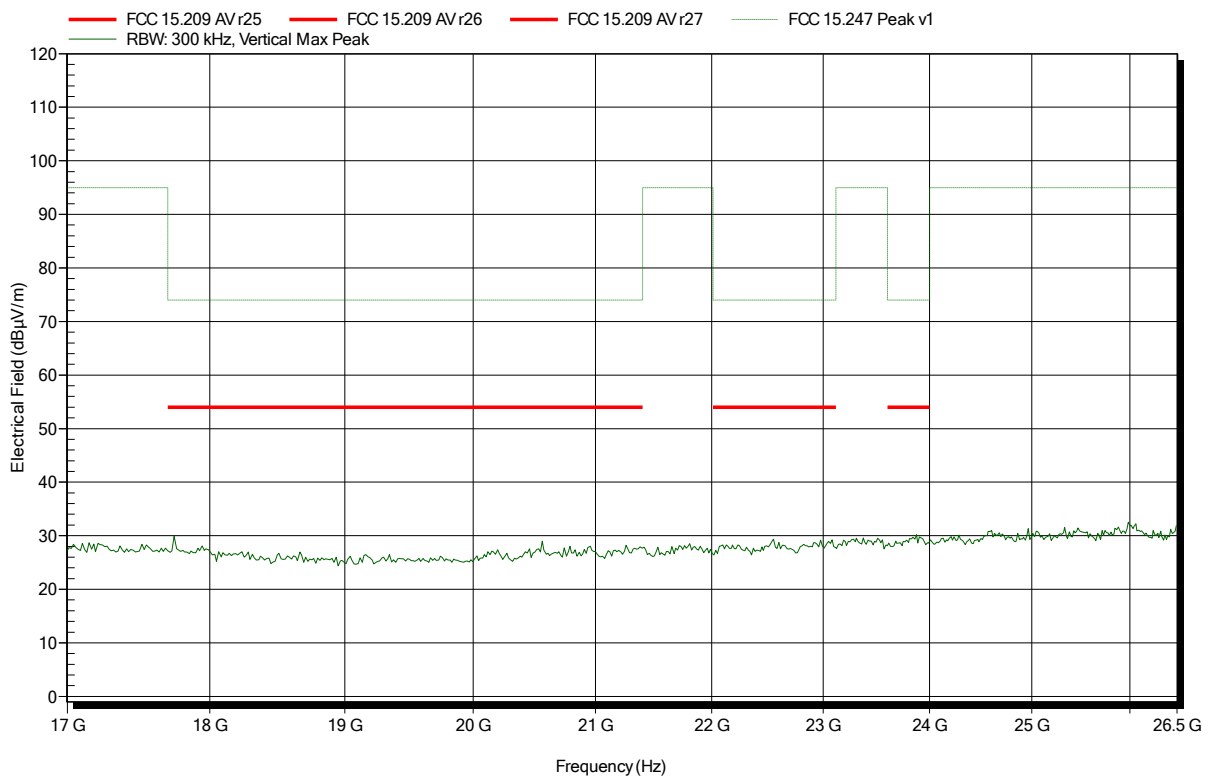

Spurious emissions according to FCC 15.247

Project number: G0M-1812-7889
 Applicant: Leica Geosystems AG
 EUT Name: Field Controller Win EC7
 Model: CS20
 Test Site: Eurofins Product Service GmbH
 Operator: Wilfried Treffke
 Test Conditions: Tnom: 22°C, Vnom: 120V AC (intern 11.1 V DC)
 Antenna: Schwarzbeck BBHA 9120D, Horizontal
 Measurement distance: 1 m converted to 3m
 Mode: TX; GFSK; DH5; 2480 MHz
 Test Date: 2019-02-06
 Note:

Index 32

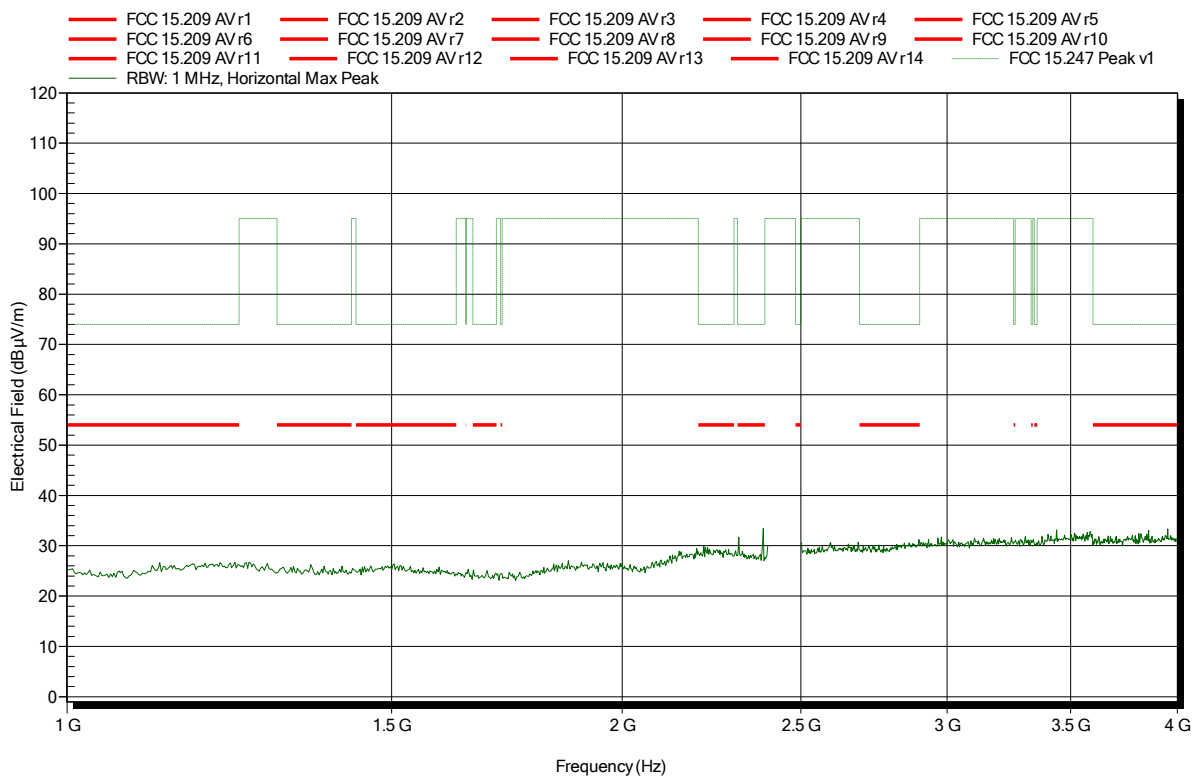

Spurious emissions according to FCC 15.247

Project number: G0M-1812-7889
 Applicant: Leica Geosystems AG
 EUT Name: Field Controller Win EC7
 Model: CS20
 Test Site: Eurofins Product Service GmbH
 Operator: Wilfried Treffke
 Test Conditions: Tnom: 22°C, Vnom: 120V AC (intern 11.1 V DC)
 Antenna: Schwarzbeck BBHA 9120D, Vertical
 Measurement distance: 1 m converted to 3m
 Mode: TX; GFSK; DH5; 2480 MHz
 Test Date: 2019-02-06
 Note:

Index 27

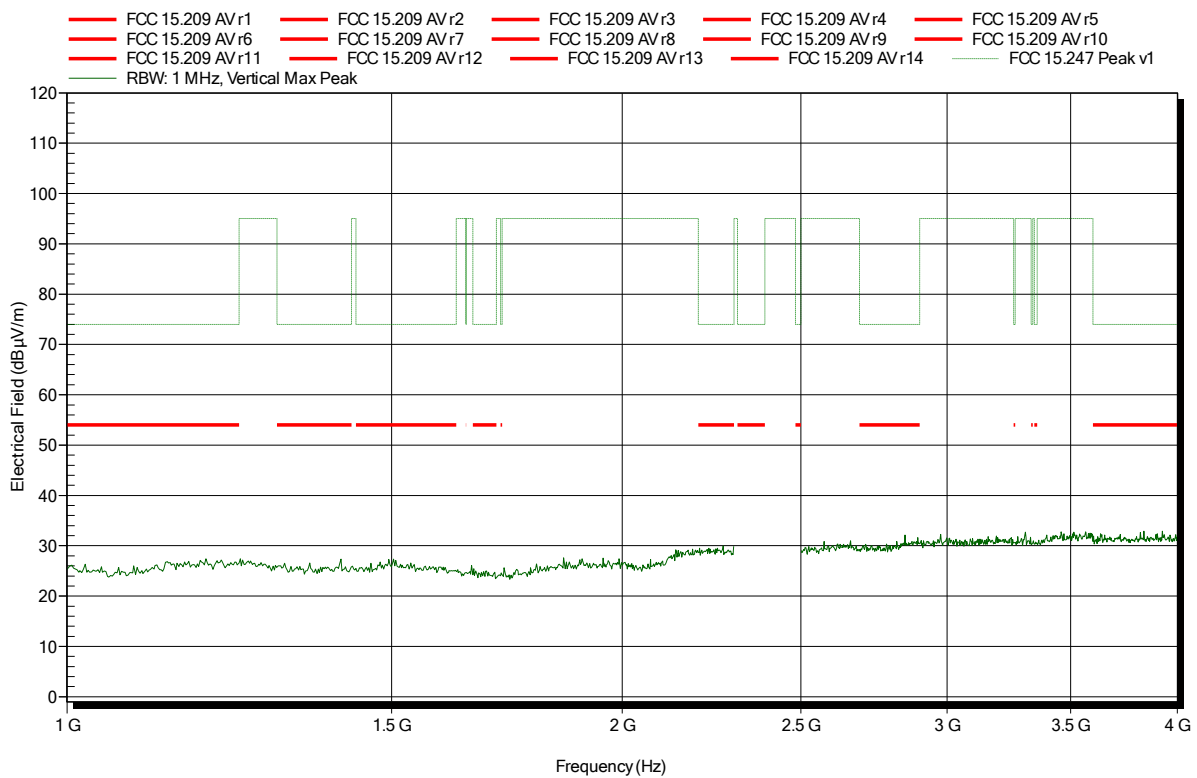

Spurious emissions according to FCC 15.247

Project number: G0M-1812-7889
 Applicant: Leica Geosystems AG
 EUT Name: Field Controller Win EC7
 Model: CS20
 Test Site: Eurofins Product Service GmbH
 Operator: Wilfried Treffke
 Test Conditions: Tnom: 22°C, Vnom: 120V AC (intern 11.1 V DC)
 Antenna: Schwarzbeck BBHA 9120D, Horizontal
 Measurement distance: 1 m converted to 3m
 Mode: TX; GFSK; DH5; 2480 MHz
 Test Date: 2019-02-06
 Note: lower bandedge

Index 33

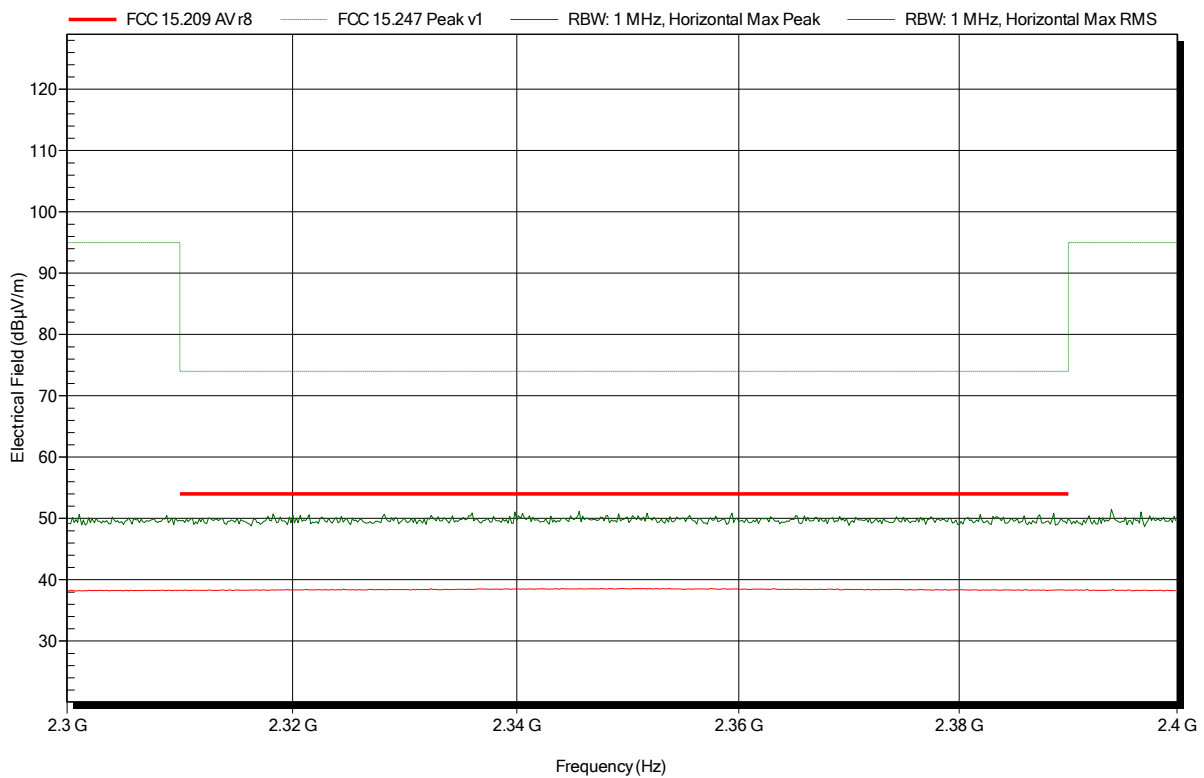

Spurious emissions according to FCC 15.247

Project number: G0M-1812-7889
 Applicant: Leica Geosystems AG
 EUT Name: Field Controller Win EC7
 Model: CS20
 Test Site: Eurofins Product Service GmbH
 Operator: Wilfried Treffke
 Test Conditions: Tnom: 22°C, Vnom: 120V AC (intern 11.1 V DC)
 Antenna: Schwarzbeck BBHA 9120D, Vertical
 Measurement distance: 1 m converted to 3m
 Mode: TX; GFSK; DH5; 2480 MHz
 Test Date: 2019-02-06
 Note: upper bandedge

Index 28

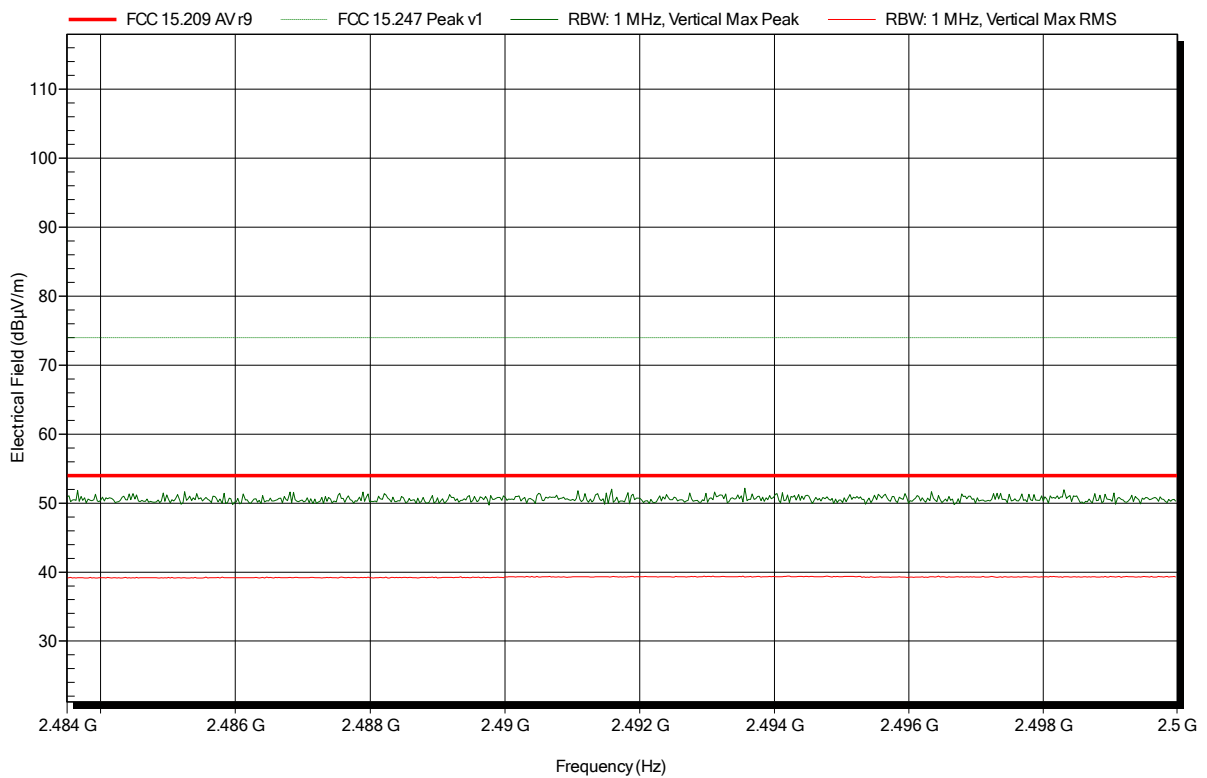

Spurious emissions according to FCC 15.247

Project number: G0M-1812-7889
 Applicant: Leica Geosystems AG
 EUT Name: Field Controller Win EC7
 Model: CS20
 Test Site: Eurofins Product Service GmbH
 Operator: Wilfried Treffke
 Test Conditions: Tnom: 22°C, Vnom: 120V AC (intern 11.1 V DC)
 Antenna: Schwarzbeck BBHA 9120D, Horizontal
 Measurement distance: 1 m converted to 3m
 Mode: TX; GFSK; DH5; 2480 MHz
 Test Date: 2019-02-06
 Note:

Index 34

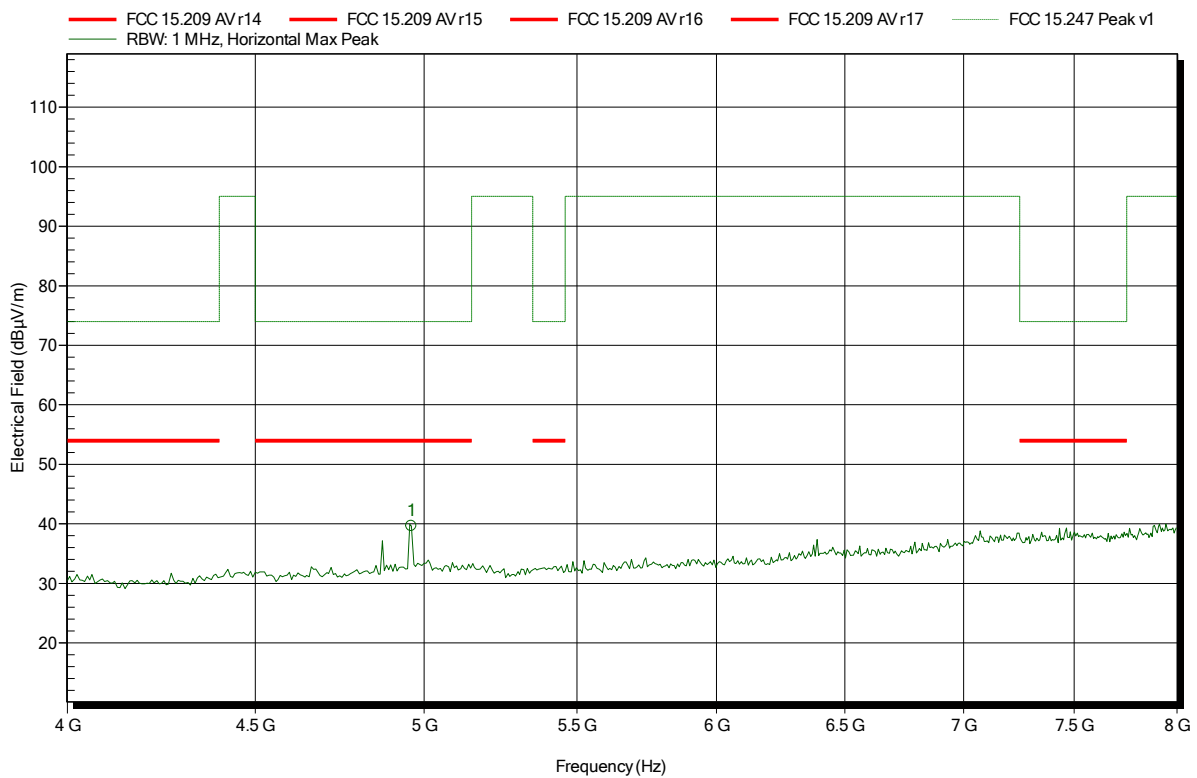

Frequency	Peak	Peak Limit	Peak Difference	Peak Status
4.96 GHz	39.63 dBµV/m	74 dBµV/m	-34.37 dB	Pass

Spurious emissions according to FCC 15.247

Project number: G0M-1812-7889
 Applicant: Leica Geosystems AG
 EUT Name: Field Controller Win EC7
 Model: CS20
 Test Site: Eurofins Product Service GmbH
 Operator: Wilfried Treffke
 Test Conditions: Tnom: 22°C, Vnom: 120V AC (intern 11.1 V DC)
 Antenna: Schwarzbeck BBHA 9120D, Vertical
 Measurement distance: 1 m converted to 3m
 Mode: TX; GFSK; DH5; 2480 MHz
 Test Date: 2019-02-06
 Note:

Index 29

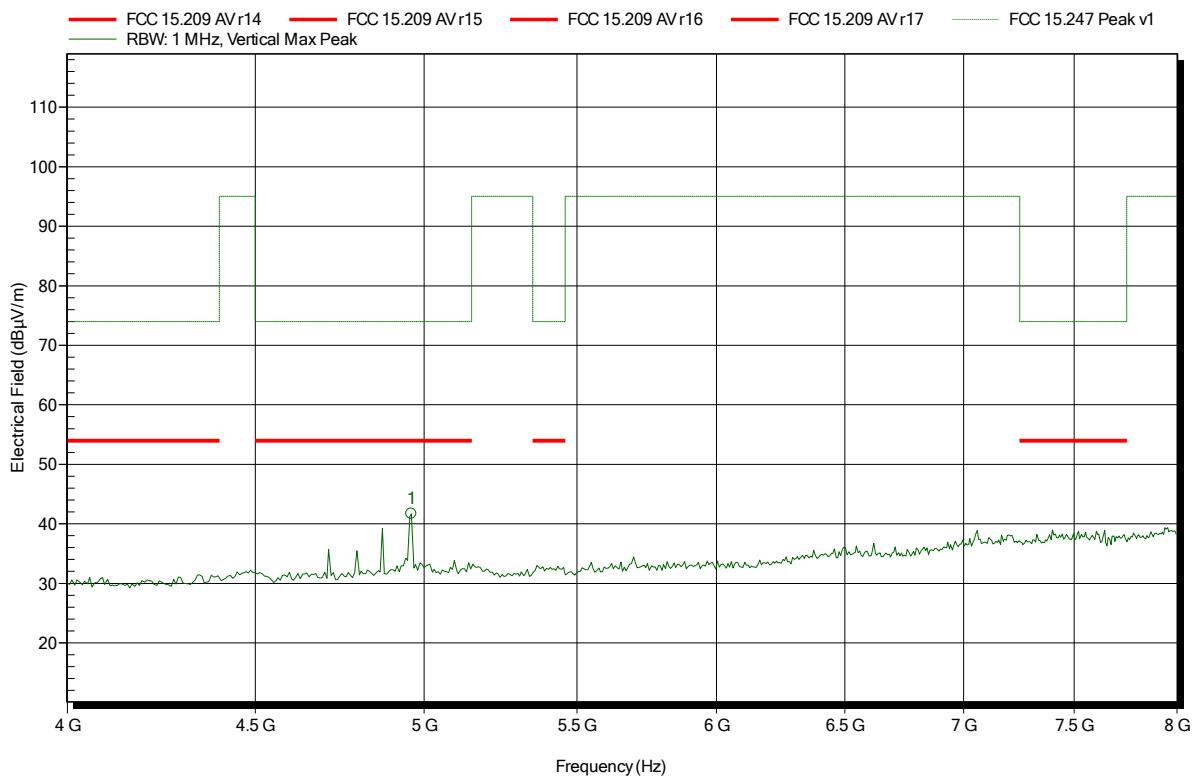

Frequency	Peak	Peak Limit	Peak Difference	Peak Status
4.96 GHz	41.67 dBµV/m	74 dBµV/m	-32.33 dB	Pass

Spurious emissions according to FCC 15.247

Project number: G0M-1812-7889
 Applicant: Leica Geosystems AG
 EUT Name: Field Controller Win EC7
 Model: CS20
 Test Site: Eurofins Product Service GmbH
 Operator: Wilfried Treffke
 Test Conditions: Tnom: 22°C, Vnom: 120V AC (intern 11.1 V DC)
 Antenna: Schwarzbeck BBHA 9120D, Horizontal
 Measurement distance: 1 m converted to 3m
 Mode: TX; GFSK; DH5; 2480 MHz
 Test Date: 2019-02-06
 Note:

Index 35

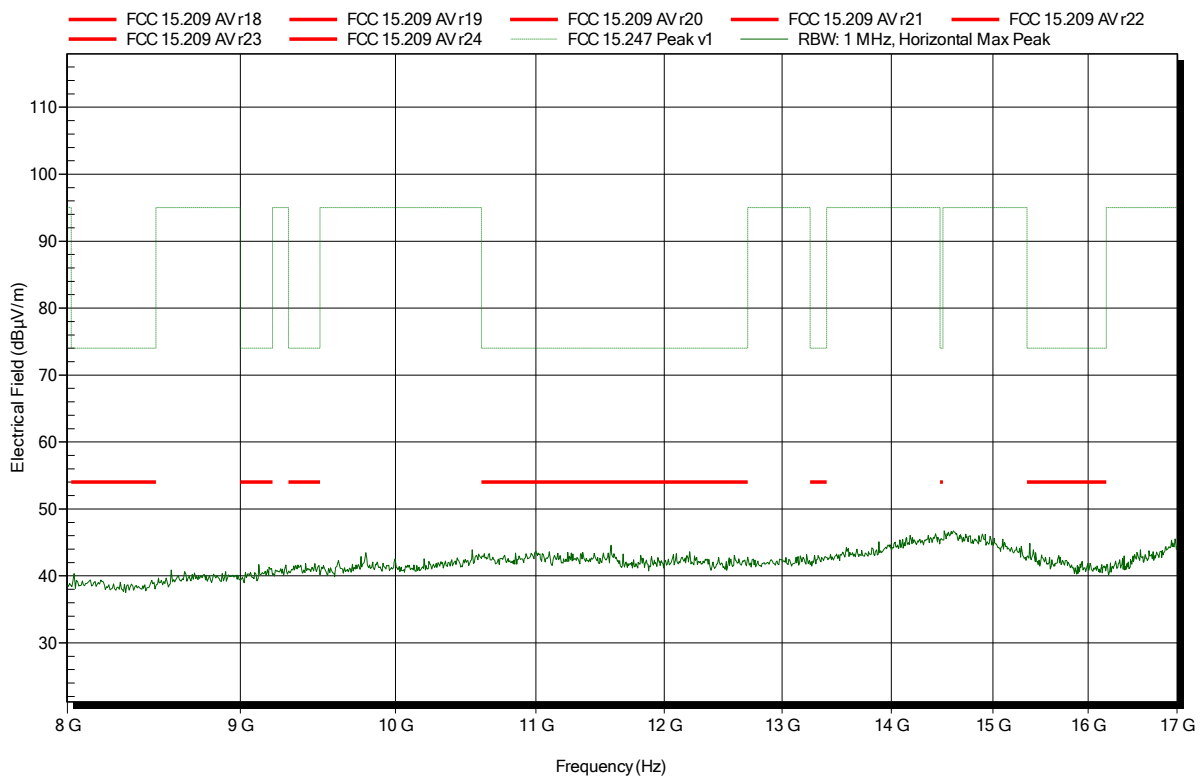

Spurious emissions according to FCC 15.247

Project number: G0M-1812-7889
 Applicant: Leica Geosystems AG
 EUT Name: Field Controller Win EC7
 Model: CS20
 Test Site: Eurofins Product Service GmbH
 Operator: Wilfried Treffke
 Test Conditions: Tnom: 22°C, Vnom: 120V AC (intern 11.1 V DC)
 Antenna: Schwarzbeck BBHA 9120D, Vertical
 Measurement distance: 1 m converted to 3m
 Mode: TX; GFSK; DH5; 2480 MHz
 Test Date: 2019-02-06
 Note:

Index 30

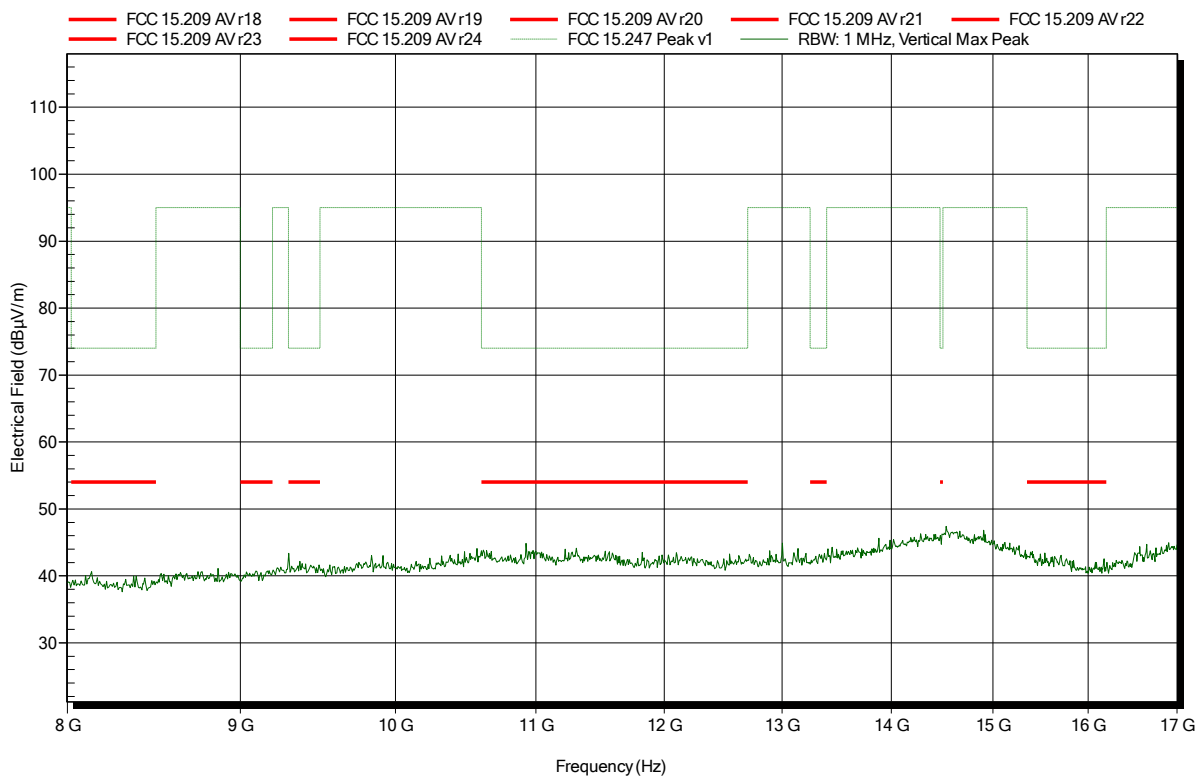

Spurious emissions according to FCC 15.247

Project number: G0M-1812-7889
 Applicant: Leica Geosystems AG
 EUT Name: Field Controller Win EC7
 Model: CS20
 Test Site: Eurofins Product Service GmbH
 Operator: Wilfried Treffke
 Test Conditions: Tnom: 22°C, Vnom: 120V AC (intern 11.1 V DC)
 Antenna: Amplifier Research AT4560, Horizontal
 Measurement distance: 1 m converted to 3m
 Mode: TX; GFSK; DH5; 2480 MHz
 Test Date: 2019-02-06
 Note:

Index 36

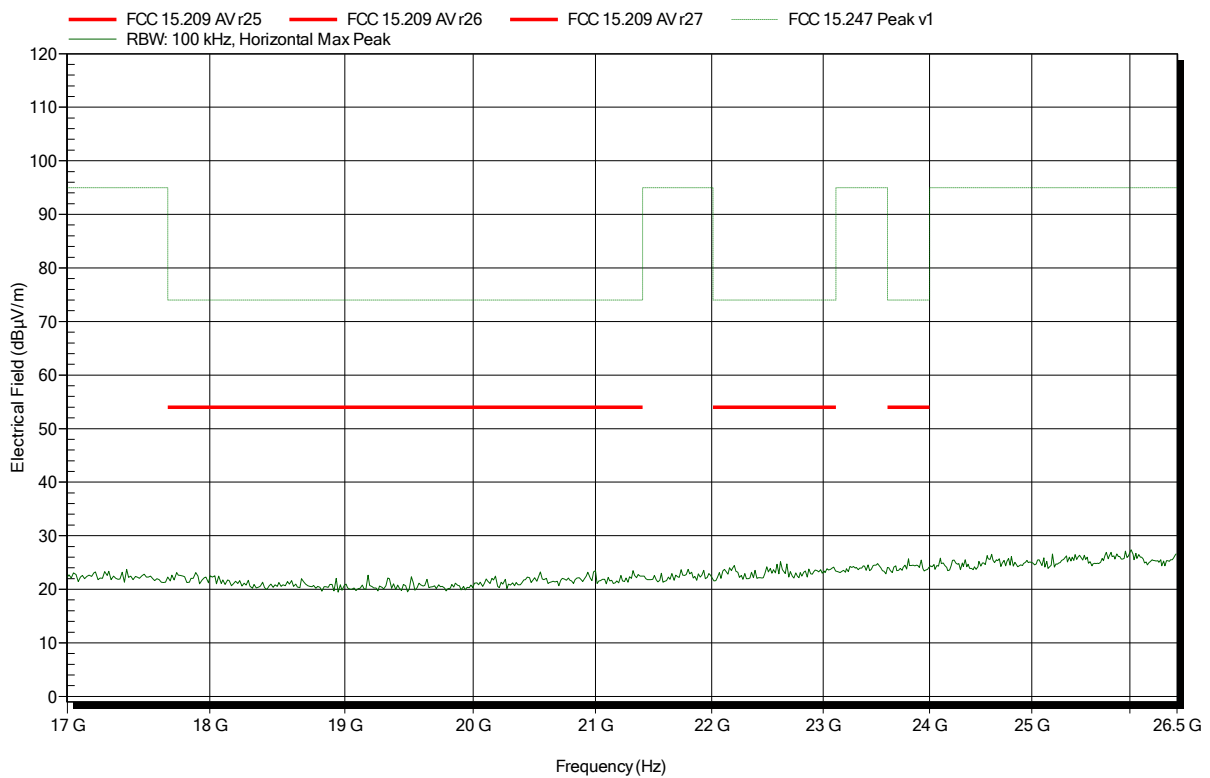

Spurious emissions according to FCC 15.247

Project number: G0M-1812-7889
 Applicant: Leica Geosystems AG
 EUT Name: Field Controller Win EC7
 Model: CS20
 Test Site: Eurofins Product Service GmbH
 Operator: Wilfried Treffke
 Test Conditions: Tnom: 22°C, Vnom: 120V AC (intern 11.1 V DC)
 Antenna: Amplifier Research AT4560, Vertical
 Measurement distance: 1 m converted to 3m
 Mode: TX; GFSK; DH5; 2480 MHz
 Test Date: 2019-02-06
 Note:

Index 31

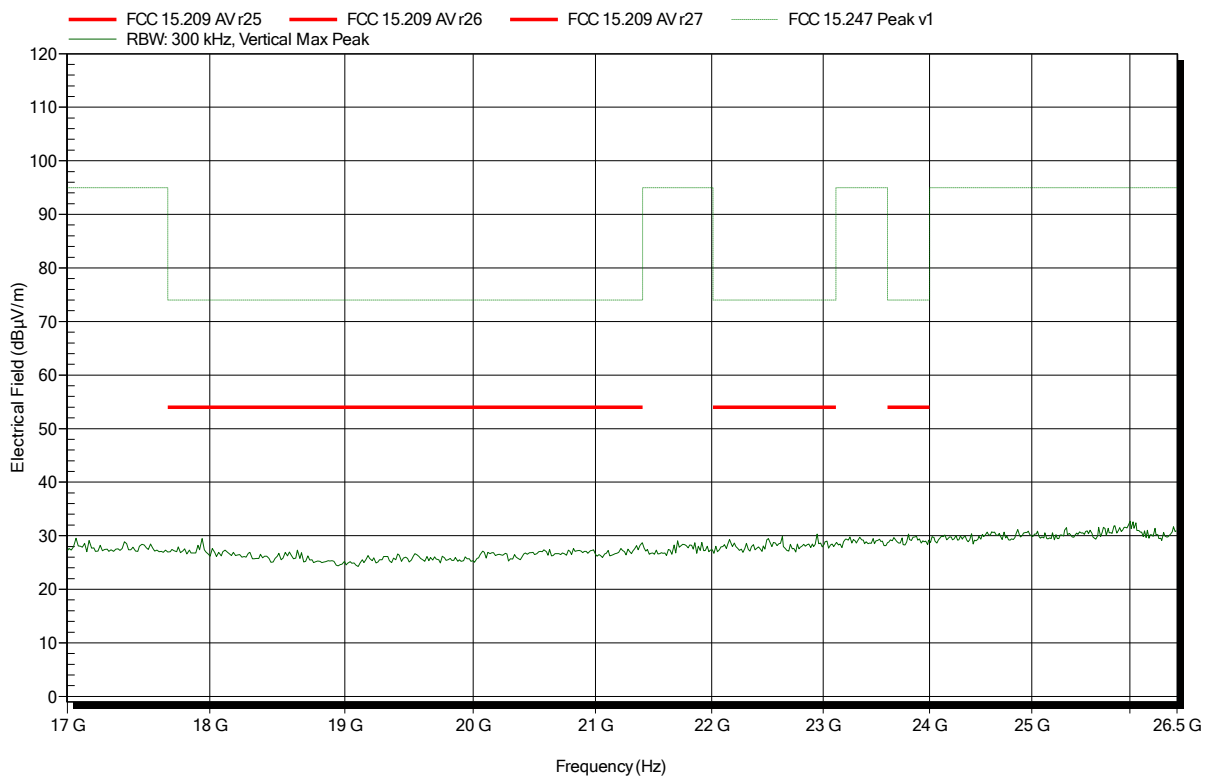

ANNEX B Receiver spurious emissions

Spurious emissions according to RSS-247 Issue 2

Project number: G0M-1812-7889
 Applicant: Leica Geosystems AG
 EUT Name: Field Controller Win EC7
 Model: CS20
 Test Site: Eurofins Product Service GmbH
 Operator: Wilfried Treffke
 Test Conditions: Tnom: 22°C, Vnom: 120V AC (intern 11.1 V DC)
 Antenna: Rohde & Schwarz HK 116, Horizontal
 Measurement distance: 3 m
 Mode: RX; Bluetooth; scan mode
 Test Date: 2019-02-06
 Note:

Index 41

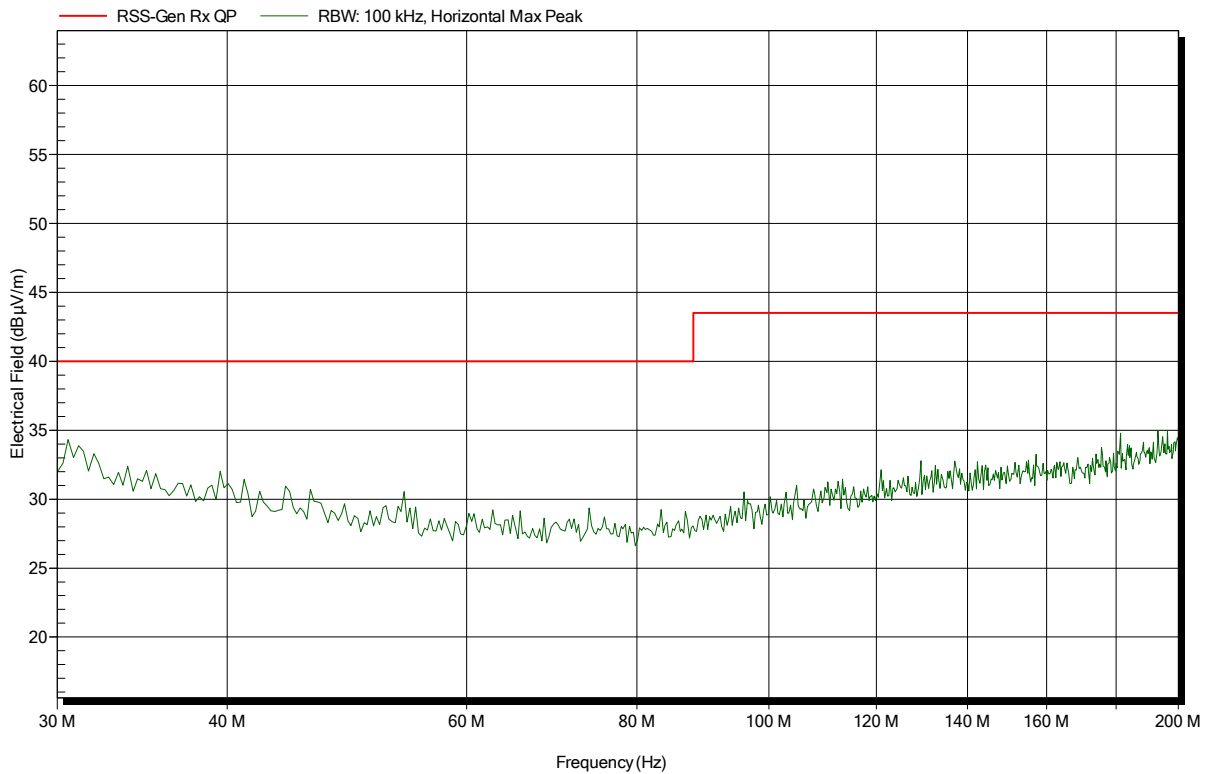

Spurious emissions according to RSS-247 Issue 2

Project number: G0M-1812-7889
 Applicant: Leica Geosystems AG
 EUT Name: Field Controller Win EC7
 Model: CS20
 Test Site: Eurofins Product Service GmbH
 Operator: Wilfried Treffke
 Test Conditions: Tnom: 22°C, Vnom: 120V AC (intern 11.1 V DC)
 Antenna: Rohde & Schwarz HK 116, Vertical
 Measurement distance: 3 m
 Mode: RX; Bluetooth; scan mode
 Test Date: 2019-02-06
 Note:

Index 42

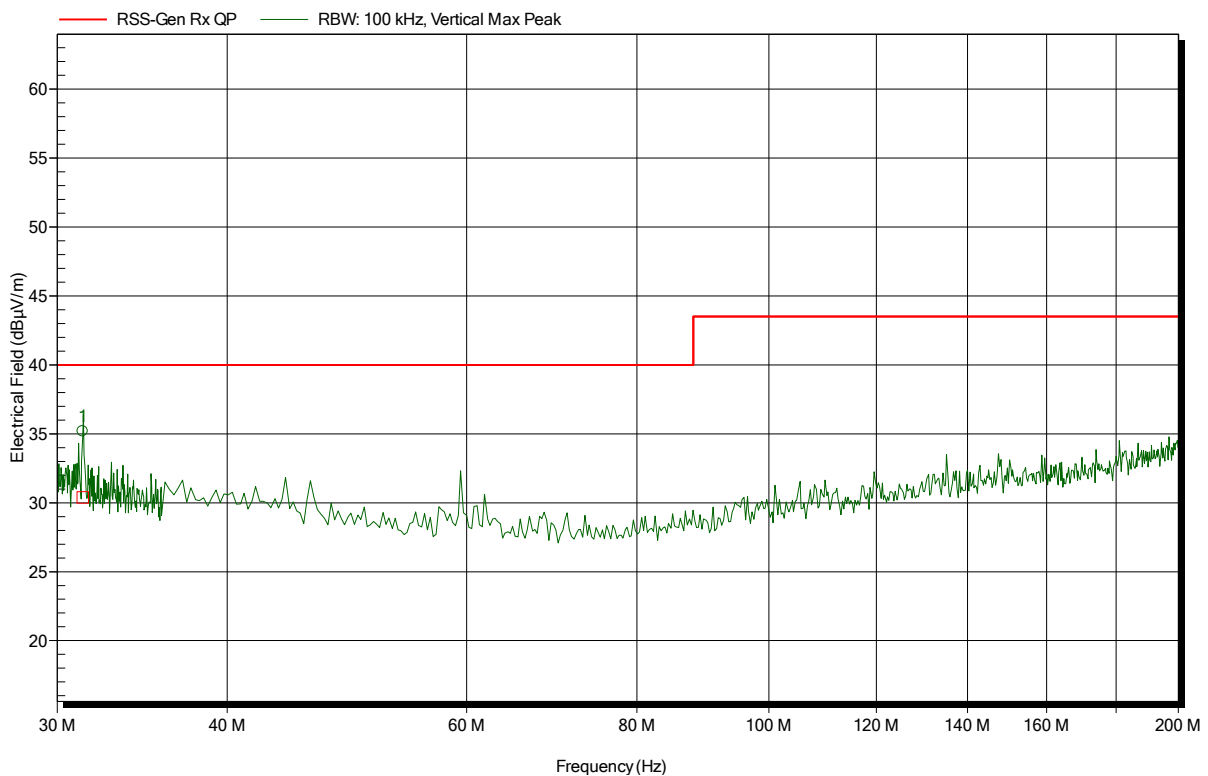

Frequency	Peak	Peak Limit	Peak Difference	Status	Angle	Height
31.335 MHz	35.19 dBµV/m	40 dBµV/m	-4.81 dB	Pass	60 Degree	1.2 m

Frequency	Quasi-Peak	Quasi-Peak Limit	Quasi-Peak Difference	Quasi-Peak Status	Angle	Height
31.335 MHz	30.4 dBµV/m	40 dBµV/m	-9.6 dB	Pass	60 Degree	1.2 m

Spurious emissions according to RSS-247 Issue 2

Project number: G0M-1812-7889
 Applicant: Leica Geosystems AG
 EUT Name: Field Controller Win EC7
 Model: CS20
 Test Site: Eurofins Product Service GmbH
 Operator: Wilfried Treffke
 Test Conditions: Tnom: 22°C, Vnom: 120V AC (intern 11.1 V DC)
 Antenna: Rohde & Schwarz HL 223, Horizontal
 Measurement distance: 3 m
 Mode: RX; Bluetooth; scan mode
 Test Date: 2019-02-06
 Note:

Index 43

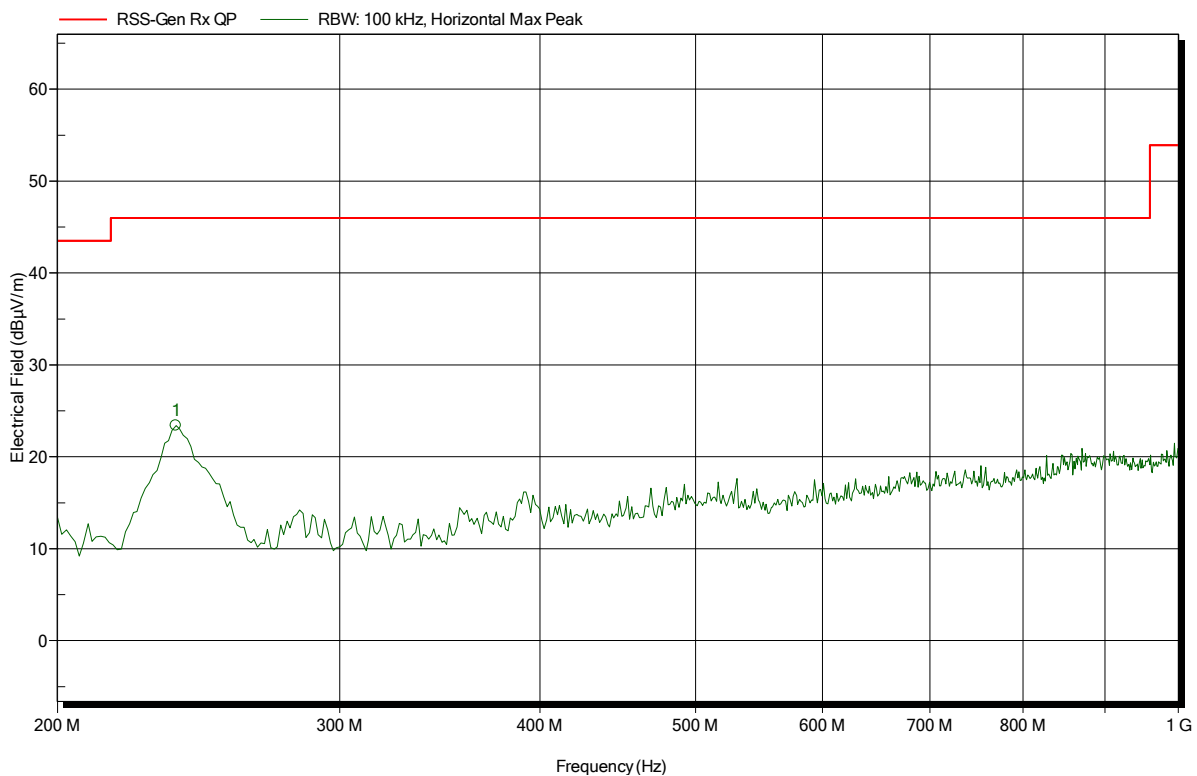

Frequency	Peak	Peak Limit	Peak Difference	Status	Angle	Height
237.12 MHz	23.38 dBµV/m	46 dBµV/m	-22.62 dB	Pass	270 Degree	1.2 m

Frequency	Angle	Height
237.12 MHz	270 Degree	1.2 m

Spurious emissions according to RSS-247 Issue 2

Project number: G0M-1812-7889
 Applicant: Leica Geosystems AG
 EUT Name: Field Controller Win EC7
 Model: CS20
 Test Site: Eurofins Product Service GmbH
 Operator: Wilfried Treffke
 Test Conditions: Tnom: 22°C, Vnom: 120V AC (intern 11.1 V DC)
 Antenna: Rohde & Schwarz HL 223, Vertical
 Measurement distance: 3 m
 Mode: RX; Bluetooth; scan mode
 Test Date: 2019-02-06
 Note:

Index 44

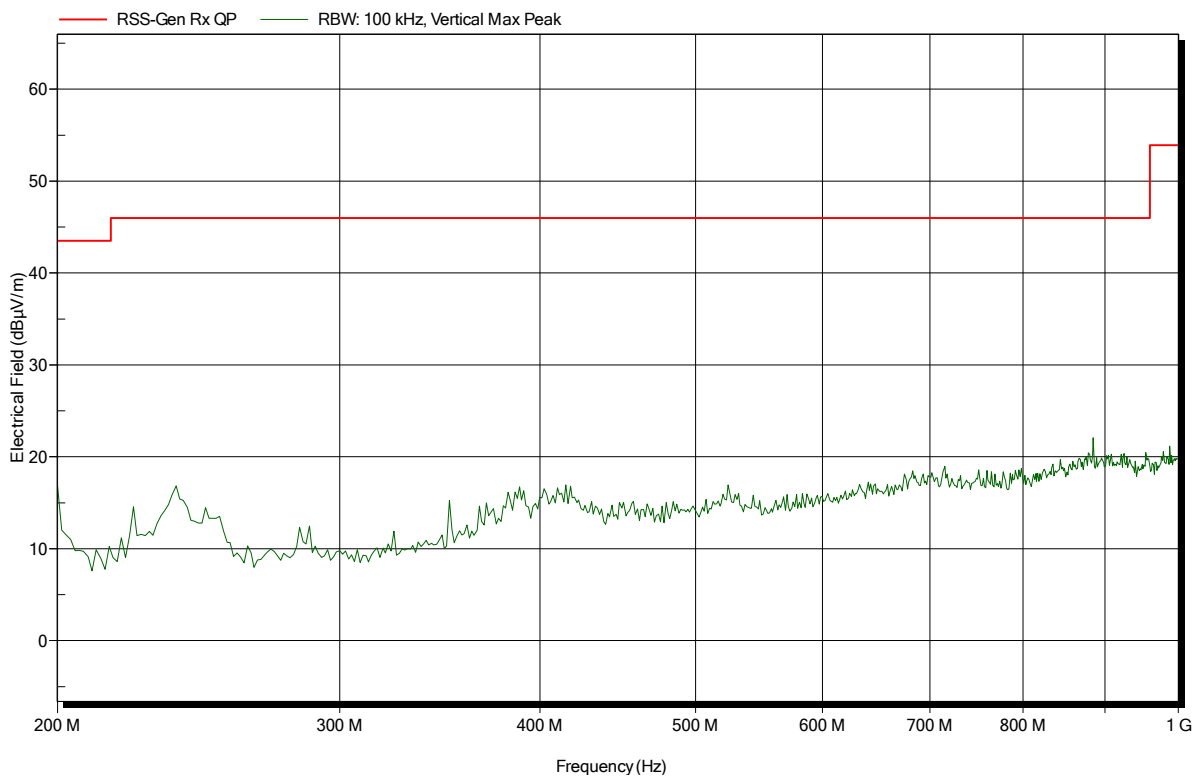

Spurious emissions according to RSS-247 Issue 2

Project number: G0M-1812-7889
 Applicant: Leica Geosystems AG
 EUT Name: Field Controller Win EC7
 Model: CS20
 Test Site: Eurofins Product Service GmbH
 Operator: Wilfried Treffke
 Test Conditions: Tnom: 22°C, Vnom: 120V AC (intern 11.1 V DC)
 Antenna: Schwarzbeck BBHA 9120D, Horizontal
 Measurement distance: 3 m
 Mode: RX; Bluetooth; scan mode
 Test Date: 2019-02-06
 Note:

Index 45

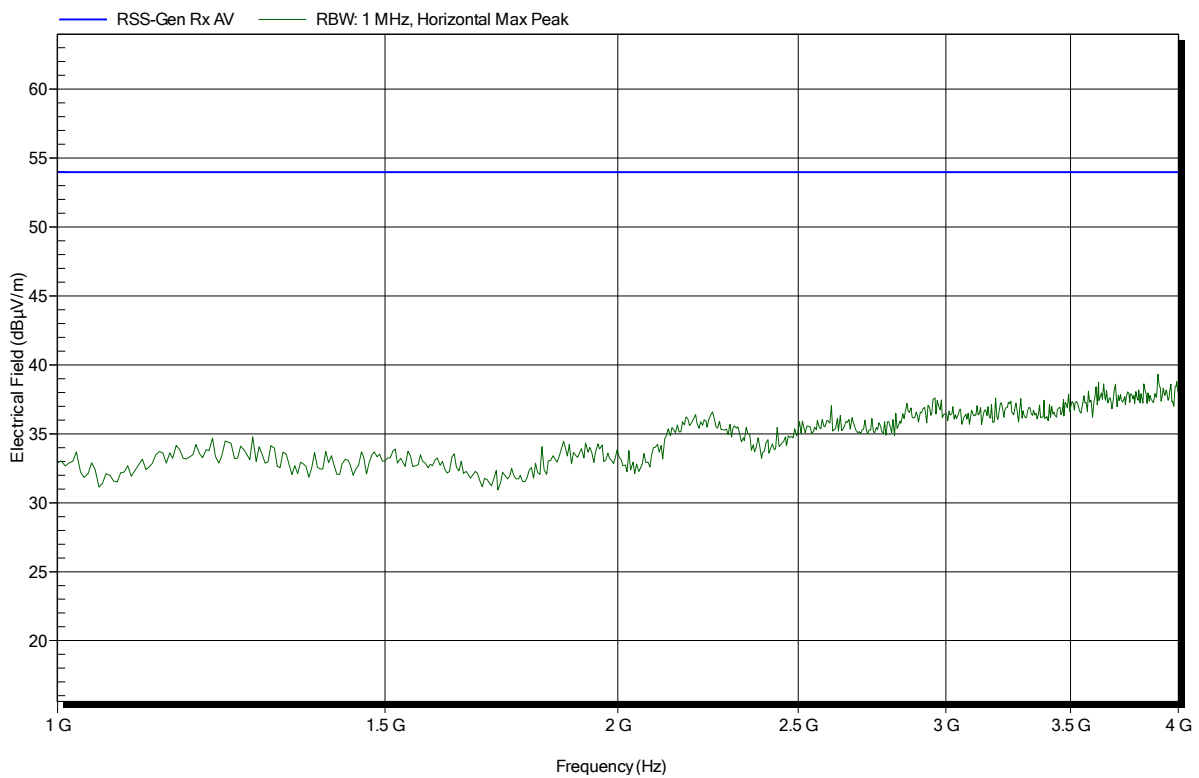

Spurious emissions according to RSS-247 Issue 2

Project number: G0M-1812-7889
 Applicant: Leica Geosystems AG
 EUT Name: Field Controller Win EC7
 Model: CS20
 Test Site: Eurofins Product Service GmbH
 Operator: Wilfried Treffke
 Test Conditions: Tnom: 22°C, Vnom: 120V AC (intern 11.1 V DC)
 Antenna: Schwarzbeck BBHA 9120D, Vertical
 Measurement distance: 3 m
 Mode: RX; Bluetooth; scan mode
 Test Date: 2019-02-06
 Note:

Index 48

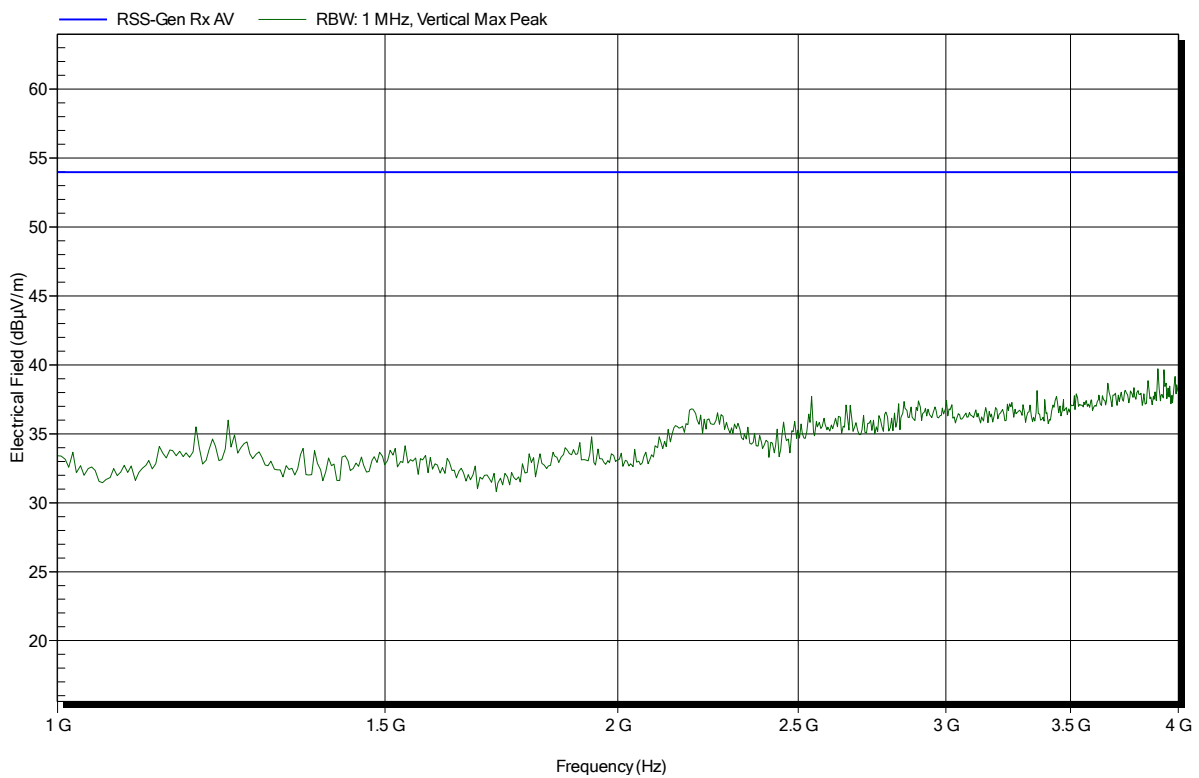

Spurious emissions according to RSS-247 Issue 2

Project number: G0M-1812-7889
 Applicant: Leica Geosystems AG
 EUT Name: Field Controller Win EC7
 Model: CS20
 Test Site: Eurofins Product Service GmbH
 Operator: Wilfried Treffke
 Test Conditions: Tnom: 22°C, Vnom: 120V AC (intern 11.1 V DC)
 Antenna: Schwarzbeck BBHA 9120D, Horizontal
 Measurement distance: 1 m
 Mode: RX; Bluetooth; scan mode
 Test Date: 2019-02-06
 Note:

Index 46

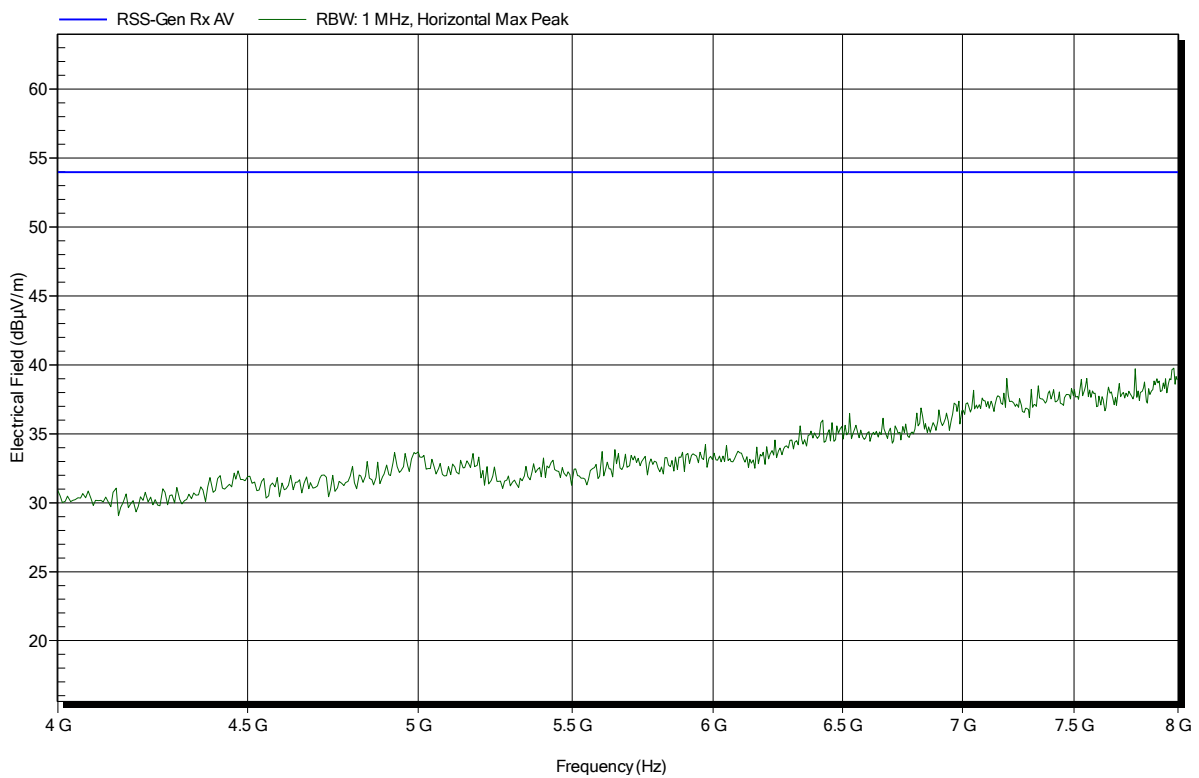

Spurious emissions according to RSS-247 Issue 2

Project number: G0M-1812-7889
 Applicant: Leica Geosystems AG
 EUT Name: Field Controller Win EC7
 Model: CS20
 Test Site: Eurofins Product Service GmbH
 Operator: Wilfried Treffke
 Test Conditions: Tnom: 22°C, Vnom: 120V AC (intern 11.1 V DC)
 Antenna: Schwarzbeck BBHA 9120D, Vertical
 Measurement distance: 1 m
 Mode: RX; Bluetooth; scan mode
 Test Date: 2019-02-06
 Note:

Index 49

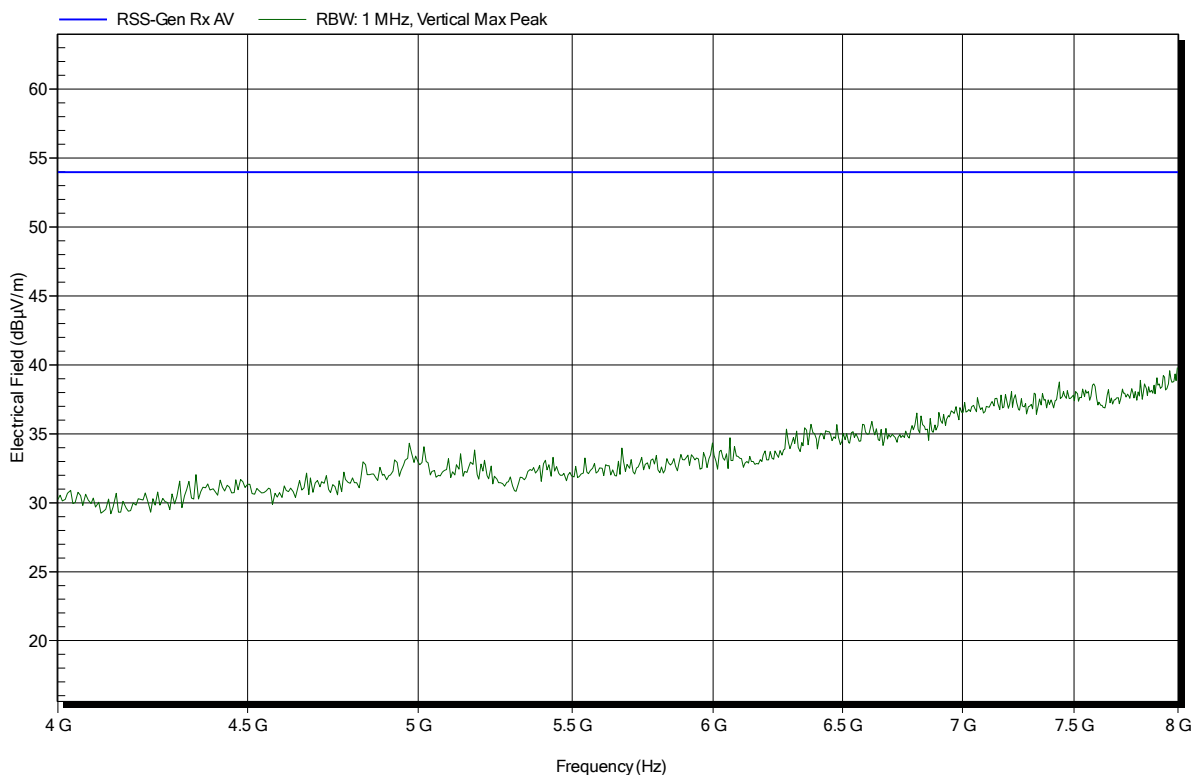

Spurious emissions according to RSS-247 Issue 2

Project number: G0M-1812-7889
 Applicant: Leica Geosystems AG
 EUT Name: Field Controller Win EC7
 Model: CS20
 Test Site: Eurofins Product Service GmbH
 Operator: Wilfried Treffke
 Test Conditions: Tnom: 22°C, Vnom: 120V AC (intern 11.1 V DC)
 Antenna: Schwarzbeck BBHA 9120D, Horizontal
 Measurement distance: 1 m converted to 3m
 Mode: RX; Bluetooth; scan mode
 Test Date: 2019-02-06
 Note:

Index 47

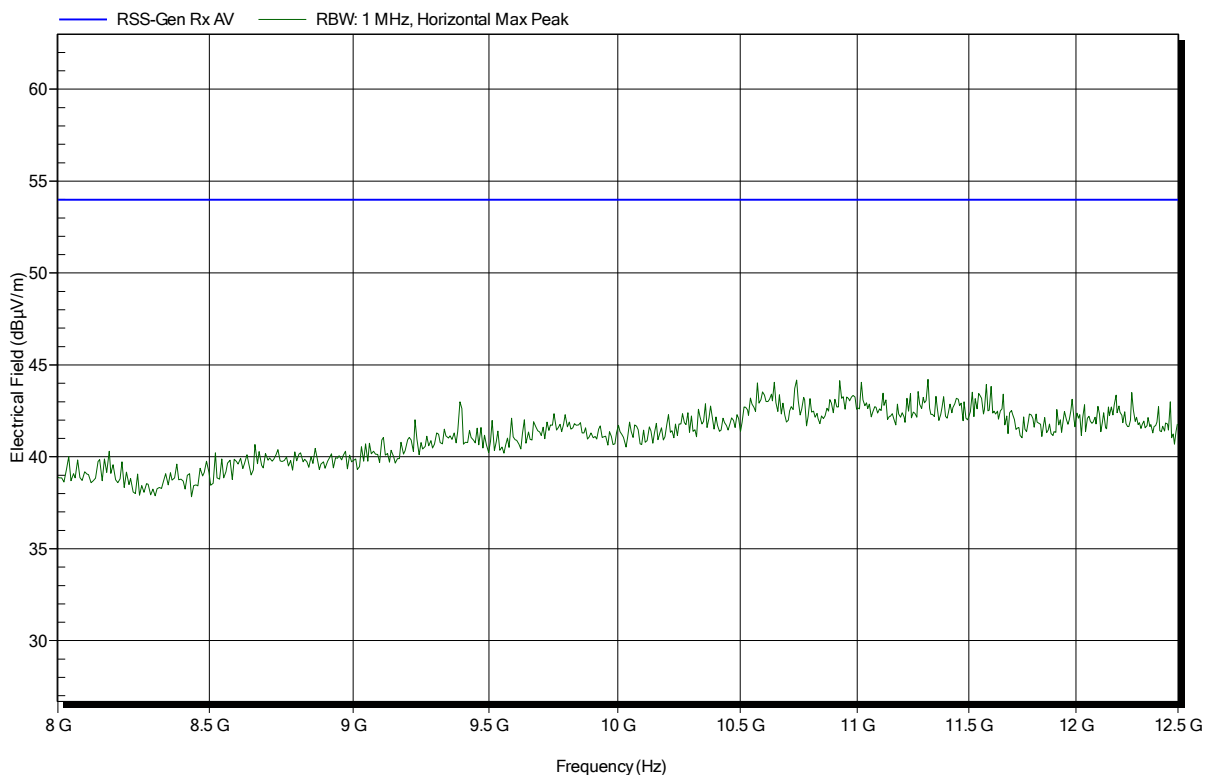

Spurious emissions according to RSS-247 Issue 2

Project number: G0M-1812-7889
 Applicant: Leica Geosystems AG
 EUT Name: Field Controller Win EC7
 Model: CS20
 Test Site: Eurofins Product Service GmbH
 Operator: Wilfried Treffke
 Test Conditions: Tnom: 22°C, Vnom: 120V AC (intern 11.1 V DC)
 Antenna: Schwarzbeck BBHA 9120D, Vertical
 Measurement distance: 1 m converted to 3m
 Mode: RX; Bluetooth; scan mode
 Test Date: 2019-02-06
 Note:

Index 50

