

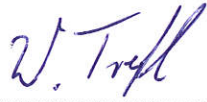

RADIO REPORT FCC 47 CFR Part 15C ISED Canada RSS-247 Digital transmission systems operating within the 2400 – 2483.5 MHz band	
Report Reference No	G0M-1812-7888-TFC247WF-V03
Testing Laboratory	Eurofins Product Service GmbH
Address	Storkower Str. 38c 15526 Reichenwalde Germany
Accreditation	 <p>A2LA Accredited Testing Laboratory, Certificate No.: 1983.01 FCC Test Firm Designation Number: DE0008 ISED Testing Laboratory site: 3470A-2</p>
Applicant	Leica Geosystems AG
Address	Heinrich Wild Strasse 9435 Heerbrugg SWITZERLAND
Test Specification	According to FCC/ISED rules
Standard	47 CFR Part 15C RSS-247, Issue 2, 2017-02 RSS-Gen, Issue 5, 2018-04
Non-Standard Test Method	None
Equipment under Test (EUT):	
Product Description	Field Controller Win EC7
Model(s)	CS20 LTE Disto (US, CA)
Additional Model(s)	None
Brand Name(s)	Leica Geosystems
Hardware Version(s)	V1.0
Software Version(s)	V4.97
FCC-ID	RFD-CSNGG
IC	3177A-CSNGG
Test Result	PASSED

Possible test case verdicts:		
required by standard but not tested	N/T	
not required by standard	N/R	
not applicable to EUT	N/A	
test object does meet the requirement	P(PASS)	
test object does not meet the requirement	F(FAIL)	
Testing:		
Test Lab Temperature	20 - 23 °C	
Test Lab Humidity	32 – 38 %	
Date of receipt of test item	2019-01-07	
Report:		
Compiled by	Wilfried Treffke	
Tested by (+ signature) (Responsible for Test)	Wilfried Treffke	
Approved by (+ signature) (Head of Lab)	Christian Weber	
Date of Issue	2019-07-16	
Total number of pages	111	
General Remarks:		
<p>The test results presented in this report relate only to the object tested.</p> <p>The results contained in this report reflect the results for this particular model and serial number. It is the responsibility of the manufacturer to ensure that all production models meet the intent of the requirements detailed within this report.</p> <p>This report shall not be reproduced, except in full, without the written approval of the Issuing testing laboratory.</p>		
Additional Comments:		
<p>The EUT can operate with different power requirements. (120V AC/DC adaptor and 11.1V DC Li- battery)</p> <p>Test mode selection is based on comparative tests. The 120V AC power port was selected for compliance tests.</p>		

ADDITIONAL VARIANTS

Additional Variants (not tested and not evaluated variants)		
Not-tested Variant	Description	
1	Product Type Description	Field Controller Win EC7
	Model name	CS20 LTE (876479)
	Brand name	Geosystems
	Hardware Version	V1.00
	Software Version	V4.97
Comment: Those named additional variants above have not been tested. Those additional variants of the series have been declared by the manufacturer. The test report explicitly states that those variants were neither tested nor assessed nor evaluated.		

VERSION HISTORY

Version History			
Version	Issue Date	Remarks	Revised By
01	2019-03-15	Initial Release	
02	2019-05-10	Product description and model name corrected.	W. Treffke
03	2019-07-16	Applicant on the test plots corrected	W. Treffke

ABBREVIATIONS AND ACRONYMS

Acronyms	
Acronym	Description
BPSK	Binary Phase Shift Keying
DSSS	Direct Sequence Spread Spectrum
EUT	Equipment Under Test
FCC	Federal Communications Commission
HT	High Throughput
IEEE 802.11	MAC and PHY Layer for WiFi
ISED	Innovation, Science and Economic Development Canada
OFDM	Orthogonal Frequency Division Multiplexing
QAM	Quadrature Amplitude Modulation
QPSK	Quadrature Phase Shift Keying
RBW	Resolution bandwidth
RMS	Root mean square
VBW	Video bandwidth
V _{NOM}	Nominal supply voltage

REPORT INDEX

1	Equipment (Test Item) Under Test.....	7
1.1	Photos – Equipment External.....	8
1.2	Photos – Equipment Internal.....	10
1.3	Photos – Test Setup.....	17
1.4	Support Equipment.....	18
1.5	Test mode duty cycle.....	19
1.6	Test Modes.....	21
1.7	Test Frequencies.....	22
1.8	Sample emission level calculation.....	23
2	Result Summary.....	24
3	Test Conditions and Results.....	25
3.1	Test Conditions and Results - Occupied bandwidth.....	25
3.2	Test Conditions and Results - AC powerline conducted emissions.....	28
3.3	Test Conditions and Results - Transmitter radiated emissions.....	31
3.4	Test Conditions and Results - Receiver radiated emissions.....	35
ANNEX A	Transmitter spurious emissions.....	38
ANNEX B	Receiver spurious emissions.....	102

1 Equipment (Test Item) Under Test

Description	Field Controller Win EC7	
Model	CS20 LTE Disto (US, CA)	
Additional Model(s)	None	
Brand Name(s)	Leica Geosystems	
Serial Number(s)	2475478	
Hardware Version(s)	V1.0	
Software Version(s)	V4.97	
PMN	CS20 LTE Disto, CS20 LTE	
HVIN	CS20 LTE Disto, CS20 LTE	
FVIN	-/-	
HMN	-/-	
FCC-ID	RFD-CSNGG	
IC	3177A-CSNGG	
Equipment type	End Product	
Radio type	Transceiver	
Assigned frequency bands	2400 - 2483.5 MHz	
Radio technology	IEEE 802.11 b/g/n (HT20)	
Modulation	BPSK, QPSK, 16-QAM, 32-QAM	
Number of antenna ports	1	
Radio Module	Type	TiWi-BLE™ Bluetooth® and Wi-Fi Modules
	Model	TIWI-BLE
	Manufacturer	Laird Technologies (LSR)
	HW Version	unspecified
	SW Version	unspecified
	FCC-ID	RFD-BTWCO
	IC	3177A-BTWCO
Antenna	Type	Integrated
	Model	W3008C
	Manufacturer	Pulse Electronics
	Gain	1 dBi (manufacturer declaration)
Supply Voltage	V _{NOM}	120 VAC (adaptor)
Operating Temperature	T _{NOM}	11.1 VAC (Lithium Battery)
AC/DC-Adaptor	Model	25 °C
	Vendor	GEV276
	Input	Leica Geosystems
	Output	100 – 240; 50 / 60 Hz
Manufacturer	Leica Geosystems AG Heinrich Wild Strasse 9435 Heerbrugg SWITZERLAND	

1.1 Photos – Equipment External

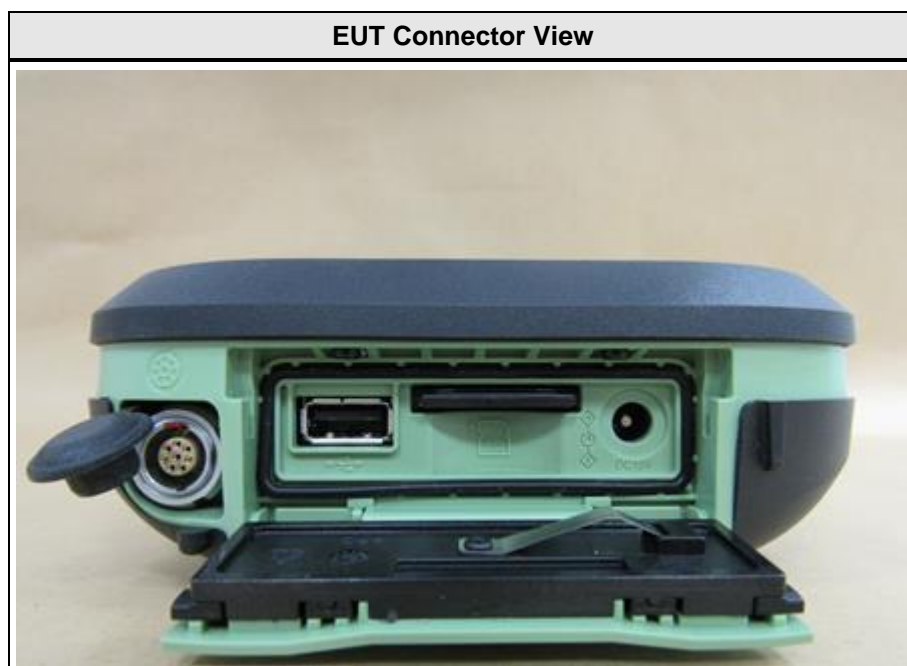



1.2 Photos – Equipment Internal

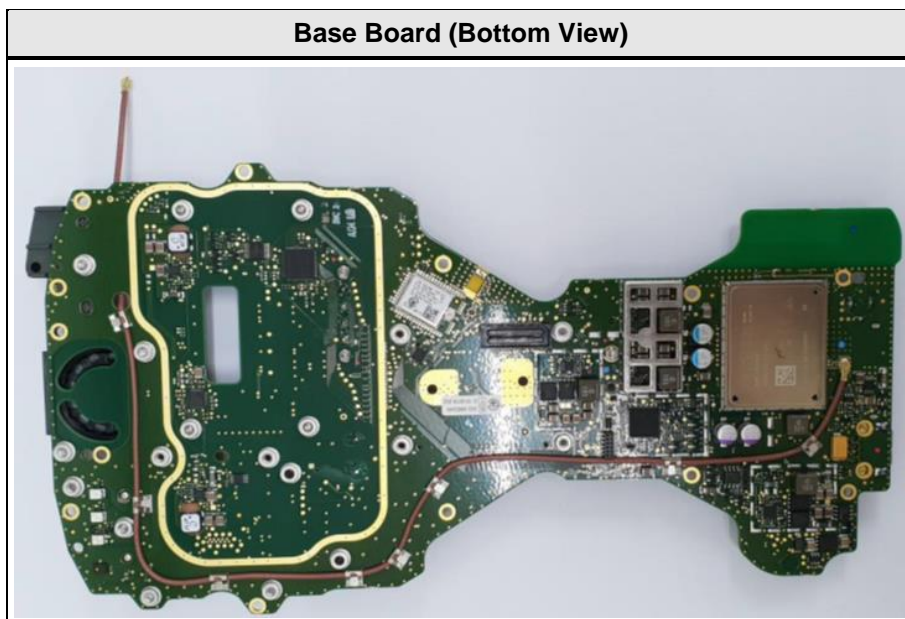
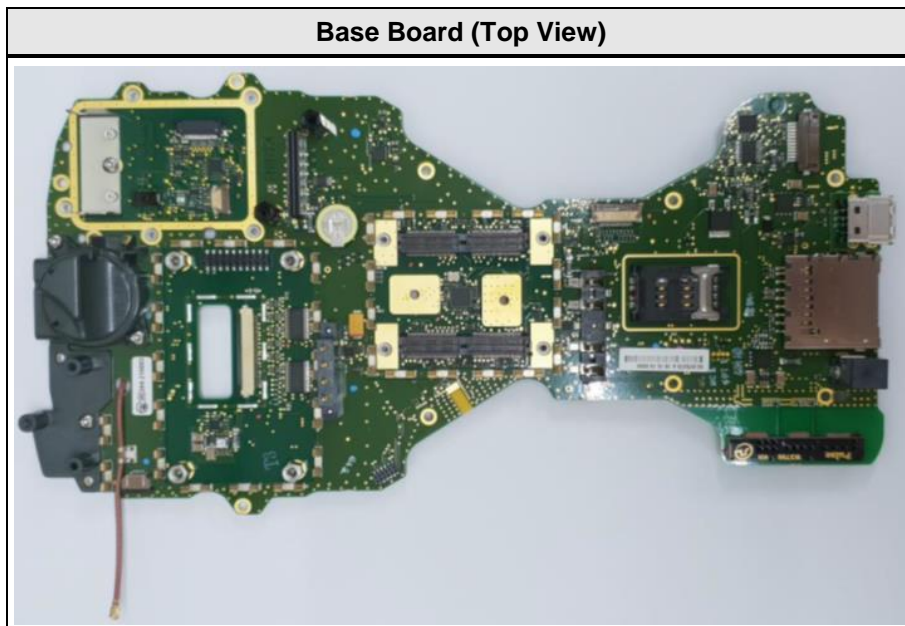

WLAN / Bluetooth Module



Core Module Board (Top View)

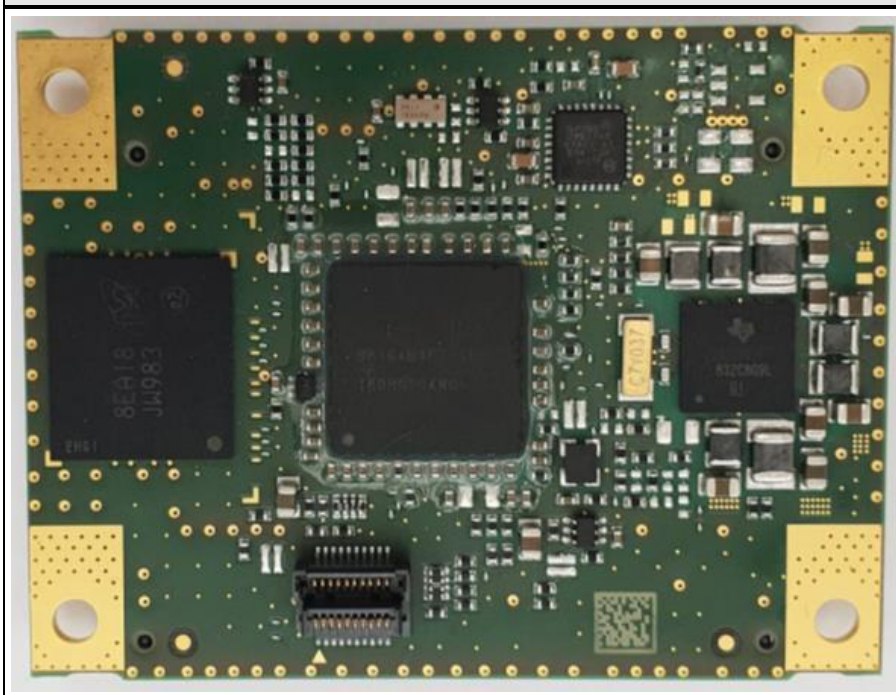

Core Module Board (Bottom View)

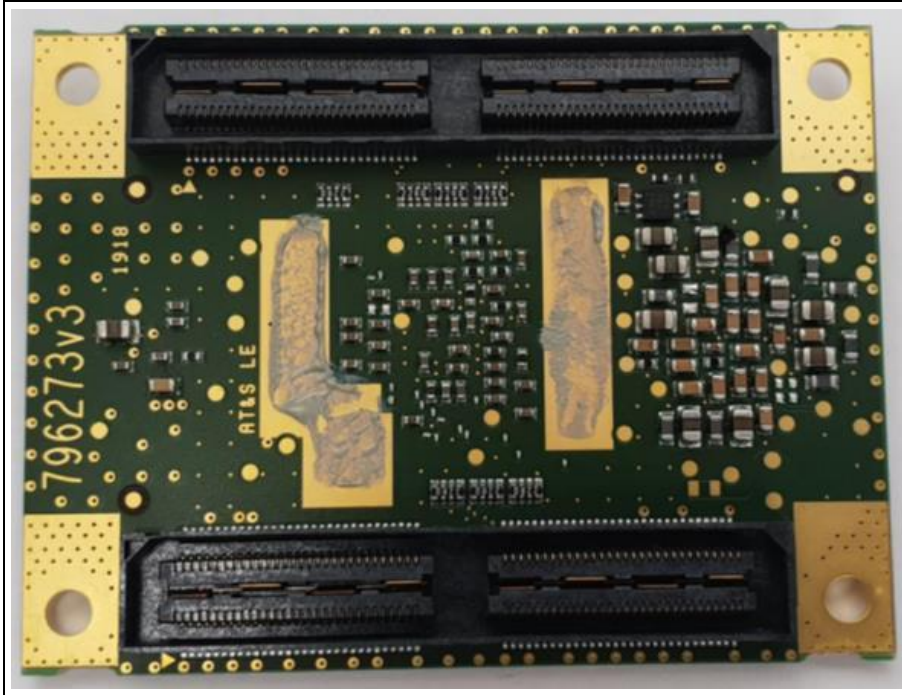

Camera Board (Top View)

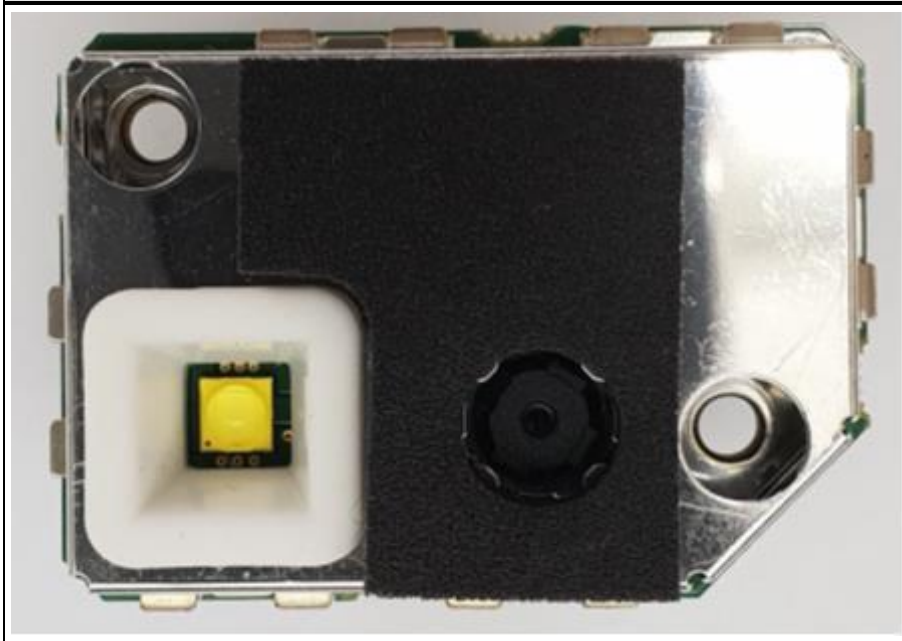

Disto Board (Top View)



Disto Board (Bottom View)

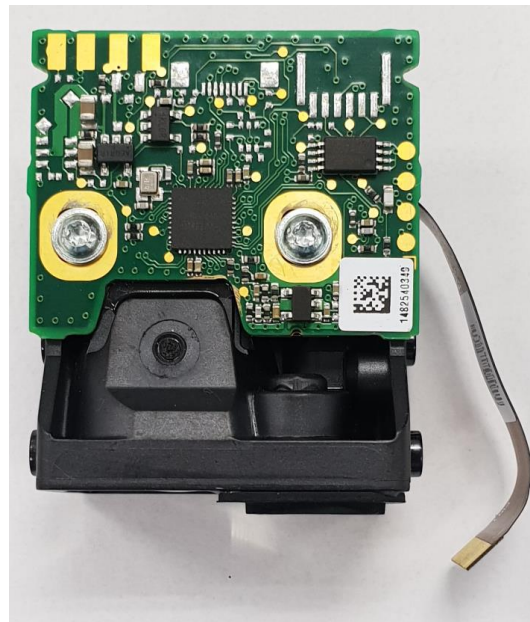

Long-Range Bluetooth Board (Top View)



Long-Range Bluetooth Board (Bottom View)

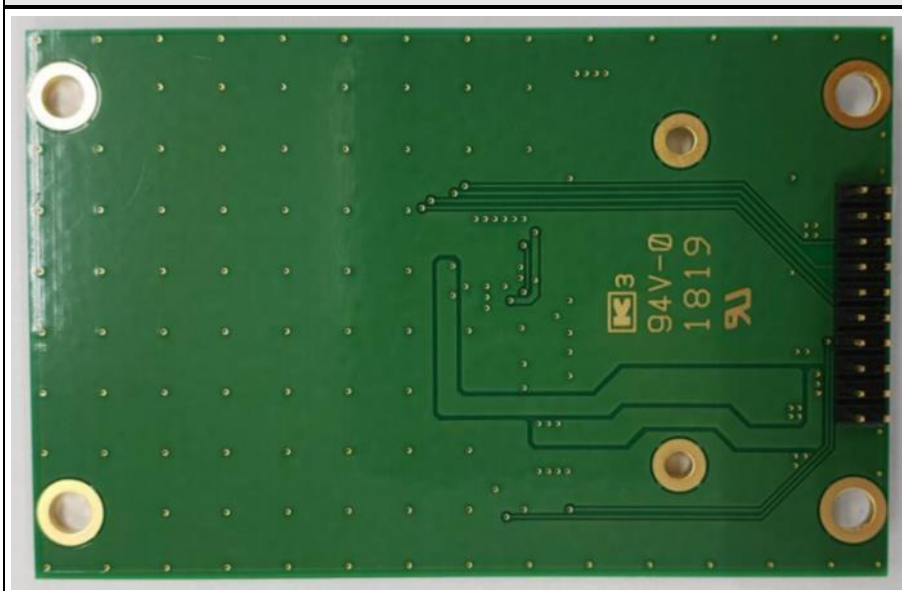

Diversity Antenna Board (Top View)

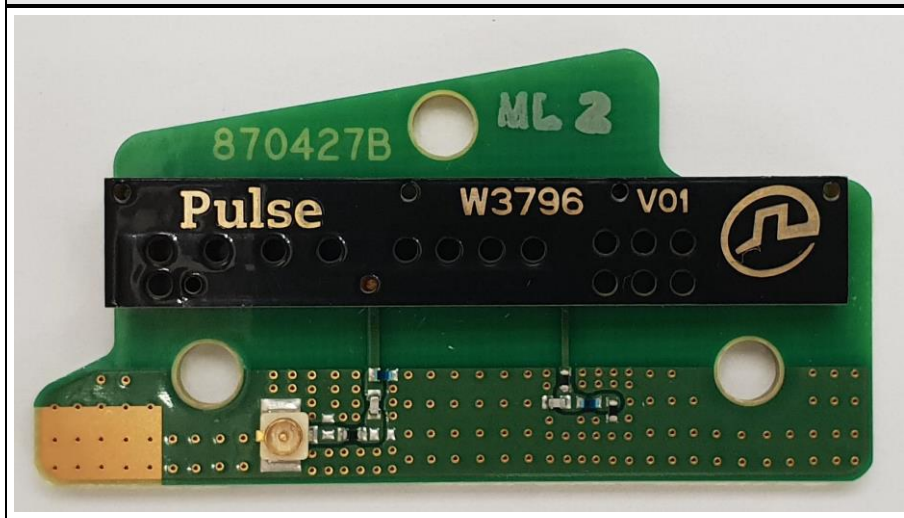

Diversity Antenna Board (Bottom View)



Long-Range Bluetooth Antenna Board (Top View)

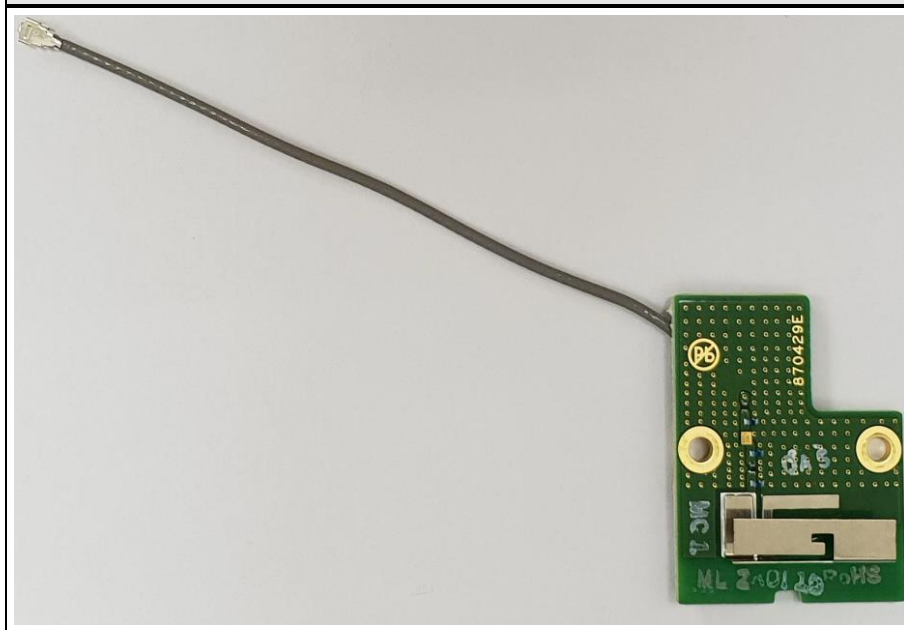

Long-Range Bluetooth Antenna Board (Bottom View)

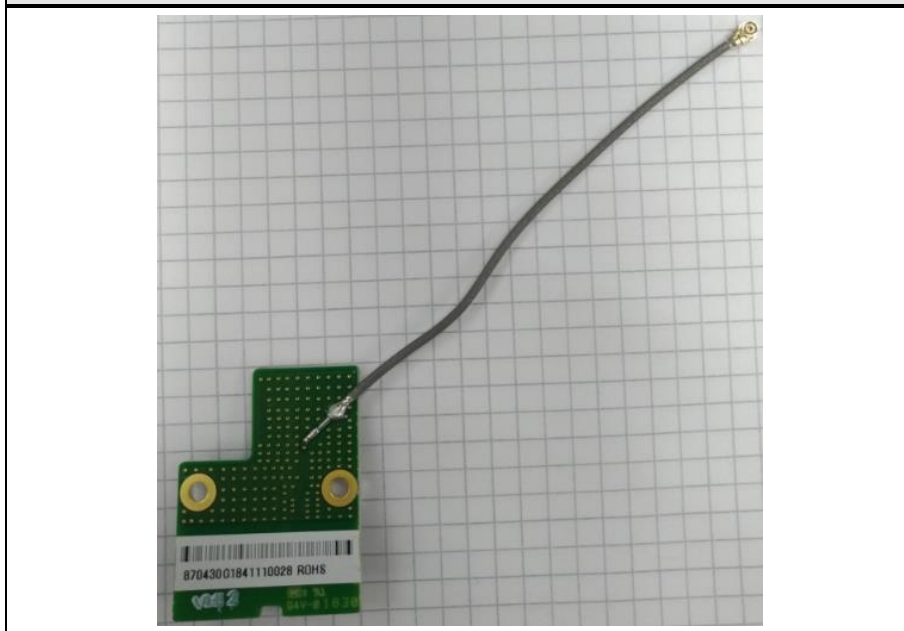

1.3 Photos – Test Setup

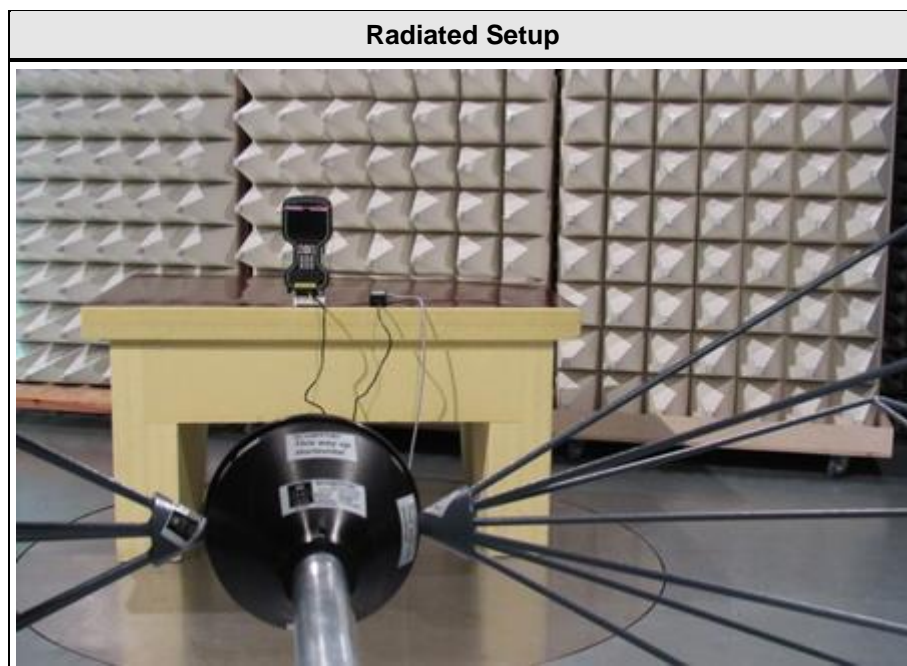
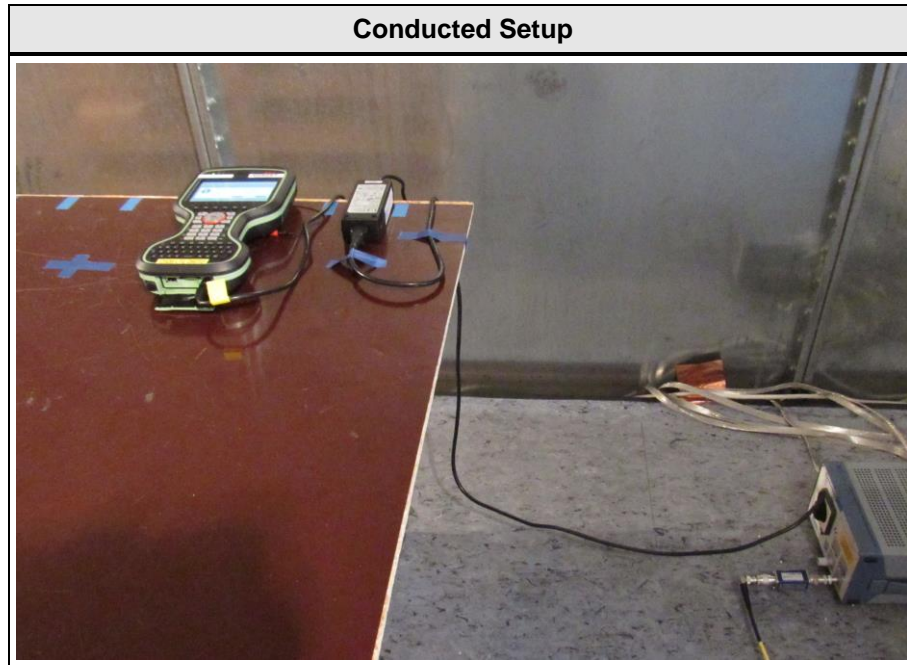

1.4 Support Equipment

Product Type	Device	Manufacturer	Model	Comment
AE	Power Supply	Dell	FA65NE0-00	S/N RX929
AE	Laptop	Dell	Latitude E6420	S/N HPJ4R1
Description:				
AE	Auxiliary Equipment			
SIM	Simulator			
CBL	Connecting Cable			
Comment:				

1.5 Test mode duty cycle

1.5.1 Information

Test Information	
Measurement Method	ANSI C63.10 11.6

1.5.2 Requirements

Requirements	
Duty cycle	Duty cycle correction
≥ 98 %	No correction required
< 98 %	Correction required ($10 \times \log_{10}(1/DC)$)

1.5.3 Setup

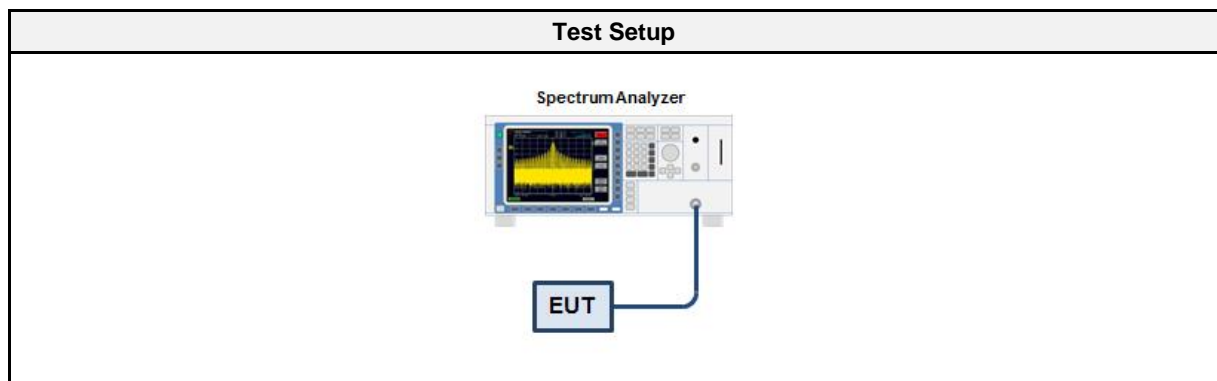

1.5.4 Equipment

Test Equipment					
Description	Manufacturer	Model	Identifier	Cal. Date	Cal. Due
Spectrum Analyzer	R&S	FSU 26	EF01003	2018-07	2019-07

1.5.5 Procedure

Test Procedure
<ol style="list-style-type: none"> 1. EUT set to test mode 2. Span is set to zero span 3. Detector set to peak 4. Sweep time is set long enough to capture at least 5 bursts 5. Envelope peak value of emission spectrum is selected 6. The maximum burst duration T_{ON} is measured using two markers set to the start and the end of the longest burst 7. The minimum idle duration T_{OFF} is measured using two markers set to the start and the end of the shortest idle period 8. The duty cycle is calculated by $DC = T_{ON} / (T_{ON} + T_{OFF})$ 9. The duty cycle correction is calculated by $DC = 10 \times \log_{10}(T_{ON} / (T_{ON} + T_{OFF}))$

1.5.6 Results

Duty Cycle Results		
Mode	Duty Cycle [%]	Correction Factor [dB]
DSSS	100	0
OFDM	100	0
HT20	100	0

1.6 Test Modes

Mode	Description
DSSS (IEEE 802.11b)	Mode = Transmit Modulation = BPSK Spreading = DSSS Bandwidth = 20 MHz Duty cycle = 100% Data rate = 1 Mbps
OFDM (IEEE 802.11g)	Mode = Transmit Modulation = BPSK Spreading = OFDM Bandwidth = 20 MHz Duty cycle = 100% Data rate = 6 Mbps
HT20 (IEEE 802.11n)	Mode = Transmit Modulation = BPSK Spreading = OFDM Bandwidth = 20 MHz Duty cycle = 100% Data rate (1 Simultaneous Tx) = 6.5 Mbps MCS (1 Simultaneous Tx) = 0
Receive	Mode = Receive
Comment: The above settings were found as worst case during pre-tests.	

1.7 Test Frequencies

Designator	Mode	Channel	Frequency [MHz]
F1	Tx / Rx	1	2412
F2	Tx / Rx	6	2437
F3	Tx / Rx	11	2462

1.8 Sample emission level calculation

The following is a description of terms and a sample calculation, as appears in the radiated emissions data table. The numbers used in the calculation are for example only. There is no direct correlation to the specific data taken for the product described in this document:

Reading:

This is the reading obtained on the spectrum analyzer in dBµV. Any external preamplifiers used are taken into account through internal analyzer settings.

A.F.:

This is the antenna factor for the receiving antenna. It is a conversion factor, which converts electric fields strengths to voltages, which can be measured directly on the spectrum analyzer. It is treated as a loss in dB. Cable losses have been included with the A.F. to simplify the calculations. The antenna factor is used in calculations as follows:

$$\text{Reading on Analyzer (dB}\mu\text{V)} + \text{A.F. (dB/m)} = \text{Net field strength (dB}\mu\text{V/m)}$$

Net:

This is the net field strength measurement (as shown above).

Limit:

This is the FCC Class B radiated emission limit (in units of dBµV/m). The FCC limits are given in units of µV/m. The following formula is used to convert the units of µV/m to dBµV/m:

$$\text{Limit (dB}\mu\text{V/m)} = 20 \cdot \log(\mu\text{V/m})$$

Margin:

This is the margin of compliance below the FCC limit. The units are given in dB. A negative margin indicates the emission was below the limit. A positive margin indicates that the emission exceeds the limit.

Example only:

Reading + AF	= Net Reading	:	Net reading - FCC limit	= Margin
+21.5 dBµV + 26 dB/m	= 47.5 dBµV/m	:	47.5 dBµV/m - 57.0 dBµV/m	= -9.5 dB

2 Result Summary

FCC 47 CFR Part 15C, ISED RSS-247				
Product Standard Reference	Requirement	Reference Method	Result	Remarks
ISED RSS-Gen, Issue 5 (section 6.6)	Occupied Bandwidth	ANSI C63.10-2013	N/R	Informational only
FCC § 15.247(a)(2) ISED RSS-247, Issue 2 (section 5.2)	6 dB Bandwidth	ANSI C63.10-2013	N/T	
FCC § 15.247(b)(1) ISED RSS-247, Issue 2 (section 5.4)	Maximum peak conducted power	ANSI C63.10-2013	N/T	
FCC § 15.247(e) ISED RSS-247, Issue 2 (section 5.2)	Power spectral density	ANSI C63.10-2013	N/T	
FCC § 15.207 ISED RSS-247, Issue 2 (section 3.1)	AC power line conducted emissions	ANSI C63.10-2013	PASS	
FCC § 15.247(d) ISED RSS-247, Issue 2 (section 5.5)	Band edge compliance	ANSI C63.10-2013	N/T	
FCC § 15.247(d) ISED RSS-247, Issue 2 (section 5.5)	Conducted spurious emissions	ANSI C63.10-2013	N/T	
FCC § 15.247(d) FCC § 15.209 ISED RSS-Gen, Issue 5 (section 6.13)	Transmitter radiated spurious emissions	ANSI C63.10-2013	PASS	
ISED RSS-247, Issue 2 (section 3.1)	Receiver radiated spurious emissions	ANSI C63.10-2013	PASS	
Comment:				

Possible Test Case Verdicts	
PASS	Test object does meet the requirements
FAIL	Test object does not meet the requirements
N/T	Required by standard but not tested
N/R	Not required by standard for the test object

3 Test Conditions and Results

3.1 Test Conditions and Results - Occupied bandwidth

3.1.1 Information

Test Information	
Reference	ISED RSS-Gen, Issue 5 (section 6.6)
Measurement Method	ANSI C63.10 6.9.3
Operator	Wilfried Treffke
Date	2019-02-09

3.1.2 Limits

Limits
None (Informational only)

3.1.3 Setup

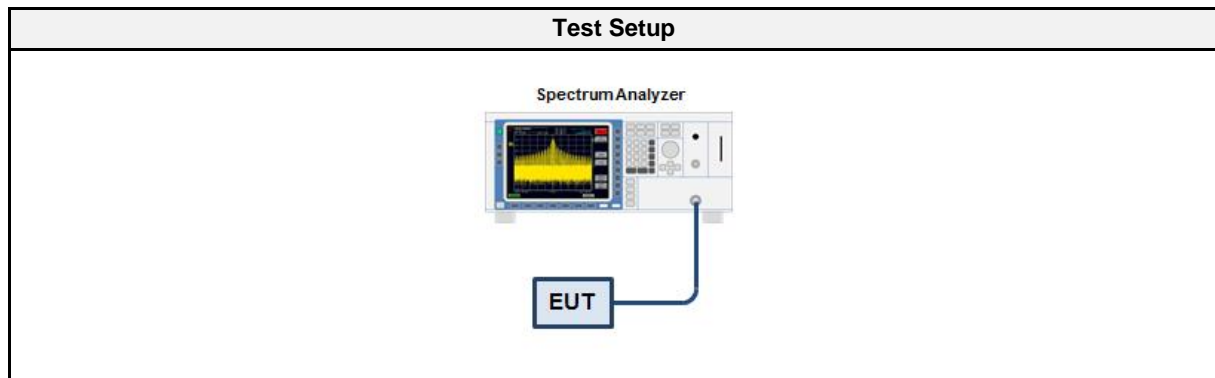

3.1.4 Equipment

Test Equipment					
Description	Manufacturer	Model	Identifier	Cal. Date	Cal. Due
Spectrum Analyzer	R&S	FSU 26	EF01407	2018-12	2019-12

3.1.5 Procedure

Test Procedure
<ol style="list-style-type: none"> 1. EUT transmitter is activated in test mode under normal conditions 2. The spectrum analyzer is set to peak detection and maximum hold with a span twice the emission spectrum 3. The resolution bandwidth is set to the range of 1 % to 5 % of the occupied bandwidth 4. The occupied bandwidth is measured with the build-in analyzer function

3.1.6 Results

Test Results		
Mode	Frequency [MHz]	Bandwidth [MHz]
HT20	2462	16.620
Comment	worst case	

Occupied Bandwidth

Project Number: G0M-1812-7888
 Applicant: Leica Geosystems AG
 Model Description: Field Controller Win EC7
 Model: CS20 LTE Disto (US, CA)
 Test Sample ID: 22136
 Reference Method: ANSI C63.10:2013, Section 6.9.3
 Operational Mode: IEEE 802.11 n HT20, Channel: 11, 2462
 Operating Conditions: Tnom/Vnom
 Operator: Wilfried Treffke
 Test Site: Eurofins Product Service GmbH
 Test Date: 2019-02-11
 Occupied Bandwidth [MHz]: 16.620

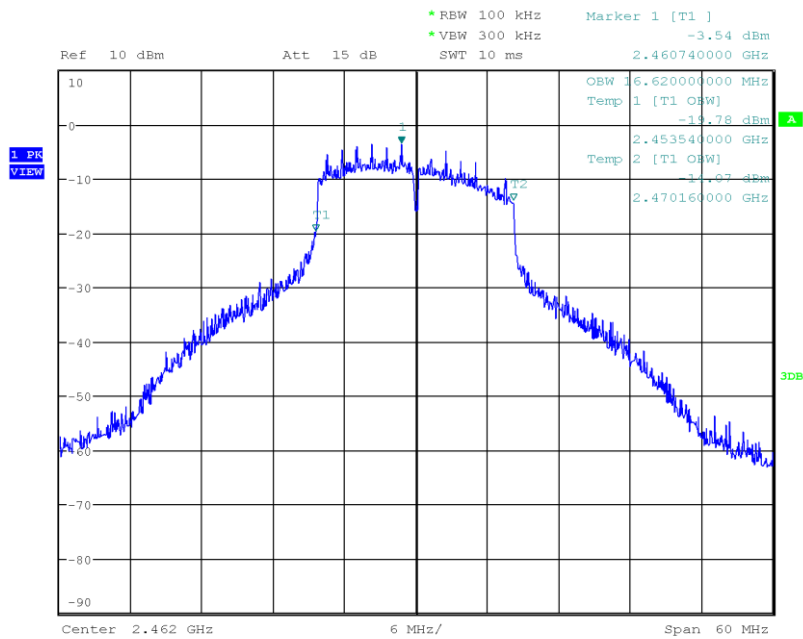

Date: 11.FEB.2019 16:31:55

3.2 Test Conditions and Results - AC powerline conducted emissions

3.2.1 Information

Test Information	
Reference	FCC § 15.207; ISED RSS-247, Issue 2 (section 3.1)
Measurement Method	ANSI C63.10 6.2
Operator	Wilfried Treffke
Date	2019-02-09

3.2.2 Limits

Limits		
Frequency [MHz]	Quasi-Peak [dBµV]	Average [dBµV]
0.15 - 0.5	66 - 56*	56 - 46*
0.5 - 5	56	46
5 - 30	60	50

* Limit decreases linearly with the logarithm of the frequency

3.2.3 Setup

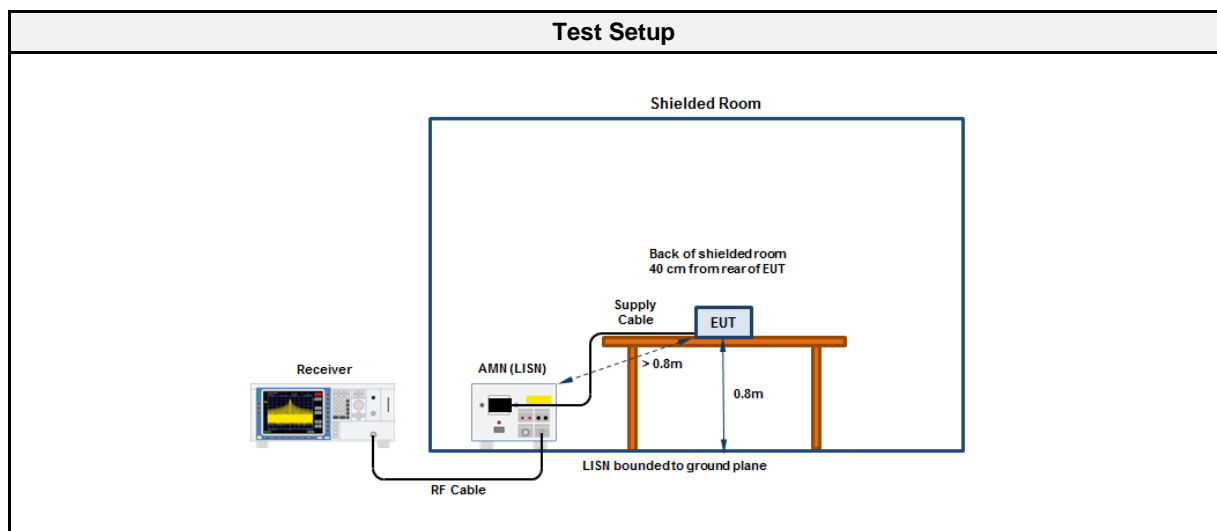

3.2.4 Equipment

Test Software			
Description	Manufacturer	Name	Version
EMC Software	DARE Instruments	RadiMation	2016.1.10

Test Equipment					
Description	Manufacturer	Model	Identifier	Cal. Date	Cal. Due
EMI Test Receiver	R&S	ESR7	EF00943	2018-07	2019-07
LISN	R&S	ESH3-Z5	EF00036	2017-01	2019-07

EMI voltage test in the ac-mains according to FCC part 15B

Project number: G0M-1812-7888

Applicant: Leica Geosystems AG
 EUT Name: Field Controller Win EC7
 Model: CS20 LTE Disto (US, CA)
 Test Site: Eurofins Product Service GmbH
 Operator: Mr. Treffke
 Test Conditions: Tnom: 23°C, Unom: 120 VAC / 60Hz
 LISN: ESH3-Z5 (L)
 Mode: Tx IEEE 802.11b; 2437 MHz
 Test Date: 2019-02-09
 Note:

Index 2

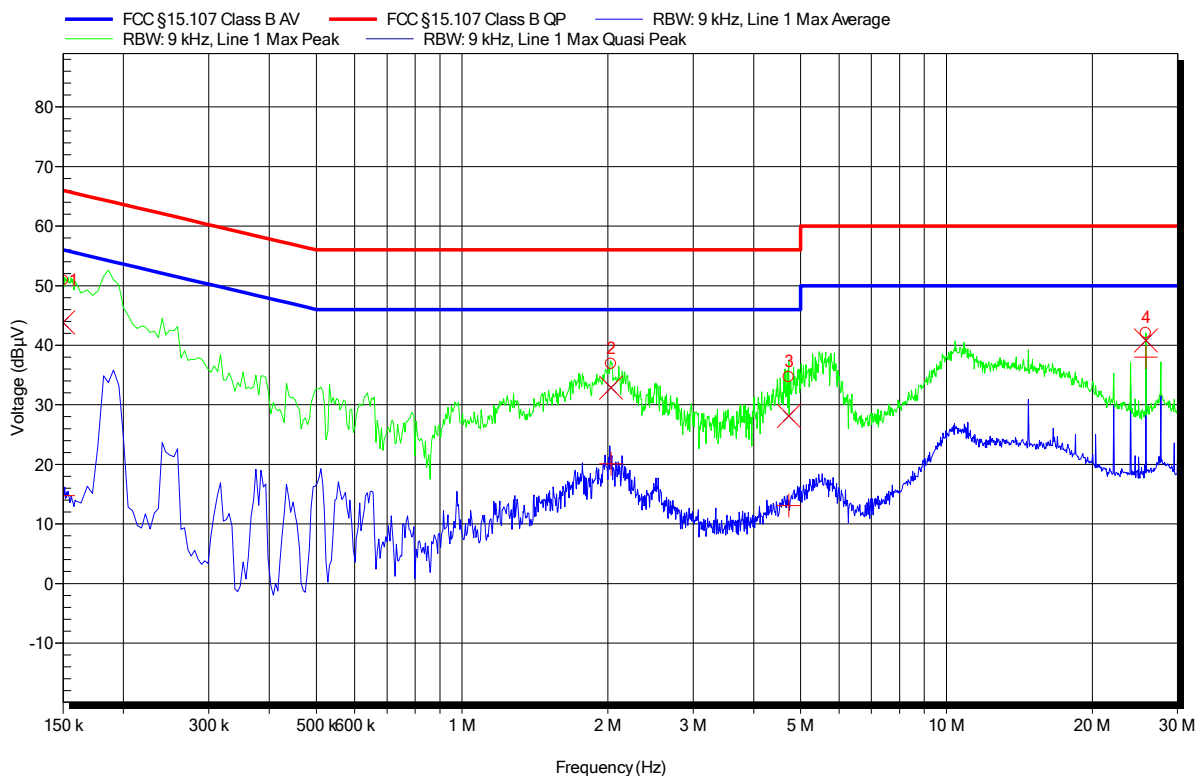

Peak Number	Frequency	Quasi-Peak	Quasi-Peak Limit	Quasi-Peak Difference	Quasi-Peak Status
1	150 kHz	43.85 dBµV	66 dBµV	-22.15 dB	Pass
2	2.031 MHz	32.9 dBµV	56 dBµV	-23.1 dB	Pass
3	4.727 MHz	28.11 dBµV	56 dBµV	-27.89 dB	Pass
4	25.807 MHz	40.8 dBµV	60 dBµV	-19.2 dB	Pass

Peak Number	Frequency	Average	Average Limit	Average Difference	Average Status
1	150 kHz	14.76 dBµV	56 dBµV	-41.24 dB	Pass
2	2.031 MHz	20.09 dBµV	46 dBµV	-25.91 dB	Pass
3	4.727 MHz	13.06 dBµV	46 dBµV	-32.94 dB	Pass
4	25.807 MHz	37.98 dBµV	50 dBµV	-12.02 dB	Pass

EMI voltage test in the ac-mains according to FCC part 15B

Project number: G0M-1812-7888

Applicant: Leica Geosystems AG
 EUT Name: Field Controller Win EC7
 Model: CS20 LTE Disto (US, CA)
 Test Site: Eurofins Product Service GmbH
 Operator: Mr. Treffke
 Test Conditions: Tnom: 24°C, Unom: 120 VAC / 60Hz
 LISN: ESH3-Z5 (N)
 Mode: Tx IEEE 802.11b; 2437 MHz
 Test Date: 2019-02-09
 Note:

Index 1

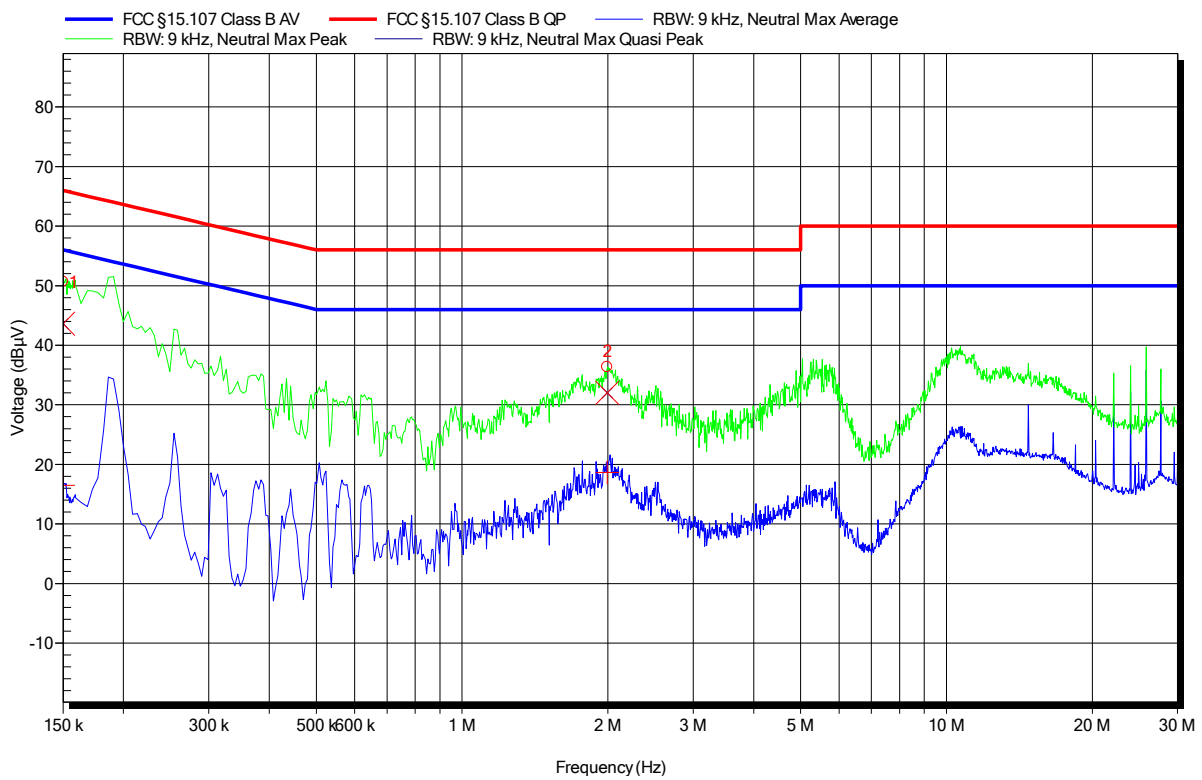

Peak Number	Frequency	Quasi-Peak	Quasi-Peak Limit	Quasi-Peak Difference	Quasi-Peak Status
1	150 kHz	43.61 dBµV	66 dBµV	-22.39 dB	Pass
2	1.995 MHz	32.02 dBµV	56 dBµV	-23.98 dB	Pass

Peak Number	Frequency	Average	Average Limit	Average Difference	Average Status
1	150 kHz	16.48 dBµV	56 dBµV	-39.52 dB	Pass
2	1.995 MHz	18.62 dBµV	46 dBµV	-27.38 dB	Pass

3.3 Test Conditions and Results - Transmitter radiated emissions

3.3.1 Information

Test Information	
Reference	FCC § 15.247(d); FCC § 15.209; ISSED RSS-Gen, Issue 5 (section 6.13)
Measurement Method	ANSI C63.10 6.4, 6.5, 6.6, 11.12
Operator	Wilfried Treffke
Date	2019-02-09

3.3.2 Limits

Limits			
Frequency [MHz]	Detector	Field strength [$\mu\text{V}/\text{m}$]	Measurement distance [m]
0.009 - 0.09	Average	2400/F[kHz]	300
0.09 - 0.110	Quasi-Peak	2400/F[kHz]	300
0.110 - 0.490	Average	2400/F[kHz]	300
0.490 - 1.705	Quasi-Peak	24000/F[kHz]	30
1.705 - 30.0	Quasi-Peak	30	30
30 - 88	Quasi-Peak	100	3
88 - 216	Quasi-Peak	150	3
216 - 960	Quasi-Peak	200	3
960 - 1000	Quasi-Peak	500	3
>1000	Average	500	3

3.3.3 Setup

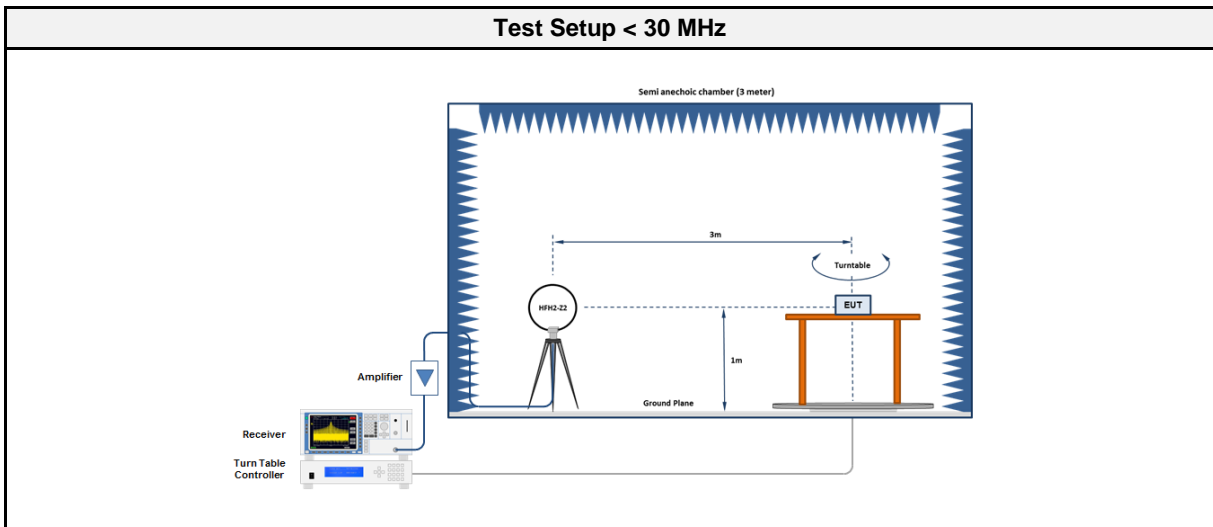

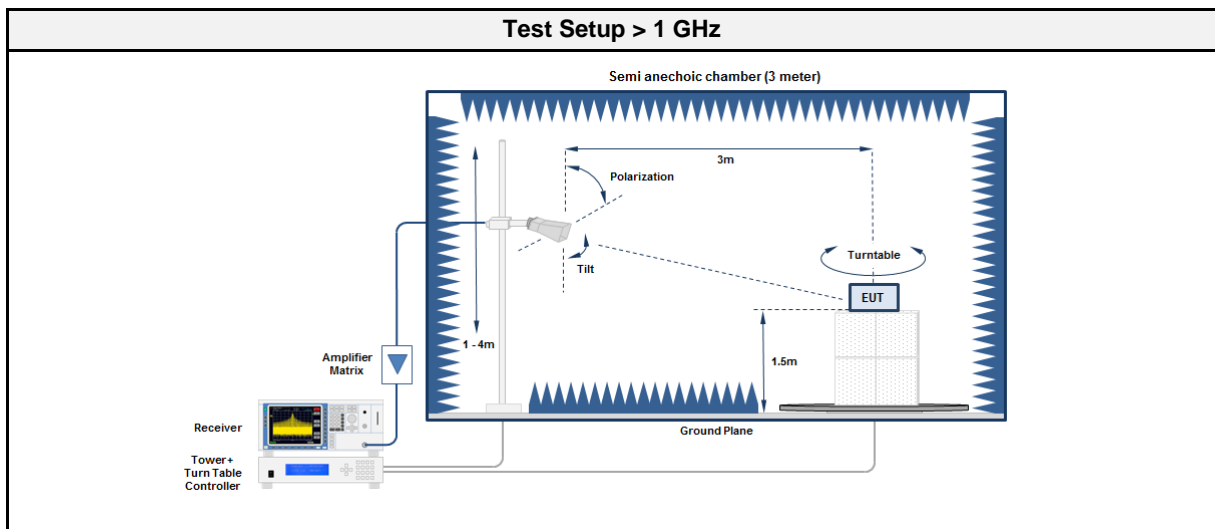
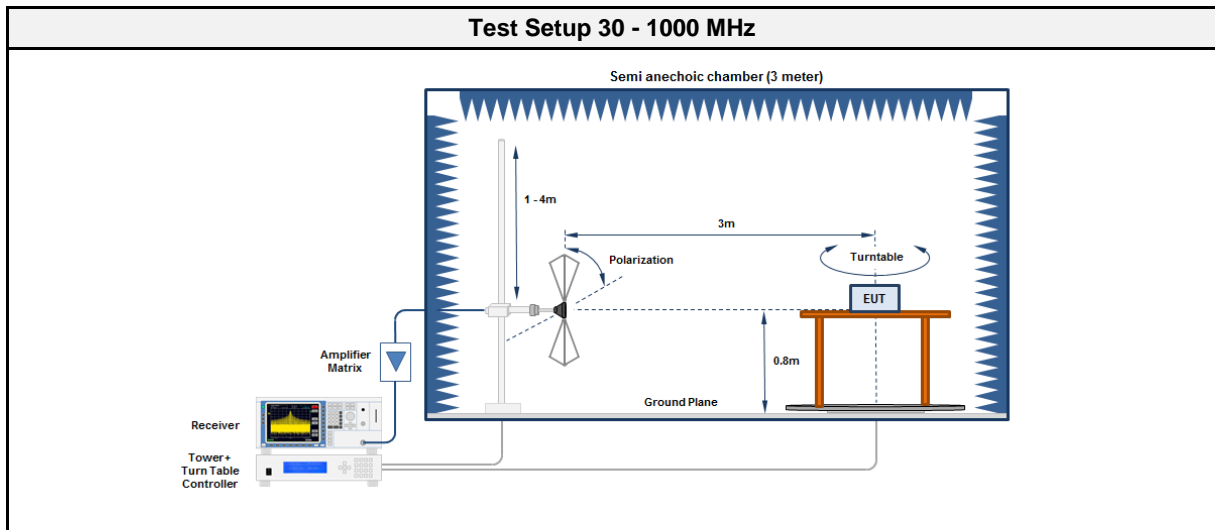

3.3.4 Equipment

Test Software			
Description	Manufacturer	Name	Version
EMC Software	DARE Instruments	RadiMation	2015.2.4

Test Equipment 30 - 1000 MHz					
Description	Manufacturer	Model	Identifier	Cal. Date	Cal. Due
Anechoic Chamber	Frankonia	AC1	EF00062	2018-07	2021-07
Measurement Receiver	Agilent	N9038A-526/WXP	EF01070	2018-08	2019-08
Antenna	R&S	VULB 9162	EF00978	2016-11	2019-11
Antenna	R&S	HK 116	EF00030	2016-04	2019-04
Antenna	R&S	HL 223	EF00187	2016-05	2019-05

Test Equipment > 1 GHz					
Description	Manufacturer	Model	Identifier	Cal. Date	Cal. Due
Anechoic Chamber	Frankonia	AC1	EF00062	2018-07	2021-07
Measurement Receiver	Agilent	N9038A-526/WXP	EF01070	2018-08	2019-08
Antenna	Schwarzbeck	BBHA 9120D	EF00018	2016-09	2019-09
Antenna	Amplifier Research	AT4560	EF00302	2018-04	2019-04
Antenna	Amplifier Research	AT4560	EF01152	2018-10	2019-10

3.3.5 Procedure

Test Procedure < 30 MHz
<ol style="list-style-type: none"> 1. EUT is placed on a non conducting support at the center of a turn table 0.8 m above the ground 2. EUT set to test mode 3. The EUT is rotated through 360° 4. The emissions are measured with peak detector and max hold 5. All significant emissions are measured again using the corresponding final detector

Test Procedure 30 - 1000 MHz
<ol style="list-style-type: none"> 1. EUT is placed on a non conducting support at the center of a turn table 0.8 m above the ground 2. EUT set to test mode 3. The receiver is set to peak detection with max hold 4. The EUT is rotated through 360° and the height of the antenna is varied from 1 m to 4 m 5. All significant emissions are measured again using the corresponding final detector

Test Procedure > 1 GHz
<ol style="list-style-type: none"> 1. EUT is placed on a non conducting support at the center of a turn table 1.5 m above the ground 2. EUT set to test mode 3. The receiver is set to peak detection with max hold 4. The EUT is rotated through 360° and the height of the antenna is varied from 1 m to 4 m 5. All significant emissions are measured again using the corresponding final detector

3.3.6 Results

Test Results - DSSS						
Channel [MHz]	Emission [MHz]	Level [dB μ V/m]	Det.	Pol.	Limit [dB μ V/m]	Margin [dB]
2412	406.08	26.44	pk	hor	46.00	-19.56
2412	2389.9	50.63	pk	hor	74.00	-23.37
2412	2389.9	38.42	RMS	hor	54.00	-15.58
2437	2485	44.53	pk	hor	74.00	-29.47
2437	2485	35.59	RMS	hor	54.00	-18.41
2437	4870	35.03	pk	ver	74.00	-38.97
2462	2485.6	52.51	pk	hor	74.00	-21.49
2462	2485.6	41.08	RMS	hor	54.00	-12.92

Test Results - OFDM						
Channel [MHz]	Emission [MHz]	Level [dB μ V/m]	Det.	Pol.	Limit [dB μ V/m]	Margin [dB]
2412	2386	50.15	pk	hor	74.00	-23.85
2412	2386	38.48	RMS	hor	54.00	-15.52
2412	2487.3	47.02	pk	hor	74.00	-26.98
2412	2487.3	26.66	RMS	hor	54.00	-27.34
2437	2483.5	54.33	pk	hor	74.00	-19.67
2437	2483.5	41.37	RMS	hor	54.00	-12.63

Test Results - HT20						
Channel [MHz]	Emission [MHz]	Level [dB μ V/m]	Det.	Pol.	Limit [dB μ V/m]	Margin [dB]
2412	2389.9	50.51	pk	hor	74.00	-23.49
2412	2389.9	38.67	RMS	hor	54.00	-15.33
2412	2389.9	50.68	pk	ver	74.00	-23.32
2412	2389.9	38.46	RMS	ver	54.00	-15.54
2412	2483.8	45.34	pk	hor	74.00	-28.66
2412	2483.8	29.75	RMS	hor	54.00	-24.25
2437	2388.8	39.88	pk	hor	74.00	-34.12
2437	2483.9	47.88	pk	hor	74.00	-26.12
2437	2483.9	32.36	RMS	hor	54.00	-21.64
2462	2483.6	57.21	pk	hor	74.00	-16.79
2462	2483.6	41.51	RMS	hor	54.00	-12.49

3.4 Test Conditions and Results - Receiver radiated emissions

3.4.1 Information

Test Information	
Reference	ISED RSS-247, Issue 2 (section 3.1)
Measurement Method	ANSI C63.10 6.5, 6.6, 11.12
Operator	Wilfried Treffke
Date	2019-02-13

3.4.2 Limits

Limits			
Frequency [MHz]	Detector	Field strength [dB μ V/m]	Measurement distance [m]
30 - 88	Quasi-Peak	100	3
88 - 216	Quasi-Peak	150	3
216 - 960	Quasi-Peak	200	3
960 - 1000	Quasi-Peak	500	3
>1000	Average	500	3

3.4.3 Setup

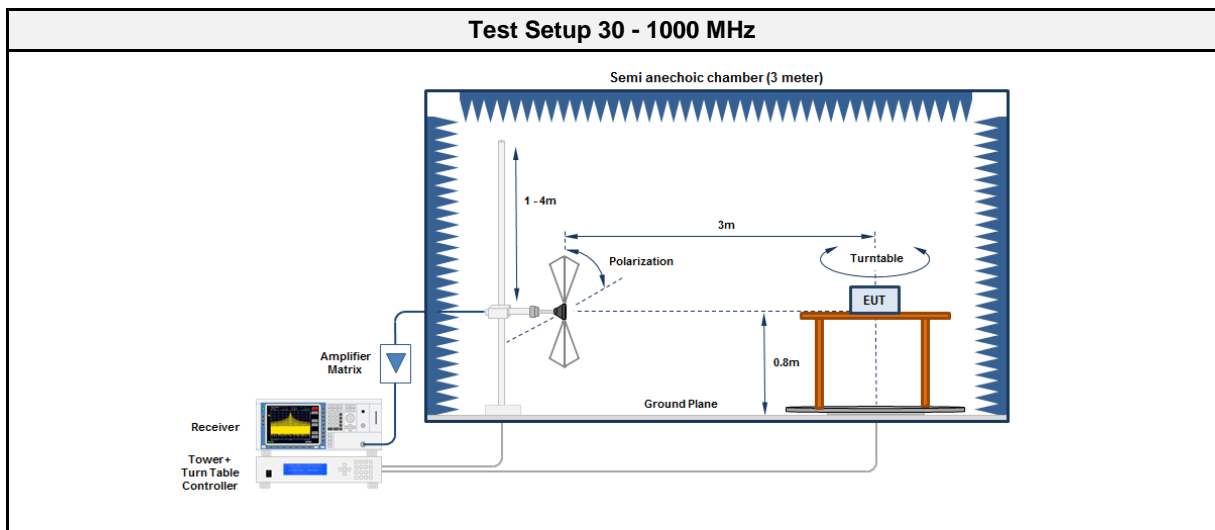

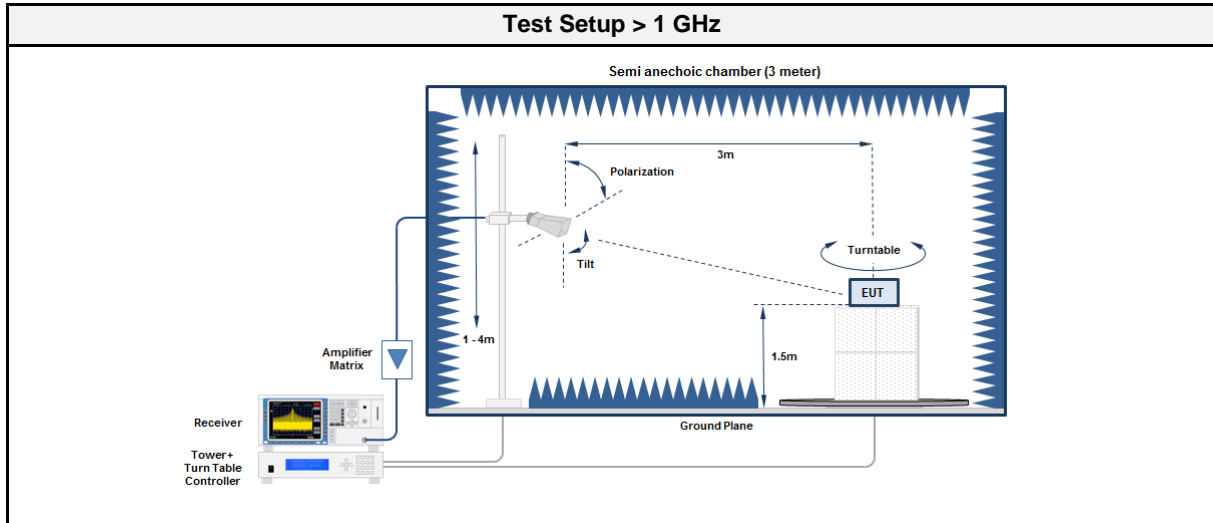

3.4.4 Equipment

Test Software			
Description	Manufacturer	Name	Version
EMC Software	DARE Instruments	RadiMation	2015.2.4

Test Equipment 30 - 1000 MHz					
Description	Manufacturer	Model	Identifier	Cal. Date	Cal. Due
Anechoic Chamber	Frankonia	AC1	EF00062	2018-07	2021-07
Measurement Receiver	Agilent	N9038A-526/WXP	EF01070	2018-08	2019-08
Antenna	R&S	VULB 9162	EF00978	2016-11	2019-11
Antenna	R&S	HK 116	EF00030	2016-04	2019-04
Antenna	R&S	HL 223	EF00187	2016-05	2019-05

Test Equipment > 1 GHz					
Description	Manufacturer	Model	Identifier	Cal. Date	Cal. Due
Anechoic Chamber	Frankonia	AC1	EF00062	2018-07	2021-07
Measurement Receiver	Agilent	N9038A-526/WXP	EF01070	2018-08	2019-08
Antenna	Schwarzbeck	BBHA 9120D	EF00018	2016-09	2019-09
Antenna	Amplifier Research	AT4560	EF00302	2018-04	2019-04
Antenna	Amplifier Research	AT4560	EF01152	2018-10	2019-10

3.4.5 Procedure

Test Procedure 30 - 1000 MHz
<ol style="list-style-type: none"> 1. EUT is placed on a non conducting support at the center of a turn table 0.8 m above the ground 2. EUT set to test mode 3. The receiver is set to peak detection with max hold 4. The EUT is rotated through 360° and the height of the antenna is varied from 1 m to 4 m 5. All significant emissions are measured again using the corresponding final detector

Test Procedure > 1 GHz

1. EUT is placed on a non conducting support at the center of a turn table 1.5 m above the ground
2. EUT set to test mode
3. The receiver is set to peak detection with max hold
4. The EUT is rotated through 360° and the height of the antenna is varied from 1 m to 4 m
5. All significant emissions are measured again using the corresponding final detector

3.4.6 Results

Test Results

Channel [MHz]	Emission [MHz]	Level [dB μ V/m]	Det.	Pol.	Limit [dB μ V/m]	Margin [dB]
2437	31.354	30.04	qpk	hor	40.00	-09.96
2437	1850	41.27	pk	hor	53.98	-12.71
2437	7981	49.41	pk	hor	53.98	-04.57
2437	11031	44.28	pk	hor	53.98	-09.70
2437	11031	43.66	pk	ver	53.98	-10.32

ANNEX A Transmitter spurious emissions

Spurious emissions according to FCC 15.247

Project number: G0M-1812-7888

Applicant: Leica Geosystems AG
 EUT Name: Field Controller Win EC7
 Model: CS20 LTE Disto (US, CA)
 Test Site: Eurofins Product Service GmbH
 Operator: Wilfried Treffke
 Test Conditions: Tnom: 22°C, Vnom: Vnom: 120V AC (intern 11.1 V DC)
 Antenna: Rohde & Schwarz HK 116, Horizontal
 Measurement distance: 3 m
 Mode: TX; IEEE 802.11b; 1Mbps; 2412 MHz
 Test Date: 2019-02-11
 Note:

Index 99

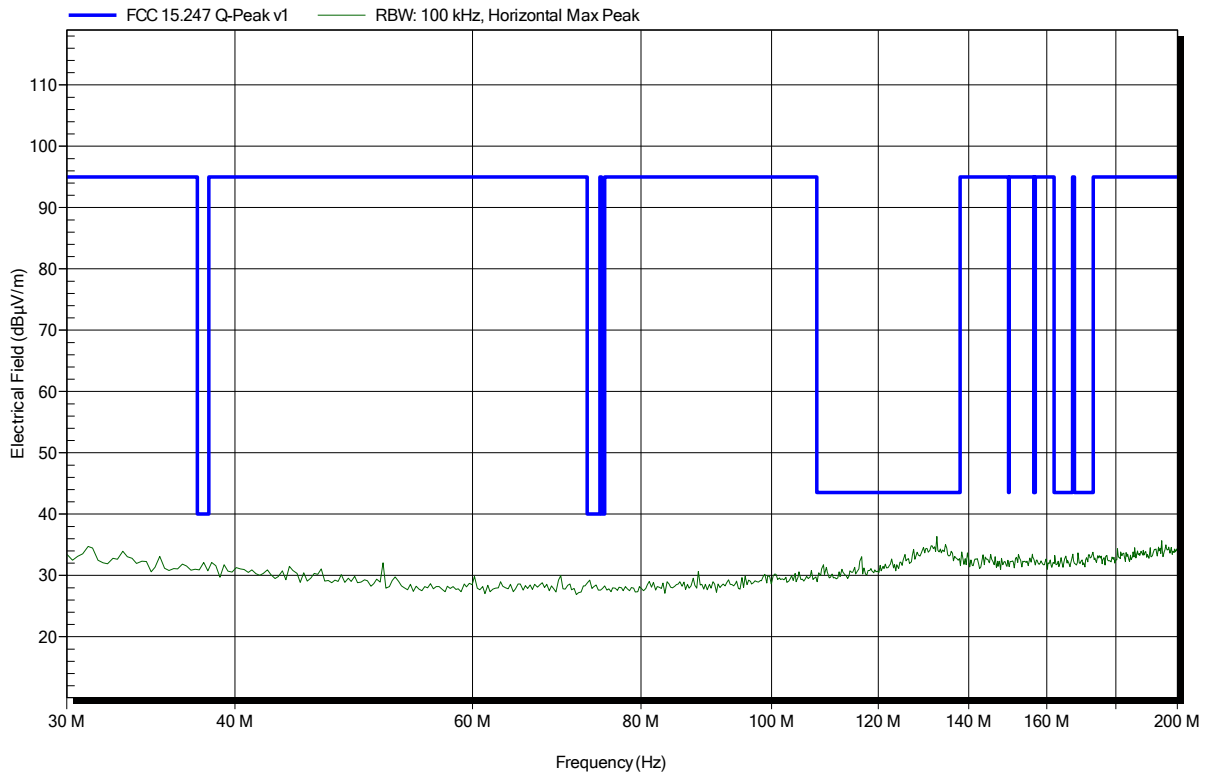

Spurious emissions according to FCC 15.247

Project number: G0M-1812-7888

Applicant: Leica Geosystems AG
 EUT Name: Field Controller Win EC7
 Model: CS20 LTE Disto (US, CA)
 Test Site: Eurofins Product Service GmbH
 Operator: Wilfried Treffke
 Test Conditions: Tnom: 22°C, Vnom: Vnom: 120V AC (intern 11.1 V DC)
 Antenna: Rohde & Schwarz HK 116, Vertical
 Measurement distance: 3 m
 Mode: TX; IEEE 802.11b; 1Mbps; 2412 MHz
 Test Date: 2019-02-11
 Note:

Index 100

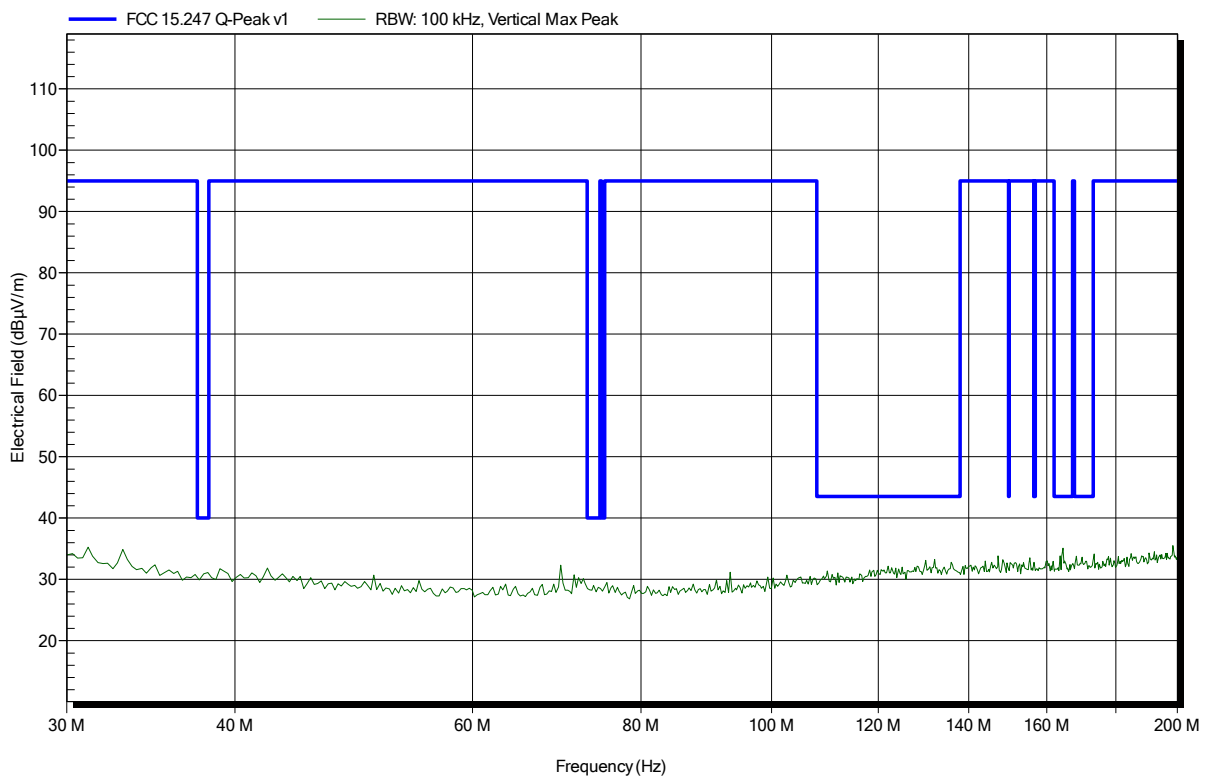

Spurious emissions according to FCC 15.247

Project number: G0M-1812-7888

Applicant: Leica Geosystems AG
 EUT Name: Field Controller Win EC7
 Model: CS20 LTE Disto (US, CA)
 Test Site: Eurofins Product Service GmbH
 Operator: Wilfried Treffke
 Test Conditions: Tnom: 22°C, Vnom: Vnom: 120V AC (intern 11.1 V DC)
 Antenna: Rohde & Schwarz HL 223, Horizontal
 Measurement distance: 3 m
 Mode: TX; IEEE 802.11b; 1Mbps; 2412 MHz
 Test Date: 2019-02-11
 Note:

Index 101

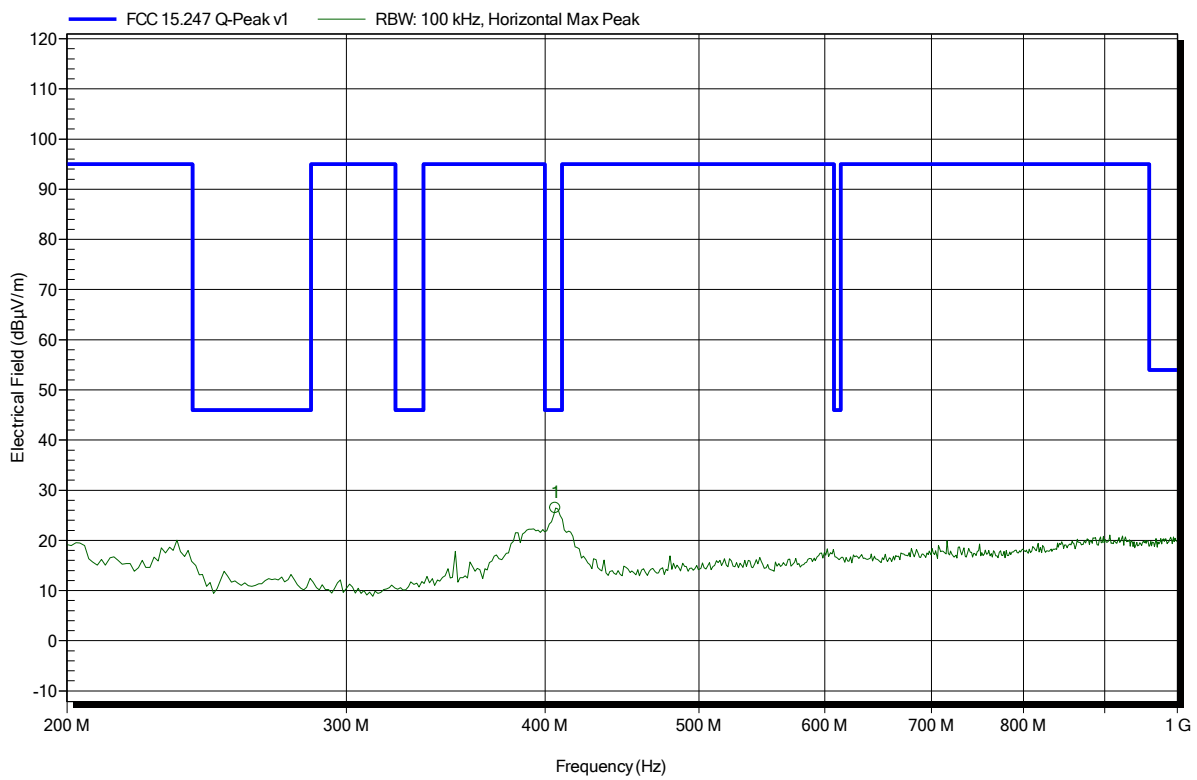

Frequency	Peak	Peak Limit	Peak Difference	Peak Status
406.08 MHz	26.44 dBµV/m	46 dBµV/m	-19.56 dB	Pass

Spurious emissions according to FCC 15.247

Project number: G0M-1812-7888

Applicant: Leica Geosystems AG
 EUT Name: Field Controller Win EC7
 Model: CS20 LTE Disto (US, CA)
 Test Site: Eurofins Product Service GmbH
 Operator: Wilfried Treffke
 Test Conditions: Tnom: 22°C, Vnom: Vnom: 120V AC (intern 11.1 V DC)
 Antenna: Rohde & Schwarz HL 223, Vertical
 Measurement distance: 3 m
 Mode: TX; IEEE 802.11b; 1Mbps; 2412 MHz
 Test Date: 2019-02-11
 Note:

Index 102

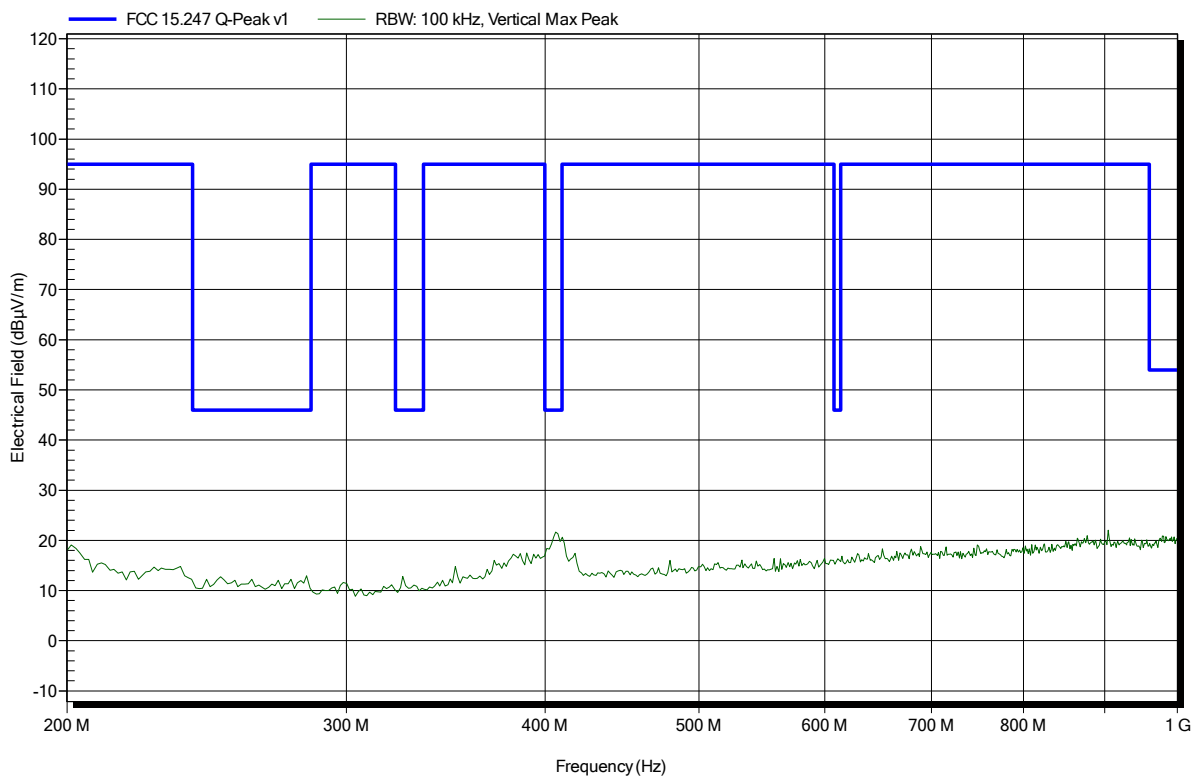

Spurious emissions according to FCC 15.247

Project number: G0M-1812-7888

Applicant: Leica Geosystems AG
 EUT Name: Field Controller Win EC7
 Model: CS20 LTE Disto (US, CA)
 Test Site: Eurofins Product Service GmbH
 Operator: Wilfried Treffke
 Test Conditions: Tnom: 22°C, Vnom: Vnom: 120V AC (intern 11.1 V DC)
 Antenna: Schwarzbeck BBHA 9120D, Horizontal
 Measurement distance: 1 m converted to 3m
 Mode: TX; IEEE 802.11b; 1Mbps; 2412 MHz
 Test Date: 2019-02-09
 Note:

Index 35

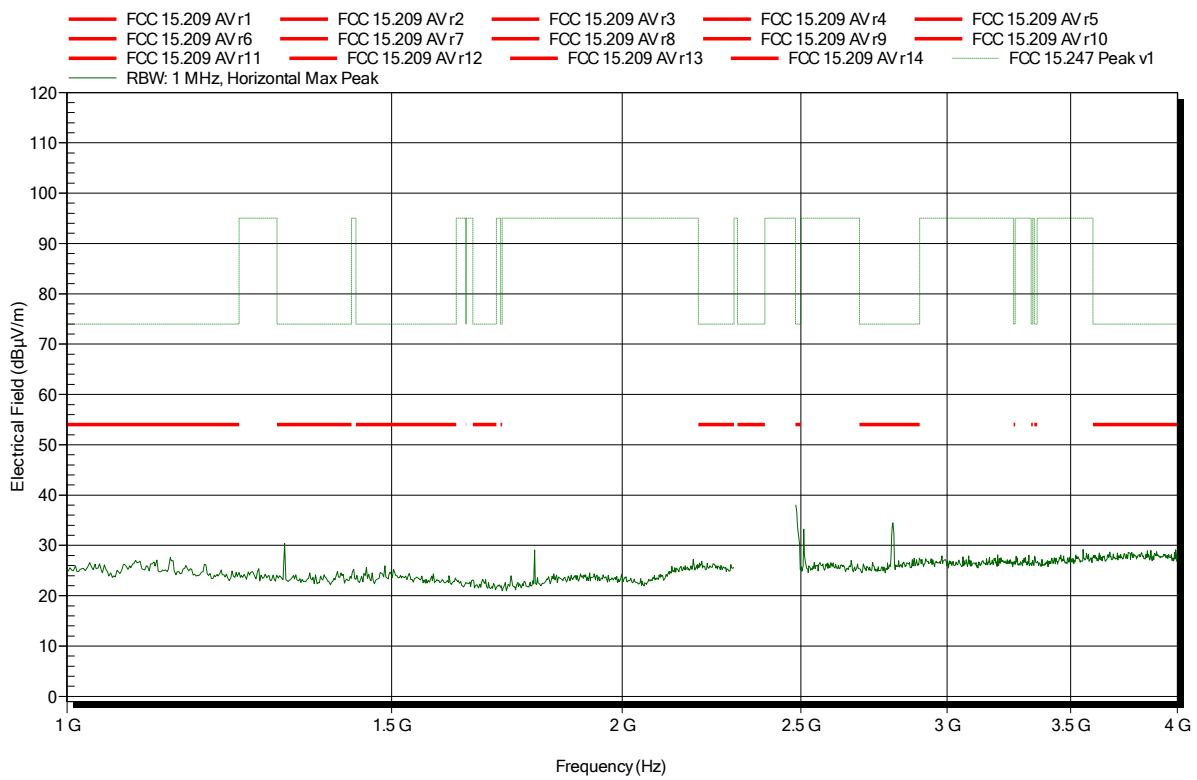

Spurious emissions according to FCC 15.247

Project number: G0M-1812-7888

Applicant: Leica Geosystems AG
 EUT Name: Field Controller Win EC7
 Model: CS20 LTE Disto (US, CA)
 Test Site: Eurofins Product Service GmbH
 Operator: Wilfried Treffke
 Test Conditions: Tnom: 22°C, Vnom: Vnom: 120V AC (intern 11.1 V DC)
 Antenna: Schwarzbeck BBHA 9120D, Vertical
 Measurement distance: 1 m converted to 3m
 Mode: TX; IEEE 802.11b; 1Mbps; 2412 MHz
 Test Date: 2019-02-09
 Note:

Index 40

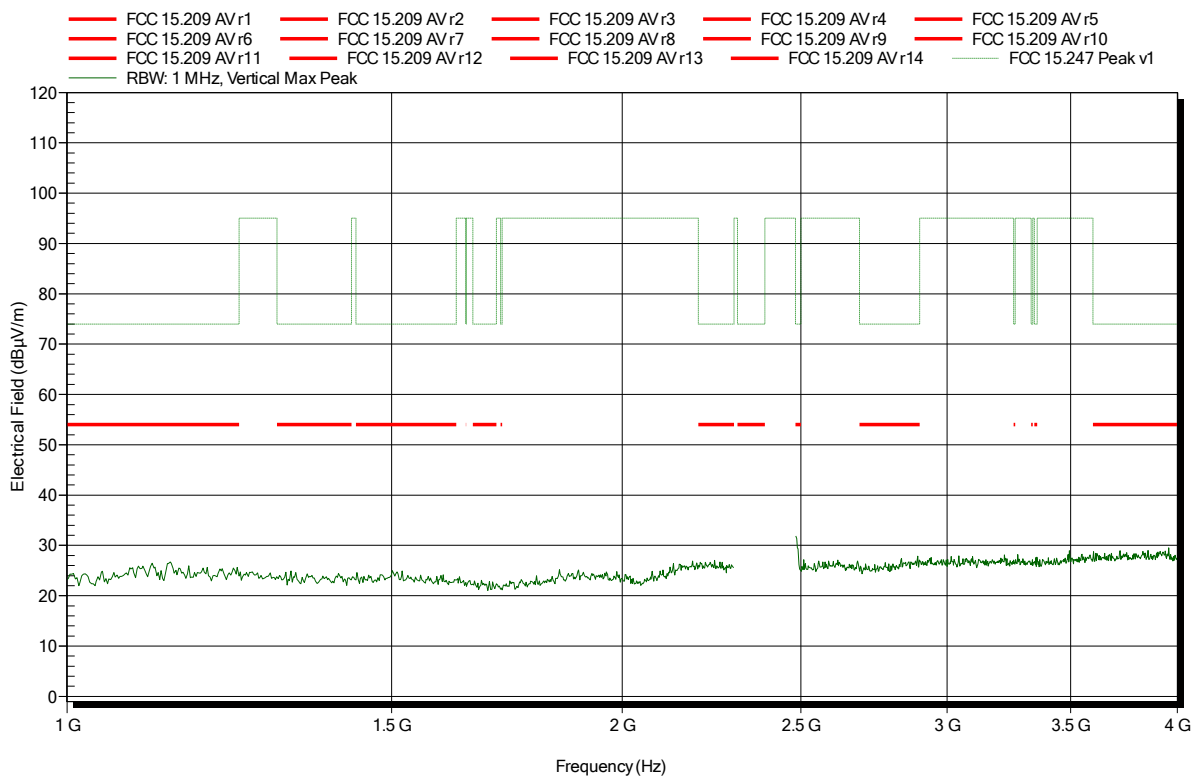

Spurious emissions according to FCC 15.247

Project number: G0M-1812-7888

Applicant: Leica Geosystems AG
 EUT Name: Field Controller Win EC7
 Model: CS20 LTE Disto (US, CA)
 Test Site: Eurofins Product Service GmbH
 Operator: Wilfried Treffke
 Test Conditions: Tnom: 22°C, Vnom: Vnom: 120V AC (intern 11.1 V DC)
 Antenna: Schwarzbeck BBHA 9120D, Horizontal
 Measurement distance: 1 m converted to 3m
 Mode: TX; IEEE 802.11b; 1Mbps; 2412 MHz
 Test Date: 2019-02-09
 Note: lower bandedge

Index 36

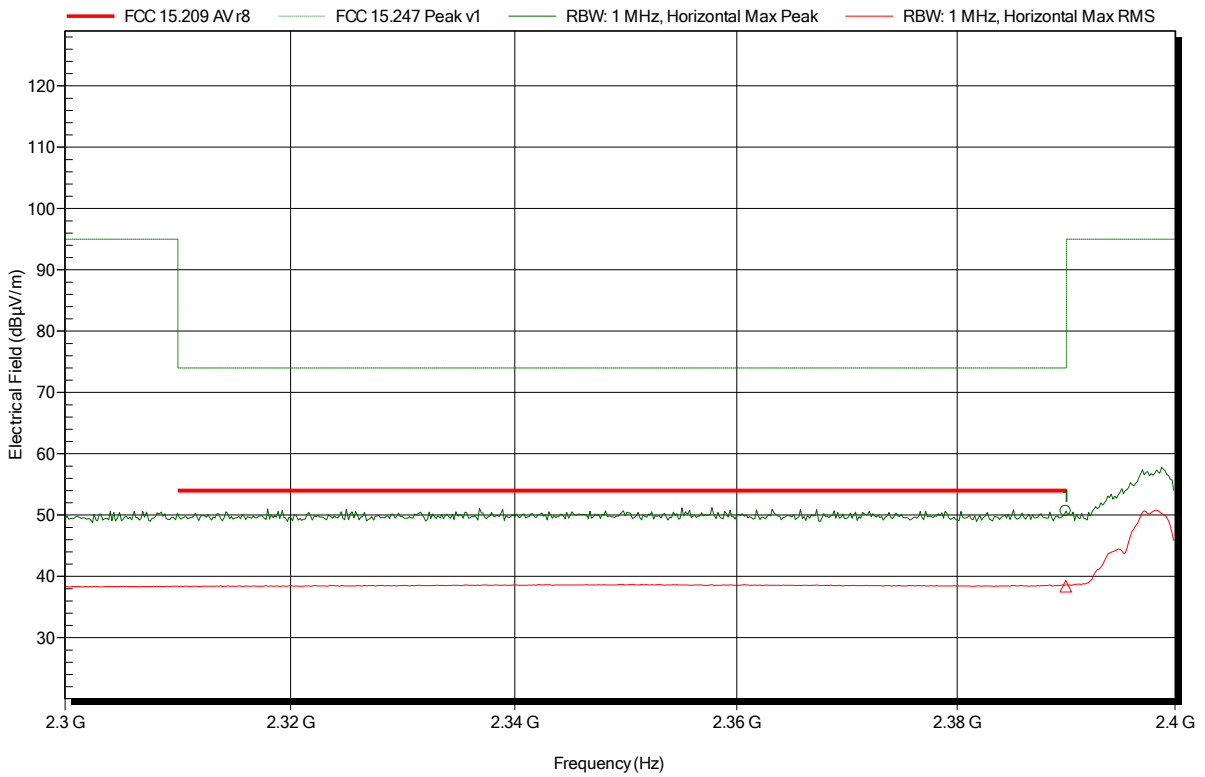

Frequency	Peak	Peak Limit	Peak Difference	Peak Status
2.3899 GHz	50.63 dBµV/m	74 dBµV/m	-23.37 dB	Pass
Frequency	RMS	RMS Limit	RMS Difference	RMS Status
2.3899 GHz	38.42 dBµV/m	54 dBµV/m	-15.58 dB	Pass

Spurious emissions according to FCC 15.247

Project number: G0M-1812-7888

Applicant: Leica Geosystems AG
 EUT Name: Field Controller Win EC7
 Model: CS20 LTE Disto (US, CA)
 Test Site: Eurofins Product Service GmbH
 Operator: Wilfried Treffke
 Test Conditions: Tnom: 22°C, Vnom: Vnom: 120V AC (intern 11.1 V DC)
 Antenna: Schwarzbeck BBHA 9120D, Vertical
 Measurement distance: 1 m converted to 3m
 Mode: TX; IEEE 802.11b; 1Mbps; 2412 MHz
 Test Date: 2019-02-09
 Note: lower bandedge

Index 41

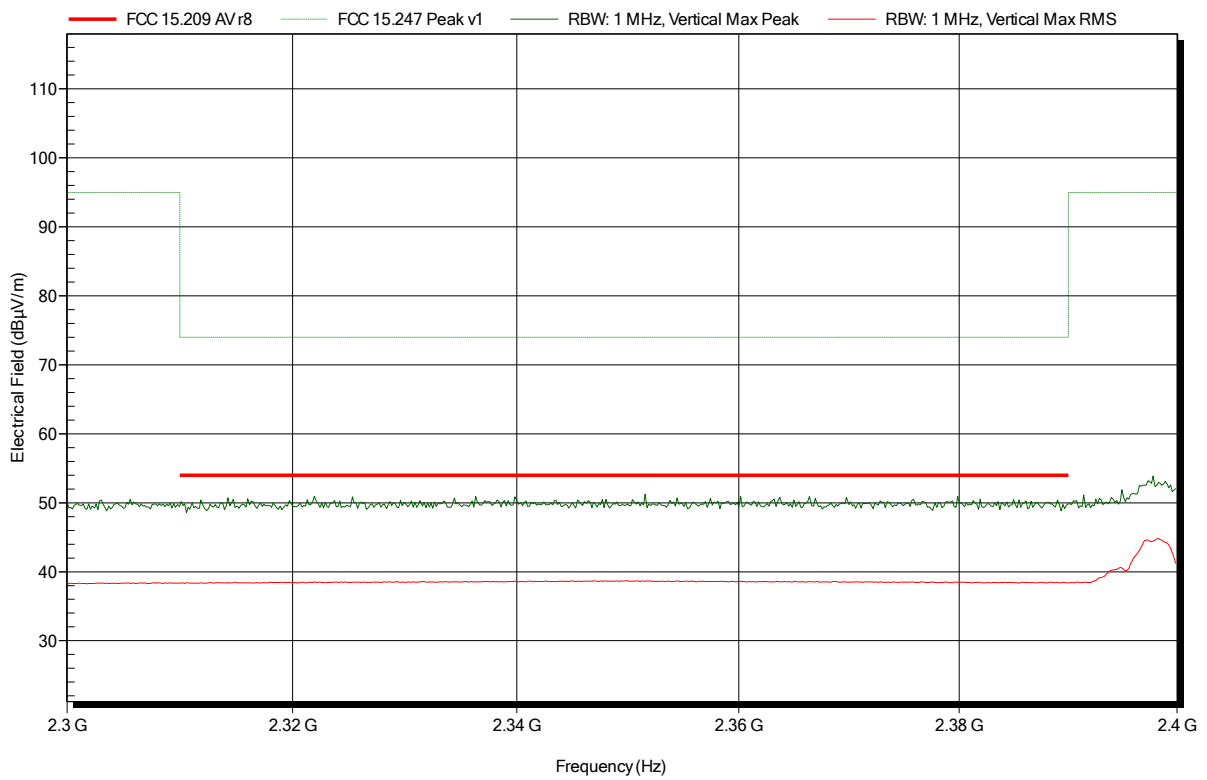

Spurious emissions according to FCC 15.247

Project number: G0M-1812-7888

Applicant: Leica Geosystems AG
 EUT Name: Field Controller Win EC7
 Model: CS20 LTE Disto (US, CA)
 Test Site: Eurofins Product Service GmbH
 Operator: Wilfried Treffke
 Test Conditions: Tnom: 22°C, Vnom: Vnom: 120V AC (intern 11.1 V DC)
 Antenna: Schwarzbeck BBHA 9120D, Horizontal
 Measurement distance: 1 m converted to 3m
 Mode: TX; IEEE 802.11b; 1Mbps; 2412 MHz
 Test Date: 2019-02-09
 Note:

Index 37

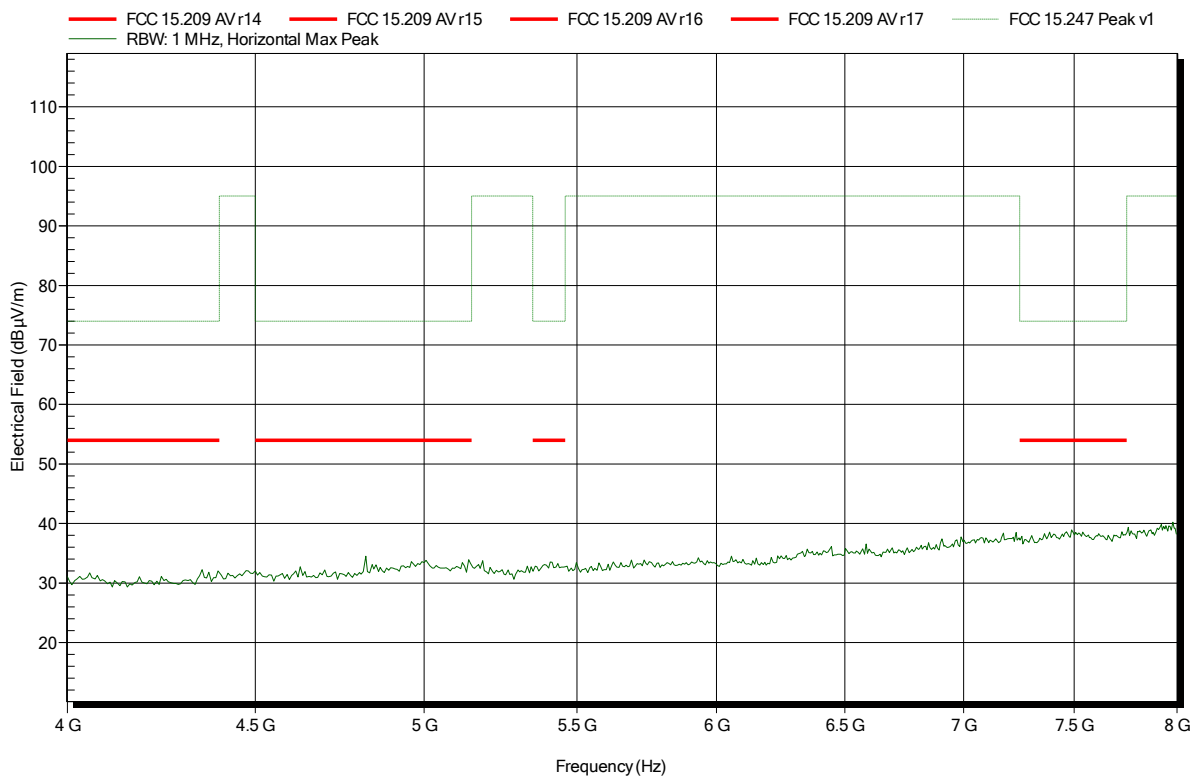

Spurious emissions according to FCC 15.247

Project number: G0M-1812-7888

Applicant: Leica Geosystems AG
 EUT Name: Field Controller Win EC7
 Model: CS20 LTE Disto (US, CA)
 Test Site: Eurofins Product Service GmbH
 Operator: Wilfried Treffke
 Test Conditions: Tnom: 22°C, Vnom: Vnom: 120V AC (intern 11.1 V DC)
 Antenna: Schwarzbeck BBHA 9120D, Vertical
 Measurement distance: 1 m converted to 3m
 Mode: TX; IEEE 802.11b; 1Mbps; 2412 MHz
 Test Date: 2019-02-09
 Note:

Index 42

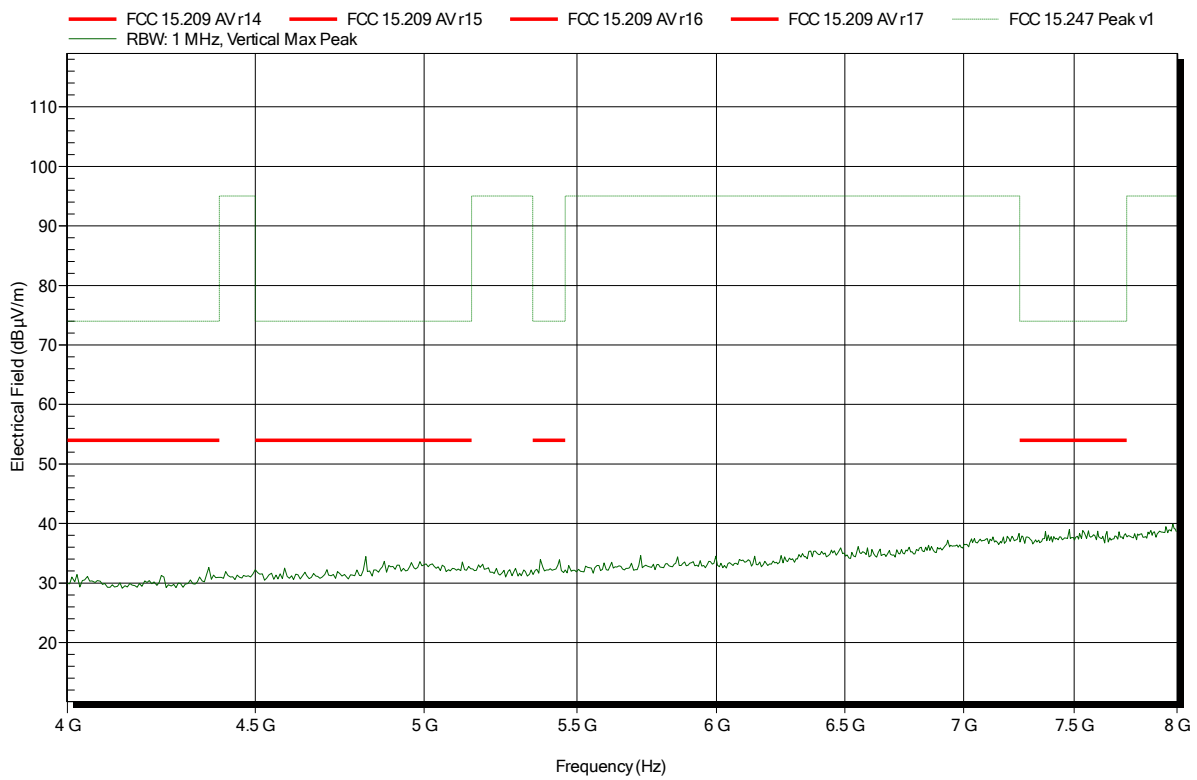

Spurious emissions according to FCC 15.247

Project number: G0M-1812-7888

Applicant: Leica Geosystems AG
 EUT Name: Field Controller Win EC7
 Model: CS20 LTE Disto (US, CA)
 Test Site: Eurofins Product Service GmbH
 Operator: Wilfried Treffke
 Test Conditions: Tnom: 22°C, Vnom: Vnom: 120V AC (intern 11.1 V DC)
 Antenna: Schwarzbeck BBHA 9120D, Horizontal
 Measurement distance: 1 m converted to 3m
 Mode: TX; IEEE 802.11b; 1Mbps; 2412 MHz
 Test Date: 2019-02-09
 Note:

Index 38

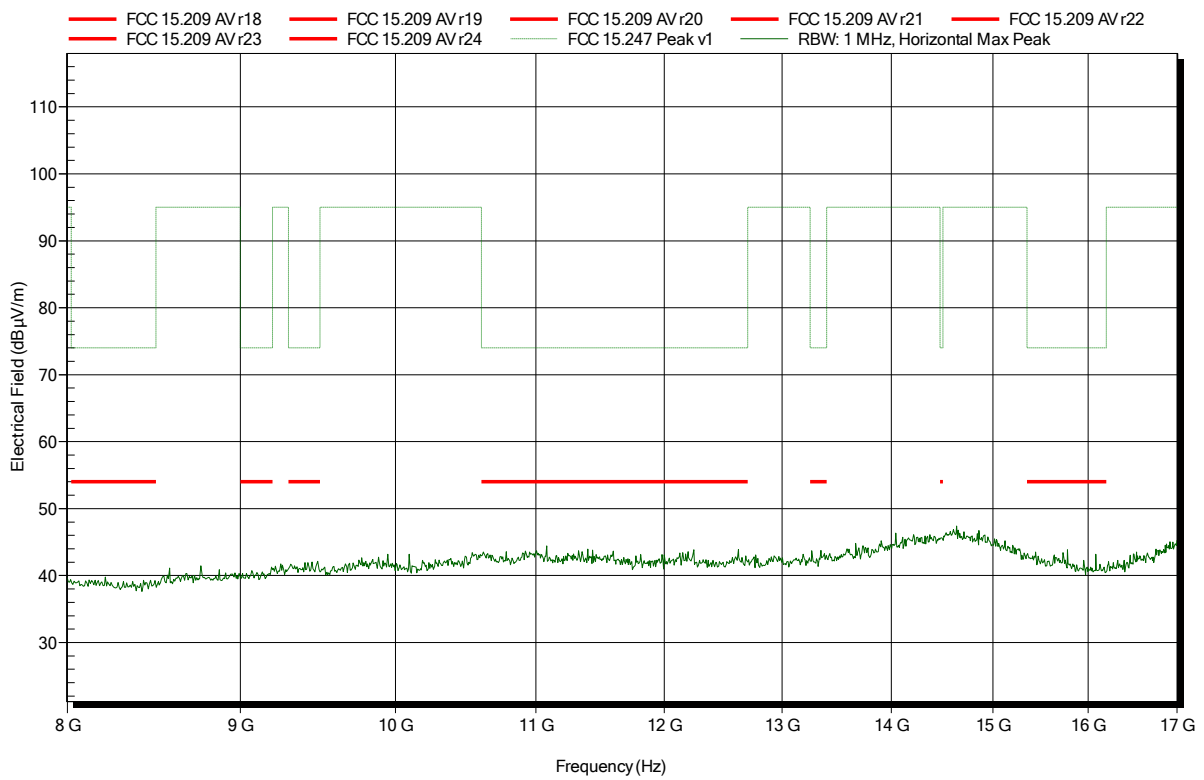

Spurious emissions according to FCC 15.247

Project number: G0M-1812-7888

Applicant: Leica Geosystems AG
 EUT Name: Field Controller Win EC7
 Model: CS20 LTE Disto (US, CA)
 Test Site: Eurofins Product Service GmbH
 Operator: Wilfried Treffke
 Test Conditions: Tnom: 22°C, Vnom: Vnom: 120V AC (intern 11.1 V DC)
 Antenna: Schwarzbeck BBHA 9120D, Vertical
 Measurement distance: 1 m converted to 3m
 Mode: TX; IEEE 802.11b; 1Mbps; 2412 MHz
 Test Date: 2019-02-09
 Note:

Index 43

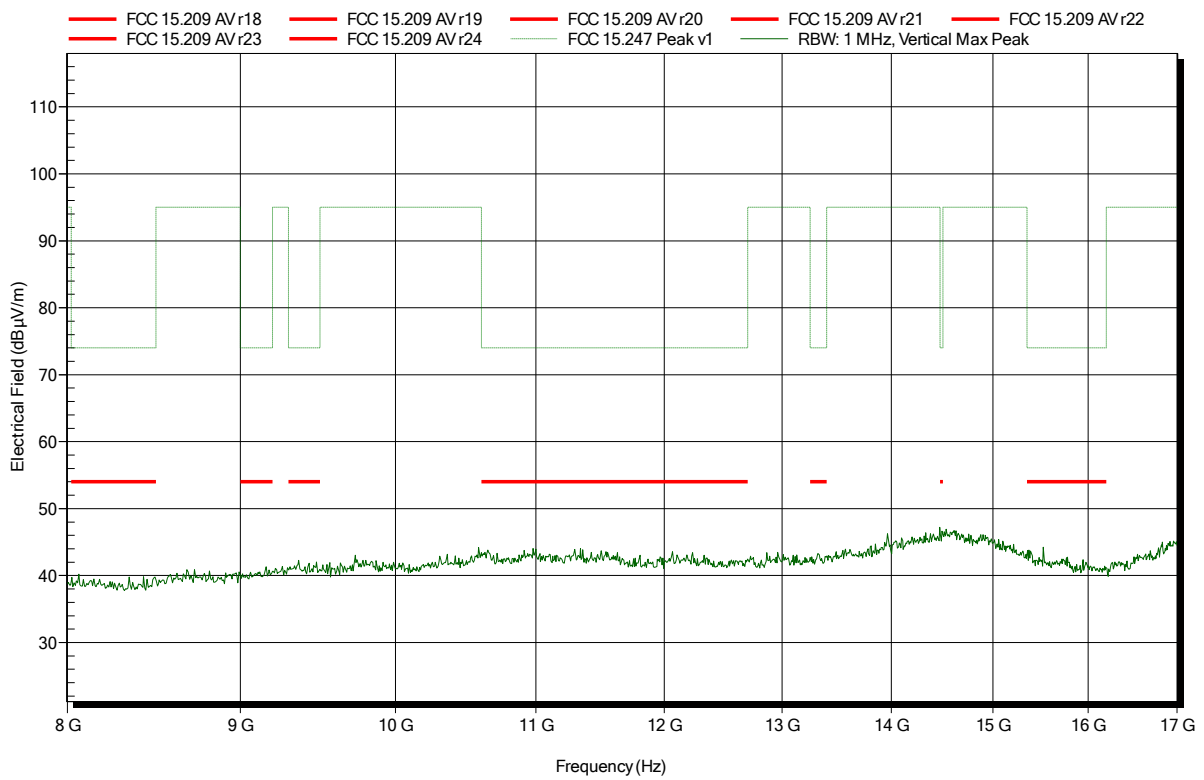

Spurious emissions according to FCC 15.247

Project number: G0M-1812-7888

Applicant: Leica Geosystems AG
 EUT Name: Field Controller Win EC7
 Model: CS20 LTE Disto (US, CA)
 Test Site: Eurofins Product Service GmbH
 Operator: Wilfried Treffke
 Test Conditions: Tnom: 22°C, Vnom: Vnom: 120V AC (intern 11.1 V DC)
 Antenna: Amplifier Research AT4560, Horizontal
 Measurement distance: 1 m converted to 3m
 Mode: TX; IEEE 802.11b; 1Mbps; 2412 MHz
 Test Date: 2019-02-09
 Note:

Index 39

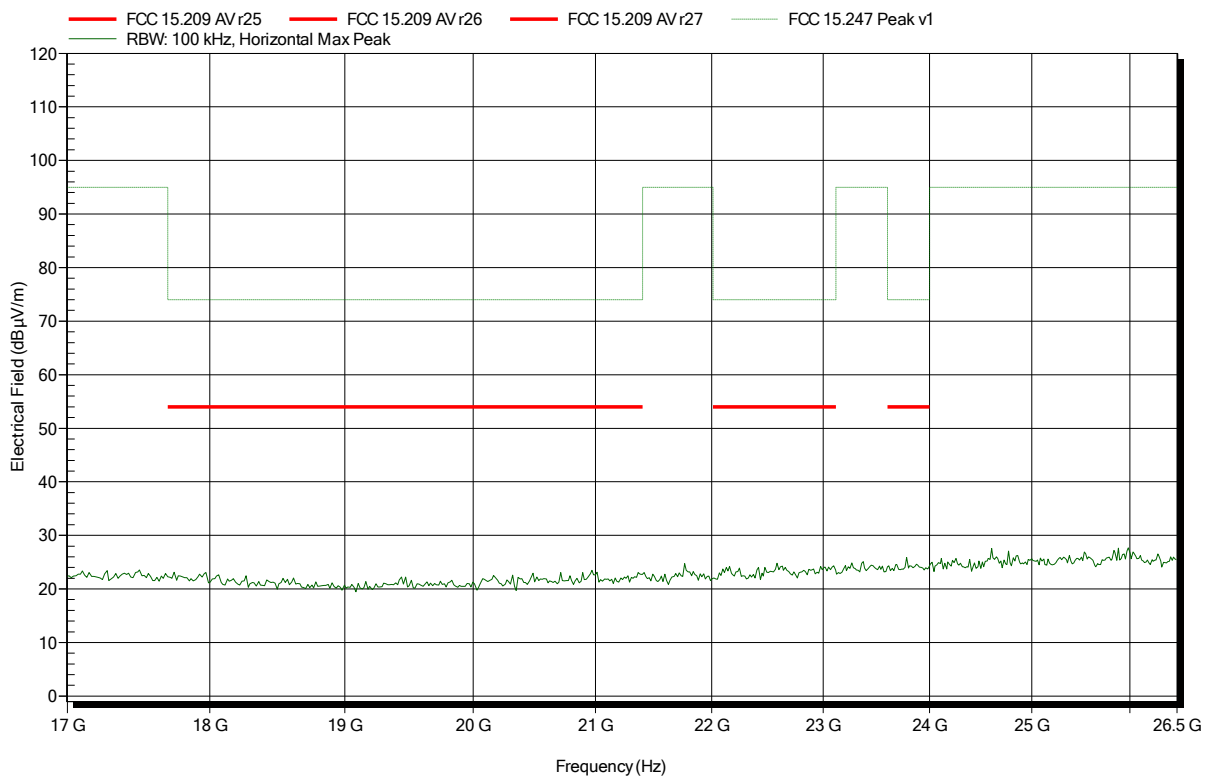

Spurious emissions according to FCC 15.247

Project number: G0M-1812-7888

Applicant: Leica Geosystems AG
 EUT Name: Field Controller Win EC7
 Model: CS20 LTE Disto (US, CA)
 Test Site: Eurofins Product Service GmbH
 Operator: Wilfried Treffke
 Test Conditions: Tnom: 22°C, Vnom: Vnom: 120V AC (intern 11.1 V DC)
 Antenna: Amplifier Research AT4560, Vertical
 Measurement distance: 1 m converted to 3m
 Mode: TX; IEEE 802.11b; 1Mbps; 2412 MHz
 Test Date: 2019-02-09
 Note:

Index 44

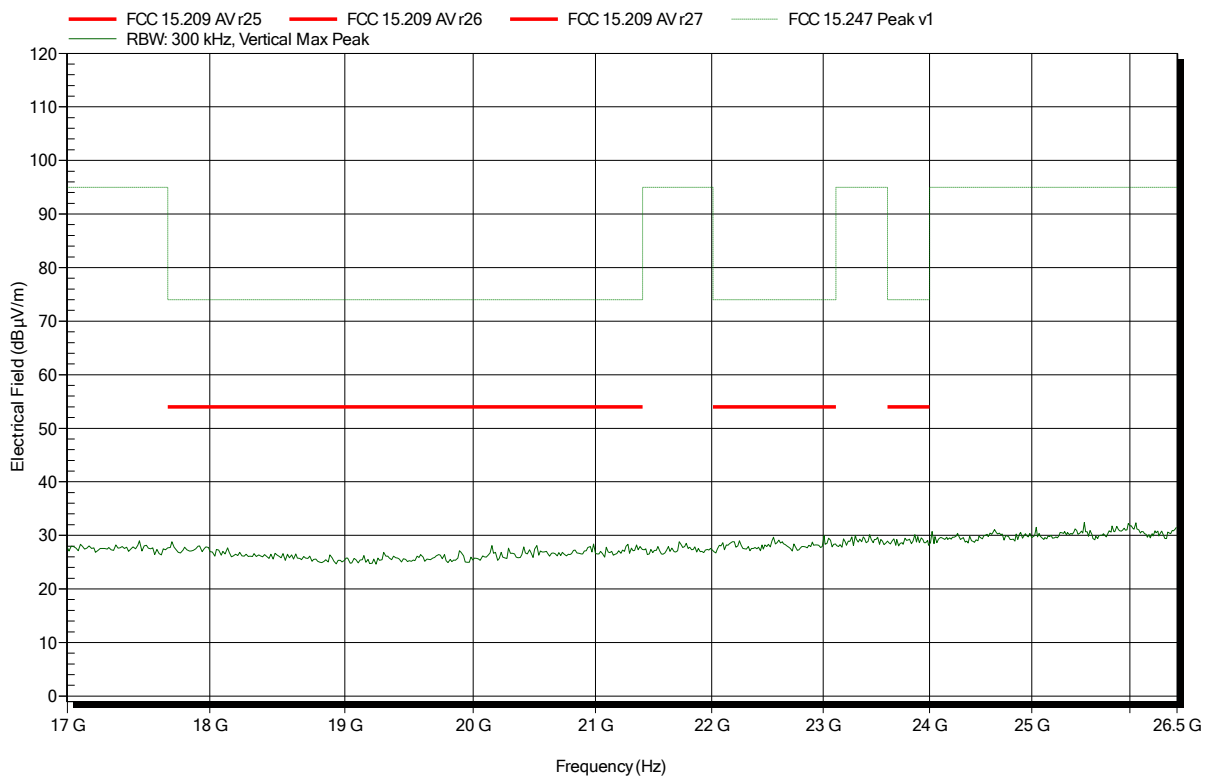

Spurious emissions according to FCC 15.247

Project number: G0M-1812-7888

Applicant: Leica Geosystems AG
 EUT Name: Field Controller Win EC7
 Model: CS20 LTE Disto (US, CA)
 Test Site: Eurofins Product Service GmbH
 Operator: Wilfried Treffke
 Test Conditions: Tnom: 22°C, Vnom: Vnom: 120V AC (intern 11.1 V DC)
 Antenna: Schwarzbeck BBHA 9120D, Horizontal
 Measurement distance: 1 m converted to 3m
 Mode: TX; IEEE 802.11b; 1Mbps; 2437 MHz
 Test Date: 2019-02-09
 Note:

Index 45

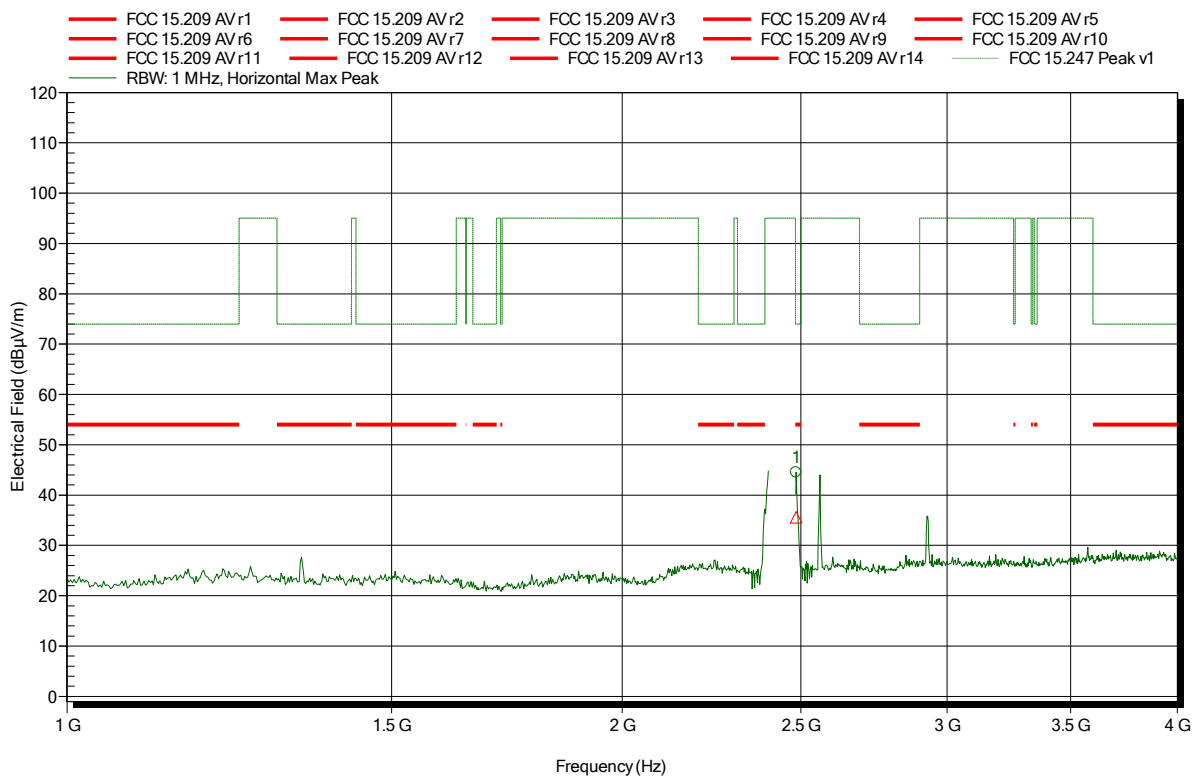

Frequency	Peak	Peak Limit	Peak Difference	Peak Status
2.485 GHz	44.53 dBµV/m	74 dBµV/m	-29.47 dB	Pass
Frequency	RMS	RMS Limit	RMS Difference	RMS Status
2.485 GHz	35.59 dBµV/m	54 dBµV/m	-18.41 dB	Pass

Spurious emissions according to FCC 15.247

Project number: G0M-1812-7888

Applicant: Leica Geosystems AG
 EUT Name: Field Controller Win EC7
 Model: CS20 LTE Disto (US, CA)
 Test Site: Eurofins Product Service GmbH
 Operator: Wilfried Treffke
 Test Conditions: Tnom: 22°C, Vnom: Vnom: 120V AC (intern 11.1 V DC)
 Antenna: Schwarzbeck BBHA 9120D, Vertical
 Measurement distance: 1 m converted to 3m
 Mode: TX; IEEE 802.11b; 1Mbps; 2437 MHz
 Test Date: 2019-02-09
 Note:

Index 49

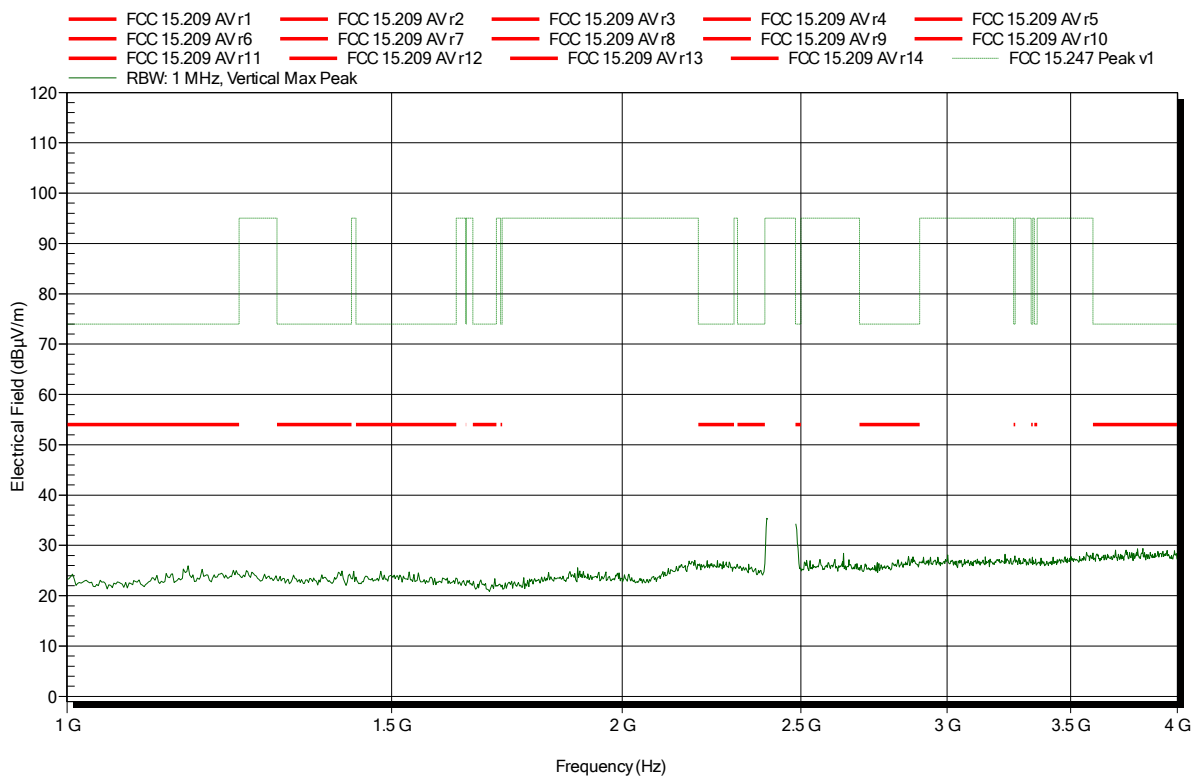

Spurious emissions according to FCC 15.247

Project number: G0M-1812-7888

Applicant: Leica Geosystems AG
 EUT Name: Field Controller Win EC7
 Model: CS20 LTE Disto (US, CA)
 Test Site: Eurofins Product Service GmbH
 Operator: Wilfried Treffke
 Test Conditions: Tnom: 22°C, Vnom: Vnom: 120V AC (intern 11.1 V DC)
 Antenna: Schwarzbeck BBHA 9120D, Horizontal
 Measurement distance: 1 m converted to 3m
 Mode: TX; IEEE 802.11b; 1Mbps; 2437 MHz
 Test Date: 2019-02-09
 Note:

Index 46

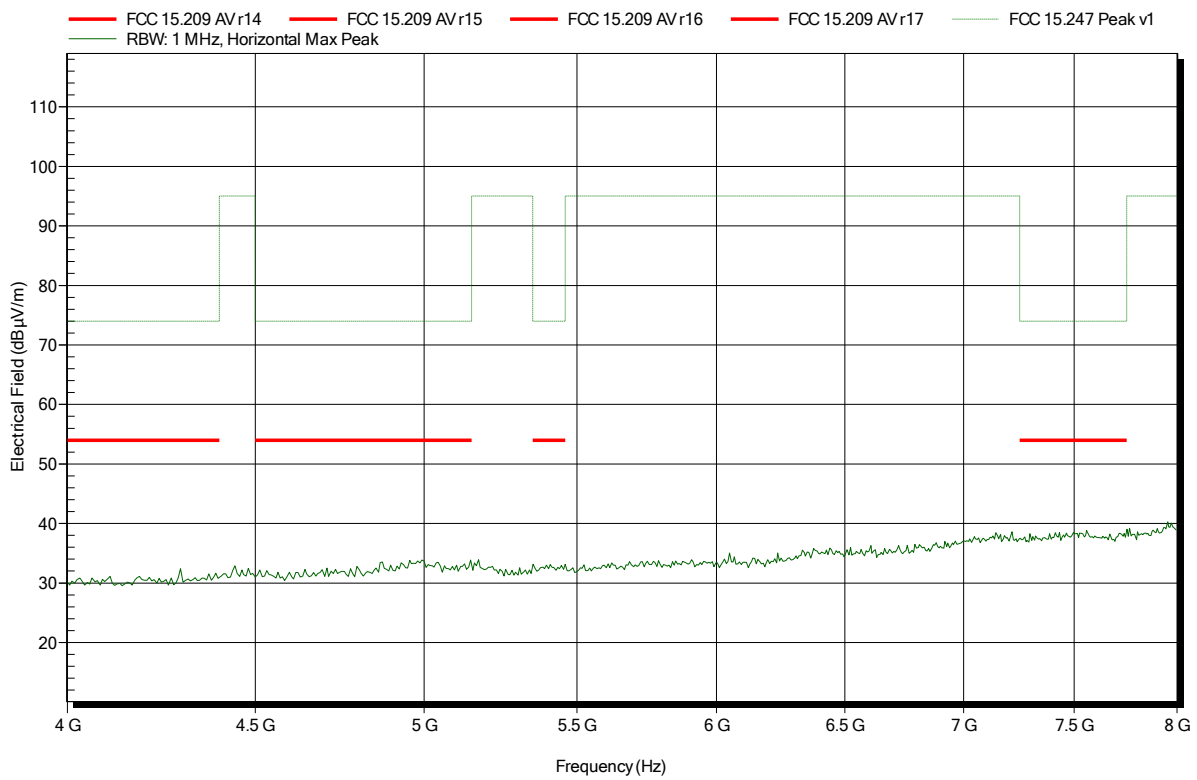

Spurious emissions according to FCC 15.247

Project number: G0M-1812-7888

Applicant: Leica Geosystems AG
 EUT Name: Field Controller Win EC7
 Model: CS20 LTE Disto (US, CA)
 Test Site: Eurofins Product Service GmbH
 Operator: Wilfried Treffke
 Test Conditions: Tnom: 22°C, Vnom: Vnom: 120V AC (intern 11.1 V DC)
 Antenna: Schwarzbeck BBHA 9120D, Vertical
 Measurement distance: 1 m converted to 3m
 Mode: TX; IEEE 802.11b; 1Mbps; 2437 MHz
 Test Date: 2019-02-09
 Note:

Index 50

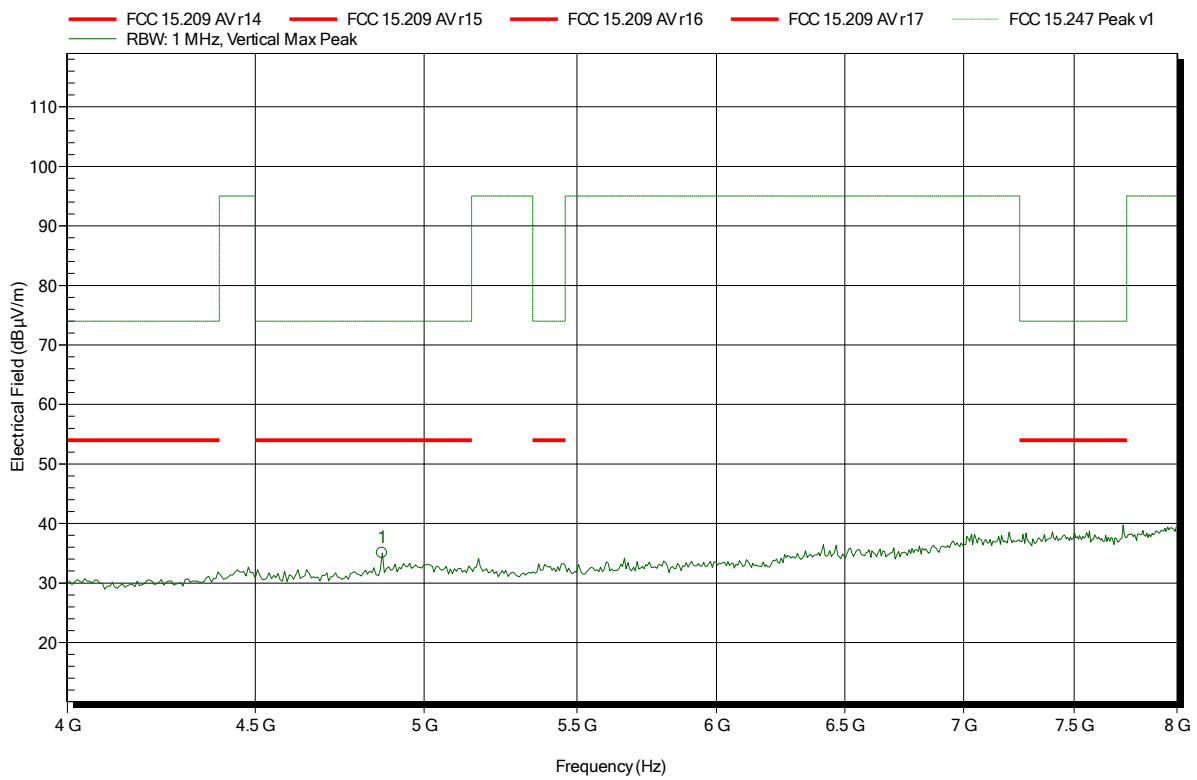

Frequency	Peak	Peak Limit	Peak Difference	Peak Status
4.87 GHz	35.03 dBµV/m	74 dBµV/m	-38.97 dB	Pass

Spurious emissions according to FCC 15.247

Project number: G0M-1812-7888

Applicant: Leica Geosystems AG
 EUT Name: Field Controller Win EC7
 Model: CS20 LTE Disto (US, CA)
 Test Site: Eurofins Product Service GmbH
 Operator: Wilfried Treffke
 Test Conditions: Tnom: 22°C, Vnom: Vnom: 120V AC (intern 11.1 V DC)
 Antenna: Schwarzbeck BBHA 9120D, Horizontal
 Measurement distance: 1 m converted to 3m
 Mode: TX; IEEE 802.11b; 1Mbps; 2437 MHz
 Test Date: 2019-02-09
 Note:

Index 47

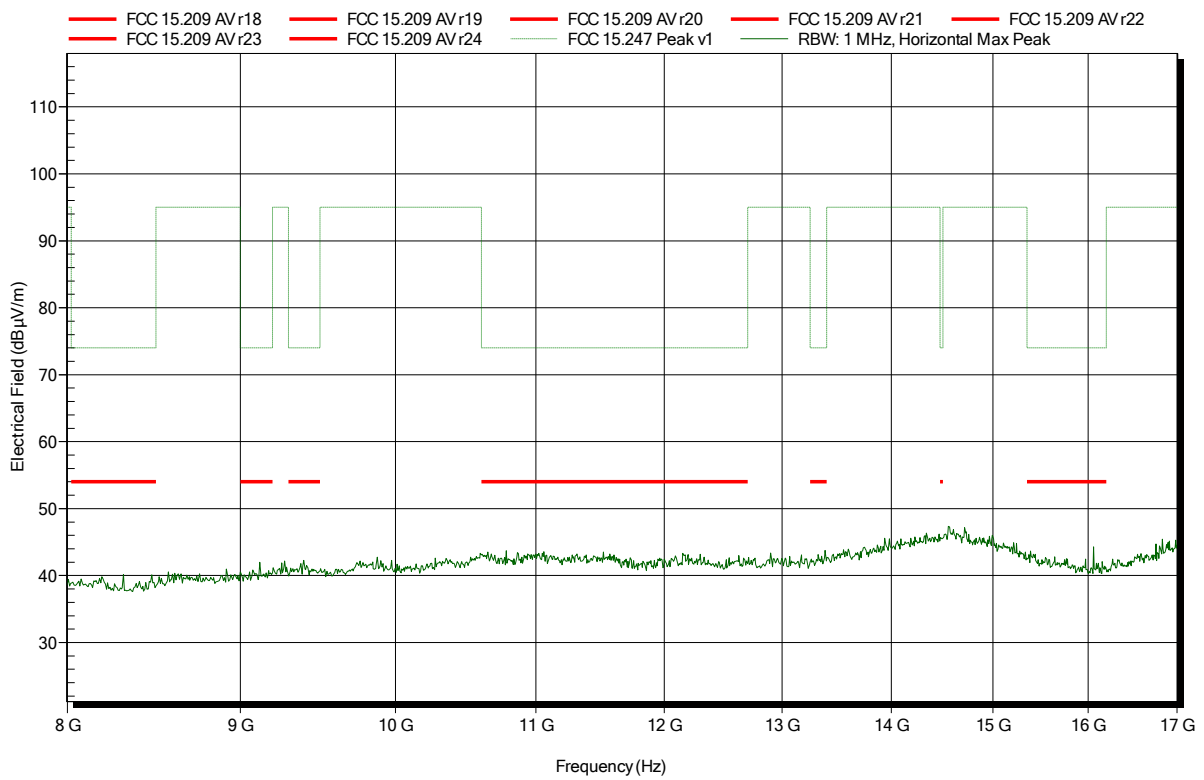

Spurious emissions according to FCC 15.247

Project number: G0M-1812-7888

Applicant: Leica Geosystems AG
 EUT Name: Field Controller Win EC7
 Model: CS20 LTE Disto (US, CA)
 Test Site: Eurofins Product Service GmbH
 Operator: Wilfried Treffke
 Test Conditions: Tnom: 22°C, Vnom: Vnom: 120V AC (intern 11.1 V DC)
 Antenna: Schwarzbeck BBHA 9120D, Vertical
 Measurement distance: 1 m converted to 3m
 Mode: TX; IEEE 802.11b; 1Mbps; 2437 MHz
 Test Date: 2019-02-09
 Note:

Index 51

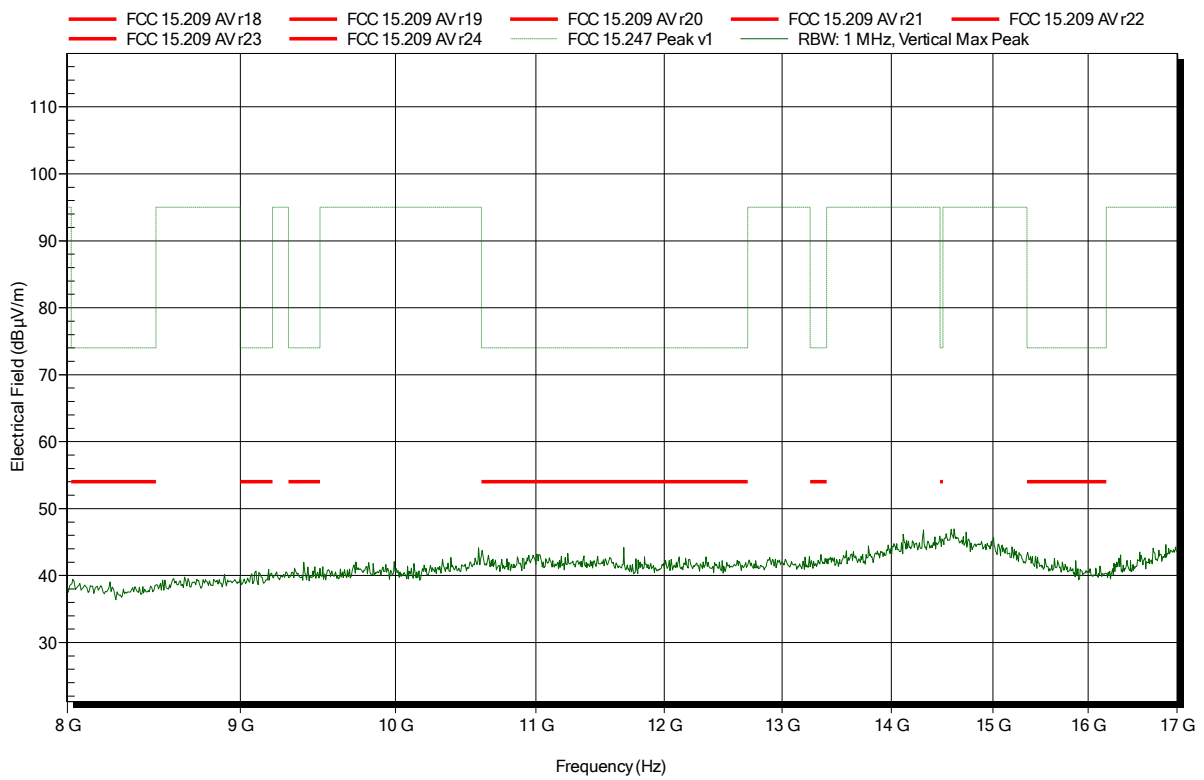

Spurious emissions according to FCC 15.247

Project number: G0M-1812-7888

Applicant: Leica Geosystems AG
 EUT Name: Field Controller Win EC7
 Model: CS20 LTE Disto (US, CA)
 Test Site: Eurofins Product Service GmbH
 Operator: Wilfried Treffke
 Test Conditions: Tnom: 22°C, Vnom: Vnom: 120V AC (intern 11.1 V DC)
 Antenna: Amplifier Research AT4560, Horizontal
 Measurement distance: 1 m converted to 3m
 Mode: TX; IEEE 802.11b; 1Mbps; 2437 MHz
 Test Date: 2019-02-09
 Note:

Index 48

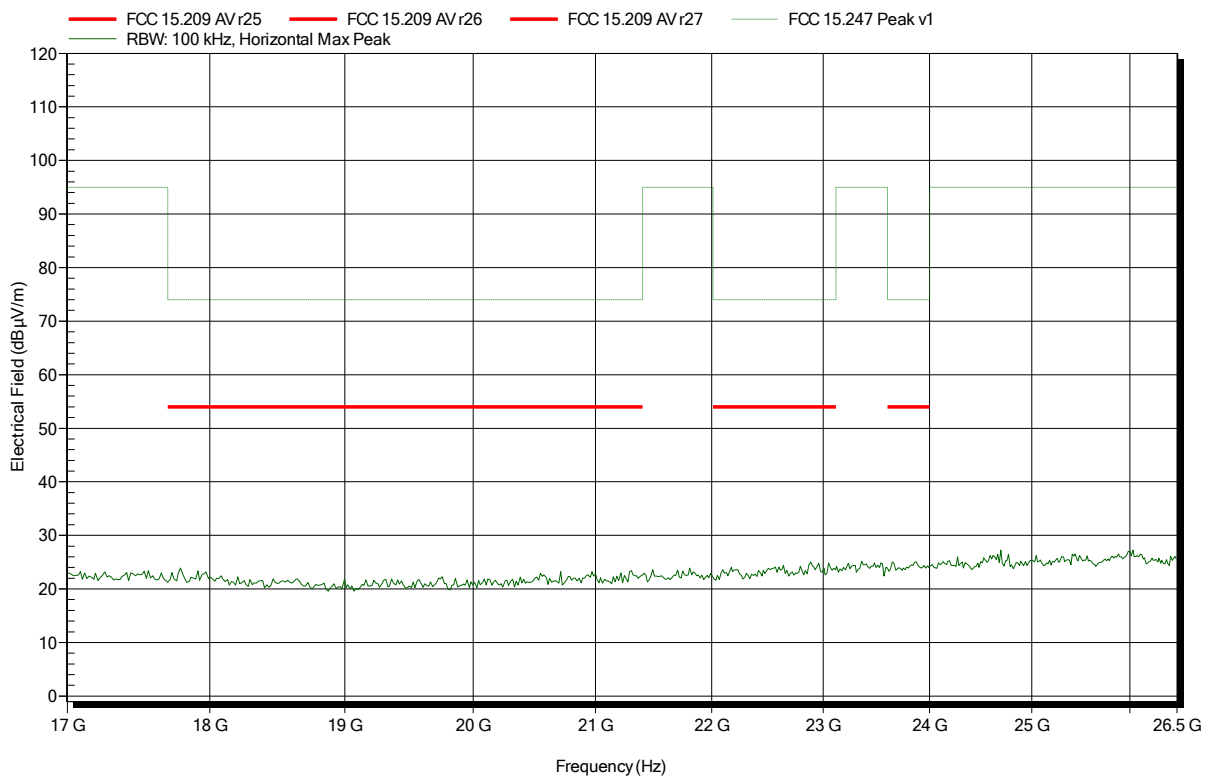

Spurious emissions according to FCC 15.247

Project number: G0M-1812-7888

Applicant: Leica Geosystems AG
 EUT Name: Field Controller Win EC7
 Model: CS20 LTE Disto (US, CA)
 Test Site: Eurofins Product Service GmbH
 Operator: Wilfried Treffke
 Test Conditions: Tnom: 22°C, Vnom: Vnom: 120V AC (intern 11.1 V DC)
 Antenna: Amplifier Research AT4560, Vertical
 Measurement distance: 1 m converted to 3m
 Mode: TX; IEEE 802.11b; 1Mbps; 2437 MHz
 Test Date: 2019-02-09
 Note:

Index 52

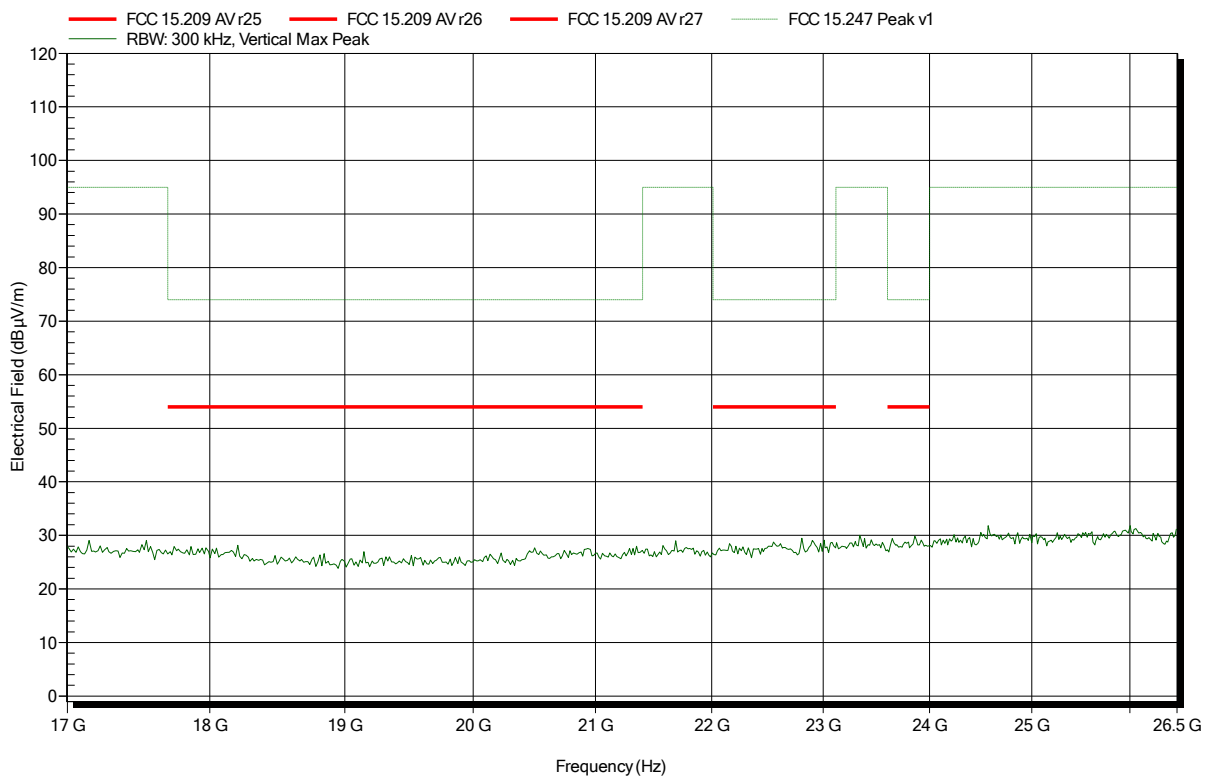

Spurious emissions according to FCC 15.247

Project number: G0M-1812-7888

Applicant: Leica Geosystems AG
 EUT Name: Field Controller Win EC7
 Model: CS20 LTE Disto (US, CA)
 Test Site: Eurofins Product Service GmbH
 Operator: Wilfried Treffke
 Test Conditions: Tnom: 22°C, Vnom: Vnom: 120V AC (intern 11.1 V DC)
 Antenna: Schwarzbeck BBHA 9120D, Horizontal
 Measurement distance: 1 m converted to 3m
 Mode: TX; IEEE 802.11b; 1Mbps; 2462 MHz
 Test Date: 2019-02-09
 Note:

Index 53

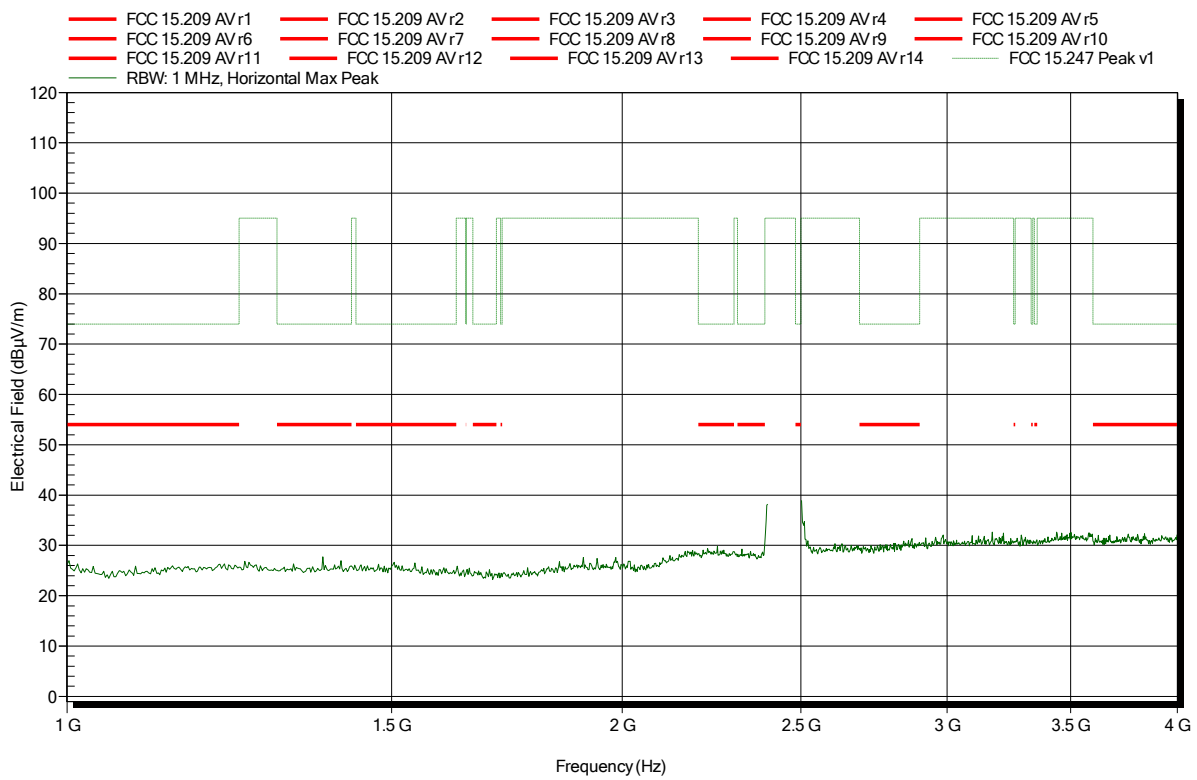

Spurious emissions according to FCC 15.247

Project number: G0M-1812-7888

Applicant: Leica Geosystems AG
 EUT Name: Field Controller Win EC7
 Model: CS20 LTE Disto (US, CA)
 Test Site: Eurofins Product Service GmbH
 Operator: Wilfried Treffke
 Test Conditions: Tnom: 22°C, Vnom: Vnom: 120V AC (intern 11.1 V DC)
 Antenna: Schwarzbeck BBHA 9120D, Vertical
 Measurement distance: 1 m converted to 3m
 Mode: TX; IEEE 802.11b; 1Mbps; 2462 MHz
 Test Date: 2019-02-11
 Note:

Index 59

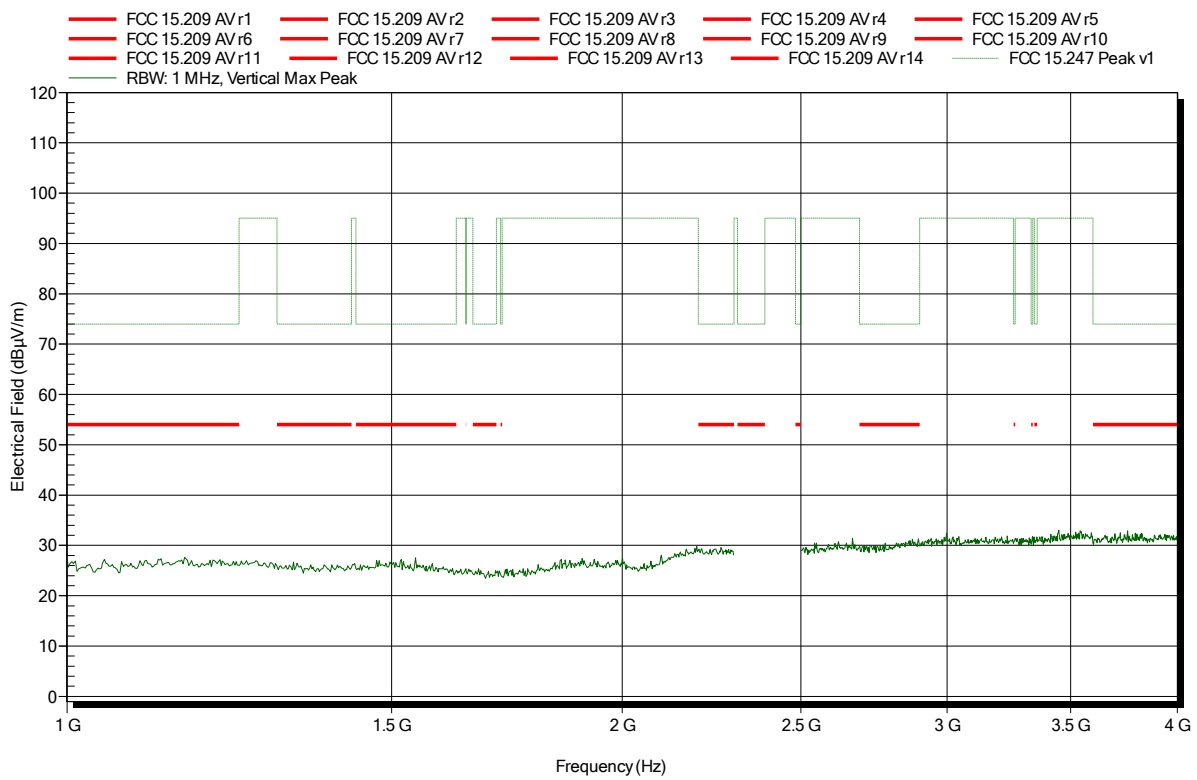

Spurious emissions according to FCC 15.247

Project number: G0M-1812-7888

Applicant: Leica Geosystems AG
 EUT Name: Field Controller Win EC7
 Model: CS20 LTE Disto (US, CA)
 Test Site: Eurofins Product Service GmbH
 Operator: Wilfried Treffke
 Test Conditions: Tnom: 22°C, Vnom: Vnom: 120V AC (intern 11.1 V DC)
 Antenna: Schwarzbeck BBHA 9120D, Horizontal
 Measurement distance: 1 m converted to 3m
 Mode: TX; IEEE 802.11b; 1Mbps; 2462 MHz
 Test Date: 2019-02-09
 Note: upper bandedge

Index 54

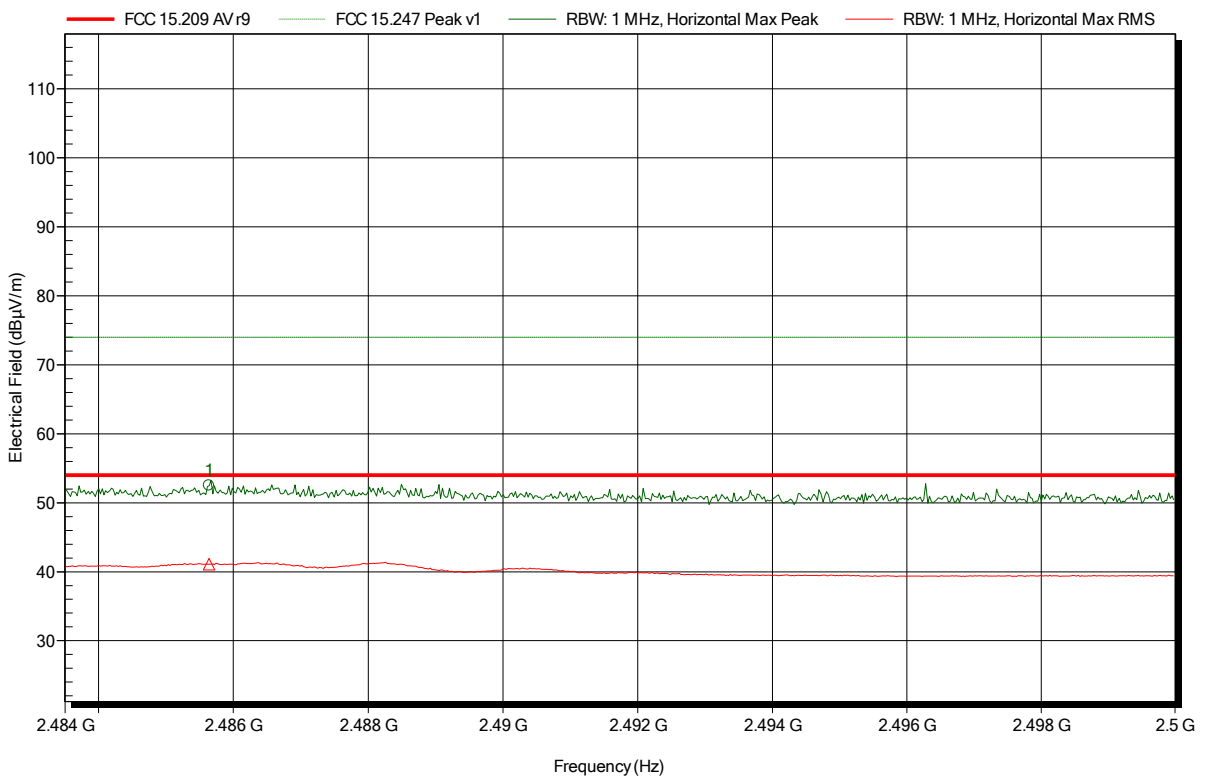

Frequency	Peak	Peak Limit	Peak Difference	Peak Status
2.4856 GHz	52.51 dBµV/m	74 dBµV/m	-21.49 dB	Pass

Frequency	RMS	RMS Limit	RMS Difference	RMS Status
2.4856 GHz	41.08 dBµV/m	54 dBµV/m	-12.92 dB	Pass

Spurious emissions according to FCC 15.247

Project number: G0M-1812-7888

Applicant: Leica Geosystems AG
 EUT Name: Field Controller Win EC7
 Model: CS20 LTE Disto (US, CA)
 Test Site: Eurofins Product Service GmbH
 Operator: Wilfried Treffke
 Test Conditions: Tnom: 22°C, Vnom: Vnom: 120V AC (intern 11.1 V DC)
 Antenna: Schwarzbeck BBHA 9120D, Vertical
 Measurement distance: 1 m converted to 3m
 Mode: TX; IEEE 802.11b; 1Mbps; 2462 MHz
 Test Date: 2019-02-11
 Note: upper bandedge

Index 60

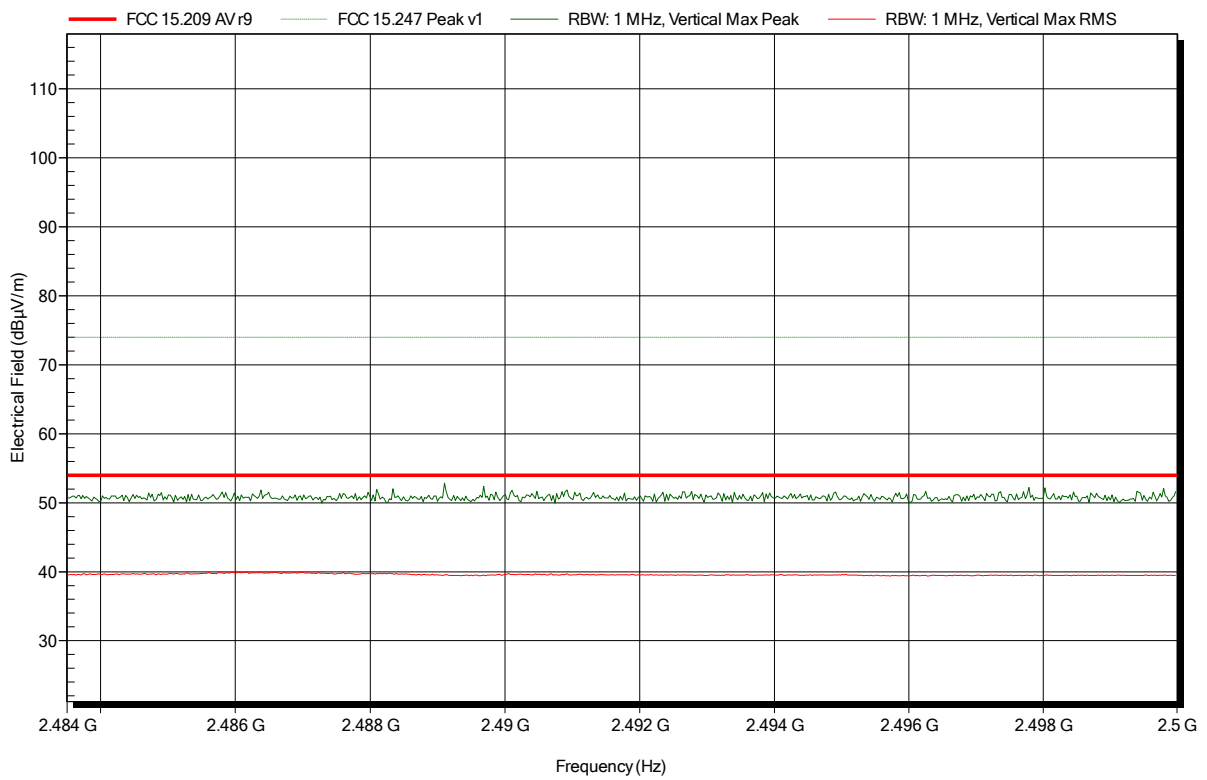

Spurious emissions according to FCC 15.247

Project number: G0M-1812-7888

Applicant: Leica Geosystems AG
 EUT Name: Field Controller Win EC7
 Model: CS20 LTE Disto (US, CA)
 Test Site: Eurofins Product Service GmbH
 Operator: Wilfried Treffke
 Test Conditions: Tnom: 22°C, Vnom: Vnom: 120V AC (intern 11.1 V DC)
 Antenna: Schwarzbeck BBHA 9120D, Horizontal
 Measurement distance: 1 m converted to 3m
 Mode: TX; IEEE 802.11b; 1Mbps; 2462 MHz
 Test Date: 2019-02-09
 Note:

Index 55

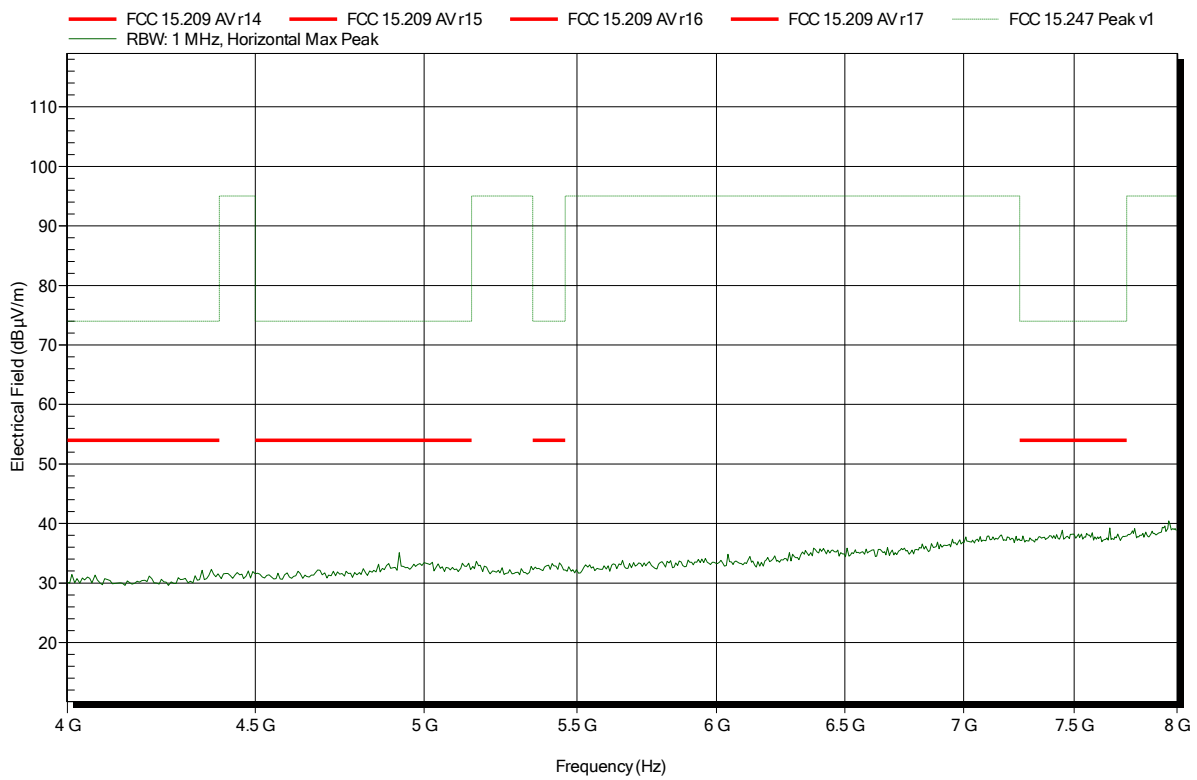

Spurious emissions according to FCC 15.247

Project number: G0M-1812-7888

Applicant: Leica Geosystems AG
 EUT Name: Field Controller Win EC7
 Model: CS20 LTE Disto (US, CA)
 Test Site: Eurofins Product Service GmbH
 Operator: Wilfried Treffke
 Test Conditions: Tnom: 22°C, Vnom: Vnom: 120V AC (intern 11.1 V DC)
 Antenna: Schwarzbeck BBHA 9120D, Vertical
 Measurement distance: 1 m converted to 3m
 Mode: TX; IEEE 802.11b; 1Mbps; 2462 MHz
 Test Date: 2019-02-11
 Note:

Index 61

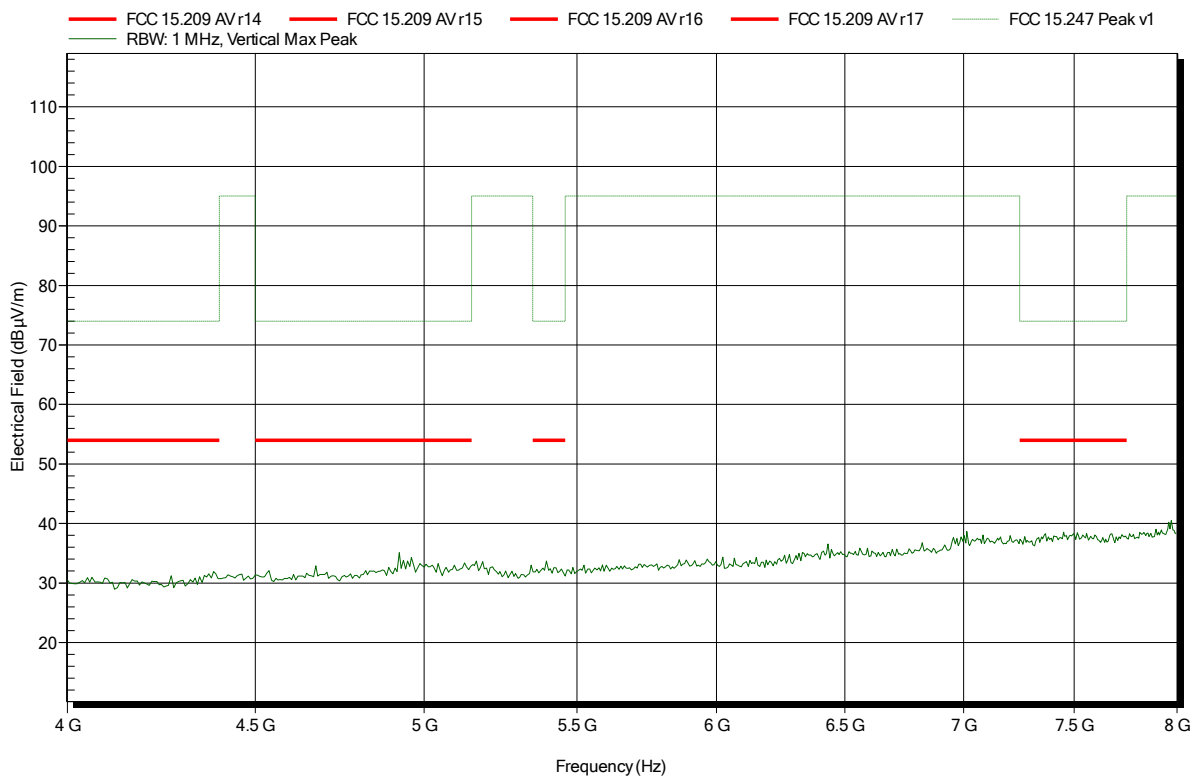

Spurious emissions according to FCC 15.247

Project number: G0M-1812-7888

Applicant: Leica Geosystems AG
 EUT Name: Field Controller Win EC7
 Model: CS20 LTE Disto (US, CA)
 Test Site: Eurofins Product Service GmbH
 Operator: Wilfried Treffke
 Test Conditions: Tnom: 22°C, Vnom: Vnom: 120V AC (intern 11.1 V DC)
 Antenna: Schwarzbeck BBHA 9120D, Horizontal
 Measurement distance: 1 m converted to 3m
 Mode: TX; IEEE 802.11b; 1Mbps; 2462 MHz
 Test Date: 2019-02-09
 Note:

Index 56

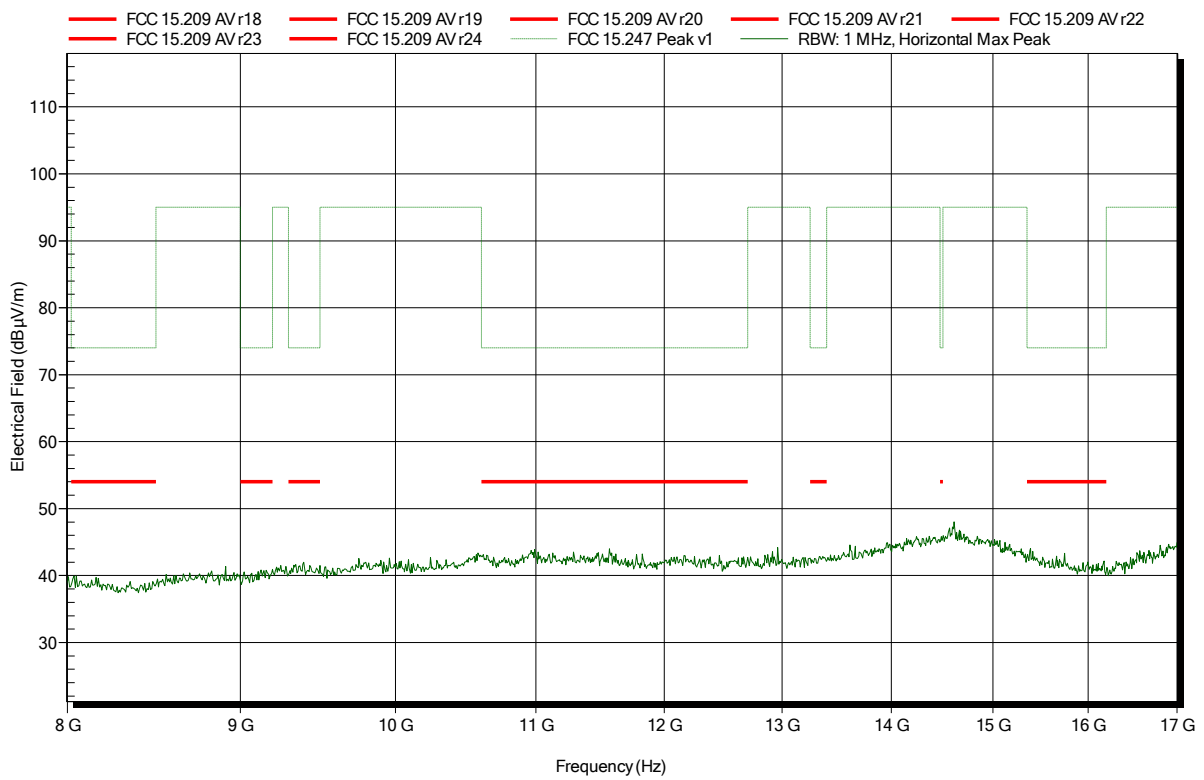

Spurious emissions according to FCC 15.247

Project number: G0M-1812-7888

Applicant: Leica Geosystems AG
 EUT Name: Field Controller Win EC7
 Model: CS20 LTE Disto (US, CA)
 Test Site: Eurofins Product Service GmbH
 Operator: Wilfried Treffke
 Test Conditions: Tnom: 22°C, Vnom: Vnom: 120V AC (intern 11.1 V DC)
 Antenna: Schwarzbeck BBHA 9120D, Vertical
 Measurement distance: 1 m converted to 3m
 Mode: TX; IEEE 802.11b; 1Mbps; 2462 MHz
 Test Date: 2019-02-11
 Note:

Index 62

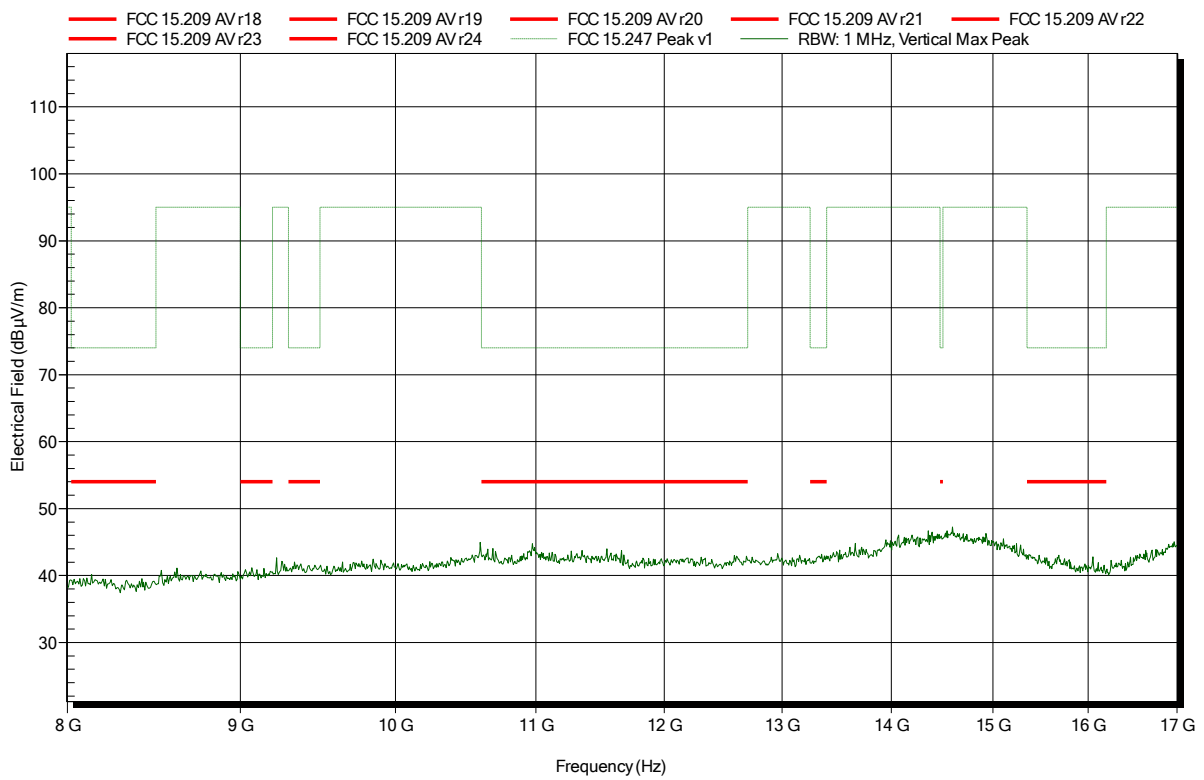

Spurious emissions according to FCC 15.247

Project number: G0M-1812-7888

Applicant: Leica Geosystems AG
 EUT Name: Field Controller Win EC7
 Model: CS20 LTE Disto (US, CA)
 Test Site: Eurofins Product Service GmbH
 Operator: Wilfried Treffke
 Test Conditions: Tnom: 22°C, Vnom: Vnom: 120V AC (intern 11.1 V DC)
 Antenna: Amplifier Research AT4560, Horizontal
 Measurement distance: 1 m converted to 3m
 Mode: TX; IEEE 802.11b; 1Mbps; 2462 MHz
 Test Date: 2019-02-09
 Note:

Index 57

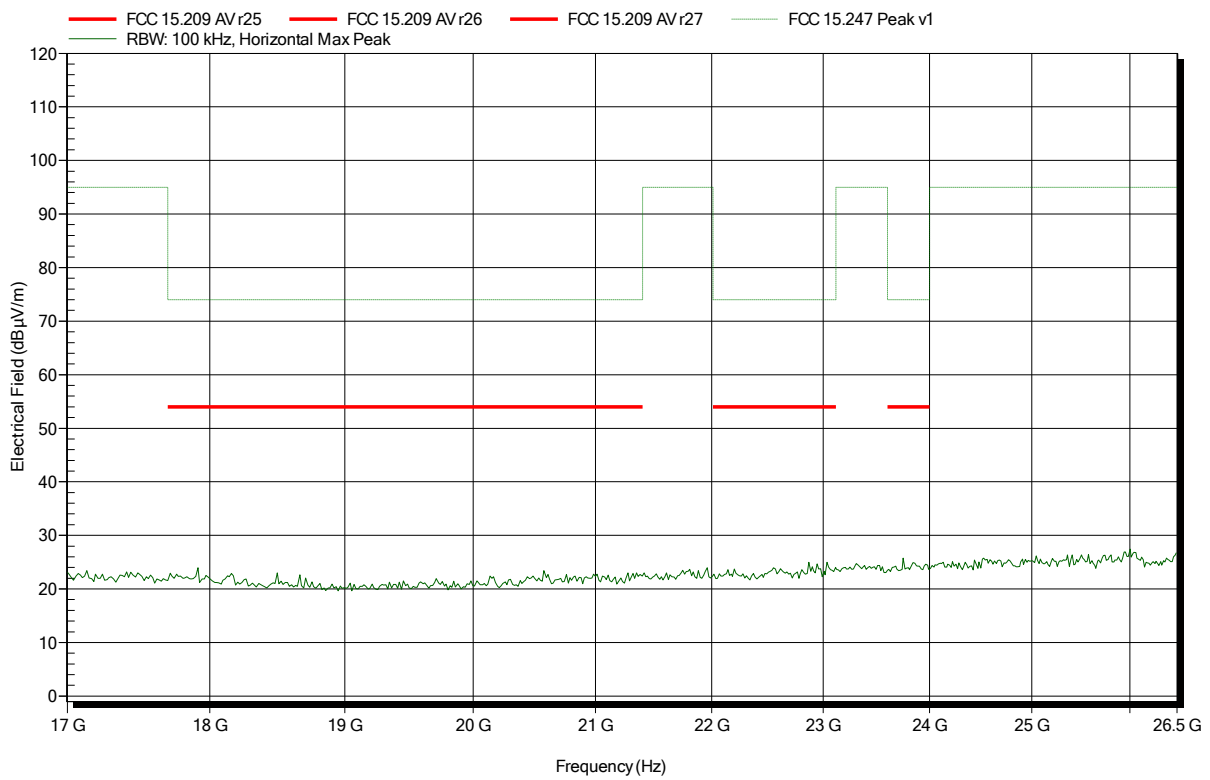

Spurious emissions according to FCC 15.247

Project number: G0M-1812-7888

Applicant: Leica Geosystems AG
 EUT Name: Field Controller Win EC7
 Model: CS20 LTE Disto (US, CA)
 Test Site: Eurofins Product Service GmbH
 Operator: Wilfried Treffke
 Test Conditions: Tnom: 22°C, Vnom: Vnom: 120V AC (intern 11.1 V DC)
 Antenna: Amplifier Research AT4560, Vertical
 Measurement distance: 1 m converted to 3m
 Mode: TX; IEEE 802.11b; 1Mbps; 2462 MHz
 Test Date: 2019-02-11
 Note:

Index 63

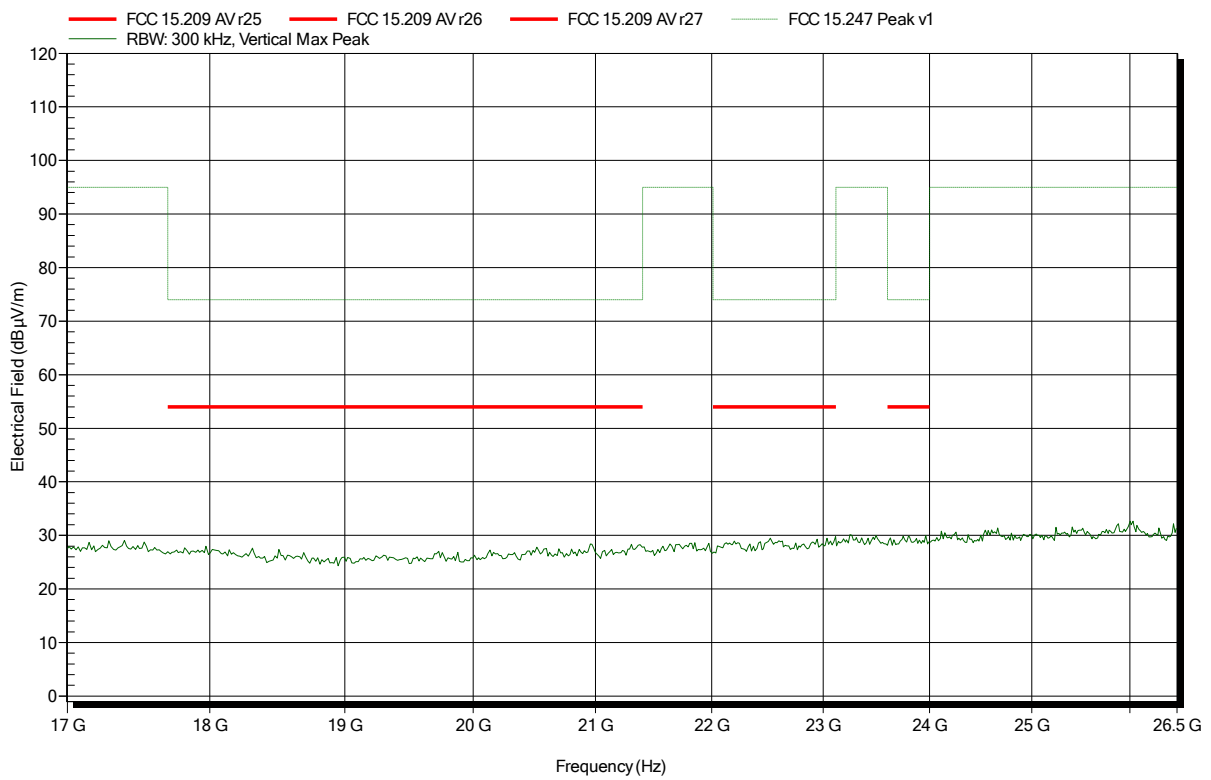

Spurious emissions according to FCC 15.247

Project number: G0M-1812-7888

Applicant: Leica Geosystems AG
 EUT Name: Field Controller Win EC7
 Model: CS20 LTE Disto (US, CA)
 Test Site: Eurofins Product Service GmbH
 Operator: Wilfried Treffke
 Test Conditions: Tnom: 22°C, Vnom: Vnom: 120V AC (intern 11.1 V DC)
 Antenna: Schwarzbeck BBHA 9120D, Horizontal
 Measurement distance: 1 m converted to 3m
 Mode: TX; IEEE 802.11g; 6Mbps; 2412 MHz
 Test Date: 2019-02-11
 Note:

Index 64

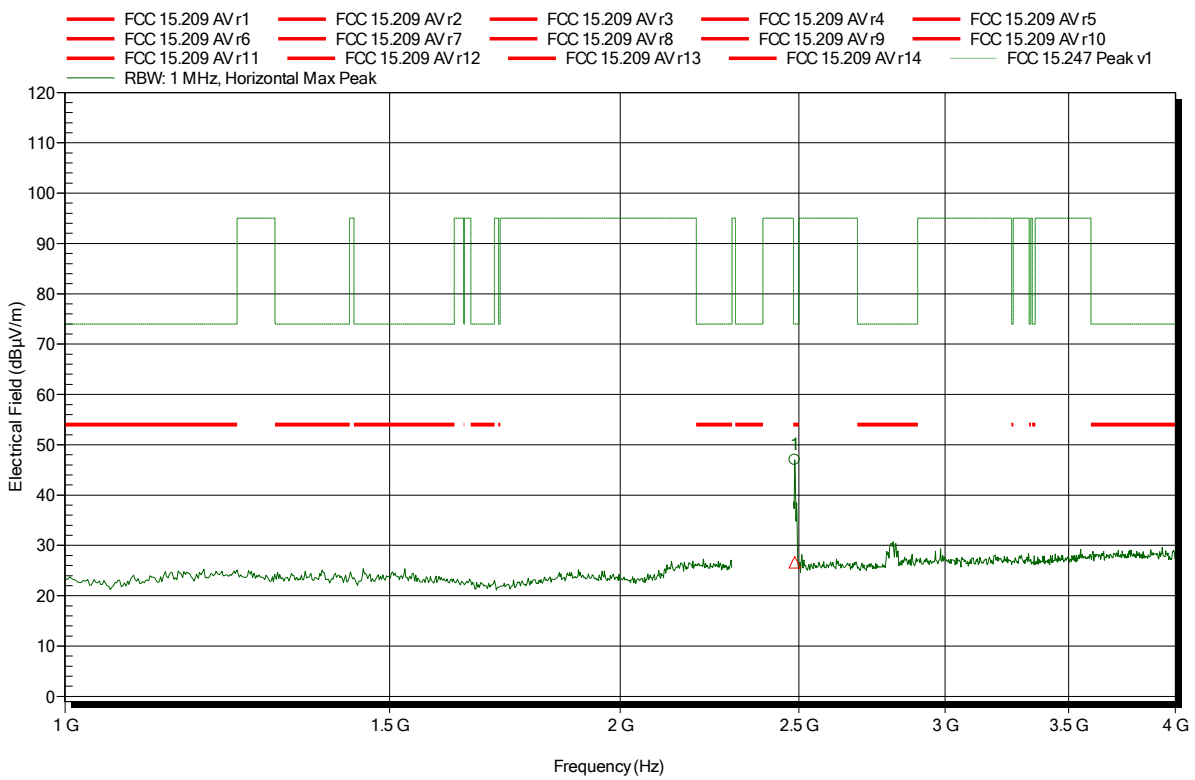

Frequency	Peak	Peak Limit	Peak Difference	Peak Status
2.4873 GHz	47.02 dBµV/m	74 dBµV/m	-26.98 dB	Pass
Frequency	RMS	RMS Limit	RMS Difference	RMS Status
2.4873 GHz	26.66 dBµV/m	54 dBµV/m	-27.34 dB	Pass

Spurious emissions according to FCC 15.247

Project number: G0M-1812-7888

Applicant: Leica Geosystems AG
 EUT Name: Field Controller Win EC7
 Model: CS20 LTE Disto (US, CA)
 Test Site: Eurofins Product Service GmbH
 Operator: Wilfried Treffke
 Test Conditions: Tnom: 22°C, Vnom: Vnom: 120V AC (intern 11.1 V DC)
 Antenna: Schwarzbeck BBHA 9120D, Vertical
 Measurement distance: 1 m converted to 3m
 Mode: TX; IEEE 802.11g; 6Mbps; 2412 MHz
 Test Date: 2019-02-11
 Note:

Index 67

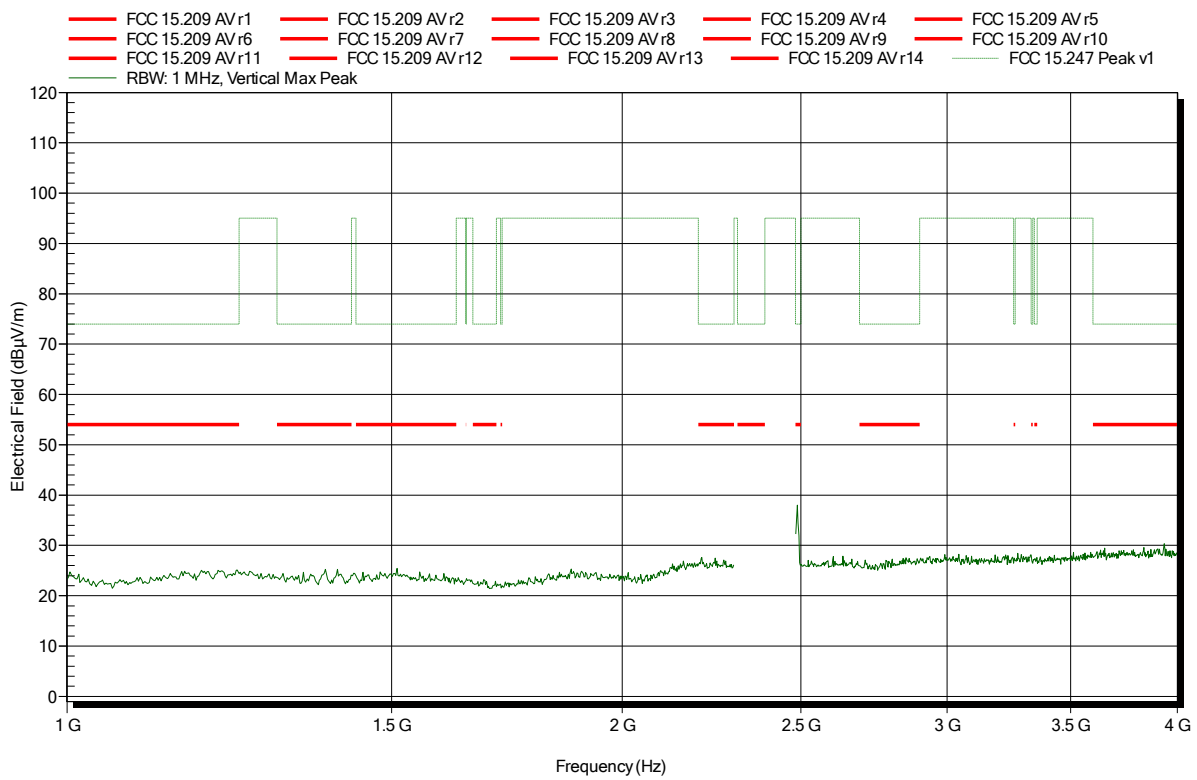

Spurious emissions according to FCC 15.247

Project number: G0M-1812-7888

Applicant: Leica Geosystems AG
 EUT Name: Field Controller Win EC7
 Model: CS20 LTE Disto (US, CA)
 Test Site: Eurofins Product Service GmbH
 Operator: Wilfried Treffke
 Test Conditions: Tnom: 22°C, Vnom: Vnom: 120V AC (intern 11.1 V DC)
 Antenna: Schwarzbeck BBHA 9120D, Horizontal
 Measurement distance: 1 m converted to 3m
 Mode: TX; IEEE 802.11g; 6Mbps; 2412 MHz
 Test Date: 2019-02-11
 Note: lower bandedge

Index 65

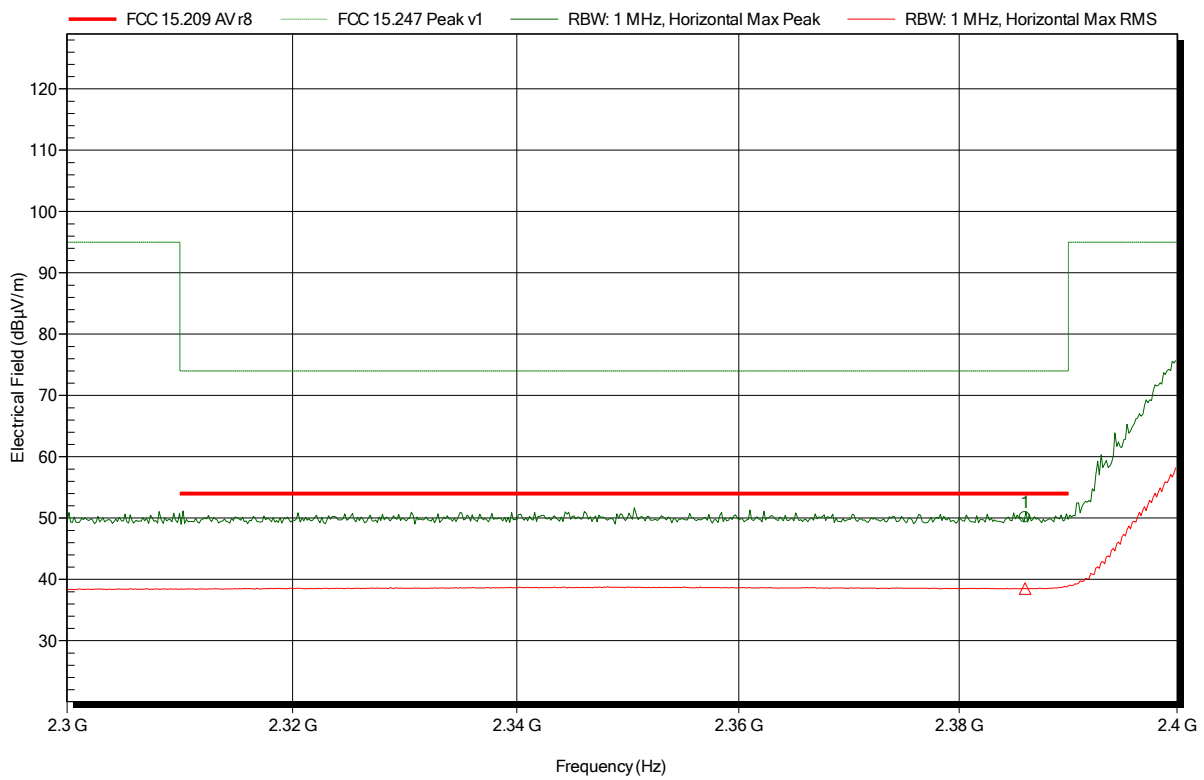

Frequency	Peak	Peak Limit	Peak Difference	Peak Status
2.386 GHz	50.15 dBµV/m	74 dBµV/m	-23.85 dB	Pass
Frequency	RMS	RMS Limit	RMS Difference	RMS Status
2.386 GHz	38.48 dBµV/m	54 dBµV/m	-15.52 dB	Pass

Spurious emissions according to FCC 15.247

Project number: G0M-1812-7888

Applicant: Leica Geosystems AG
 EUT Name: Field Controller Win EC7
 Model: CS20 LTE Disto (US, CA)
 Test Site: Eurofins Product Service GmbH
 Operator: Wilfried Treffke
 Test Conditions: Tnom: 22°C, Vnom: Vnom: 120V AC (intern 11.1 V DC)
 Antenna: Schwarzbeck BBHA 9120D, Vertical
 Measurement distance: 1 m converted to 3m
 Mode: TX; IEEE 802.11g; 6Mbps; 2412 MHz
 Test Date: 2019-02-11
 Note: lower bandedge

Index 68

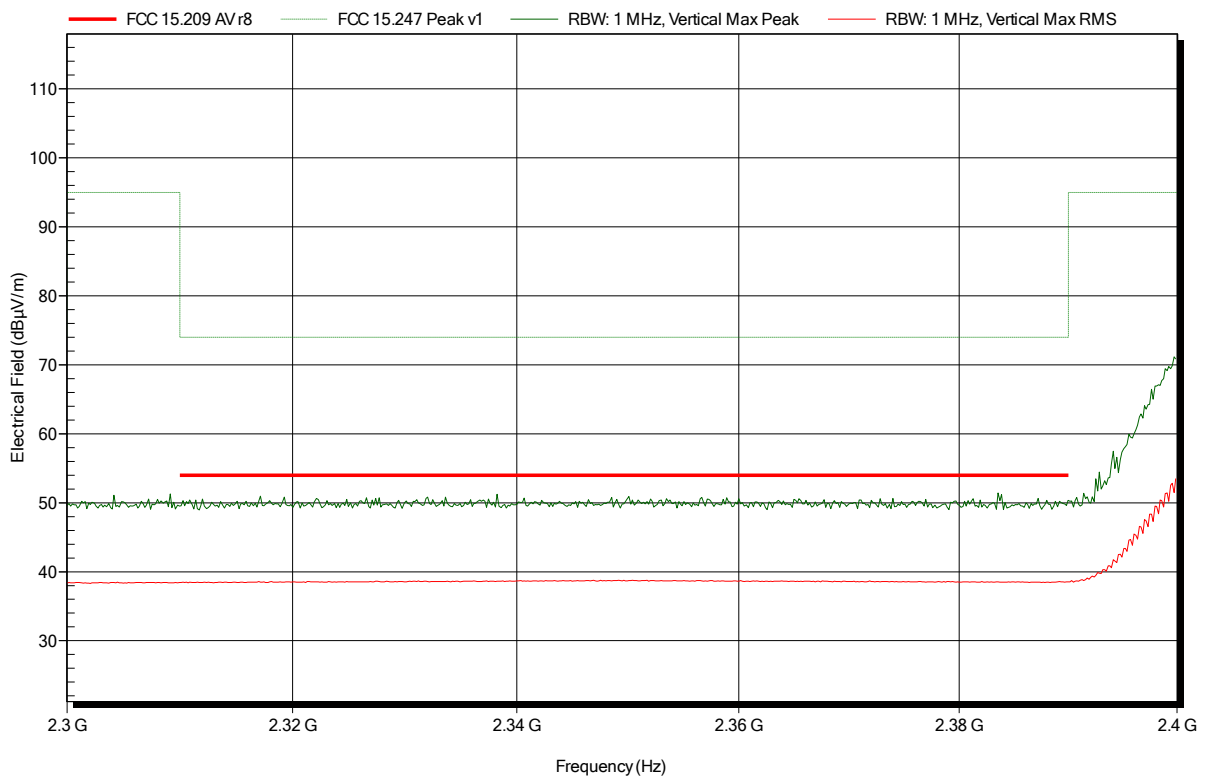

Spurious emissions according to FCC 15.247

Project number: G0M-1812-7888

Applicant: Leica Geosystems AG
 EUT Name: Field Controller Win EC7
 Model: CS20 LTE Disto (US, CA)
 Test Site: Eurofins Product Service GmbH
 Operator: Wilfried Treffke
 Test Conditions: Tnom: 22°C, Vnom: Vnom: 120V AC (intern 11.1 V DC)
 Antenna: Schwarzbeck BBHA 9120D, Horizontal
 Measurement distance: 1 m converted to 3m
 Mode: TX; IEEE 802.11g; 6Mbps; 2412 MHz
 Test Date: 2019-02-11
 Note:

Index 66

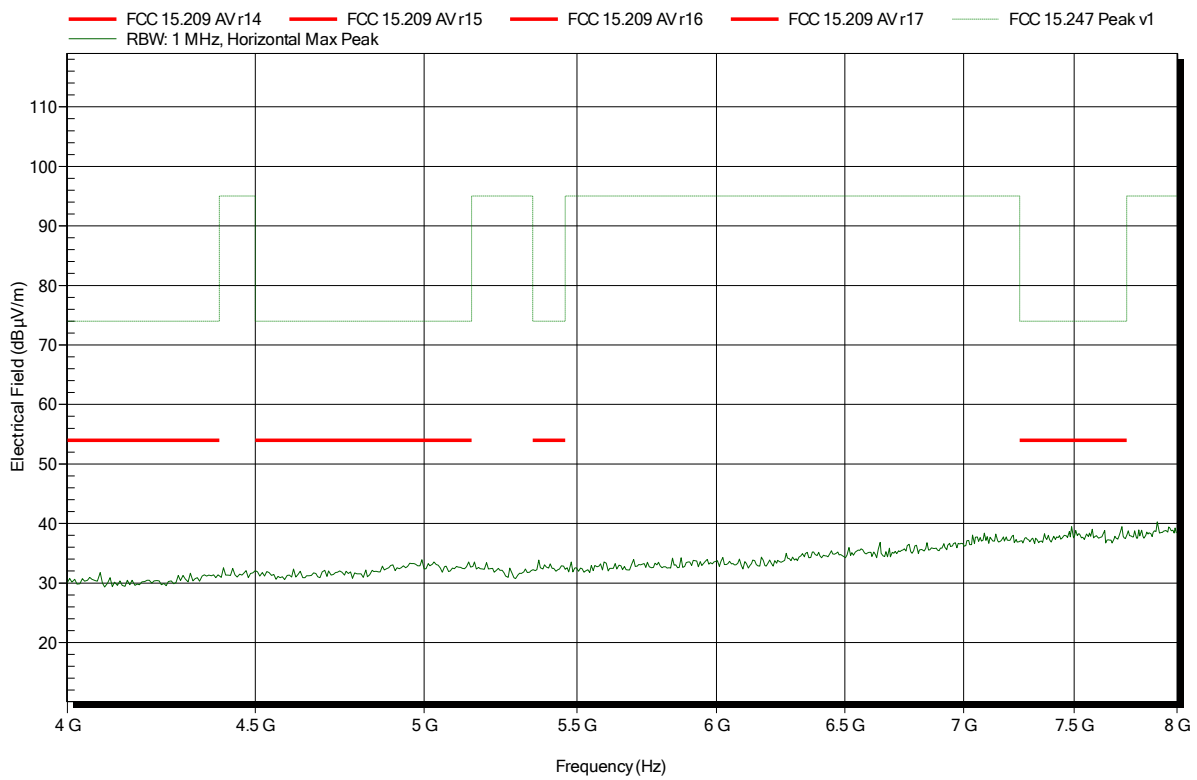

Spurious emissions according to FCC 15.247

Project number: G0M-1812-7888

Applicant: Leica Geosystems AG
 EUT Name: Field Controller Win EC7
 Model: CS20 LTE Disto (US, CA)
 Test Site: Eurofins Product Service GmbH
 Operator: Wilfried Treffke
 Test Conditions: Tnom: 22°C, Vnom: Vnom: 120V AC (intern 11.1 V DC)
 Antenna: Schwarzbeck BBHA 9120D, Vertical
 Measurement distance: 1 m converted to 3m
 Mode: TX; IEEE 802.11g; 6Mbps; 2412 MHz
 Test Date: 2019-02-11
 Note:

Index 69

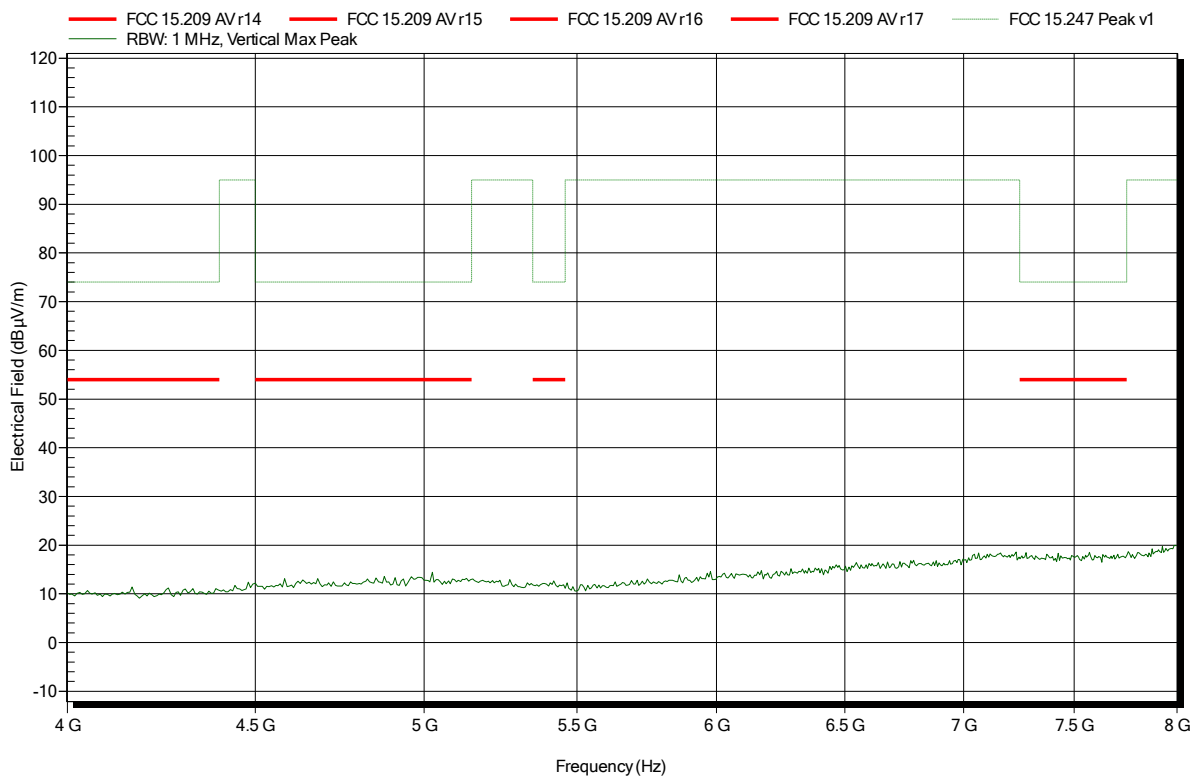

Spurious emissions according to FCC 15.247

Project number: G0M-1812-7888

Applicant: Leica Geosystems AG
 EUT Name: Field Controller Win EC7
 Model: CS20 LTE Disto (US, CA)
 Test Site: Eurofins Product Service GmbH
 Operator: Wilfried Treffke
 Test Conditions: Tnom: 22°C, Vnom: Vnom: 120V AC (intern 11.1 V DC)
 Antenna: Schwarzbeck BBHA 9120D, Horizontal
 Measurement distance: 1 m converted to 3m
 Mode: TX; IEEE 802.11g; 6Mbps; 2437 MHz
 Test Date: 2019-02-11
 Note:

Index 70

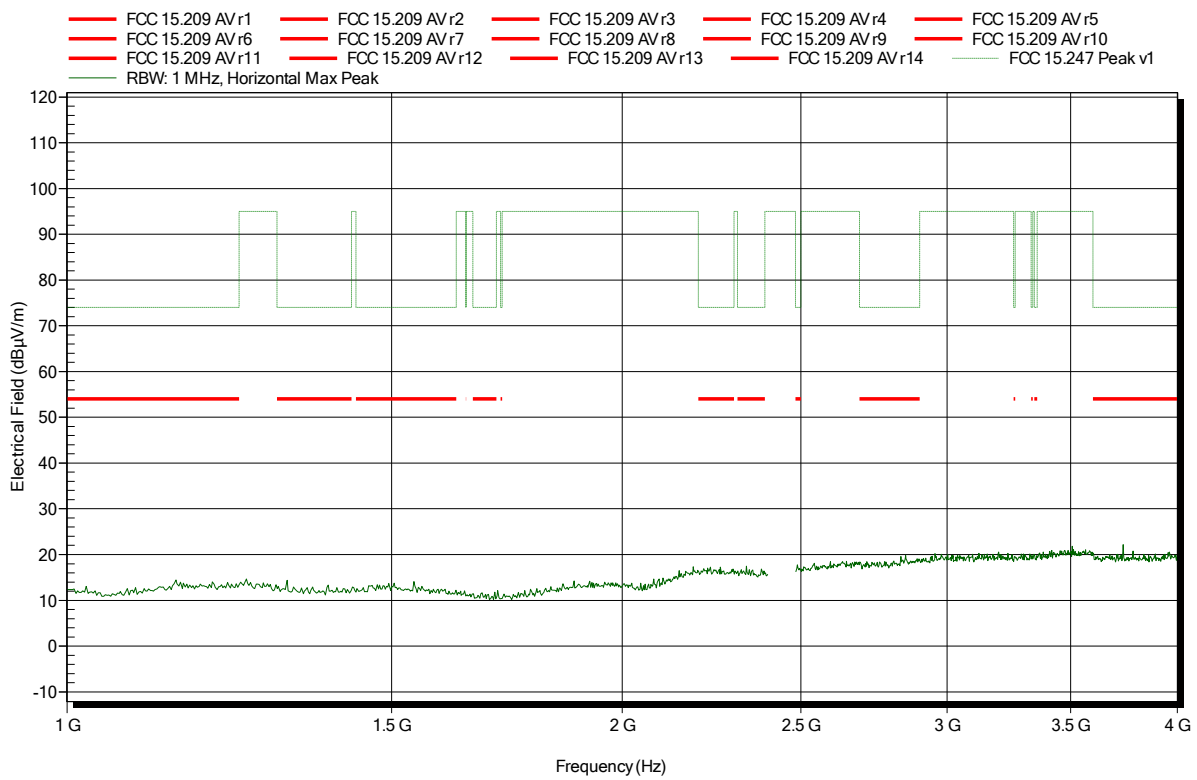

Spurious emissions according to FCC 15.247

Project number: G0M-1812-7888

Applicant: Leica Geosystems AG
 EUT Name: Field Controller Win EC7
 Model: CS20 LTE Disto (US, CA)
 Test Site: Eurofins Product Service GmbH
 Operator: Wilfried Treffke
 Test Conditions: Tnom: 22°C, Vnom: Vnom: 120V AC (intern 11.1 V DC)
 Antenna: Schwarzbeck BBHA 9120D, Vertical
 Measurement distance: 1 m converted to 3m
 Mode: TX; IEEE 802.11g; 6Mbps; 2437 MHz
 Test Date: 2019-02-11
 Note:

Index 73

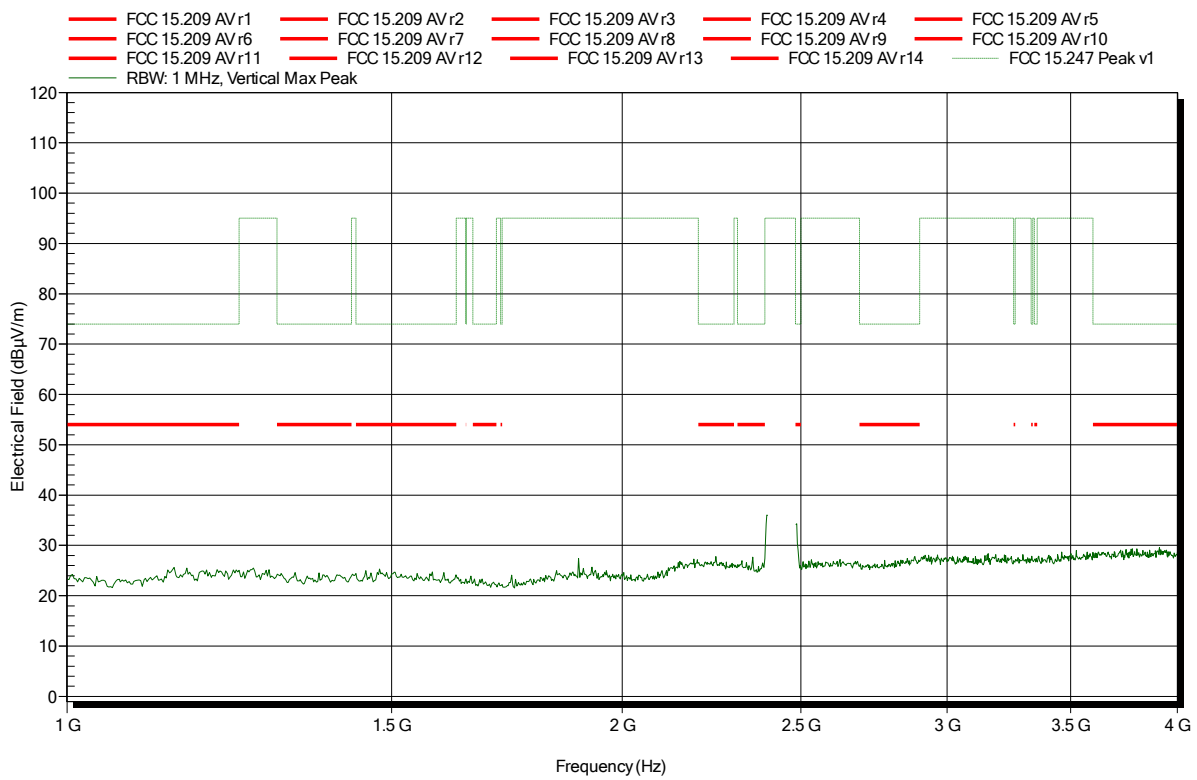

Spurious emissions according to FCC 15.247

Project number: G0M-1812-7888

Applicant: Leica Geosystems AG
 EUT Name: Field Controller Win EC7
 Model: CS20 LTE Disto (US, CA)
 Test Site: Eurofins Product Service GmbH
 Operator: Wilfried Treffke
 Test Conditions: Tnom: 22°C, Vnom: Vnom: 120V AC (intern 11.1 V DC)
 Antenna: Schwarzbeck BBHA 9120D, Horizontal
 Measurement distance: 1 m converted to 3m
 Mode: TX; IEEE 802.11g; 6Mbps; 2437 MHz
 Test Date: 2019-02-11
 Note:

Index 72

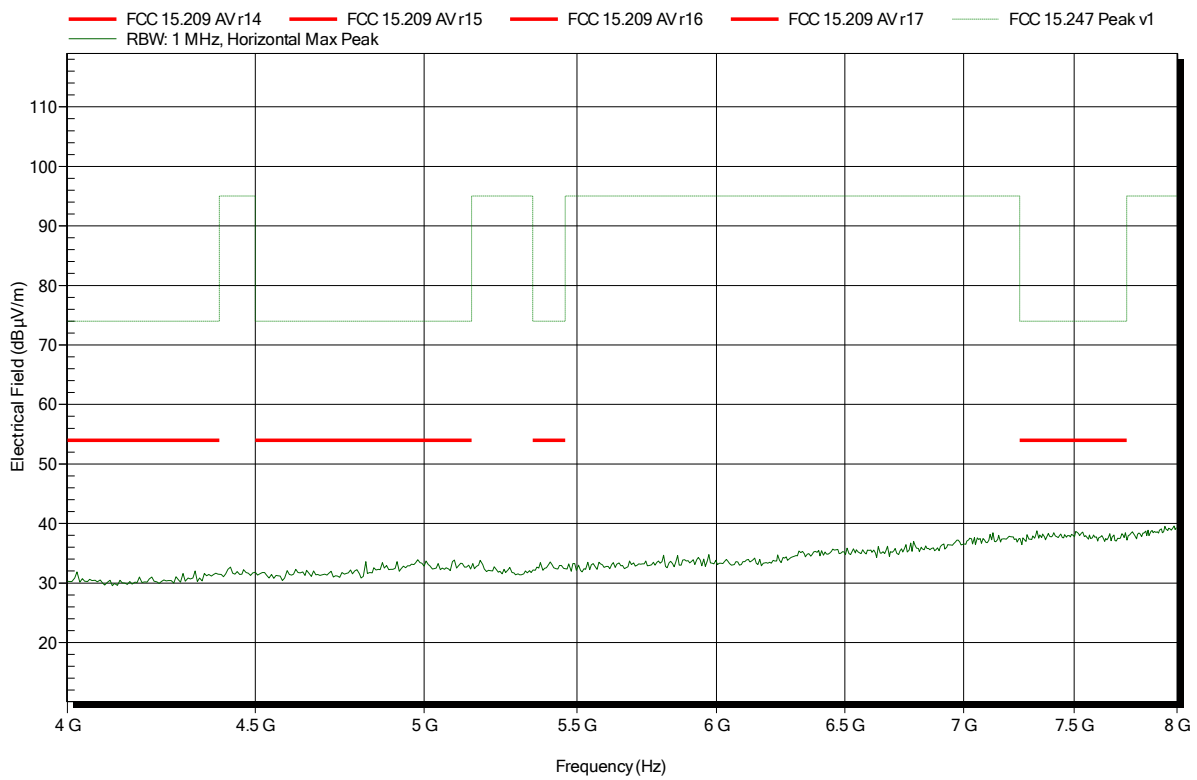

Spurious emissions according to FCC 15.247

Project number: G0M-1812-7888

Applicant: Leica Geosystems AG
 EUT Name: Field Controller Win EC7
 Model: CS20 LTE Disto (US, CA)
 Test Site: Eurofins Product Service GmbH
 Operator: Wilfried Treffke
 Test Conditions: Tnom: 22°C, Vnom: Vnom: 120V AC (intern 11.1 V DC)
 Antenna: Schwarzbeck BBHA 9120D, Horizontal
 Measurement distance: 1 m converted to 3m
 Mode: TX; IEEE 802.11g; 6Mbps; 2462 MHz
 Test Date: 2019-02-11
 Note:

Index 75

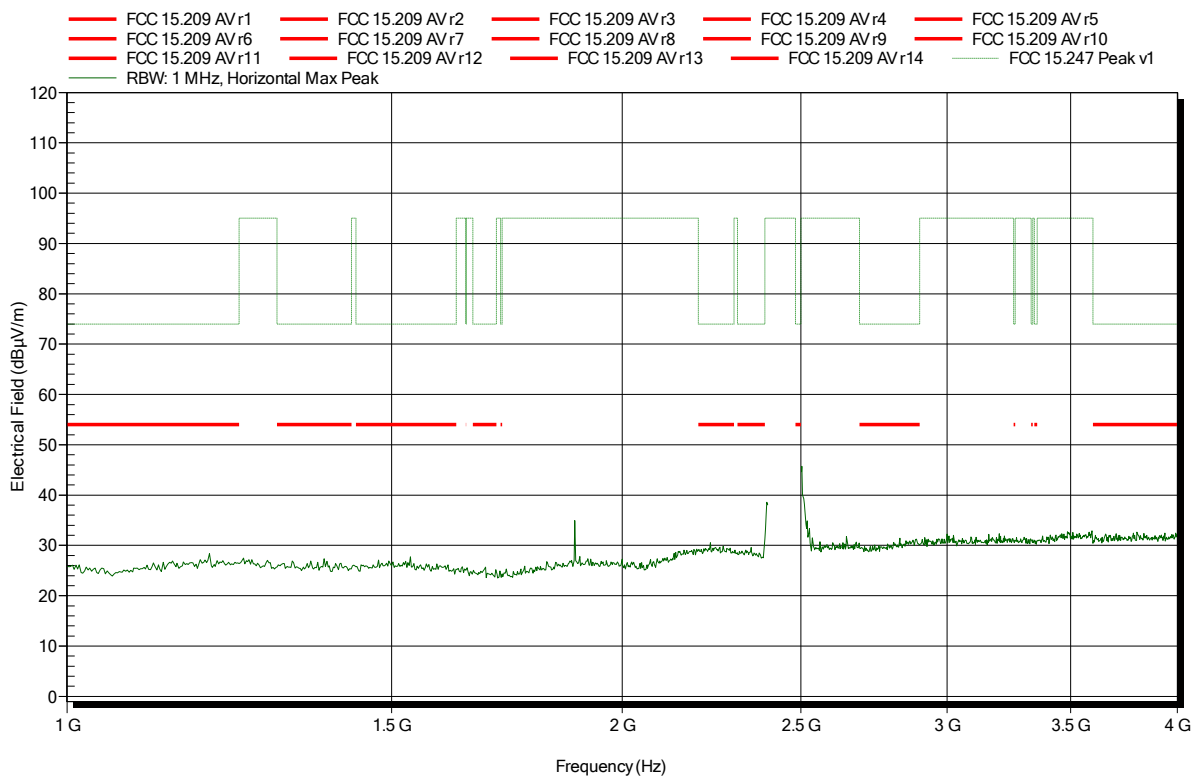

Spurious emissions according to FCC 15.247

Project number: G0M-1812-7888

Applicant: Leica Geosystems AG
 EUT Name: Field Controller Win EC7
 Model: CS20 LTE Disto (US, CA)
 Test Site: Eurofins Product Service GmbH
 Operator: Wilfried Treffke
 Test Conditions: Tnom: 22°C, Vnom: Vnom: 120V AC (intern 11.1 V DC)
 Antenna: Schwarzbeck BBHA 9120D, Vertical
 Measurement distance: 1 m converted to 3m
 Mode: TX; IEEE 802.11g; 6Mbps; 2462 MHz
 Test Date: 2019-02-11
 Note:

Index 78

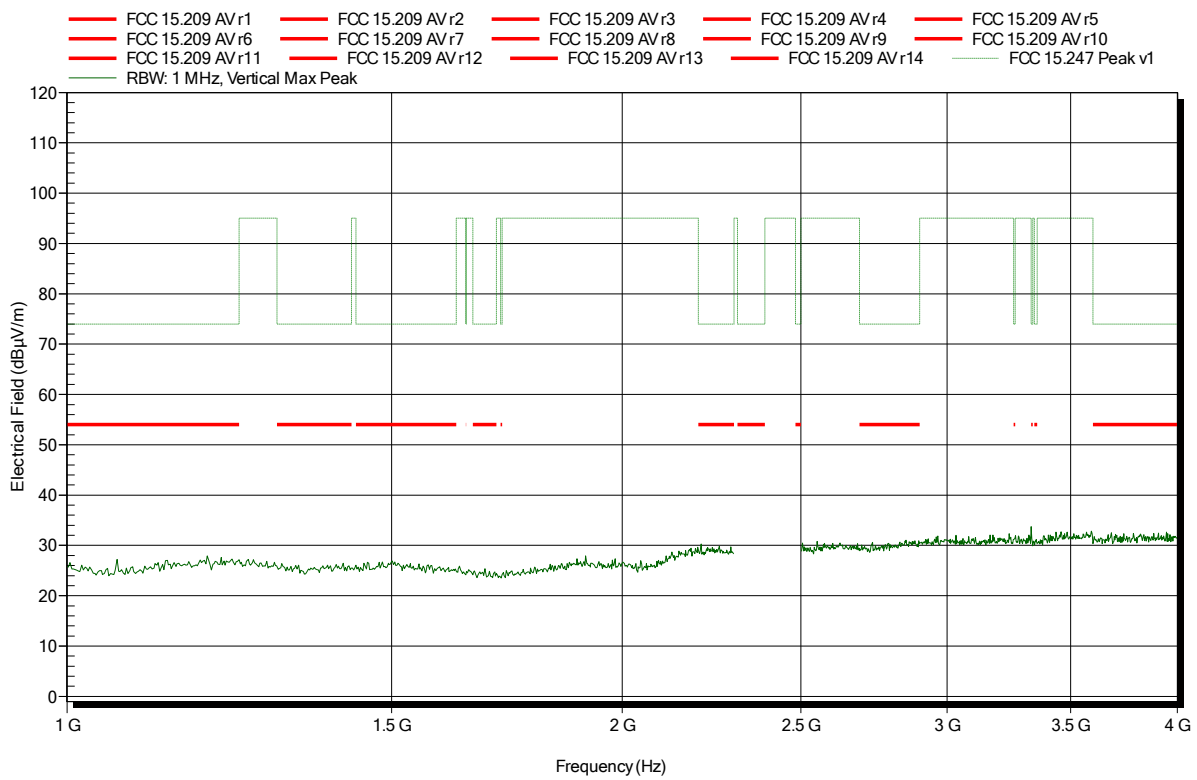

Spurious emissions according to FCC 15.247

Project number: G0M-1812-7888

Applicant: Leica Geosystems AG
 EUT Name: Field Controller Win EC7
 Model: CS20 LTE Disto (US, CA)
 Test Site: Eurofins Product Service GmbH
 Operator: Wilfried Treffke
 Test Conditions: Tnom: 22°C, Vnom: Vnom: 120V AC (intern 11.1 V DC)
 Antenna: Schwarzbeck BBHA 9120D, Horizontal
 Measurement distance: 1 m converted to 3m
 Mode: TX; IEEE 802.11g; 6Mbps; 2462 MHz
 Test Date: 2019-02-11
 Note: upper bandedge

Index 76

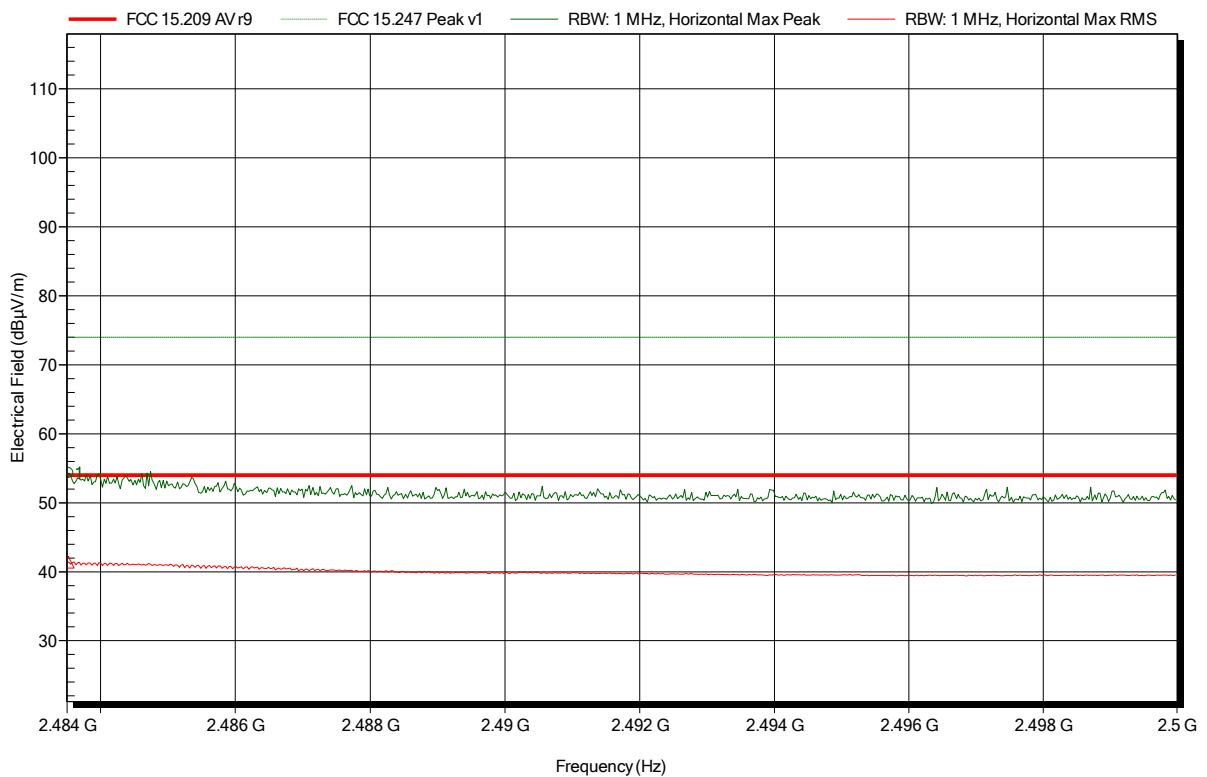

Frequency	Peak	Peak Limit	Peak Difference	Peak Status
2.4835 GHz	54.33 dBµV/m	74 dBµV/m	-19.67 dB	Pass
Frequency	RMS	RMS Limit	RMS Difference	RMS Status
2.4835 GHz	41.37 dBµV/m	54 dBµV/m	-12.63 dB	Pass

Spurious emissions according to FCC 15.247

Project number: G0M-1812-7888

Applicant: Leica Geosystems AG
 EUT Name: Field Controller Win EC7
 Model: CS20 LTE Disto (US, CA)
 Test Site: Eurofins Product Service GmbH
 Operator: Wilfried Treffke
 Test Conditions: Tnom: 22°C, Vnom: Vnom: 120V AC (intern 11.1 V DC)
 Antenna: Schwarzbeck BBHA 9120D, Vertical
 Measurement distance: 1 m converted to 3m
 Mode: TX; IEEE 802.11g; 6Mbps; 2462 MHz
 Test Date: 2019-02-11
 Note: upper bandedge

Index 79

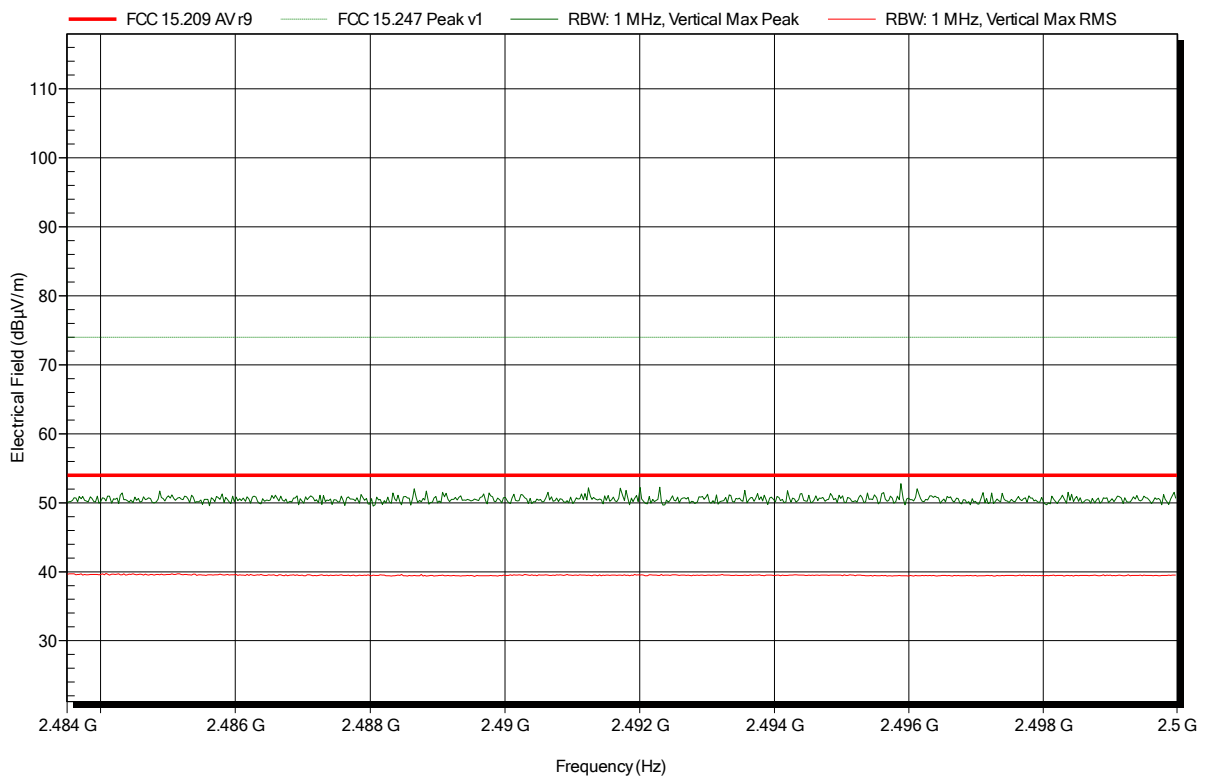

Spurious emissions according to FCC 15.247

Project number: G0M-1812-7888

Applicant: Leica Geosystems AG
 EUT Name: Field Controller Win EC7
 Model: CS20 LTE Disto (US, CA)
 Test Site: Eurofins Product Service GmbH
 Operator: Wilfried Treffke
 Test Conditions: Tnom: 22°C, Vnom: Vnom: 120V AC (intern 11.1 V DC)
 Antenna: Schwarzbeck BBHA 9120D, Horizontal
 Measurement distance: 1 m converted to 3m
 Mode: TX; IEEE 802.11g; 6Mbps; 2462 MHz
 Test Date: 2019-02-11
 Note:

Index 77

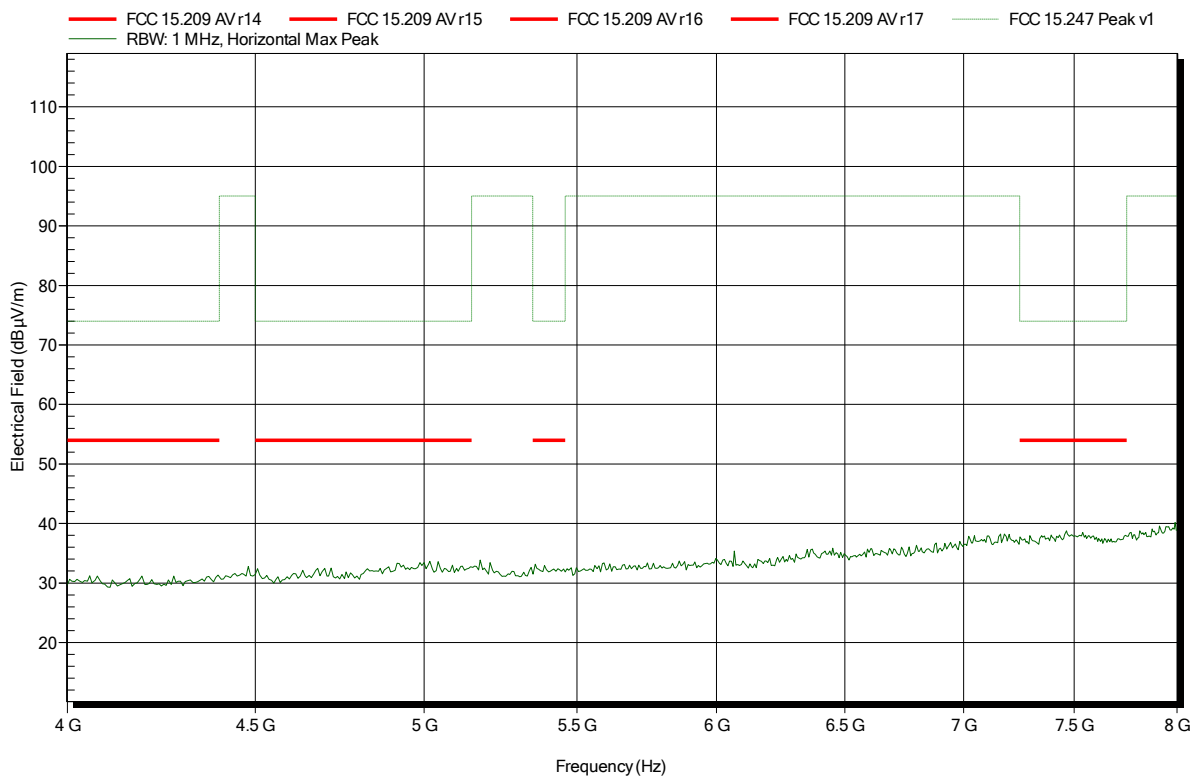

Spurious emissions according to FCC 15.247

Project number: G0M-1812-7888

Applicant: Leica Geosystems AG
 EUT Name: Field Controller Win EC7
 Model: CS20 LTE Disto (US, CA)
 Test Site: Eurofins Product Service GmbH
 Operator: Wilfried Treffke
 Test Conditions: Tnom: 22°C, Vnom: Vnom: 120V AC (intern 11.1 V DC)
 Antenna: Schwarzbeck BBHA 9120D, Vertical
 Measurement distance: 1 m converted to 3m
 Mode: TX; IEEE 802.11g; 6Mbps; 2462 MHz
 Test Date: 2019-02-11
 Note:

Index 80

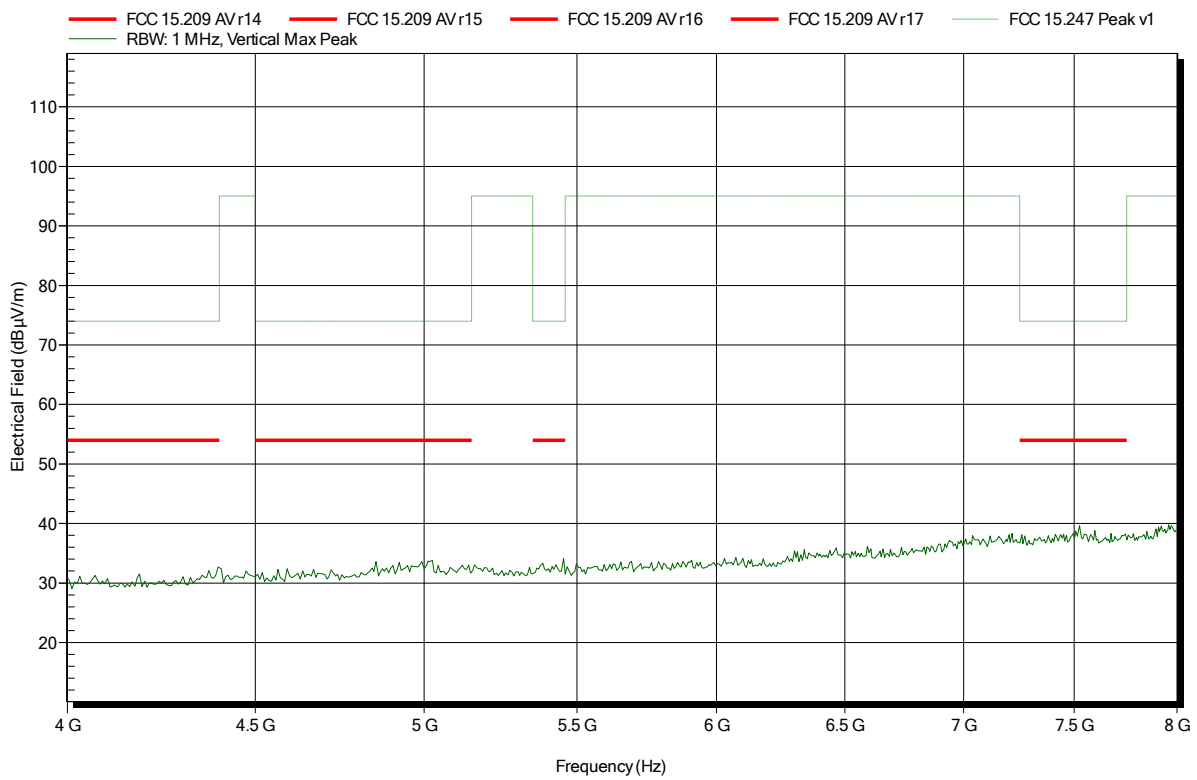

Spurious emissions according to FCC 15.247

Project number: G0M-1812-7888

Applicant: Leica Geosystems AG
 EUT Name: Field Controller Win EC7
 Model: CS20 LTE Disto (US, CA)
 Test Site: Eurofins Product Service GmbH
 Operator: Wilfried Treffke
 Test Conditions: Tnom: 22°C, Vnom: Vnom: 120V AC (intern 11.1 V DC)
 Antenna: Schwarzbeck BBHA 9120D, Horizontal
 Measurement distance: 1 m converted to 3m
 Mode: TX; IEEE 802.11n; MCS0; 2412 MHz
 Test Date: 2019-02-11
 Note:

Index 83

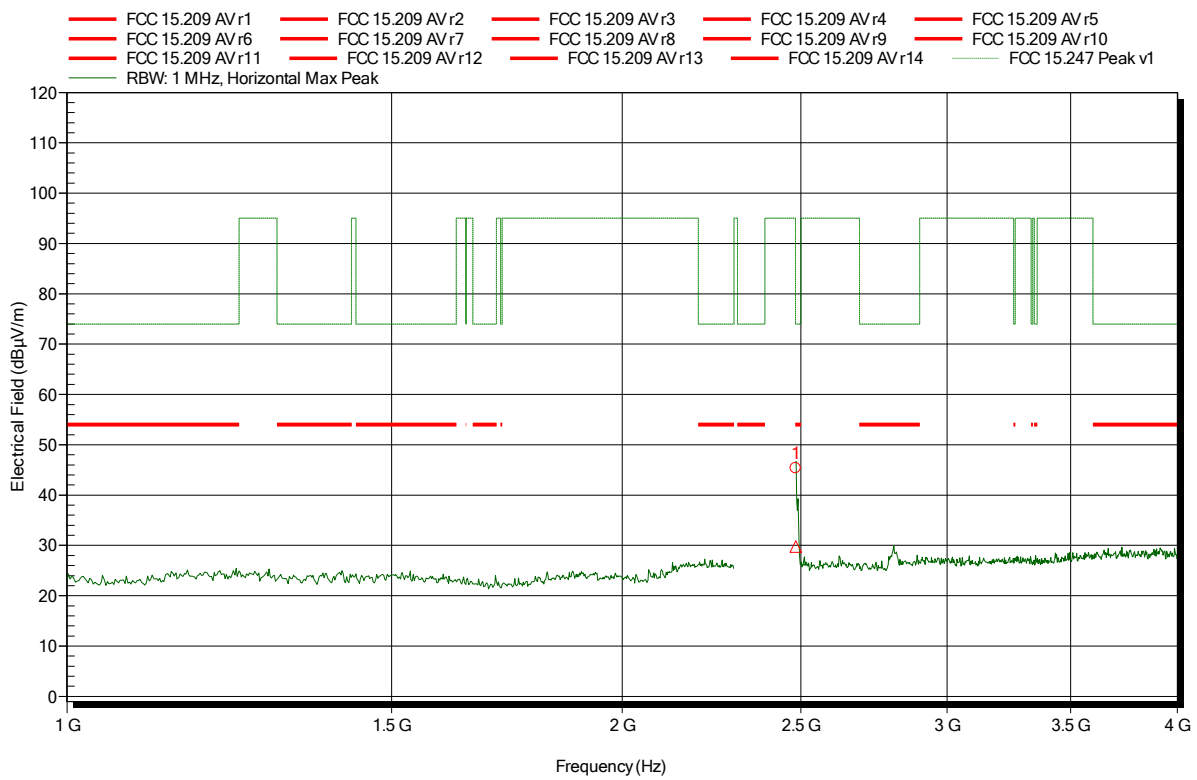

Frequency	Peak	Peak Limit	Peak Difference	Peak Status
2.4838 GHz	45.34 dBµV/m	74 dBµV/m	-28.66 dB	Pass
Frequency	RMS	RMS Limit	RMS Difference	RMS Status
2.4838 GHz	29.75 dBµV/m	54 dBµV/m	-24.25 dB	Pass

Spurious emissions according to FCC 15.247

Project number: G0M-1812-7888

Applicant: Leica Geosystems AG
 EUT Name: Field Controller Win EC7
 Model: CS20 LTE Disto (US, CA)
 Test Site: Eurofins Product Service GmbH
 Operator: Wilfried Treffke
 Test Conditions: Tnom: 22°C, Vnom: Vnom: 120V AC (intern 11.1 V DC)
 Antenna: Schwarzbeck BBHA 9120D, Vertical
 Measurement distance: 1 m converted to 3m
 Mode: TX; IEEE 802.11n; MCS0; 2412 MHz
 Test Date: 2019-02-11
 Note:

Index 85

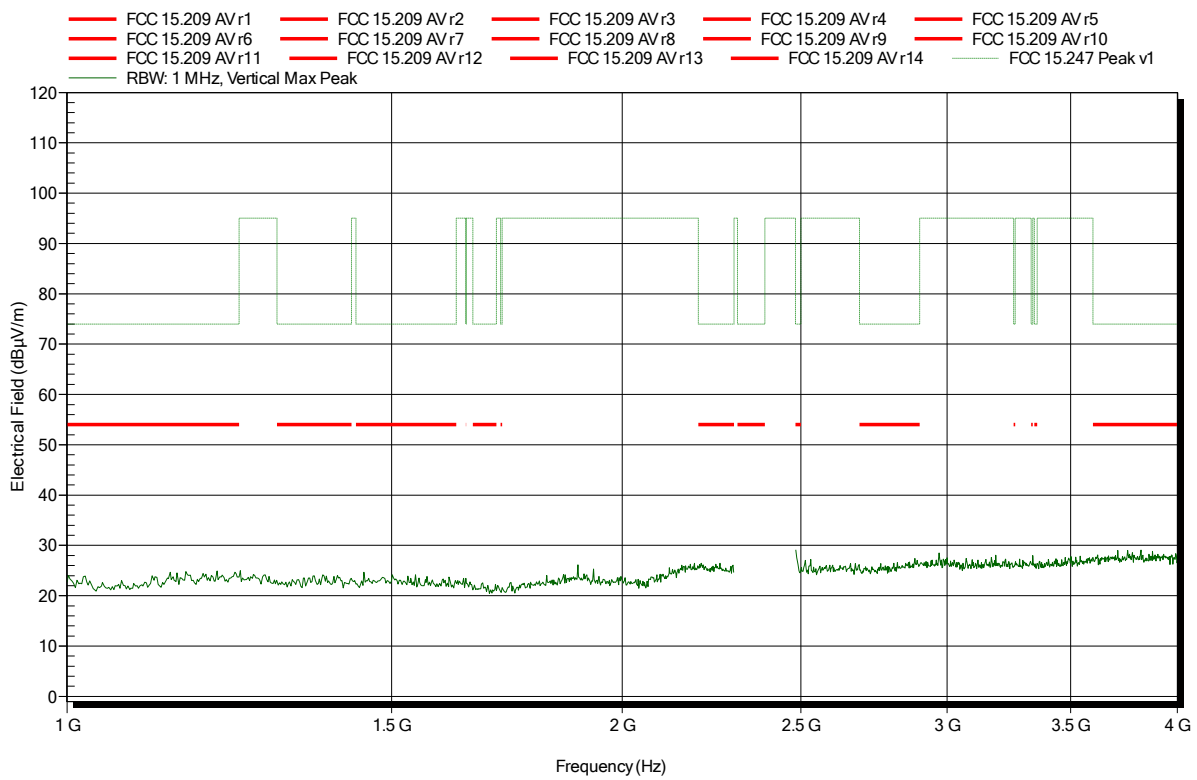

Spurious emissions according to FCC 15.247

Project number: G0M-1812-7888

Applicant: Leica Geosystems AG
 EUT Name: Field Controller Win EC7
 Model: CS20 LTE Disto (US, CA)
 Test Site: Eurofins Product Service GmbH
 Operator: Wilfried Treffke
 Test Conditions: Tnom: 22°C, Vnom: Vnom: 120V AC (intern 11.1 V DC)
 Antenna: Schwarzbeck BBHA 9120D, Horizontal
 Measurement distance: 1 m converted to 3m
 Mode: TX; IEEE 802.11n; MCS0; 2412 MHz
 Test Date: 2019-02-11
 Note: lower bandedge

Index 82

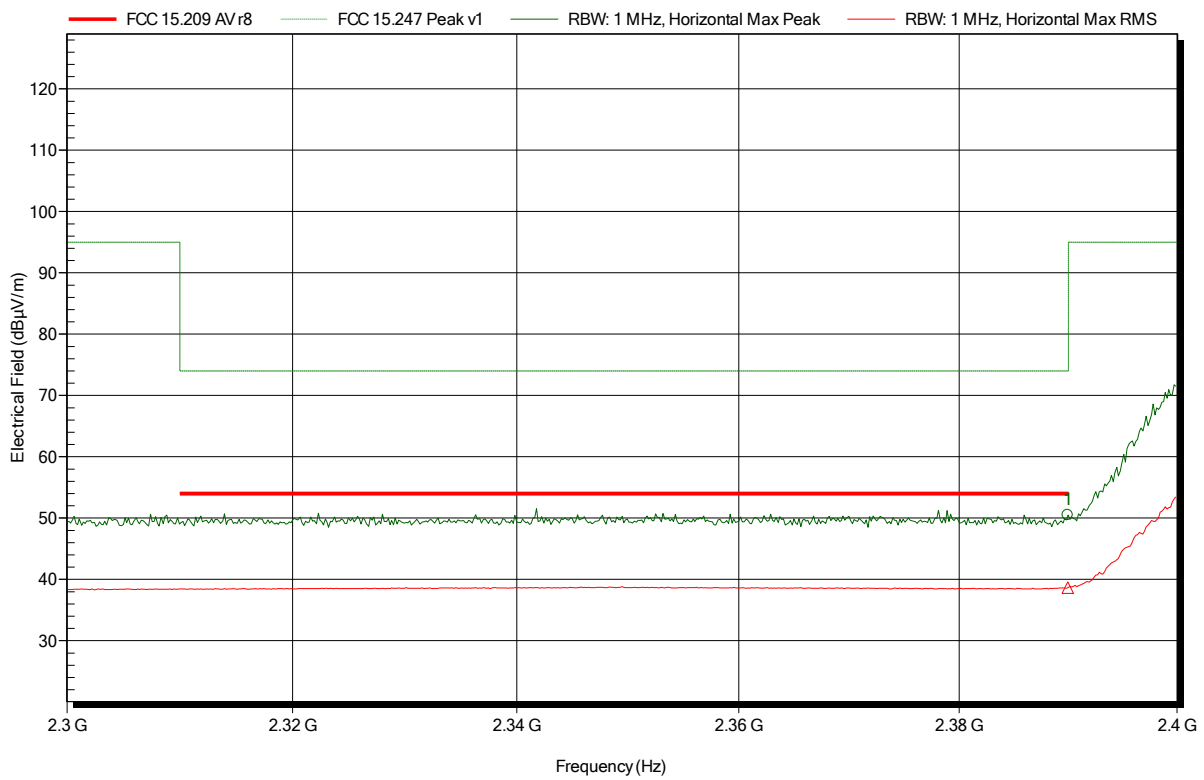

Frequency	Peak	Peak Limit	Peak Difference	Peak Status
2.3899 GHz	50.51 dBµV/m	74 dBµV/m	-23.49 dB	Pass
Frequency	RMS	RMS Limit	RMS Difference	RMS Status
2.3899 GHz	38.67 dBµV/m	54 dBµV/m	-15.33 dB	Pass

Spurious emissions according to FCC 15.247

Project number: G0M-1812-7888

Applicant: Leica Geosystems AG
 EUT Name: Field Controller Win EC7
 Model: CS20 LTE Disto (US, CA)
 Test Site: Eurofins Product Service GmbH
 Operator: Wilfried Treffke
 Test Conditions: Tnom: 22°C, Vnom: Vnom: 120V AC (intern 11.1 V DC)
 Antenna: Schwarzbeck BBHA 9120D, Vertical
 Measurement distance: 1 m converted to 3m
 Mode: TX; IEEE 802.11n; MCS0; 2412 MHz
 Test Date: 2019-02-11
 Note: lower bandedge

Index 86

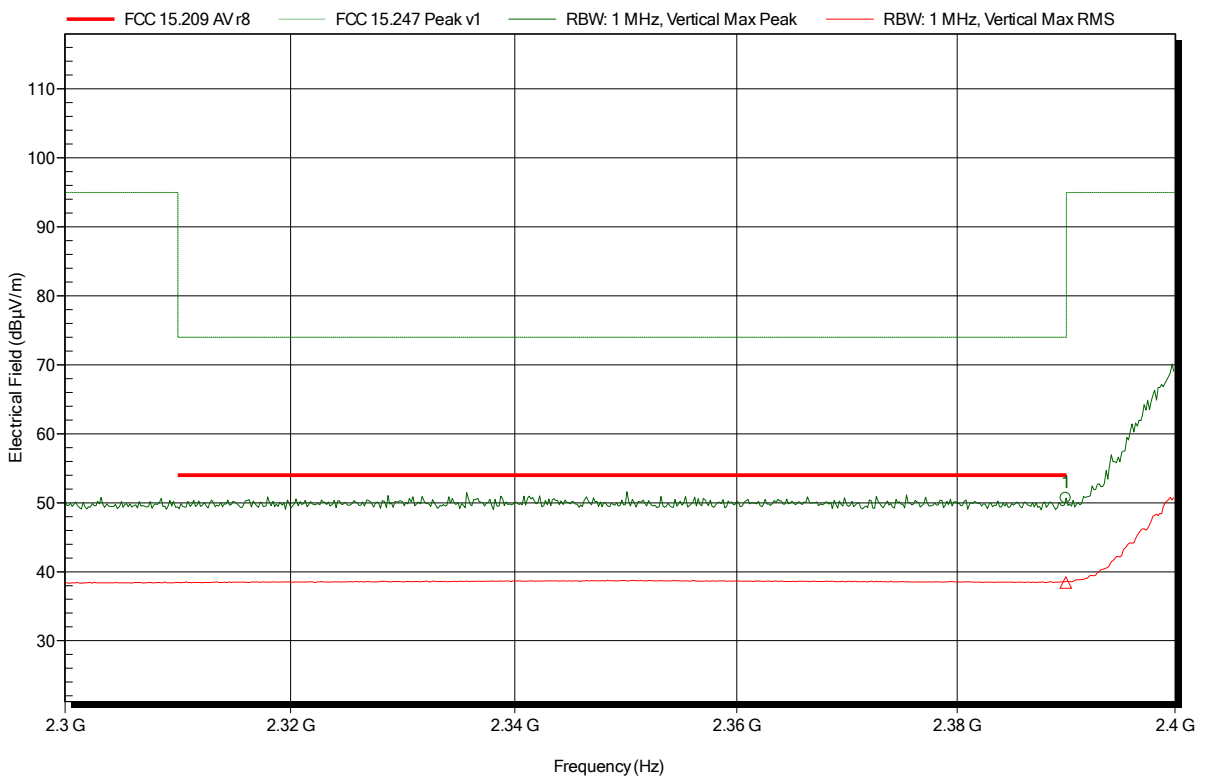

Frequency	Peak	Peak Limit	Peak Difference	Peak Status
2.3899 GHz	50.68 dBµV/m	74 dBµV/m	-23.32 dB	Pass
Frequency	RMS	RMS Limit	RMS Difference	RMS Status
2.3899 GHz	38.46 dBµV/m	54 dBµV/m	-15.54 dB	Pass

Spurious emissions according to FCC 15.247

Project number: G0M-1812-7888

Applicant: Leica Geosystems AG
 EUT Name: Field Controller Win EC7
 Model: CS20 LTE Disto (US, CA)
 Test Site: Eurofins Product Service GmbH
 Operator: Wilfried Treffke
 Test Conditions: Tnom: 22°C, Vnom: Vnom: 120V AC (intern 11.1 V DC)
 Antenna: Schwarzbeck BBHA 9120D, Horizontal
 Measurement distance: 1 m converted to 3m
 Mode: TX; IEEE 802.11n; MCS0; 2412 MHz
 Test Date: 2019-02-11
 Note:

Index 84

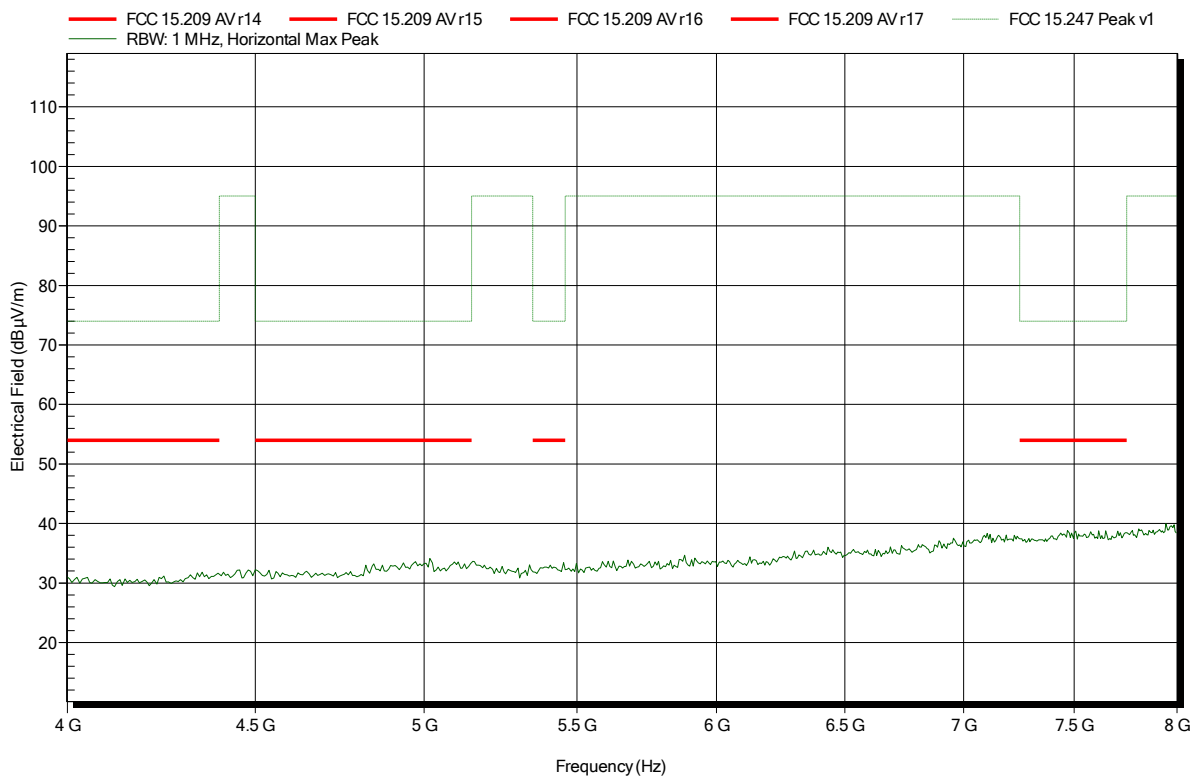

Spurious emissions according to FCC 15.247

Project number: G0M-1812-7888

Applicant: Leica Geosystems AG
 EUT Name: Field Controller Win EC7
 Model: CS20 LTE Disto (US, CA)
 Test Site: Eurofins Product Service GmbH
 Operator: Wilfried Treffke
 Test Conditions: Tnom: 22°C, Vnom: Vnom: 120V AC (intern 11.1 V DC)
 Antenna: Schwarzbeck BBHA 9120D, Vertical
 Measurement distance: 1 m converted to 3m
 Mode: TX; IEEE 802.11n; MCS0; 2412 MHz
 Test Date: 2019-02-11
 Note:

Index 87

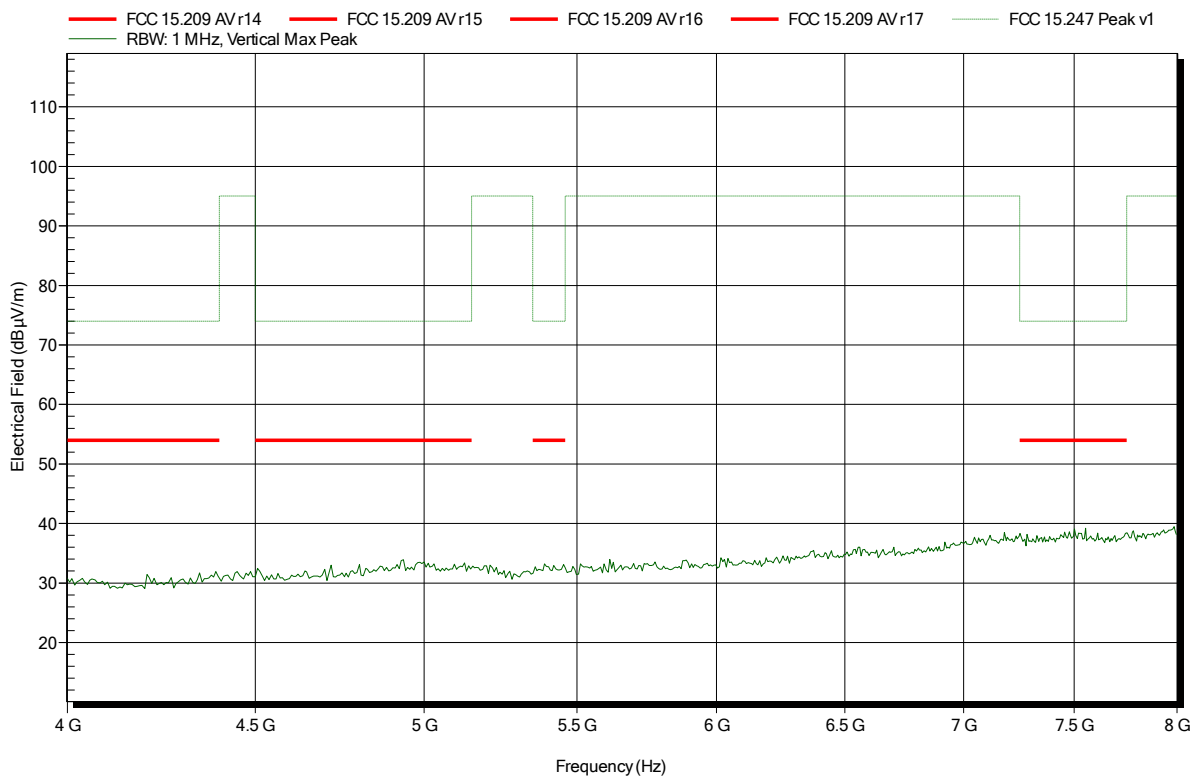

Spurious emissions according to FCC 15.247

Project number: G0M-1812-7888

Applicant: Leica Geosystems AG
 EUT Name: Field Controller Win EC7
 Model: CS20 LTE Disto (US, CA)
 Test Site: Eurofins Product Service GmbH
 Operator: Wilfried Treffke
 Test Conditions: Tnom: 22°C, Vnom: Vnom: 120V AC (intern 11.1 V DC)
 Antenna: Schwarzbeck BBHA 9120D, Horizontal
 Measurement distance: 1 m converted to 3m
 Mode: TX; IEEE 802.11n; MCS0; 2437 MHz
 Test Date: 2019-02-11
 Note:

Index 88

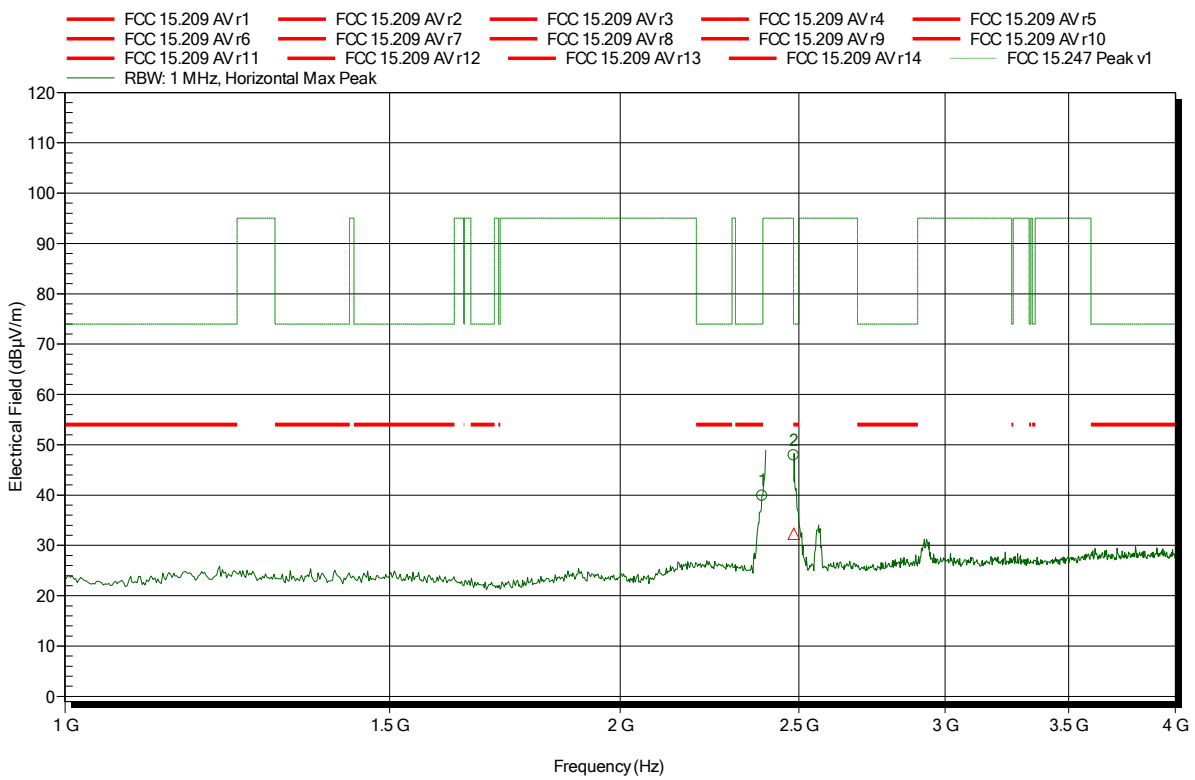

Frequency	Peak	Peak Limit	Peak Difference	Peak Status
2.3888 GHz	39.88 dBµV/m	74 dBµV/m	-34.12 dB	Pass
2.4839 GHz	47.88 dBµV/m	74 dBµV/m	-26.12 dB	Pass

Frequency	RMS	RMS Limit	RMS Difference	RMS Status
2.4839 GHz	32.36 dBµV/m	54 dBµV/m	-21.64 dB	Pass

Spurious emissions according to FCC 15.247

Project number: G0M-1812-7888

Applicant: Leica Geosystems AG
 EUT Name: Field Controller Win EC7
 Model: CS20 LTE Disto (US, CA)
 Test Site: Eurofins Product Service GmbH
 Operator: Wilfried Treffke
 Test Conditions: Tnom: 22°C, Vnom: Vnom: 120V AC (intern 11.1 V DC)
 Antenna: Schwarzbeck BBHA 9120D, Vertical
 Measurement distance: 1 m converted to 3m
 Mode: TX; IEEE 802.11n; MCS0; 2437 MHz
 Test Date: 2019-02-11
 Note:

Index 91

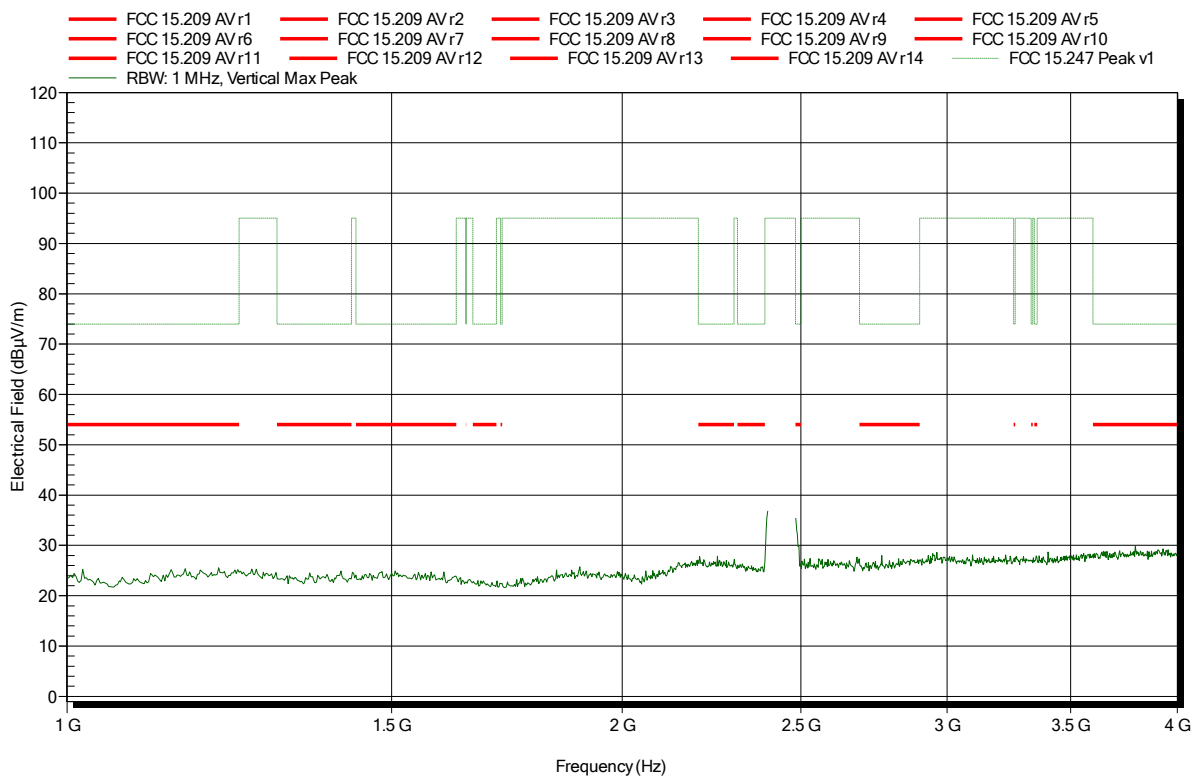

Spurious emissions according to FCC 15.247

Project number: G0M-1812-7888

Applicant: Leica Geosystems AG
 EUT Name: Field Controller Win EC7
 Model: CS20 LTE Disto (US, CA)
 Test Site: Eurofins Product Service GmbH
 Operator: Wilfried Treffke
 Test Conditions: Tnom: 22°C, Vnom: Vnom: 120V AC (intern 11.1 V DC)
 Antenna: Schwarzbeck BBHA 9120D, Horizontal
 Measurement distance: 1 m converted to 3m
 Mode: TX; IEEE 802.11n; MCS0; 2437 MHz
 Test Date: 2019-02-11
 Note:

Index 89

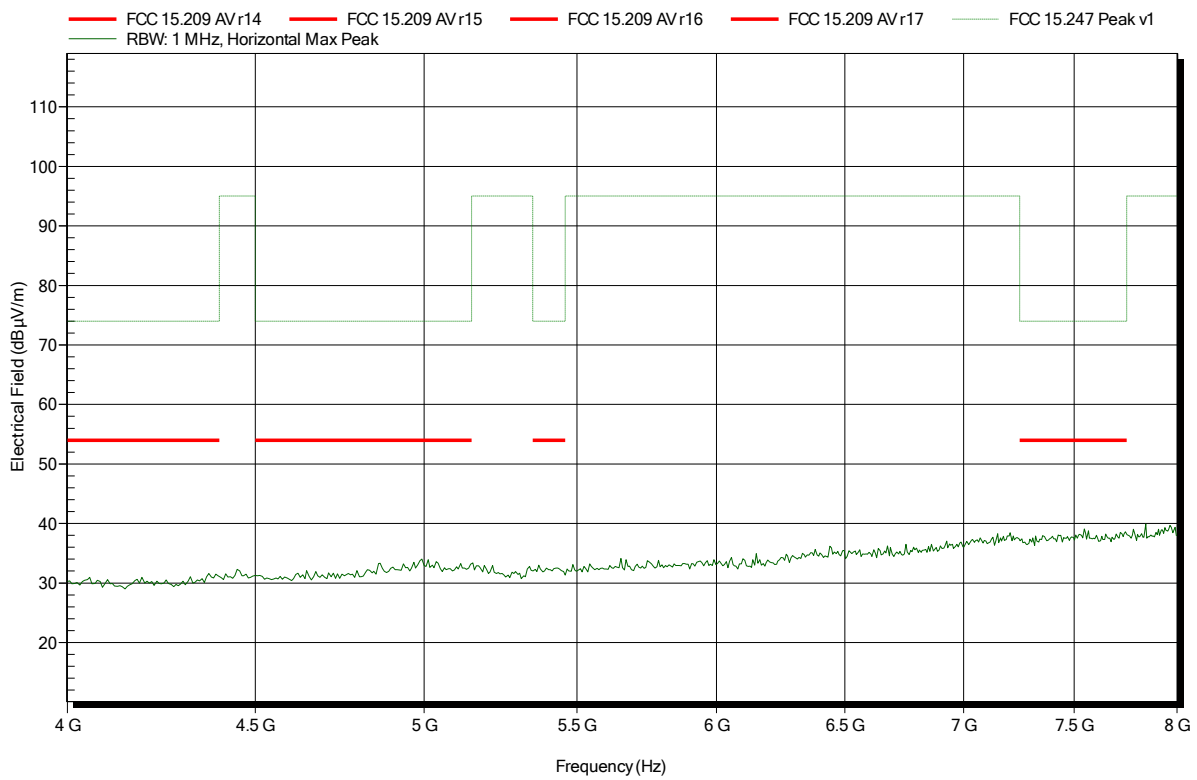

Spurious emissions according to FCC 15.247

Project number: G0M-1812-7888

Applicant: Leica Geosystems AG
 EUT Name: Field Controller Win EC7
 Model: CS20 LTE Disto (US, CA)
 Test Site: Eurofins Product Service GmbH
 Operator: Wilfried Treffke
 Test Conditions: Tnom: 22°C, Vnom: Vnom: 120V AC (intern 11.1 V DC)
 Antenna: Schwarzbeck BBHA 9120D, Vertical
 Measurement distance: 1 m converted to 3m
 Mode: TX; IEEE 802.11n; MCS0; 2437 MHz
 Test Date: 2019-02-11
 Note:

Index 92

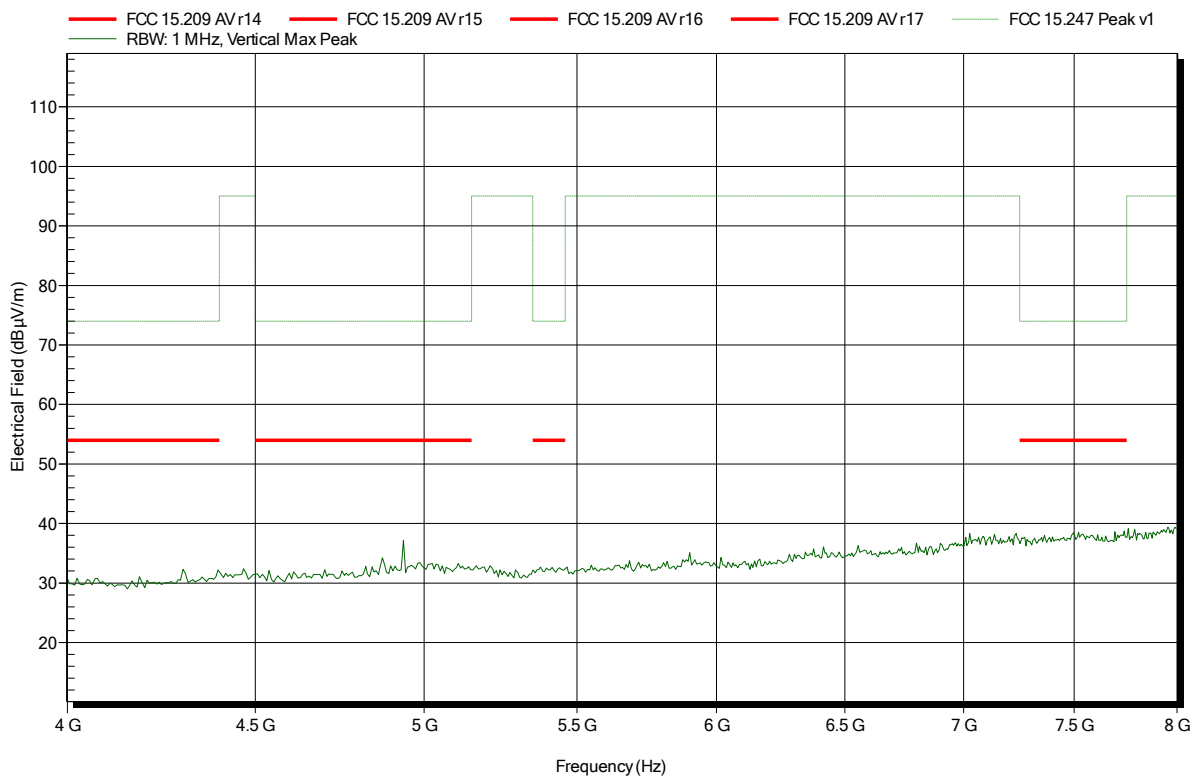

Spurious emissions according to FCC 15.247

Project number: G0M-1812-7888

Applicant: Leica Geosystems AG
 EUT Name: Field Controller Win EC7
 Model: CS20 LTE Disto (US, CA)
 Test Site: Eurofins Product Service GmbH
 Operator: Wilfried Treffke
 Test Conditions: Tnom: 22°C, Vnom: Vnom: 120V AC (intern 11.1 V DC)
 Antenna: Schwarzbeck BBHA 9120D, Horizontal
 Measurement distance: 1 m converted to 3m
 Mode: TX; IEEE 802.11n; MCS0; 2462 MHz
 Test Date: 2019-02-11
 Note:

Index 93

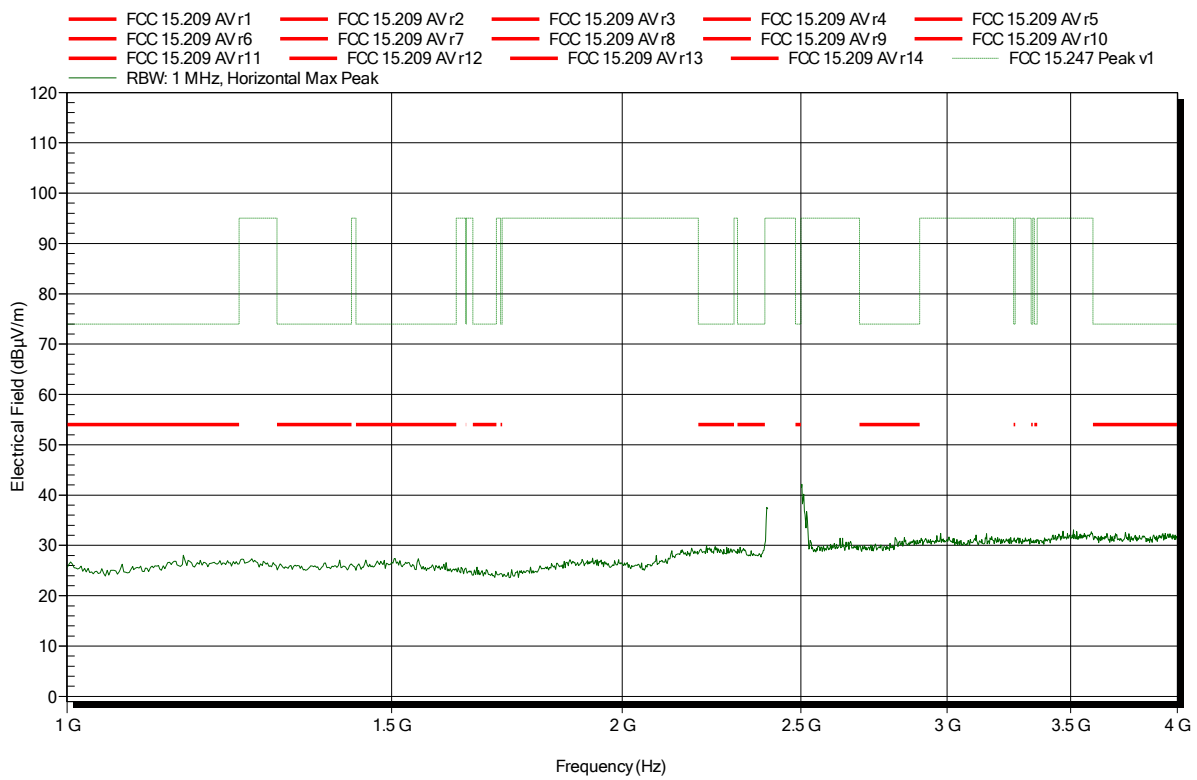

Spurious emissions according to FCC 15.247

Project number: G0M-1812-7888

Applicant: Leica Geosystems AG
 EUT Name: Field Controller Win EC7
 Model: CS20 LTE Disto (US, CA)
 Test Site: Eurofins Product Service GmbH
 Operator: Wilfried Treffke
 Test Conditions: Tnom: 22°C, Vnom: Vnom: 120V AC (intern 11.1 V DC)
 Antenna: Schwarzbeck BBHA 9120D, Vertical
 Measurement distance: 1 m converted to 3m
 Mode: TX; IEEE 802.11n; MCS0; 2462 MHz
 Test Date: 2019-02-11
 Note:

Index 96

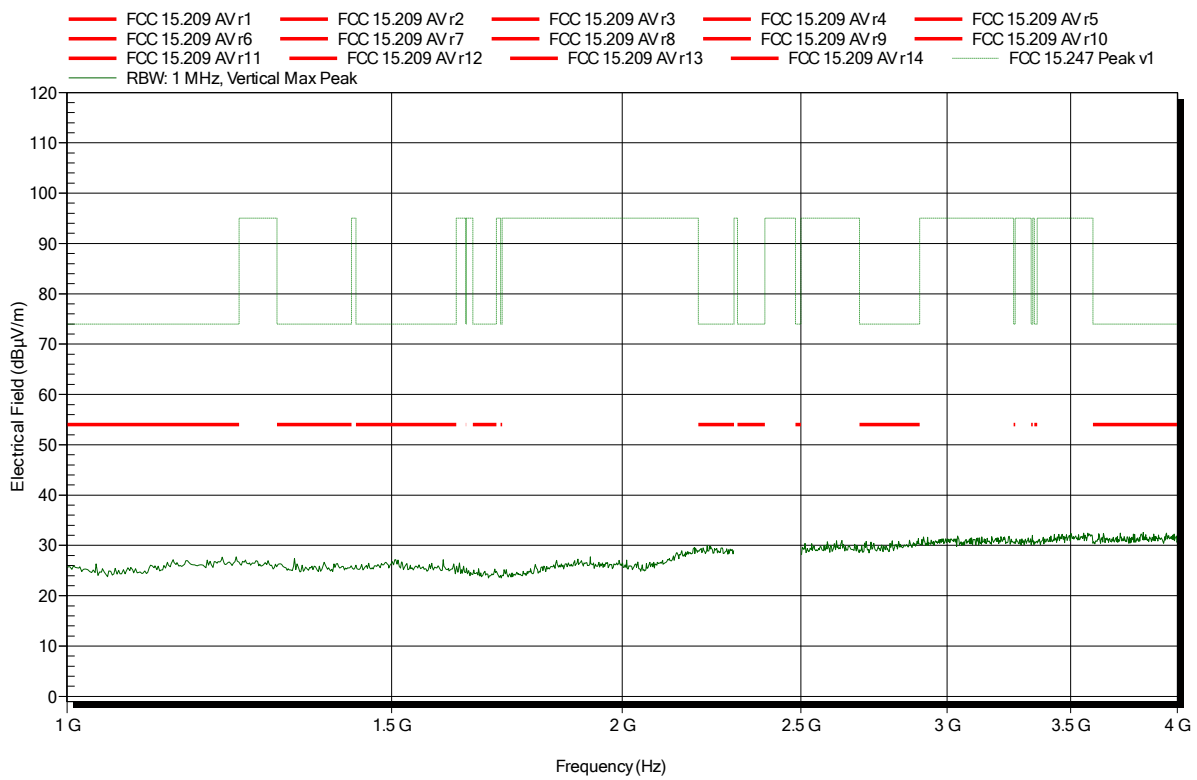

Spurious emissions according to FCC 15.247

Project number: G0M-1812-7888

Applicant: Leica Geosystems AG
 EUT Name: Field Controller Win EC7
 Model: CS20 LTE Disto (US, CA)
 Test Site: Eurofins Product Service GmbH
 Operator: Wilfried Treffke
 Test Conditions: Tnom: 22°C, Vnom: Vnom: 120V AC (intern 11.1 V DC)
 Antenna: Schwarzbeck BBHA 9120D, Horizontal
 Measurement distance: 1 m converted to 3m
 Mode: TX; IEEE 802.11n; MCS0; 2462 MHz
 Test Date: 2019-02-11
 Note: upper bandedge

Index 94

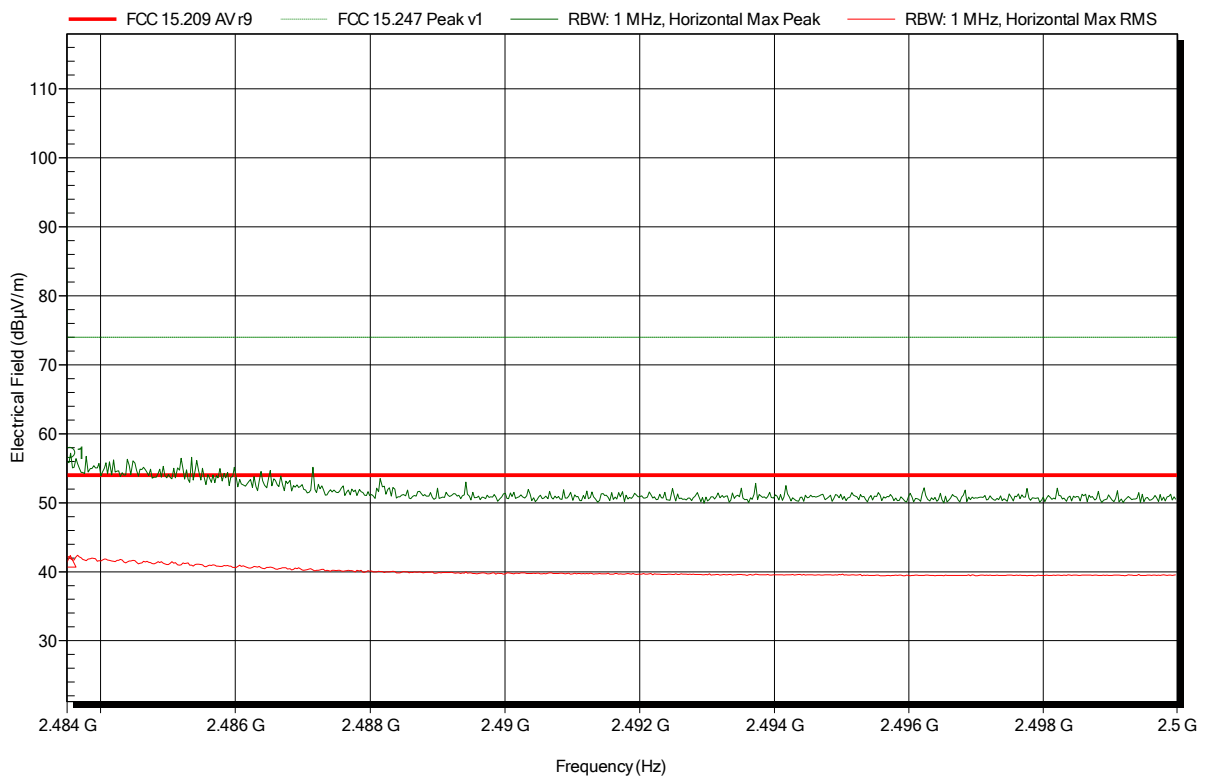

Frequency	Peak	Peak Limit	Peak Difference	Peak Status
2.4836 GHz	57.21 dBµV/m	74 dBµV/m	-16.79 dB	Pass
Frequency	RMS	RMS Limit	RMS Difference	RMS Status
2.4836 GHz	41.51 dBµV/m	54 dBµV/m	-12.49 dB	Pass

Spurious emissions according to FCC 15.247

Project number: G0M-1812-7888

Applicant: Leica Geosystems AG
 EUT Name: Field Controller Win EC7
 Model: CS20 LTE Disto (US, CA)
 Test Site: Eurofins Product Service GmbH
 Operator: Wilfried Treffke
 Test Conditions: Tnom: 22°C, Vnom: Vnom: 120V AC (intern 11.1 V DC)
 Antenna: Schwarzbeck BBHA 9120D, Vertical
 Measurement distance: 1 m converted to 3m
 Mode: TX; IEEE 802.11n; MCS0; 2462 MHz
 Test Date: 2019-02-11
 Note: upper bandedge

Index 97

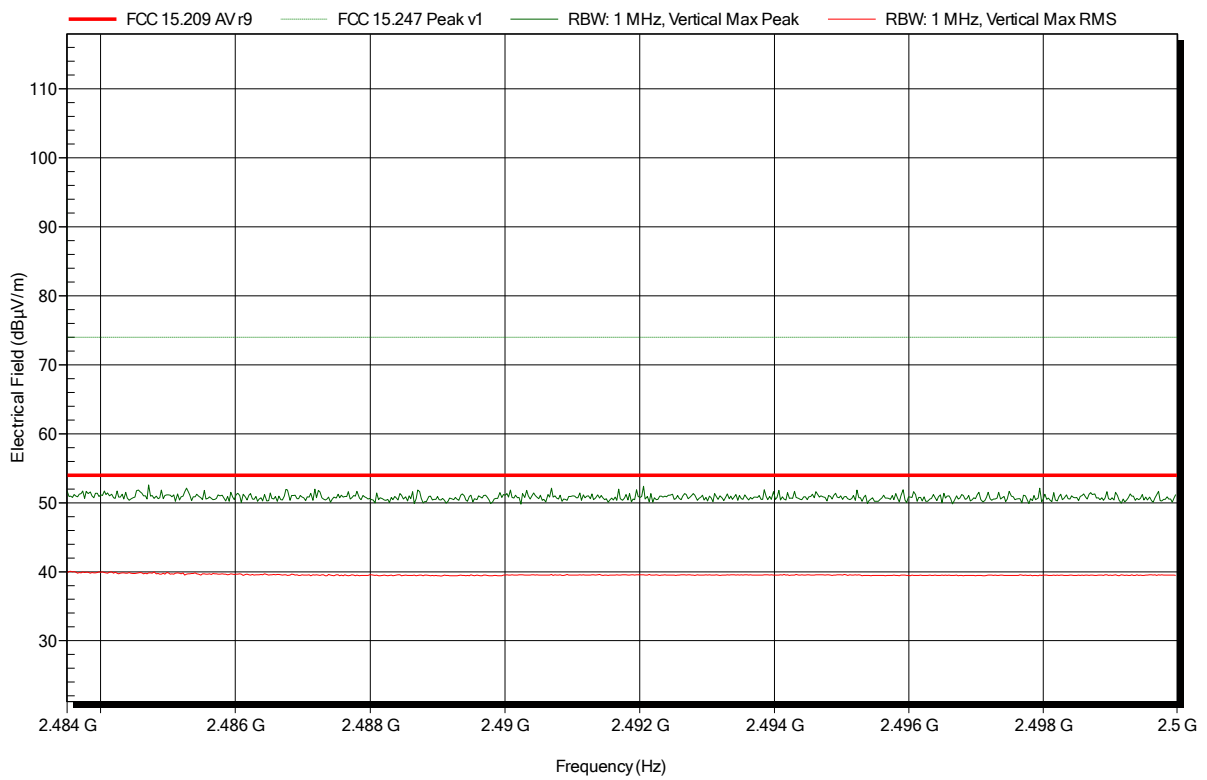

Spurious emissions according to FCC 15.247

Project number: G0M-1812-7888

Applicant: Leica Geosystems AG
 EUT Name: Field Controller Win EC7
 Model: CS20 LTE Disto (US, CA)
 Test Site: Eurofins Product Service GmbH
 Operator: Wilfried Treffke
 Test Conditions: Tnom: 22°C, Vnom: Vnom: 120V AC (intern 11.1 V DC)
 Antenna: Schwarzbeck BBHA 9120D, Horizontal
 Measurement distance: 1 m converted to 3m
 Mode: TX; IEEE 802.11n; MCS0; 2462 MHz
 Test Date: 2019-02-11
 Note:

Index 95

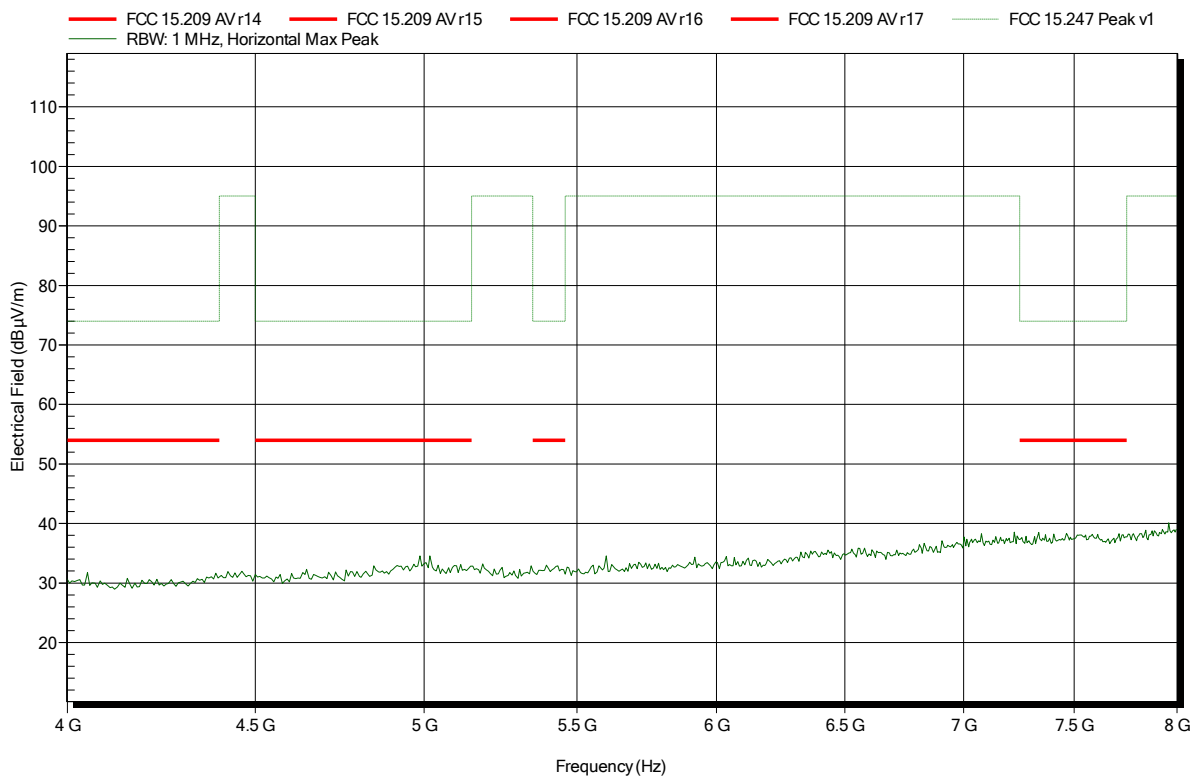

Spurious emissions according to FCC 15.247

Project number: G0M-1812-7888

Applicant: Leica Geosystems AG
 EUT Name: Field Controller Win EC7
 Model: CS20 LTE Disto (US, CA)
 Test Site: Eurofins Product Service GmbH
 Operator: Wilfried Treffke
 Test Conditions: Tnom: 22°C, Vnom: Vnom: 120V AC (intern 11.1 V DC)
 Antenna: Schwarzbeck BBHA 9120D, Vertical
 Measurement distance: 1 m converted to 3m
 Mode: TX; IEEE 802.11n; MCS0; 2462 MHz
 Test Date: 2019-02-11
 Note:

Index 98

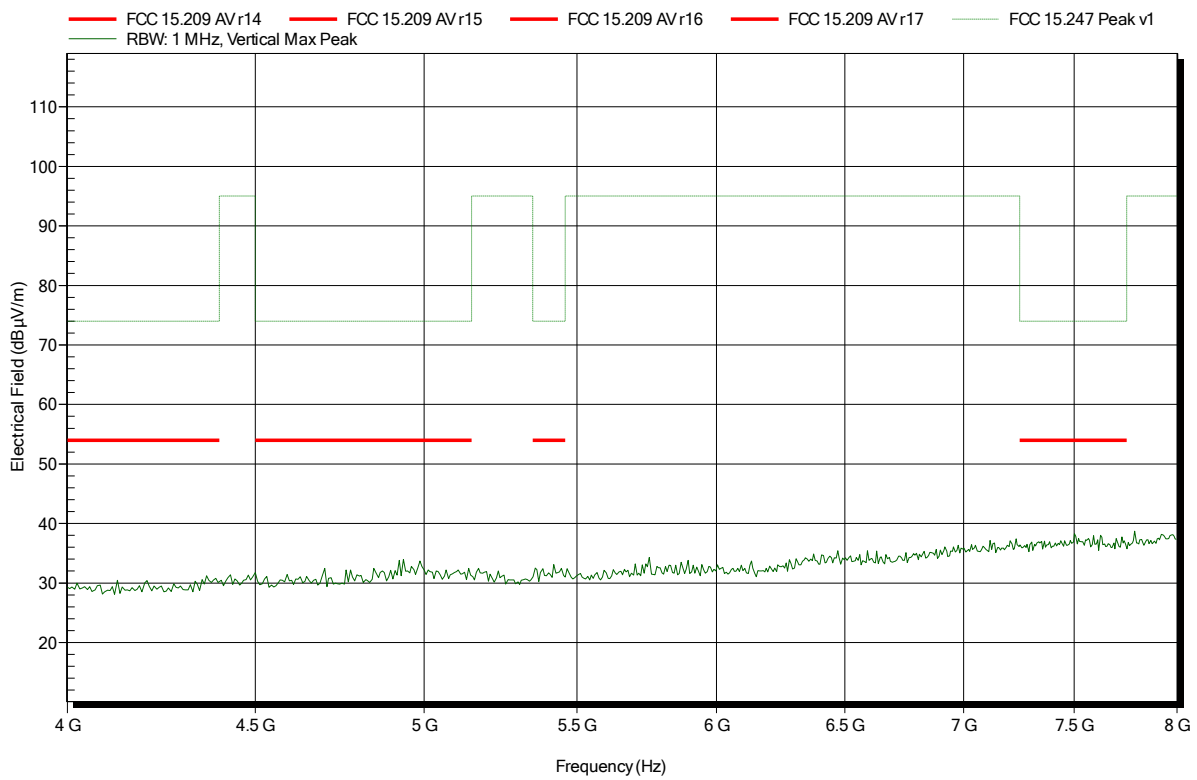

ANNEX B Receiver spurious emissions

Spurious emissions according to RSS-247 Issue 2

Project number: G0M-1812-7888

Applicant: Leica Geosystems AG
 EUT Name: Field Controller Win EC7
 Model: CS20 LTE Disto (US, CA)
 Test Site: Eurofins Product Service GmbH
 Operator: Wilfried Treffke
 Test Conditions: Tnom: 24°C, Vnom: Vnom: 120V AC (intern 11.1 V DC)
 Antenna: Rohde & Schwarz HK 116, Horizontal
 Measurement distance: 3 m
 Mode: RX; IEEE 802.11b; 2437 MHz
 Test Date: 2019-02-13
 Note:

Index 45

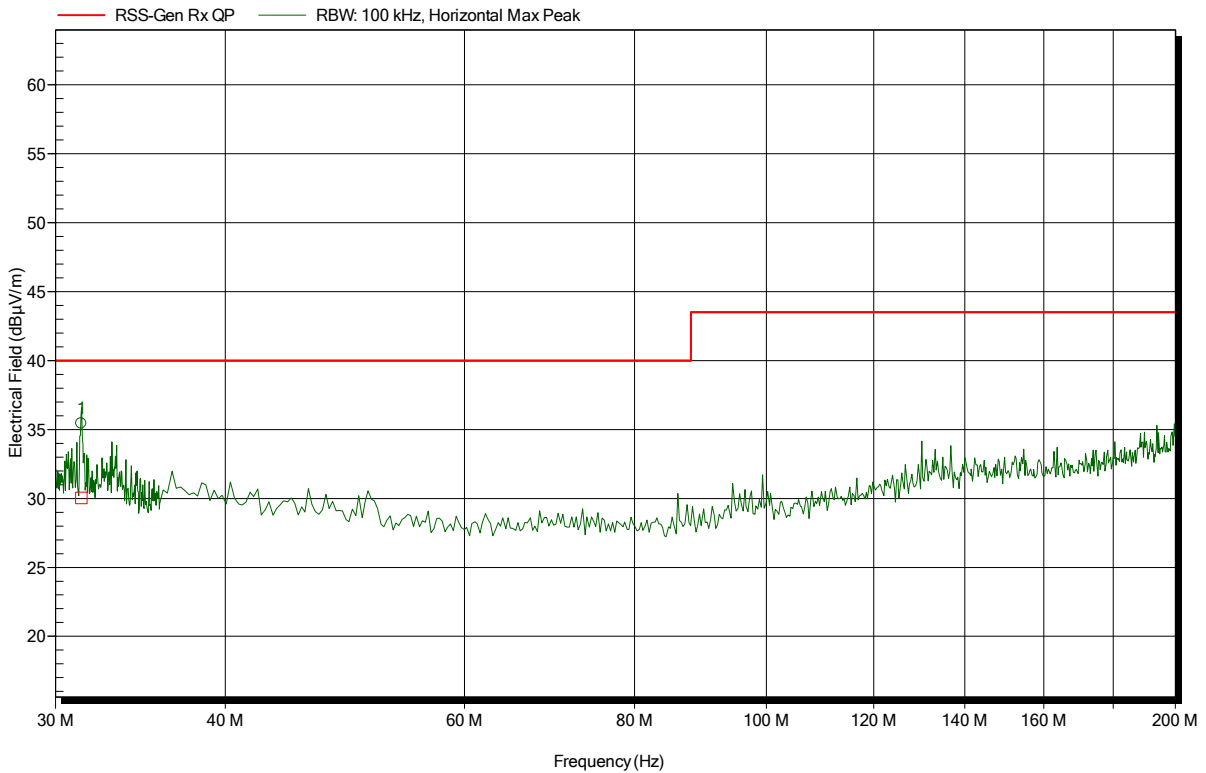

Frequency	Peak	Peak Limit	Peak Difference	Status	Angle	Height
31.354 MHz	35.43 dBµV/m	40 dBµV/m	-4.57 dB	Pass	291 Degree	1.2 m
Frequency	Quasi-Peak	Quasi-Peak Limit	Quasi-Peak Difference	Quasi-Peak Status	Angle	Height
31.354 MHz	30.04 dBµV/m	40 dBµV/m	-9.96 dB	Pass	291 Degree	1.2 m

Spurious emissions according to RSS-247 Issue 2

Project number: G0M-1812-7888

Applicant: Leica Geosystems AG
 EUT Name: Field Controller Win EC7
 Model: CS20 LTE Disto (US, CA)
 Test Site: Eurofins Product Service GmbH
 Operator: Wilfried Treffke
 Test Conditions: Tnom: 24°C, Vnom: Vnom: 120V AC (intern 11.1 V DC)
 Antenna: Rohde & Schwarz HK 116, Vertical
 Measurement distance: 3 m
 Mode: RX; IEEE 802.11b; 2437 MHz
 Test Date: 2019-02-13
 Note:

Index 47

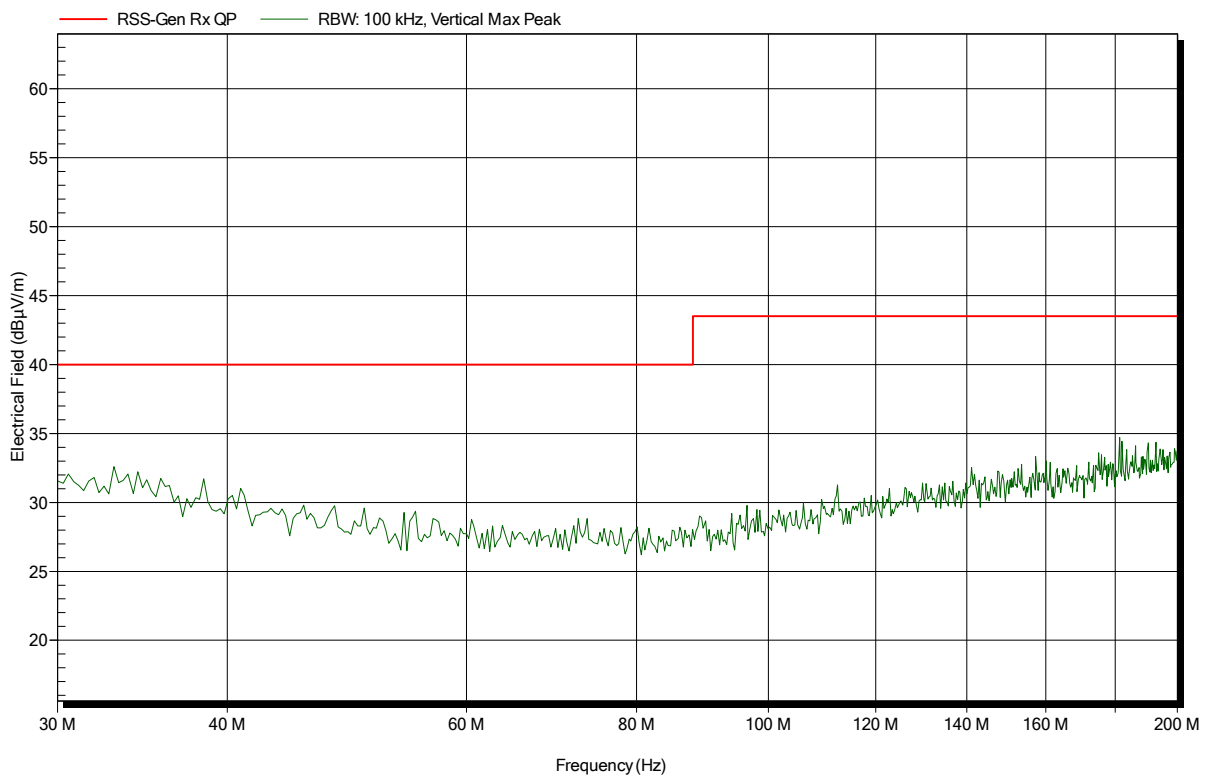

Spurious emissions according to RSS-247 Issue 2

Project number: G0M-1812-7888

Applicant: Leica Geosystems AG
 EUT Name: Field Controller Win EC7
 Model: CS20 LTE Disto (US, CA)
 Test Site: Eurofins Product Service GmbH
 Operator: Wilfried Treffke
 Test Conditions: Tnom: 24°C, Vnom: Vnom: 120V AC (intern 11.1 V DC)
 Antenna: Rohde & Schwarz HL 223, Horizontal
 Measurement distance: 3 m
 Mode: RX; IEEE 802.11b; 2437 MHz
 Test Date: 2019-02-13
 Note:

Index 46

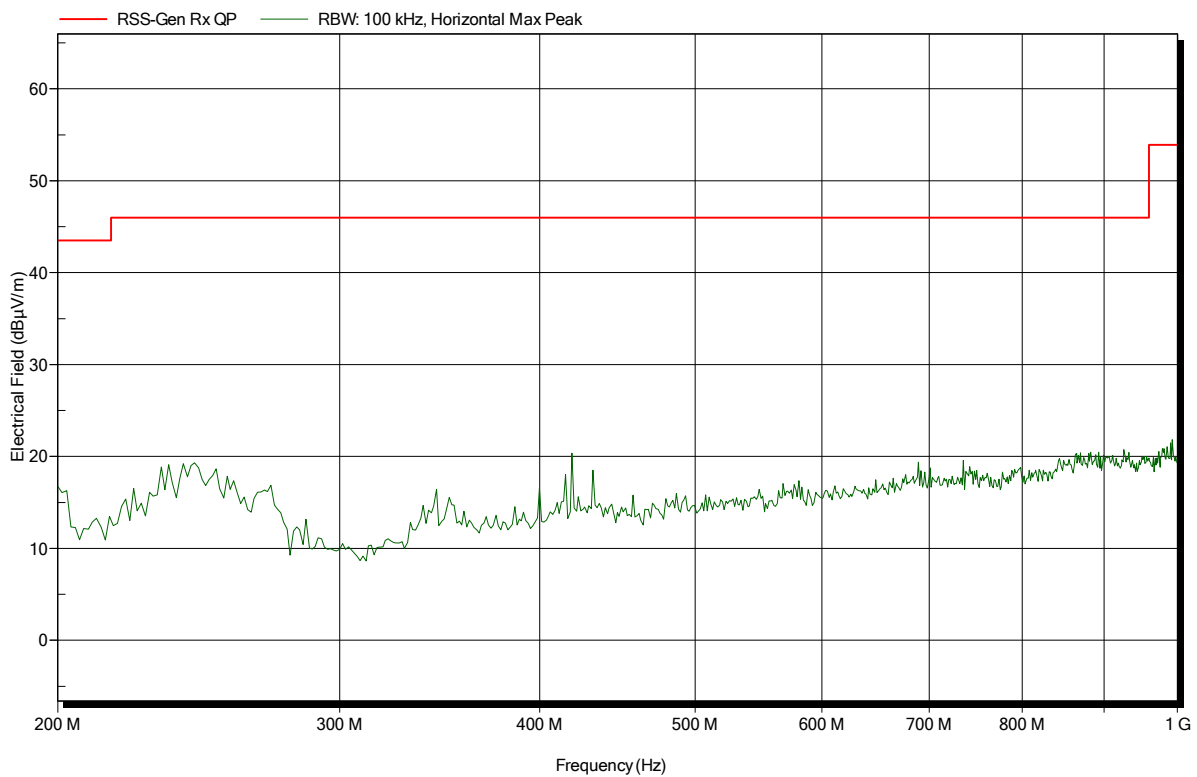

Spurious emissions according to RSS-247 Issue 2

Project number: G0M-1812-7888

Applicant: Leica Geosystems AG
 EUT Name: Field Controller Win EC7
 Model: CS20 LTE Disto (US, CA)
 Test Site: Eurofins Product Service GmbH
 Operator: Wilfried Treffke
 Test Conditions: Tnom: 24°C, Vnom: Vnom: 120V AC (intern 11.1 V DC)
 Antenna: Rohde & Schwarz HL 223, Vertical
 Measurement distance: 3 m
 Mode: RX; IEEE 802.11b; 2437 MHz
 Test Date: 2019-02-13
 Note:

Index 48

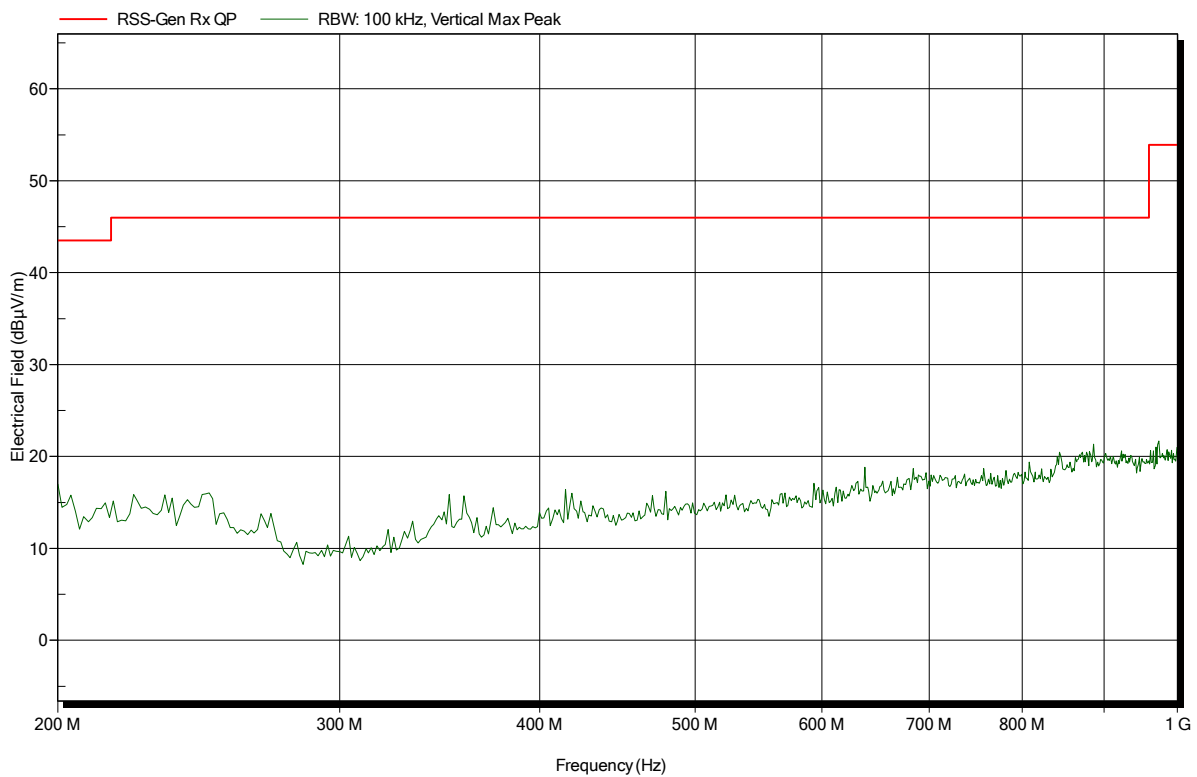

Spurious emissions according to RSS-247 Issue 2

Project number: G0M-1812-7888

Applicant: Leica Geosystems AG
 EUT Name: Field Controller Win EC7
 Model: CS20 LTE Disto (US, CA)
 Test Site: Eurofins Product Service GmbH
 Operator: Wilfried Treffke
 Test Conditions: Tnom: 24°C, Vnom: Vnom: 120V AC (intern 11.1 V DC)
 Antenna: Schwarzbeck BBHA 9120D, Horizontal
 Measurement distance: 3 m
 Mode: RX; IEEE 802.11b; 2437 MHz
 Test Date: 2019-02-13
 Note:

Index 49

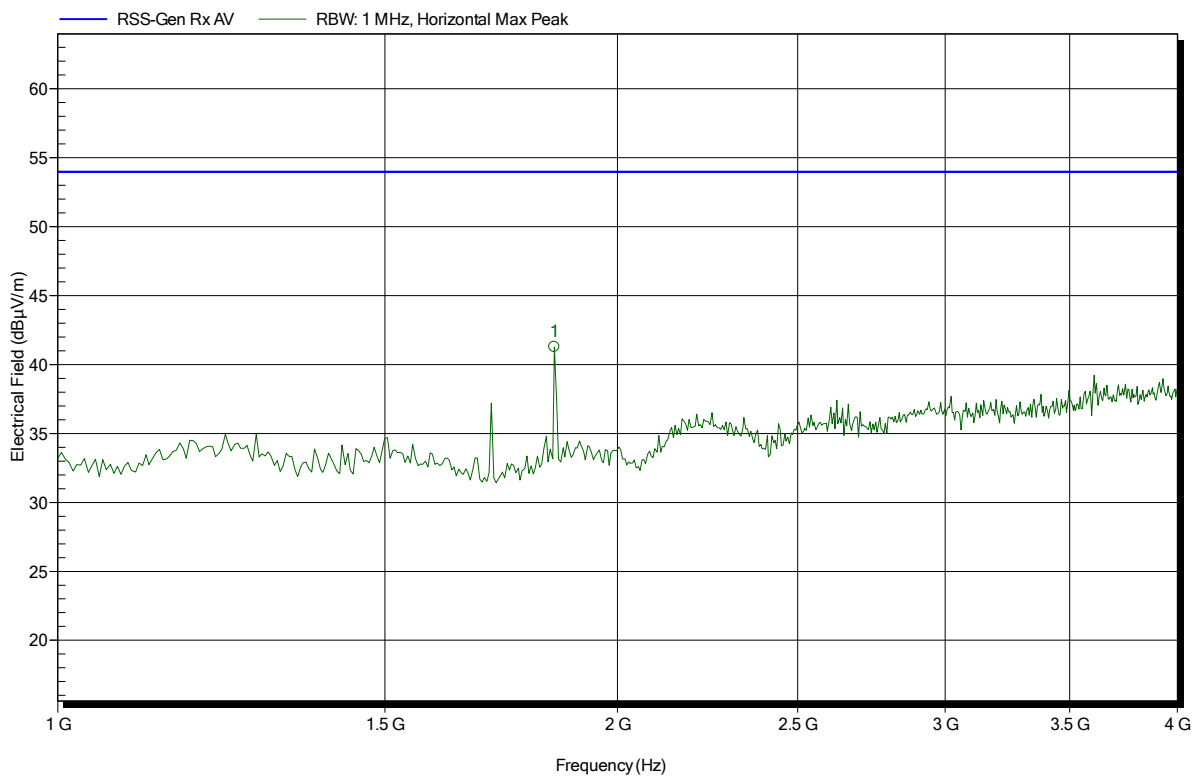

Frequency	Peak	Peak Limit	Peak Difference	Peak Status
1.85 GHz	41.27 dBµV/m	53.98 dBµV/m	-12.71 dB	Pass

Spurious emissions according to RSS-247 Issue 2

Project number: G0M-1812-7888

Applicant: Leica Geosystems AG
 EUT Name: Field Controller Win EC7
 Model: CS20 LTE Disto (US, CA)
 Test Site: Eurofins Product Service GmbH
 Operator: Wilfried Treffke
 Test Conditions: Tnom: 24°C, Vnom: Vnom: 120V AC (intern 11.1 V DC)
 Antenna: Schwarzbeck BBHA 9120D, Vertical
 Measurement distance: 3 m
 Mode: RX; IEEE 802.11b; 2437 MHz
 Test Date: 2019-02-13
 Note:

Index 52

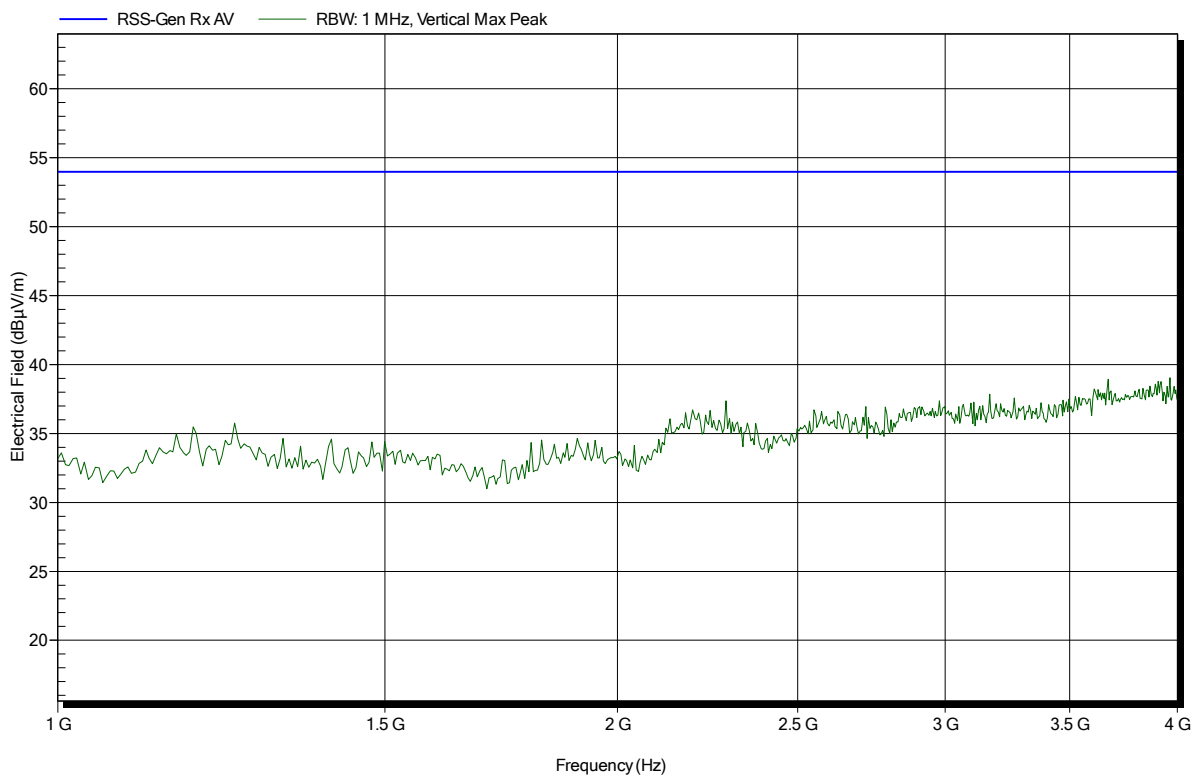

Spurious emissions according to RSS-247 Issue 2

Project number: G0M-1812-7888

Applicant: Leica Geosystems AG
 EUT Name: Field Controller Win EC7
 Model: CS20 LTE Disto (US, CA)
 Test Site: Eurofins Product Service GmbH
 Operator: Wilfried Treffke
 Test Conditions: Tnom: 24°C, Vnom: Vnom: 120V AC (intern 11.1 V DC)
 Antenna: Schwarzbeck BBHA 9120D, Vertical
 Measurement distance: 1 m
 Mode: RX; IEEE 802.11b; 2437 MHz
 Test Date: 2019-02-13
 Note:

Index 53

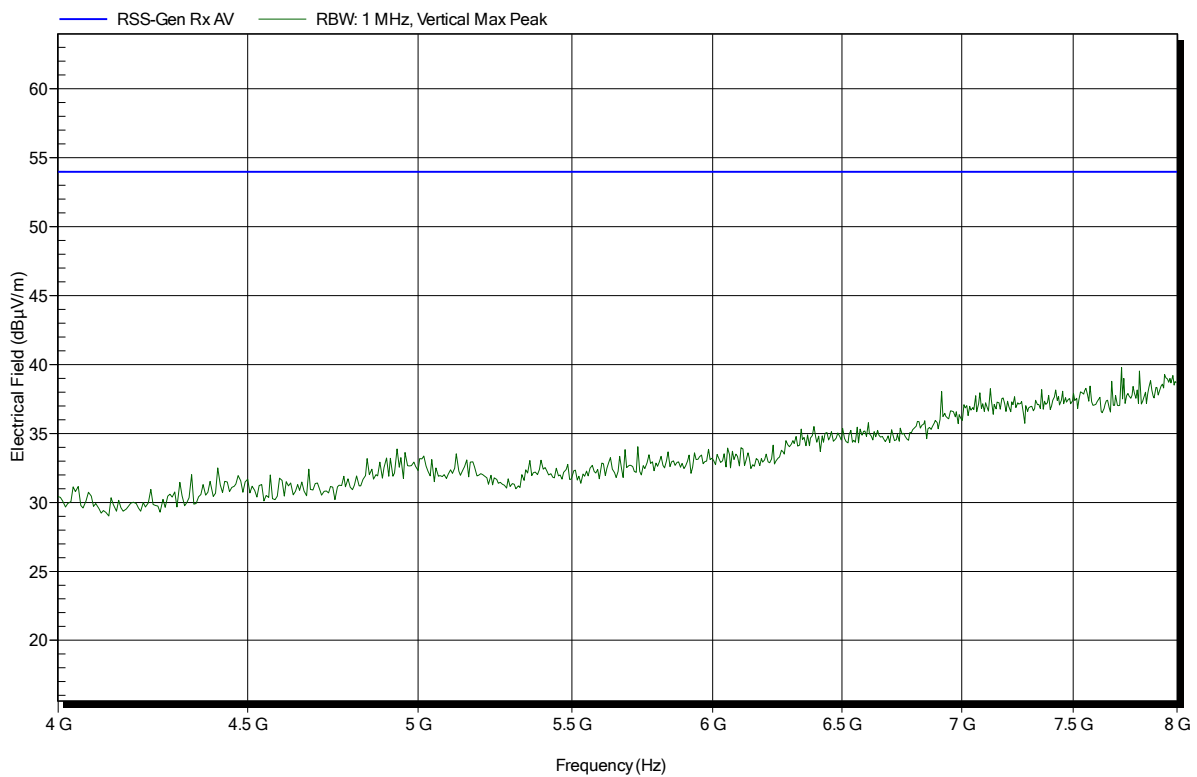

Spurious emissions according to RSS-247 Issue 2

Project number: G0M-1812-7888

Applicant: Leica Geosystems AG
 EUT Name: Field Controller Win EC7
 Model: CS20 LTE Disto (US, CA)
 Test Site: Eurofins Product Service GmbH
 Operator: Wilfried Treffke
 Test Conditions: Tnom: 24°C, Vnom: Vnom: 120V AC (intern 11.1 V DC)
 Antenna: Schwarzbeck BBHA 9120D, Horizontal
 Measurement distance: 3 m
 Mode: RX; IEEE 802.11b; 2437 MHz
 Test Date: 2019-02-13
 Note:

Index 50

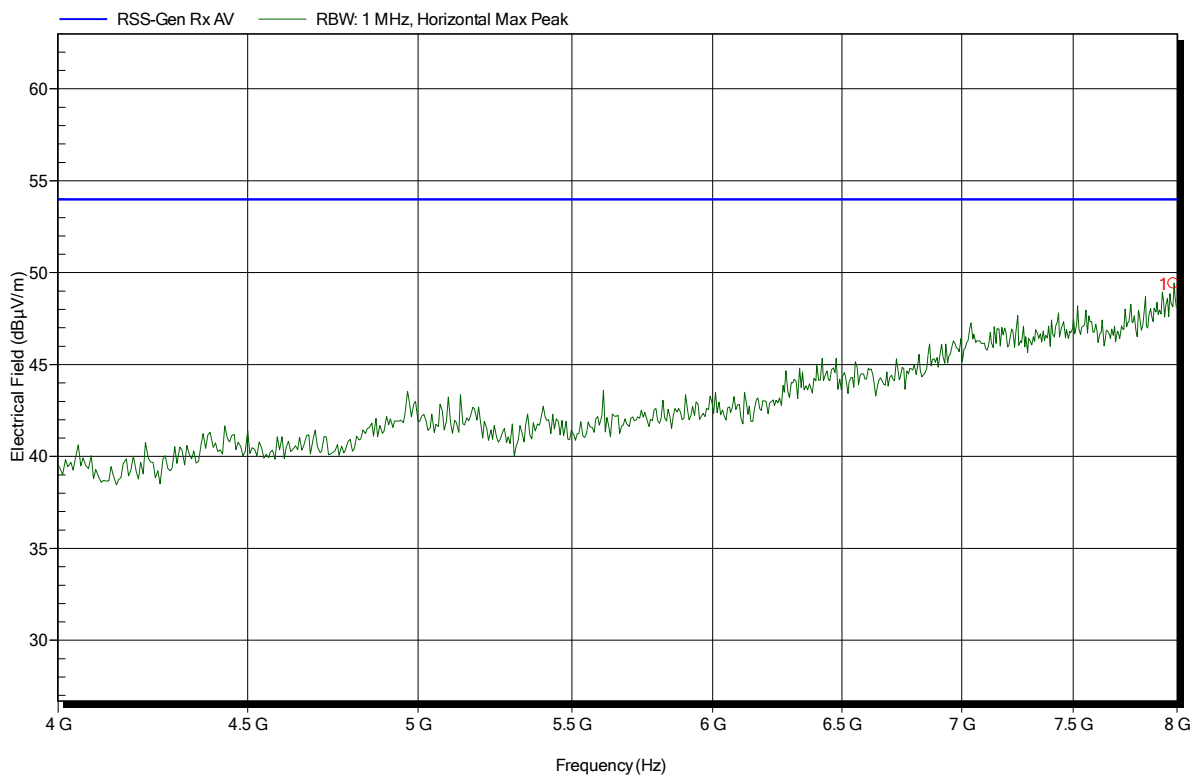

Frequency	Peak	Peak Limit	Peak Difference	Peak Status
7.981 GHz	49.41 dBµV/m	53.98 dBµV/m	-4.57 dB	Pass

Spurious emissions according to RSS-247 Issue 2

Project number: G0M-1812-7888

Applicant: Leica Geosystems AG
 EUT Name: Field Controller Win EC7
 Model: CS20 LTE Disto (US, CA)
 Test Site: Eurofins Product Service GmbH
 Operator: Wilfried Treffke
 Test Conditions: Tnom: 24°C, Vnom: Vnom: 120V AC (intern 11.1 V DC)
 Antenna: Schwarzbeck BBHA 9120D, Horizontal
 Measurement distance: 1 m converted to 3m
 Mode: RX; IEEE 802.11b; 2437 MHz
 Test Date: 2019-02-13
 Note:

Index 51

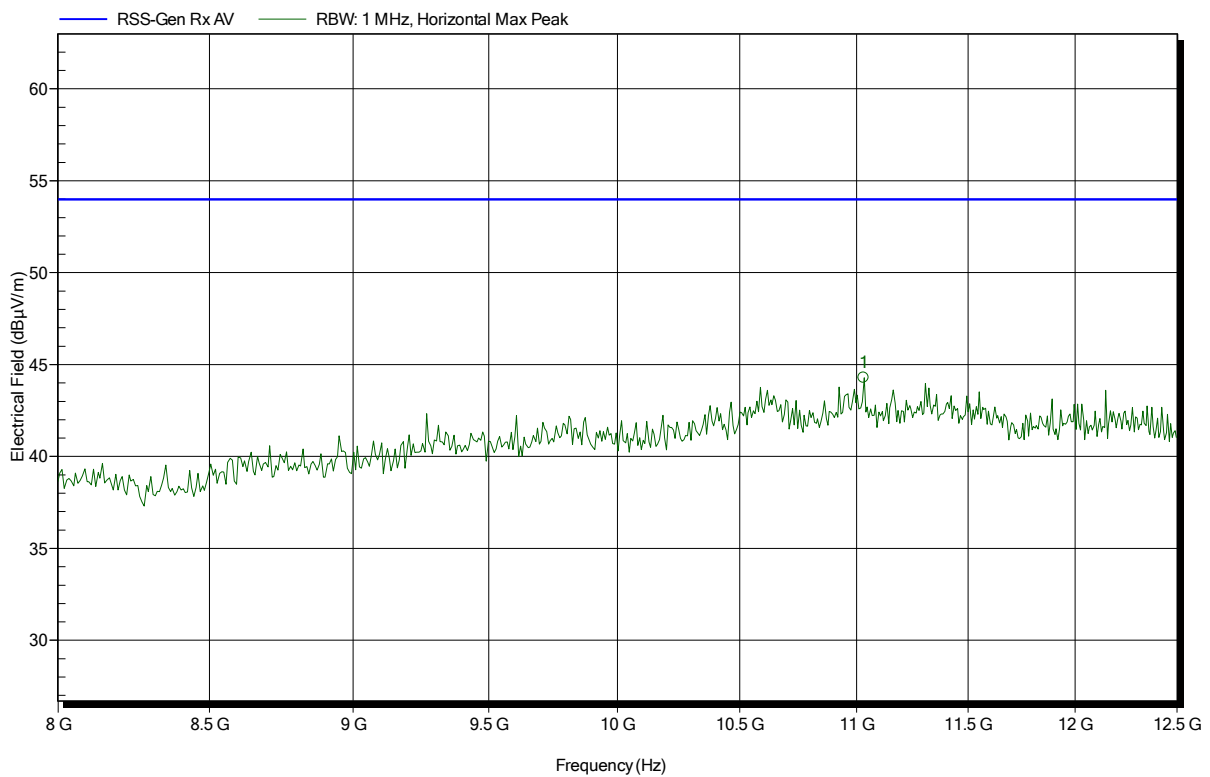

Frequency	Peak	Peak Limit	Peak Difference	Status
11.031 GHz	44.28 dBµV/m	53.98 dBµV/m	-9.7 dB	Pass

Spurious emissions according to RSS-247 Issue 2

Project number: G0M-1812-7888

Applicant: Leica Geosystems AG
 EUT Name: Field Controller Win EC7
 Model: CS20 LTE Disto (US, CA)
 Test Site: Eurofins Product Service GmbH
 Operator: Wilfried Treffke
 Test Conditions: Tnom: 24°C, Vnom: Vnom: 120V AC (intern 11.1 V DC)
 Antenna: Schwarzbeck BBHA 9120D, Vertical
 Measurement distance: 1 m converted to 3m
 Mode: RX; IEEE 802.11b; 2437 MHz
 Test Date: 2019-02-13
 Note:

Index 54

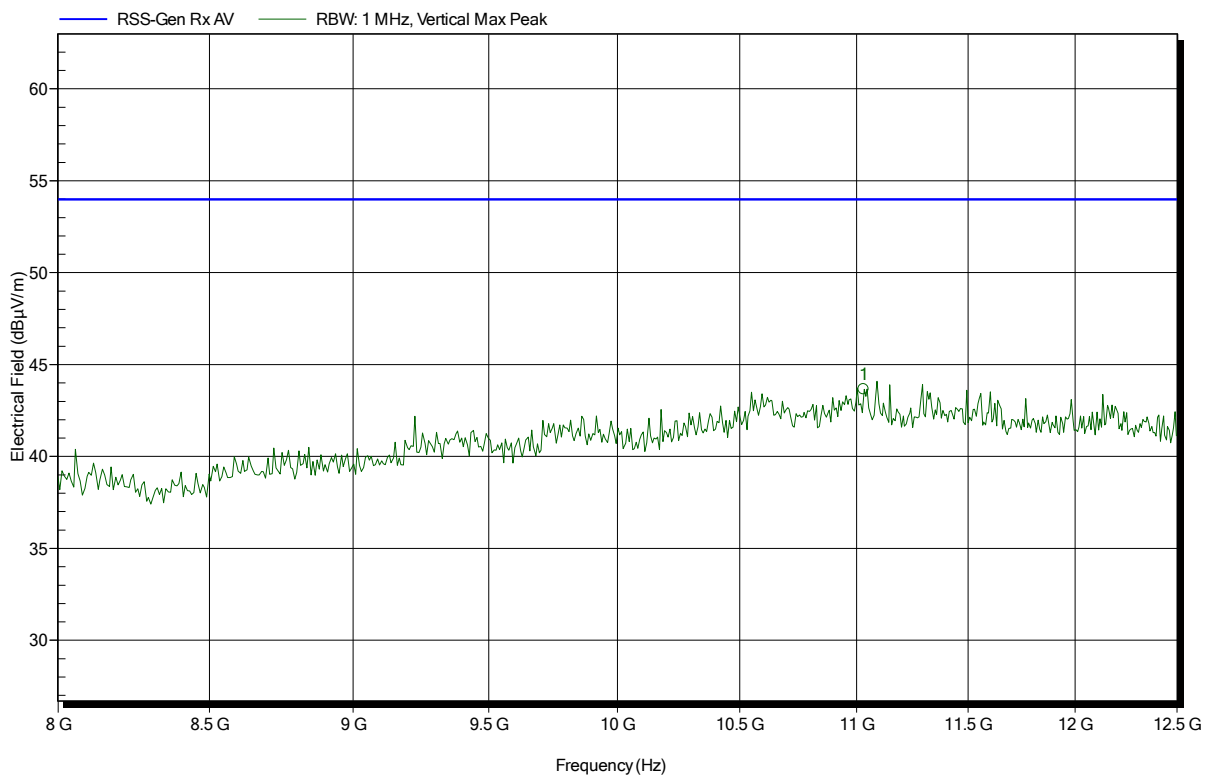

Frequency	Peak	Peak Limit	Peak Difference	Status
11.031 GHz	43.66 dBµV/m	53.98 dBµV/m	-10.32 dB	Pass