



Leica CS10/CS15

User Manual



Version 3.0
English

- when it has to be **right**

Leica
Geosystems

Introduction

Purchase



Congratulations on the purchase of a Leica CS10/CS15.

This manual contains important safety directions as well as instructions for setting up the product and operating it. Refer to "5 Safety Directions" for further information.

Read carefully through the User Manual before you switch on the product.

Product identification





The type and serial number of your product are indicated on the type plate. Enter the type and serial number in your manual and always refer to this information when you need to contact your agency or Leica Geosystems authorised service workshop.

Type: _____

Serial No.: _____

Symbols

The symbols used in this manual have the following meanings:

Type	Description
 Danger	Indicates an imminently hazardous situation which, if not avoided, will result in death or serious injury.
 Warning	Indicates a potentially hazardous situation or an unintended use which, if not avoided, could result in death or serious injury.
 Caution	Indicates a potentially hazardous situation or an unintended use which, if not avoided, may result in minor or moderate injury and/or appreciable material, financial and environmental damage.
	Important paragraphs which must be adhered to in practice as they enable the product to be used in a technically correct and efficient manner.

Trademarks



- Windows is a registered trademark of Microsoft Corporation in the United States and other countries
- CompactFlash and CF are trademarks of SanDisk Corporation
- Bluetooth is a registered trademark of Bluetooth SIG, Inc.
- SD is a trademark of the SD Card Association



All other trademarks are the property of their respective owners.



Validity of this manual

This manual applies to the CS10 and CS15 field controllers. Differences between the various models are marked and described.

Available documentation

Name	Description/Format		
CS10/CS15 User Manual	All instructions required in order to operate the product to a basic level are contained in the User Manual. Provides an overview of the product together with technical data and safety directions.	✓	✓

Name	Description/Format		
Viva GNSS Getting Started Guide	Describes the general working of the product in standard use. Intended as a quick reference field guide.	✓	✓

Name	Description/Format		
Viva TPS Getting Started Guide	Describes the general working of the product in standard use. Intended as a quick reference field guide.	✓	✓
Viva Series Technical Reference Manual	Overall comprehensive guide to the product and application functions. Included are detailed descriptions of special software/hardware settings and software/hardware functions intended for technical specialists.		✓

Refer to the following resources for all CS10/CS15 documentation/software:

- the Leica Viva Series DVD
- <https://myworld.leica-geosystems.com>



myWorld@Leica Geosystems (<https://myworld.leica-geosystems.com>) offers a wide range of services, information and training material. With direct access to myWorld, you are able to access all relevant services whenever it is convenient for you, 24 hours a day, 7 days per week. This increases your efficiency and keeps you and your equipment instantly updated with the latest information from Leica Geosystems.

Service	Description
myProducts	Simply add all Leica Geosystems products that you and your company own. View detailed information on your products, buy additional options or Customer Care Packages (CCPs), update your products with the latest software and keep up-to-date with the latest documentation.
myService	View the service history of your products in Leica Geosystems Service Centers and detailed information on the services performed on your products. For your products that are currently in Leica Geosystems Service Centers view the current service status and the expected end date of service.
mySupport	Create new support requests for your products that will be answered by your local Leica Geosystems Support Team. View the complete history of your Support and view detailed information on each request in case you want to refer to previous support requests.
myTraining	Enhance your product knowledge with the Leica Geosystems Campus - Information, Knowledge, Training. Study the latest online training material or download training material on your products. Keep up-to-date with the latest News on your products and register for Seminars or Courses in your country.

Table of Contents

In this manual	Chapter	Page
	1 Description of the System	11
	1.1 Overview	11
	1.2 Terminology	12
	1.3 System Concept	14
	1.3.1 Software Concept	14
	1.3.2 Power Concept	18
	1.3.3 Data Storage Concept	19
	1.4 CS Components	21
	1.4.1 CS10	21
	1.4.2 CS15	23
	1.5 Docking Station Components	25
	2 User Interface	26
	2.1 Keyboard	26
	2.2 Operating Principles	32
	3 Operation	33
	3.1 Equipment Setup	33

3.1.1	Fixing the Display Foil to the CS	33
3.1.2	Fixing a Hand Strap to the CS	35
3.1.3	Fixing the Slot Cover to the CS	37
3.1.4	Inserting and Removing a SIM Card	38
3.1.5	Setting up as Handheld GNSS	40
3.1.6	Setting up the Docking Station	42
3.1.7	Connecting to a Personal Computer	43
3.2	Power Functions	49
3.3	Batteries	51
3.3.1	Operating Principles	51
3.3.2	Changing the Battery	52
3.3.3	Charging the Battery	55
3.4	Working with the Memory Device	57
3.5	LED Indicators on CS10 /CS15	61
3.6	LED Indicators on GS08 /GS12	64
3.7	Using the Digital Camera	66
4	Care and Transport	68
4.1	Transport	68
4.2	Storage	69
4.3	Cleaning and Drying	70

5	Safety Directions	72
5.1	General Introduction	72
5.2	Intended Use	73
5.3	Limits of Use	75
5.4	Responsibilities	76
5.5	Hazards of Use	78
5.6	Electromagnetic Compatibility EMC	84
5.7	FCC Statement, Applicable in U.S.	87
6	Technical Data	92
6.1	CS10 /CS15 Technical Data	92
6.2	GS05 /GS06 Technical Data	97
6.2.1	Tracking Characteristics	97
6.2.2	Accuracy	99
6.2.3	Technical Data	100
6.3	GS08 /GS12 Technical Data	103
6.3.1	Tracking Characteristics	103
6.3.2	Accuracy	106
6.3.3	Technical Data	108
6.4	Antennas Technical Data	112
6.5	Conformity to National Regulations	115

CS10/CS15, Table of Contents	10
6.5.1 CS10	115
6.5.2 CS15	119
6.5.3 GS08	122
6.5.4 GS12	124
7 International Limited Warranty, Software Licence Agreement	126
Appendix A Pin Assignments and Sockets	128
A.1 CS10 /CS15	128
A.2 GS08 /GS12	131
Index	133

1 Description of the System

1.1 Overview

System components

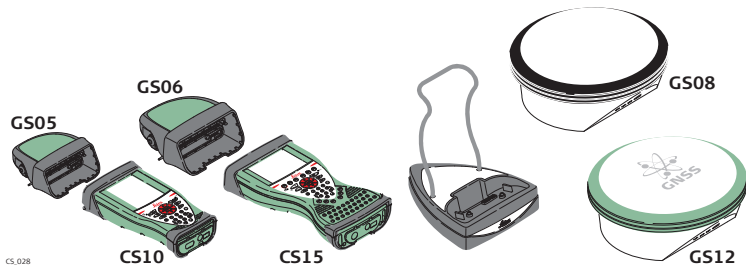

1.2 Terminology

CS general description

CS is a collective term describing the various models (CS10/CS15) of the multi-purpose field controller which is used with GNSS and TPS instruments.

CS available models

Model	Touch screen	Colour display	Internal radio modem	Internal 3.5 GSM/UMTS modem	Internal battery*1	SD card	CompactFlash card	Bluetooth	Wireless LAN 802.11b/g	Windows CE
Basic (CS10/CS15)	✓	✓	-	-	✓	✓	✓	✓	-	✓
WLAN (CS10/CS15)	✓	✓	-	-	✓	✓	✓	✓	✓	✓
Radio (CS10/CS15)	✓	✓	✓	-	✓	✓	✓	✓	✓	✓
GSM (CS10/CS15)	✓	✓	-	✓	✓	✓	✓	✓	✓	✓
Radio + GSM (CS15)	✓	✓	✓	✓	✓	✓	✓	✓	✓	✓
 Use the supplied stylus on the screens of the touch screen.										

*1 removable

CS available radios

Radios for remote control (RCS) are available for the following devices:

Radio Modem	Description
CS10	Field controller with an integrated radio modem. This field controller has a colour display.
CS15	Field controller with an integrated radio modem. This field controller has a colour display.
 All devices contain the same spread spectrum transceiver radio modem.	

1.3 System Concept

1.3.1 Software Concept

Software for all CS models

Software type	Description
CS firmware (CS_xx.fw)	This software includes: <ul style="list-style-type: none">- The language-specific version of Windows CE.- The basic functionality of the CS.

Software for the GS05/GS06

Software type	Description
GS firmware (GS_xx.fw)	This software includes: <ul style="list-style-type: none">- The firmware for the measurement engine.

Software for the GS08/GS12

Software type	Description
ME firmware (ME_xx.fw)	This software includes: <ul style="list-style-type: none">- The firmware for the measurement engine.

Software upload



Uploading firmware can take some time. Ensure that the battery is at least 75% full before beginning the upload, and do not remove the battery during the upload process.

Software for	Description
All CS models	<p>The software is stored in the flash RAM of the CS field controller.</p> <p>CS firmware update instructions</p> <ul style="list-style-type: none">• Download the most recent CS firmware file from https://myworld.leica-geosystems.com. Refer to "Introduction".• Connect the CS field controller to your PC. Refer to "3.1.7 Connecting to a Personal Computer".• Copy CS firmware file onto a folder on the Leica SD card, Leica CompactFlash card or USB stick.• Tap the Loader icon from the desktop, to run the Loader application.• Browse to the directory into which you copied CS firmware file, select it and start the upload.• A message will appear when the upload is complete. <p> Ensure that a Leica SD card or a Leica CF card is inserted into the CS field controller before starting the upload.</p>

Software for	Description
GS05/GS06	<p>The software is stored in the flash RAM of the GS05/GS06.</p> <p>GS firmware update instructions</p> <ul style="list-style-type: none">• Download the most recent GS firmware file from https://myworld.leica-geosystems.com. Refer to "Introduction".• Connect the CS field controller to your PC. Refer to "3.1.7 Connecting to a Personal Computer".• Copy GS firmware file into the /SYSTEM directory of the Leica SD card or Leica CompactFlash card.• Connect the GS05/GS06 to the CS field controller. Refer to "3.1.5 Setting up as Handheld GNSS".• Establish a connection between the GS05/GS06 and the CS field controller. Refer to the Leica Viva TechRef (Instrument connections - GPS connection wizard).• Start the upload. Refer to the Leica Viva GNSS Getting Started Guide (Appendix B Uploading System Files).• A message will appear when the upload is complete.

Software for	Description
GS08/GS12	<p>The software is stored in the flash RAM of the GS08/GS12.</p> <p>ME firmware update instructions</p> <ul style="list-style-type: none"> • Download the most recent ME firmware file from https://myworld.leica-geosystems.com. Refer to "Introduction". • Connect the CS field controller to your PC. Refer to "3.1.7 Connecting to a Personal Computer". • Copy ME firmware file into the /SYSTEM directory of the Leica SD card or Leica CompactFlash card. • Connect the GS08/GS12 with the GEV234/GEV237 cable to the CS field controller and establish a connection between the GS08/GS12 and the CS field controller. Refer to the Leica Viva TechRef (Instrument connections - GPS connection wizard). • Start the upload. Refer to the Leica Viva GNSS Getting Started Guide (Appendix B Uploading System Files). • A message will appear when the upload is complete.

1.3.2 Power Concept

General

Use the Leica Geosystems batteries, chargers and accessories or accessories recommended by Leica Geosystems to ensure the correct functionality of the instrument.

Power options

Model	Power supply
all CS models	Internally by GEB211/GEB212 battery, OR Externally by docking station, OR Externally by GEV235 cable, OR Externally by GEV219 cable (only CS models with LEMO CBC01 connector module), OR Externally by GDC221 car adapter If an external power supply is connected and the internal battery is inserted, then the external power is used.
GS05/GS06	Externally by CS field controller
GS08/GS12	Internally by GEB211/GEB212 battery, OR Externally by GEV219 cable If an external power supply is connected and the internal battery is inserted, then the external power is used.

1.3.3

Data Storage Concept

Description

Data is stored on a memory device. The memory device can be an SD card, CompactFlash card, USB stick or internal memory.

Memory device

SD card: All CS field controllers have an SD card slot fitted as standard. An SD card can be inserted and removed. Available capacity: 1 GB.

CompactFlash card: All CS field controllers have a CF card slot fitted as standard. A CompactFlash card can be inserted and removed. Available capacity: 256 MB, 1 GB.

USB stick: All CS field controllers have a USB port fitted as standard.

Internal memory: All CS field controllers have an internal memory fitted as standard. Available capacity: 1 GB.



While other SD cards or CompactFlash cards can be used, Leica Geosystems recommends to only use Leica SD cards or Leica CompactFlash cards and is not responsible for data loss or any other error that can occur while using a non-Leica card.



Removing the SD card, CompactFlash card or USB stick while the CS field controller is turned on can cause loss of data. Only remove the SD card, CompactFlash card or USB stick or unplug connecting cables when the CS field controller is switched off.

Transfer data

Data can be transferred in various ways. Refer to "3.1.7 Connecting to a Personal Computer".



CompactFlash cards and SD cards can directly be used in an OMNI drive as supplied by Leica Geosystems. Other PC card drives can require an adaptor.

1.4

1.4.1

CS Components

CS10

Upside of CS10

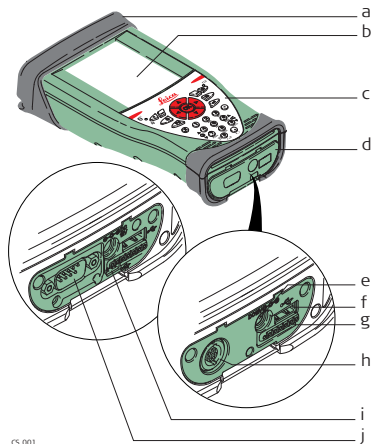

Underside of CS10

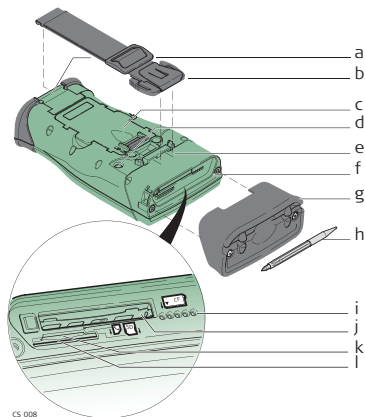

CS_008

- a) Hand strap bottom clips
- b) Hand strap
- c) Battery compartment
- d) Digital camera
- e) Hand strap top clips
- f) Slots
- g) Slot cover
- h) Stylus
- i) GS05 contacts
- j) CompactFlash card slot
- k) SIM card slot
- l) SD card slot

1.4.2

CS15

Upside of CS15

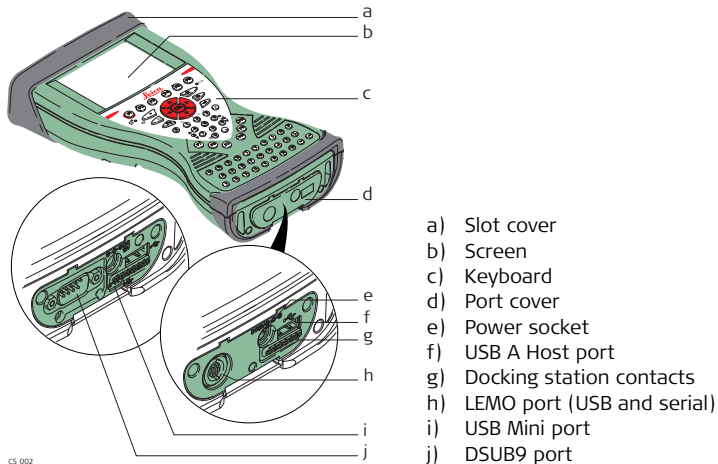

CS_002

Underside of CS15

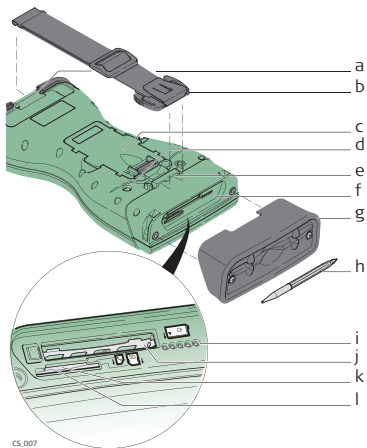

- a) Hand strap bottom clips
- b) Hand strap
- c) Battery compartment
- d) Digital camera
- e) Hand strap top clips
- f) Slots
- g) Slot cover
- h) Stylus
- i) GS06 contacts
- j) CompactFlash card slot
- k) SIM card slot
- l) SD card slot

CS_007

1.5

Docking Station Components

Docking station

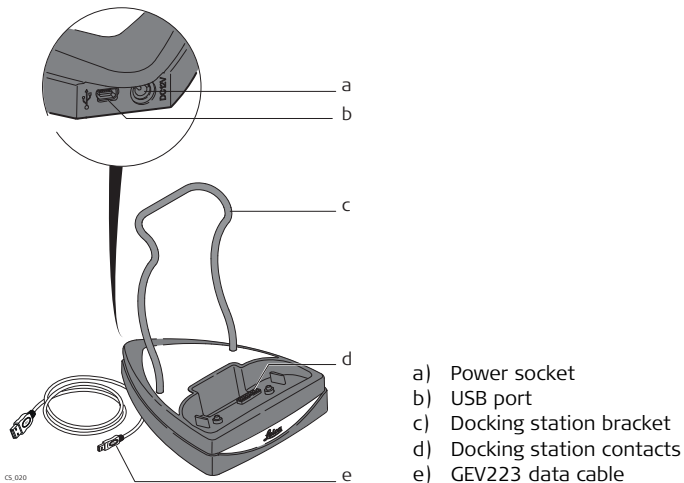

2 User Interface

2.1 Keyboard

Keyboard display
CS10

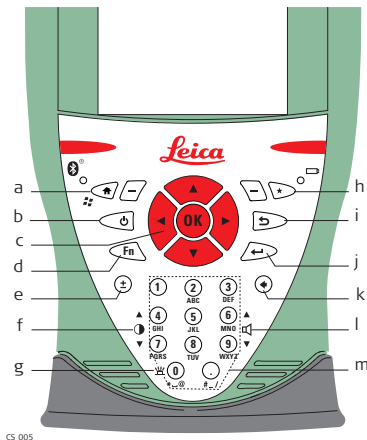





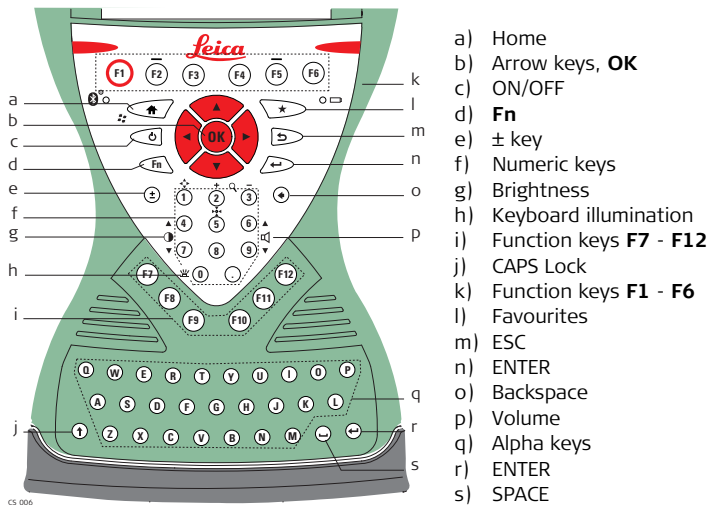







- a) Home
- b) ON/OFF
- c) Arrow keys, **OK**
- d) **Fn**
- e) ± key
- f) Brightness
- g) Keyboard illumination
- h) Favourites
- i) ESC
- j) Enter
- k) Backspace
- l) Volume
- m) Numeric keys



Keyboard display CS15













Keys

Key		Function
Function keys F1-F6		Correspond to six softkeys that appear on the bottom of the screen when the screen is activated.
Function keys F7-F12		User definable keys to execute chosen commands or access chosen screens.
Alpha keys		To type letters.
Numeric keys		To type numbers.
Caps Lock		Switches between upper case and lower case letters.
Backspace		Clears all entry at the beginning of user input. Clears the last character during user input.
Esc		Leaves the current screen without storing any changes.
Fn		Switches between the first and second level of function keys.
Space		Enters a blank.

Key	Function
Enter 	Selects the highlighted line and leads to the next logical menu/ dialog. Starts the edit mode for editable fields. Opens a selectable list.
ON/OFF 	If CS10/CS15 already off: Turns on CS10/CS15 when held for 2 s. If CS10/CS15 in stand-by mode: Turns on CS10/CS15 when held < 2 s. If CS10/CS15 already on: <ul style="list-style-type: none"> • Puts CS10/CS15 into stand-by mode when held < 2 s. Refer to "Stand-by". • Turns to Power Options menu when held for 2 s. Refer to "Power Options menu". • Turns off CS10/CS15 when held for 5 s.
Favourites 	Goes to a website by simply clicking its name.
Home 	Switches to the Windows CE Start Menu.

Key	Function
Arrow keys 	Move the focus on the screen.
OK 	Selects the highlighted line and leads to the next logical menu/ dialog. Starts the edit mode for editable fields. Opens a selectable list.

Key combinations

Key	Function
 + 	Hold Fn while pressing 4 . Increase the screen brightness.
 + 	Hold Fn while pressing 7 . Decrease the screen brightness.
 + 	Hold Fn while pressing 6 . Increase the volume for acoustic warning signals, beeps and keypresses on the CS field controller.
 + 	Hold Fn while pressing 9 . Decrease the volume for acoustic warning signals, beeps and keypresses on the CS field controller.
 + 	Hold Fn while pressing 0 . If keyboard illumination is already off: Turns on keyboard illumination. If keyboard illumination is already on: Turns off keyboard illumination.

2.2

Operating Principles

Keyboard and touch screen

The user interface is operated either by the keyboard or by the touch screen with supplied stylus. The workflow is the same for keyboard and touch screen entry, the only difference lies in the way information is selected and entered.

Operation by keyboard

Information is selected and entered using the keys. Refer to "2.1 Keyboard" for a detailed description of the keys on the keyboard and their function.

Operation by touch screen

Information is selected and entered on the screen using the supplied stylus.

Operation	Description
To select an item	Tap on the item.
To start the edit mode in editable fields	Tap on the editable field.
To highlight an item or parts of it for editing	Drag the supplied stylus from the left to the right.
To accept data entered into an editable field and exit the edit mode	Tap on the screen outside of the editable field.
To open a context-sensitive menu	Tap on the item and hold for 2 s.

3

Operation

3.1

Equipment Setup



3.1.1

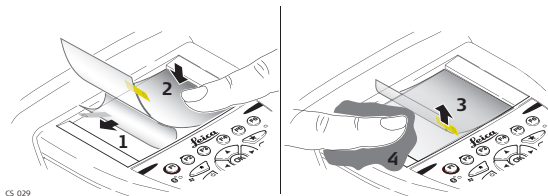

Fixing the Display Foil to the CS

Fixing the display foil to the CS step-by-step



CS_029

Step	Description
	Ensure that the display of the CS is free of dust and grease.
	The non-reflecting display foil has a silver-coloured sticker to peel away the carrier foil from the actual display foil.
1.	Touch the silver-coloured sticker with two fingers and pull it slowly upwards. The carrier foil is peeling away.  Do not peel the carrier foil more than 2 cm - 3 cm away.

Step	Description
2.	Fix the laid open adhesive underside of the display foil at the display border.  Pay attention that the display foil is not fixed between display and display frame.
3.	Peel away the carrier foil bit by bit and smooth it out slowly onto the display.
4.	Potential air bubbles between display and display foil have to be smoothed out using the included microfibre cloth.  Do not use sharp objects!

3.1.2

Fixing a Hand Strap to the CS

Fixing the CS to a hand strap step-by-step

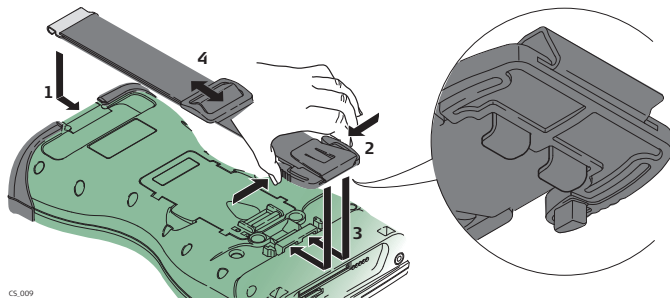

Step	Description
	Turn the CS field controller over.
1.	Take the end of the hand strap and clip it to the base of CS field controller.
2.	Compress the clips of the main hook.
3.	Lower the main hook onto the pivot knob of the CS field controller. A click can be felt when the clip is secure.

Step	Description
4.	Adjust the length of the hand strap.

3.1.3

Fixing the Slot Cover to the CS

Fixing the slot cover to the CS step-by-step

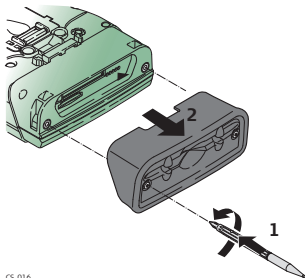

CS.016

Step	Description
1.	Press the screwdriver end of the supplied stylus on the quarter-turn screws and loosen them.
2.	Remove the slot cover.
	Reattach the slot cover with the stylus, making sure the quarter-turn screws are seated.

3.1.4 Inserting and Removing a SIM Card

Insert and remove a SIM card step-by-step

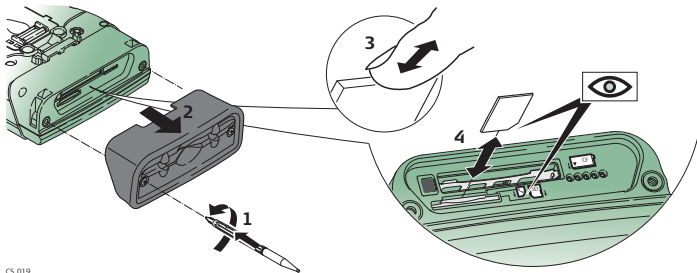

CS_019

	Description
	The SIM card is inserted into a slot inside the top of the CS10/CS15.
1.	Loosen the screws inside the slot cover on top of the CS10/CS15 using the screwdriver end of the stylus.
2.	Detach the slot cover from the CS10/CS15.
3.	Slide the card firmly into the slot until it clicks into position.

	Description
	 Do not force the card into the slot. The card should be held with the contacts facing the slot.
4.	Attach the slot cover and tighten the screws.
5.	To remove the card, detach the slot cover of the CS10/CS15.
6.	Gently press the top of the card to release it from the slot.
7.	Remove the SIM card and attach the slot cover.

3.1.5

Setting up as Handheld GNSS



The setup GS05/CS10 is identical to the setup GS06/CS15. For simplicity, the setup GS05/CS10 is used in the following.

Attaching the GS05 to the CS10 step-by-step

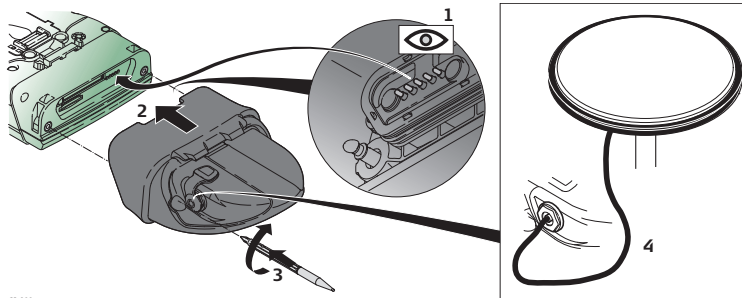

CS_011

Step	Description
	Detach the slot cover from the CS10. Refer to "3.1.3 Fixing the Slot Cover to the CS".
1.	Check the position of the contacts in the inner surface of the GS05.

Step	Description
2.	Attach the GS05 to the CS10.
3.	Press the screwdriver end of the supplied stylus on the quarter-turn screws and tighten them.
4.	To achieve the optimal satellite tracking performance, mount the AS05 (external GNSS antenna) on the GS05.

3.1.6

Setting up the Docking Station

Mounting components of the docking station step-by-step

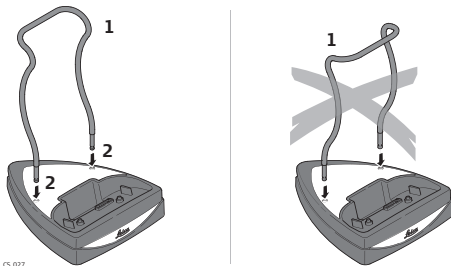

CS_027

Step	Description
1.	Hold the docking station bracket as shown in the illustration in relation to the docking station rack.
2.	Slightly press the holder into the docking station rack. A click can be felt when the holder is secure.

3.1.7



Connecting to a Personal Computer



Microsoft ActiveSync (for PCs with Windows XP operating system) or Windows Mobile Device Center (for PCs with Windows Vista or Windows 7 operating system) is the synchronisation software for Windows mobile-based pocket PCs. Microsoft ActiveSync or Windows Mobile Device Center enables a PC and a Windows mobile-based pocket PC to communicate.

Install Leica Viva USB drivers

Step	Description
1.	Start the PC.
2.	Insert the Leica Viva Series DVD.
3.	Run the SetupViva&GR_USB_XX.exe to install the drivers necessary for Leica Viva devices. Depending on the version (32bit or 64bit) of the operating system on your PC, you have to select between the three setup files following: <ul style="list-style-type: none">• SetupViva&GR_USB_32bit.exe• SetupViva&GR_USB_64bit.exe• SetupViva&GR_USB_64bit_itanium.exe  The setup has to be run only once for all Leica Viva devices.

Step	Description
4.	The Welcome to InstallShield Wizard for Leica Viva & GR USB drivers window appears.  Ensure that all Leica Viva devices are disconnected from your PC before you continue!
5.	Next> .
6.	The Ready to Install the Program window appears.
7.	Install. The drivers will be installed on your PC.  For PCs with Windows Vista or Windows 7 operating system: If not already installed, Windows Mobile Device Center will be installed additionally.
8.	The InstallShield Wizard Completed window appears.
9.	Check I have read the instructions and click Finish to exit the wizard.

Connect USB cable to PC for the first time step-by-step

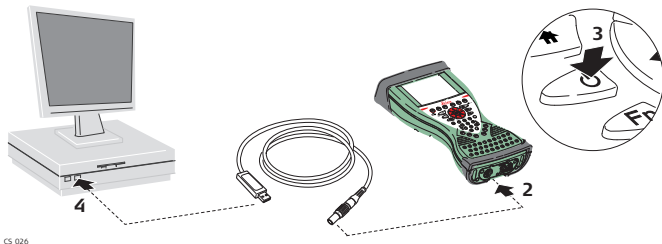



CS.026

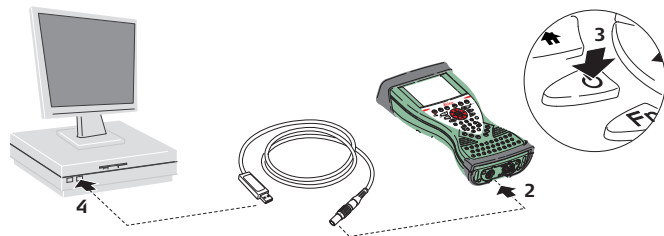

Step	Description
1.	Start the PC.
2.	Plug the GEV234 cable into CS field controller.  For CS field controllers with DSUB9 connector, the GEV223 cable has to be used.
3.	Turn on the CS field controller.
4.	Plug the GEV234 cable into the USB port of the PC. The Found New Hardware Wizard starts up automatically.
5.	Check Yes, this time only. Next> .

Step	Description
6.	Check Install the software automatically (Recommended). Next> . The software for Remote NDIS based LGS CS Device will be installed on your PC.
7.	Finish.
8.	The Found New Hardware Wizard starts up automatically a second time.
9.	Check Yes, this time only. Next> .
10.	Check Install the software automatically (Recommended). Next> . The software for LGS CS USB Device will be installed on your PC.
11.	Finish.
	For PCs with Windows XP operating system:
12.	Run the ActiveSync installation program if not already installed.
13.	Allow USB connections inside the Connection Settings window of Active-Sync.
	For PCs with Windows Vista or Windows 7 operating system:
14.	Windows Mobile Device Center starts up automatically. If does not start automatically, start Windows Mobile Device Center.

Connect to PC via USB cable step-by-step





Step	Description
1.	Start the PC.
2.	Plug the GEV234 cable into CS field controller.  For CS field controllers with DSUB9 connector, the GEV223 cable has to be used.
3.	Turn the CS field controller on.
4.	Plug the GEV234 cable into the USB port of the PC.
	For PCs with Windows XP operating system:  ActiveSync starts up automatically. If does not start automatically, start ActiveSync. If not already installed, run the ActiveSync installation program.

Step	Description
5.	Allow USB connections inside the Connection Settings window of Active-Sync.
6.	Click Explore in ActiveSync.  The folders on the CS field controller are displayed under Mobile Devices . The folders of the data storage device can be found in StorageCard .
	For PCs with Windows Vista or Windows 7 operating system:  Windows Mobile Device Center starts up automatically. If does not start automatically, start Windows Mobile Device Center.



3.2

Power Functions



Turning CS field controller on

Press and hold power key () for 2 s.
 CS field controller must have a power supply.



Turning CS field controller off

Press and hold power key () for 5 s.
 CS field controller must be on.

Putting CS field controller into stand-by

Press and hold power key () < 2 s.
 CS field controller must be on.

Power Options menu

Press and hold power key () for 2 s to open **Power Options** menu.
 CS field controller must be on.

Option	Description
Turn off	Turn CS field controller off.
Stand-by	Put CS field controller into stand-by mode.  In stand-by mode, CS field controller shuts down and reduces power consumption. Rebooting from stand-by mode is quicker than a cold start after turning off.

Option	Description
Lock keyboard	Lock the keyboard. Option turns to Unlock keyboard .
Turn off touch screen	Disable touch screen. Option turns to Turn on touch screen .
Reset...	Perform one of the following options: <ul style="list-style-type: none"><li data-bbox="744 377 1166 405">• Restart (restarts Windows CE)<li data-bbox="744 412 1336 474">• Reset Windows CE (resets Windows CE and communication settings to factory defaults)<li data-bbox="744 481 1355 543">• Reset installed software (resets settings of all installed software)<li data-bbox="744 551 1365 644">• Reset Windows CE and installed software (resets Windows CE and settings of all installed software)

3.3

3.3.1

Batteries

Operating Principles

Charging / first-time use

- The battery must be charged prior to using it for the first time because it is delivered with an energy content as low as possible.
 - The permissible temperature range for charging is between 0°C to +40°C/ +32°F to +104°F. For optimal charging, we recommend charging the batteries at a low ambient temperature of +10°C to +20°C/+50°F to +68°F if possible.
 - It is normal for the battery to become warm during charging. Using the chargers recommended by Leica Geosystems, it is not possible to charge the battery if the temperature is too high.
 - For new batteries or batteries that have been stored for a long time (> three months), it is effectual to make only one charge/discharge cycle.
 - For Li-Ion batteries, a single discharging and charging cycle is sufficient. We recommend carrying out the process when the battery capacity indicated on the charger or on a Leica Geosystems product deviates significantly from the actual battery capacity available.
-

Operation / Discharging

- The batteries can be operated from -20°C to +55°C/-4°F to +131°F.
 - Low operating temperatures reduce the capacity that can be drawn; high operating temperatures reduce the service life of the battery.
-

3.3.2 Changing the Battery

Insert and remove the battery on the CS field controller step-by-step

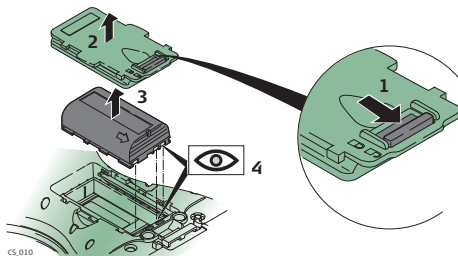

Step	Description
	Turn CS field controller over to gain access to the battery compartment.
1.	Push the slide fastener in the direction of the arrow with the open-lock symbol.
2.	Open the battery compartment.
3.	Pull the battery from the battery compartment.
4.	Place the battery into the battery compartment with the Leica logo facing to the top.

Step	Description
5.	Close the battery compartment by pushing the slide fastener in the direction of the arrow with the close-lock symbol.

Insert and remove the battery on the GS08/GS12 step-by-step

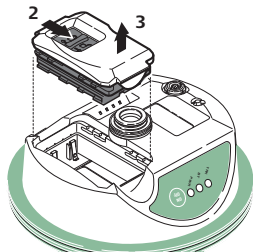

GS 121

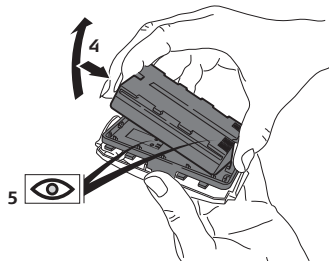

Step	Description
1.	Turn GS08/GS12 over to gain access to the battery compartment.
2.	Open the battery compartment by pushing the slide fastener in the direction of the arrow with the open-lock symbol.
3.	Pull out the battery housing. The battery is attached to the housing.

Step	Description
4.	Hold the battery housing and pull the battery from the battery housing.
5.	A polarity of the battery is displayed inside the battery housing. This is a visual aid to assist in placing the battery correctly.
6.	Place the battery onto the battery housing, ensuring that the contacts are facing outward. Click the battery into position.
7.	Close the battery compartment by pushing the slide fastener in the direction of the arrow with the close-lock symbol.

3.3.3

Charging the Battery

Charge battery step-by-step

A



B

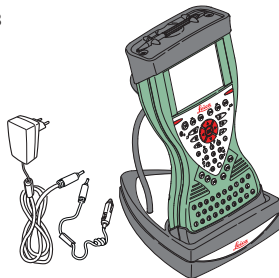

CS.024

Step	Description
1.	Connect the GEV235 power adapter or GDC221 car adapter with the CS field controller (A) or the docking station (B) and an A/C plug.
2.	The power LED on the CS field controller switches on. When CS field controller's battery is fully charged the LED switches off again.  Refer to "LED indicators" for information about the power LED.



The following advice is only valid for battery charger, power adapter and car adapter.

**Warning**

If you open the product, either of the following actions may cause you to receive an electric shock.

- Touching live components
- Using the product after incorrect attempts were made to carry out repairs

Precautions:

Do not open the product. Only Leica Geosystems authorised service workshops are entitled to repair these products.



The following advice is only valid for batteries, power adapter or docking station.

**Caution**

The product is not designed for use under wet and severe conditions. If unit becomes wet it may cause you to receive an electric shock.

Precautions:

Use the product only in dry environments, for example in buildings or vehicles. Protect the product against humidity. If the product becomes humid, it must not be used!



3.4

Working with the Memory Device





- Keep the card dry.
- Use it only within the specified temperature range.
- Do not bend the card.
- Protect the card from direct impacts.

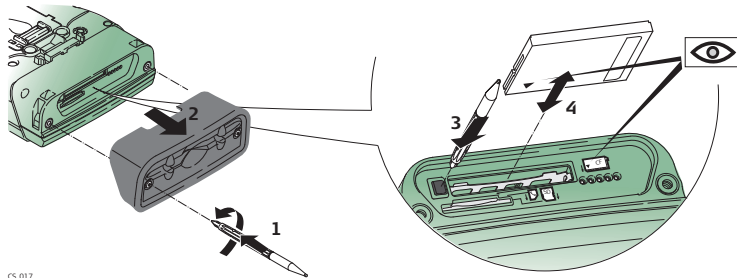

Failure to follow these instructions could result in data loss and/or permanent damage to the card.

Insert and remove a CompactFlash card step-by-step



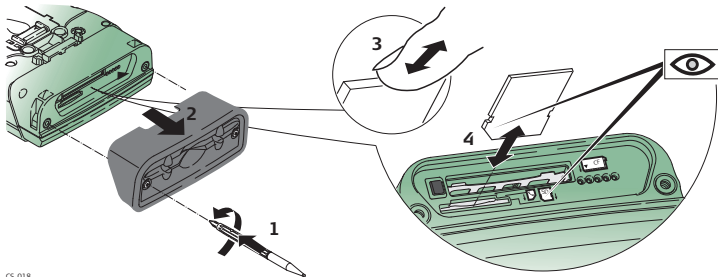

Step	Description
	The CompactFlash card is inserted into a slot inside the top of the CS10/CS15.
1.	Refer to "Fixing the slot cover to the CS step-by-step". Loosen the screws inside the slot cover on top of the CS10/CS15 using the screwdriver end of the stylus.
2.	Detach the slot cover from the CS10/CS15.
3.	Slide the card firmly into the slot until it clicks into position.  Do not force the card into the slot.
4.	The card must be held with the contacts facing the slot.
5.	Attach the slot cover and tighten the screws.
6.	To remove the card, detach the slot cover of the CS10/CS15.
7.	Press the eject button next to the card slot twice.
8.	Remove the CompactFlash card and attach the slot cover.

Insert and remove an SD card step-by-step



CS.018

Step	Description
	The SD card is inserted into a slot inside the top of the CS10/CS15.
1.	Refer to "Fixing the slot cover to the CS step-by-step". Loosen the screws inside the slot cover on top of the CS10/CS15 using the screwdriver end of the stylus.
2.	Detach the slot cover from the CS10/CS15.
3.	Slide the card firmly into the slot until it clicks into position.  Do not force the card into the slot.
4.	The card must be held with the contacts facing the slot.

Step	Description
5.	Attach the slot cover and tighten the screws.
6.	To remove the card, detach the slot cover of the CS10/CS15.
7.	Gently press the top of the card to release it from the slot.
8.	Remove the SD card and attach the slot cover.

3.5

LED Indicators on CS10/CS15

LED indicators

Description

The CS field controller has **L**ight **E**mitting **D**iode indicators. They indicate the basic field controller status.

Diagram

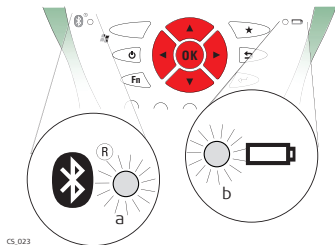

- a) Bluetooth LED
- b) Power LED

Description of the LEDs

IF the	is	THEN
Bluetooth LED	green	Bluetooth is in data mode and ready for connecting.
	purple	Bluetooth is connecting.
	blue	Bluetooth has connected.
	flashing blue	data is being transferred
Power LED	off	power is off.
	green	power is okay.
	flashing green	power is okay. The battery is being charged.
	yellow	power is low. The remaining time for which enough power is available depends on the use of wireless modules, the temperature and the age of the battery.
	flashing yellow	power is low. The remaining time for which enough power is available depends on the use of wireless modules, the temperature and the age of the battery. The battery is being charged.
	red	power is very low. The battery should be changed.

IF the	is	THEN
	flashing red	power is very low. The battery is being charged.

3.6

LED Indicators on GS08/GS12

LED indicators

Description

The GS08/GS12 instrument has **L**ight **E**mitting **D**iode indicators. They indicate the basic instrument status.

Diagram

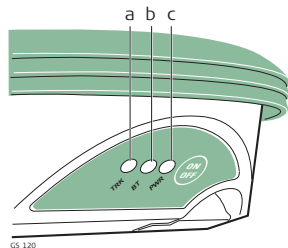

- a) Tracking LED (TRK)
- b) BT - Bluetooth LED (BT)
- c) Power LED (PWR)

Description of the LEDs

IF the	is	THEN
TRK LED	off	No satellites are tracked.
	flashing green	Less than four satellites are tracked, a position is not yet available.
	green	Enough satellites are tracked to compute a position.
	red	GS08/GS12 instrument is initialising.
BT LED	green	Bluetooth is in data mode and ready for connecting.
	purple	Bluetooth is connecting.
	blue	Bluetooth has connected.
	flashing blue	Data is being transferred.
PWR LED	off	Power is off.
	green	Power is okay.
	flashing green	Power is low. The remaining time for which enough power is available depends on the type of survey, the temperature and the age of the battery.

3.7 Using the Digital Camera

Overview

Both CS field controllers are equipped with a digital camera located at the underside (refer to "1.4 CS Components"). If a hand strap or pole holder plate is mounted, the camera view is not limited. The camera application can be started from the desktop icon **Camera** or from the Start menu **Start - Programs - Camera**.

Taking a picture step-by-step

Step	Description
1.	Aim the camera to the desired target.
2.	Check the view at the display.
3.	Press OK or click Capture to take the picture.  Capture changes to Save .
4.	Press OK again or click Save to open the Save As dialog.
5.	Click Discard to reject the picture.

Storing a picture step-by-step

Step	Description
	The Save As dialog is Windows CE standard and allows to name the picture, choose the location or to create a folder.
1.	Browse to the desired folder or create a new one.
2.	Name the picture.
3.	Press OK to save it and return to the camera view.
4.	Press Cancel to reject the picture and to return to the camera view without saving the picture.

4 Care and Transport

4.1 Transport

Transport in a road vehicle Never carry the product loose in a road vehicle, as it can be affected by shock and vibration. Always carry the product in its transport container and secure it.

Shipping When transporting the product by rail, air or sea, always use the complete original Leica Geosystems packaging, transport container and cardboard box, or its equivalent, to protect against shock and vibration.

Shipping, transport of batteries When transporting or shipping batteries, the person in charge of the product must ensure that the applicable national and international rules and regulations are observed. Before transportation or shipping, contact your local passenger or freight transport company.

4.2

Storage

Product

Respect the temperature limits when storing the equipment, particularly in summer if the equipment is inside a vehicle. Refer to "6 Technical Data" for information about temperature limits.

Li-Ion batteries

- Refer to "6 Technical Data" for information about storage temperature range.
 - At the recommended storage temperature range, batteries containing a 10% to 50% charge can be stored for up to one year. After this storage period the batteries must be recharged.
 - Remove batteries from the product and the charger before storing.
 - After storage recharge batteries before using.
 - Protect batteries from damp and wetness. Wet or damp batteries must be dried before storing or use.
 - A storage temperature range of -20°C to +30°C/-4°F to 86°F in a dry environment is recommended to minimise self-discharging of the battery.
-

4.3 Cleaning and Drying

Product and accessories

- Use only a clean, soft, lint-free cloth for cleaning. If necessary, moisten the cloth with water or pure alcohol. Do not use other liquids; these may attack the polymer components.

Damp products

Dry the product, the transport container, the foam inserts and the accessories at a temperature not greater than 40°C/104°F and clean them. Do not repack until everything is dry. Always close the transport container when using in the field.

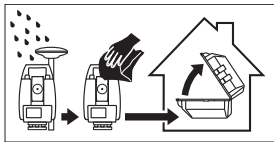
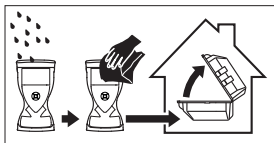

Cables and plugs

Keep plugs clean and dry. Blow away any dirt lodged in the plugs of the connecting cables.

Connectors with dust caps

Wet connectors must be dry before attaching the dust cap.

5 Safety Directions

5.1 General Introduction

Description

The following directions enable the person responsible for the product, and the person who actually uses the equipment, to anticipate and avoid operational hazards.

The person responsible for the product must ensure that all users understand these directions and adhere to them.

5.2

Intended Use

Permitted use

- Remote control of product.
 - Data communication with external appliances.
-

Adverse use

- Use of the product without instruction.
- Use outside of the intended limits.
- Disabling safety systems.
- Removal of hazard notices.
- Opening the product using tools, for example screwdriver, unless this is permitted for certain functions.
- Modification or conversion of the product.
- Use after misappropriation.
- Use of products with recognisable damages or defects.
- Use with accessories from other manufacturers without the prior explicit approval of Leica Geosystems.
- Inadequate safeguards at the working site, for example when measuring on roads.
- Controlling of machines, moving objects or similar monitoring application without additional control- and safety installations.



Warning

Adverse use can lead to injury, malfunction and damage.

It is the task of the person responsible for the equipment to inform the user about hazards and how to counteract them. The product is not to be operated until the user has been instructed on how to work with it.

5.3

Limits of Use

Environment

Suitable for use in an atmosphere appropriate for permanent human habitation: not suitable for use in aggressive or explosive environments.



Danger

Local safety authorities and safety experts must be contacted before working in hazardous areas, or close to electrical installations or similar situations by the person in charge of the product.



The following advice is only valid for battery charger, power adapter and car adapter.

Environment

Suitable for use in dry environments only and not under adverse conditions.



5.4

Responsibilities

Manufacturer of the product

Leica Geosystems AG, CH-9435 Heerbrugg, hereinafter referred to as Leica Geosystems, is responsible for supplying the product, including the user manual and original accessories, in a safe condition.

Manufacturers of non Leica Geosystems accessories

The manufacturers of non Leica Geosystems accessories for the product are responsible for developing, implementing and communicating safety concepts for their products, and are also responsible for the effectiveness of those safety concepts in combination with the Leica Geosystems product.

Person in charge of the product

The person in charge of the product has the following duties:

- To understand the safety instructions on the product and the instructions in the user manual.
 - To be familiar with local regulations relating to safety and accident prevention.
 - To inform Leica Geosystems immediately if the product and the application becomes unsafe.
 - To ensure that the national laws, regulations and conditions for the operation of radio transmitters are respected.
-

**Warning**

The person responsible for the product must ensure that it is used in accordance with the instructions. This person is also accountable for the training and the deployment of personnel who use the product and for the safety of the equipment in use.

5.5

Hazards of Use

**Warning**

The absence of instruction, or the inadequate imparting of instruction, can lead to incorrect or adverse use, and can cause accidents with far-reaching human, material, financial and environmental consequences.

Precautions:

All users must follow the safety directions given by the manufacturer and the directions of the person responsible for the product.

**Danger**

Because of the risk of electrocution, it is dangerous to use poles and extensions in the vicinity of electrical installations such as power cables or electrical railways.

Precautions:

Keep at a safe distance from electrical installations. If it is essential to work in this environment, first contact the safety authorities responsible for the electrical installations and follow their instructions.





Warning

During dynamic applications, for example stakeout procedures there is a danger of accidents occurring if the user does not pay attention to the environmental conditions around, for example obstacles, excavations or traffic.

Precautions:

The person responsible for the product must make all users fully aware of the existing dangers.



Warning

Inadequate securing of the working site can lead to dangerous situations, for example in traffic, on building sites, and at industrial installations.

Precautions:

Always ensure that the working site is adequately secured. Adhere to the regulations governing safety and accident prevention and road traffic.



Warning

If computers intended for use indoors are used in the field there is a danger of electric shock.

Precautions:

Adhere to the instructions given by the computer manufacturer regarding field use with Leica Geosystems products.



Caution

If the accessories used with the product are not properly secured and the product is subjected to mechanical shock, for example blows or falling, the product may be damaged or people can sustain injury.

Precautions:

When setting-up the product, make sure that the accessories are correctly adapted, fitted, secured, and locked in position.

Avoid subjecting the product to mechanical stress.

**Warning**

If the product is used with accessories, for example masts, staffs, poles, you may increase the risk of being struck by lightning.

Precautions:

Do not use the product in a thunderstorm.

**Warning**

Using a battery charger not recommended by Leica Geosystems can destroy the batteries. This can cause fire or explosions.

Precautions:

Only use chargers recommended by Leica Geosystems to charge the batteries.

**Caution**

During the transport, shipping or disposal of batteries it is possible for inappropriate mechanical influences to constitute a fire hazard.

Precautions:

Before shipping the product or disposing of it, discharge the batteries by running the product until they are flat.

When transporting or shipping batteries, the person in charge of the product must ensure that the applicable national and international rules and regulations are

observed. Before transportation or shipping contact your local passenger or freight transport company.

 **Warning**

High mechanical stress, high ambient temperatures or immersion into fluids can cause leakage, fire or explosions of the batteries.

Precautions:

Protect the batteries from mechanical influences and high ambient temperatures. Do not drop or immerse batteries into fluids.

 **Warning**

If battery terminals come in contact with jewellery, keys, metallised paper or other metals, short circuited battery terminals can overheat and cause injury or fire, for example by storing or transporting in pockets.

Precautions:

Make sure that the battery terminals do not come into contact with metallic objects.



The following advice is only valid for battery charger, power adapter and car adapter.

 **Warning**

If you open the product, either of the following actions may cause you to receive an electric shock.

- Touching live components
- Using the product after incorrect attempts were made to carry out repairs

Precautions:

Do not open the product. Only Leica Geosystems authorised service workshops are entitled to repair these products.



The following advice is only valid for batteries, power adapter or docking station.

**Caution**

The product is not designed for use under wet and severe conditions. If unit becomes wet it may cause you to receive an electric shock.

Precautions:

Use the product only in dry environments, for example in buildings or vehicles. Protect the product against humidity. If the product becomes humid, it must not be used!

**Warning**

If the product is improperly disposed of, the following can happen:

- If polymer parts are burnt, poisonous gases are produced which may impair health.
- If batteries are damaged or are heated strongly, they can explode and cause poisoning, burning, corrosion or environmental contamination.
- By disposing of the product irresponsibly you may enable unauthorised persons to use it in contravention of the regulations, exposing themselves and third

parties to the risk of severe injury and rendering the environment liable to contamination.

Precautions:

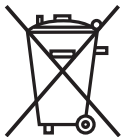

The product must not be disposed with household waste.
Dispose of the product appropriately in accordance with the national regulations in force in your country.
Always prevent access to the product by unauthorised personnel.

Product-specific treatment and waste management information can be downloaded from the Leica Geosystems home page at <http://www.leica-geosystems.com/treatment> or received from your Leica Geosystems dealer.



Warning

Only Leica Geosystems authorised service workshops are entitled to repair these products.

5.6 Electromagnetic Compatibility EMC

Description

The term Electromagnetic Compatibility is taken to mean the capability of the product to function smoothly in an environment where electromagnetic radiation and electrostatic discharges are present, and without causing electromagnetic disturbances to other equipment.



Warning

Electromagnetic radiation can cause disturbances in other equipment.

Although the product meets the strict regulations and standards which are in force in this respect, Leica Geosystems cannot completely exclude the possibility that other equipment may be disturbed.

The product is a class A product when operated with the internal batteries. In a domestic environment this product may cause radio interference in which case the user may be required to take adequate measures.



Caution

There is a risk that disturbances may be caused in other equipment if the product is used with accessories from other manufacturers, for example field computers, personal computers, two-way radios, non-standard cables or external batteries.

Precautions:

Use only the equipment and accessories recommended by Leica Geosystems. When combined with the product, they meet the strict requirements stipulated by the

guidelines and standards. When using computers and two-way radios, pay attention to the information about electromagnetic compatibility provided by the manufacturer.

 **Caution**

Disturbances caused by electromagnetic radiation can result in erroneous measurements.

Although the product meets the strict regulations and standards which are in force in this respect, Leica Geosystems cannot completely exclude the possibility that the product may be disturbed by intense electromagnetic radiation, for example, near radio transmitters, two-way radios or diesel generators.

Precautions:

Check the plausibility of results obtained under these conditions.

 **Warning**

If the product is operated with connecting cables attached at only one of their two ends, for example external supply cables, interface cables, the permitted level of electromagnetic radiation may be exceeded and the correct functioning of other products may be impaired.

Precautions:

While the product is in use, connecting cables, for example product to external battery, product to computer, must be connected at both ends.

Radios or digital cellular phones**Warning**

Use of product with radio or digital cellular phone devices:

Electromagnetic fields can cause disturbances in other equipment, in installations, in medical devices, for example pacemakers or hearing aids and in aircraft. It can also affect humans and animals.

Precautions:

Although the product meets the strict regulations and standards which are in force in this respect, Leica Geosystems cannot completely exclude the possibility that other equipment can be disturbed or that humans or animals can be affected.

- Do not operate the product with radio or digital cellular phone devices in the vicinity of filling stations or chemical installations, or in other areas where an explosion hazard exists.
 - Do not operate the product with radio or digital cellular phone devices near to medical equipment.
 - Do not operate the product with radio or digital cellular phone devices in aircraft.
-

5.7

FCC Statement, Applicable in U.S.



Warning

The greyed paragraph below is only applicable for products without radio.

This equipment has been tested and found to comply with the limits for a Class B digital device, pursuant to part 15 of the FCC rules.

These limits are designed to provide reasonable protection against harmful interference in a residential installation.

This equipment generates, uses and can radiate radio frequency energy and, if not installed and used in accordance with the instructions, may cause harmful interference to radio communications. However, there is no guarantee that interference will not occur in a particular installation.

If this equipment does cause harmful interference to radio or television reception, which can be determined by turning the equipment off and on, the user is encouraged to try to correct the interference by one or more of the following measures:

- Reorient or relocate the receiving antenna.
 - Increase the separation between the equipment and the receiver.
 - Connect the equipment into an outlet on a circuit different from that to which the receiver is connected.
 - Consult the dealer or an experienced radio/TV technician for help.
-

 **Warning**

Changes or modifications not expressly approved by Leica Geosystems for compliance could void the user's authority to operate the equipment.

Labelling CS10

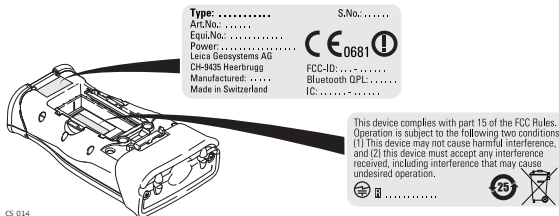

CS_014

Labelling CS15

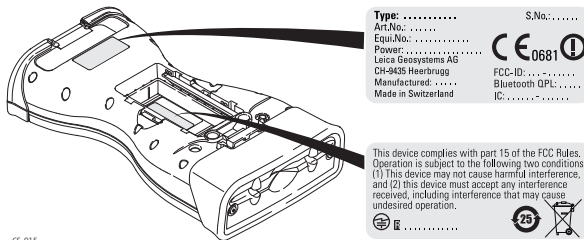

CS_015

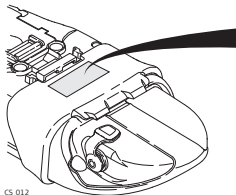

Labelling GS05, GS06



CS_012

Type: Art.No.:
Equip.No.: S.No.:

Leica Geosystems AG
CH-9435 Heerbrugg
Manufactured:
Made in Canada



Labelling GS08, GS12

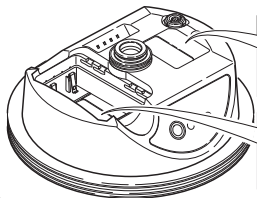

GS_123

This device complies with part 15 of the FCC Rules. Operation is subject to the following two conditions: (1) This device may not cause harmful interference, and (2) this device must accept any interference received, including interference that may cause undesired operation.

Type: GS..... Art.No.:.....
Equip.No.: XXXXXX S.No.:.....
Power: 12V^{nom}, nominal 1/0.5A max.

Leica Geosystems AG
CH-9435 Heerbrugg
Manufactured: 2004
Made in Switzerland S.No.:.....



**Labelling internal
battery GEB211,
GEB212**



GEB_001

This device complies with part 15 of the FCC Rules. Operation is subject to the following two conditions: (1) This device may not cause harmful interference, and (2) this device must accept any interference received, including interference that may cause undesired operation.

UL US LISTED
ITE Accessory
E179078 . 70YL

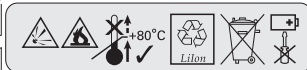

Exposure to radio frequency (RF) signals

The wireless device is a radio transmitter and receiver. It is designed and manufactured not to exceed the emission limit for exposure to radio frequency (RF) energy set by the OET Bulletin 65 Supplement C / Ministry of Health (Canada), Safety Code 6. These limits are part of comprehensive guidelines and established permitted levels of RF energy for the general population. These guidelines are based on the safety standards previously set by international standard bodies. These standards include a substantial safety margin designed to assure the safety of all persons, regardless of age and health.

This device and its antenna must not be co-located or operating in conjunction with any other antenna or transmitter.

This device has been shown to be capable of compliance for localised specific absorption rate (SAR) for uncontrolled environment / general public exposure limits specific in ANSI/IEEE C95.1-1992 and had been tested in accordance with the measurement procedures specified in IEEE Std. 1528-2003.

SAR compliance for body-worn operating configurations is limited to specific belt-clips, holsters or similar accessory configurations that have no metallic component in the assembly providing at least 1.0 cm separation distance between the device and the body of the user.

6 Technical Data

6.1 CS10/CS15 Technical Data

Design Glass reinforced polymer housing with optional integrated battery and radio modem.

Control unit

CS10

Display: VGA (480 x 640 pixels), graphics capable LCD, illumination, touch screen, colour

Keyboard: 26 keys, illumination

Touch screen: Toughened film on glass

Sound: Integrated sealed speaker and microphone

Digital camera: Resolution: 1600 x 1200 pixels, fixed focus lens, image capture: JPEG

CS15

Display: VGA (640 x 480 pixels), graphics capable LCD, illumination, touch screen, colour

Keyboard: 65 keys including 12 function keys, illumination

Touch screen: Toughened film on glass

Sound: Integrated sealed speaker and microphone

Digital camera: Resolution: 1600 x 1200 pixels, fixed focus lens, image capture: JPEG

Dimensions

Type	Length [m]	Width [m]	Thickness [m]
CS10	0.200	0.102	0.045
CS15	0.245	0.125	0.045

Weight

Type	Weight [kg]/[lbs]
CS10, with battery, internal radio and WLAN	0.720/1.587
CS15, with battery, internal radio and WLAN	0.870/1.918

Recording

Data can be recorded on the SD card, CompactFlash card, USB stick or in the internal memory.

Power

Type	Consumption [W]	External supply voltage
CS10/CS15	2.0	Nominal voltage 12 V DC (---) Voltage range 10.5 V-28 V

Internal battery

Type	Battery	Voltage	Capacity	Operating time, typical*
CS10/CS15	Li-Ion	7.4 V	GEB212: 2.6 Ah	10 h

* Operating time depends on use of wireless communication devices.

Environmental specifications**Temperature**

Type	Operating temperature [°C]	Storage temperature [°C]
CS10/CS15	-30 to +60	-40 to +80
Internal battery	-20 to +55	-40 to +70

Protection against water, dust and sand

Type	Protection
CS10/CS15	IP67 (IEC60529) Dust tight Waterproof to 1 m temporary immersion

Humidity

Type	Protection
CS10/CS15	Up to 100 % The effects of condensation are to be effectively counteracted by periodically drying out CS10/CS15.

Interfaces

Type	RS232	USB Host	USB OTG	Bluetooth	WLAN
CS10/CS15	LEMO port or DSUB9	LEMO port or USB A	LEMO port, USB Mini-AB or docking station contacts	Class 2	802.11b/g

Data format for RS232

The default values are:

Baud rate:	115200
Parity:	None
Terminator:	CR/LF
Data bits:	8
Stop bits:	1

Ports

Type	8 pin LEMO-1	DSUB9	USB A Host	USB Mini	Docking station contacts
CS10/CS15	For power and/or communication	For communication			For power and/or communication

6.2

GS05/GS06 Technical Data

6.2.1

Tracking Characteristics

Instrument technology

SmartTrack+

Satellite reception

Single frequency

Instrument channels

GS05/GS06: Up to 14 channels continuous tracking on L1 (GPS); up to 14 channels continuous tracking on L1 (GLONASS); one channel tracking SBAS.



Depending on the satellite systems and signals configured, a maximum number of 14 channels is allocated.

Supported codes and phases**GPS**

Type	L1
GS05/GS06	Carrier phase, C/A-code

GLONASS

Type	L1
GS05/GS06	Carrier phase, C/A-code



Carrier phase and code measurements on L1 (GPS) are fully independent with AS on or off.

Satellites tracked

GS05/GS06: Up to 14 simultaneously on L1 (GPS) + up to 14 simultaneously on L1 (GLONASS) + up to one SBAS

6.2.2



Accuracy

Accuracy is dependent upon various factors including the number of satellites tracked, constellation geometry, observation time, ephemeris accuracy, ionospheric disturbance, multipath and resolved ambiguities.

The following accuracies, given as **root mean square**, are based on measurements processed using LGO and on real-time measurements.

The use of multiple GNSS systems can increase accuracy by up to 30% relative to GPS only.

Differential code

The baseline precision of a differential code solution for static and kinematic surveys is 40 cm.

Differential phase in post-processing

Static	Kinematic
10 mm + 2 ppm	20 mm + 2 ppm

6.2.3

Technical Data

Description and use

The table gives a description and the intended use of the GS05/GS06.

Type	Description	Use
GS05	L1 GPS, GLONASS SmartTrack+ antenna.	With CS10 field controller.
GS06	L1 GPS, GLONASS SmartTrack+ antenna.	With CS15 field controller.

Dimensions

Type	Length [m]	Width [m]	Thickness [m]
GS05 with CS10	0.278	0.102	0.045
GS06 with CS15	0.323	0.125	0.045

Connector

5 pin interface port

Weight

Type	Weight [kg]/[lbs]
GS05 with CS10	0.750/1.653
GS06 with CS15	0.910/2.006

Power

Power consumption:	0.5 W typically, 45 mA
External supply voltage:	Nominal 12 V DC (---), voltage range 5 V-28 V DC

Electrical data

Type	GS05/GS06
Voltage	-
Current	-
Frequency	GPS L1 1575.42 MHz GLONASS L1 1602.5625 MHz-1611.5 MHz
Gain	Typically 27 dBi
Noise Figure	Typically < 2 dBi

Environmental specifications**Temperature**

Operating temperature [°C]	Storage temperature [°C]
-30 to +60	-40 to +80

Protection against water, dust and sand

Protection
IP67 (IEC 60529) Dust tight Protected against water jets Waterproof to 1 m temporary immersion

Humidity

Protection
Up to 100 % The effects of condensation are to be effectively counteracted by periodically drying out the antenna.

6.3

GS08/GS12 Technical Data

6.3.1

Tracking Characteristics

Instrument technology

SmartTrack+

Satellite reception

GS08: Dual frequency.
GS12: Triple frequency.

Instrument channels

GS08: Up to 14 channels continuous tracking on L1, L2 (GPS); up to 12 channels continuous tracking on L1 and L2 (GLONASS); two channels tracking SBAS (EGNOS, WAAS, MSAS, GAGAN).
GS12: Up to 16 channels continuous tracking on L1, L2 and L5 (GPS); up to 14 channels continuous tracking on L1 and L2 (GLONASS); up to 14 channels continuous tracking on E1, E5a, E5b and Alt-BOC (Galileo); four channels tracking SBAS (EGNOS, WAAS, MSAS, GAGAN).



Depending on the satellite systems and signals configured, a maximum number of 72 (GS08) or 120 (GS12) channels is allocated.

**Supported codes
and phases****GPS**

Type	L1	L2	L5
GS08	Carrier phase, C/A-code	Carrier phase, C code (L2C) and P2-code	-
GS12	Carrier phase, C/A-code	Carrier phase, C code (L2C) and P2-code	Carrier phase, code

GLONASS

Type	L1	L2
GS08	Carrier phase, C/A-code	Carrier phase, P2-code
GS12	Carrier phase, C/A-code	Carrier phase, P2-code

Galileo

Type	E1	E5a	E5b	Alt-BOC
GS12	Carrier phase, code	Carrier phase, code	Carrier phase, code	Carrier phase, code



Carrier phase and code measurements on L1, L2 and L5 (GPS) are fully independent with AS on or off.

Satellites tracked	GS08:	Up to 14 simultaneously on L1, L2 (GPS) + up to twelve simultaneously on L1 and L2 (GLONASS)+ up to two SBAS (EGNOS, WAAS, MSAS, GAGAN)
	GS12:	Up to 16 simultaneously on L1, L2 and L5 (GPS) + up to 14 simultaneously on L1 and L2 (GLONASS) + up to 14 simultaneously on E1, E5a, E5b and Alt-BOC (Galileo) + up to four SBAS (EGNOS, WAAS, MSAS, GAGAN)

6.3.2

Accuracy



Accuracy is dependent upon various factors including the number of satellites tracked, constellation geometry, observation time, ephemeris accuracy, ionospheric disturbance, multipath and resolved ambiguities.

The following accuracies, given as **root mean square**, are based on measurements processed using LGO and on real-time measurements.

The use of multiple GNSS systems can increase accuracy by up to 30% relative to GPS only.

Differential code

The baseline precision of a differential code solution for static and kinematic surveys is 25 cm.

**Differential phase
in post-processing**

Static and rapid static

Static		Kinematic	
Horizontal	Vertical	Horizontal	Vertical
5 mm + 0.5 ppm	10 mm + 0.5 ppm	10 mm + 1 ppm	20 mm + 1 ppm

Static with long observations

Static		Kinematic	
Horizontal	Vertical	Horizontal	Vertical
3 mm + 0.5 ppm	6 mm + 0.5 ppm	10 mm + 1 ppm	20 mm + 1 ppm

**Differential phase
in real-time**

Static		Kinematic	
Horizontal	Vertical	Horizontal	Vertical
5 mm + 0.5 ppm	10 mm + 0.5 ppm	10 mm + 1 ppm	20 mm + 1 ppm

6.3.3 Technical Data

Description and use

The table gives a description and the intended use of the GS08/GS12.

Type	Description	Use
GS08	L1, L2 GPS, GLONASS SmartTrack+ antenna.	With CS10 field controller.
GS12	L1, L2, L5 GPS, GLONASS, Galileo SmartTrack+ antenna.	With CS10 or CS15 field controller.

Dimensions

Height: 0.089 m
Diameter: 0.186 m

Connector

- 8 pin LEMO-1
- 5 pin SmartStation clip-on-contacts (GS12 only)

Mounting

5/8" Whitworth

Weight

1.1 kg including internal battery

Power

Power consumption: 1.8 W typically
External supply voltage: Nominal 12 V DC (≡≡≡), voltage range 10.5 V-28 V

Battery internal

Type:	Li-Ion
Voltage:	7.4 V
Capacity:	GEB211: 2.2 Ah GEB212: 2.6 Ah
Typical operating time:	7 h

The given operating times are valid for

- one fully charged GEB212 battery.
- 25°C. Operating times will be shorter when working in cold weather.

Electrical data

Type	GS08	GS12
Frequency		
GPS L1 1575.42 MHz	✓	✓
GPS L2 1227.60 MHz	✓	✓
GPS L5 1176.45 MHz	-	✓
GLONASS L1 1602.5625-1611.5 MHz	✓	✓
GLONASS L2 1246.4375-1254.3 MHz	✓	✓
Galileo E1 1575.42 MHz	-	✓
Galileo E5a 1176.45 MHz	-	✓

Type	GS08	GS12
Galileo E5b 1207.14 MHz	-	✓
Galileo Alt-BOC 1191.795 MHz	-	✓
Gain	Typically 27 dBi	Typically 27 dBi
Noise Figure	Typically < 2 dBi	Typically < 2 dBi

Environmental specifications

Temperature

Operating temperature [°C]	Storage temperature [°C]
-40 to +65	-40 to +80
Bluetooth: -30 to +65	

Protection against water, dust and sand

Protection
IP67 (IEC 60529)
Dusttight
Protected against water jets
Waterproof to 1 m temporary immersion

Humidity

Protection
Up to 100 % The effects of condensation are to be effectively counteracted by periodically drying out the antenna.

6.4 Antennas Technical Data

Description and use

The table gives a description and the intended use of the antenna.

Type	Description	Use
AS05	L1 GPS, GLONASS SmartTrack+ antenna with built-in ground plane.	With CS10/GS05, CS15/GS06.

Dimensions

Type	AS05
Height	6.2 cm
Diameter	17.0 cm

Connector

AS05: TNC female

Mounting

AS05: 5/8" Whitworth

Weight

AS05: 0.4 kg

Electrical data

Type	AS05
Voltage	4.5 V to 18 V DC
Current	35 mA typical
Frequency	GPS L1 1575.42 MHz GLONASS L1 1602.5625 MHz-1611.5 MHz
Gain (typically)	27 dBi
Noise Figure (typically)	< 2 dBi

Environmental specifications**Temperature**

Type	Operating temperature [°C]	Storage temperature [°C]
AS05	-40 to +70	-55 to +85

Protection against water, dust and sand

Type	Protection
AS05	IP67 (IEC 60529) Dust tight Protected against water jets

Type	Protection
	Waterproof to 1 m temporary immersion

Humidity

Type	Protection
AS05	Up to 100 % The effects of condensation are to be effectively counteracted by periodically drying out the antenna.

Cable length

Separation distance from instrument ...	to antenna	Supplied cable lengths [m]
GS05/GS06	AS05	1.2

6.5

Conformity to National Regulations

Conformity to national regulations

For products which do not fall under R&TTE directive:



Hereby, Leica Geosystems AG, declares that the product/s is/are in compliance with the essential requirements and other relevant provisions of Directive 1999/5/EC. The declaration of conformity can be consulted at <http://www.leica-geosystems.com/ce>.

6.5.1

CS10

Conformity to national regulations

- FCC Part 15 (applicable in US)
- Hereby, Leica Geosystems AG, declares that the product CS10 is in compliance with the essential requirements and other relevant provisions of Directive 1999/5/EC. The declaration of conformity can be consulted at <http://www.leica-geosystems.com/ce>.



Class 2 equipment according European Directive 1999/5/EC (R&TTE) for which following EEA Member States apply restrictions on the placing on the market or on the putting into service or require authorisation for use:

- France
- Italy
- Norway (if used in the geographical area within a radius of 20km from the centre of Ny-Ålesund)
- The conformity for countries with other national regulations not covered by the FCC part 15 or European directive 1999/5/EC has to be approved prior to use and operation.

Frequency band

Type	Frequency band [MHz]
CS10, Bluetooth	2402 - 2480
CS10, RCS	2402 - 2452
CS10, 3.5G GSM/UMTS	UMTS/HSDPA (WCDMA/FDD) 850 / 1900 / 2100 Quad-Band EGSM 850 / 900 / 1800 / 1900 GPRS multi-slot class 12 EDGE multi-slot class 12
CS10, WLAN	2400 - 2484

Output power

Type	Output power [mW]
CS10, Bluetooth	2.5
CS10, RCS	< 100
CS10, 3.5G GSM/UMTS EGSM850/900	2
CS10, 3.5G GSM/UMTS GSM1800/1900	1
CS10, 3.5G GSM/UMTS UMTS2100	0.25
CS10, 3.5G GSM/UMTS EDGE850/900	0.5
CS10, 3.5G GSM/UMTS EDGE1800/1900	0.4
CS10, WLAN (802.11b)	50
CS10, WLAN (802.11g) 6 Mbit/s-36 Mbit/s	50
CS10, WLAN (802.11b) 48 Mbit/s-56 Mbit/s	31.6

Antenna

Type	Antenna	Gain [dBi]	Connector	Frequency band [MHz]
CS10, Bluetooth	Integrated antenna	-	-	-

Type	Antenna	Gain [dBi]	Connector	Frequency band [MHz]
CS10, RCS	Integrated antenna	-	-	-
CS10, 3.5G GSM/UMTS	Integrated antenna	-	-	-
CS10, WLAN	Integrated antenna	-	-	-
GS05	Internal GNSS antenna element (receive only)	-	-	-

6.5.2

CS15

Conformity to national regulations

- FCC Part 15 (applicable in US)
- Hereby, Leica Geosystems AG, declares that the product CS15 is in compliance with the essential requirements and other relevant provisions of Directive 1999/5/EC. The declaration of conformity can be consulted at <http://www.leica-geosystems.com/ce>.



Class 2 equipment according European Directive 1999/5/EC (R&TTE) for which following EEA Member States apply restrictions on the placing on the market or on the putting into service or require authorisation for use:

- France
 - Italy
 - Norway (if used in the geographical area within a radius of 20km from the centre of Ny-Ålesund)
- The conformity for countries with other national regulations not covered by the FCC part 15 or European directive 1999/5/EC has to be approved prior to use and operation.

Frequency band

Type	Frequency band [MHz]
CS15, Bluetooth	2402 - 2480
CS15, RCS	2402 - 2452

Type	Frequency band [MHz]
CS15, 3.5G GSM/UMTS	UMTS/HSDPA (WCDMA/FDD) 850 / 1900 / 2100 Quad-Band EGSM 850 / 900 / 1800 / 1900 GPRS multi-slot class 12 EDGE multi-slot class 12
CS15, WLAN	2400 - 2484

Output power

Type	Output power [mW]
CS15, Bluetooth	2.5
CS15, RCS	< 100
CS15, 3.5G GSM/UMTS EGSM850/900	2
CS15, 3.5G GSM/UMTS GSM1800/1900	1
CS15, 3.5G GSM/UMTS UMTS2100	0.25
CS15, 3.5G GSM/UMTS EDGE850/900	0.5
CS15, 3.5G GSM/UMTS EDGE1800/1900	0.4
CS15, WLAN (802.11b)	50
CS15, WLAN (802.11g) 6 Mbit/s-36 Mbit/s	50

Type	Output power [mW]
CS15, WLAN (802.11b) 48 Mbit/s-56 Mbit/s	31.6

Antenna

Type	Antenna	Gain [dBi]	Connector	Frequency band [MHz]
CS15, Bluetooth	Integrated antenna	-	-	-
CS15, RCS	Integrated antenna	-	-	-
CS15, 3.5G GSM/UMTS	Integrated antenna	-	-	-
CS15, WLAN	Integrated antenna	-	-	-
GS06	Internal GNSS antenna element (receive only)	-	-	-

6.5.3

GS08

Conformity to national regulations

- FCC Part 15, 22 and 24 (applicable in US)
- Hereby, Leica Geosystems AG, declares that the product GS08 is in compliance with the essential requirements and other relevant provisions of Directive 1999/5/EC. The declaration of conformity can be consulted at <http://www.leica-geosystems.com/ce>.



Class 1 equipment according European Directive 1999/5/EC (R&TTE) can be placed on the market and be put into service without restrictions in any EEA member state.

- The conformity for countries with other national regulations not covered by the FCC part 15, 22 and 24 or European directive 1999/5/EC has to be approved prior to use and operation.

Frequency band

Type	Frequency band [MHz]
GS08	1227.60 1575.42 1246.4375 - 1254.3 1602.4375 - 1611.5
Bluetooth	2402 - 2480

Output power

Type	Output power [mW]
GNSS	Receive only
Bluetooth	5

Antenna

GNSS	Internal GNSS antenna element (receive only)
Bluetooth	Type: Internal Microstrip antenna Gain: 1.5 dBi

6.5.4

GS12

Conformity to national regulations

- FCC Part 15, 22 and 24 (applicable in US)
- Hereby, Leica Geosystems AG, declares that the product GS12 is in compliance with the essential requirements and other relevant provisions of Directive 1999/5/EC. The declaration of conformity can be consulted at <http://www.leica-geosystems.com/ce>.



Class 1 equipment according European Directive 1999/5/EC (R&TTE) can be placed on the market and be put into service without restrictions in any EEA member state.

- The conformity for countries with other national regulations not covered by the FCC part 15, 22 and 24 or European directive 1999/5/EC has to be approved prior to use and operation.

Frequency band

Type	Frequency band [MHz]
GS12	1176.45 1191.795 1207.14 1227.60 1246.4375 - 1254.3 1575.42 1602.4375 - 1611.5

Type	Frequency band [MHz]
Bluetooth	2402 - 2480

Output power

Type	Output power [mW]
GNSS	Receive only
Bluetooth	5

Antenna

GNSS	Internal GNSS antenna element (receive only)
Bluetooth	Type: Internal Microstrip antenna Gain: 1.5 dBi

7 International Limited Warranty, Software Licence Agreement

International Limited Warranty

This product is subject to the terms and conditions set out in the International Limited Warranty which you can download from the Leica Geosystems home page at <http://www.leica-geosystems.com/internationalwarranty> or collect from your Leica Geosystems distributor. The foregoing warranty is exclusive and is in lieu of all other warranties, terms or conditions, expressed or implied, either in fact or by operation of law, statutory or otherwise, including warranties, terms or conditions of merchantability, fitness for a particular purpose, satisfactory quality and non-infringement, all which are expressly disclaimed.

Software Licence Agreement

This product contains software that is preinstalled on the product, or that is supplied to you on a data carrier medium, or that can be downloaded by you online according to prior authorisation from Leica Geosystems. Such software is protected by copyright and other laws and its use is defined and regulated by the Leica Geosystems Software Licence Agreement, which covers aspects such as, but not limited to, Scope of the Licence, Warranty, Intellectual Property Rights, Limitation of Liability, Exclusion of other Assurances, Governing Law and Place of Jurisdiction. Please make sure, that at any time you fully comply with the terms and conditions of the Leica Geosystems Software Licence Agreement.

Such agreement is provided together with all products and can also be referred to and downloaded at the Leica Geosystems home page at <http://www.leica-geosystems.com/swlicense> or collected from your Leica Geosystems distributor.

You must not install or use the software unless you have read and accepted the terms and conditions of the Leica Geosystems Software Licence Agreement. Installation or use of the software or any part thereof, is deemed to be an acceptance of all the terms and conditions of such Licence Agreement. If you do not agree to all or some of the terms of such Licence Agreement, you must not download, install or use the software and you must return the unused software together with its accompanying documentation and the purchase receipt to the distributor from whom you purchased the product within ten (10) days of purchase to obtain a full refund of the purchase price.

Appendix A Pin Assignments and Sockets

A.1 CS10/CS15

Description

Some applications require knowledge of the pin assignments for the CS10/CS15 ports.

In this chapter, the pin assignments and sockets for the ports of the CS10/CS15 are explained.

Ports at the instrument bottom panel - DSUB9 connector

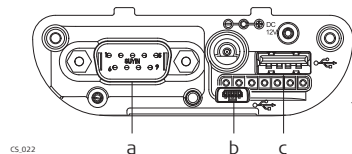

CS.022

- a) DSUB9 port
- b) USB Mini port
- c) USB A Host port

Ports at the instrument bottom panel - Lemo connector

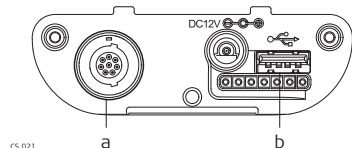

CS.021

- a) Lemo port (USB and serial)
- b) USB A Host port

Pin assignments for RS232 serial port



PIN_002

Pin	Signal Name	Function	Direction
1	NC	Not connected	-
2	RxD	RS232, receive data	In
3	TxD	RS232, transmit data	Out
4	NC	Not connected	-
5	GND	Signal Ground	-
6	NC	Not connected	-
7	RTS	RS232, request to send	Out
8	CTS	RS232, clear to send	In
9	NC	Not connected	-

Pin assignments for 8 pin LEMO-1

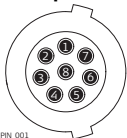

PIN_001

Pin	Signal Name	Function	Direction
1	USB_D+	USB data line	In or out
2	USB_D-	USB data line	In or out
3	GND	Signal ground	-
4	RxD	RS232, receive data	In

Pin	Signal Name	Function	Direction
5	TxD	RS232, transmit data	Out
6	ID	Identification pin	In or out
7	PWR	Power input, 10.5 V-28 V	In
8	TRM_ON/USB_ID	RS232, general purpose signal	In or out

Sockets

9 pin RS232:

RS232, 9 pin, DE9

8 pin LEMO-1:

LEMO-1, 8 pin, LEMO EGI.1B.308.CLN

A.2

GS08/GS12

Description

Some applications require knowledge of the pin assignments for the GS08/GS12 ports. In this chapter, the pin assignments and sockets for the ports of the GS08/GS12 are explained.

Ports at the instrument underside

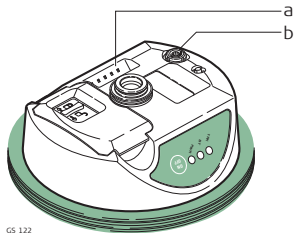

GS_122

- a) Clip on contacts (only GS12)
 - b) Lemo port (USB and serial)
-

**Pin assignments
for 8 pin LEMO-1**

PIN_001

Pin	Signal Name	Function	Direction
1	USB_D+	USB data line	In or out
2	USB_D-	USB data line	In or out
3	GND	Signal ground	-
4	RxD	RS232, receive data	In
5	TxD	RS232, transmit data	Out
6	ID	Identification pin	In or out
7	PWR	Power input, 10.5 V-28 V	In
8	TRM_ON/USB_ID	RS232, general purpose signal	In or out

Sockets

8 pin LEMO-1:

LEMO-1, 8 pin, LEMO EGI.1B.308.CLN

Index

A

ActiveSync	43
Antennas	112
GS08	123
GS12	125
Operating Temperature	113
Storing Temperature	113
Type	112

B

Batteries	
Charge in CS10/CS15	55
Charging, first-time use	51
Operation, Discharging	51
Battery	
Change in CS10/CS15	52
Charge in CS10/CS15	55
Internal, GS08	109
Internal, GS12	109
Storage temperature	94
Bluetooth	
LED on CS10	61

LED on CS15	61
LED on GS08	64
LED on GS12	64

C

CompactFlash card	
Insert	57
Memory device	19
Remove	57
Connector	
GS05	100
GS06	100
GS08	108
GS12	108
Connector, antennas	112

CS

Available models	12
Display foil	33
Docking Station	25, 42
Firmware for all CS models	14
Lock keyboard	50
Operating principles	32

Power Options menu	49	GS12	108
Stand-by mode	49	SmartAntenna	100
System components	11	Display foil	33
Unlock keyboard	50	Docking Station	
CS10		Components	25
Operating temperature	94	Mounting	42
Status	61	Documentation	4
Storage temperature	94	Drive	
Underside	22	PC card, on office computer	20
Upside	21		
CS15		E	
Operating temperature	94	Electrical data	
Status	61	GS08	109
Storage temperature	94	GS12	109
Underside	24	Electrical Data	
Upside	23	GS05	101
D		GS06	101
Data transfer	20	Electrical data, antennas	113
Description of the system	11	Environmental specifications	
Digital Camera	66	Antenna	113
Dimensions		GS05	102
Antennas	112	GS06	102
GS08	108	GS08	110
		GS12	110

F		H	
FCC Statement	87	Hand strap	35
Frequency band		Handheld GNSS	40
GS08	122	I	
GS12	124	Indicators, LED	
G		CS10	61
GEB211 (internal battery)		CS15	61
Operating temperature	94	GS08	64
GEB212 (internal battery)		GS12	64
Operating temperature	94	Insert	
GS		CompactFlash card	57
Firmware for GS05/GS06	14	SD card	59
Firmware for GS08/GS12	14	SIM card	38
GS05		Intended Use	73
Operating Temperature	102	Internal memory	
Storage Temperature	102	Memory device	19
GS06		International Limited Warranty	126
Operating Temperature	102	K	
Storage Temperature	102	Key combinations	
GS08		Description of	31
Status	64	Keyboard	
GS12		CS10 Graphical overview	26
Status	64	CS15 Graphical overview	27

Operating principles	32	L	
Keyboard illumination		Labelling	
Turn off	31	CS10	88
Turn on	31	CS15	88
Keys		GEB211	90
Alpha keys	28	GEB212	90
Arrow keys	30	GS05	89
Backspace key	28	GS06	89
Caps Lock	28	GS08	89
Description of	28	GS12	89
ENTER key	29	LED	
ESC key	28	CS10, description	62
Favourites	29	CS15, description	62
Fn key	28	GS08, description	65
Function keys	28	GS12, description	65
Home	29	Light Emitting Diode	
Hot keys	28	CS10	61
Numeric keys	28	CS15	61
OK	30	GS08	64
ON/OFF	29	GS12	64
SPACE key	28	Li-Ion battery	109
		Storage	69

M		Pin Assignment	128
Memory device		Power	
Available	19	GS05	101
Microsoft ActiveSync	43	GS06	101
Mount, antennas	112	GS08	108
Mount, GS08	108	GS12	108
Mount, GS12	108	Power LED	
O		CS10	61
Operating Temperature		CS15	61
Antennas	113	GS08	64
CS10	94	GS12	64
CS15	94	Power supply	18
GEB211 (internal battery)	94	R	
GEB212 (internal battery)	94	Radio Modem	
GS05	102	Available radios	13
GS06	102	Recording	93
GS08	110	Remove	
GS12	110	CompactFlash card	57
Output power		SD card	59
GS08	123	SIM card	38
GS12	125	Reset	
P		Options	50
PC card drive on office computer	20	Responsibilities	76

S

Safety Directions	72
Satellite reception	103
Screen brightness	
Decrease	31
Increase	31
SD card	
Insert	59
Memory device	19
Remove	59
SIM card	
Insert	38
Remove	38
Slot Cover	37
Socket	128
Software	
Upload	15
Software Licence Agreement	126
Specifications, environmental	
Antennas	113
GS05	102
GS06	102
Status, CS10	61
Status, CS15	61

Status, GS08	64
Status, GS12	64
Storage Temperature	
CS10	94
CS15	94
For internal battery GEB211	94
For internal battery GEB212	94
GS05	102
GS06	102
GS08	110
GS12	110
Storing Temperature	
Antennas	113

T

Technical Data	
CS10	92
CS15	92
Dimensions	93
Display and keyboard	92
Environmental specifications	94
GS05	97
GS06	97
GS08	103

GS12	103	User Manual	
Interface	95	Validity of	4
Internal battery GEB211	94	V	
Internal battery GEB212	94	Volume	
Ports	96	Decrease	31
Power supply	93	Increase	31
Weight	93	W	
Temperature range		Weight	
Product, drying	70	Antennas	112
Temperature, charging internal battery	51	GS05	101
Touch screen		GS06	101
Turn off	50	GS08	108
Turn on	50	GS12	108
Touch Screen, operating principles	32	Windows CE	
Tracking LED		Reset registry	50
GS08	64	Restart	50
GS12	64	Windows Mobile Device Center	43
Transfer data	20	WLAN	12
U			
Upload software	15		
USB stick			
Memory device	19		
User Interface	26		

Total Quality Management: Our commitment to total customer satisfaction.



Leica Geosystems AG, Heerbrugg, Switzerland, has been certified as being equipped with a quality system which meets the International Standards of Quality Management and Quality Systems (ISO standard 9001) and Environmental Management Systems (ISO standard 14001).

Ask your local Leica Geosystems dealer for more information about our TQM program.

Leica Geosystems AG

Heinrich-Wild-Strasse
CH-9435 Heerbrugg
Switzerland
Phone +41 71 727 31 31

www.leica-geosystems.com

- when it has to be **right**

Leica
Geosystems

772386-3.0.0en

Original text
Printed in Switzerland
© 2010 Leica Geosystems AG, Heerbrugg, Switzerland