

TEST REPORT

Test Report Reference: R70284_A Edition 1

**Equipment under Test: 802.11b/g Wireless LAN module
cB-OWLAN211gi-02 / cB-OWLAN211gx-02**

FCC ID: PVH090901

IC: 5325A-090901

Applicant: connectBlue AB

Manufacturer: connectBlue AB

**Test Laboratory
(CAB)
accredited by
DATech GmbH
in compliance with DIN EN ISO/IEC 17025
under the
Reg. No. DAT-P-105/99-21,
FCC Test site registration number 90877
and
Industry Canada Test site registration IC3469**

TEST REPORT REFERENCE: R70284_A Edition 1

Contents:	Page
1 IDENTIFICATION	4
1.1 APPLICANT	4
1.2 MANUFACTURER	4
1.3 DATES	4
1.4 TEST LABORATORY	5
1.5 RESERVATION	5
1.6 NORMATIVE REFERENCES	5
1.7 TEST RESULTS	5
2 TECHNICAL DATA OF EQUIPMENT	6
2.1 DEVICE UNDER TEST	6
2.2 PERIPHERY DEVICES	8
3 OPERATIONAL STATES AND PHYSICAL BOUNDARIES	8
4 APPLICATION OVERVIEW	9
5 TEST RESULTS	10
5.1 CONDUCTED EMISSIONS ON POWER SUPPLY LINES (150 kHz to 30 MHz)	10
5.1.1 METHOD OF MEASUREMENT	10
5.1.2 TEST RESULTS (CONDUCTED EMISSIONS ON POWER SUPPLY LINES)	11
5.2 6 dB BANDWIDTH	13
5.2.1 METHOD OF MEASUREMENT (6 dB BANDWIDTH)	13
5.2.2 TEST RESULTS (6 dB BANDWIDTH)	14
5.3 MAXIMUM PEAK OUTPUT POWER	18
5.3.1 METHOD OF MEASUREMENT (MAXIMUM PEAK OUTPUT POWER)	18
5.3.2 TEST RESULTS (MAXIMUM PEAK OUTPUT POWER)	19
5.4 POWER SPECTRAL DENSITY	20
5.4.1 METHOD OF MEASUREMENT (POWER SPECTRAL DENSITY)	20
5.4.2 TEST RESULTS (POWER SPECTRAL DENSITY)	21
5.5 BAND-EDGE COMPLIANCE	25
5.5.1 METHOD OF MEASUREMENT (BAND-EDGE COMPLIANCE)	25
5.5.2 TEST RESULT (BAND-EDGE COMPLIANCE (RADIATED)) b-mode	26
5.5.3 TEST RESULT (BAND-EDGE COMPLIANCE (RADIATED)) g-mode	28

[CONTINUED NEXT PAGE](#)

TEST REPORT REFERENCE: R70284_A Edition 1

Contents (continued):	Page
5.6 RADIATED EMISSIONS.....	30
5.6.1 METHOD OF MEASUREMENT (RADIATED EMISSIONS).....	30
5.6.2 TEST RESULTS (TRANSMITTER RADIATED EMISSIONS).....	36
5.6.2.1 PRELIMINARY MEASUREMENT INTERNAL ANTENNA (30 kHz to 1 GHz)	36
5.6.2.2 FINAL MEASUREMENT INTERNAL ANTENNA (9 kHz to 30 MHz).....	40
5.6.2.3 FINAL MEASUREMENT INTERNAL ANTENNA (30 MHz to 1 GHz)	41
5.6.2.4 PRELIMINARY MEASUREMENT INTERNAL ANTENNA (1 GHz to 25 GHz) b-mode	45
5.6.2.5 FINAL MEASUREMENT INTERNAL ANTENNA (1 GHz to 25 GHz) b mode	52
5.6.2.6 PRELIMINARY MEASUREMENT INTERNAL ANTENNA (1 GHz to 25 GHz) g-mode	55
5.6.2.7 FINAL MEASUREMENT INTERNAL ANTENNA (1 GHz to 25 GHz) g- mode.....	62
5.6.2.8 PRELIMINARY MEASUREMENT EXTERNAL PATCH ANTENNA (1 GHz to 25 GHz) b-mode	65
5.6.2.9 FINAL MEASUREMENT EXTERNAL PATCH ANTENNA (1 GHz to 25 GHz) b-mode	72
5.6.2.10 PRELIMINARY MEASUREMENT EXTERNAL PATCH ANTENNA (1 GHz to 25 GHz) g-mode	75
5.6.2.11 FINAL MEASUREMENT EXTERNAL PATCH ANTENNA (1 GHz to 25 GHz) g-mode	82
5.6.2.12 PRELIMINARY MEASUREMENT EXTERNAL MONOPOLE ANTENNA (1 GHz to 25 GHz), b-mode	85
5.6.2.13 FINAL MEASUREMENT EXTERNAL MONOPOLE ANTENNA (1 GHz to 25 GHz) b-mode	92
5.6.2.14 PRELIMINARY MEASUREMENT EXTERNAL MONOPOLE ANTENNA (1 GHz to 25 GHz), g-mode	95
5.6.2.15 FINAL MEASUREMENT EXTERNAL MONOPOLE ANTENNA (1 GHz to 25 GHz) g-mode	102
6 TEST EQUIPMENT AND ANCILLARIES USED FOR TESTS.....	105
7 LIST OF ANNEXES	109

TEST REPORT REFERENCE: R70284_A Edition 1

1 IDENTIFICATION

1.1 APPLICANT

Name:	connectBlue AB
Address:	Norra Vallgatan 64 3V
	Malmö SE-211 19
Country:	Sweden
Name for contact purposes:	Mr. Martin Engdahl
Tel:	+ 46 40 63 07 100
Fax:	+ 46 40 23 71 37
e-mail address:	martin.engdahl@connectblue.se

1.2 MANUFACTURER

Name:	connectBlue AB
Address:	Norra Vallgatan 64 3V
	Malmö SE-211 19
Country:	Sweden
Name for contact purposes:	Mr. Martin Engdahl
Tel:	+ 46 40 63 07 100
Fax:	+ 46 40 23 71 37
e-mail address:	martin.engdahl@connectblue.se

1.3 DATES

Date of receipt of test sample:	28 February 2007
Start of test:	11 April 2007
End of test:	11 Mai 2007

TEST REPORT REFERENCE: R70284_A Edition 1

1.4 TEST LABORATORY

The tests were carried out at: **PHOENIX TESTLAB GmbH**
Königswinkel 10
D-32825 Blomberg Phone: **+49 (0) 52 35 / 95 00-0**
Germany Fax: **+49 (0) 52 35 / 95 00-10**

accredited by DATech GmbH in compliance with DIN EN ISO/IEC 17025 under Reg. No. DAT-P-105/99-21, FCC Testside registration number 90877 and Industry Canada Test site registration IC3469

Test engineer: Dieter SÜTTHOFF

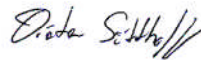

12 July 2007

Name

Signature

Date

Test report checked: Thomas KÜHN



12 July 2007

Name

Signature

Date

PHOENIX TESTLAB GmbH
Königswinkel 10
32825 Blomberg
Tel. 0 52 35 / 95 00-0
Fax 0 52 35 / 95 00-10

Stamp

1.5 RESERVATION

This test report is only valid in its original form.

Any reproduction of its contents without written permission of the accredited test laboratory PHOENIX TESTLAB GmbH is prohibited.

The test results herein refer only to the tested sample. PHOENIX TESTLAB GmbH is not responsible for any generalisations or conclusions drawn from these test results concerning further samples. Any modification of the tested samples is prohibited and leads to the invalidity of this test report. Each page necessarily contains the PHOENIX TESTLAB Logo and the TEST REPORT REFERENCE.

1.6 NORMATIVE REFERENCES

- [1] **ANSI C63.4:2003** American National Standard for Methods of Measuring of Radio-Noise Emissions from Low-Voltage Electrical and Electronic Equipment in the Range of 9 kHz to 40 GHz.
- [2] **FCC 47 CFR Part 15** Radio Frequency Devices (Subpart B)
- [3] **RSS-210 Issue 7 June 2006** Low power Licence-Exempt Radiocommunication Devices (All Frequency Bands): Category I Equipment
- [4] **RSS-Gen Issue 2 June 2006** General Requirements and Information for the Certification of Radiocommunication Equipment

1.7 TEST RESULTS

The requirements of this test document are fulfilled by the equipment under test. The complete test results are presented in the following.

TEST REPORT REFERENCE: R70284_A Edition 1

2 TECHNICAL DATA OF EQUIPMENT

2.1 DEVICE UNDER TEST

Type of equipment: *	802.11b and g Wireless LAN module
Type designation: *	cB-OWLAN211gi-02 / cB-OWLAN211gx-02
FCC ID: *	PVH090901
IC:	IC: 5325A-090901
Antenna type / gain: *	External or internal, refer table below
Antenna connector: *	With internal antenna, no antenna connector is mounted. Using external antennas, two UFL connectors were used.
Power supply: *	3.3 V DC to 5.5 V DC
Type of modulation: *	DSSS/OFDM (CCK / DQPSK, depends on data-rate and the 802.11-mode)
Operating frequency range:*	2.412 to 2.462 GHz (11 channels with 5 MHz channel separation)
Data rate:*	1 Mbps to 54 Mbps
Number of channels: *	11
Temperature range: *	-30 °C to +85 °C
Highest / lowest internal frequency: *	2.462 GHz / 32 kHz

*: declared by the applicant

TEST REPORT REFERENCE: R70284_A Edition 1

Used antennas:

Manufacturer, model name*	Antenna type	Antenna location	Antenna gain*	Cable length
Fractus, FR05-01-N-0-001	Patch	Internal	+1.1 dBi	-
Centurion, NanoBlue-IP04, MAF94045	Patch	External	+2.0 dBi	10 cm
Centurion, WCR-2400-IP04, MAF94017	Monopole	External	+2.0 dBi	10 cm
WiMo Antennen, Notebookantenna NB-2400	Patch	External	+2.0 dBi	60 cm
Mobile Mark, PSTG0-2400HS	Monopole	External	0.0 dBi	-
Mobile Mark, SDM2-2400/1575	Patch	External	+2.0 dBi	20 cm
Joymax, IHF-242	Monopole	External	+2.0 dBi	1.5 m
Joymax, IH-151	Monopole	External	+5.0 dBi	0 cm/ 50 cm
Joymax, IG-103	Monopole	External	+8.5 dBi	30 cm / 3 m
Huber + Suhner, SPA 2400/75/8/0/V	Patch	External	+7.5 dBi	50 cm / 3 m
Huber + Suhner, SOA 2400/360/6/20/V	Monopole	External	+6.0 dBi	30 cm / 3 m
Huber + Suhner, SOA 2400/360/4/20/V	Monopole	External	+4.0 dBi	0 cm / 30 cm / 1.5 m / 3 m
SEW EURODRIVE, 1 300 081 0	Patch	External	+5.9 dBi	10 cm
Joymax, IW- 145	Monopole	External	+4.0 dBi	25 cm

*: declared by the applicant

The following external I/O cables were used:

Cable	Length	Shielding	Connector
DC in (carrier board)	2 m *	No	6.3 mm jack plug
RS 232 (carrier board)	2 m *	Yes	9 pole D-Sub connector

*: Length during the test if no other specified.

TEST REPORT REFERENCE: R70284_A Edition 1

2.2 PERIPHERY DEVICES

The following equipment was used as control unit and ancillary equipment:

- The EUT was connected to a carrier board (cB-0903-03), which was delivered by the applicant. The carrier board was supplied via an external power supply with 5.0 V DC.
- A personal computer (ACER TravelMate 525TXV, model No. 1904) with a configuration-software was used, connected temporarily to the EUT via the RS 232 interface, for setting the equipment into the necessary operation mode.

3 OPERATIONAL STATES AND PHYSICAL BOUNDARIES

The EUT is intended to be used in several WLAN applications. Because the EUT is a module, which will be implemented in a final application, it was mounted on a carrier board to change the operation modes of the EUT from a Laptop with test software. Because no RS232 interface is implemented in the EUT, an additional UART-SPI bridge was used. The tests were carried out with one unmodified sample "cB-OWLAN211gi-02" with integral antenna and another unmodified sample "cB-OWLAN211gx-02" with an antenna connector and external antennas.

The EUT has two UFL connectors (one for transceiver antenna, one for receiver antenna). The connector type UFL is regarded to be unique.

During the tests the test sample was powered by an external power supply via the carrier board with 5.0 V DC. The emission measurement on AC mains was carried out by using a mascot power supply type 2121.

If not otherwise stated, for modulating the transmitter, a pseudo random bit sequence with a data rate of 11 Mbps (802.11 b-mode) or 6 Mbps (802.11 g-mode) was used because pre-tests have shown that these operation modes are causing the highest spurious emissions and occupying the largest bandwidth.

For selecting an operation mode, a personal computer with a software delivered by the applicant was connected to the EUT via a carrier board. To do this the test-engineer was instructed by the applicant.

For the emission measurement on AC mains a radio link to another cB-OWLAN211g was established. This device was connected to the PC with a produce and echo software, and transmits a signal to the EUT. The EUT looped back its input to its output (with the help of an echo-plug). After receiving the looped back signal it was compared with the transmitted signal with the help of the produce and echo software.

During the tests, the EUT was not labelled with a FCC-label.

The following operation modes were used during the tests:

Operation mode	Description of the operation mode
1	Continuous transmitting on 2412 MHz, b-mode, 11 Mbps
2	Continuous transmitting on 2437 MHz, b-mode, 11 Mbps
3	Continuous transmitting on 2462 MHz, b-mode, 11 Mbps
4	Continuous transmitting on 2412 MHz, g-mode, 6 Mbps
5	Continuous transmitting on 2437 MHz, g-mode, 6 Mbps
6	Continuous transmitting on 2462 MHz, g-mode, 6 Mbps
7	Produce and echo mode

TEST REPORT REFERENCE: R70284_A Edition 1

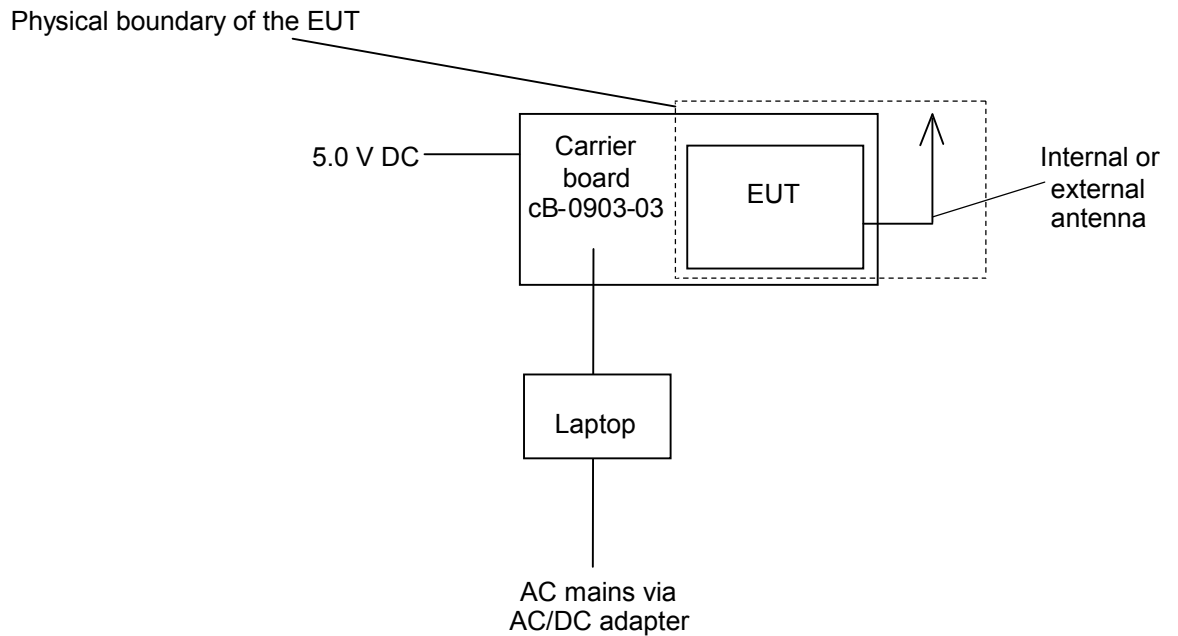

4 APPLICATION OVERVIEW

Application	Frequency range [MHz]	FCC 47 CFR Part 15 section	Status	Tested operation mode	Refer page
Conducted emissions on supply line	0.15 – 30	15.207 (a)	Passed	7	10 et seq.
6 dB bandwidth	General	15.247 (a) (2)	Passed	1 to 6	13 et seq.
Maximum peak output power	2400.0 – 2483.5	15.247 (b) (3), (4)	Passed	1 to 6	18 et seq.
Power spectral density	2400.0 – 2483.5	15.247 (e)	Passed	1 to 6	20 et seq.
Band edge compliance	2400.0 – 2483.5	15.247 (d)	Passed	1, 3, 4, 6	25 et seq.
Radiated emissions (transmitter)	30 – 25,000	15.205 (a) 15.209 (a)	Passed	1 to 6	30 et seq.

TEST REPORT REFERENCE: R70284_A Edition 1

5 TEST RESULTS

5.1 CONDUCTED EMISSIONS ON POWER SUPPLY LINES (150 kHz to 30 MHz)

5.1.1 METHOD OF MEASUREMENT

This test will be carried out in a shielded chamber. Tabletop devices will set up on a non-conducting support with a size of 1 m by 1.5 m and a height of 80 cm above the ground plane. Floor-standing devices will be placed directly on the ground plane. The set up of the Equipment under test will be in accordance to ANSI C63.4-2003 [1].

The frequency range 150 kHz to 30 MHz will be measured with an EMI Receiver set to MAX Hold mode with peak and average detector and a resolution bandwidth of 9 kHz. A scan will be carried out on the phase (or plus pole in case of DC powered devices) of the AC mains network. If levels detected 10 dB below the appropriate limit, this emission will be measured with the average and quasi-peak detector on all lines.

Frequency range	Resolution bandwidth
150 kHz to 30 MHz	9 kHz

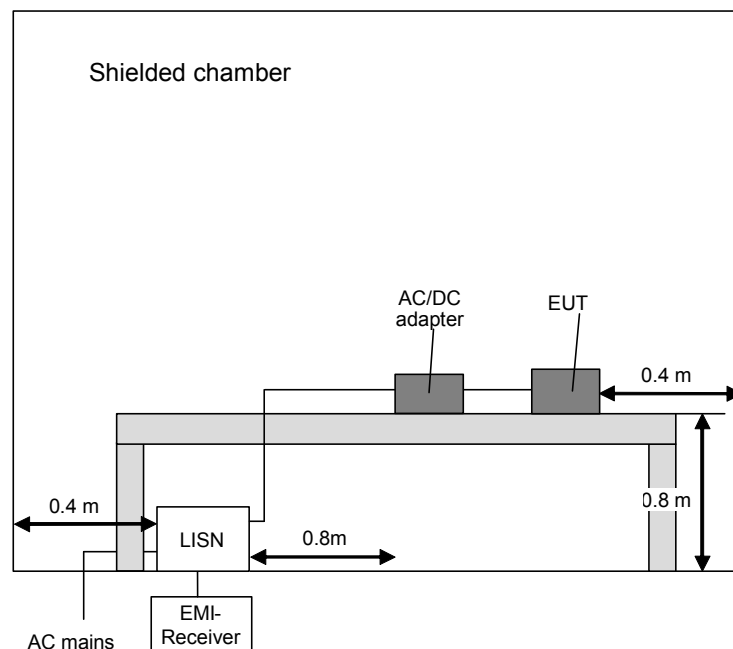

TEST REPORT REFERENCE: R70284_A Edition 1

5.1.2 TEST RESULTS (CONDUCTED EMISSIONS ON POWER SUPPLY LINES)

Ambient temperature	20 °C	Relative humidity	30 %
---------------------	-------	-------------------	------

Position of EUT: The EUT was set-up on a non-conducting table of a height of 0.8 m.

Cable guide: The cable of the EUT was fixed on the non-conducting table. For further information of the cable guide refer to the pictures in annex A of this test report.

Test record: All results are shown in the following.

Supply voltage: During all measurements the EUT was supplied with 5.0 V DC via the carrier board and the mascot AC/DC adaptor.

Measurement uncertainty: +3.6 dB / -4.5 dB

Title: AC Powerline Conducted Emission Test with protective ground conductor simulating network

EUT: OWLAN211g with mascot power supply type 2121

Manufacturer: connectBlue AB

Operating Condition: operation mode 7 (Produce and Echo Mode)

Test site: PHOENIX TESTLAB Blomberg M4

Operator: B. STEINER

Test Specification:

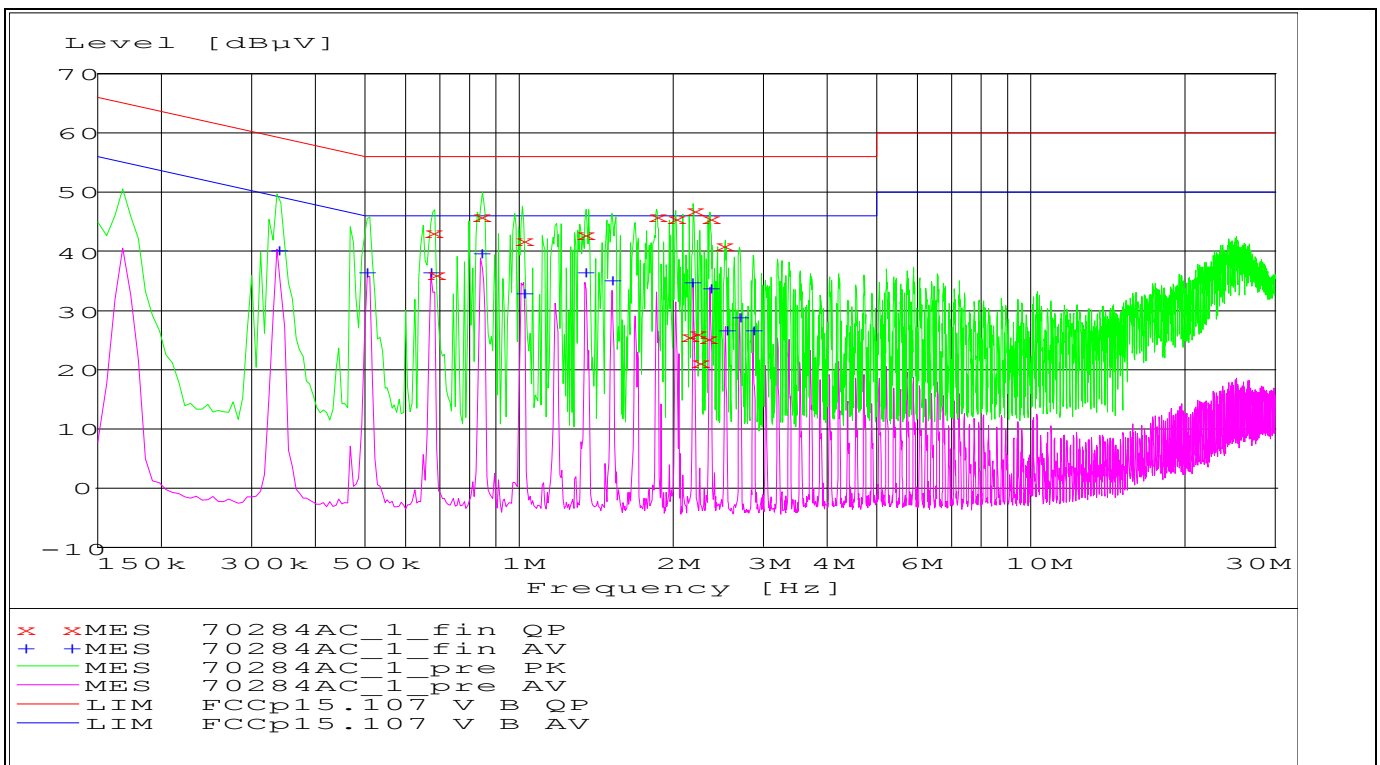

Data record name: 70284AC_1 of 12.04.2007

TEST REPORT REFERENCE: R70284_A Edition 1

**Result measured with the quasipeak detector:
(These values are marked in the above diagram by x)**

Frequency MHz	Level dB μ V	Transducer dB	Limit dB μ V	Margin dB	Line	PE
0.676050	43.40	0.8	56.0	12.6	L1	FLO
0.684240	36.10	0.8	56.0	19.9	L1	FLO
0.845160	46.20	0.7	56.0	9.8	L1	FLO
1.016790	41.90	0.7	56.0	14.1	L1	FLO
1.351860	42.90	0.6	56.0	13.1	L1	FLO
1.853520	46.20	0.7	56.0	9.8	L1	FLO
2.022450	45.80	0.8	56.0	10.2	L1	FLO
2.150610	26.10	0.8	56.0	29.9	L1	FLO
2.191650	46.80	0.8	56.0	9.2	L1	FLO
2.230620	26.30	0.8	56.0	29.7	L1	FLO
2.247360	21.20	0.7	56.0	34.8	N	FLO
2.336100	25.40	0.7	56.0	30.6	L1	FLO
2.359140	45.60	0.7	56.0	10.4	L1	FLO
2.523570	41.00	0.7	56.0	15.0	L1	FLO

Data record name: 70284AC_1_fin QP of 12.04.2007

**Result measured with the average detector:
(These values are marked in the above diagram by +)**

Frequency MHz	Level dB μ V	Transducer dB	Limit dB μ V	Margin dB	Line	PE
0.336930	40.40	0.9	49.3	8.9	L1	FLO
0.506130	36.50	0.8	46.0	9.5	L1	FLO
0.673980	36.80	0.8	46.0	9.2	L1	FLO
0.841920	40.00	0.7	46.0	6.0	L1	FLO
1.015530	33.00	0.7	46.0	13.0	N	FLO
1.347180	36.50	0.6	46.0	9.5	L1	FLO
1.515570	35.40	0.7	46.0	10.6	L1	FLO
2.189040	34.80	0.8	46.0	11.2	L1	FLO
2.357250	33.80	0.7	46.0	12.2	L1	FLO
2.524560	26.90	0.7	46.0	19.1	L1	FLO
2.694390	29.10	0.8	46.0	16.9	L1	FLO
2.862060	26.70	0.9	46.0	19.3	L1	FLO

Data record name: 70284AC_1_fin AV of 12.04.2007

Test: Passed

TEST EQUIPMENT USED FOR THE TEST:

1 – 3, 5, 6

TEST REPORT REFERENCE: R70284_A Edition 1

5.2 6 dB BANDWIDTH

5.2.1 METHOD OF MEASUREMENT (6 dB BANDWIDTH)

The calibration of the spectrum analyser has to be checked with the help of a known signal from a signal generator. The EUT has to be connected to the spectrum analyser via a low loss cable. If the EUT is not equipped with an antenna connector, a temporary antenna connector has to be installed. The EUT has to be switched on, the transmitter shall work with its maximum data rate.

The following spectrum analyser settings shall be used:

- Span: App. 2 to 3 times the 6 dB bandwidth, centred on the actual channel.
- Resolution bandwidth: 100 kHz.
- Video bandwidth: 100 kHz.
- Sweep: Auto.
- Detector function: peak.
- Trace mode: Max hold.

After trace stabilisation the marker shall be set on the signal peak. The first display line has to be set on this value. The second display line has to be set 6 dB below the first line (or the peak marker). The frequency lines shall be set on the intersection points between the second display line and the measured curve.

The measurement will be performed at the upper, the lower end and the middle of the assigned frequency band.

Test set-up:

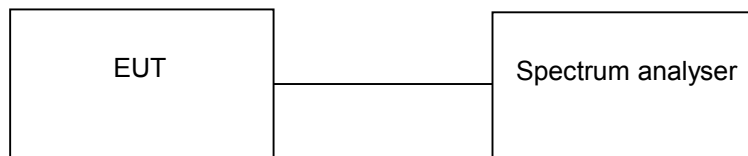

TEST REPORT REFERENCE: R70284_A Edition 1

5.2.2 TEST RESULTS (6 dB BANDWIDTH)

Ambient temperature	21 °C	Relative humidity	34 %
---------------------	-------	-------------------	------

70284_31.wmf: (6 dB bandwidth at the lower end of the assigned frequency band, operation mode 1):

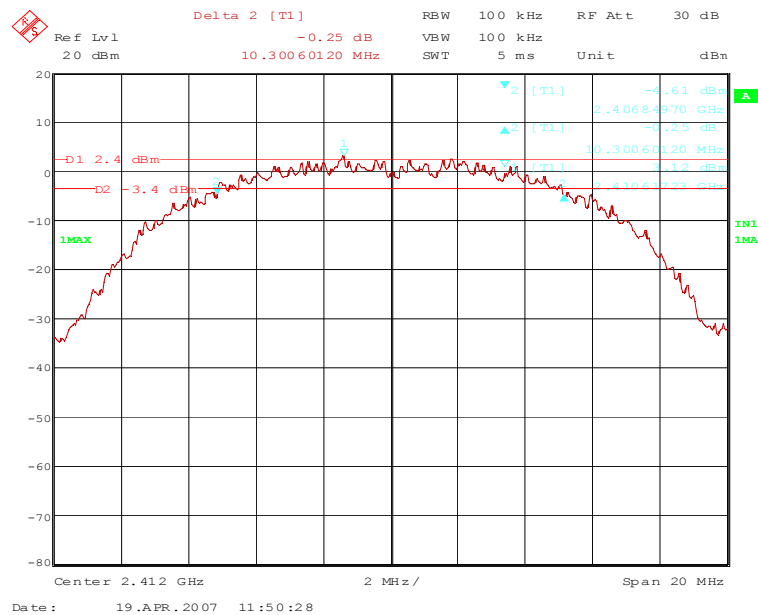

70284_33.wmf: (6 dB bandwidth at the middle of the assigned frequency band, operation mode 2):

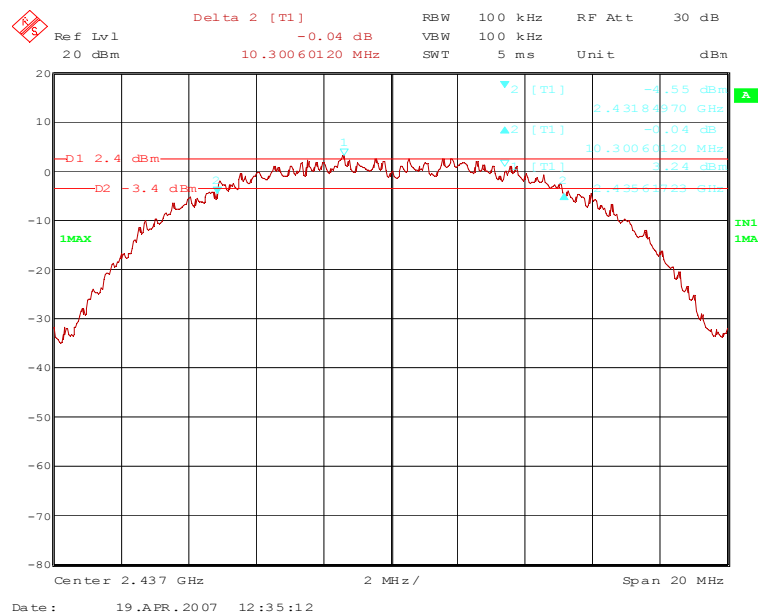

TEST REPORT REFERENCE: R70284_A Edition 1

70284_35.wmf: (6 dB bandwidth at the upper end of the assigned frequency band, operation mode 3):

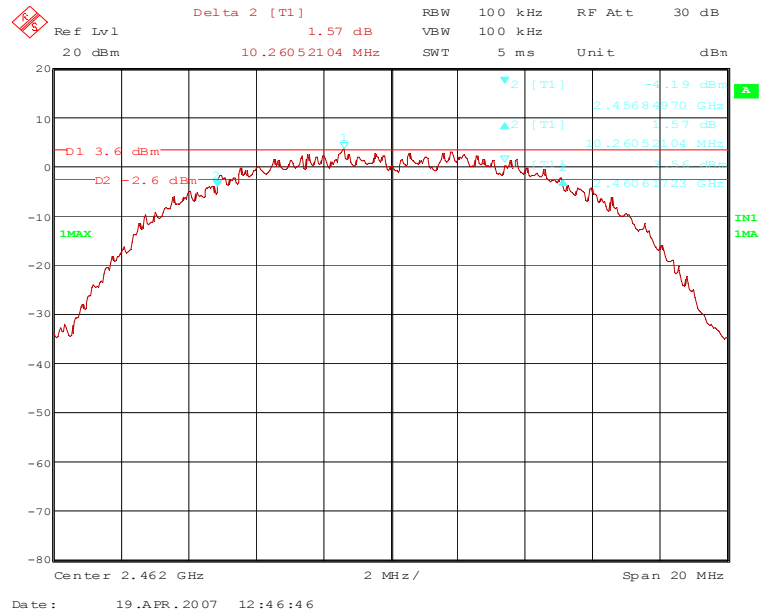

70284_32.wmf: (6 dB bandwidth at the lower end of the assigned frequency band, operation mode 4):

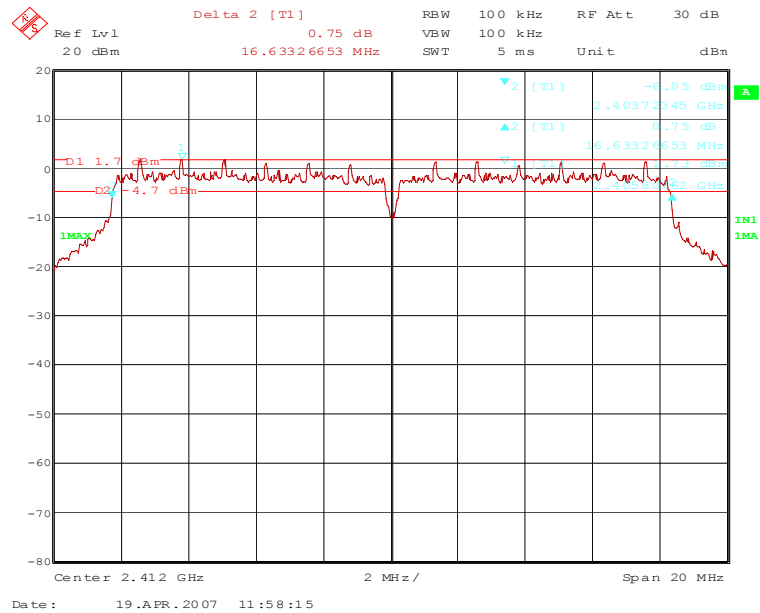

TEST REPORT REFERENCE: R70284_A Edition 1

70284_34.wmf: (6 dB bandwidth at the middle of the assigned frequency band, operation mode 5):

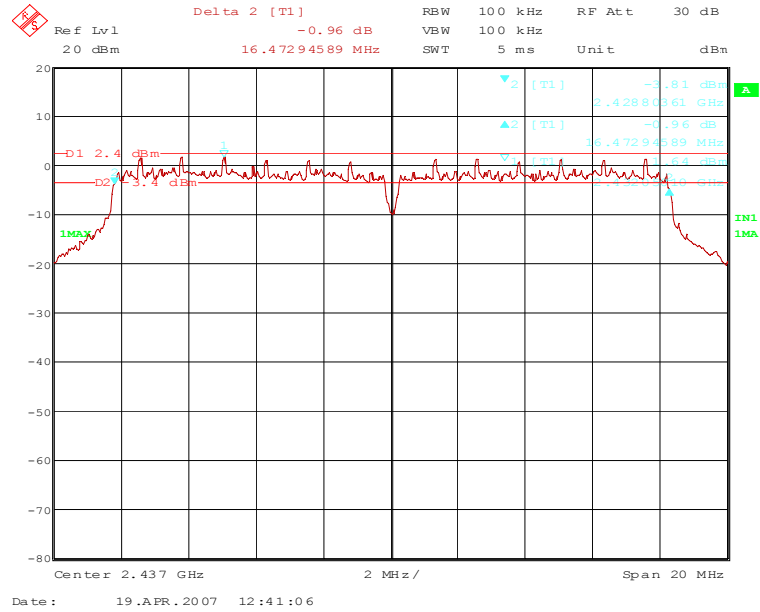

70284_36.wmf: (6 dB bandwidth at the upper end of the assigned frequency band, operation mode 6):

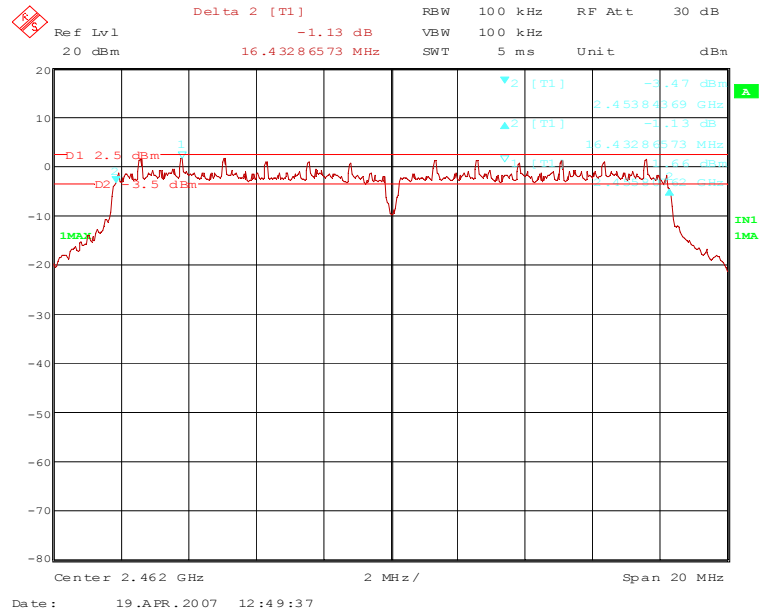

TEST REPORT REFERENCE: R70284_A Edition 1

Operation mode 1 to 3		
Channel number	Channel frequency [MHz]	6dB bandwidth [MHz]
1	2412	10.301
6	2437	10.301
11	2462	10.261
Operation mode 4 to 6		
Channel number	Channel frequency [MHz]	6dB bandwidth [MHz]
1	2412	16.633
6	2437	16.473
11	2462	16.433
Measurement uncertainty		$< \pm 1 \cdot 10^{-7}$

TEST EQUIPMENT USED FOR THE TEST:

31, 46, 54

TEST REPORT REFERENCE: R70284_A Edition 1

5.3 MAXIMUM PEAK OUTPUT POWER

5.3.1 METHOD OF MEASUREMENT (MAXIMUM PEAK OUTPUT POWER)

The calibration of the spectrum analyser has to be checked with the help of a known signal from a signal generator. The EUT has to be connected to the spectrum analyser via a low loss cable. If the EUT is not equipped with an antenna connector, a temporary antenna connector has to be installed. The EUT has to be switched on.

The following power meter settings shall be used:

- Filter No. auto.
- Measuring time 0.136 s to 26 s.
- Used peak sensor NRV –Z32.

The measurement will be performed at the upper and lower end and the middle of the assigned frequency band.

Test set-up:

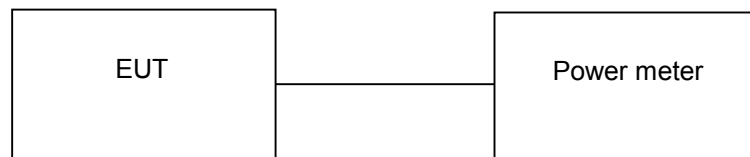

TEST REPORT REFERENCE: R70284_A Edition 1

5.3.2 TEST RESULTS (MAXIMUM PEAK OUTPUT POWER)

Ambient temperature	21 °C	Relative humidity	34 %
---------------------	-------	-------------------	------

Because the maximum antenna gain exceed the 6.0 dBi, the limit is reduced by the amount of the exceedance.

Operation mode 1 to 3				
Channel number	Channel frequency [MHz]	Maximum peak output power [dBm]	Antenna gain [dBi]	Peak power limit [dBm]
1	2412	15.0	8.5	27.5
6	2437	15.5	8.5	27.5
11	2462	15.7	8.5	27.5
Operation mode 4 to 6				
Channel number	Channel frequency [MHz]	Maximum peak output power [dBm]	Antenna gain [dBi]	Peak power limit [dBm]
1	2412	19.9	8.5	27.5
6	2437	20.2	8.5	27.5
11	2462	20.6	8.5	27.5
Measurement uncertainty			+0.66 dB / -0.72 dB	

Test: Passed

TEST EQUIPMENT USED FOR THE TEST:

46, 54, 55

TEST REPORT REFERENCE: R70284_A Edition 1

5.4 POWER SPECTRAL DENSITY

5.4.1 METHOD OF MEASUREMENT (POWER SPECTRAL DENSITY)

The calibration of the spectrum analyser has to be checked with the help of a known signal from a signal generator. The EUT has to be connected to the spectrum analyser via a low loss cable. If the EUT is not equipped with an antenna connector, a temporary antenna connector has to be installed.

The following spectrum analyser settings shall be used:

- Span: 1.5 MHz, centred on the actual channel.
- Resolution bandwidth: 3 kHz.
- Video bandwidth: 30 kHz.
- Sweep: 500 s.
- Detector function: peak.
- Trace mode: Max hold.

After trace stabilisation the marker shall be set on the signal peak. The indicated level is the power spectral density.

Test set-up:



TEST REPORT REFERENCE: R70284_A Edition 1

5.4.2 TEST RESULTS (POWER SPECTRAL DENSITY)

Ambient temperature	21 °C	Relative humidity	34 %
---------------------	-------	-------------------	------

70284_37.wmf (power spectral density (transmit on channel 1), operation mode 1):

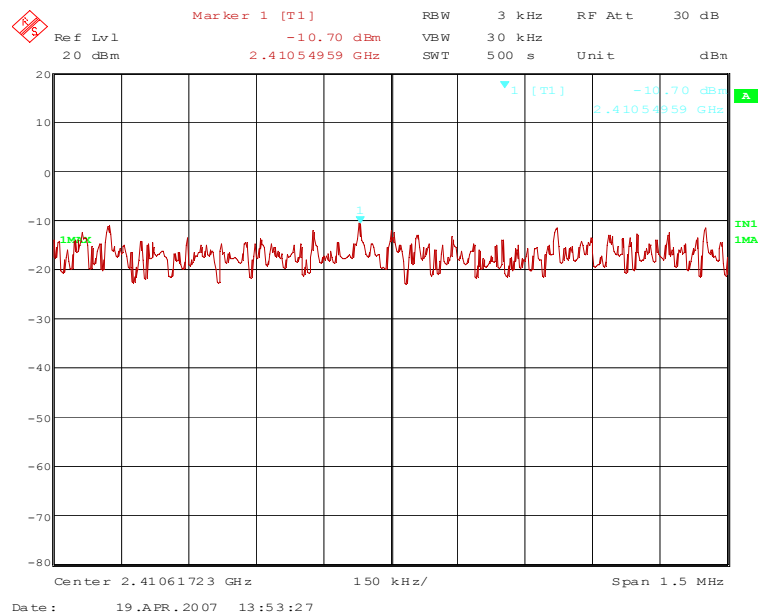

70284_39.wmf (power spectral density (transmit on channel 6), operation mode 2):

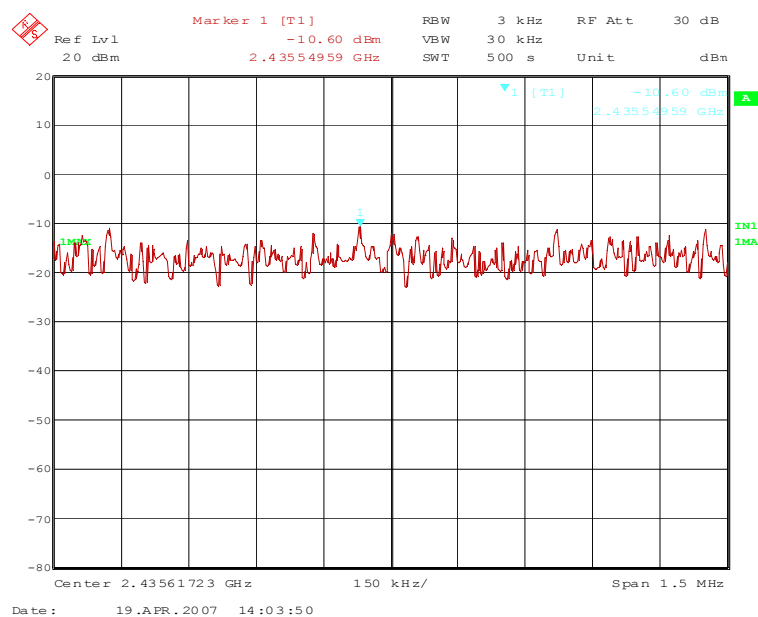

TEST REPORT REFERENCE: R70284_A Edition 1

70284_41.wmf (power spectral density (transmit on channel 11), operation mode 3):

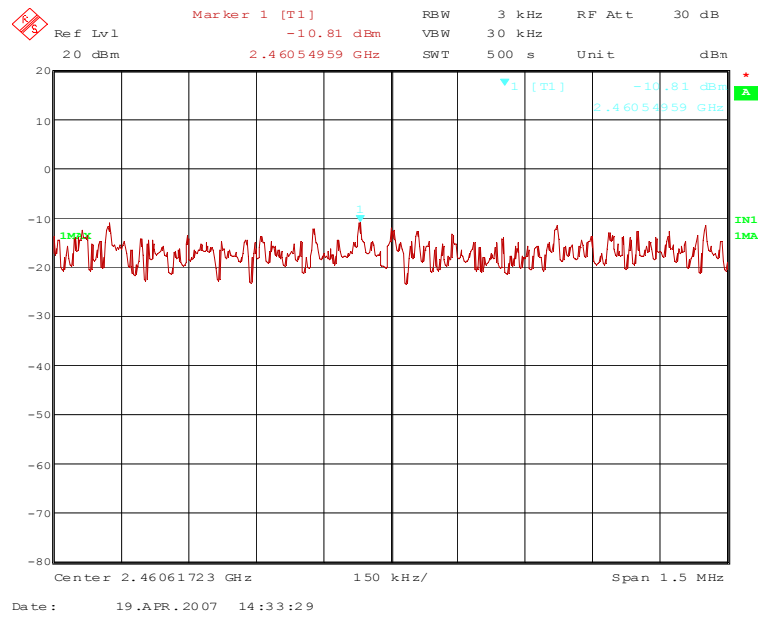

70284_38.wmf (power spectral density (transmit on channel 1), operation mode 4):

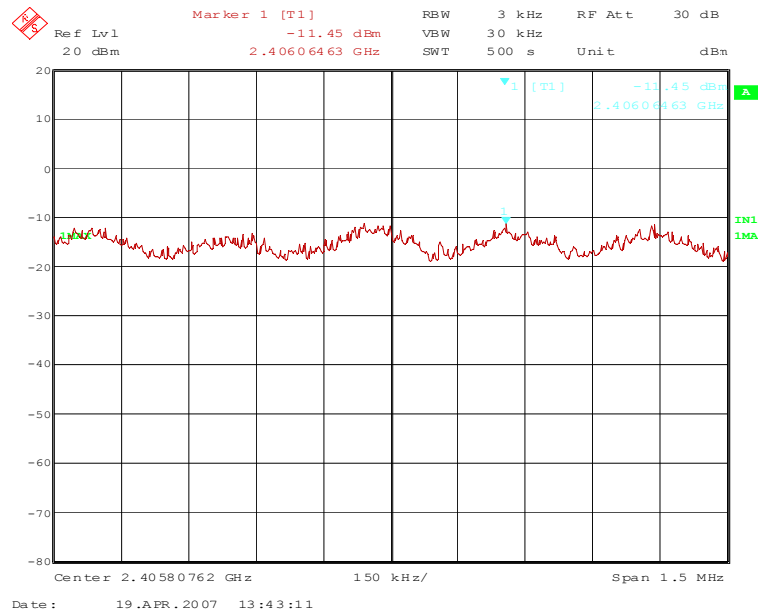

TEST REPORT REFERENCE: R70284_A Edition 1

70284_40.wmf (power spectral density (transmit on channel 6), operation mode 5):

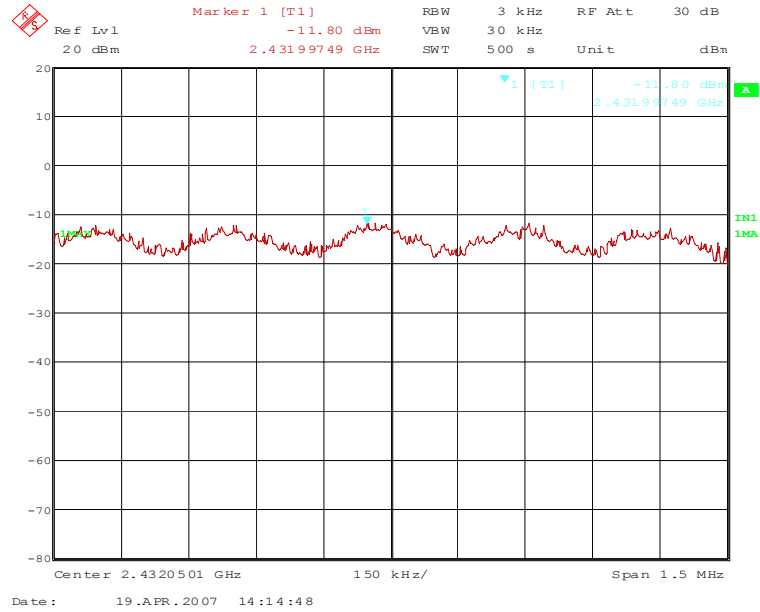

70284_42.wmf (power spectral density (transmit on channel 11), operation mode 6):

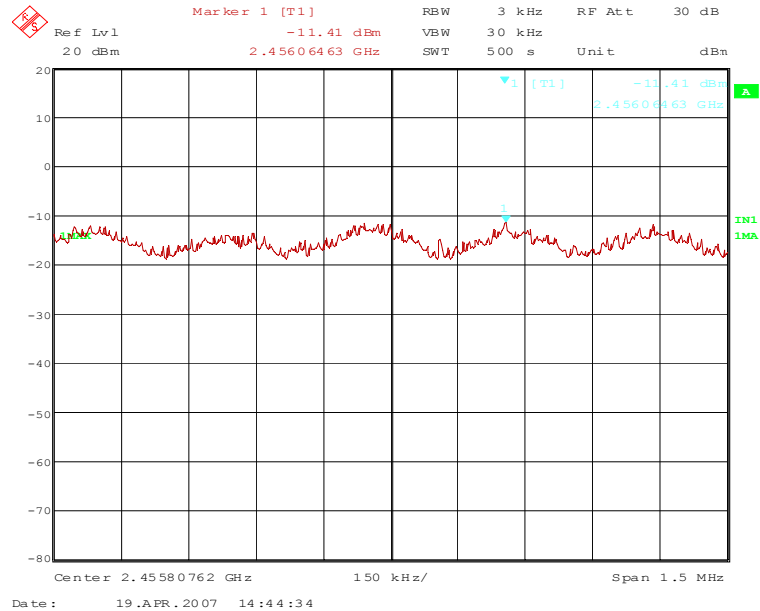

TEST REPORT REFERENCE: R70284_A Edition 1

Because the maximum antenna gain exceed the 6.0 dBi, the limit is reduced by the amount of the exceedance.

Operation mode 1 to 3				
Channel number	Channel frequency [MHz]	Power spectral density [dBm / 3 kHz]	Antenna gain [dBi]	Power spectral density limit [dBm / 3 kHz]
1	2412	-9.8 *	8.5	5.5
6	2437	-9.7 *	8.5	5.5
11	2462	-9.9 *	8.5	5.5
Operation mode 4 to 6				
Channel number	Channel frequency [MHz]	Power spectral density [dBm / 3 kHz]	Antenna gain [dBi]	Power spectral density limit [dBm / 3 kHz]
1	2412	-10.5 *	8.5	5.5
6	2437	-10.9 *	8.5	5.5
11	2462	-10.5 *	8.5	5.5
Measurement uncertainty			+1.1 dB / -1.5 dB	

* cable loss of 0.9 dB respected

Test: Passed

TEST EQUIPMENT USED FOR THE TEST:
31, 46, 54

TEST REPORT REFERENCE: R70284_A Edition 1

5.5 BAND-EDGE COMPLIANCE

5.5.1 METHOD OF MEASUREMENT (BAND-EDGE COMPLIANCE)

The calibration of the spectrum analyser has to be checked with the help of a known signal from a signal generator. The EUT has to be connected to the antenna, which causes the highest field strength on the wanted frequency.

The following spectrum analyser settings shall be used:

- Span: Wide enough to capture the peak level of the emission on the channel closest to the band-edge, as well as any modulation products, which fall outside the assigned frequency band.
- Resolution bandwidth: 100 kHz.
- Video bandwidth: \geq the resolution bandwidth.
- Sweep: Auto.
- Detector function: Peak.
- Trace mode: Max hold.

The same test set-up as used for the final radiated emission measurement shall be used (refer also subclause 5.6.1 of this test report). The measurements shall be carried out with using a resolution bandwidth of 100 kHz.

After trace stabilisation the marker shall be set on the signal peak. The first display line has to be set on this value. The second display line has to be set 20 dB below the first line (or the peak marker). The frequency line shall be set on the edge of the assigned frequency band. Set the second marker on the emission at the band-edge, or on the highest modulation product outside of the band, if this level is higher than that at the band-edge. This frequency shall be measured with the EMI receiver as described in subclause 5.6.1 of this test report, but 100 kHz resolution bandwidth shall be used.

The measurement will be performed at the upper end of the assigned frequency band.

TEST REPORT REFERENCE: R70284_A Edition 1

5.5.2 TEST RESULT (BAND-EDGE COMPLIANCE (RADIATED)) b-mode

Ambient temperature	20 °C	Relative humidity	35 %
---------------------	-------	-------------------	------

70284_72.wmf (radiated band-edge compliance, upper band edge, operation mode 3):

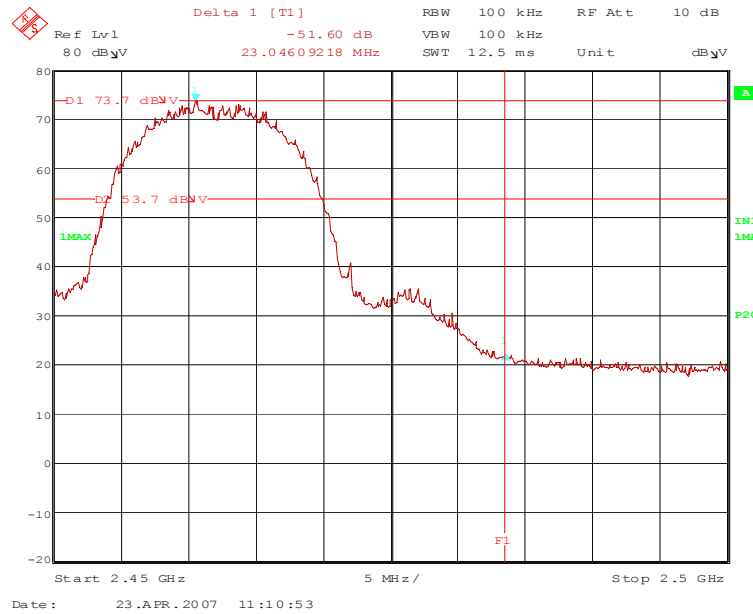

70284_69.wmf (radiated band-edge compliance, lower band edge, operation mode 1):

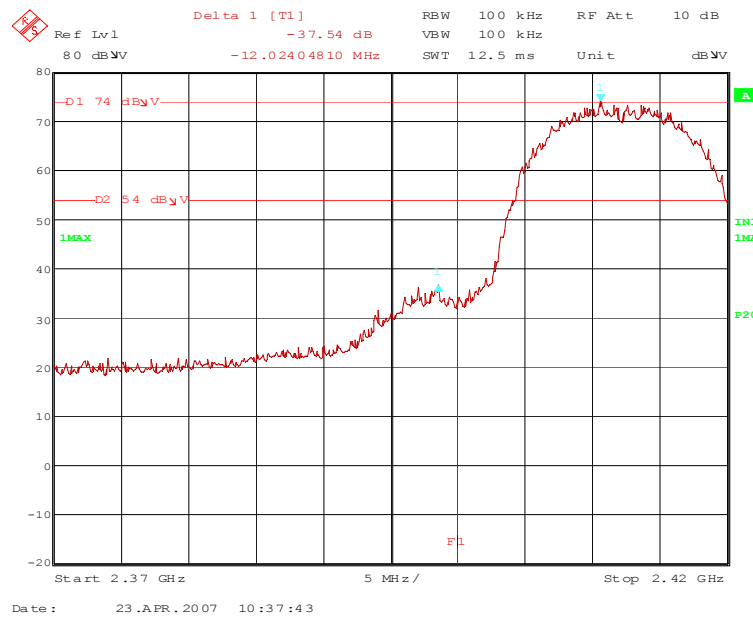

TEST REPORT REFERENCE: R70284_A Edition 1

The plots on the page before are showing the radiated band-edge compliance for the upper band-edge. The display line 1 (D1) in these plots represents the highest level within the assigned frequency band. The display line 2 (D2) represents the 20 dB offset to this highest level and shows the compliance with FCC 47 CFR Part 15.247 (d). The frequency line 1 (F1) shows the edge of the assigned frequency.

Band-edge compliance (upper band edge)										
Result measured with the peak detector:										
Frequency	Corr. value	Limit	Margin	Readings	Antenna factor	Preamp	Cable loss	Height	Pol.	Restr. Band
GHz	dB μ V/m	dB μ V/m	dB	dB μ V	1/m	dB	dB	cm		
2.462	112.4 *	-	-	80.9	28.7	0.0	2.8	150	Vert.	-
2.484	54.0	74.0	20.0	22.5	28.7	0.0	2.8	150	Vert.	Yes
Result measured with the average detector:										
Frequency	Corr. value	Limit	Margin	Readings	Antenna factor	Preamp	Cable loss	Height	Pol.	Restr. Band
GHz	dB μ V/m	dB μ V/m	dB	dB μ V	1/m	dB	dB	cm		
2.462	105.0 *	-	-	73.5	28.7	0.0	2.8	150	Vert.	-
2.484	40.9	54.0	13.1	9.4	28.7	0.0	2.8	150	Vert.	Yes
Measurement uncertainty							+2.2 dB / -3.6 dB			

Band-edge compliance (lower band edge)										
Result measured with the peak detector:										
Frequency	Corr. value	Limit	Margin	Readings	Antenna factor	Preamp	Cable loss	Height	Pol.	Restr. Band
GHz	dB μ V/m	dB μ V/m	dB	dB μ V	1/m	dB	dB	cm		
2.412	111.8 *	-	-	80.5	28.5	0.0	2.8	150	Vert.	-
2.397	67.3	91.8	24.6	35.8	28.7	0.0	2.8	150	Vert.	No
Result measured with the average detector:										
Frequency	Corr. value	Limit	Margin	Readings	Antenna factor	Preamp	Cable loss	Height	Pol.	Restr. Band
GHz	dB μ V/m	dB μ V/m	dB	dB μ V	1/m	dB	dB	cm		
2.412	104.3 *	-	-	73.0	28.5	0.0	2.8	150	Vert.	-
2.397	55.0	84.3	29.3	23.5	28.7	0.0	2.8	150	Vert.	No
Measurement uncertainty							+2.2 dB / -3.6 dB			

*Worst case measurement values out of final measurements with worst case antenna (Patch antenna) in b-mode, refer to page 72 and 74 of this test report.

Test: Passed

TEST EQUIPMENT USED FOR THE TEST:
29, 31 – 34, 36, 44, 54

TEST REPORT REFERENCE: R70284_A Edition 1

5.5.3 TEST RESULT (BAND-EDGE COMPLIANCE (RADIATED)) g-mode

Ambient temperature	20 °C	Relative humidity	35 %
---------------------	-------	-------------------	------

70284_71.wmf (radiated band-edge compliance, upper band edge, operation mode 6):

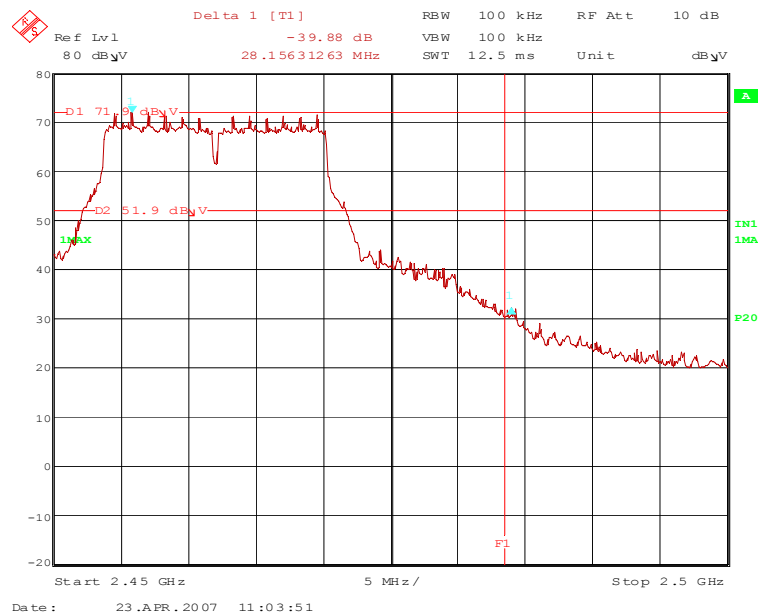

70284_70.wmf (radiated band-edge compliance, lower band edge, operation mode 4):

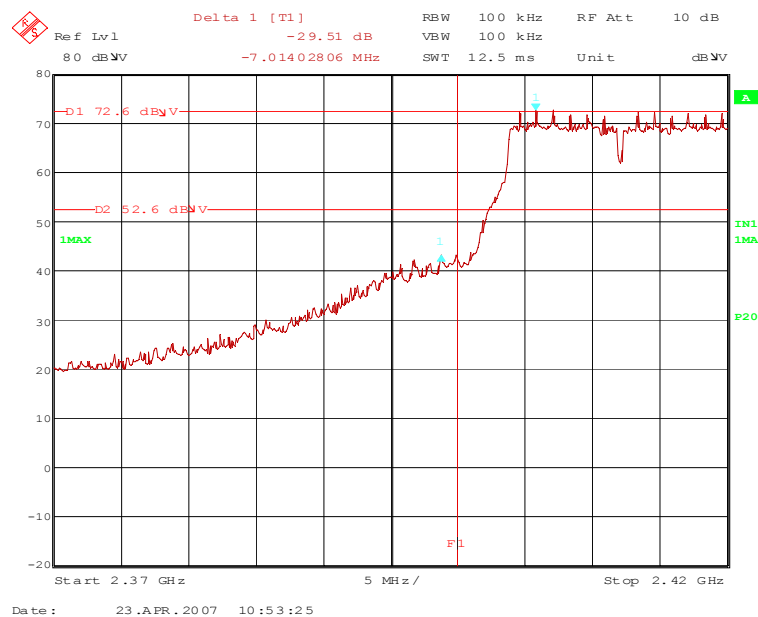

TEST REPORT REFERENCE: R70284_A Edition 1

The plots on the page before are showing the radiated band-edge compliance for the upper band-edge. The display line 1 (D1) in these plots represents the highest level within the assigned frequency band. The display line 2 (D2) represents the 20 dB offset to this highest level and shows the compliance with FCC 47 CFR Part 15.247 (d). The frequency line 1 (F1) shows the edge of the assigned frequency.

Band-edge compliance (upper band edge)										
Result measured with the peak detector:										
Frequency	Corr. value	Limit	Margin	Readings	Antenna factor	Preamp	Cable loss	Height	Pol.	Restr. Band
GHz	dB μ V/m	dB μ V/m	dB	dB μ V	1/m	dB	dB	cm		
2.462	113.3 *	-	-	81.8	28.7	0.0	2.8	150	Vert.	-
2.484	61.1	74.0	12.9	29.6	28.7	0.0	2.8	150	Vert.	Yes
Result measured with the average detector:										
Frequency	Corr. value	Limit	Margin	Readings	Antenna factor	Preamp	Cable loss	Height	Pol.	Restr. Band
GHz	dB μ V/m	dB μ V/m	dB	dB μ V	1/m	dB	dB	cm		
2.462	103.2 *	-	-	71.7	28.7	0.0	2.8	150	Vert.	-
2.484	48.7	54.0	5.3	17.2	28.7	0.0	2.8	150	Vert.	Yes
Measurement uncertainty							+2.2 dB / -3.6 dB			

Band-edge compliance (lower band edge)										
Result measured with the peak detector:										
Frequency	Corr. value	Limit	Margin	Readings	Antenna factor	Preamp	Cable loss	Height	Pol.	Restr. Band
GHz	dB μ V/m	dB μ V/m	dB	dB μ V	1/m	dB	dB	cm		
2.412	112.8 *	-	-	81.5	28.5	0.0	2.8	150	Vert.	-
2.398	73.1	92.8	19.7	41.6	28.7	0.0	2.8	150	Vert.	Yes
Result measured with the average detector:										
Frequency	Corr. value	Limit	Margin	Readings	Antenna factor	Preamp	Cable loss	Height	Pol.	Restr. Band
GHz	dB μ V/m	dB μ V/m	dB	dB μ V	1/m	dB	dB	cm		
2.412	102.6 *	-	-	71.3	28.5	0.0	2.8	150	Vert.	-
2.398	60.7	82.6	21.9	29.2	28.7	0.0	2.8	150	Vert.	Yes
Measurement uncertainty							+2.2 dB / -3.6 dB			

*Worst case measurement values out of final measurements with worst case antenna (Patch antenna) in g-mode, Refer to page 82 and 84 of this test report.

Test: Passed

TEST EQUIPMENT USED FOR THE TEST:
29, 31 – 34, 36, 44, 54

TEST REPORT REFERENCE: R70284_A Edition 1

5.6 RADIATED EMISSIONS

5.6.1 METHOD OF MEASUREMENT (RADIATED EMISSIONS)

The radiated emission measurement is subdivided into four stages.

- A preliminary measurement carried out in a fully anechoic chamber with a fixed antenna height in the frequency range 30 kHz to 1 GHz.
- A final measurement carried out on an outdoor test side without reflecting ground plane and a fixed antenna height in the frequency range 30 kHz to 30 MHz.
- A final measurement carried out on an open area test side with reflecting ground plane and various antenna height in the frequency range 30 MHz to 1 GHz.
- A final measurement carried out in a fully anechoic chamber with a fixed antenna height in the frequency range 1 GHz to 25 GHz.

All measurements will be carried out with the EUT working on the middle and upper and lower edge of the assigned frequency band.

Preliminary measurement (30 kHz to 30 MHz):

In the first stage a preliminary measurement will be performed in a shielded room with a measuring distance of 3 meters. Tabletop devices will set up on a non-conducting support with a size of 1 m by 1.5 m and a height of 80 cm. Floor-standing devices will be placed directly on the turntable/ground plane. The set up of the Equipment under test will be in accordance to ANSI C63.4-2003 [1].

The frequency range 30 kHz to 30 MHz will be monitored with a spectrum analyser while the system and its cables will be manipulated to find out the configuration with the maximum emission levels if applicable. The EMI Receiver will be set to MAX Hold mode. The EUT and the measuring antenna will be rotated around their vertical axis to found the maximum emissions.

The resolution bandwidth of the spectrum analyser will be set to the following values:

Frequency range	Resolution bandwidth
30 kHz to 150 kHz	200 Hz
150 kHz to 30 MHz	10 kHz

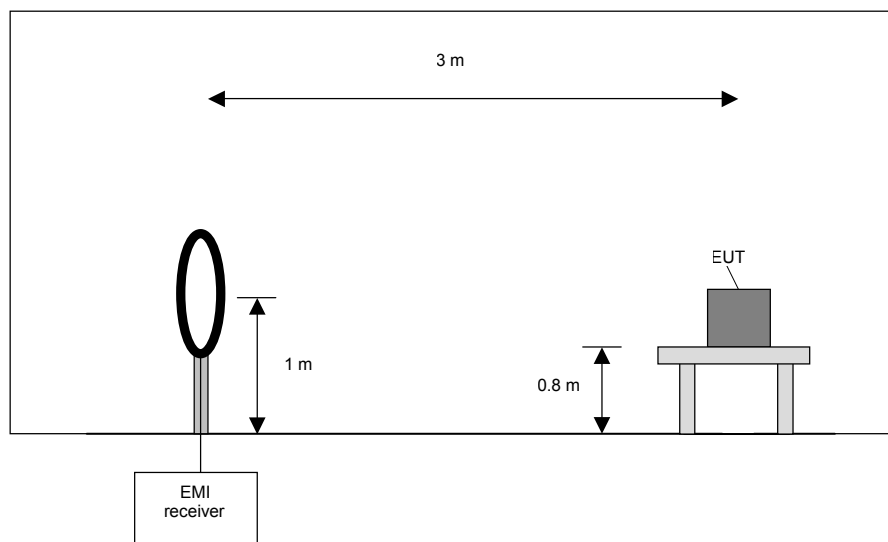

TEST REPORT REFERENCE: R70284_A Edition 1

Preliminary measurement procedure:

Prescans were performed in the frequency range 30 kHz to 150 kHz and 150 kHz to 30 MHz.

The following procedure will be used:

- 1) Monitor the frequency range at horizontal polarisation and a EUT azimuth of 0 °.
- 2) Manipulate the system cables within the range to produce the maximum level of emission.
- 3) Rotate the EUT by 360 ° to maximize the detected signals.
- 4) Make a hardcopy of the spectrum.
- 5) Measure the frequencies of highest detected emission with a lower span and resolution bandwidth to increase the accuracy and note the frequency value.
- 6) Repeat steps 1) to 5) with the other orthogonal axes of the EUT (because of EUT is a module and might be used in a handheld equipment application).
- 7) Rotate the measuring antenna and repeat steps 1) to 5).

Final measurement (30 kHz to 30 MHz):

In the second stage a final measurement will be performed on an open area test site with no conducting ground plane in a measuring distances of 3 m, 10 m and 30 m if possible. In the case where larger measuring distances are required the results will be extrapolated based on the values measured on the closer distances according to Section 15.31 (f) (2) [2]. The final measurement will be performed with a EMI Receiver set to Quasi Peak detector except for the frequency bands 30 kHz to 90 kHz and 110 kHz to 490 kHz where an average detector will be used according Section 15.209 (d) [2].

On the during the preliminary measurement detected frequencies the final measurement will be performed while rotating the EUT and the measuring antenna in the range of 0 ° to 360 ° around their vertical axis until the maximum value is found.

The resolution bandwidth of the EMI Receiver will be set to the following values:

Frequency range	Resolution bandwidth
30 kHz to 150 kHz	200 Hz
150 kHz to 30 MHz	9 kHz

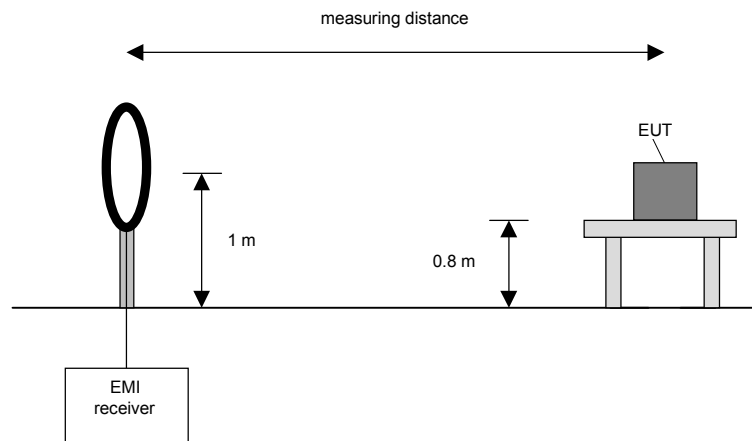

TEST REPORT REFERENCE: R70284_A Edition 1

Final measurement procedure:

The following procedure will be used:

- 1) Monitor the frequency range with the measuring antenna at vertical orientation parallel to the EUT at an azimuth of 0 °.
- 2) Rotate the EUT by 360 ° to maximize the detected signals and note the azimuth and orientation.
- 3) Rotate the measuring antenna to find the maximum and note the value.
- 4) Rotate the measuring antenna and repeat steps 1) to 3) until the maximum value is found.
- 5) Repeat steps 1) to 4) with the other orthogonal axes of the EUT (because of EUT is a module and might be used in a handheld equipment application).

Preliminary measurement (30 MHz to 1 GHz)

In the first stage a preliminary measurement will be performed in a fully anechoic chamber with a measuring distance of 3 meter. Tabletop devices will set up on a non-conducting support with a size of 1 m by 1.5 m and a height of 80 cm. Floor-standing devices will be placed directly on the turntable/ground plane. The set up of the Equipment under test will be in accordance to ANSI C63.4-2003 [1].

The frequency range 30 MHz to 1 GHz will be measured with an EMI Receiver set to MAX Hold mode and a resolution bandwidth of 100 kHz. The measurement will be performed in horizontal and vertical polarisation of the measuring antenna and while rotating the EUT in its vertical axis in the range of 0 ° to 360 °.

The resolution bandwidth of the EMI Receiver will be set to the following values:

Frequency range	Resolution bandwidth
30 MHz to 230 MHz	100 kHz
230 MHz to 1 GHz	100 kHz

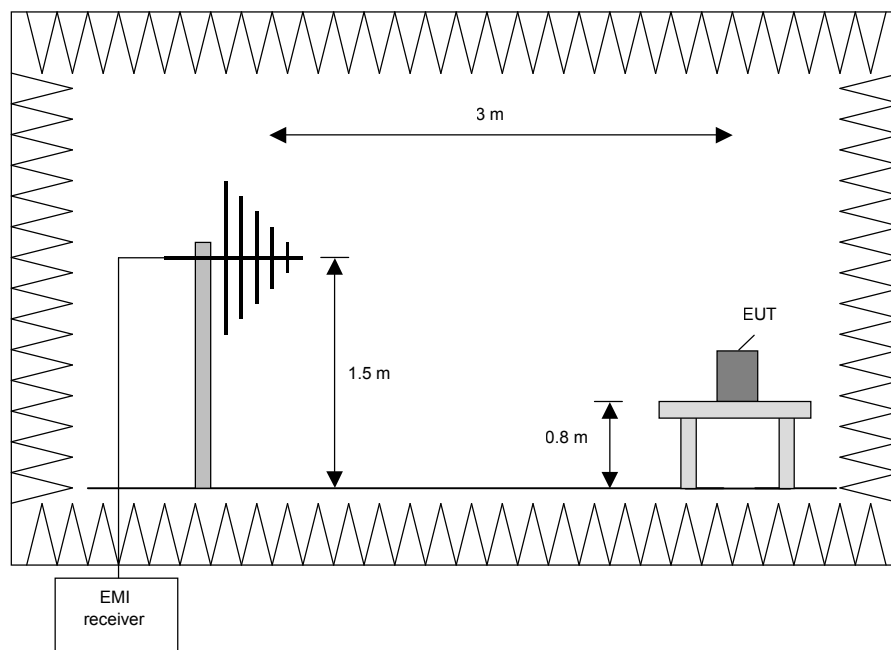

TEST REPORT REFERENCE: R70284_A Edition 1

Procedure preliminary measurement:

Prescans were performed in the frequency range 30 MHz to 230 MHz and 230 MHz to 1 GHz.
The following procedure will be used:

1. Monitor the frequency range at horizontal polarisation and a EUT azimuth of 0 °.
2. Manipulate the system cables within the range to produce the maximum level of emission.
3. Rotate the EUT by 360 ° to maximize the detected signals.
4. Make a hardcopy of the spectrum.
5. Measure the frequency of the detected emissions with a lower span and resolution bandwidth to increase the accuracy and note the frequency value.
6. Repeat 1) to 4) with the other orthogonal axes of the EUT if handheld equipment.
7. Repeat 1) to 5) with the vertical polarisation of the measuring antenna.

Final measurement (30 MHz to 1 GHz)

A final measurement on an open area test site will be performed on selected frequencies found in the preliminary measurement. During this test the EUT will be rotated in the range of 0 ° to 360 °, the measuring antenna will be set to horizontal and vertical polarisation and raised and lowered in the range from 1 m to 4 m to find the maximum level of emissions.

The resolution bandwidth of the EMI Receiver will be set to the following values:

Frequency range	Resolution bandwidth
30 MHz to 1 GHz	120 kHz

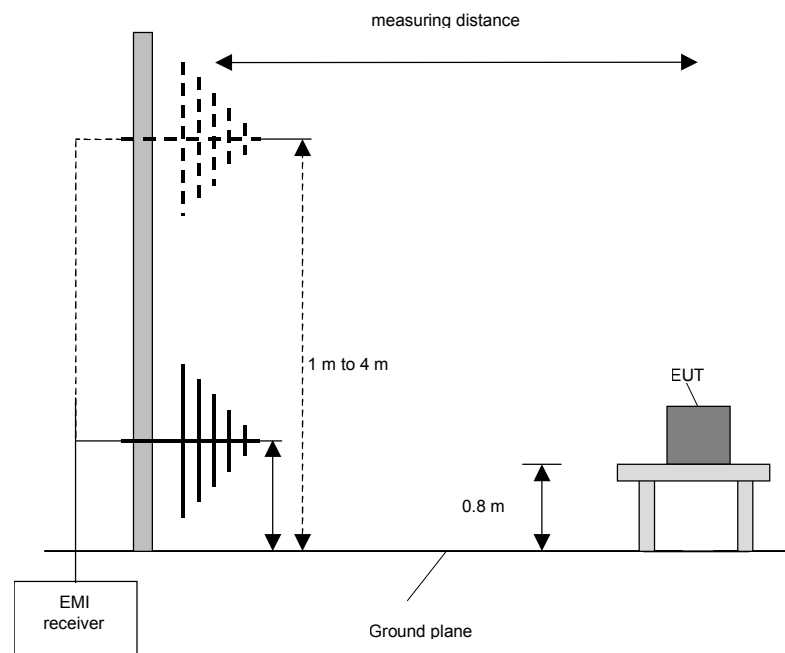

TEST REPORT REFERENCE: R70284_A Edition 1

Procedure final measurement:

The following procedure will be used:

- 1) Measure on the selected frequencies at an antenna height of 1 m and a EUT azimuth of 23 °.
- 2) Move the antenna from 1 m to 4 m and note the maximum value at each frequency.
- 3) Rotate the EUT by 45 ° and repeat 2) until an azimuth of 337 ° is reached.
- 4) Repeat 1) to 3) for the other orthogonal antenna polarization.
- 5) Move the antenna and the turntable to the position where the maximum value is detected.
- 6) Measure while moving the antenna slowly +/- 1 m.
- 7) Set the antenna to the position where the maximum value is found.
- 8) Measure while moving the turntable +/- 45 °.
- 9) Set the turntable to the azimuth where the maximum value is found.
- 10) Measure with Final detector (QP and AV) and note the value.
- 11) Repeat 5) to 10) for each frequency.
- 12) Repeat 1) to 11) for each orthogonal axes of the EUT if handheld equipment.

Preliminary and final measurement (1 GHz to 25 GHz)

This measurement will be performed in a fully anechoic chamber. Tabletop devices will set up on a non-conducting support with a size of 1 m by 1.5 m and a height of 80 cm. Floor-standing devices will be placed directly on the turntable/ground plane. The set up of the Equipment under test will be in accordance to ANSI C63.4-2003 [1]. The resolution bandwidth of the EMI Receiver will be set to the following values:

Frequency range	Resolution bandwidth (preliminary)	Resolution bandwidth (final)
1 GHz to 4 GHz	100 kHz	1 MHz
4 GHz to 12 GHz	100 kHz	1 MHz
12 GHz to 18 GHz	100 kHz	1 MHz
18 GHz to 25 GHz	100 kHz	1 MHz

Preliminary measurement (1 GHz to 25 GHz)

The frequency range will be divided into different sub ranges depending of the frequency range of the used horn antenna. The spectrum analyser set to MAX Hold mode and a resolution bandwidth of 100 kHz. The measurement will be performed in horizontal and vertical polarisation of the measuring antenna, the antenna close to the EUT and while moving the antenna over all sides of the EUT. With the spectrum analyser in CLEAR / WRITE mode the cone of the emission should be found and than the measuring distance will be set to 3 m with the receiving antenna moving in this cone of emission. At this position the final measurement will be carried out.

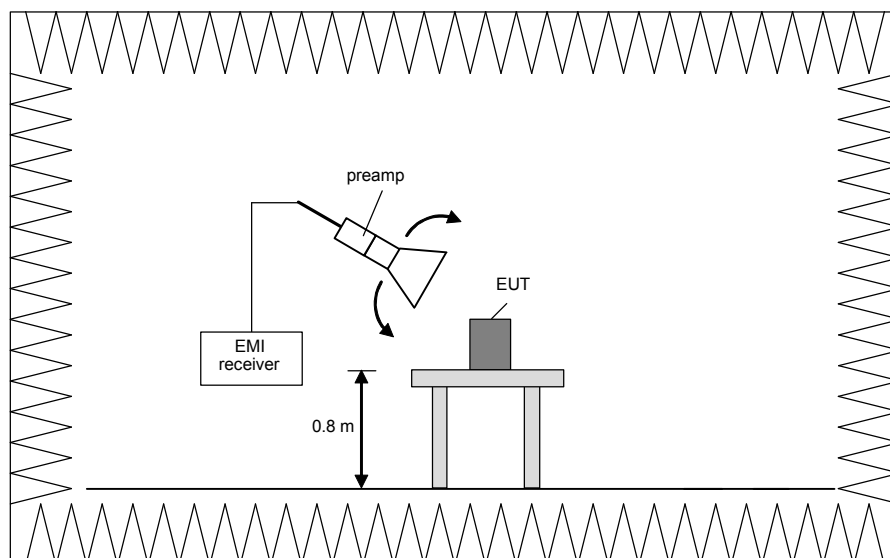

TEST REPORT REFERENCE: R70284_A Edition 1

Final measurement (1 GHz to 25 GHz)

The frequency range will be divided into different sub ranges depending of the frequency range of the used horn antenna. The EMI Receiver set to peak and average mode and a resolution bandwidth of 1 MHz. The measurement will be performed in horizontal and vertical polarisation of the measuring antenna and while rotating the EUT in its vertical axis in the range of 0 ° to 360 ° in order to have the antenna inside the cone of radiation.

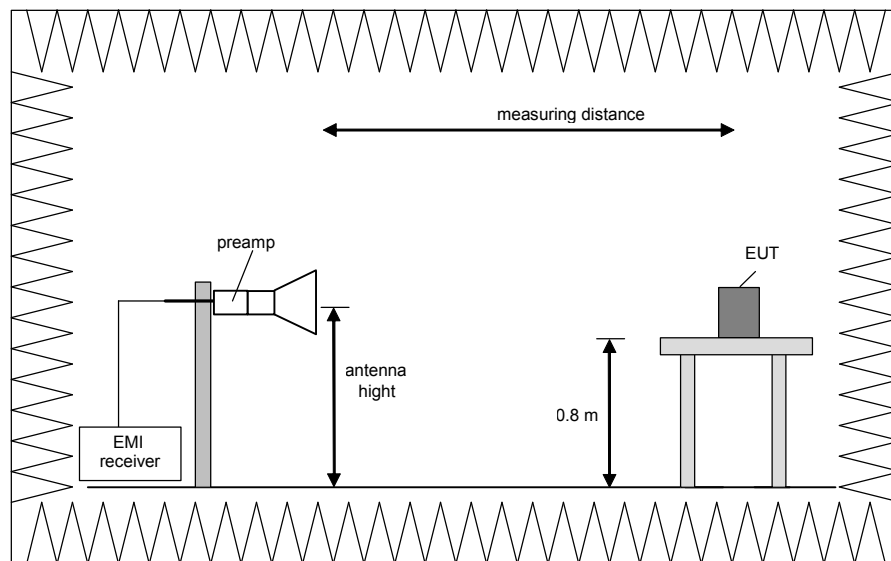

Procedure of measurement:

The measurements were performed in the frequency range 1 GHz to 4 GHz, 4 GHz to 12 GHz, 12 GHz to 18 GHz and 18 GHz to 25 GHz.

The following procedure will be used:

- 1) Monitor the frequency range at horizontal polarisation and move the antenna over all sides of the EUT (if necessary move the EUT to another orthogonal axis).
- 2) Change the antenna polarisation and repeat 1) with vertical polarisation.
- 3) Make a hardcopy of the spectrum.
- 4) Measure the frequency of the detected emissions with a lower span and resolution bandwidth to increase the accuracy and note the frequency value.
- 5) Change the analyser mode to Clear / Write and found the cone of emission.
- 6) Rotate and move the EUT, so that the measuring distance can be enlarged to 3 m and the antenna will be still inside the cone of emission.
- 7) Measure the level of the detected frequency with the correct resolution bandwidth, with the antenna polarisation and azimuth and the peak and average detector, which causes the maximum emission.
- 8) Repeat steps 1) to 7) for the next antenna spot if the EUT is larger than the antenna beam width.

Step 1) to 6) are defined as preliminary measurement.

TEST REPORT REFERENCE: R70284_A Edition 1

5.6.2 TEST RESULTS (TRANSMITTER RADIATED EMISSIONS)

5.6.2.1 PRELIMINARY MEASUREMENT INTERNAL ANTENNA (30 kHz to 1 GHz)

Ambient temperature	20 °C	Relative humidity	35 %
---------------------	-------	-------------------	------

- Position of EUT:** The EUT was set-up on a non-conducting table of a height of 0.8 m. The distance between EUT and antenna was 3 m.
- Cable guide:** The cables of the EUT were fixed on the non-conducting table. For further information of the cable guide refer to the pictures in annex A of this test report.
- Test record:** All results are shown in the following.
- Supply voltage:** During all measurements the EUT was supplied with 5.0 V DC via the carrier board.
- Remark:** As pre-tests have shown, the emissions in the frequency range 30 kHz to 1 GHz are not depending on the used antenna or the antenna cable length and also not on the transmitter operation mode or frequency. Therefore the emissions in this frequency range were measured only with the internal antenna, only in b-mode with 11 Mbps and transmit in the middle of the assigned frequency range (operation mode 2).

The emissions around 31 kHz 62 kHz and 116 kHz are caused by the measuring system, not by the EUT.

70284_102.wmf (30 kHz to 150 kHz), operation mode2:

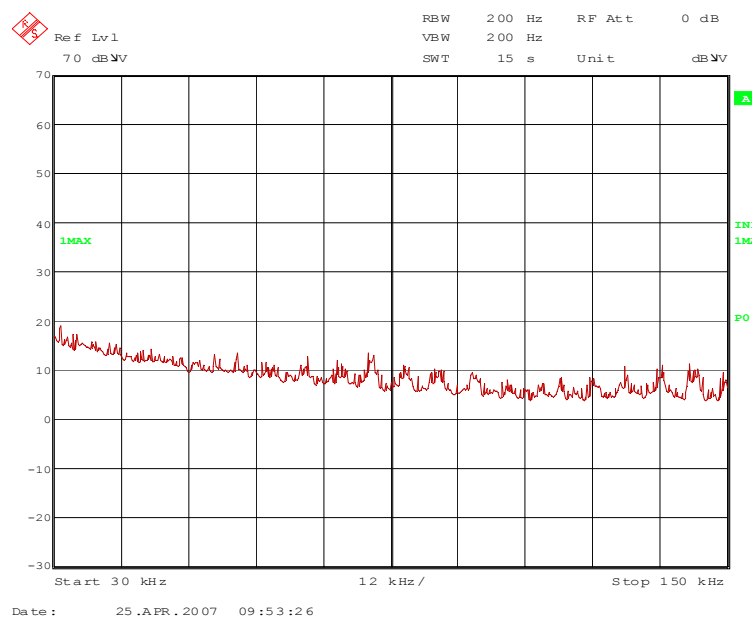

TEST EQUIPMENT USED FOR THE TEST:

29, 31 – 37, 39, 43, 46, 49 – 51, 54, 58

TEST REPORT REFERENCE: R70284_A Edition 1

70284_100.wmf (150 kHz to 1 MHz), operation mode 2:

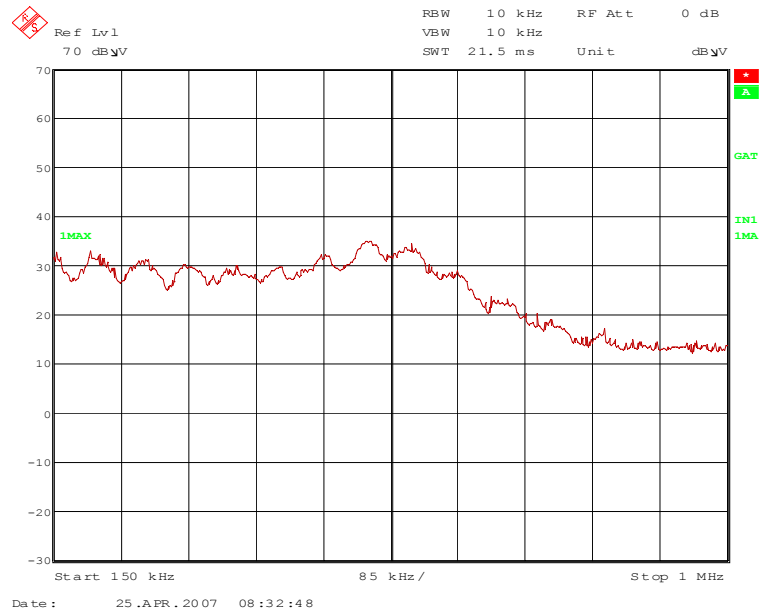

70284_101.wmf (1 MHz to 30 MHz), operation mode 2:

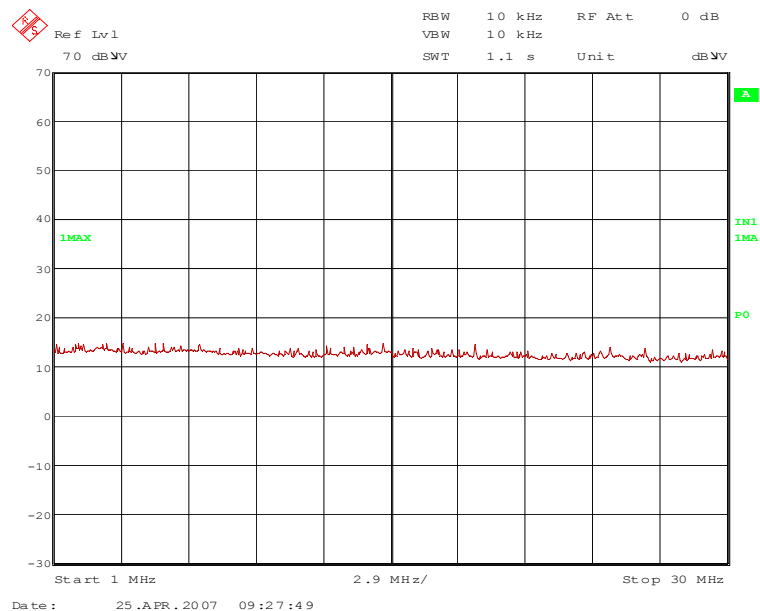

The following emission was found according to FCC 47 CFR Part 15 section 15.209 (a).

86.361 kHz, 138.118 kHz, 143.898 kHz, 208.59 kHz, 553.11 kHz and 599.513 kHz.

These frequencies have to be measured on the outdoor test site. The result of this final measurement were presented in the following.

TEST REPORT REFERENCE: R70284_A Edition 1

70284_106.wmf (30 MHz to 230 MHz), operation mode 2:

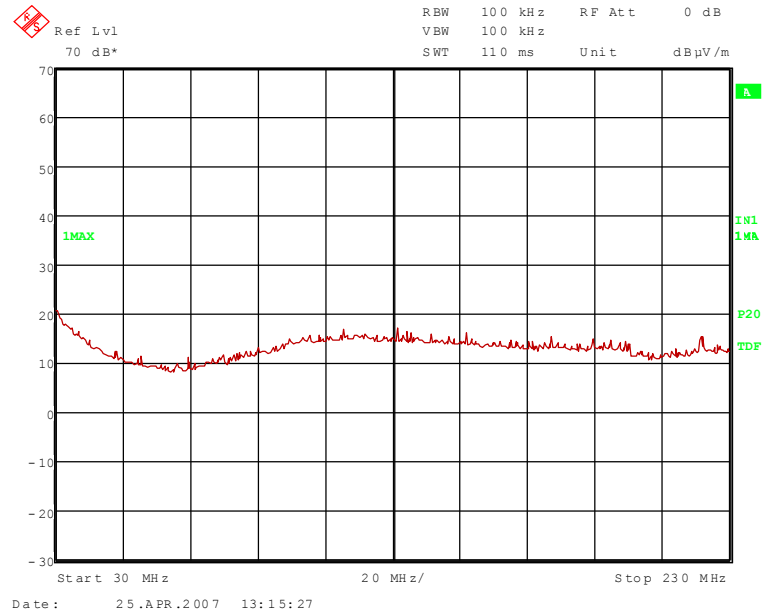

70284_107.wmf (230 MHz to 1 GHz), operation mode 2:

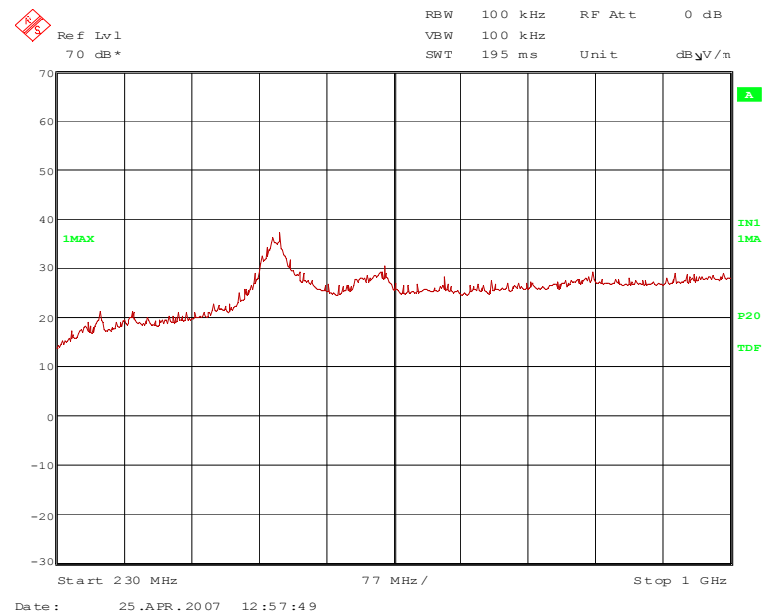

The following frequencies were found during the preliminary radiated emission test:

221.192 MHz, 492.8 MHz

The following frequencies were found inside the restricted bands according to FCC 47 CFR Part 15 section 15.205 [2].

131.277 MHz, 608.447 MHz

TEST REPORT REFERENCE: R70284_A Edition 1

70284_108.wmf (30 MHz to 230 MHz), operation mode 5:

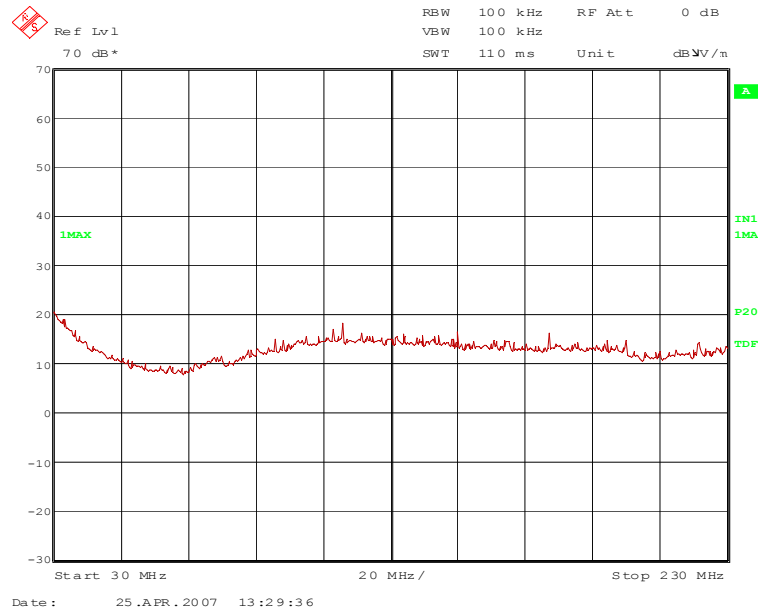

70284_109.wmf (230 MHz to 1 GHz), operation mode 5:

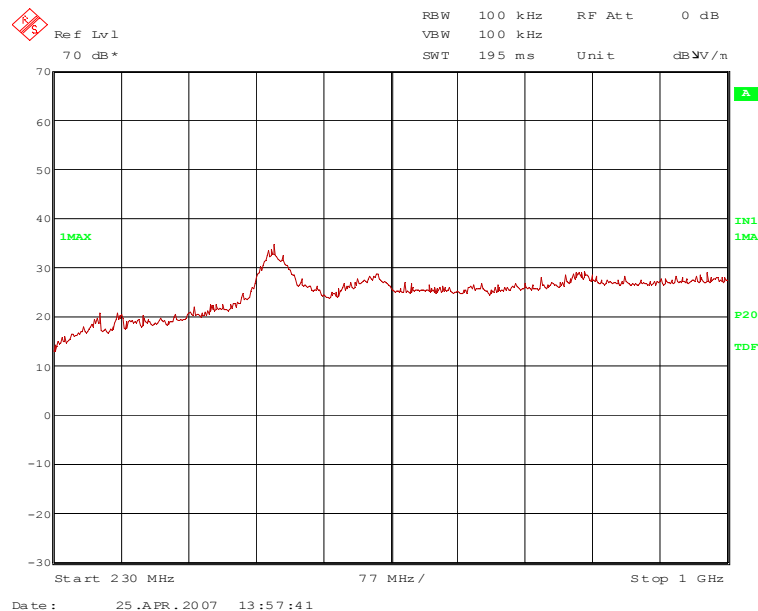

The following frequencies were found during the preliminary radiated emission test:

176.954 MHz, 492.800 MHz, 600.391 MHz, 837.606

The following frequencies were found inside the restricted bands according to FCC 47 CFR Part 15 section 15.205 [2].

113.787 MHz,

These frequencies have to be measured on the open area test site. The results of this final measurement were presented in the following.

TEST REPORT REFERENCE: R70284_A Edition 1

5.6.2.2 FINAL MEASUREMENT INTERNAL ANTENNA (9 kHz to 30 MHz)

Ambient temperature:	12 °C	Relative humidity:	50 %
----------------------	-------	--------------------	------

- Position of EUT:** The EUT was set-up on a non-conducting table of a height of 0.8 m. The distance between EUT and antenna was 3 m.
- Cable guide:** The cables of the EUT were fixed on the non-conducting table. For further information of the cable guide refer to the pictures in annex A of this test report.
- Test record:** All results are shown in the following.
- Supply voltage:** During all measurements the EUT was supplied with 5.0 V DC via the carrier board.
- Remark:** As pre-tests have shown, the emissions in the frequency range 30 kHz to 1 GHz are not depending on the used antenna or the antenna cable length and also not on the transmitter operation mode or frequency. Therefore the emissions in this frequency range were measured only with the internal antenna, only in b-mode with 11 Mbps and transmit in the middle of the assigned frequency range (operation mode 2).
- Test results:** The test results were calculated with the following formula:

$$\text{Result [dB}\mu\text{V/m]} = \text{reading [dB}\mu\text{V]} + \text{antenna factor [dB/m]}$$

Results with measuring distance of 3 m						
Frequency	Result dB μ V/m	Limit dB μ V/m	Margin dB	Detector	Readings dB μ V	Antenna factor * dB/m
86.361 kHz	33.0	108.9	75.9	AV	13.0	20
138.118 kHz	36.3	104.8	68.8	AV	16.3	20
143.898 kHz	32.4	104.4	72.0	AV	12.4	20
208.590 kHz	31.7	101.2	69.5	AV	11.7	20
553.110 kHz	49.1	72.7	23.6	QP	19.5	20
599.513 kHz	38.0	72.0	34.0	QP	18.0	20
Results with measuring distance of 10 m						
Frequency MHz	Result dB μ V/m	Limit dB μ V/m	Margin dB	Detector	Readings dB μ V	Antenna factor * dB/m
86.361 kHz	Signal was below the noise floor of the system					
138.118 kHz	Signal was below the noise floor of the system					
143.898 kHz	Signal was below the noise floor of the system					
208.59 kHz	Signal was below the noise floor of the system					
553.11 kHz	Signal was below the noise floor of the system					
599.513 kHz	Signal was below the noise floor of the system					
Measurement uncertainty				+2.2 dB / -3.6 dB		

*: Cable loss included

Test: Passed

TEST EQUIPMENT USED FOR THE TEST:
54, 56 - 58

TEST REPORT REFERENCE: R70284_A Edition 1

5.6.2.3 FINAL MEASUREMENT INTERNAL ANTENNA (30 MHz to 1 GHz)

Ambient temperature:	19 °C	Relative humidity:	50 %
----------------------	-------	--------------------	------

- Position of EUT:** The EUT was set-up on a non-conducting table of a height of 0.8 m. The distance between EUT and antenna was 3 m.
- Cable guide:** The cables of the EUT were fixed on the non-conducting table. For further information of the cable guide refer to the pictures in annex A of this test report.
- Test record:** All results are shown in the following.
- Supply voltage:** During all measurements the EUT was supplied with 5.0 V DC via the carrier board.
- Remark:** As pre-tests have shown, the emissions in the frequency range 30 kHz to 1 GHz are not depending on the used antenna or the antenna cable length and also not on the transmitter operation mode or frequency. Therefore the emissions in this frequency range were measured with the internal antenna, in b-mode with 11 Mbps and in g-mode with 6 Mbps in transmit in the middle of the assigned frequency range (operation mode 2 and 5).

30 MHz to 1 GHz, operation mode 2:

The measured points and the limit line in the following diagram refer to the standard measurement of the emitted interference in compliance with the above-mentioned standard. The measured points marked with x are the measured results of the standard final measurement on the open area test site.

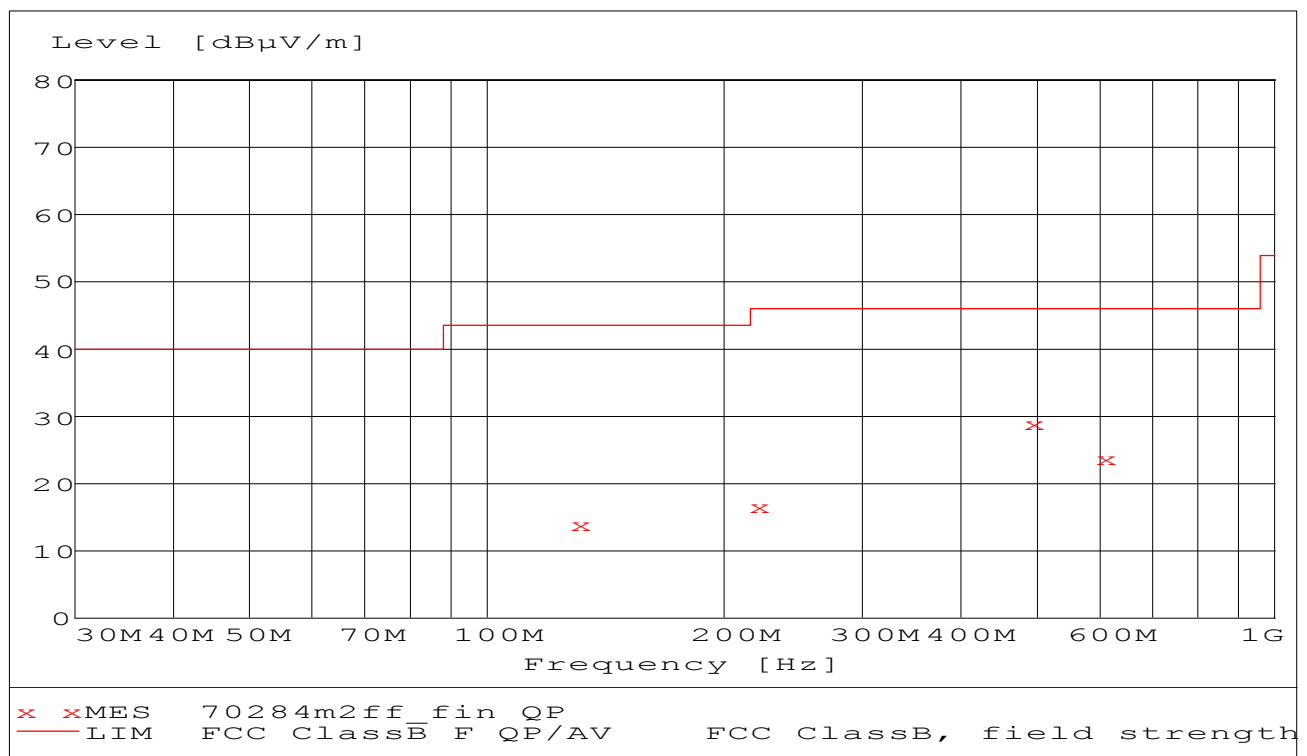

Data record name: 70284m2ff

TEST REPORT REFERENCE: R70284_A Edition 1

The results of the standard final measurement on the open area test site are indicated in the table below. The limits as well as the measured results (levels) refer to the above-mentioned standard while taking account of the specified requirements for a 3 m measuring distance.

The measurement time with the quasi-peak measuring detector is 1 second.

Result measured with the quasipeak detector:

(These values are marked in the above diagram by x)

Spurious emissions outside restricted bands									
Frequency	Result	Limit	Margin	Readings	Antenna factor	Cable loss	Height	Azimuth	Pol.
MHz	dB μ V/m	dB μ V/m	dB	dB μ V	dB/m	dB	cm	deg	
221.192	16.70	46.0	29.3	4.8	9.9	1.6	175.0	330.00	Vert.
492.800	29.20	46.0	16.8	9.4	17.3	2.5	169.0	226.00	Hor.
Spurious emissions in restricted bands									
Frequency	Result	Limit	Margin	Readings	Antenna factor	Cable loss	Height	Azimuth	Pol.
MHz	dB μ V/m	dB μ V/m	dB	dB μ V	dB/m	dB	cm	deg	
131.277	14.00	43.5	29.5	0.6	12.1	1.3	175.0	286.00	Vert.
608.447	23.80	46.0	22.2	1.6	19.4	2.8	143.0	228.00	Hor.
Measurement uncertainty				+2.2 dB / -3.6 dB					

TEST REPORT REFERENCE: R70284_A Edition 1

30 MHz to 1 GHz, operation mode 5:

The measured points and the limit line in the following diagram refer to the standard measurement of the emitted interference in compliance with the above mentioned standard. The measured points marked with x are the measured results of the standard subsequent measurement on the open area test site.

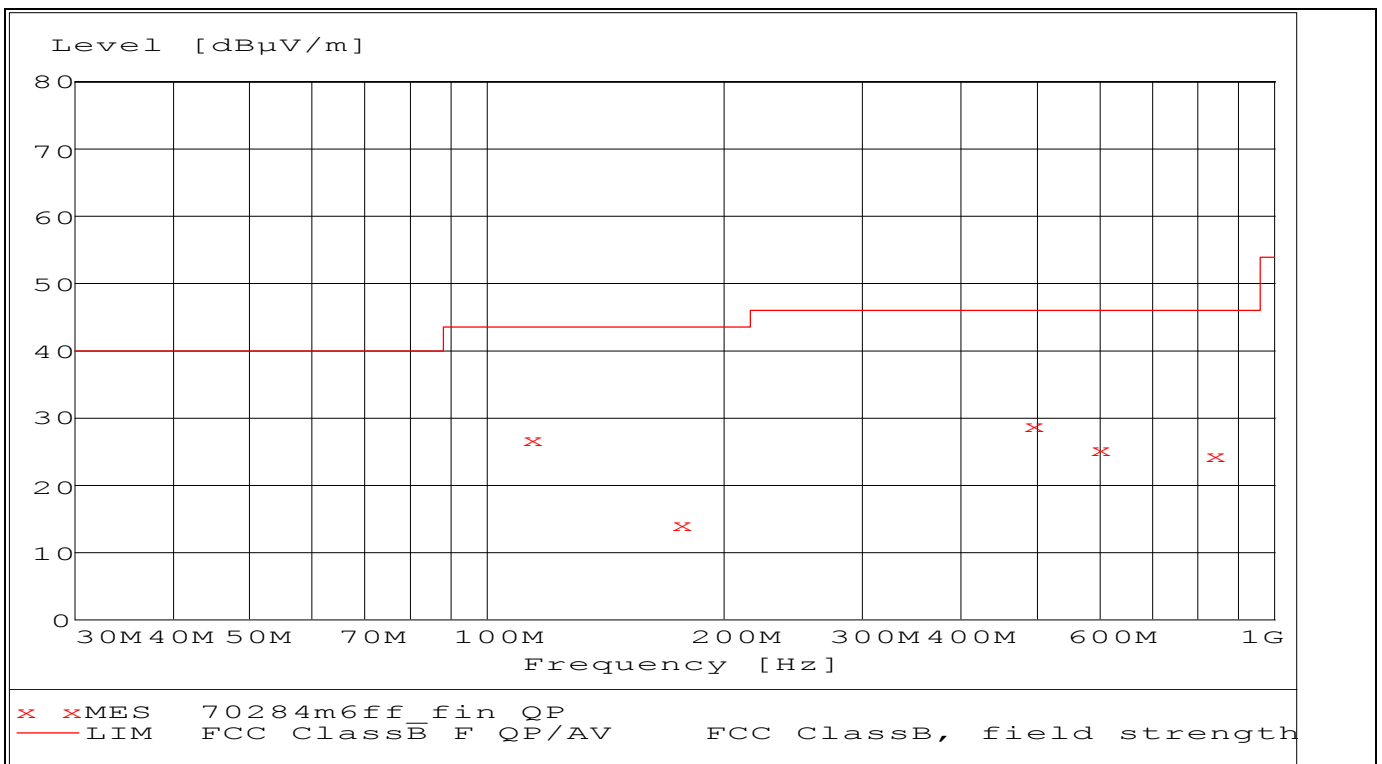

Data record name: 70284m6ff

The results of the standard subsequent measurement on the open area test site are indicated in the table below. The limits as well as the measured results (levels) refer to the above mentioned standard while taking account of the specified requirements for a 3 m measuring distance.

TEST REPORT REFERENCE: R70284_A Edition 1

Result measured with the quasipeak detector:

(These values are marked in the above diagram by x)

These values are marked in the above diagram by x)

Spurious emissions outside restricted bands									
Frequency	Result	Limit	Margin	Readings	Antenna factor	Cable loss	Height	Azimuth	Pol.
MHz	dB μ V/m	dB μ V/m	dB	dB μ V	dB/m	dB	cm	deg	
176.954	14.50	43.5	29.0	3.3	9.7	1.5	100.0	337	Ver.
492.800	28.90	46.0	17.1	9.1	17.3	2.5	169.0	228	Hor.
600.391	25.30	46.0	20.7	3.3	19.2	2.8	132.0	228.0	Hor.
837.606	24.60	46.0	21.4	-1.3	22.7	3.2	100.0	228.0	Hor.
Spurious emissions in restricted bands									
Frequency	Result	Limit	Margin	Readings	Antenna factor	Cable loss	Height	Azimuth	Pol.
MHz	dB μ V/m	dB μ V/m	dB	dB μ V	dB/m	dB	cm	deg	
113.787	26.90	43.5	16.6	13.8	12.0	1.1	100.0	112.0	Ver.
Measurement uncertainty				+2.2 dB / -3.6 dB					

Test results:

The test results were calculated with the following formula:

$$\text{Result [dB}\mu\text{V/m]} = \text{reading [dB}\mu\text{V]} + \text{cable loss [dB]} + \text{antenna factor [dB/m]}$$

Test: Passed

TEST EQUIPMENT USED FOR THE TEST:
14 – 20

TEST REPORT REFERENCE: R70284_A Edition 1

5.6.2.4 PRELIMINARY MEASUREMENT INTERNAL ANTENNA (1 GHz to 25 GHz) b-mode

Ambient temperature	20 °C	Relative humidity	35 %
---------------------	-------	-------------------	------

- Position of EUT: The EUT was set-up on a non-conducting table of a height of 0.8 m. The distance between EUT and antenna was 3 m.
- Cable guide: The cable of the EUT was fixed on the non-conducting table. For further information of the cable guide refer to the pictures in annex A of this test report.
- Test record: All results are shown in the following.
- Supply voltage: During all measurements the EUT was supplied with 5.0 V DC via the carrier board.

Transmitter operates at the lower end of the assigned frequency band (operation mode 1)

70284_5.wmf (1 GHz to 4 GHz), operation mode 1:

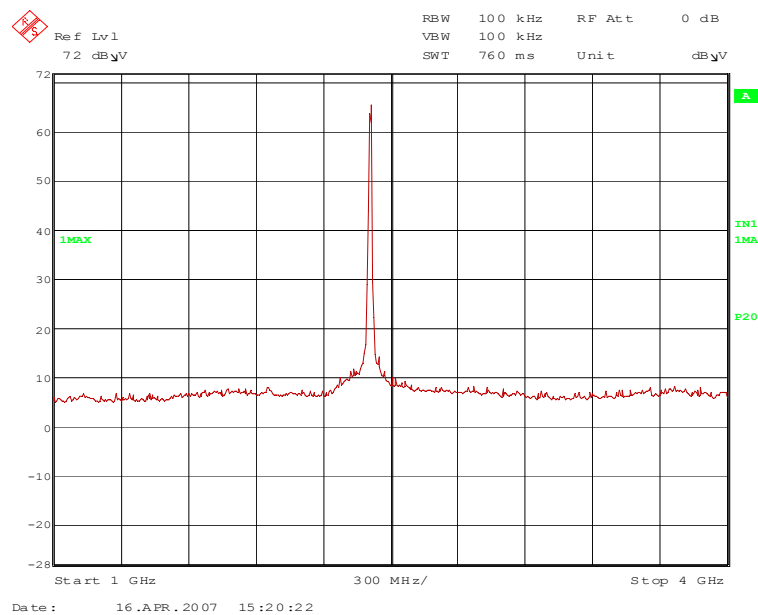

TEST REPORT REFERENCE: R70284_A Edition 1

70284_11.wmf (4 GHz to 12 GHz), operation mode 1:

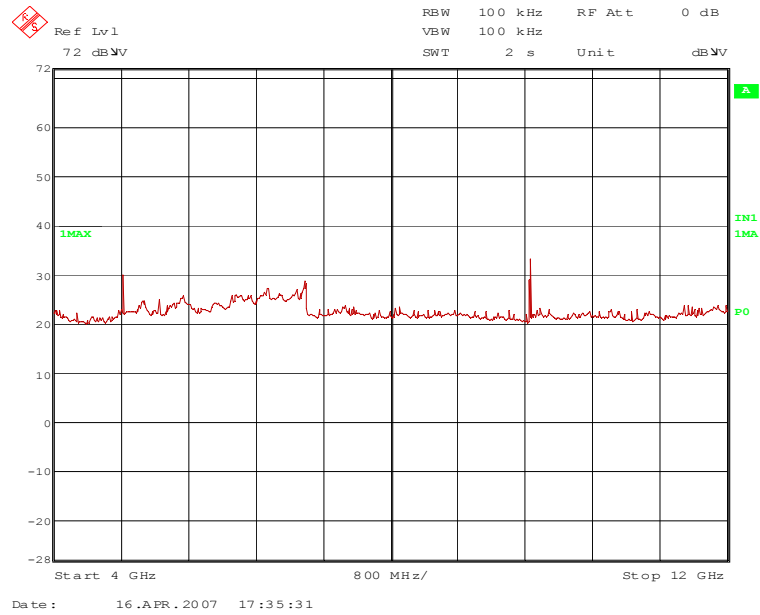

70284_19.wmf (12 GHz to 18 GHz), operation mode 1:

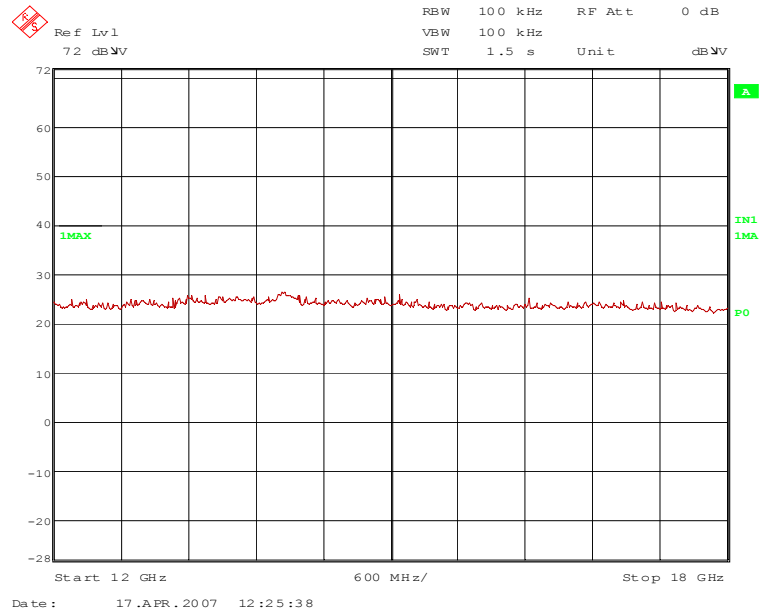

TEST REPORT REFERENCE: R70284_A Edition 1

70284_25.wmf (18 GHz to 25 GHz), operation mode 1:

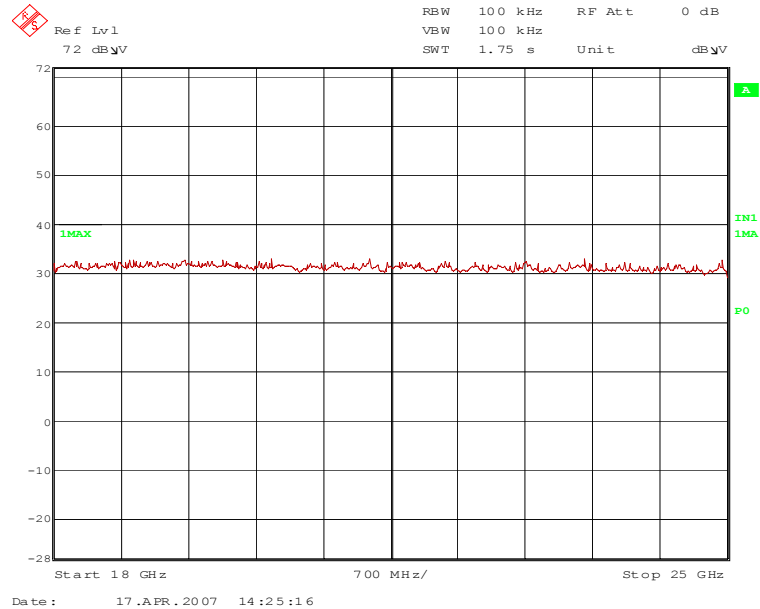

The following frequency was found inside the restricted bands during the preliminary radiated emission test:

- 4.824 GHz.

The following frequencies were found outside the restricted bands during the preliminary radiated emission test:

- 2.412 GHz and 9.648 GHz.

These frequencies have to be measured in a final measurement. The results were presented in the following.

TEST REPORT REFERENCE: R70284_A Edition 1

Transmitter operates at the middle of the assigned frequency band (operation mode 2)

70284_6.wmf (1 GHz to 4 GHz), operation mode 2:

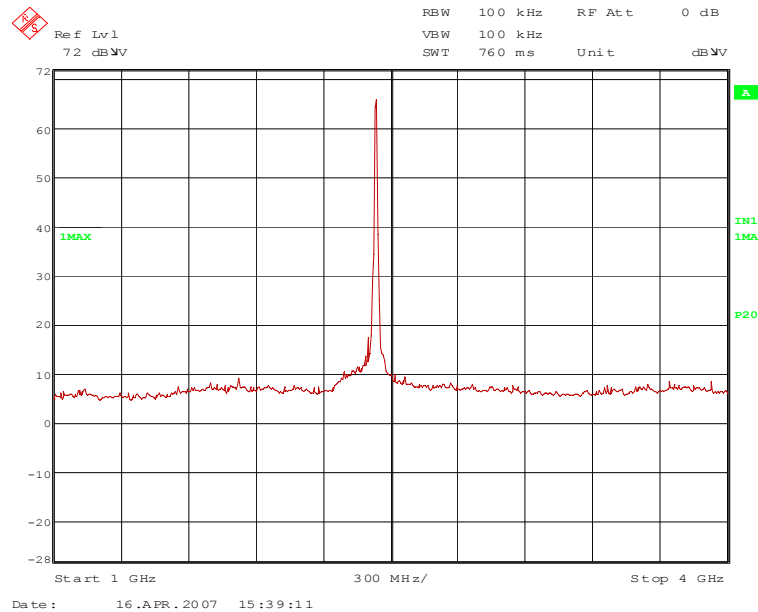

70284_12.wmf (4 GHz to 12 GHz), operation mode 2:

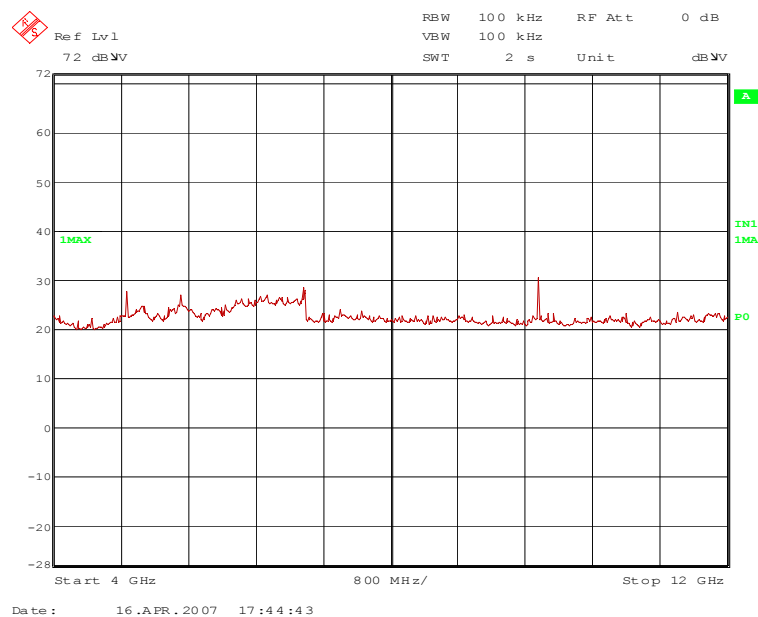

TEST REPORT REFERENCE: R70284_A Edition 1

70284_20.wmf (12 GHz to 18 GHz), operation mode 2:

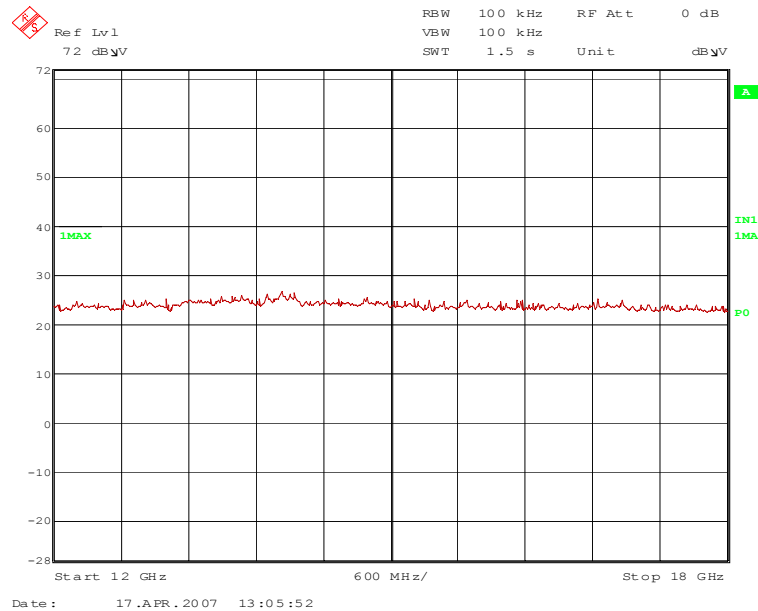

70284_26.wmf (18 GHz to 25 GHz), operation mode 2:

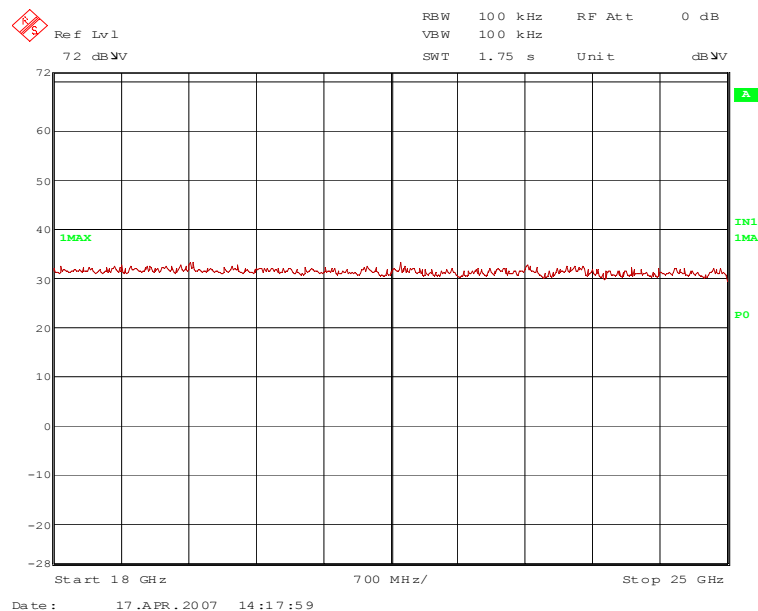

The following frequency was found inside the restricted bands during the preliminary radiated emission test:

- 4.874 GHz.

The following frequencies were found outside the restricted bands during the preliminary radiated emission test:

- 2.437 GHz and 9.748 GHz.

These frequencies have to be measured in a final measurement. The results were presented in the following.

TEST REPORT REFERENCE: R70284_A Edition 1

Transmitter operates at the upper end of the assigned frequency band (operation mode 3)

70284_7.wmf (1 GHz to 4 GHz), operation mode 3:

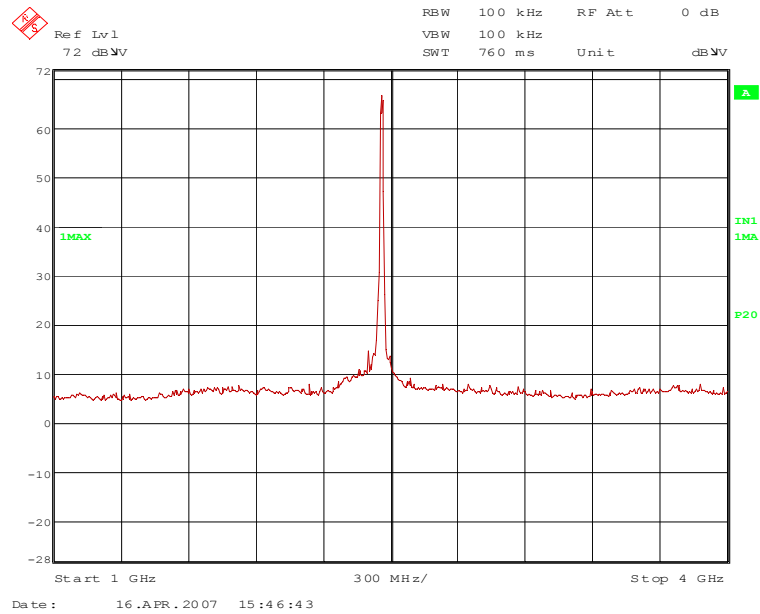

70284_13.wmf (4 GHz to 12 GHz), operation mode 3:

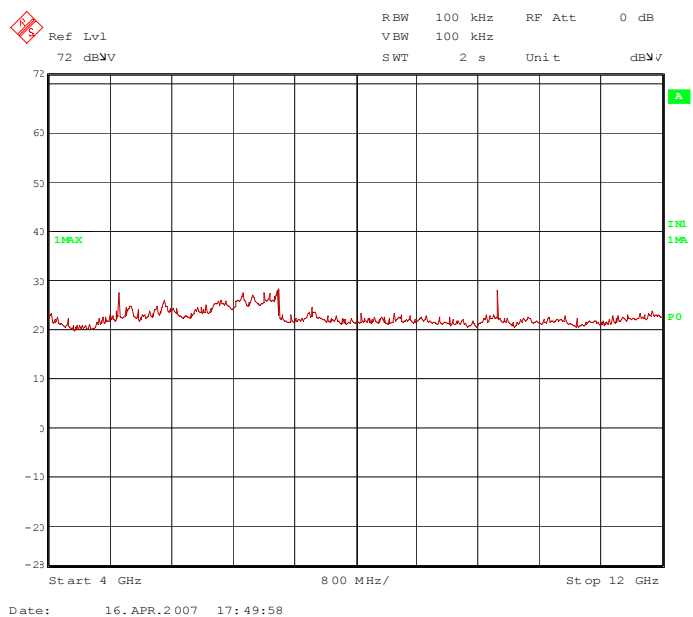

TEST REPORT REFERENCE: R70284_A Edition 1

5.6.2.5 FINAL MEASUREMENT INTERNAL ANTENNA (1 GHz to 25 GHz) b mode

Ambient temperature	20 °C	Relative humidity	35 %
---------------------	-------	-------------------	------

Position of EUT: The EUT was set-up on a non-conducting table of a height of 0.8 m. The distance between EUT and antenna was 3 m.

Cable guide: The cables of the EUT were fixed on the non-conducting table. For further information of the cable guide refer to the pictures in annex A of this test report.

Supply voltage: During all measurements the EUT was supplied with 5.0 V DC via the carrier board.

Resolution bandwidth: For all measurements a resolution bandwidth of 1 MHz was used.

Transmitter operates at the lower end of the assigned frequency band (operation mode 1)

Result measured with the peak detector:

Frequency GHz	Corr. value dB μ V/m	Limit dB μ V/m	Margin dB	Readings dB μ V	Antenna factor 1/m	Preamp dB	Cable loss dB	Height cm	Pol.	Restr. Band
2.412	102.0	-	-	70.7	28.5	0.0	2.8	150	Hor.	-
4.824	47.2	74.0	26.8	36.0	33.1	25.7	3.8	150	Hor.	Yes
9.648	58.3	82.0	23.7	38.6	37.9	23.9	5.7	150	Hor.	No
Measurement uncertainty							+2.2 dB / -3.6 dB			

Result measured with the average detector:

Frequency GHz	Corr. value dB μ V/m	Limit dB μ V/m	Margin dB	Readings dB μ V	Antenna factor 1/m	Preamp dB	Cable loss dB	Height cm	Pol.	Restr. Band
2.412	92.5	-	-	64	28.7	0.0	2.8	150	Hor.	-
4.824	39.4	54.0	14.6	27.9	33.4	25.7	3.8	150	Hor.	Yes
9.648	54.6	72.5	17.9	34.9	37.9	23.9	5.7	150	Hor.	No
Measurement uncertainty							+2.2 dB / -3.6 dB			

TEST REPORT REFERENCE: R70284_A Edition 1

Transmitter operates at the middle of the assigned frequency band (operation mode 2)

Result measured with the peak detector:

Frequency GHz	Corr. value dB μ V/m	Limit dB μ V/m	Margin dB	Readings dB μ V	Antenna factor 1/m	Preamp dB	Cable loss dB	Height cm	Pol.	Restr. Band
2.437	103.3	-	-	71.8	28.7	0	2.8	150	Hor.	-
4.874	48.2	74.0	25.8	36.7	33.4	25.7	3.8	150	Hor.	Yes
9.748	57.2	83.3	26.1	37.5	37.9	23.9	5.7	150	Hor.	No
Measurement uncertainty						+2.2 dB / -3.6 dB				

Result measured with the average detector:

Frequency GHz	Corr. value dB μ V/m	Limit dB μ V/m	Margin dB	Readings dB μ V	Antenna factor 1/m	Preamp dB	Cable loss dB	Height cm	Pol.	Restr. Band
2.437	92.5	-	-	65	28.7	0	2.8	150	Hor.	-
4.874	38.8	54.0	15.2	27.3	33.4	25.7	3.8	150	Hor.	Yes
9.748	52.4	72.5	20.1	32.7	37.9	23.9	5.7	150	Hor.	No
Measurement uncertainty						+2.2 dB / -3.6 dB				

TEST REPORT REFERENCE: R70284_A Edition 1

Transmitter operates at the upper end of the assigned frequency band (operation mode 3)

Result measured with the peak detector:

Frequency GHz	Corr. value dB μ V/m	Limit dB μ V/m	Margin dB	Readings dB μ V	Antenna factor 1/m	Preamp dB	Cable loss dB	Height cm	Pol.	Restr. Band
2.462	104.4	-	-	72.9	28.7	0	2.8	150	Hor.	-
4.924	46.7	74.0	27.3	35	33.5	25.6	3.8	150	Hor.	Yes
9.848	54.4	84.4	30.0	34.7	37.9	23.9	5.7	150	Hor.	No
Measurement uncertainty							+2.2 dB / -3.6 dB			

Result measured with the average detector:

Frequency GHz	Corr. value dB μ V/m	Limit dB μ V/m	Margin dB	Readings dB μ V	Antenna factor 1/m	Preamp dB	Cable loss dB	Height cm	Pol.	Restr. Band
2.462	92.5	-	-	66.2	28.7	0	2.8	150	Hor.	-
4.924	38.1	54.0	15.9	26.4	33.5	25.6	3.8	150	Hor.	Yes
9.848	46.9	72.5	25.6	27.2	37.9	23.9	5.7	150	Hor.	No
Measurement uncertainty							+2.2 dB / -3.6 dB			

Test: Passed

TEST EQUIPMENT USED FOR THE TEST:

29, 31 – 37, 39, 43, 46, 49 – 51, 54

TEST REPORT REFERENCE: R70284_A Edition 1

5.6.2.6 PRELIMINARY MEASUREMENT INTERNAL ANTENNA (1 GHz to 25 GHz) g-mode

Ambient temperature	20 °C	Relative humidity	35 %
---------------------	-------	-------------------	------

- Position of EUT: The EUT was set-up on a non-conducting table of a height of 0.8 m. The distance between EUT and antenna was 3 m.
- Cable guide: The cables of the EUT were fixed on the non-conducting table. For further information of the cable guide refer to the pictures in annex A of this test report.
- Test record: All results are shown in the following.
- Supply voltage: During all measurements the EUT was supplied with 5.0 V DC via the carrier board.

Transmitter operates at the lower end of the assigned frequency band (operation mode 4)

70284_8.wmf (1 GHz to 4 GHz), operation mode 4:

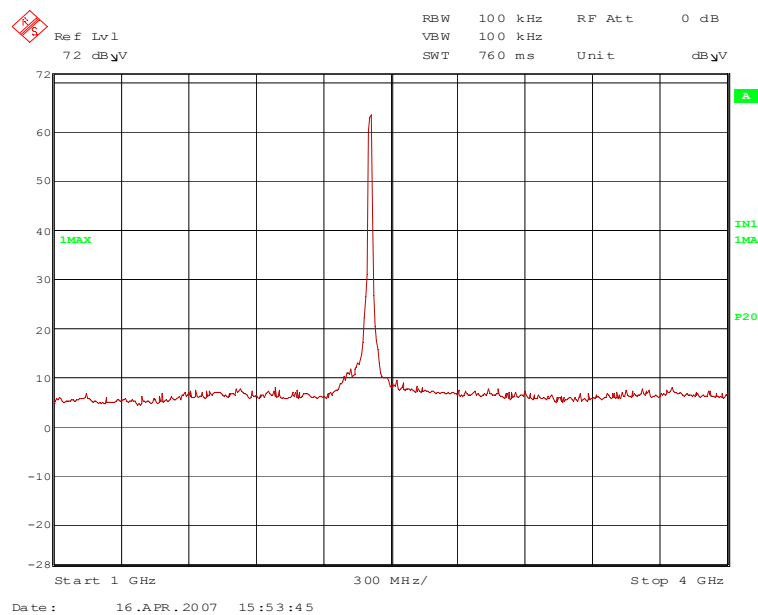

TEST REPORT REFERENCE: R70284_A Edition 1

70284_28.wmf (18 GHz to 25 GHz), operation mode 4:

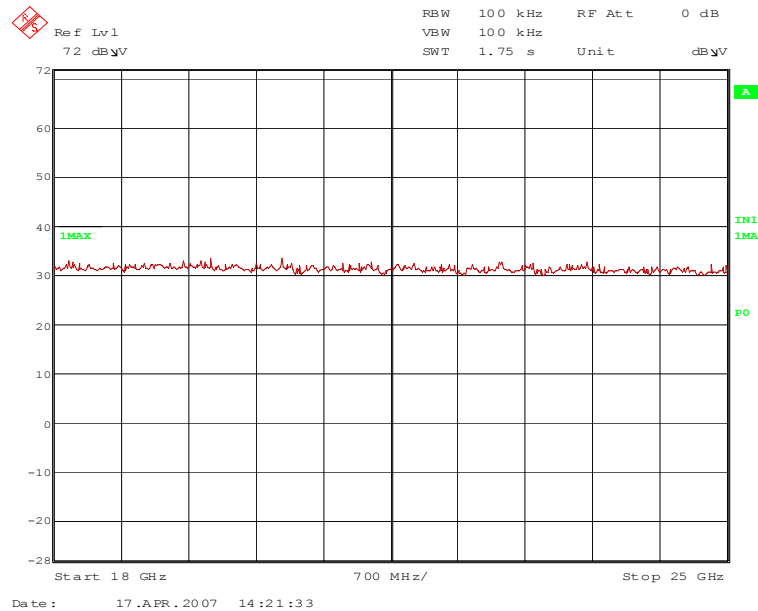

The following frequency was found inside the restricted bands during the preliminary radiated emission test:

- 4.824 GHz.

The following frequencies were found outside the restricted bands during the preliminary radiated emission test:

- 2.412 GHz and 9.648 GHz.

These frequencies have to be measured in a final measurement. The results were presented in the following.

TEST REPORT REFERENCE: R70284_A Edition 1

Transmitter operates at the middle of the assigned frequency band (operation mode 5)

70284_9.wmf (1 GHz to 4 GHz), operation mode 5:

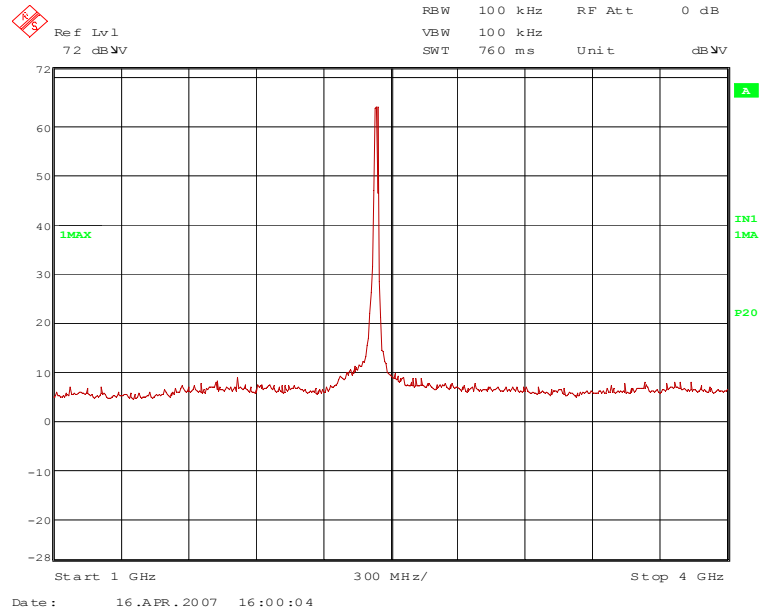

70284_15.wmf (4 GHz to 12 GHz), operation mode 5:

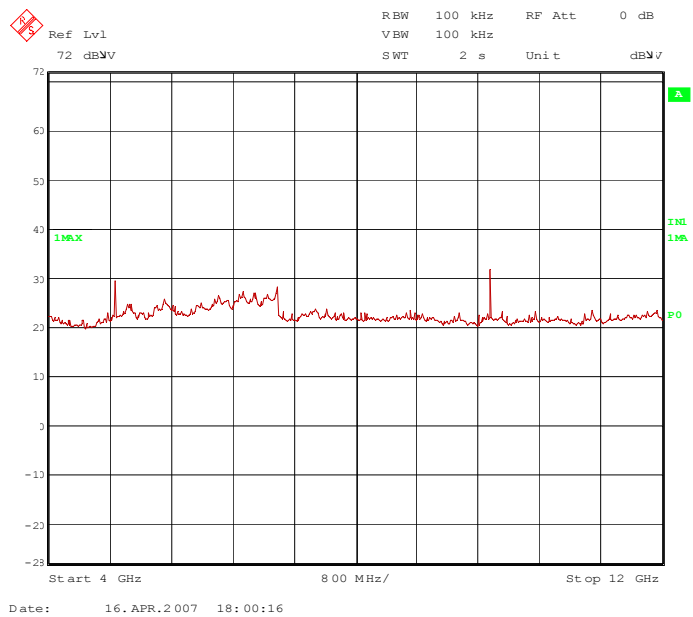

TEST REPORT REFERENCE: R70284_A Edition 1

70284_23.wmf (12 GHz to 18 GHz), operation mode 5:

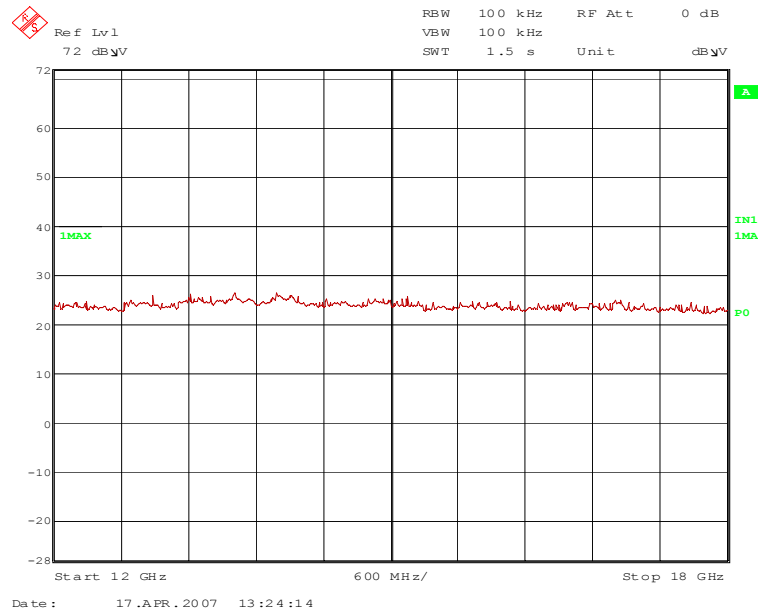

70284_29.wmf (18 GHz to 25 GHz), operation mode 5:

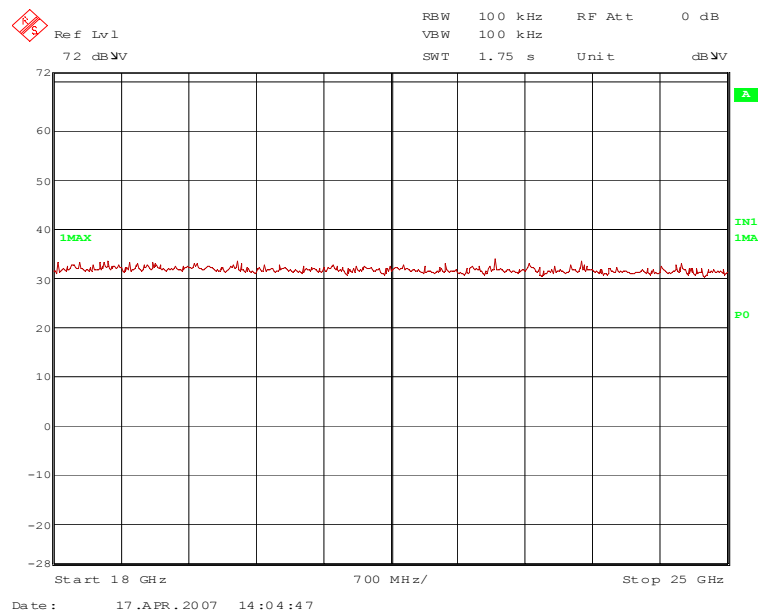

The following frequencies were found inside the restricted bands during the preliminary radiated emission test:

- 4.874 GHz.

The following frequencies were found outside the restricted bands during the preliminary radiated emission test:

- 2.437 GHz and 9.748 GHz.

These frequencies have to be measured in a final measurement. The results were presented in the following.

TEST REPORT REFERENCE: R70284_A Edition 1

Transmitter operates at the upper end of the assigned frequency band (operation mode 6)

70284_10.wmf (1 GHz to 4 GHz), operation mode 6:

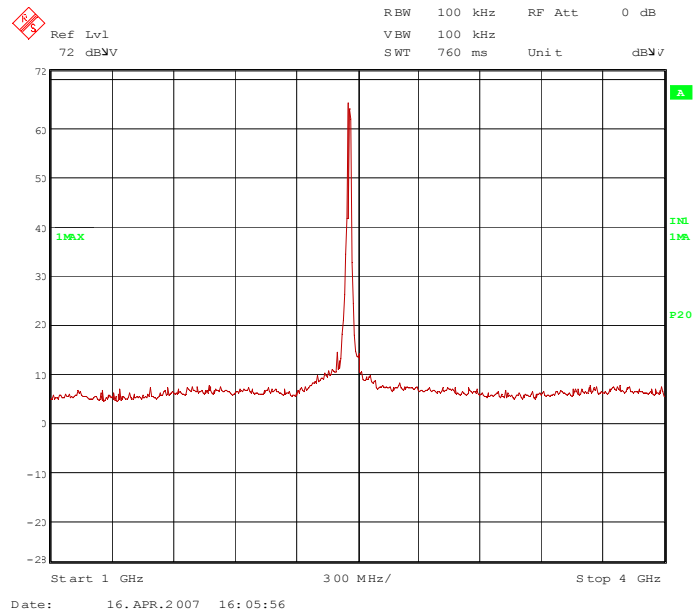

70284_16.wmf (4 GHz to 12 GHz), operation mode 6:

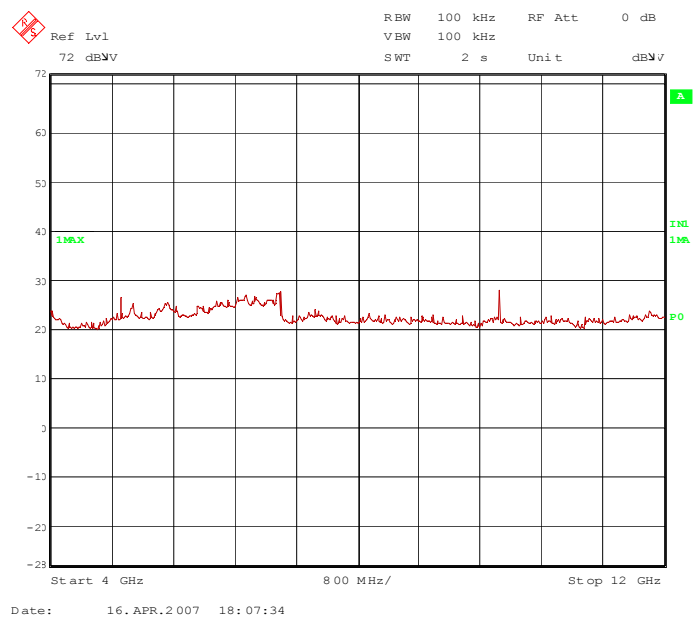

TEST REPORT REFERENCE: R70284_A Edition 1

70284_24.wmf (12 GHz to 18 GHz), operation mode 6:

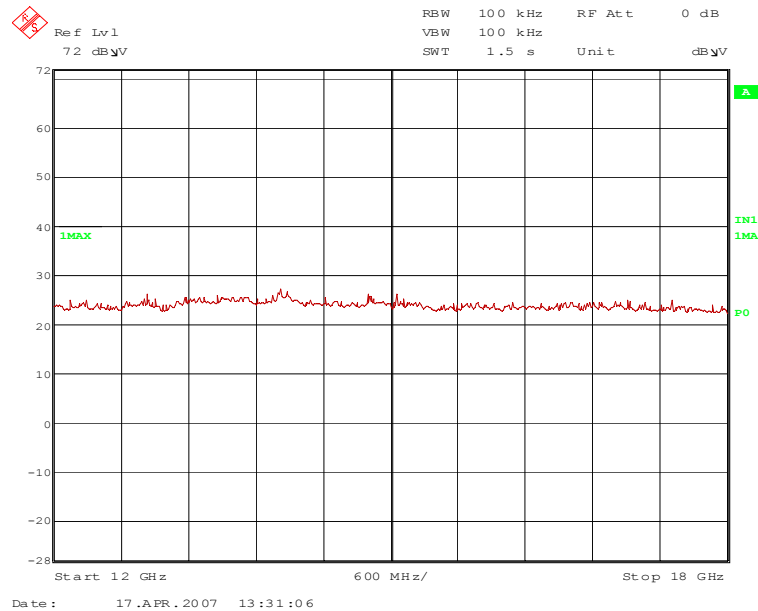

70284_30.wmf (18 GHz to 25 GHz), operation mode 6:

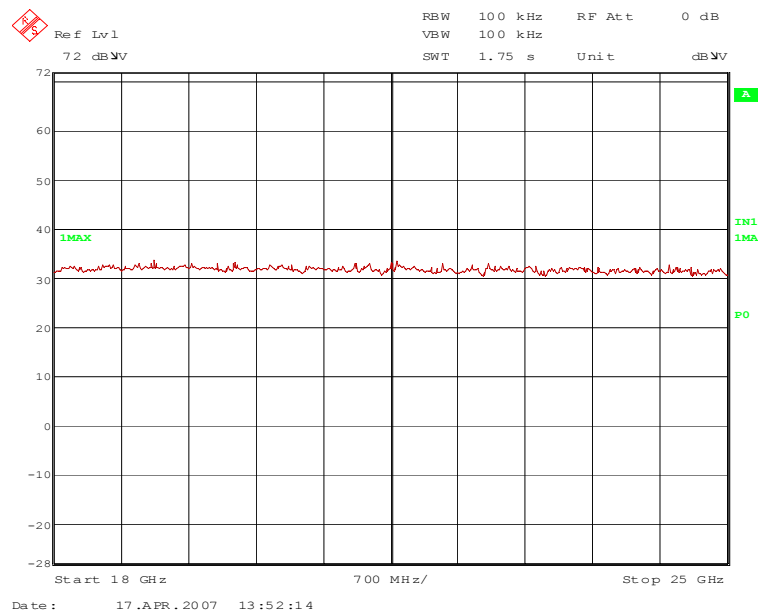

The following frequencies were found inside the restricted bands during the preliminary radiated emission test:

- 4.924 GHz.

The following frequencies were found outside the restricted bands during the preliminary radiated emission test:

- 2.462 GHz and 9.848 GHz.

These frequencies have to be measured in a final measurement. The results were presented in the following.

TEST REPORT REFERENCE: R70284_A Edition 1

5.6.2.7 FINAL MEASUREMENT INTERNAL ANTENNA (1 GHz to 25 GHz) g- mode

Ambient temperature	20 °C	Relative humidity	35 %
---------------------	-------	-------------------	------

Position of EUT: The EUT was set-up on a non-conducting table of a height of 0.8 m. The distance between EUT and antenna was 3 m.

Cable guide: The cables of the EUT were fixed on the non-conducting table. For further information of the cable guide refer to the pictures in annex A of this test report.

Supply voltage: During all measurements the EUT was supplied with 5.0 V DC via the carrier board.

Resolution bandwidth: For all measurements a resolution bandwidth of 1 MHz was used.

Transmitter operates at the lower end of the assigned frequency band (operation mode 4)

Result measured with the peak detector:

Frequency GHz	Corr. value dB μ V/m	Limit dB μ V/m	Margin dB	Readings dB μ V	Antenna factor 1/m	Preamp dB	Cable loss dB	Height cm	Pol.	Restr. Band
2.412	103.7	-	-	72.4	28.5	0	2.8	150	Hor.	-
4.824	46.6	74.0	27.4	35.4	33.1	25.7	3.8	150	Hor.	Yes
9.648	57.9	83.7	25.8	38.2	37.9	23.9	5.7	150	Hor.	No
Measurement uncertainty							+2.2 dB / -3.6 dB			

Result measured with the average detector:

Frequency GHz	Corr. value dB μ V/m	Limit dB μ V/m	Margin dB	Readings dB μ V	Antenna factor 1/m	Preamp dB	Cable loss dB	Height cm	Pol.	Restr. Band
2.412	92.5	-	-	62.1	28.5	0	2.8	150	Hor.	-
4.824	39.8	54.0	14.2	28.6	33.1	25.7	3.8	150	Hor.	Yes
9.648	54.3	72.5	18.2	34.6	37.9	23.9	5.7	150	Hor.	No
Measurement uncertainty							+2.2 dB / -3.6 dB			

TEST REPORT REFERENCE: R70284_A Edition 1

Transmitter operates at the middle of the assigned frequency band (operation mode 5)

Result measured with the peak detector:

Frequency GHz	Corr. value dB μ V/m	Limit dB μ V/m	Margin dB	Readings dB μ V	Antenna factor 1/m	Preamp dB	Cable loss dB	Height cm	Pol.	Restr. Band
2.437	102.5	-	-	71	28.7	0	2.8	150	Hor.	-
4.874	47.6	74.0	26.4	36.1	33.4	25.7	3.8	150	Hor.	Yes
9.748	57.2	82.5	25.3	37.5	37.9	23.9	5.7	150	Hor.	No
Measurement uncertainty							+2.2 dB / -3.6 dB			

Result measured with the average detector:

Frequency GHz	Corr. value dB μ V/m	Limit dB μ V/m	Margin dB	Readings dB μ V	Antenna factor 1/m	Preamp dB	Cable loss dB	Height cm	Pol.	Restr. Band
2.437	92.5	-	-	62.4	28.7	0	2.8	150	Hor.	-
4.874	39.7	54.0	14.3	28.2	33.4	25.7	3.8	150	Hor.	Yes
9.748	52.4	72.5	20.1	32.7	37.9	23.9	5.7	150	Hor.	No
Measurement uncertainty							+2.2 dB / -3.6 dB			

TEST REPORT REFERENCE: R70284_A Edition 1

Transmitter operates at the upper end of the assigned frequency band (operation mode 6)

Result measured with the peak detector:

Frequency GHz	Corr. value dB μ V/m	Limit dB μ V/m	Margin dB	Readings dB μ V	Antenna factor 1/m	Preamp dB	Cable loss dB	Height cm	Pol.	Restr. Band
2.462	103.5	-	-	72	28.7	0	2.8	150	Hor.	-
4.924	46.9	74.0	27.1	35.2	33.5	25.6	3.8	150	Hor.	Yes
9.848	54.7	83.5	28.8	35	37.9	23.9	5.7	150	Hor.	No
Measurement uncertainty							+2.2 dB / -3.6 dB			

Result measured with the average detector:

Frequency GHz	Corr. value dB μ V/m	Limit dB μ V/m	Margin dB	Readings dB μ V	Antenna factor 1/m	Preamp dB	Cable loss dB	Height cm	Pol.	Restr. Band
2.462	92.5	-	-	63.4	28.7	0	2.8	150	Hor.	-
4.924	37.9	54.0	16.1	26.2	33.5	25.6	3.8	150	Hor.	Yes
9.848	47.3	72.5	25.2	27.6	37.9	23.9	5.7	150	Hor.	No
Measurement uncertainty							+2.2 dB / -3.6 dB			

Test: Passed

TEST EQUIPMENT USED FOR THE TEST:

29, 31 – 37, 39, 43, 46, 49 – 51, 54

TEST REPORT REFERENCE: R70284_A Edition 1

5.6.2.8 PRELIMINARY MEASUREMENT EXTERNAL PATCH ANTENNA (1 GHz to 25 GHz) b-mode

Ambient temperature	21 °C	Relative humidity	39 %
---------------------	-------	-------------------	------

- Position of EUT: The EUT was set-up on a non-conducting table of a height of 0.8 m. The distance between EUT and antenna was 3 m.
- Cable guide: The cables of the EUT were fixed on the non-conducting table. For further information of the cable guide refer to the pictures in annex A of this test report.
- Test record: All results are shown in the following.
- Supply voltage: During all measurements the EUT was supplied with 5.0 V DC via the carrier board.
- Remark: As external antenna the SPA 2400/75/8/0/V with a 50 cm antenna was used, because of the highest gain of this antenna type. Additionally pre-tests have shown that this antenna and this antenna cable caused the highest spurious emissions of all patch antennas.

Transmitter operates at the lower end of the assigned frequency band (operation mode 1)

70284_43.wmf (1 GHz to 4 GHz), operation mode 1:

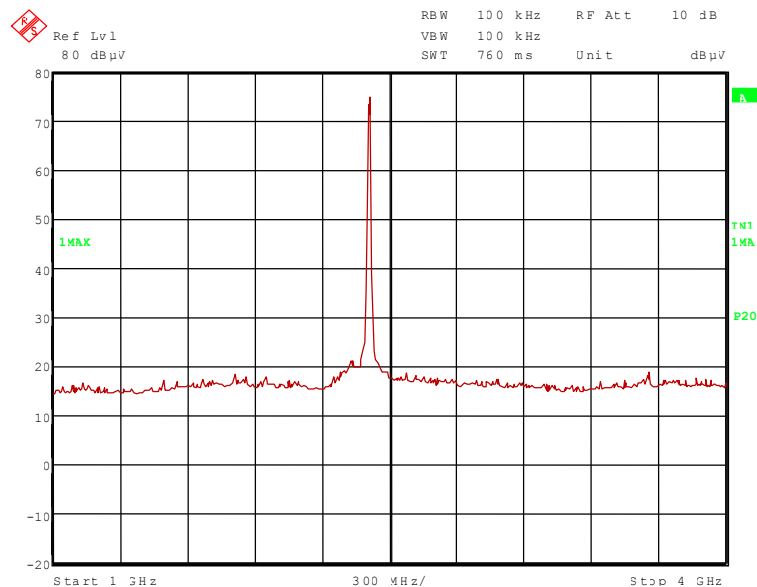

TEST REPORT REFERENCE: R70284_A Edition 1

70284_49.wmf (4 GHz to 12 GHz), operation mode 1:

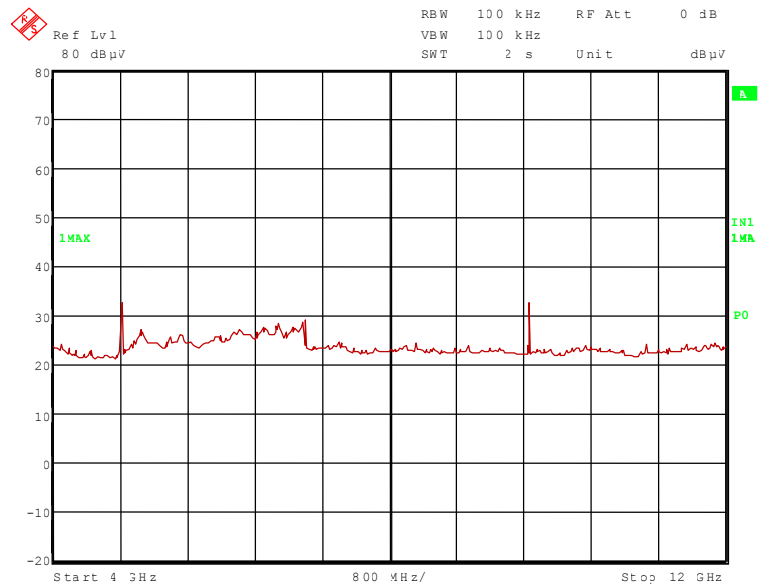

70284_88.wmf (12 GHz to 18 GHz), operation mode 1:

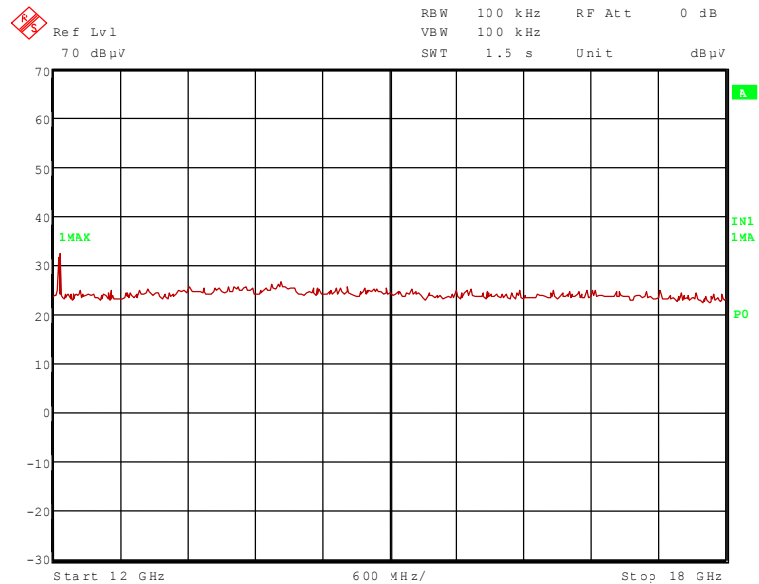

TEST REPORT REFERENCE: R70284_A Edition 1

70284_99.wmf (18 GHz to 25 GHz), operation mode 1:

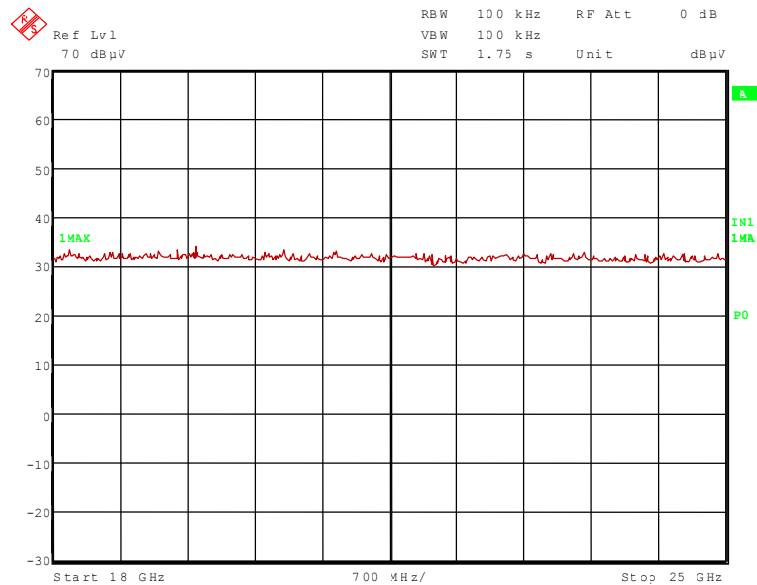

The following frequency was found inside the restricted bands during the preliminary radiated emission test:

- 2.343 GHz, 4.824 GHz and 12.060 GHz.

The following frequencies were found outside the restricted bands during the preliminary radiated emission test:

- 2.412 GHz and 9.648 GHz.

These frequencies have to be measured in a final measurement. The results were presented in the following.

TEST REPORT REFERENCE: R70284_A Edition 1

70284_89.wmf (12 GHz to 18 GHz), operation mode 2:

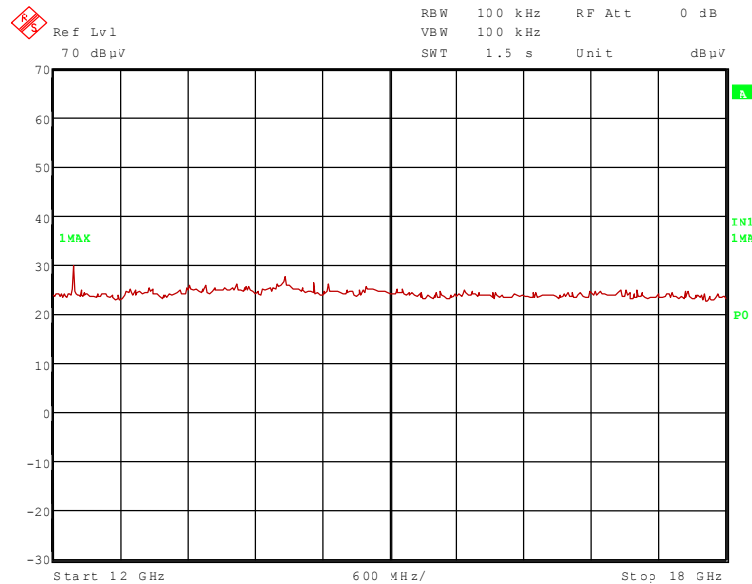

70284_98.wmf (18 GHz to 25 GHz), operation mode 2:

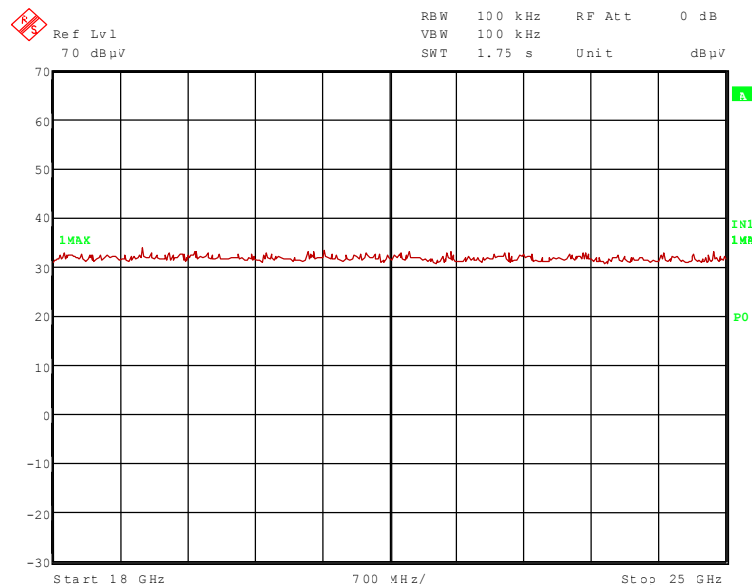

The following frequency was found inside the restricted bands during the preliminary radiated emission test:

- 4.874 GHz and 12.185 GHz.

The following frequencies were found outside the restricted bands during the preliminary radiated emission test:

- 2.400 GHz, 2.437 GHz and 9.748 GHz.

These frequencies have to be measured in a final measurement. The results were presented in the following.

TEST REPORT REFERENCE: R70284_A Edition 1

70284_90.wmf (12 GHz to 18 GHz), operation mode 3:

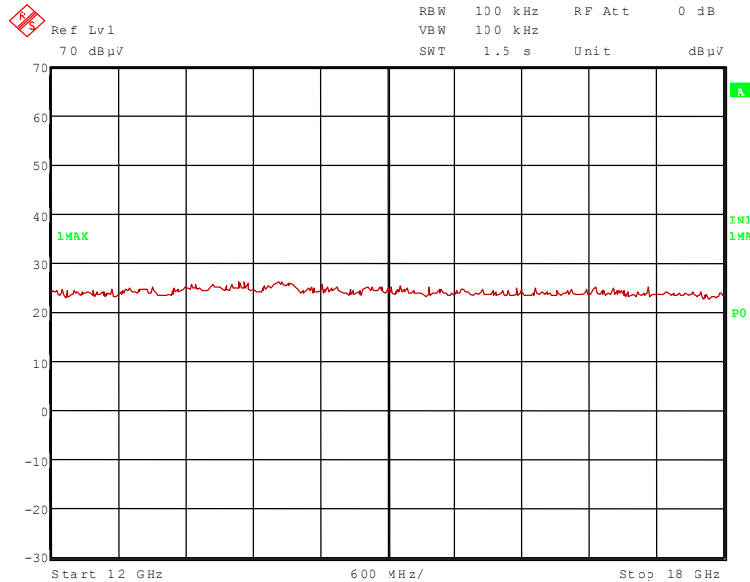

70284_97.wmf (18 GHz to 25 GHz), operation mode 3:

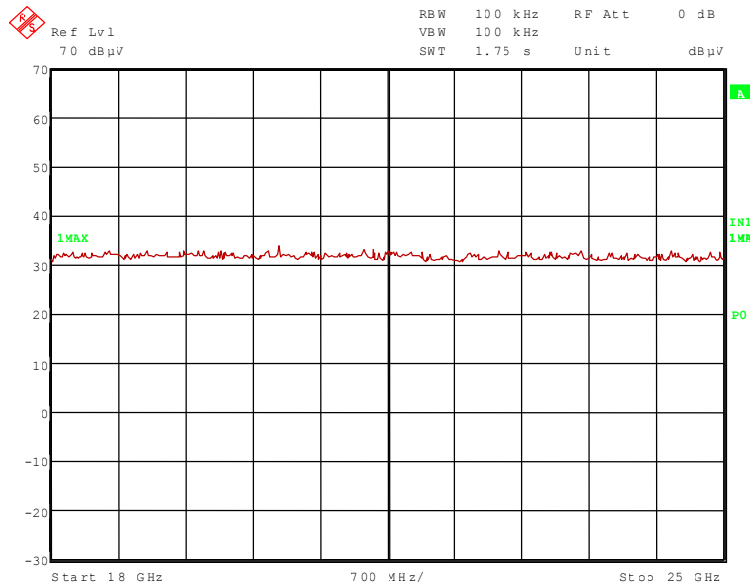

The following frequency was found inside the restricted bands during the preliminary radiated emission test:

- 4.924 GHz.

The following frequencies were found outside the restricted bands during the preliminary radiated emission test:

- 2.400 GHz, 2.462 GHz and 9.848 GHz.

These frequencies have to be measured in a final measurement. The results were presented in the following.

TEST REPORT REFERENCE: R70284_A Edition 1

5.6.2.9 FINAL MEASUREMENT EXTERNAL PATCH ANTENNA (1 GHz to 25 GHz) b-mode

Ambient temperature	21 °C	Relative humidity	39 %
---------------------	-------	-------------------	------

- Position of EUT: The EUT was set-up on a non-conducting table of a height of 0.8 m. The distance between EUT and antenna was 3 m.
- Cable guide: The cables of the EUT were fixed on the non-conducting table. For further information of the cable guide refer to the pictures in annex A of this test report.
- Supply voltage: During all measurements the EUT was supplied with 5.0 V DC via the carrier board.
- Resolution bandwidth: For all measurements a resolution bandwidth of 1 MHz was used.
- Remark: As external antenna the SPA 2400/75/8/0/V with a 50 cm antenna was used, because of the highest gain of this antenna type. Additionally pre-tests have shown that this antenna and this antenna cable caused the highest spurious emissions of all patch antennas.

Transmitter operates at the lower end of the assigned frequency band (operation mode 1)

Result measured with the peak detector:

Frequency GHz	Corr. value dB μ V/m	Limit dB μ V/m	Margin dB	Readings dB μ V	Antenna factor 1/m	Preamp dB	Cable loss dB	Height cm	Pol.	Restr. Band
2.343	67.6	74.0	6.4	36.5	28.4	0.0	2.7	150	Vert.	Yes
2.412	111.8	-	-	80.5	28.5	0.0	2.8	150	Vert.	-
4.824	51.7	74.0	22.3	40.5	33.1	25.7	3.8	150	Hor.	Yes
9.648	57.4	91.8	34.4	37.7	37.9	23.9	5.7	150	Hor.	No
12.060	47.8	74.0	26.2	39.1	33.6	25.9	1.0	100	Vert.	Yes
Measurement uncertainty						+2.2 dB / -3.6 dB				

Result measured with the average detector:

Frequency GHz	Corr. value dB μ V/m	Limit dB μ V/m	Margin dB	Readings dB μ V	Antenna factor 1/m	Preamp dB	Cable loss dB	Height cm	Pol.	Restr. Band
2.343	46.5	54.0	7.5	15.4	28.4	0.0	2.7	150	Vert.	Yes
2.412	104.3	-	-	73.0	28.5	0.0	2.8	150	Vert.	-
4.824	44.3	54.0	9.7	32.8	33.1	25.7	3.8	150	Hor.	Yes
9.648	57.6	84.3	26.7	33.1	37.9	23.9	5.7	150	Hor.	No
12.060	36.7	54.0	17.3	28.0	33.6	25.9	1.0	100	Vert.	Yes
Measurement uncertainty						+2.2 dB / -3.6 dB				

TEST REPORT REFERENCE: R70284_A Edition 1

Transmitter operates at the middle of the assigned frequency band (operation mode 2)

Result measured with the peak detector:

Frequency GHz	Corr. value dB μ V/m	Limit dB μ V/m	Margin dB	Readings dB μ V	Antenna factor 1/m	Preamp dB	Cable loss dB	Height cm	Pol.	Restr. Band
2.400	70.3	92.5	22.2	39.0	28.5	0.0	2.8	150	Vert.	No
2.437	112.5	-	-	81.0	28.7	0.0	2.8	150	Vert.	-
4.874	50.6	74.0	23.4	39.1	33.4	25.7	3.8	150	Hor.	Yes
9.748	57.6	92.5	34.9	37.9	37.9	23.9	5.7	150	Hor.	No
12.185	47.5	74.0	26.5	38.7	33.6	25.8	1.0	100	Vert.	Yes
Measurement uncertainty						+2.2 dB / -3.6 dB				

Result measured with the average detector:

Frequency GHz	Corr. value dB μ V/m	Limit dB μ V/m	Margin dB	Readings dB μ V	Antenna factor 1/m	Preamp dB	Cable loss dB	Height cm	Pol.	Restr. Band
2.400	56.5	85.2	28.7	25.2	28.5	0.0	2.8	150	Vert.	No
2.437	105.2	-	-	73.7	28.7	0.0	2.8	150	Vert.	-
4.874	44.2	54.0	9.8	32.7	33.4	25.7	3.8	150	Hor.	Yes
9.748	52.2	85.2	33.0	32.5	37.9	23.9	5.7	150	Hor.	No
12.185	36.4	54.0	17.6	27.6	33.6	25.8	1.0	100	Vert.	Yes
Measurement uncertainty						+2.2 dB / -3.6 dB				

TEST REPORT REFERENCE: R70284_A Edition 1

Transmitter operates at the upper end of the assigned frequency band (operation mode 3)

Result measured with the peak detector:

Frequency GHz	Corr. value dB μ V/m	Limit dB μ V/m	Margin dB	Readings dB μ V	Antenna factor 1/m	Preamp dB	Cable loss dB	Height cm	Pol.	Restr. Band
2.400	64.3	92.4	28.1	33.0	28.5	0.0	2.8	150	Vert.	No
2.462	112.4	-	-	80.9	28.7	0.0	2.8	150	Vert.	-
4.924	49.7	74.0	24.3	39.1	32.4	25.6	3.8	150	Hor.	Yes
9.848	57.1	92.4	35.3	36.4	37.9	23.9	5.7	150	Hor.	No
Measurement uncertainty						+2.2 dB / -3.6 dB				

Result measured with the average detector:

Frequency GHz	Corr. value dB μ V/m	Limit dB μ V/m	Margin dB	Readings dB μ V	Antenna factor 1/m	Preamp dB	Cable loss dB	Height cm	Pol.	Restr. Band
2.400	53.3	85.0	31.7	22.0	28.5	0.0	2.8	150	Vert.	No
2.462	105.0	-	-	73.5	28.7	0.0	2.8	150	Vert.	-
4.924	43.5	54.0	10.5	32.9	32.4	25.6	3.8	150	Hor.	Yes
9.848	50.1	85.0	34.9	30.4	37.9	23.9	5.7	150	Hor.	No
Measurement uncertainty						+2.2 dB / -3.6 dB				

Test: Passed

TEST EQUIPMENT USED FOR THE TEST:

29, 31 – 37, 39, 43, 46, 49 – 51, 54

TEST REPORT REFERENCE: R70284_A Edition 1

5.6.2.10 PRELIMINARY MEASUREMENT EXTERNAL PATCH ANTENNA (1 GHz to 25 GHz) g-mode

Ambient temperature	21 °C	Relative humidity	39 %
---------------------	-------	-------------------	------

- Position of EUT: The EUT was set-up on a non-conducting table of a height of 0.8 m. The distance between EUT and antenna was 3 m.
- Cable guide: The cables of the EUT were fixed on the non-conducting table. For further information of the cable guide refer to the pictures in annex A of this test report.
- Test record: All results are shown in the following.
- Supply voltage: During all measurements the EUT was supplied with 5.0 V DC via the carrier board.
- Remark: As external antenna the SPA 2400/75/8/0/V with a 50 cm antenna was used, because of the highest gain of this antenna type. Additionally pre-tests have shown that this antenna and this antenna cable caused the highest spurious emissions of all patch antennas.

Transmitter operates at the lower end of the assigned frequency band (operation mode 4)

70284_48.wmf (1 GHz to 4 GHz), operation mode 4:

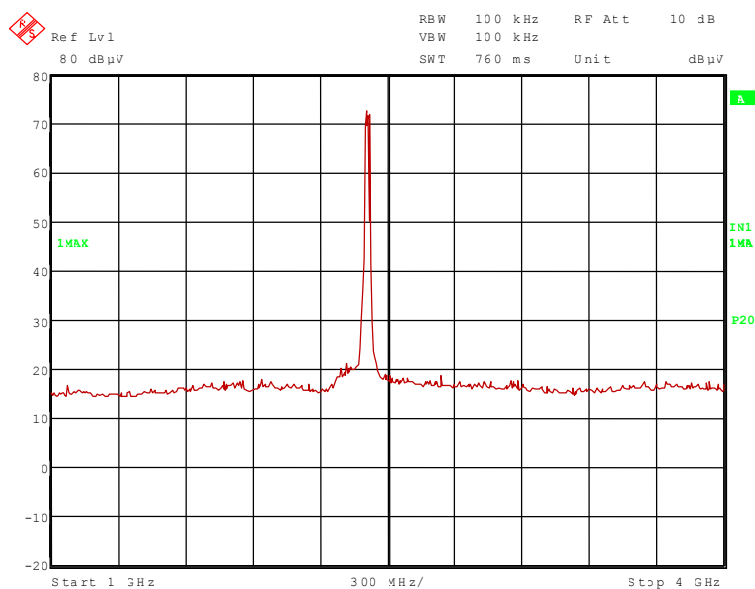

TEST REPORT REFERENCE: R70284_A Edition 1

7284_52.wmf (4 GHz to 12 GHz), operation mode 4:

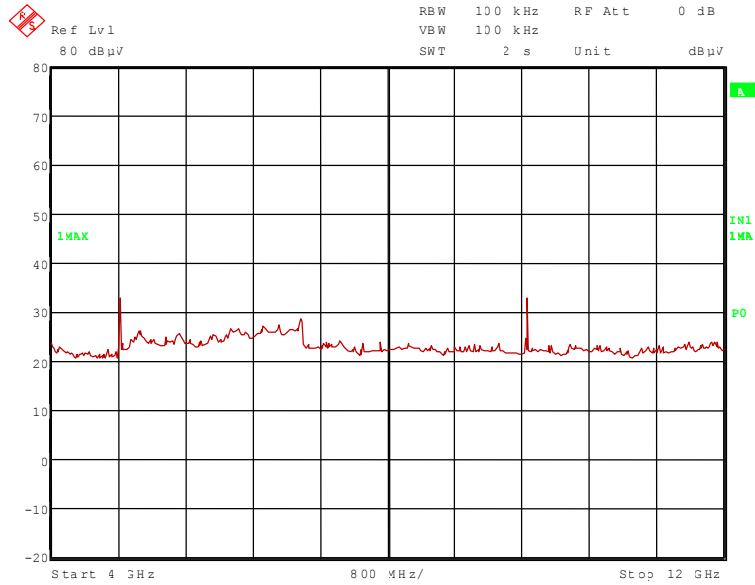

70284_91.wmf (12 GHz to 18 GHz), operation mode 4:

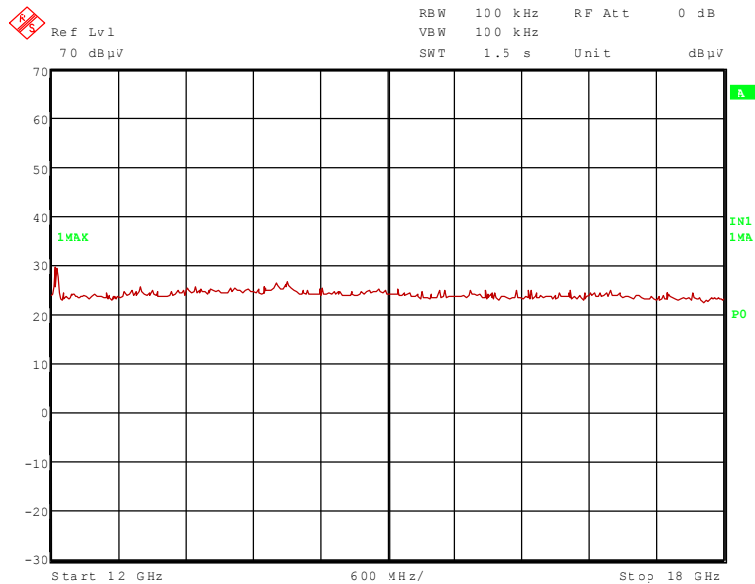

TEST REPORT REFERENCE: R70284_A Edition 1

70284_96.wmf (18 GHz to 25 GHz), operation mode 4:

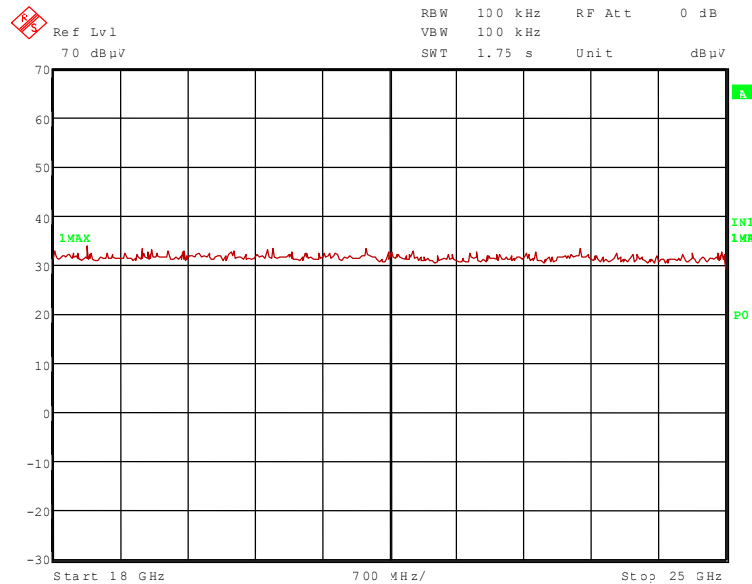

The following frequency was found inside the restricted bands during the preliminary radiated emission test:

- 2.343, 4.824 GHz and 12.060 GHz.

The following frequencies were found outside the restricted bands during the preliminary radiated emission test:

- 2.412 GHz and 9.648 GHz.

These frequencies have to be measured in a final measurement. The results were presented in the following.

TEST REPORT REFERENCE: R70284_A Edition 1

70284_92.wmf (12 GHz to 18 GHz), operation mode 5:

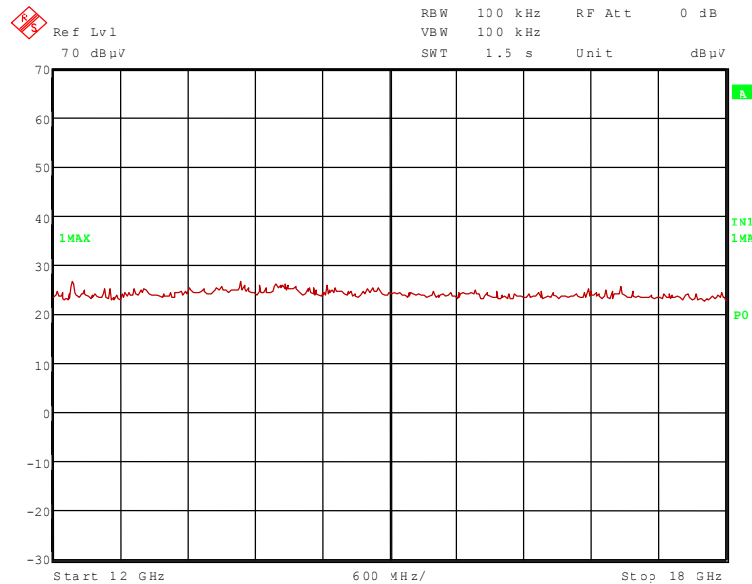

70284_95.wmf (18 GHz to 25 GHz), operation mode 5:

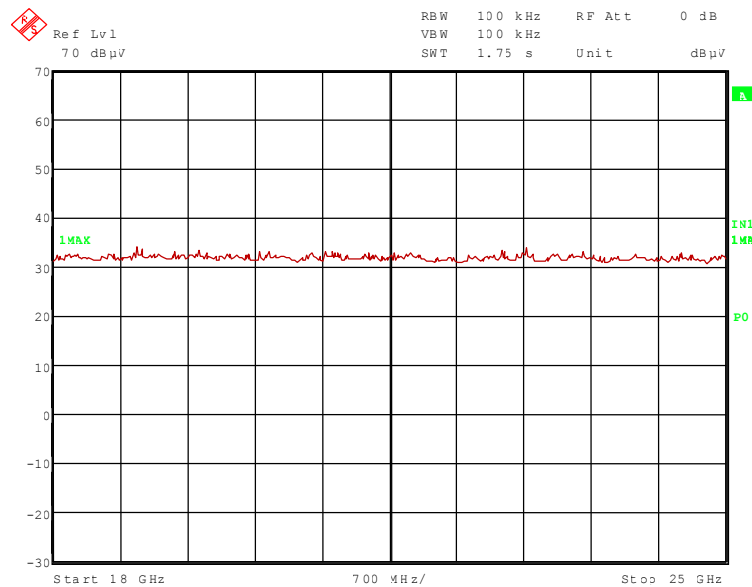

The following frequency was found inside the restricted bands during the preliminary radiated emission test:

- 4.874 GHz.

The following frequencies were found outside the restricted bands during the preliminary radiated emission test:

- 2.437 GHz and 9.748 GHz.

These frequencies have to be measured in a final measurement. The results were presented in the following.

TEST REPORT REFERENCE: R70284_A Edition 1

70284_93.wmf (12 GHz to 18 GHz), operation mode 6:

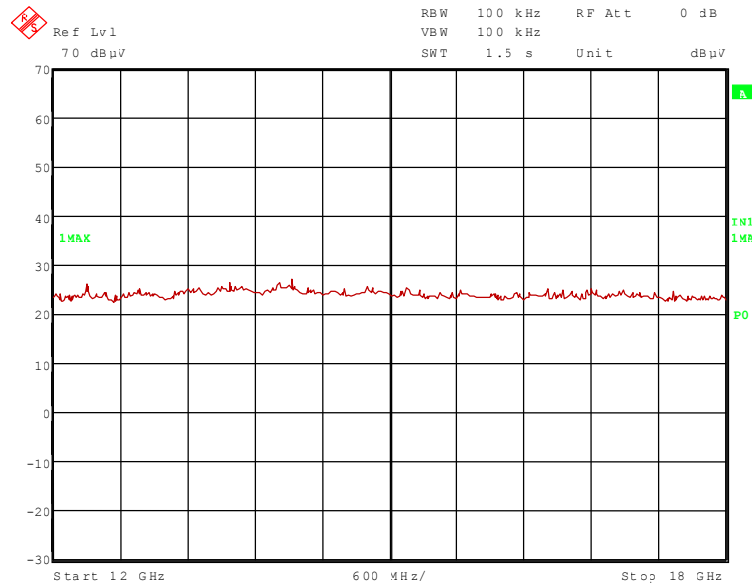

70284_94.wmf (18 GHz to 25 GHz), operation mode 6:

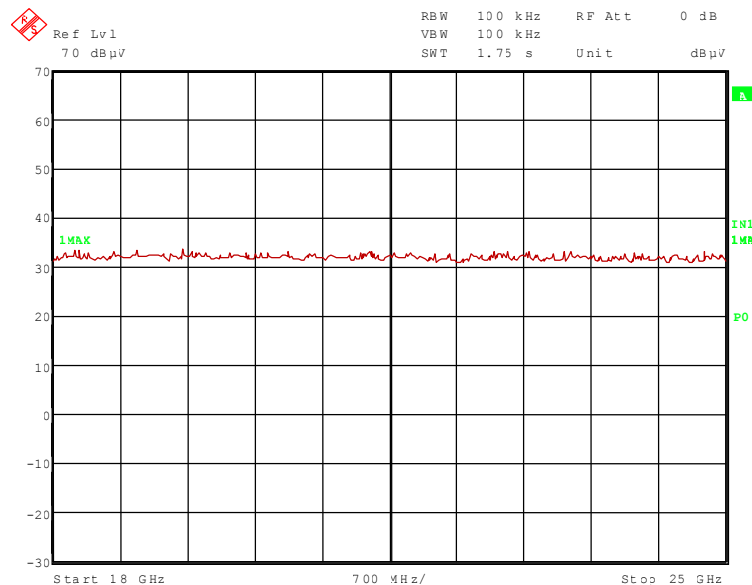

The following frequency was found inside the restricted bands during the preliminary radiated emission test:

- 4.924 GHz.

The following frequencies were found outside the restricted bands during the preliminary radiated emission test:

- 2.400 GHz, 2.462 GHz and 9.848 GHz.

These frequencies have to be measured in a final measurement. The results were presented in the following.

TEST REPORT REFERENCE: R70284_A Edition 1

5.6.2.11 FINAL MEASUREMENT EXTERNAL PATCH ANTENNA (1 GHz to 25 GHz) g-mode

Ambient temperature	21 °C	Relative humidity	39 %
---------------------	-------	-------------------	------

- Position of EUT: The EUT was set-up on a non-conducting table of a height of 0.8 m. The distance between EUT and antenna was 3 m.
- Cable guide: The cables of the EUT were fixed on the non-conducting table. For further information of the cable guide refer to the pictures in annex A of this test report.
- Supply voltage: During all measurements the EUT was supplied with 5.0 V DC via the carrier board.
- Resolution bandwidth: For all measurements a resolution bandwidth of 1 MHz was used.
- Remark: As external antenna the SPA 2400/75/8/0/V with a 50 cm antenna was used, because of the highest gain of this antenna type. Additionally pre-tests have shown that this antenna and this antenna cable caused the highest spurious emissions of all patch antennas.

Transmitter operates at the lower end of the assigned frequency band (operation mode 4)

Result measured with the peak detector:

Frequency GHz	Corr. value dB μ V/m	Limit dB μ V/m	Margin dB	Readings dB μ V	Antenna factor 1/m	Preamp dB	Cable loss dB	Height cm	Pol.	Restr. Band
2.343	67.6	74.0	6.4	36.5	28.4	0.0	2.7	150	Vert.	Yes
2.412	112.8	-	-	81.5	28.5	0.0	2.8	150	Vert.	-
4.824	74.0	74.0	23.9	38.9	33.1	25.7	3.8	150	Hor.	Yes
9.648	57.6	92.8	35.3	37.9	37.9	23.9	5.7	150	Hor.	No
12.060	49.3	74.0	24.7	40.6	33.6	25.9	1.0	100	Vert.	Yes
Measurement uncertainty						+2.2 dB / -3.6 dB				

Result measured with the average detector:

Frequency GHz	Corr. value dB μ V/m	Limit dB μ V/m	Margin dB	Readings dB μ V	Antenna factor 1/m	Preamp dB	Cable loss dB	Height cm	Pol.	Restr. Band
2.343	46.5	54.0	7.5	15.4	28.4	0.0	2.7	150	Vert.	Yes
2.412	102.6	-	-	71.3	28.5	0.0	2.8	150	Vert.	-
4.824	44.5	54.0	9.5	33.3	33.1	25.7	3.8	150	Hor.	Yes
9.648	53.0	82.6	29.6	33.3	37.9	23.9	5.7	150	Hor.	No
12.060	35.5	54.0	18.5	26.8	33.6	25.9	1.0	100	Vert.	Yes
Measurement uncertainty						+2.2 dB / -3.6 dB				

TEST REPORT REFERENCE: R70284_A Edition 1

Transmitter operates at the middle of the assigned frequency band (operation mode 5)

Result measured with the peak detector:

Frequency GHz	Corr. value dB μ V/m	Limit dB μ V/m	Margin dB	Readings dB μ V	Antenna factor 1/m	Preamp dB	Cable loss dB	Height cm	Pol.	Restr. Band
2.437	113.3	-	-	81.8	28.7	0.0	2.8	150	Vert.	-
4.874	50.5	74.0	23.5	39.0	33.4	25.7	3.8	150	Hor.	Yes
9.748	57.5	93.3	35.8	37.8	37.9	23.9	5.7	150	Hor.	No
Measurement uncertainty							+2.2 dB / -3.6 dB			

Result measured with the average detector:

Frequency GHz	Corr. value dB μ V/m	Limit dB μ V/m	Margin dB	Readings dB μ V	Antenna factor 1/m	Preamp dB	Cable loss dB	Height cm	Pol.	Restr. Band
2.437	103.0	-	-	71.5	28.7	0.0	2.8	150	Vert.	-
4.874	43.7	54.0	10.3	32.2	33.4	25.7	3.8	150	Hor.	Yes
9.748	52.2	83.3	30.8	32.5	37.9	23.9	5.7	150	Hor.	No
Measurement uncertainty							+2.2 dB / -3.6 dB			

TEST REPORT REFERENCE: R70284_A Edition 1

Transmitter operates at the upper end of the assigned frequency band (operation mode 6)

Result measured with the peak detector:

Frequency GHz	Corr. value dB μ V/m	Limit dB μ V/m	Margin dB	Readings dB μ V	Antenna factor 1/m	Preamp dB	Cable loss dB	Height cm	Pol.	Restr. Band
2.400	65.1	93.3	28.8	33.8	28.5	0.0	2.8	150	Vert.	No
2.462	113.3	-	-	81.8	28.7	0.0	2.8	150	Vert.	-
4.924	49.9	74.0	24.1	39.3	32.4	25.6	3.8	150	Hor.	Yes
9.848	57.1	93.3	36.2	36.2	37.9	23.9	5.7	150	Hor.	No
Measurement uncertainty						+2.2 dB / -3.6 dB				

Result measured with the average detector:

Frequency GHz	Corr. value dB μ V/m	Limit dB μ V/m	Margin dB	Readings dB μ V	Antenna factor 1/m	Preamp dB	Cable loss dB	Height cm	Pol.	Restr. Band
2.400	53.6	83.2	29.6	22.3	28.5	0.0	2.8	150	Vert.	No
2.462	103.2	-	-	71.7	28.7	0.0	2.8	150	Vert.	-
4.924	42.0	54.0	12.0	31.4	32.4	25.6	3.8	150	Hor.	Yes
9.848	49.8	83.2	33.4	30.1	37.9	23.9	5.7	150	Hor.	No
Measurement uncertainty						+2.2 dB / -3.6 dB				

Test: Passed

TEST EQUIPMENT USED FOR THE TEST:

29, 31 – 37, 39, 43, 46, 49 – 51, 54

TEST REPORT REFERENCE: R70284_A Edition 1

5.6.2.12 PRELIMINARY MEASUREMENT EXTERNAL MONOPOLE ANTENNA (1 GHz to 25 GHz), b-mode

Ambient temperature	20 °C	Relative humidity	32 %
---------------------	-------	-------------------	------

- Position of EUT: The EUT was set-up on a non-conducting table of a height of 0.8 m. The distance between EUT and antenna was 3 m.
- Cable guide: The cables of the EUT were fixed on the non-conducting table. For further information of the cable guide refer to the pictures in annex A of this test report.
- Test record: All results are shown in the following.
- Supply voltage: During all measurements the EUT was supplied with 5.0 V DC via the carrier board.
- Remark: As external antenna the IG-103 with a 30 cm antenna cable was used, because of the highest gain of this antenna type. Additionally pre-tests have shown that this antenna and this antenna cable caused the highest spurious emissions of all monopole antennas.

Transmitter operates at the lower end of the assigned frequency band (operation mode 1)

70284_57.wmf (1 GHz to 4 GHz), operation mode 1:

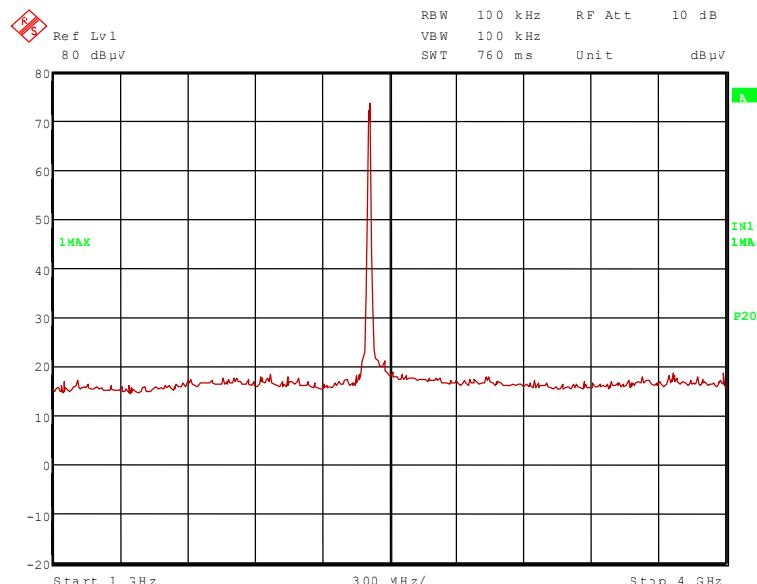

TEST REPORT REFERENCE: R70284_A Edition 1

70284_76.wmf (18 GHz to 25 GHz), operation mode 1:

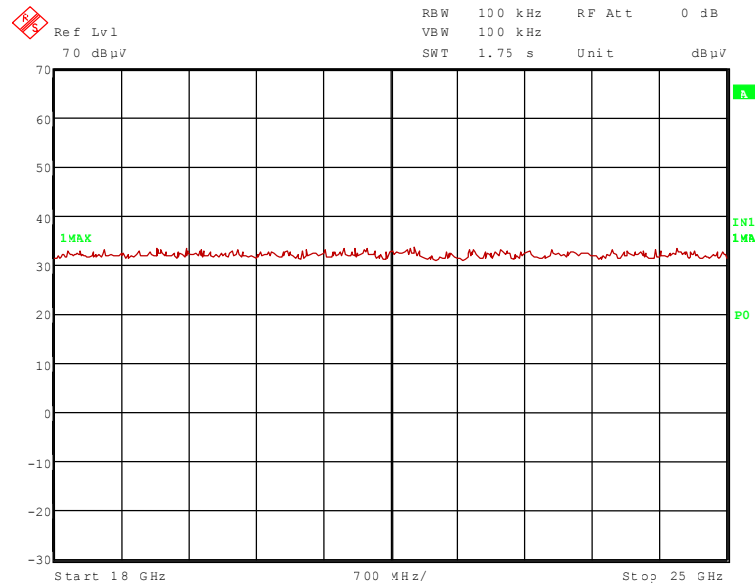

The following frequency was found inside the restricted bands during the preliminary radiated emission test:

- 4.824 GHz and 12.060 GHz.

The following frequencies were found outside the restricted bands during the preliminary radiated emission test:

- 2.412 GHz, 2.480 GHz and 9.648 GHz.

These frequencies have to be measured in a final measurement. The results were presented in the following.

TEST REPORT REFERENCE: R70284_A Edition 1

Transmitter operates at the middle of the assigned frequency band (operation mode 2)

70284_58.wmf (1 GHz to 4 GHz), operation mode 2:

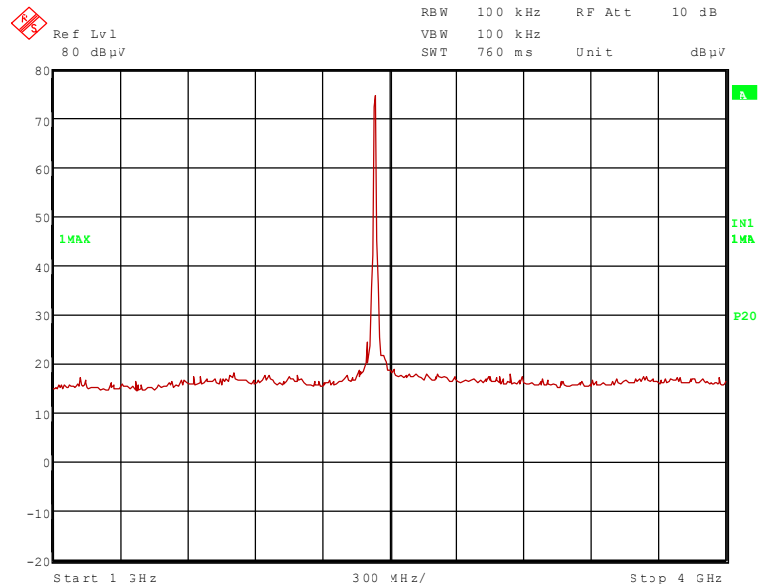

70284_64.wmf (4 GHz to 12 GHz), operation mode 2:

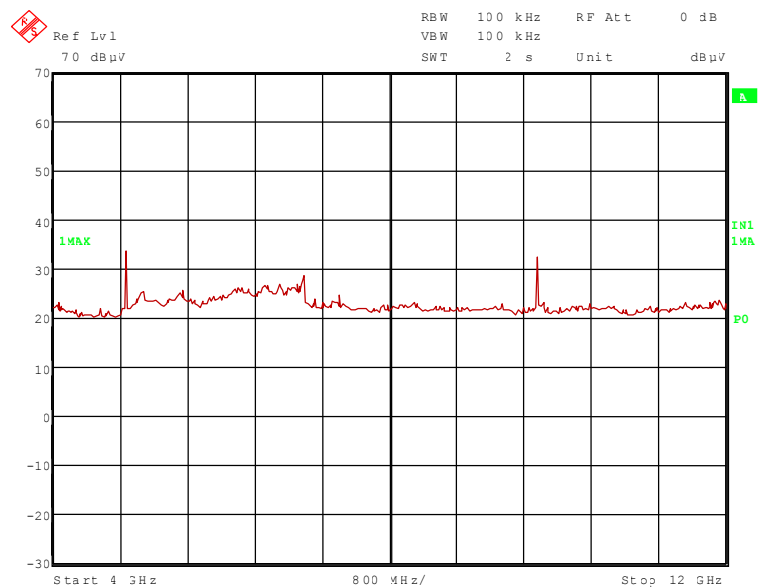

TEST REPORT REFERENCE: R70284_A Edition 1

70284_86.wmf (12 GHz to 18 GHz), operation mode 2:

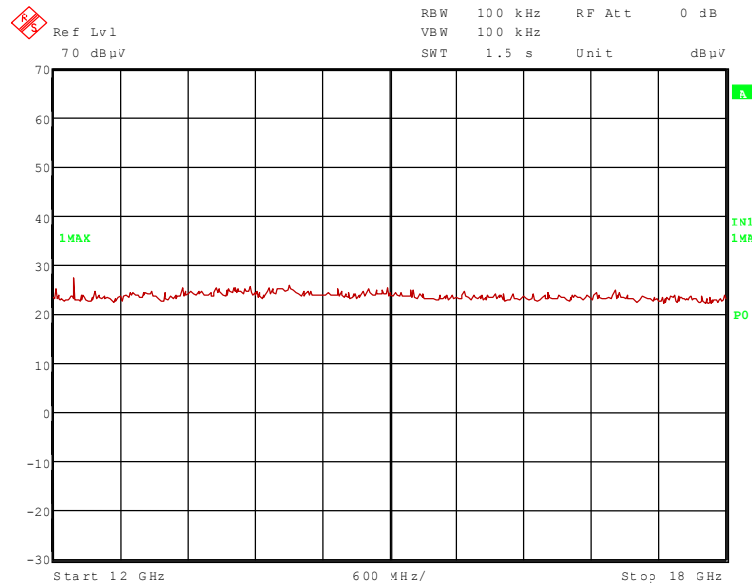

70284_77.wmf (18 GHz to 25 GHz), operation mode 2:

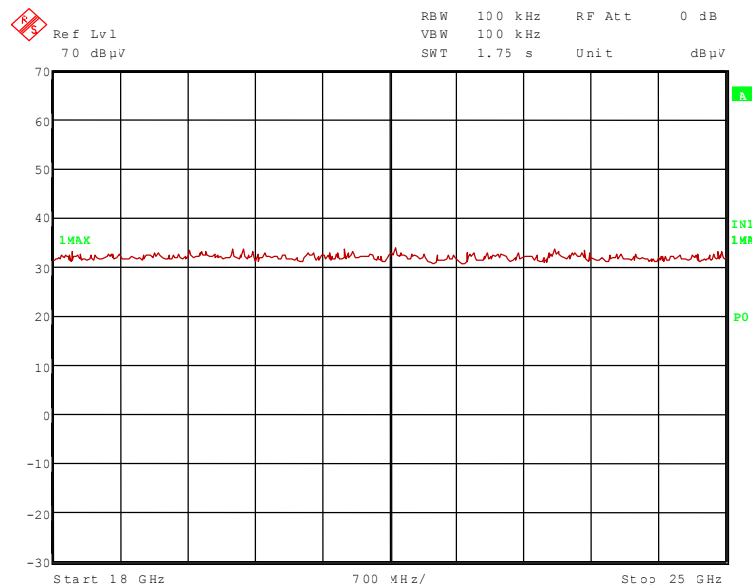

The following frequency was found inside the restricted bands during the preliminary radiated emission test:

- 4.874 GHz and 12.185 GHz.

The following frequencies were found outside the restricted bands during the preliminary radiated emission test:

- 2.400 GHz, 2.437 GHz and 9.748 GHz.

These frequencies have to be measured in a final measurement. The results were presented in the following.

TEST REPORT REFERENCE: R70284_A Edition 1

70284_85.wmf (12 GHz to 18 GHz), operation mode 3:

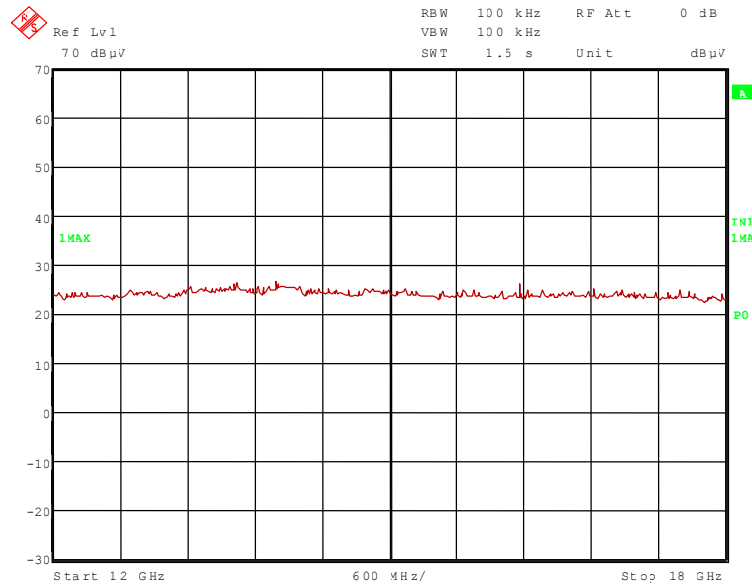

70284_78.wmf (18 GHz to 25 GHz), operation mode 3:

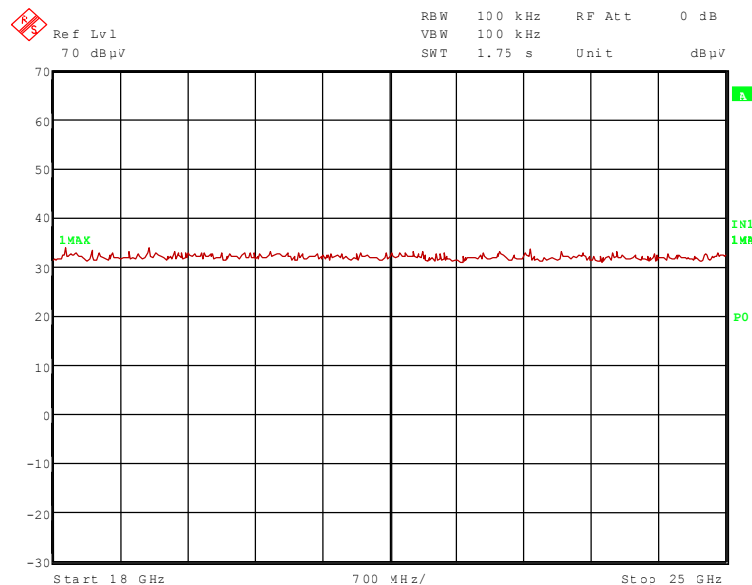

The following frequency was found inside the restricted bands during the preliminary radiated emission test:

- 4.924 GHz.

The following frequency was found outside the restricted bands during the preliminary radiated emission test:

- 2.400 GHz, 2.462 GHz and 9.848 GHz.

These frequencies have to be measured in a final measurement. The results were presented in the following.

TEST REPORT REFERENCE: R70284_A Edition 1

5.6.2.13 FINAL MEASUREMENT EXTERNAL MONOPOLE ANTENNA (1 GHz to 25 GHz) b-mode

Ambient temperature	20 °C	Relative humidity	32 %
---------------------	-------	-------------------	------

Position of EUT: The EUT was set-up on a non-conducting table of a height of 0.8 m. The distance between EUT and antenna was 3 m.

Cable guide: The cables of the EUT were fixed on the non-conducting table. For further information of the cable guide refer to the pictures in annex A of this test report.

Supply voltage: During all measurements the EUT was supplied with 5.0 V DC via the carrier board.

Resolution bandwidth: For all measurements a resolution bandwidth of 1 MHz was used.

Remark: As external antenna the IG-103 with a 30 cm antenna cable was used, because of the highest gain of this antenna type. Additionally pre-tests have shown that this antenna and this antenna cable caused the highest spurious emissions of all monopole antennas.

Transmitter operates at the lower end of the assigned frequency band (operation mode 1)

Result measured with the peak detector:

Frequency GHz	Corr. value dB μ V/m	Limit dB μ V/m	Margin dB	Readings dB μ V	Antenna factor 1/m	Preamp dB	Cable loss dB	Height cm	Pol.	Restr. Band
2.412	111.0	-	-	79.7	28.5	0.0	2.8	150	Vert.	-
2.480	63.5	91.0	27.5	32.0	28.7	0.0	2.8	150	Vert.	No
4.824	53.1	74.0	20.9	41.9	33.1	25.7	3.8	150	Hor.	Yes
9.648	57.3	91.0	33.7	37.6	37.9	23.9	5.7	150	Hor.	No
12.060	49.3	74.0	24.7	40.6	33.6	25.9	1.0	100	Vert.	Yes
Measurement uncertainty							+2.2 dB / -3.6 dB			

Result measured with the average detector:

Frequency GHz	Corr. value dB μ V/m	Limit dB μ V/m	Margin dB	Readings dB μ V	Antenna factor 1/m	Preamp dB	Cable loss dB	Height cm	Pol.	Restr. Band
2.412	103.3	-	-	72.0	28.5	0.0	2.8	150	Vert.	-
2.480	48.7	83.3	34.8	17.2	28.7	0.0	2.8	150	Vert.	No
4.824	45.7	54.0	8.3	34.5	33.1	25.7	3.8	150	Hor.	Yes
9.648	52.6	83.4	30.8	32.9	37.9	23.9	5.7	150	Hor.	No
12.060	36.2	54.0	17.8	27.5	33.6	25.9	1.0	100	Vert.	Yes
Measurement uncertainty							+2.2 dB / -3.6 dB			

TEST REPORT REFERENCE: R70284_A Edition 1

Transmitter operates at the middle of the assigned frequency band (operation mode 2)

Result measured with the peak detector:

Frequency GHz	Corr. value dB μ V/m	Limit dB μ V/m	Margin dB	Readings dB μ V	Antenna factor 1/m	Preamp dB	Cable loss dB	Height cm	Pol.	Restr. Band
2.400	67.3	91.2	23.9	36.0	28.5	0.0	2.8	150	Vert.	No
2.437	111.2	-	-	79.7	28.7	0.0	2.8	150	Vert.	-
4.874	52.7	74.0	21.3	41.2	33.4	25.7	3.8	150	Hor.	Yes
9.748	57.8	91.2	33.4	38.1	37.9	23.9	5.7	150	Hor.	No
12.185	47.5	74.0	26.5	38.7	33.6	25.8	1.0	100	Vert.	Yes
Measurement uncertainty						+2.2 dB / -3.6 dB				

Result measured with the average detector:

Frequency GHz	Corr. value dB μ V/m	Limit dB μ V/m	Margin dB	Readings dB μ V	Antenna factor 1/m	Preamp dB	Cable loss dB	Height cm	Pol.	Restr. Band
2.400	53.4	84.1	30.7	22.1	28.5	0.0	2.8	150	Vert.	No
2.437	104.1	-	-	72.6	28.7	0.0	2.8	150	Vert.	-
4.874	45.5	54.0	8.5	34.0	33.4	25.7	3.8	150	Hor.	Yes
9.748	52.7	84.1	31.4	33.0	37.9	23.9	5.7	150	Hor.	No
12.185	36.0	54.0	18.0	27.2	33.6	25.8	1.0	100	Vert.	Yes
Measurement uncertainty						+2.2 dB / -3.6 dB				

TEST REPORT REFERENCE: R70284_A Edition 1

Transmitter operates at the upper end of the assigned frequency band (operation mode 3)

Result measured with the peak detector:

Frequency GHz	Corr. value dB μ V/m	Limit dB μ V/m	Margin dB	Readings dB μ V	Antenna factor 1/m	Preamp dB	Cable loss dB	Height cm	Pol.	Restr. Band
2.400	64.3	91.7	27.4	33.0	28.5	0.0	2.8	150	Vert.	No
2.462	111.7	-	-	80.2	28.7	0.0	2.8	150	Vert.	-
4.924	51.8	74.0	22.2	40.1	33.5	25.6	3.8	150	Hor.	Yes
9.848	56.5	91.7	35.2	36.8	37.9	23.9	5.7	150	Hor.	No
Measurement uncertainty						+2.2 dB / -3.6 dB				

Result measured with the average detector:

Frequency GHz	Corr. value dB μ V/m	Limit dB μ V/m	Margin dB	Readings dB μ V	Antenna factor 1/m	Preamp dB	Cable loss dB	Height cm	Pol.	Restr. Band
2.400	52.8	84.3	31.5	21.5	28.5	0.0	2.8	150	Vert.	No
2.462	104.3	-	-	72.8	28.7	0.0	2.8	150	Vert.	-
4.924	45.0	54.0	9.0	33.3	33.5	25.6	3.8	150	Hor.	Yes
9.848	49.7	84.3	34.6	30.0	37.9	23.9	5.7	150	Hor.	No
Measurement uncertainty						+2.2 dB / -3.6 dB				

Test: Passed

TEST EQUIPMENT USED FOR THE TEST:

29, 31 – 37, 39, 43, 46, 49 – 51, 54

TEST REPORT REFERENCE: R70284_A Edition 1

5.6.2.14 PRELIMINARY MEASUREMENT EXTERNAL MONOPOLE ANTENNA (1 GHz to 25 GHz), g-mode

Ambient temperature	20 °C	Relative humidity	32 %
---------------------	-------	-------------------	------

- Position of EUT:** The EUT was set-up on a non-conducting table of a height of 0.8 m. The distance between EUT and antenna was 3 m.
- Cable guide:** The cables of the EUT were fixed on the non-conducting table. For further information of the cable guide refer to the pictures in annex A of this test report.
- Test record:** All results are shown in the following.
- Supply voltage:** During all measurements the EUT was supplied with 5.0 V DC via the carrier board.
- Remark:** As external antenna the IG-103 with a 30 cm antenna cable was used, because of the highest gain of this antenna type. Additionally pre-tests have shown that this antenna and this antenna cable caused the highest spurious emissions of all monopole antennas.

Transmitter operates at the lower end of the assigned frequency band (operation mode 4)

70284_60.wmf (1 GHz to 4 GHz), operation mode 4:

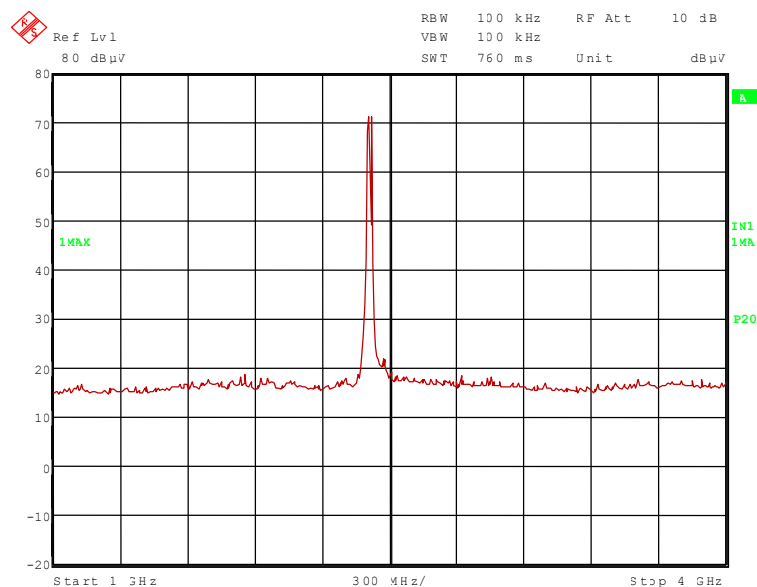

TEST REPORT REFERENCE: R70284_A Edition 1

70284_79.wmf (18 GHz to 25 GHz), operation mode 4:

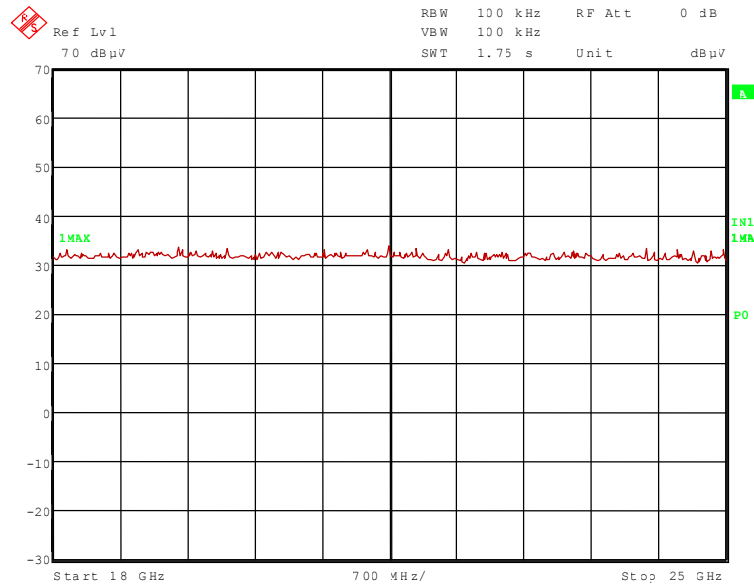

The following frequency was found inside the restricted bands during the preliminary radiated emission test:

- 4.824 GHz and 12.060 GHz.

The following frequencies were found outside the restricted bands during the preliminary radiated emission test:

- 2.412 GHz, 2.480 GHz and 9.648 GHz.

These frequencies have to be measured in a final measurement. The results were presented in the following.

TEST REPORT REFERENCE: R70284_A Edition 1

Transmitter operates at the middle of the assigned frequency band (operation mode 5)

70284_61.wmf (1 GHz to 4 GHz), operation mode 5:

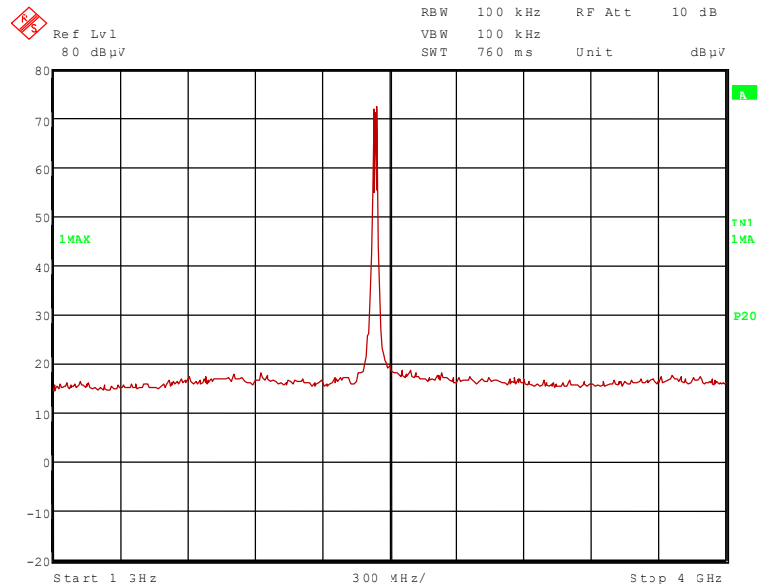

70284_67.wmf (4 GHz to 12 GHz), operation mode 5:

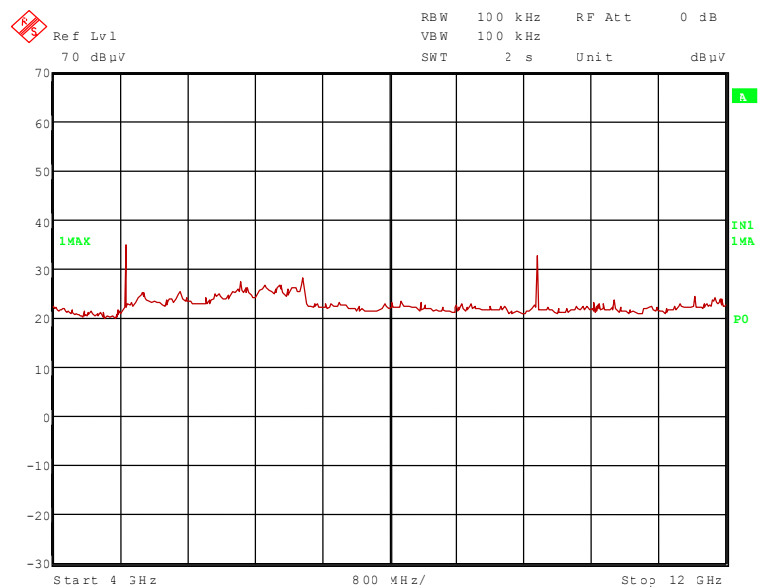

TEST REPORT REFERENCE: R70284_A Edition 1

70284_83.wmf (12 GHz to 18 GHz), operation mode 5:

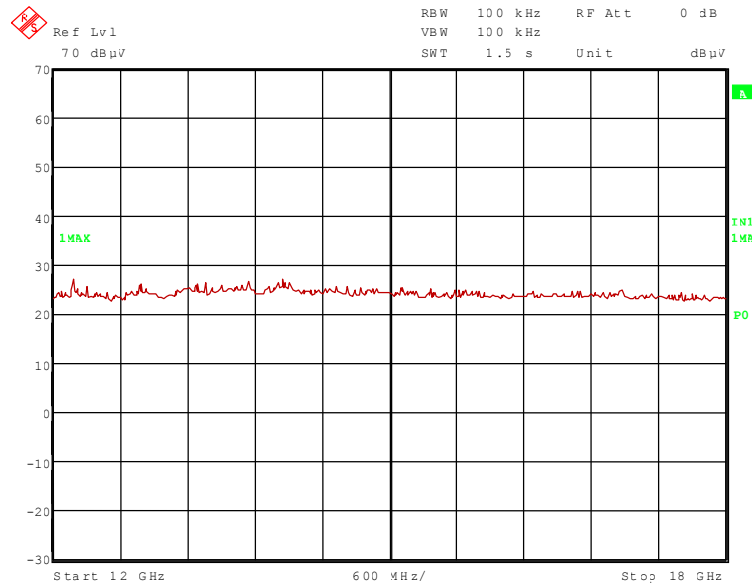

70284_80.wmf (18 GHz to 25 GHz), operation mode 5:

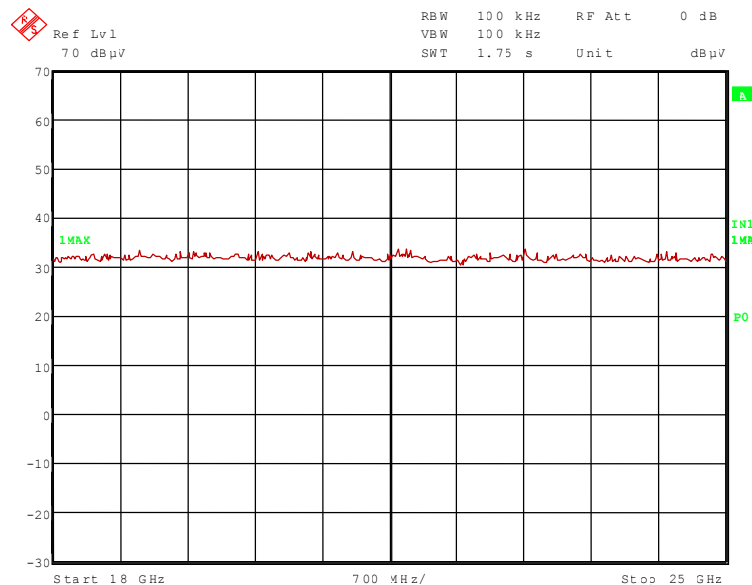

The following frequency was found inside the restricted bands during the preliminary radiated emission test:

- 4.874 GHz and 12.185 GHz.

The following frequency was found outside the restricted bands during the preliminary radiated emission test:

- 2.437 GHz and 9.748 GHz.

These frequencies have to be measured in a final measurement. The results were presented in the following.

TEST REPORT REFERENCE: R70284_A Edition 1

70284_82.wmf (12 GHz to 18 GHz), operation mode 6:

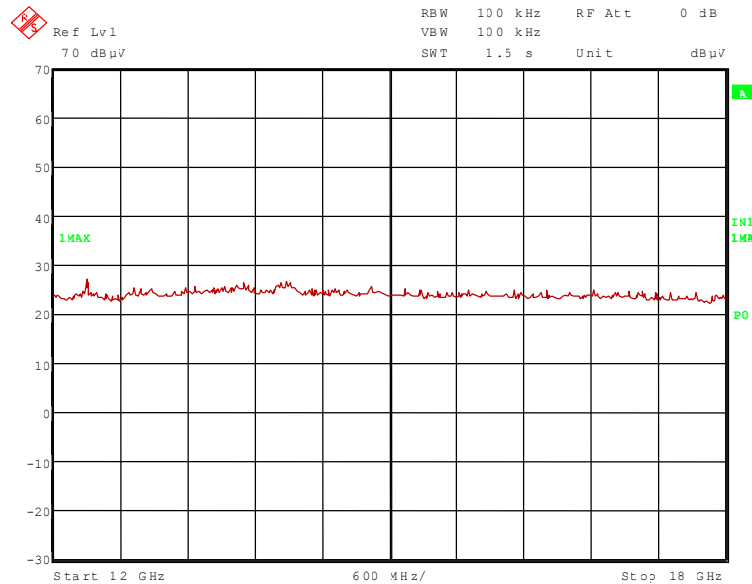

70284_81.wmf (18 GHz to 25 GHz), operation mode 6:

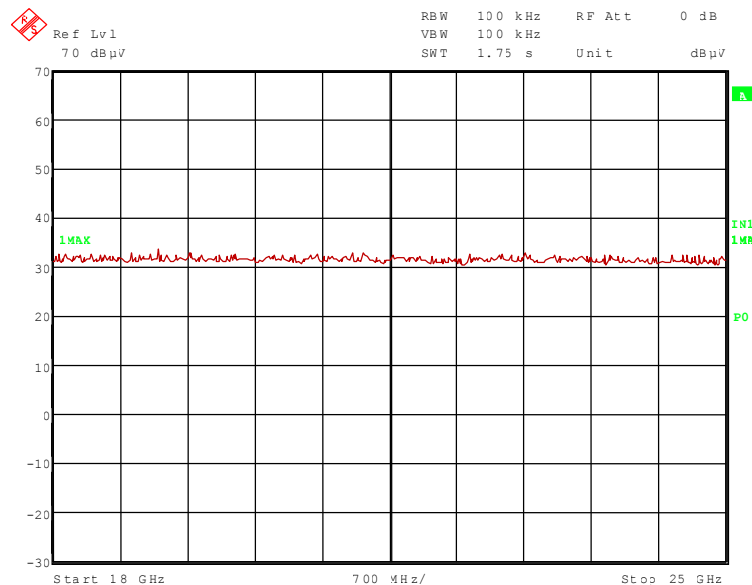

The following frequency was found inside the restricted bands during the preliminary radiated emission test:

- 4.924 GHz and 12.310 GHz.

The following frequencies were found outside the restricted bands during the preliminary radiated emission test:

- 2.400 GHz, 2.462 GHz and 9.848 GHz.

These frequencies have to be measured in a final measurement. The results were presented in the following.

TEST REPORT REFERENCE: R70284_A Edition 1

5.6.2.15 FINAL MEASUREMENT EXTERNAL MONOPOLE ANTENNA (1 GHz to 25 GHz) g-mode

Ambient temperature	20 °C	Relative humidity	32 %
---------------------	-------	-------------------	------

Position of EUT: The EUT was set-up on a non-conducting table of a height of 0.8 m. The distance between EUT and antenna was 3 m.

Cable guide: The cables of the EUT were fixed on the non-conducting table. For further information of the cable guide refer to the pictures in annex A of this test report.

Supply voltage: During all measurements the EUT was supplied with 5.0 V DC via the carrier board.

Resolution bandwidth: For all measurements a resolution bandwidth of 1 MHz was used.

Remark: As external antenna the IG-103 with a 30 cm antenna cable was used, because of the highest gain of this antenna type. Additionally pre-tests have shown that this antenna and this antenna cable caused the highest spurious emissions of all monopole antennas.

Transmitter operates at the lower end of the assigned frequency band (operation mode 4)

Result measured with the peak detector:

Frequency GHz	Corr. Value dB μ V/m	Limit dB μ V/m	Margin dB	Readings dB μ V	Antenna factor 1/m	Preamp dB	Cable loss dB	Height cm	Pol.	Restr. Band
2.412	111.9	-	-	80.6	28.5	0.0	2.8	150	Vert.	-
2.480	63.3	91.7	28.4	31.8	28.7	0.0	2.8	150	Vert.	No
4.824	51.4	74.0	22.6	40.2	33.1	25.7	3.8	150	Hor.	Yes
9.648	57.3	91.7	34.6	37.6	37.9	23.9	5.7	150	Hor.	No
12.060	48.9	74.0	25.1	40.2	33.6	25.9	1.0	100	Vert.	Yes
Measurement uncertainty							+2.2 dB / -3.6 dB			

Result measured with the average detector:

Frequency GHz	Corr. Value dB μ V/m	Limit dB μ V/m	Margin dB	Readings dB μ V	Antenna factor 1/m	Preamp dB	Cable loss dB	Height cm	Pol.	Restr. Band
2.412	101.7	-	-	70.4	28.5	0.0	2.8	150	Vert.	-
2.480	48.7	81.7	33.0	17.2	28.7	0.0	2.8	150	Vert.	No
4.824	46.2	54.0	7.8	35.0	33.1	25.7	3.8	150	Hor.	Yes
9.648	52.9	81.7	28.8	33.2	37.9	23.9	5.7	150	Hor.	No
12.060	35.3	54.0	18.7	26.6	33.6	25.9	1.0	100	Vert.	Yes
Measurement uncertainty							+2.2 dB / -3.6 dB			

TEST REPORT REFERENCE: R70284_A Edition 1

Transmitter operates at the middle of the assigned frequency band (operation mode 5)

Result measured with the peak detector:

Frequency GHz	Corr. Value dB μ V/m	Limit dB μ V/m	Margin dB	Readings dB μ V	Antenna factor 1/m	Preamp dB	Cable loss dB	Height cm	Pol.	Restr. Band
2.437	112.1	-	-	80.6	28.7	0.0	2.8	150	Vert.	-
4.874	52.0	74.0	22.0	40.5	33.4	25.7	3.8	150	Hor.	Yes
9.748	57.4	92.1	34.7	37.7	37.9	23.9	5.7	150	Hor.	No
12.185	46.0	74.0	28.0	37.2	33.6	25.8	1.0	100	Vert.	Yes
Measurement uncertainty						+2.2 dB / -3.6 dB				

Result measured with the average detector:

Frequency GHz	Corr. Value dB μ V/m	Limit dB μ V/m	Margin dB	Readings dB μ V	Antenna factor 1/m	Preamp dB	Cable loss dB	Height cm	Pol.	Restr. Band
2.437	102.0	-	-	70.5	28.7	0.0	2.8	150	Vert.	-
4.874	45.2	54.0	8.8	33.7	33.4	25.7	3.8	150	Hor.	Yes
9.748	52.7	82.0	29.3	33.0	37.9	23.9	5.7	150	Hor.	No
12.185	32.1	54.0	21.9	23.3	33.6	25.8	1.0	100	Vert.	Yes
Measurement uncertainty						+2.2 dB / -3.6 dB				

TEST REPORT REFERENCE: R70284_A Edition 1

Transmitter operates at the upper end of the assigned frequency band (operation mode 6)

Result measured with the peak detector:

Frequency GHz	Corr. Value dB μ V/m	Limit dB μ V/m	Margin dB	Readings dB μ V	Antenna factor 1/m	Preamp dB	Cable loss dB	Height cm	Pol.	Restr. Band
2.400	64.2	92.0	27.8	32.9	28.5	0.0	2.8	150	Vert.	No
2.462	112.0	-	-	80.5	28.7	0.0	2.8	150	Vert.	-
4.924	51.8	74.0	22.2	40.1	33.5	25.6	3.8	150	Hor.	Yes
9.848	55.3	92.0	36.7	35.6	37.9	23.9	5.7	150	Hor.	No
12.310	46.4	74.0	27.6	37.5	33.7	25.8	1.0	100	Vert.	Yes
Measurement uncertainty						+2.2 dB / -3.6 dB				

Result measured with the average detector:

Frequency GHz	Corr. Value dB μ V/m	Limit dB μ V/m	Margin dB	Readings dB μ V	Antenna factor 1/m	Preamp dB	Cable loss dB	Height cm	Pol.	Restr. Band
2.400	52.8	82.1	29.3	21.5	28.5	0.0	2.8	150	Vert.	No
2.462	102.1	-	-	70.6	28.7	0.0	2.8	150	Vert.	-
4.924	43.1	54.0	10.9	31.4	33.5	25.6	3.8	150	Hor.	Yes
9.848	49.8	82.1	32.3	30.1	37.9	23.9	5.7	150	Hor.	No
12.310	33.2	54.0	20.8	24.3	33.7	25.8	1.0	100	Vert.	Yes
Measurement uncertainty						+2.2 dB / -3.6 dB				

Test: Passed

TEST EQUIPMENT USED FOR THE TEST:

29, 31 – 37, 39, 43, 46, 49 – 51, 54

TEST REPORT REFERENCE: R70284_A Edition 1

6 TEST EQUIPMENT AND ANCILLARIES USED FOR TESTS

TEST REPORT REFERENCE: R70284_A Edition 1

Emission measurement at AC mains and DC in / out ports at M4					
No.	Test equipment	Type	Manufacturer	Serial No.	PM-No
1	Shielded chamber M4	-	Siemens	B83117S1-X158	480088
2	Measuring receiver	ESAI	Rohde & Schwarz	831953/001 833181/018	480025 480026
3	LISN	NSLK8128	Schwarzbeck	8128155	480058
4	DC-filter	B84266-A21-E13	Siemens	940164525	480099
5	AC-filter	B84299-D87-E3	Siemens	930262292	480097
6	EMI-Software	ES-K1	Rohde & Schwarz	-	480111

Radiated emission measurement at M5					
No.	Test equipment	Type	Manufacturer	Serial No.	PM-No
7	Fully anechoic chamber M5	-	Siemens	B83177-S1-X156	480073
8	Measuring receiver	ESCS 30	Rohde & Schwarz	828985/014	480270
9	Controller	HD100	Deisel	100/324	480067
10	Antenna support	MA240	Deisel	228/314	480069
11	Turntable	DS412	Deisel	412/317	480070
12	Antenna	CBL6112C	Chase	2689	480327
13	EMI Software	ES-K1	Rohde & Schwarz	-	480111

Radiated emission measurement at M6					
No.	Test equipment	Type	Manufacturer	Serial No.	PM-No
14	Open area test site	-	Phoenix Test-Lab	-	480085
15	Measuring receiver	ESCS 30	Rohde & Schwarz	828985/014	480270
16	Controller	HD100	Deisel	100/670	480139
17	Turntable	DS420HE	Deisel	420/620/80	480087
18	Antenna support	AS615P	Deisel	615/310	480086
19	Antenna	CBL6111 A	Chase	1643	480147
20	EMI Software	ES-K1	Rohde & Schwarz	-	480111

TEST REPORT REFERENCE: R70284_A Edition 1

Radiated emission measurement at M8					
No.	Test equipment	Type	Manufacturer	Serial No.	PM-No
21	Fully anechoic chamber M8	-	Siemens	B83117-E7019-T231	480190
22	Measuring receiver	ESMI	Rohde & Schwarz	843977/001 843530/018	480179 480180
23	Measuring receiver	ESCS 30	Rohde & Schwarz	828985/014	480270
24	Controller	HD100	Deisel	100/427	480181
25	Turntable	DS420	Deisel	420/435/97	480186
26	Antenna support	AS615P	Deisel	615/310	480187
27	Antenna	CBL6112 A	Chase	2034	480185
28	EMI Software	ES-K1	Rohde & Schwarz	-	480111

Radiated emission measurement at M20					
No.	Test equipment	Type	Manufacturer	Serial No.	PM-No
29	Fully anechoic chamber M20	-	Albatross Projects	B83107-E2439-T232	480303
30	Measuring receiver	ESMI	Rohde & Schwarz	843977/001 843530/018	480179 480180
31	Measuring receiver	ESI 40	Rohde & Schwarz	100064	480355
32	Controller	HD100	Deisel	100/670	480326
33	Turntable	DS420HE	Deisel	420/620/80	480315
34	Antenna support	AS615P	Deisel	615/310	480187
35	Antenna	CBL6112 B	Chase	2688	480328
36	Antenna	3115 A	EMCO	9609-4918	480183
37	Standard Gain Horn 11.9 GHz – 18 GHz	18240-20	Flann Microwave	483	480294
38	Standard Gain Horn 11.9 GHz – 18 GHz	18240-20	Flann Microwave	482	480295
39	Standard Gain Horn 17.9 GHz – 26.7 GHz	20240-20	Flann Microwave	411	480297
40	Standard Gain Horn 17.9 GHz – 26.7 GHz	20240-20	Flann Microwave	410	480296
41	Standard Gain Horn 26.4 GHz – 40.1 GHz	22240-20	Flann Microwave	469	480299

TEST REPORT REFERENCE: R70284_A Edition 1

No.	Test equipment	Type	Manufacturer	Serial No.	PM-No
42	Standard Gain Horn 26.4 GHz – 40.1 GHz	22240-20	Flann Microwave	468	480298
43	RF-cable No. 30	RTK 081	Rosenberger	-	410141
44	RF-cable No. 31	RTK 081	Rosenberger	-	410142
45	RF-cable 1m	KPS-1533- 400-KPS	Insulated Wire	-	480300
46	RF-cable 1m	KPS-1533- 400-KPS	Insulated Wire	-	480301
47	RF-cable 2m	KPS-1533- 400-KPS	Insulated Wire	-	480302
48	RF-cable No. 5	RTK 081	Rosenberger		410097
49	Preamplifier	JS3- 00101200- 23-5A	Miteq	681851	480337
50	Preamplifier	JS3- 12001800- 16-5A	Miteq	571667	480343
51	Preamplifier	JS3- 18002600- 20-5A	Miteq	658697	480342
52	Preamplifier	JS3- 26004000- 25-5A	Miteq	563593	480344
53	EMI Software	ES-K1	Rohde & Schwarz	-	480111

Ancillary equipment used for testing					
No.	Test equipment	Type	Manufacturer	Serial No.	PM-No
54	Power supply	TOE 8852	Toellner	51712	480233
55	Peak Power Sensor	NRV-Z32	Rohde & Schwarz	849745/016	480551
56	Outdoor test site	-	Phoenix Test-Lab	-	480293
57	Measuring receiver	ESPC	Rohde & Schwarz	843756/006	480150
58	Loop antenna	HFH2-Z2	Rohde & Schwarz	832609/014	480059

All used measurement equipment was calibrated (if necessary). The calibration intervals and the calibration history will be given out on request.

TEST REPORT REFERENCE: R70284_A Edition 1

7 LIST OF ANNEXES

Annex A	Photographs of the test set-ups:	9 pages
	cB-OWLAN211gx-02 with external monopole antenna, test set-up fully anechoic chamber	70284_25.jpg
	cB-OWLAN211gx-02 with external monopole antenna, test set-up fully anechoic chamber	70284_24.jpg
	cB-OWLAN211gx-02 with external patch antenna, test set-up fully anechoic chamber	70284_26.jpg
	cB-OWLAN211gx-02 with external patch antenna, test set-up fully anechoic chamber	70284_32.jpg
	cB-OWLAN211gi-02 with internal antenna, test set-up fully anechoic chamber	70284_28.jpg
	cB-OWLAN211gi-02 with internal antenna, test set-up fully anechoic chamber	70284_31.jpg
	cB-OWLAN211gi-02 with internal antenna, test set-up outdoor test site	70284_2.jpg
	cB-OWLAN211gi-02 with internal antenna, test set-up open area test site	70284_27.jpg
	cB-OWLAN211gi-02 test set-up conducted emission measurement	70284_30.jpg
ANNEX B	INTERNAL PHOTOGRAPHS OF THE TEST SAMPLE:	7 pages
	cB-OWLAN211gx-02 (sample for external antenna), top view	70284_g.jpg
	cB-OWLAN211gi-02, top view (sample with internal antenna)	70284_e.jpg
	cB-OWLAN211gx-02 (sample with internal antenna), housing removed, top view	70284_k.jpg
	cB-OWLAN211gx-02, bottom view	70284_f.jpg
	cB-0903-03, cB-0903-03, carrier board, top view	70284_d.jpg
	cB-0903-03, carrier board for cB-OWLAN211g-02 with external antenna, top view	70290_h.jpg
	cB-0903-03, carrier board, bottom view with UART-SPI bridge	70284_b.jpg
ANNEX C	EXTERNAL PHOTOGRAPHS OF THE TEST SAMPLE:	- pages
	Because the EUT is a module, which is intended to be implemented inside a final application, no external photographs were available	
ANNEX D	ADDITIONAL RESULTS FOR INDUSTRY CANADA:	12 pages
ANNEX E	FCC / IC CROSSREFERENCE	1 page