



EUROFINS PRODUCT SERVICE GMBH

SAR

TEST - REPORT

SAR Compliance Test Report

Field controller
CS10

Test report no.:
G0M20908-2507-S-1



Eurofins Product Service GmbH
Storkower Str. 38c, D-15526 Reichenwalde,
Germany

Phone +49-33631-888 00
Fax +49-33631-888 660

TABLE OF CONTENTS

1	General information	3
1.1	Notes	3
1.2	Testing laboratory	4
1.3	Details of approval holder	4
1.4	Manufacturer	5
1.5	Application details	5
1.6	Test item	5
1.7	Test results	6
1.8	Test standards	6
2	Technical test	7
2.1	Summary of test results	7
2.2	Test environment	7
2.3	Test equipment utilized	8
2.4	Definitions	9
2.5	Measurement system description	10
2.6	Test system specification	15
2.7	Measurement procedure	16
2.8	Reference points	17
2.9	Test positions	19
2.10	Measurement uncertainty	23
3	Tissue and system verification	24
3.1	Tissue verification	24
3.2	System verification	24
4	Test Results	25
5	Transmitter co-location performance evaluation	27
6	References	30
7	Annex	31

1 General Information
1.1 Notes

The results of this test report relate exclusively to the item tested as specified in chapter "Description of test item" and are not transferable to any other test items.

Eurofins Product Service GmbH is not responsible for any generalisations and conclusions drawn from this report. Any modification of the test item can lead to invalidity of test results and this test report may therefore be not applicable to the modified test item.

The test report may only be reproduced or published in full. Reproducing or publishing extracts of the report requires the prior written approval of the Eurofins Product Service GmbH.

This document is subject to the General Terms and Conditions and the Testing and Certification System of Eurofins Product Service GmbH, available on request or accessible at www.pt.eurofins.com

I attest to the accuracy of data. All measurements reported herein were performed by me or were made under my supervision and are correct to the best of my knowledge and belief. I assume full responsibility for the completeness of these measurements and vouch for the qualification of all persons taking them.

Operator:

16.09.2009

B. Pudell



Date

Eurofins-Lab.

Name

Signature

Technical responsibility for area of testing:

16.09.2009

T. Jahn



Date

Eurofins

Name

Signature

1.2 Testing laboratory

1.2.1 Location

EUROFINS PRODUCT SERVICE GMBH
Storkower Straße 38c
D-15526 Reichenwalde b. Berlin
Germany
Telephone : +49 33631 888 00
Fax : +49 33631 888 660

1.2.2 Details of accreditation status

DAR ACCREDITED TESTING LABORATORY
DAR-REGISTRATION NUMBER: DAT-P-268/08

RECOGNIZED NOTIFIED BODY EMC
REGISTRATION NUMBER: BNetzA-bS EMV-07/61

RECOGNIZED NOTIFIED BODY R&TTE
REGISTRATION NUMBER: BNetzA-bS-02/51-53

FCC FILED TEST LABORATORY
REG.-No. 96970

A2LA ACCREDITED TESTING LABORATORY
CERTIFICATE No. 1983.01

BLUETOOTH QUALIFICATION TEST FACILITY (BQTF)
ACCREDITED BY BLUETOOTH QUALIFICATION REVIEW BOARD

INDUSTRY CANADA FILED TEST LABORATORY
REG. NO. IC 3470

Statement: The tests documented within this report are carried out in accordance with the scope of accreditation of test laboratory Eurofins Product Service GmbH.

1.3 Details of approval holder

Name : Leica Geosystems AG
Street : Heinrich Wild Strasse 1
Town : CH-9435 Heerbrugg
Country : Switzerland
Telephone : +41 71 727 3764
Fax : +41 71 726 5764

Contact : Herr Silvan Stucki
E-Mail : Silvan.Stucki@Leica-Geosystems.com

1.4 Manufacturer: (if applicable)

Name :
Street :
Town :
Country :

1.5 Application details

Date of receipt of application : 18.08.2009
Date of receipt of test item : 18.08.2009
Date of test : 25.08.2009 - 31.08.2009

1.6 Test item

FCC ID : RFD-CS-S
Description of test item : Field controller
Type identification : CS10
Serial number : without; Identical prototype
Device category : DSS (Part 15 Spread Spectrum Transmitter)

Technical data

TX Frequency range : 2402,0 - 2480,0 MHz
Max. Radiated RF output power : 20,22 dBm (105,2 mW)
Power supply : 7.4VDC
Antenna Tx : integral
Antenna RX : integral
Additional information : ./.

1.7 Test Results

Max. SAR Measurement (Body) : 0.583 W/kg (averaged over 1 gram)

This EUT has been shown to be capable of compliance for localized specific absorption rate (SAR) for uncontrolled environment/general population exposure limits specified in ANSI/IEEE Std. C95.1-1992 and had been tested in accordance with the measurement procedures specified in FCC/OET Bulletin 65 Supplement C (2001) and IEEE Std. 1528-2003, December 2003.

1.8 Test standards

Standards : - Radiocommunications (Electromagnetic Radiation - Human Exposure) Standard 2003
- IEEE Std. 1528-2003, December 2003

FCC Rule Part(s) : - FCC OET Bulletin 65, Supplement C, Edition 01-01

2 Technical test

2.1 Summary of test results

Applicable Configuration

Handset (Head)	
Handset (Body)	
Headset (Head)	
Body Worn Equipment	X

EUT complies with the RF radiation exposure limits of the FCC as shown by the SAR measurement results. These measurements are taken to simulate the RF effects exposure under worst-case conditions. The EUT complies with the requirements in respect to all parameters subject to the test. The test results and statements relate only to the item(s) tested.

Please note that the absorption and distribution of electromagnetic energy in the body are very complex phenomena that depend on the mass, shape, and size of the body, the orientation of the body with respect to the field vectors, and the electrical properties of both the body and the environment. Other variables that may play a substantial role in possible biological effects are those that characterize the environment (e.g. ambient temperature, air velocity, relative humidity, and body insulation) and those that characterize the individual (e.g. age, gender, activity level, debilitation, or disease). Because innumerable factors may interact to determine the specific biological outcome of an exposure to electromagnetic fields, any protection guide shall consider maximal amplification of biological effects as a result of field-body interactions, environmental conditions, and physiological variables. [1]

In case of multiple hotspots the secondary hotspots within 2dB of the maximum SAR value will be recorded and displayed in the measurement plots. The secondary hotspots with a peak SAR value below 0.5 W/kg will not be measured by the system, due to the high margin to the limits.

2.2 Test environment

Room temperature	: 22.1 -22.6 °C
Liquid temperature	: 22.0 -22.3 °C
Relative humidity content	: 20 ... 75 %
Air pressure	: 86 ... 103 k P a
Details of power supply	: 7.4VDC

2.3 Test equipment utilized

No.	Measurement device:	Type:	Manufacturer:
ETS 0449	Stäubli Robot	RX90B L	Stäubli
ETS 0450	Stäubli Robot Controller	CS/MBs&p	Stäubli
ETS 0451	DASY 4 Measurement Server		Schmid & Partner
ETS 0452	Control Pendant		Stäubli
ETS 0453	Compaq Computer	Pentium IV, 2 GHz,	Schmid & Partner
ETS 0454	Dabu Acquisition Electronics	DAE3V1	Schmid & Partner
ETS 0455	Dummy Probe		Schmid & Partner
ETS 0456	Dosimetric E-Field Probe	ET3DV6	Schmid & Partner
ETS 0457	Dosimetric E-Field Probe	ET3DV6	Schmid & Partner
ETS 0458	Dosimetric H-Field Probe	H3DV6	Schmid & Partner
ETS 0459	System Validation Kit	D900V2	Schmid & Partner
ETS 0460	System Validation Kit	D1800V2	Schmid & Partner
ETS 0461	System Validation Kit	D1900V2	Schmid & Partner
ETS 0462	System Validation Kit	D2450V2	Schmid & Partner
ETS 0463	Probe Alignment Unit	LBV2	Schmid & Partner
ETS 0464	SAM Twin phantom	V 4.0	Schmid & Partner
ETS 0465	Mounting Device	V 3.1	Schmid & Partner
ETS 0224a	Millivoltmeter	URV 5	Rohde & Schwarz
ETS 0219	Power sensor	NRV-Z2	Rohde & Schwarz
ETS 0268	RF signal generator	SMP 02	Rohde & Schwarz
ETS 0322	Insertion unit	URV5-Z4	Rohde & Schwarz
ETS 0466	Directional Coupler	HP 87300B	HP
ETS0231	Radio Communication Tester	CMD65	Rohde & Schwarz
ETS 0467	Universal Radio Communication Tester	CMU 200	Rohde & Schwarz
ETS 0468	Network Analyzer 300 kHz to 3 GHz	8753C	Agilent
ETS 0469	Dielectric Probe Kit	85070C	Agilent

2.4 Definitions

2.4.1 SAR

The specific absorption rate (SAR) is defined as the time derivative of the incremental energy (dW) absorbed by (dissipated in) an incremental mass (dm) contained in a volume element (dV) of a given density (ρ_t), expressed in watts per kilogram (W/kg)

$$\text{SAR} = \frac{d}{dt} \left(\frac{dW}{dm} \right) = \frac{d}{dt} \left(\frac{dW}{\rho_t dV} \right) = \frac{\sigma}{\rho_t} |E_t|^2$$

where:

$$\frac{dW}{dt} = \int_v E \cdot J dV = \int_v \sigma E^2 dV$$

2.4.2 Uncontrolled Exposure

The general population/uncontrolled exposure limits are applicable to situations in which the general public may be exposed or in which persons who are exposed as a consequence of their employment may not be made fully aware of the potential for exposure or cannot exercise control over their exposure. Members of the general public would come under this category when exposure is not employment-related; for example, in the case of a wireless transmitter that exposes persons in its vicinity. Warning labels placed on low-power consumer devices such as cellular telephones are not considered sufficient to allow the device to be considered under the occupational/controlled category, and the general population/uncontrolled exposure limits apply to these devices. [2]

2.4.3 Controlled Exposure

In general, occupational/controlled exposure limits are applicable to situations in which persons are exposed as a consequence of their employment, who have been made fully aware of the potential for exposure and can exercise control over their exposure. This exposure category is also applicable when the exposure is of a transient nature due to incidental passage through a location where the exposure levels may be higher than the general population/uncontrolled limits, but the exposed person is fully aware of the potential for exposure and can exercise control over his or her exposure by leaving the area or by some other appropriate means. Awareness of the potential for RF exposure in a workplace or similar environment can be provided through specific training as part of a RF safety program. If appropriate, warning signs and labels can also be used to establish such awareness by providing prominent information on the risk of potential exposure and instructions on methods to minimize such exposure risks. [2]

2.5 Measurement System Description

2.5.1 System Setup

Measurements are performed using the DASY4 automated dosimetric assessment system (figure 1) made by Schmid & Partner Engineering AG (SPEAG) in Zurich, Switzerland.



Figure 1

The DASY4 system for performing compliance tests consists of the following items:

- A standard high precision 6-axis robot (Stäubli RX family) with controller, teach pendant and software. An arm extension for accommodating the data acquisition electronics (DAE).
- A dosimetric probe, i.e., an isotropic E-field probe optimized and calibrated for usage in tissue simulating liquid. The probe is equipped with an optical surface detector system.
- A data acquisition electronics (DAE) which performs the signal amplification, signal multiplexing, AD-conversion, offset measurements, mechanical surface detection, collision detection, etc. The unit is battery powered with standard or rechargeable batteries. The signal is optically transmitted to the EOC.
- An unit to operate the optical surface detector which is connected to the EOC.
- The Electro-optical converter (EOC) performs the conversion from the optical into a digital electric signal of the DAE. The EOC is connected to the measurement server.
- The functions of the measurement server is to perform the time critical task such as signal filtering, surveillance of the robot operation, fast movement interrupts.
- A probe alignment unit which improves the (absolute) accuracy of the probe positioning.
- A computer operating Windows 2000 or Windows NT.
- DASY4 software.
- Remote control with teach pendant and additional circuitry for robot safety such as warning lamps, etc.
- The SAM twin phantom enabling testing left-hand and right-hand usage.
- The device holder for handheld mobile phones.
- Tissue simulating liquid mixed according to the given recipes (see Application Notes).
- System validation dipoles allowing to validate the proper functioning of the system.

2.5.2 Phantom Description



(Figure 2.1)



(Figure 2.2)

The SAM twin phantom V4.0 (figure 2.1) is a fiberglass shell phantom with 2 mm shell thickness. It has three measurement areas:

- Left hand
- Right hand
- Flat phantom

The Oval flat phantom (ELI 4) (figure 2.3) is a fiberglass shell phantom with 2 mm thickness.

The phantom is integrated in a wooden table.

The bottom plate of the table contains three pair of bolts for locking the device holder. The device holder positions are adjusted to the standard measurement positions in the three sections. Only one device holder is necessary if two phantoms are used (e.g., for different liquids).

A cover is provided to tap the phantom during off-periods to prevent water evaporation and changes in the liquid parameters. Free space scans of devices on the cover are possible.

On the phantom top, three reference markers are provided to identify the phantom positions with respect to the robot.

2.5.3 Tissue Simulating Liquids

The parameters of the tissue simulating liquid strongly influence the SAR. The parameters for the different frequencies are defined in the corresponding compliance standards (e.g., EN 50361, IEEE P1528-2003, December 2003).

Tissue dielectric properties

Frequency (MHz)	Head		Body	
	Relative Dielectric Constant (ϵ_r)	Conductivity (σ) (S/m)	Relative Dielectric Constant (ϵ_r)	Conductivity (σ) (S/m)
300	45.3	0.87	58.2	0.92
450	43.5	0.87	56.7	0.94
835	41.5	0.90	55.2	0.97
900	41.5	0.97	55.0	1.05
1450	40.5	1.20	54.0	1.30
1800	40.0	1.40	53.3	1.52
1900	40.0	1.40	53.3	1.52
2000	40.0	1.40	53.3	1.52
2450	39.2	1.80	52.7	1.95
3000	38.5	2.40	52.0	2.73

2.5.4 Device Holder

The DASY device holder (figure 3.1 and 3.2) is designed to cope with different positions given in the standard. It has two scales for the device rotation (with respect to the body axis) and the device inclination (with respect to the line between the ear openings). The rotation centers for both scales is the ear opening. Thus the device needs no repositioning when changing the angles.



Figure 3.1

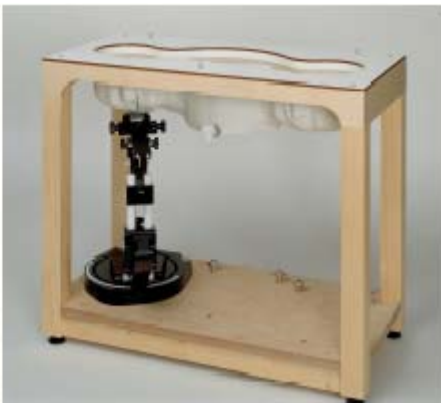

Figure 3.2

The DASY device holder has been made out of low-loss POM material having the following dielectric parameters: relative permittivity $\epsilon = 3$ and loss tangent $\delta = 0.02$. The amount of dielectric material has been reduced in the closest vicinity of the device, since measurements have suggested that the influence of the clamp on the test results could thus be lowered.

2.5.5 Probes

The SAR measurements were conducted with the dosimetric probe ET3DV6 (figure 4), designed in the classical triangular configuration and optimized for dosimetric evaluation. [3] The probe is constructed using the thick film technique; with printed resistive lines on ceramic substrates. The probe is equipped with an optical multifiber line ending at the front of the probe tip. It is connected to the EOC box on the robot arm and provides an automatic detection of the phantom surface. Half of the fibers are connected to a pulsed infrared transmitter, the other half to a synchronized receiver. As the probe approaches the surface, the reflection from the surface produces a coupling from the transmitting to the receiving fibers. This reflection increases first during the approach, reaches maximum and then decreases. If the probe is flatly touching the surface, the coupling is zero. The distance of the coupling maximum to the surface is independent of the surface reflectivity and largely independent of the surface to probe angle. The DASY4 software reads the reflection during a software approach and looks for the maximum using a 2nd order fitting. The approach is stopped at reaching the maximum.



Figure 4

Probe Specifications

Calibration:	In air from 10 MHz to 2.5 GHz In brain and muscle simulating tissue at Frequencies of 835 MHz, 900 MHz, 1800 MHz, 1900 MHz and 2450 MHz Calibration certificates please find attached.
Frequency:	10 MHz to > 3 GHz; Linearity: ± 0.2 dB (30 MHz to 3 GHz)
Directivity:	± 0.2 dB in HSL (rotation around probe axis) ± 0.4 dB in HSL (rotation normal probe axis)
Dynamic Range:	5 μ W/g to > 100 mW/g;
Linearity:	± 0.2 dB
Dimensions:	Overall length: 330 mm Tip length: 16 mm Body diameter: 12 mm Tip diameter: 6.8 mm Distance from probe tip to dipole centers: 2.7 mm
Application:	General dosimetry up to 3 GHz Compliance tests of mobile phones Fast automatic scanning in arbitrary phantoms

2.6 Test System Specification

Positioner

Robot:	Stäubli Animation Corp. Robot Model: RX90B L
Repeatability:	0.02 mm
No. of axis:	6

Data Acquisition Electronic (DAE) System

Cell Controller

Processor:	Pentium IV
Clock Speed:	2.0 GHz
Operating System:	Windows 2000
Data Card:	DASY4 PC-Board
Data Converter	
Features:	Signal Amplifier, multiplexer, A/D converter, & control logic
Software:	DASY4 software
Connecting Lines:	Optical downlink for data and status info. Optical uplink for commands and clock

PC Interface Card

Function:	24 bit (64 MHz) DSP for real time processing Link to DAE3 16 bit A/D converter for surface detection system serial link to robot direct emergency stop output for robot
-----------	---

E-Field Probes

Model:	ET3DV6 SN1711
Construction:	Triangular core fiber optic detection system
Frequency:	10 MHz to 6 GHz
Linearity:	± 0.2 dB (30MHz to 3 GHz)

Phantom

Phantom 1:	Oval flat phantom (ELI 4)
Shell Material:	Fiberglass
Thickness:	2.0 ± 0.2 mm
Phantom 2:	SAM Twin Phantom (V4.0)
Shell Material:	Fiberglass
Thickness:	2.0 ± 0.2 mm

2.7 Measurement Procedure

The evaluation was performed using the following procedure:

1. The SAR measurement was taken at a selected spatial reference point to monitor power variations during testing. This fixed location point was measured and used as a reference value.
2. The SAR distribution at the exposed side of the head was measured at a distance of 3.9mm from the inner surface of the shell. The area covered the entire dimension of the head and the horizontal grid spacing was 10mm x 10mm.
3. Based on the area scan data, the area of the maximum absorption was determined by spline interpolation. Around this point, a volume of 30mm x 30mm x 30mm (fine resolution volume scan, zoom scan) was assessed by measuring 5 x 5 x 5 points. On this basis of this data set, the spatial peak SAR value was evaluated with the following procedure:
 - a. The data at the surface was extrapolated, since the center of the dipoles is 2.7mm away from the tip of the probe and the distance between the surface and the lowest measuring point is 1.2mm. The extrapolation was based on a least square algorithm [4]. A polynomial of the fourth order was calculated through the points in z-axes. This polynomial was then used to evaluate the points between the surface and the probe tip.
 - b. The maximum interpolated value was searched with a straight-forward algorithm. Around this maximum the SAR values averaged over the spatial volumes (1g or 10g) were computed using the 3D-Spline interpolation algorithm. The 3D-spline is composed of three one-dimensional splines with the "Not a knot" condition (in x, y, and z directions) [4] [5]. The volume was integrated with the trapezoidal algorithm. One thousand points (10 x 10 x 10) were interpolated to calculate the average.
 - c. All neighboring volumes were evaluated until no neighboring volume with a higher average value was found.
4. The SAR reference value, at the same location as procedure #1, was re-measured. If the value changed by more than 5 %, the evaluation is repeated.

2.8 Reference Points

2.8.1 Ear Reference Points

Figure 5.1 shows the front, back and side views of SAM. The point "M" is the reference point for the center of mouth, "LE" is the left ear reference point (ERP), and "RE" is the right ERP. The ERPs are 15 mm posterior to the entrance to ear canal (EEC) along the B-M line (Back-Mouth), as shown in Figure 5.2. The plane passing through the two ear reference points and M is defined as the Reference Plane. The line N-F (Neck-Front) perpendicular to the reference plane and passing through the RE (or LE) is called the Reference Pivoting Line (see Figure 5.3). Line B-M is perpendicular to the N-F line. Both N-F and B-M lines should be marked on the external phantom shell to facilitate handset positioning. Posterior to the N-F line, the thickness of the N-F line, the ear is truncated as illustrated in Figure 5.2. The ear truncation is introduced to avoid the handset from touching the ear lobe, which can cause unstable handset positioning at the cheek. [6]

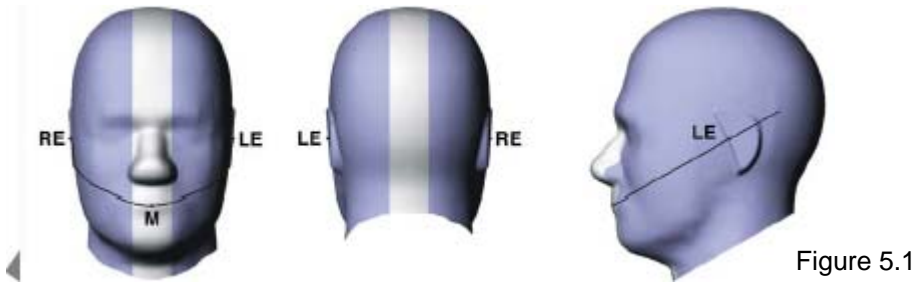

Figure 5.1

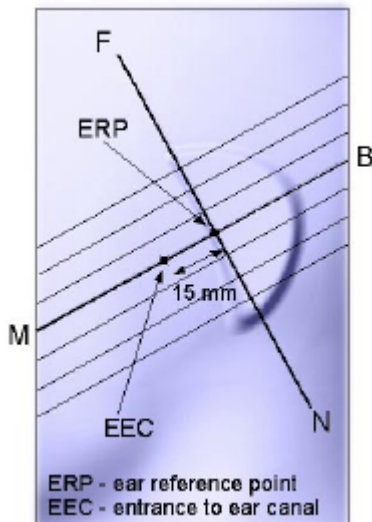

Figure 5.2

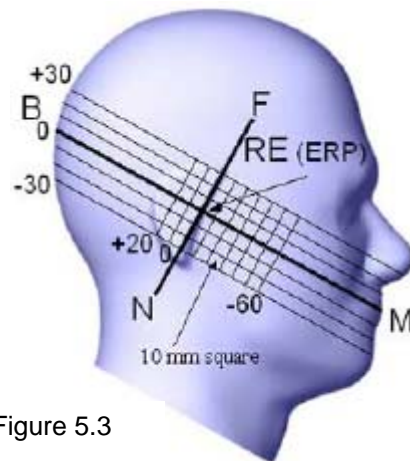

Figure 5.3

2.8.2 Handset Reference Points

Two imaginary lines on the handset were defined: the vertical centerline and the horizontal line. The vertical centerline passes through two points on the front side of the handset: the midpoint of the width w_t of the handset at the level of the acoustic output (point A on Figures 6.1 and 6.2), and the midpoint of the width w_b of the bottom of the handset (point B). The horizontal line is perpendicular to the vertical centerline and passes through the center of the acoustic output (see Figure 6.1). The two lines intersect at point A. For many handsets, point A coincides with the center of the acoustic output. However, the acoustic output may be located elsewhere on the horizontal line. The vertical centerline is not necessarily parallel to the front face of the handset (see Figure 6.2), especially for clamshell handsets, handsets with flip pieces, and other irregularly-shaped handsets. [6]

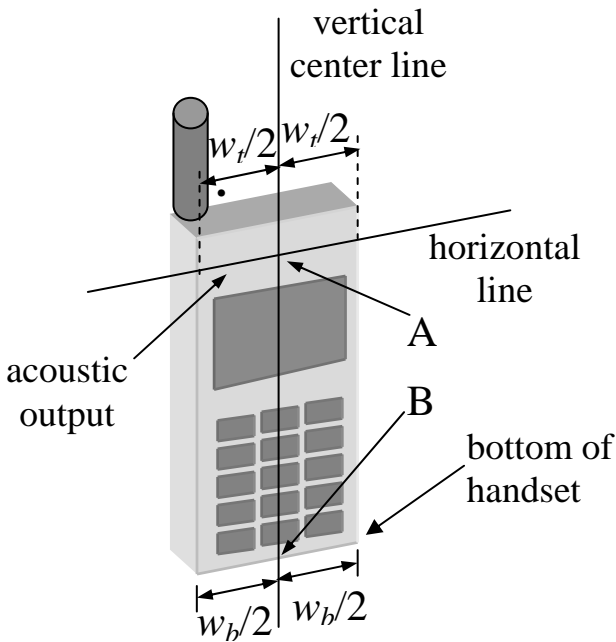

Figure 6.1

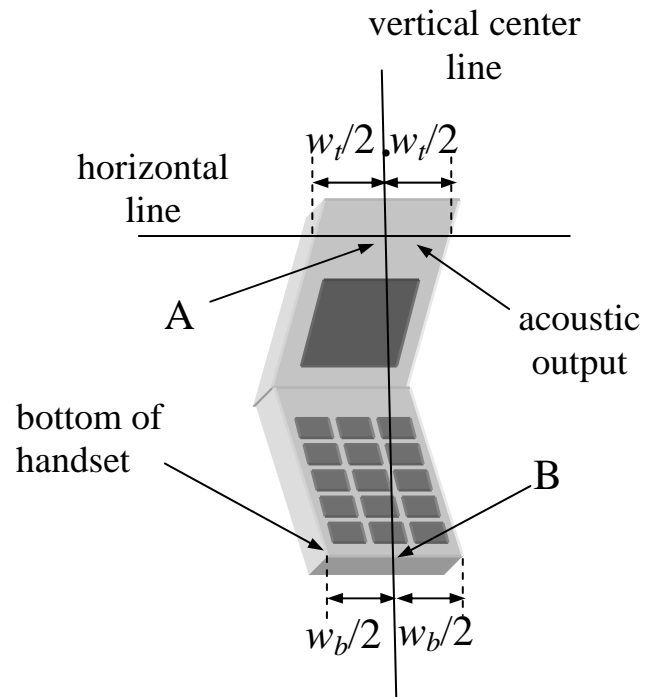

Figure 6.2

2.9 Test Positions

2.9.1 "Cheek" / "Touch" Position

The EUT was positioned close to the surface of the phantom such that point A is on the (virtual) extension of the line passing through points RE and LE on the phantom (see Figure 7), such that the plane defined by the vertical center line and the horizontal line of the handset is approximately parallel to the sagittal plane of the phantom.

The EUT was translated towards the phantom along the line passing through RE and LE until the handset touches the pinna.

While maintaining the handset in this plane, the EUT was rotated it around the LE-RE line until the vertical centerline was in the plane normal to MB-NF including the line MB (called the reference plane).

The EUT was rotated around the vertical centerline until the handset (horizontal line) was symmetrical with respect to the line NF.

While maintaining the vertical centerline in the reference plane, keeping point A on the line passing through RE and LE and maintaining the handset contact with the pinna, the EUT was rotated about the line NF until any point on the handset was in contact with a phantom point below the pinna (cheek). [6] See Figure 7.

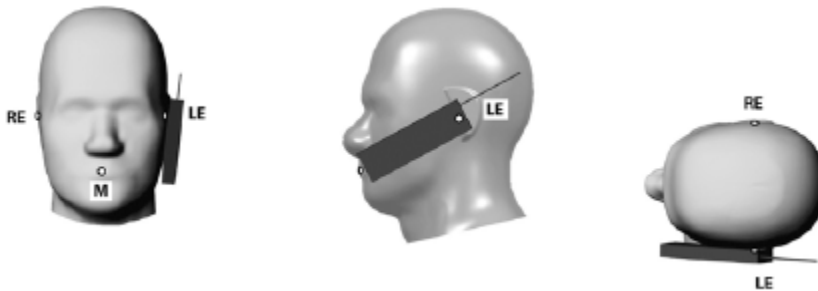

Figure 7

2.9.2 "Tilted" Position

The EUT was in "cheek position".

While maintaining the orientation of the handset move the handset away from the pinna along the line passing through RE and LE in order to enable a rotation of the handset by 15 degrees.

The EUT was rotated around the horizontal line by 15 degrees.

While maintaining the orientation of the handset, the EUT was moved towards the phantom on a line passing through RE and LE until any part of the handset touched the ear. The tilted position is obtained when the contact is on the pinna. If the contact was at any location other than the pinna (e.g., the antenna with the back of the phantom head), the angle of the handset would be reduced. In this case, the tilted position is obtained if any part of the handset was in contact with the pinna as well as a second part of the handset was in contact with the phantom (e.g., the antenna with the back of the head). [6] See Figure 8.

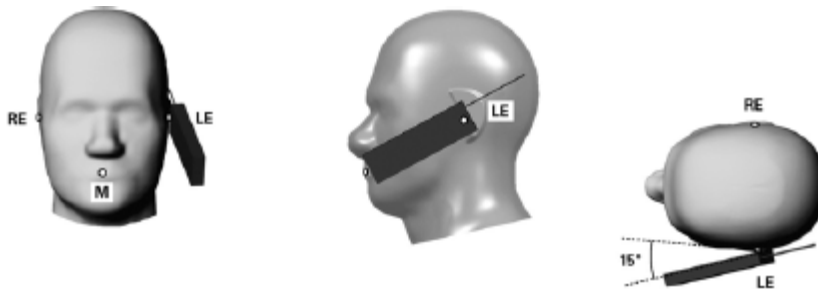

Figure 8

2.9.3 Belt Clip/Holster Configuration

Test configurations for body-worn operated EUTs are carried out while the belt-clip and/or holster is attached to the EUT and placed against a flat phantom in a regular configuration (see Figure 9). An EUT with a headset output is tested with a headset connected to the device.

Body dielectric parameters are used.

There are two categories for accessories for body-worn operation configurations:

1. accessories not containing metallic components
2. accessories containing metallic components.

When the EUT is equipped with accessories not containing metallic components the tests are done with the accessory that dictates the closest spacing to the body. For accessories containing metallic parts a test with each one is implemented. If the multiple accessories share an identical metallic component (e.g. the same metallic belt-clip used with different holsters with no other metallic components) only the accessory that has the closest spacing to the body is tested.

In case that a EUT authorized to be body-worn is not supplied or has no options to be operated with any accessories, a test configuration where a separation distance between the back of the device and the flat phantom is used. All test position spacings are documented.

Transmitters operating in front of a person's face (e.g. push-to-talk configurations) are tested for SAR compliance with the front of the device positioned to face the flat platform. SAR Compliance tests for shoulder, waist or chest-worn transmitters are carried out with the accessories including headsets and microphones attached to the device and placed against a flat phantom in a regular configuration.

The SAR measurements are performed to investigate the worst-case positioning. This is documented and used to perform Body SAR testing. [2].



Figure 9

2.9.4 Headset Configuration

Headsets which have their radiating structure in close proximity to the head are measured according to the following conditions.

- Head tissue liquid is used.
- The EUT is positioned on the surface of the head of phantom according the picture below. Right and left position is tested according to the normal use (see figure 10).
- Additional metallic parts like clips or others are subject of testing, too.



Figure 10

Headsets which have their radiating structure in close proximity to the body are tested as body worn equipment.

2.10 Measurement uncertainty

The uncertainty budget has been determined for the DASY4 system performance check according to IEEE Std. 1528-2003 December 2003.

Error Description	Tol. (± %)	Prob. dist.	Div.	$(\sigma)^1$ (1g)	Std. unc. (1g) (± %)	$(\sigma)^2$
Measurement System						
Probe Calibration	4.8	N	1	1	4.8	∞
Axial Isotropy	4.7	R	$\sqrt{3}$	0.7	1.9	∞
Hemispherical Isotropy	9.6	R	$\sqrt{3}$	0.7	3.9	∞
Boundary Effects	1.0	R	$\sqrt{3}$	1	0.6	∞
Linearity	4.7	R	$\sqrt{3}$	1	2.7	∞
System Detection Limit	1.0	R	$\sqrt{3}$	1	0.6	∞
Readout Electronics	1.0	N	1	1	1.0	∞
Response Time	0.8	R	$\sqrt{3}$	1	0.5	∞
Integration Time	2.6	R	$\sqrt{3}$	1	1.5	∞
RF Ambient Conditions	3.0	R	$\sqrt{3}$	1	1.7	∞
Probe Positioner	0.4	R	$\sqrt{3}$	1	0.2	∞
Probe Positioning	2.9	R	$\sqrt{3}$	1	1.7	∞
Algorithms for Max. SAR Eval.	1.0	R	$\sqrt{3}$	1	0.6	∞
Test Sample Related						
Device Positioning	2.9	N	1	1	2.9	145
Device Holder	3.6	N	1	1	3.6	5
Power Drift	5.0	R	$\sqrt{3}$	1	2.9	∞
Phantom and Setup						
Phantom Uncertainty	4.0	R	$\sqrt{3}$	1	2.3	∞
Liquid Conductivity (target)	5.0	R.	$\sqrt{3}$	0.64	1.8	∞
Liquid Conductivity (meas.)	2.6	N	1	0.64	1.7	∞
Liquid Permittivity (target)	5.0	R	$\sqrt{3}$	0.6	1.7	∞
Liquid Permittivity (meas.)	3.8	N	1	0.6	2.3	∞
Combined Standard Uncertainty					10.4	330
Expanded Uncertainty $k_p=2$						
Coverage Factor for 95%					20.8	

The budget is valid for the frequency range 300MHz – 3 GHz and represent a worst case analysis. For specific tests and configurations, the uncertainty could be considerable smaller.

3. Tissue and System Verification

3.1 Tissue Verification

Dielectric parameters of the simulating liquids were verified using a Dielectric Probe Kit Agilent 85070D to a tolerance of $\pm 5\%$.

Room Temperature: 22.1 -22.6 ° C

	Measured Tissue Parameters	
	2450 MHz Muscle	
	Target	Measured 31.08.2009 25.08.2009 26.08.2009
Date		22.1 ° C
Liquid Temperature:		22.1 ° C
Dielectric Constant: ϵ	52.7	52.9
Conductivity: σ	1.95	2.03

3.2 System Verification

Prior to the assessment, the system was verified by using a 2450 MHz validation dipole. Power level of 250 mW was supplied to the dipole antenna placed under the flat section of Oval Flat Phantom. This system validation is valid for a frequency range of 900 ± 100 MHz.

The system was verified to a tolerance of $\pm 10\%$.

Liquid Temperature: 22.0 -22.3 ° C
 Room Temperature: 22.1 -22.6 ° C
 Liquid Depth: > 15.5 cm

System Dipole Validation Target & Measurement					
Date	System Validation Kit:	Liquid	Targeted SAR 1g (mW/g)	Measured SAR 1g (mW/g)	Deviation (%)
31.08.2009	D2450V2 SN722	2450 MHz Muscle	54,8	52,0	-5,11
25.08.2009	D2450V2 SN722	2450 MHz Muscle	54,8	50,4	-8,03
26.08.2009	D2450V2 SN722	2450 MHz Muscle	54,8	50,8	-7,30

Comment: Please find attached the measurement plots.

4. Test Results

Procedures Used To Establish Test Signal

The EUT was placed into simulated call mode (e.g. AMPS, Cellular CDMA & PCS CDMA modes) using manufacturers test codes. Such test signals offer a consistent means for testing SAR and are recommended for evaluating SAR [2]. The actual transmission is activated through a base station simulator or similar when test modes are not available or inappropriate for testing the EUT.

The EUT is battery operated. The battery used for the SAR measurements was completely charged. The device was tested at full power verified by implementing conducted output power measurements. For confirming of the output power it was tested before and after each SAR measurement. The test was repeated if a conducted power deviation of more than 5 % occurred.

Mixture Type: 2450 MHz Muscle
Date: 25.08.2009 - 31.08.2009
Liquid Temperature: 22.0 -22.3 °C **Room Temperature:** 22.1 -22.6 °C

Frequency			Power Drift dBm	Antenna Pos.	Phantom Section	Test Position 0mm	SAR (W/kg)
MHz	Channel	Modulation					
2401	00	FHSS / GFSK	-0.073	Integral	Flat	Front	0.583
2401	00	FHSS / GFSK	-0.149	Integral	Flat	Back	0.045
2437	42	FHSS / GFSK	0.142	Integral	Flat	Front	0.504
2441	42	FHSS / GFSK	0.171	Integral	Flat	Back	0.049
2480	84	FHSS / GFSK	0.114	Integral	Flat	Front	0.376
2480	84	FHSS / GFSK	-0.199	Integral	Flat	Back	0.037
2412	1	DSSS	-0.106	Integral	Flat	Front	0.011
2412	1	DSSS	-0.194	Integral	Flat	Back	0.198
2437	6	DSSS	-0.040	Integral	Flat	Front	0.012
2437	6	DSSS	-0.146	Integral	Flat	Back	0.245
2462	11	DSSS	0.193	Integral	Flat	Front	0.013
2462	11	DSSS	-0.152	Integral	Flat	Back	0.281
2412	1	OFDM	-0.041	Integral	Flat	Front	0.194
2437	6	OFDM	-0.167	Integral	Flat	Back	0.011
2437	6	OFDM	-0.146	Integral	Flat	Front	0.189
2462	11	OFDM	-0.079	Integral	Flat	Back	0.248

Limits:

Exposure Limits	SAR (W/kg)					
	Uncontrolled Exposure/General Population Environment			Controlled Exposure/Occupational Environment		
Region	Australia	US	EU	Australia	US	EU
Spatial Average SAR (averaged over the whole body)	0.08	0.08	0.08	0.40	0.40	0.40
Spatial Peak SAR (averaged over any 1 g of tissue)	2.00	1.60	2.00	10.0	8.00	10.0
Spatial Peak SAR (Hands, Feet, Ankles, Wrist) (averaged over any 10 g of tissue)	4.00	4.00	4.00	20.0	20.0	20.0

Notes:

1. Test data represent the worst case SAR value and test procedure used are according to OET Bulletin 65, Supplement C (01-01).
2. All modes of operation were investigated.

5. Transmitter co-location performance evaluation

The following transmitters are implemented in the device:

- Bluetooth
- WLAN 802.11b/g
- 2.4GHz FHSS

For co-location calculation a transmitter has to fulfill multiple conditions before it has to be taken into account. The mutual distance of the antennas of two transmitters has to be lower than 200mm and the transmitter has to have a transmitter power above a certain threshold value before it is of any concern regarding transmitter co-transmission or co-location.

The euclidean distances between the various transmitter antennas in the device are summarized in the table below. Again each technology that is closer than 200mm to another transmitter is relevant.

Distance Antenna to Antenna			
	Bluetooth	WLAN	2.4GHz FHSS
Bluetooth		107mm	20mm
WLAN	107mm		103mm
2.4GHz FHSS	20mm	103mm	

The power threshold is given by the expression $60/f$ [GHz]. Any transmitter whose power level is larger than the value given by this threshold has to be taken into account.

Conducted Power Threshold					
Transmitter	Highest Frequency [MHz]	Conducted Power [dBm]	Conducted Power [mW]	$60/f$ [GHz] Threshold	Over Threshold
Bluetooth	2480	0.75	1.19	24.19	No
WLAN 802.11b	2462	15.7	37.2	24.37	Yes
WLAN 802.11g	2462	20.6	114.8	24.37	Yes
2.4GHz FHSS	2474	20.3	107.2	24.25	Yes

The following table list the co-transmission capability of the transmitters of the device.

Co-transmission capability			
	Bluetooth	WLAN	2.4GHz FHSS
Bluetooth		Yes	Yes
WLAN	Yes		Yes
2.4GHz FHSS	Yes	Yes	

Regarding the data given in the tables the following transmitter modes have to be taken into account:

- WLAN 802.11b/g
- 2.4GHz FHSS

For these transmitter modes the co-transmission SAR values are obtained:

SAR co-location results				
Worst Case Position	2.4GHz FHSS	WLAN 802.11b	WLAN 802.11g	Σ SAR
	2474MHz	2462MHz	2462MHz	
Flat	0.376	0.281		0.657
Flat	0.376		0.248	0.624

Limits:

Exposure Limits	SAR (W/kg)					
	Uncontrolled Exposure/General Population Environment			Controlled Exposure/Occupational Environment		
Region	Australia	US	EU	Australia	US	EU
Spatial Average SAR (averaged over the whole body)	0.08	0.08	0.08	0.40	0.40	0.40
Spatial Peak SAR (averaged over any 1 g of tissue)	2.00	1.60	2.00	10.0	8.00	10.0
Spatial Peak SAR (Hands, Feet, Ankles, Wrist) (averaged over any 10 g of tissue)	4.00	4.00	4.00	20.0	20.0	20.0

6. References

- [1] ANSI/IEEE C95.3 – 1991, *IEEE Recommended Practice for the Measurement of Potentially Hazardous Electromagnetic fields, 300 kHz to 100 GHz*, New York: IEEE, Aug. 1992
- [2] Federal Communications Commission, OET Bulletin 65 (Edition 97-01), Supplement C (Edition 01-01), *Evaluating Compliance with FCC Guidelines for Human Exposure to Radiofrequency Electromagnetic Fields*, July 2001.
- [3] T. Schmid, O. Egger, N. Kuster, *Automated E-field scanning system for dosimetric assessments*, IEEE Transaction on Microwave Theory and Techniques, vol. 44, Jan. 1996, pp. 105-113.
- [4] W. Gander, *Computermathematics*, Birkhaeuser, Basel, 1992.
- [5] W.H. Press, S.A. Teukolsky, W.T. Vetterling, and B.P. Flannery, *Numerical Recipes in C, The Art of Scientific Computing*, Second edition, Cambridge University Press, 1992.
- [6] IEEE Standards Coordinating Committee 34 – IEEE Std. 1528-2003, December 2003, *Recommended Practice for Determining the Peak Spatial-Average Absorption Rate (SAR in the Human Body Due to Wireless Communications Devices: Experimental Techniques*.
- [7] DASY4 *Dosimetric Assessment System Manual*; Draft; September 6, 2002; Schmid & Partner Engineering AG

7. Annex

1.	Annex A	Calibration Certificate	D2450V2 SN722 ET3DV6 SN1711 DAE3V1-522	32
2.	Annex B	Measurement Plots		56
3.	Annex C	Pictures		78

Annex A

Calibration Certificate

Note:

The calibration cycle for SAR field probes and related equipment is determined to one year. According to Eurofins's internal quality management instruction based on EN 17025 the calibration cycle for other test equipment is determined to 2 years. Additionally, Eurofins has prolonged the calibration interval for SPEAG System Validation Dipoles by two additional years. These QM procedures are acknowledged by the accreditation bodies mentioned on page 3 of this report during several accreditation audits.



Accredited by the Swiss Federal Office of Metrology and Accreditation
The Swiss Accreditation Service is one of the signatories to the EA
Multilateral Agreement for the recognition of calibration certificates

Accreditation No.: **SCS 108**

Client **Dr. Genz**

Certificate No. **D2450V2-722_Sep06**

CALIBRATION CERTIFICATE

Object **D2450V2 - SN: 722**

Calibration procedure(s) **QA CAL-05.v6
Calibration procedure for dipole validation kits**

Calibration date: **September 27, 2006**

Condition of the calibrated item **In Tolerance**

This calibration certificate documents the traceability to national standards, which realize the physical units of measurements (SI).
The measurements and the uncertainties with confidence probability are given on the following pages and are part of the certificate.

All calibrations have been conducted in the closed laboratory facility: environment temperature (22 ± 3)°C and humidity < 70%.

Calibration Equipment used (M&TE critical for calibration)

Primary Standards	ID #	Cal Date (Calibrated by, Certificate No.)	Scheduled Calibration
Power meter EPM-442A	GB37480704	04-Oct-05 (METAS, No. 251-00516)	Oct-06
Power sensor HP 8481A	US37292783	04-Oct-05 (METAS, No. 251-00516)	Oct-06
Reference 20 dB Attenuator	SN: 5086 (20g)	10-Aug-06 (METAS, No 217-00591)	Aug-07
Reference 10 dB Attenuator	SN: 5047.2 (10r)	10-Aug-06 (METAS, No 217-00591)	Aug-07
Reference Probe ES3DV2	SN 3025	28-Oct-05 (SPEAG, No. ES3-3025_Oct05)	Oct-06
DAE4	SN 601	15-Dec-05 (SPEAG, No. DAE4-601_Dec05)	Dec-06

Secondary Standards	ID #	Check Date (in house)	Scheduled Check
Power sensor HP 8481A	MY41092317	18-Oct-02 (SPEAG, in house check Oct-05)	In house check: Oct-07
RF generator Agilent E4421B	MY41000675	11-May-05 (SPEAG, in house check Nov-05)	In house check: Nov-07
Network Analyzer HP 8753E	US37390585 S4206	18-Oct-01 (SPEAG, in house check Nov-05)	In house check: Nov-06

Calibrated by: **Claudio Leubler** **Laboratory Technician** *[Signature]*

Approved by: **Katja Pokovic** **Technical Manager** *[Signature]*

Issued: September 28, 2006

This calibration certificate shall not be reproduced except in full without written approval of the laboratory.



Accredited by the Swiss Federal Office of Metrology and Accreditation
The Swiss Accreditation Service is one of the signatories to the EA
Multilateral Agreement for the recognition of calibration certificates

Accreditation No.: **SCS 108**

Glossary:

TSL	tissue simulating liquid
ConvF	sensitivity in TSL / NORM x,y,z
N/A	not applicable or not measured

Calibration is Performed According to the Following Standards:

- IEEE Std 1528-2003, "IEEE Recommended Practice for Determining the Peak Spatial-Averaged Specific Absorption Rate (SAR) in the Human Head from Wireless Communications Devices: Measurement Techniques", December 2003
- CENELEC EN 50361, "Basic standard for the measurement of Specific Absorption Rate related to human exposure to electromagnetic fields from mobile phones (300 MHz - 3 GHz), July 2001
- Federal Communications Commission Office of Engineering & Technology (FCC OET), "Evaluating Compliance with FCC Guidelines for Human Exposure to Radiofrequency Electromagnetic Fields; Additional Information for Evaluating Compliance of Mobile and Portable Devices with FCC Limits for Human Exposure to Radiofrequency Emissions", Supplement C (Edition 01-01) to Bulletin 65

Additional Documentation:

- DASY4 System Handbook

Methods Applied and Interpretation of Parameters:

- Measurement Conditions:** Further details are available from the Validation Report at the end of the certificate. All figures stated in the certificate are valid at the frequency indicated.
- Antenna Parameters with TSL:** The dipole is mounted with the spacer to position its feed point exactly below the center marking of the flat phantom section, with the arms oriented parallel to the body axis.
- Feed Point Impedance and Return Loss:** These parameters are measured with the dipole positioned under the liquid filled phantom. The impedance stated is transformed from the measurement at the SMA connector to the feed point. The Return Loss ensures low reflected power. No uncertainty required.
- Electrical Delay:** One-way delay between the SMA connector and the antenna feed point. No uncertainty required.
- SAR measured:** SAR measured at the stated antenna input power.
- SAR normalized:** SAR as measured, normalized to an input power of 1 W at the antenna connector.
- SAR for nominal TSL parameters:** The measured TSL parameters are used to calculate the nominal SAR result.

Measurement Conditions

DASY system configuration, as far as not given on page 1.

DASY Version	DASY4	V4.7
Extrapolation	Advanced Extrapolation	
Phantom	Modular Flat Phantom V5.0	
Distance Dipole Center - TSL	10 mm	with Spacer
Zoom Scan Resolution	dx, dy, dz = 5 mm	
Frequency	2450 MHz ± 1 MHz	

Head TSL parameters

The following parameters and calculations were applied.

	Temperature	Permittivity	Conductivity
Nominal Head TSL parameters	22.0 °C	39.2	1.80 mho/m
Measured Head TSL parameters	(22.0 ± 0.2) °C	37.8 ± 6 %	1.77 mho/m ± 6 %
Head TSL temperature during test	(22.0 ± 0.2) °C	—	—

SAR result with Head TSL

SAR averaged over 1 cm³ (1 g) of Head TSL	condition	
SAR measured	250 mW input power	13.6 mW / g
SAR normalized	normalized to 1W	54.4 mW / g
SAR for nominal Head TSL parameters ¹	normalized to 1W	53.8 mW / g ± 17.0 % (k=2)

SAR averaged over 10 cm³ (10 g) of Head TSL	condition	
SAR measured	250 mW input power	6.31 mW / g
SAR normalized	normalized to 1W	25.2 mW / g
SAR for nominal Head TSL parameters ¹	normalized to 1W	25.0 mW / g ± 16.5 % (k=2)

¹ Correction to nominal TSL parameters according to d), chapter "SAR Sensitivities"

Body TSL parameters

The following parameters and calculations were applied.

	Temperature	Permittivity	Conductivity
Nominal Body TSL parameters	22.0 °C	52.7	1.95 mho/m
Measured Body TSL parameters	(22.0 ± 0.2) °C	52.1 ± 6 %	1.97 mho/m ± 6 %
Body TSL temperature during test	(21.6 ± 0.2) °C	---	---

SAR result with Body TSL

SAR averaged over 1 cm³ (1 g) of Body TSL	Condition	
SAR measured	250 mW input power	13.8 mW / g
SAR normalized	normalized to 1W	55.2 mW / g
SAR for nominal Body TSL parameters ²	normalized to 1W	54.5 mW / g ± 17.0 % (k=2)

SAR averaged over 10 cm³ (10 g) of Body TSL	Condition	
SAR measured	250 mW input power	6.39 mW / g
SAR normalized	normalized to 1W	25.6 mW / g
SAR for nominal Body TSL parameters ²	normalized to 1W	25.4 mW / g ± 16.5 % (k=2)

² Correction to nominal TSL parameters according to d), chapter "SAR Sensitivities"

Appendix

Antenna Parameters with Head TSL

Impedance, transformed to feed point	$50.4 \Omega + 6.4 j\Omega$
Return Loss	- 24.0 dB

Antenna Parameters with Body TSL

Impedance, transformed to feed point	$46.5 \Omega + 6.3 j\Omega$
Return Loss	- 22.6 dB

General Antenna Parameters and Design

Electrical Delay (one direction)	1.153 ns
----------------------------------	----------

After long term use with 100W radiated power, only a slight warming of the dipole near the feedpoint can be measured.

The dipole is made of standard semirigid coaxial cable. The center conductor of the feeding line is directly connected to the second arm of the dipole. The antenna is therefore short-circuited for DC-signals.

No excessive force must be applied to the dipole arms, because they might bend or the soldered connections near the feedpoint may be damaged.

Additional EUT Data

Manufactured by	SPEAG
Manufactured on	October 16, 2002

DASY4 Validation Report for Head TSL

Date/Time: 27.09.2006 11:58:51

Test Laboratory: SPEAG, Zurich, Switzerland

DUT: Dipole 2450 MHz; Type: D2450V2; Serial: D2450V2 - SN722

Communication System: CW-2450; Frequency: 2450 MHz; Duty Cycle: 1:1

Medium: HSL U10 BB;

Medium parameters used: $f = 2450$ MHz; $\sigma = 1.77$ mho/m; $\epsilon_r = 37.8$; $\rho = 1000$ kg/m³

Phantom section: Flat Section

Measurement Standard: DASY4 (High Precision Assessment)

DASY4 Configuration:

- Probe: ES3DV2 - SN3025 (HF); ConvF(4.4, 4.4, 4.4); Calibrated: 28.10.2005
- Sensor-Surface: 4mm (Mechanical Surface Detection)
- Electronics: DAE4 Sn601; Calibrated: 15.12.2005
- Phantom: Flat Phantom 5.0 (front); Type: QD000P50AA; ;
- Measurement SW: DASY4, V4.7 Build 44; Postprocessing SW: SEMCAD, V1.8 Build 171

Pin = 250 mW; d = 10 mm/Zoom Scan (7x7x7)/Cube 0:

Measurement grid: dx=5mm, dy=5mm, dz=5mm

Reference Value = 90.6 V/m; Power Drift = -0.016 dB

Peak SAR (extrapolated) = 28.4 W/kg

SAR(1 g) = 13.6 mW/g; SAR(10 g) = 6.31 mW/g

Maximum value of SAR (measured) = 15.2 mW/g

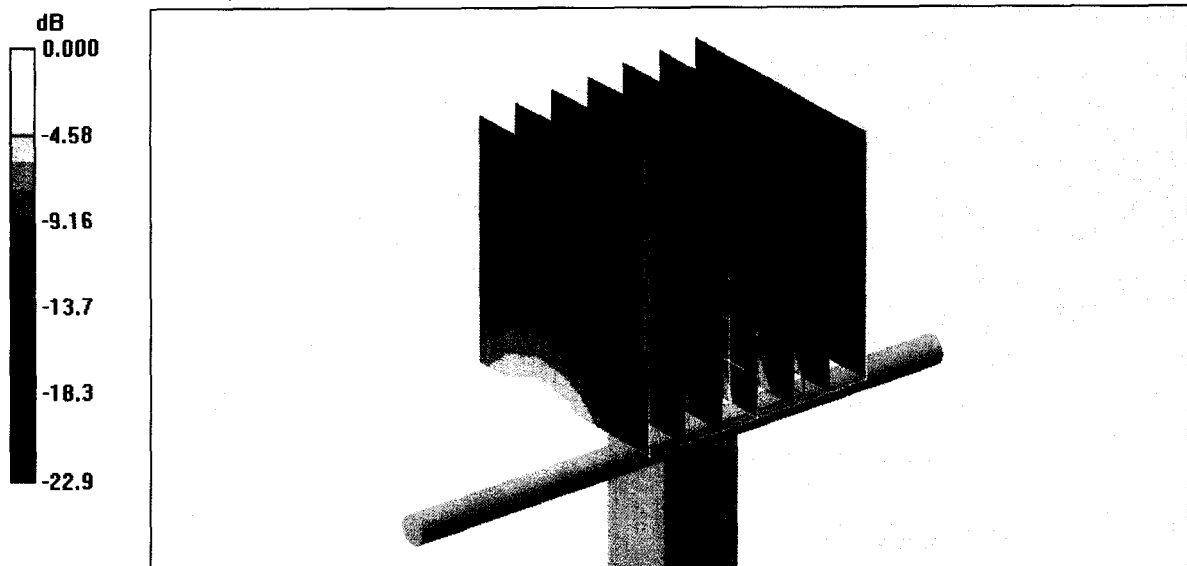

0 dB = 15.2mW/g

Impedance Measurement Plot for Head TSL

27 Sep 2006 10:24:48

CH1 S11 1 U FS 1: 50.445 Ω 6.3594 Ω 413.11 μH 2 450.000 000 MHz

*
Del
Cor

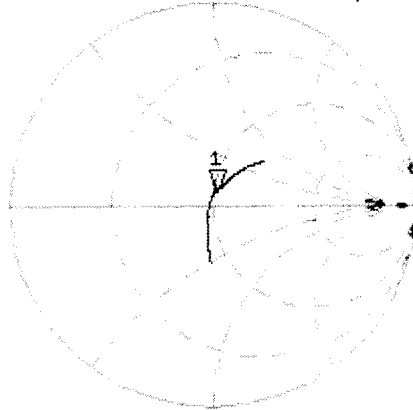

Avg
16
↑

CH2 S11 LOG 5 dB/REF -20 dB 1: -23.958 dB 2 450.000 000 MHz

Cor
Avg
16
↑

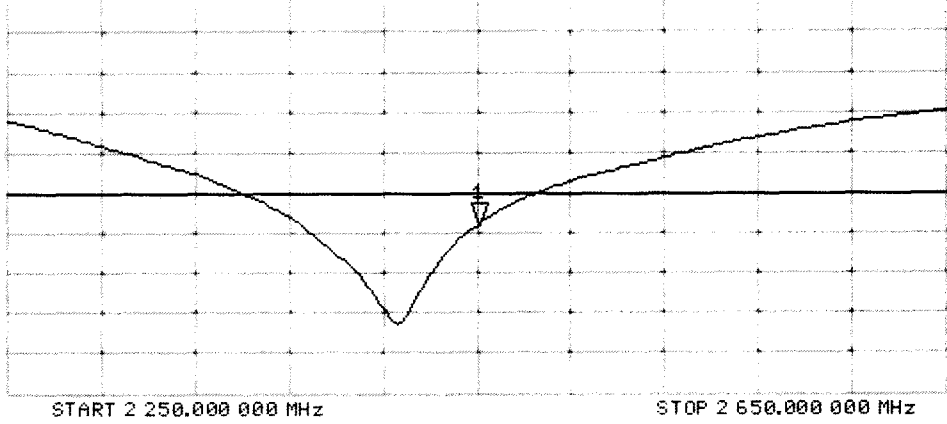

DASY4 Validation Report for Body TSL

Date/Time: 27.09.2006 14:44:54

Test Laboratory: SPEAG, Zurich, Switzerland

DUT: Dipole 2450 MHz; Type: D2450V2; Serial: D2450V2 - SN722

Communication System: CW-2450; Frequency: 2450 MHz; Duty Cycle: 1:1

Medium: MSL U10 BB;

Medium parameters used: $f = 2450$ MHz; $\sigma = 1.97$ mho/m; $\epsilon_r = 52.2$; $\rho = 1000$ kg/m³

Phantom section: Flat Section

Measurement Standard: DASY4 (High Precision Assessment)

DASY4 Configuration:

- Probe: ES3DV2 - SN3025 (HF); ConvF(4.06, 4.06, 4.06); Calibrated: 28.10.2005
- Sensor-Surface: 4mm (Mechanical Surface Detection)
- Electronics: DAE4 Sn601; Calibrated: 15.12.2005
- Phantom: Flat Phantom 5.0 (back); Type: QD000P50AA; ;
- Measurement SW: DASY4, V4.7 Build 44; Postprocessing SW: SEMCAD, V1.8 Build 171

Pin = 250 mW; d = 10 mm/Zoom Scan (7x7x7)/Cube 0:

Measurement grid: dx=5mm, dy=5mm, dz=5mm

Reference Value = 89.4 V/m; Power Drift = 0.005 dB

Peak SAR (extrapolated) = 29.3 W/kg

SAR(1 g) = 13.8 mW/g; SAR(10 g) = 6.39 mW/g

Maximum value of SAR (measured) = 15.7 mW/g

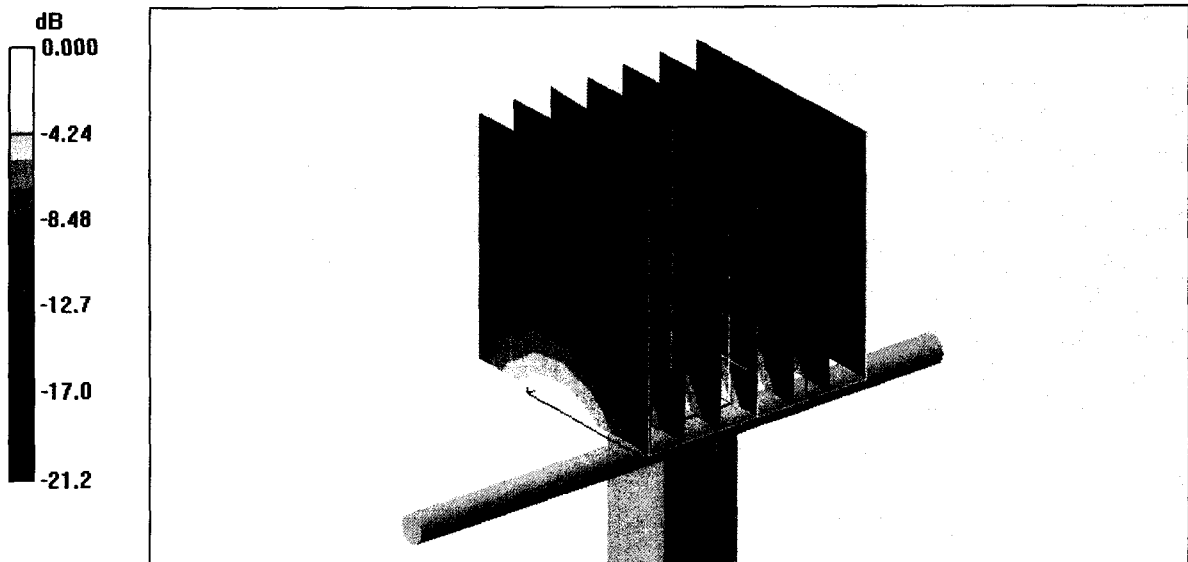

0 dB = 15.7mW/g

Impedance Measurement Plot for Body TSL

27 Sep 2006 10:26:30

CH1 S11 1 U FS 1: 46.539 Ω 6.2676 Ω 407.15 pF 2 450.000 000 MHz

*
Del
Cor

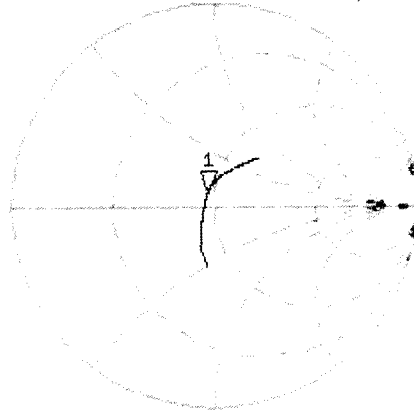

Avg
16
↑

CH2 S11 LOG 5 dB/REF -20 dB 1:-22.612 dB 2 450.000 000 MHz

Cor

Avg
16
↑

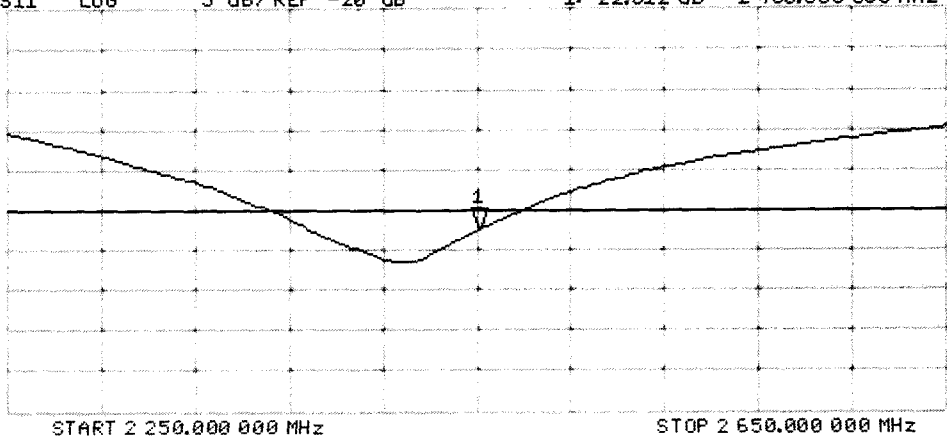



Accredited by the Swiss Accreditation Service (SAS)
The Swiss Accreditation Service is one of the signatories to the EA
Multilateral Agreement for the recognition of calibration certificates

Accreditation No.: **SCS 108**

Client **Eurofins**

Certificate No: **ET3-1711_Sep08**

CALIBRATION CERTIFICATE

Object **ET3DV6 - SN:1711**

Calibration procedure(s) **QA-CAL-01-v6, QA-CAL-12-v5 and QA-CAL-23-v3
Calibration procedure for dosimetric E-field probes**

Calibration date: **September 17, 2008**

Condition of the calibrated item **In Tolerance**

This calibration certificate documents the traceability to national standards, which realize the physical units of measurements (SI).
The measurements and the uncertainties with confidence probability are given on the following pages and are part of the certificate.

All calibrations have been conducted in the closed laboratory facility: environment temperature (22 ± 3)°C and humidity < 70%.

Calibration Equipment used (M&TE critical for calibration)

Primary Standards	ID #	Cal Date (Certificate No.)	Scheduled Calibration
Power meter E4419B	GB41293874	1-Apr-08 (No. 217-00788)	Apr-09
Power sensor E4412A	MY41495277	1-Apr-08 (No. 217-00788)	Apr-09
Power sensor E4412A	MY41498087	1-Apr-08 (No. 217-00788)	Apr-09
Reference 3 dB Attenuator	SN: S5054 (3c)	1-Jul-08 (No. 217-00865)	Jul-09
Reference 20 dB Attenuator	SN: S5086 (20b)	31-Mar-08 (No. 217-00787)	Apr-09
Reference 30 dB Attenuator	SN: S5129 (30b)	1-Jul-08 (No. 217-00866)	Jul-09
Reference Probe ES3DV2	SN: 3013	2-Jan-08 (No. ES3-3013_Jan08)	Jan-09
DAE4	SN: 660	9-Sep-08 (No. DAE4-660_Sep08)	Sep-09
Secondary Standards	ID #	Check Date (in house)	Scheduled Check
RF generator HP 8648C	US3642U01700	4-Aug-99 (in house check Oct-07)	In house check: Oct-09
Network Analyzer HP 8753E	US37390585	18-Oct-01 (in house check Oct-07)	In house check: Oct-08

	Name	Function	Signature
Calibrated by:	Katja Pokovic	Technical Manager	
Approved by:	Niels Kuster	Quality Manager	

Issued: September 17, 2008

This calibration certificate shall not be reproduced except in full without written approval of the laboratory.



Accredited by the Swiss Accreditation Service (SAS)
The Swiss Accreditation Service is one of the signatories to the EA
Multilateral Agreement for the recognition of calibration certificates

Accreditation No.: **SCS 108**

Glossary:

TSL	tissue simulating liquid
NORM _{x,y,z}	sensitivity in free space
ConvF	sensitivity in TSL / NORM _{x,y,z}
DCP	diode compression point
Polarization φ	φ rotation around probe axis
Polarization ϑ	ϑ rotation around an axis that is in the plane normal to probe axis (at measurement center), i.e., $\vartheta = 0$ is normal to probe axis

Calibration is Performed According to the Following Standards:

- IEEE Std 1528-2003, "IEEE Recommended Practice for Determining the Peak Spatial-Averaged Specific Absorption Rate (SAR) in the Human Head from Wireless Communications Devices: Measurement Techniques", December 2003
- IEC 62209-1, "Procedure to measure the Specific Absorption Rate (SAR) for hand-held devices used in close proximity to the ear (frequency range of 300 MHz to 3 GHz)", February 2005

Methods Applied and Interpretation of Parameters:

- NORM_{x,y,z}**: Assessed for E-field polarization $\vartheta = 0$ ($f \leq 900$ MHz in TEM-cell; $f > 1800$ MHz: R22 waveguide). NORM_{x,y,z} are only intermediate values, i.e., the uncertainties of NORM_{x,y,z} does not effect the E²-field uncertainty inside TSL (see below *ConvF*).
- NORM(f)_{x,y,z} = NORM_{x,y,z} * frequency_response** (see Frequency Response Chart). This linearization is implemented in DASY4 software versions later than 4.2. The uncertainty of the frequency response is included in the stated uncertainty of *ConvF*.
- DCP_{x,y,z}**: DCP are numerical linearization parameters assessed based on the data of power sweep (no uncertainty required). DCP does not depend on frequency nor media.
- ConvF and Boundary Effect Parameters**: Assessed in flat phantom using E-field (or Temperature Transfer Standard for $f \leq 800$ MHz) and inside waveguide using analytical field distributions based on power measurements for $f > 800$ MHz. The same setups are used for assessment of the parameters applied for boundary compensation (alpha, depth) of which typical uncertainty values are given. These parameters are used in DASY4 software to improve probe accuracy close to the boundary. The sensitivity in TSL corresponds to NORM_{x,y,z} * ConvF whereby the uncertainty corresponds to that given for ConvF. A frequency dependent ConvF is used in DASY version 4.4 and higher which allows extending the validity from ± 50 MHz to ± 100 MHz.
- Spherical isotropy (3D deviation from isotropy)**: in a field of low gradients realized using a flat phantom exposed by a patch antenna.
- Sensor Offset**: The sensor offset corresponds to the offset of virtual measurement center from the probe tip (on probe axis). No tolerance required.

Probe ET3DV6

SN:1711

Manufactured:	August 7, 2002
Last calibrated:	September 19, 2007
Recalibrated:	September 17, 2008

Calibrated for DASY Systems

(Note: non-compatible with DASY2 system!)

DASY - Parameters of Probe: ET3DV6 SN:1711**Sensitivity in Free Space^A****Diode Compression^B**

NormX	1.92 ± 10.1%	$\mu\text{V}/(\text{V}/\text{m})^2$	DCP X	90 mV
NormY	1.86 ± 10.1%	$\mu\text{V}/(\text{V}/\text{m})^2$	DCP Y	93 mV
NormZ	2.04 ± 10.1%	$\mu\text{V}/(\text{V}/\text{m})^2$	DCP Z	92 mV

Sensitivity in Tissue Simulating Liquid (Conversion Factors)

Please see Page 8.

Boundary Effect

TSL 900 MHz Typical SAR gradient: 5 % per mm

Sensor Center to Phantom Surface Distance		3.7 mm	4.7 mm
SAR _{be} [%]	Without Correction Algorithm	9.8	5.8
SAR _{be} [%]	With Correction Algorithm	0.9	0.2

TSL 1810 MHz Typical SAR gradient: 10 % per mm

Sensor Center to Phantom Surface Distance		3.7 mm	4.7 mm
SAR _{be} [%]	Without Correction Algorithm	10.4	6.5
SAR _{be} [%]	With Correction Algorithm	0.8	0.4

Sensor Offset

Probe Tip to Sensor Center **2.7 mm**

The reported uncertainty of measurement is stated as the standard uncertainty of measurement multiplied by the coverage factor k=2, which for a normal distribution corresponds to a coverage probability of approximately 95%.

^A The uncertainties of NormX,Y,Z do not affect the E²-field uncertainty inside TSL (see Page 8).

^B Numerical linearization parameter: uncertainty not required.

Frequency Response of E-Field

(TEM-Cell: ifi110 EXX, Waveguide: R22)

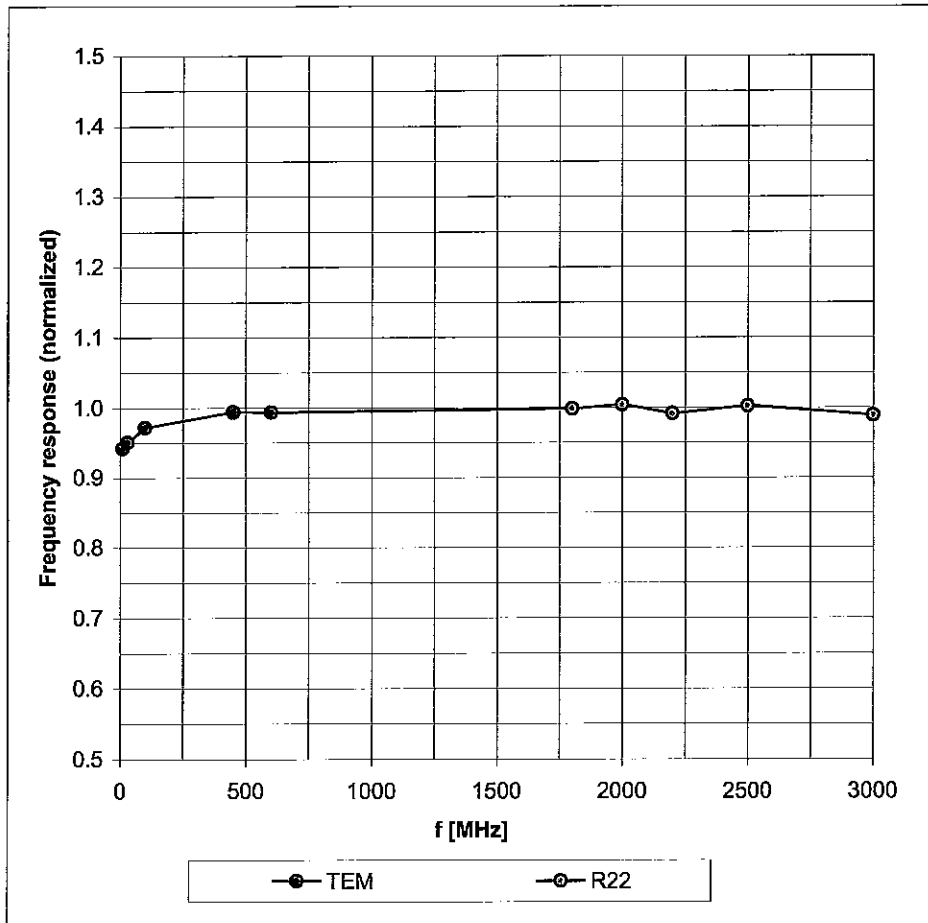

Uncertainty of Frequency Response of E-field: $\pm 6.3\%$ (k=2)

Receiving Pattern (ϕ), $\theta = 0^\circ$

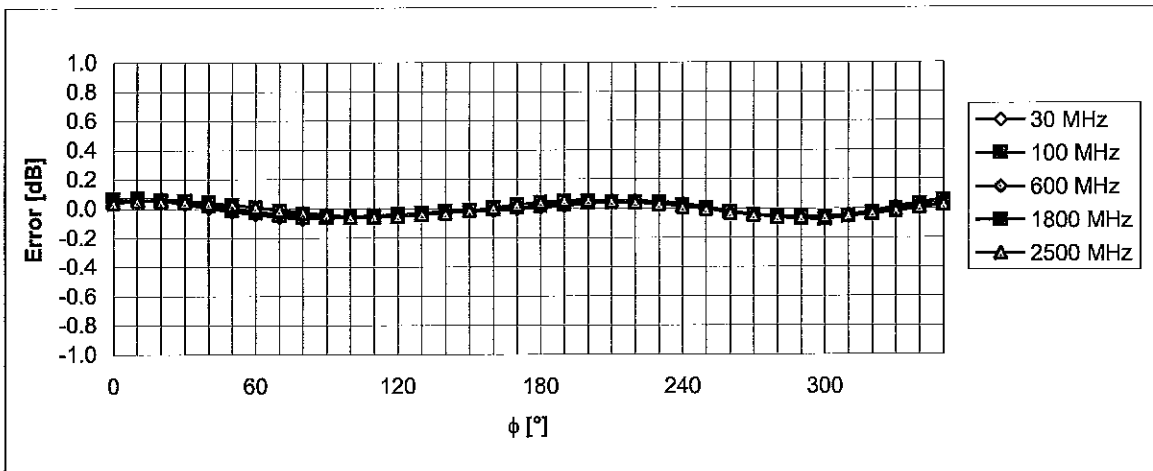
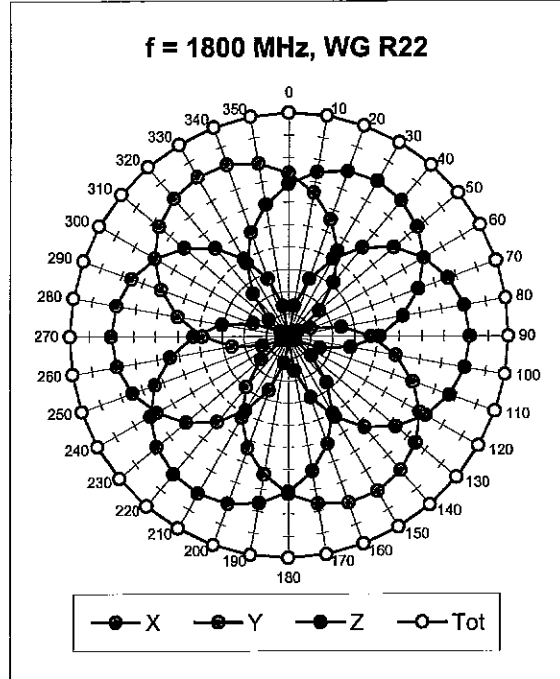
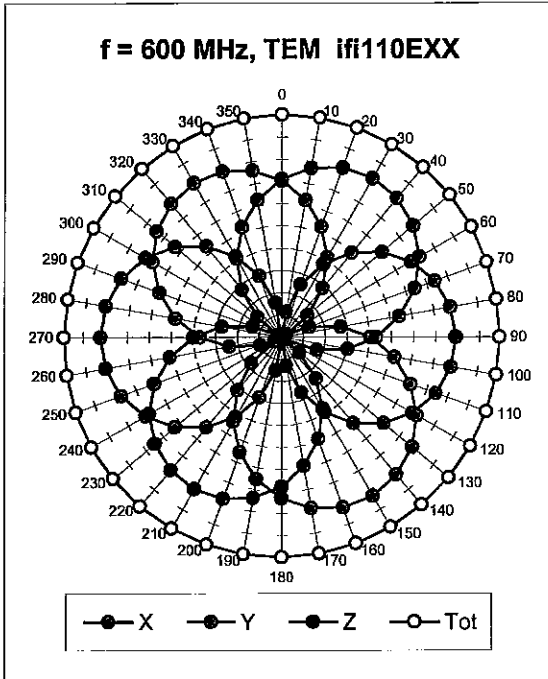

Uncertainty of Axial Isotropy Assessment: $\pm 0.5\%$ ($k=2$)

Dynamic Range $f(\text{SAR}_{\text{head}})$ (Waveguide R22, $f = 1800 \text{ MHz}$)

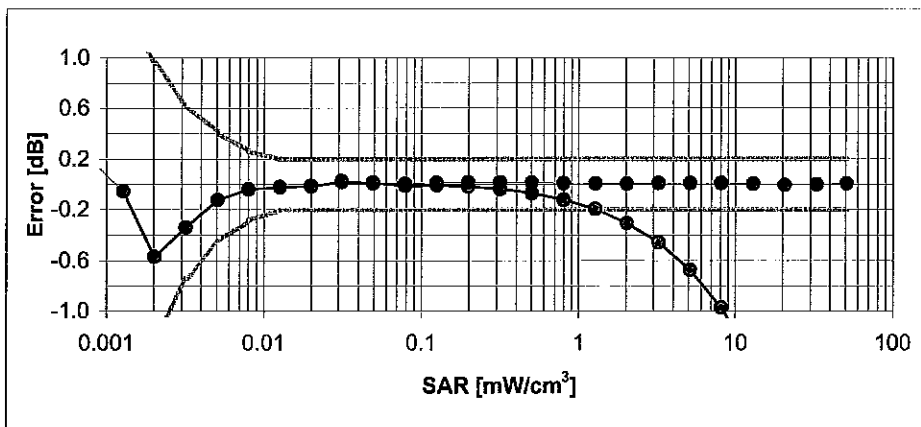
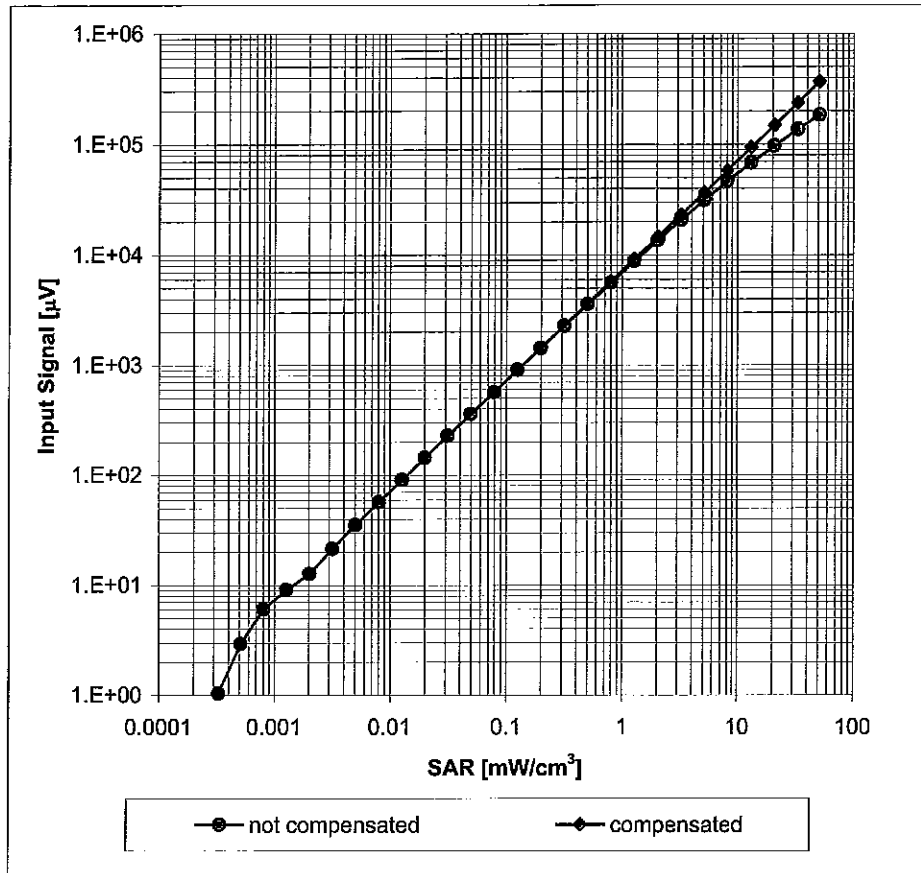

Uncertainty of Linearity Assessment: $\pm 0.6\%$ ($k=2$)

Conversion Factor Assessment

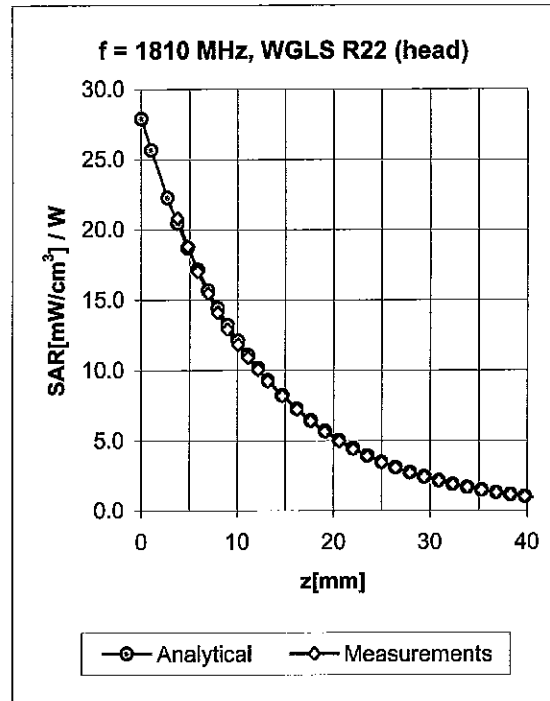
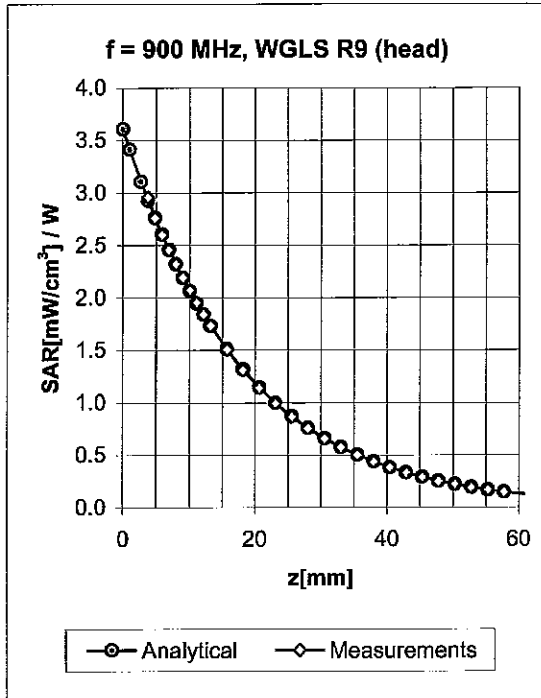

f [MHz]	Validity [MHz] ^c	TSL	Permittivity	Conductivity	Alpha	Depth	ConvF Uncertainty
450	± 50 / ± 100	Head	43.5 ± 5%	0.87 ± 5%	0.34	1.75	7.42 ± 13.3% (k=2)
900	± 50 / ± 100	Head	41.5 ± 5%	0.97 ± 5%	0.30	2.88	6.17 ± 11.0% (k=2)
1810	± 50 / ± 100	Head	40.0 ± 5%	1.40 ± 5%	0.67	1.95	5.17 ± 11.0% (k=2)
1950	± 50 / ± 100	Head	40.0 ± 5%	1.40 ± 5%	0.79	1.69	4.96 ± 11.0% (k=2)
2450	± 50 / ± 100	Head	39.2 ± 5%	1.80 ± 5%	0.85	1.50	4.55 ± 11.0% (k=2)
450	± 50 / ± 100	Body	56.7 ± 5%	0.94 ± 5%	0.28	1.82	7.91 ± 13.3% (k=2)
900	± 50 / ± 100	Body	55.0 ± 5%	1.05 ± 5%	0.38	2.65	6.01 ± 11.0% (k=2)
1810	± 50 / ± 100	Body	53.3 ± 5%	1.52 ± 5%	0.70	2.03	4.57 ± 11.0% (k=2)
1950	± 50 / ± 100	Body	53.3 ± 5%	1.52 ± 5%	0.76	1.82	4.51 ± 11.0% (k=2)
2450	± 50 / ± 100	Body	52.7 ± 5%	1.95 ± 5%	0.85	1.55	3.81 ± 11.0% (k=2)

^c The validity of ± 100 MHz only applies for DASY v4.4 and higher (see Page 2). The uncertainty is the RSS of the ConvF uncertainty at calibration frequency and the uncertainty for the indicated frequency band.

Deviation from Isotropy in HSL

Error (ϕ, ϑ), $f = 900$ MHz

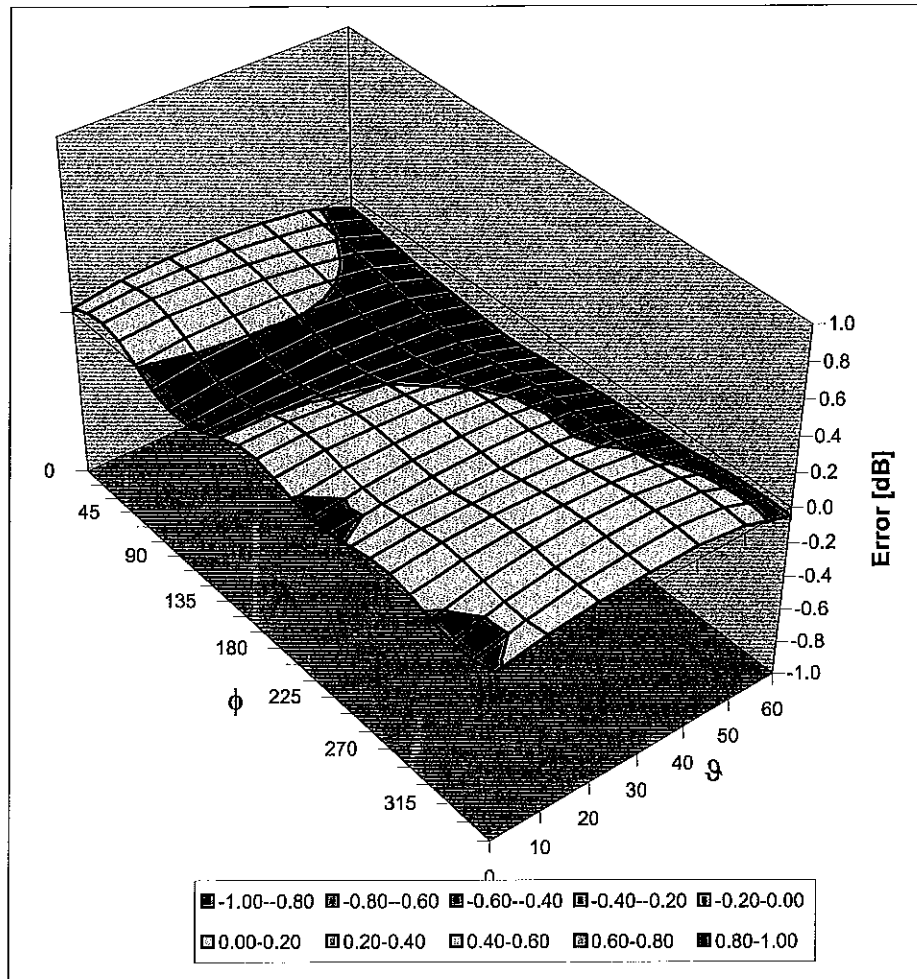

Uncertainty of Spherical Isotropy Assessment: $\pm 2.6\%$ ($k=2$)



Accredited by the Swiss Accreditation Service (SAS)
The Swiss Accreditation Service is one of the signatories to the EA
Multilateral Agreement for the recognition of calibration certificates

Accreditation No.: **SCS 108**

Client **Eurofins**

Certificate No: **DAE3-522_Sep08**

CALIBRATION CERTIFICATE

Object **DAE3 - SD 000 D03 AA - SN: 522**

Calibration procedure(s) **QA-CAL-06 v12
Calibration procedure for the data acquisition electronics (DAE)**

Calibration date: **September 16, 2008**

Condition of the calibrated item **In Tolerance**

This calibration certificate documents the traceability to national standards, which realize the physical units of measurements (SI).
The measurements and the uncertainties with confidence probability are given on the following pages and are part of the certificate.

All calibrations have been conducted in the closed laboratory facility: environment temperature $(22 \pm 3)^\circ\text{C}$ and humidity $< 70\%$.

Calibration Equipment used (M&TE critical for calibration)

Primary Standards	ID #	Cal Date (Certificate No.)	Scheduled Calibration
Fluke Process Calibrator Type 702	SN: 6295803	04-Oct-07 (No: 6467)	Oct-08
Keithley Multimeter Type 2001	SN: 0810278	03-Oct-07 (No: 6465)	Oct-08
Secondary Standards	ID #	Check Date (in house)	Scheduled Check
Calibrator Box V1.1	SE UMS 006 AB 1004	06-Jun-08 (in house check)	In house check: Jun-09

Calibrated by:	Name Andrea Guntli	Function Technician	Signature
Approved by:	Name Fin Bomholt	Function R&D Director	Signature

Issued: September 16, 2008

This calibration certificate shall not be reproduced except in full without written approval of the laboratory.



Accredited by the Swiss Accreditation Service (SAS)
The Swiss Accreditation Service is one of the signatories to the EA
Multilateral Agreement for the recognition of calibration certificates

Accreditation No.: **SCS 108**

Glossary

DAE data acquisition electronics
Connector angle information used in DASY system to align probe sensor X to the robot coordinate system.

Methods Applied and Interpretation of Parameters

- *DC Voltage Measurement:* Calibration Factor assessed for use in DASY system by comparison with a calibrated instrument traceable to national standards. The figure given corresponds to the full scale range of the voltmeter in the respective range.
- *Connector angle:* The angle of the connector is assessed measuring the angle mechanically by a tool inserted. Uncertainty is not required.
- The following parameters as documented in the Appendix contain technical information as a result from the performance test and require no uncertainty.
 - *DC Voltage Measurement Linearity:* Verification of the Linearity at +10% and -10% of the nominal calibration voltage. Influence of offset voltage is included in this measurement.
 - *Common mode sensitivity:* Influence of a positive or negative common mode voltage on the differential measurement.
 - *Channel separation:* Influence of a voltage on the neighbor channels not subject to an input voltage.
 - *AD Converter Values with inputs shorted:* Values on the internal AD converter corresponding to zero input voltage
 - *Input Offset Measurement:* Output voltage and statistical results over a large number of zero voltage measurements.
 - *Input Offset Current:* Typical value for information; Maximum channel input offset current, not considering the input resistance.
 - *Input resistance:* DAE input resistance at the connector, during internal auto-zeroing and during measurement.
 - *Low Battery Alarm Voltage:* Typical value for information. Below this voltage, a battery alarm signal is generated.
 - *Power consumption:* Typical value for information. Supply currents in various operating modes.

DC Voltage Measurement

A/D - Converter Resolution nominal

High Range: 1LSB = 6.1 μ V, full range = -100...+300 mV

Low Range: 1LSB = 61nV, full range = -1.....+3mV

DASY measurement parameters: Auto Zero Time: 3 sec; Measuring time: 3 sec

Calibration Factors	X	Y	Z
High Range	404.296 \pm 0.1% (k=2)	403.979 \pm 0.1% (k=2)	404.799 \pm 0.1% (k=2)
Low Range	3.96483 \pm 0.7% (k=2)	3.94724 \pm 0.7% (k=2)	3.95304 \pm 0.7% (k=2)

Connector Angle

Connector Angle to be used in DASY system	59 $^{\circ}$ \pm 1 $^{\circ}$
---	----------------------------------

Appendix

1. DC Voltage Linearity

High Range	Input (μV)	Reading (μV)	Error (%)
Channel X + Input	200000	200000.1	0.00
Channel X + Input	20000	20004.65	0.02
Channel X - Input	20000	-19997.96	-0.01
Channel Y + Input	200000	200000.2	0.00
Channel Y + Input	20000	20002.06	0.01
Channel Y - Input	20000	-20002.21	0.01
Channel Z + Input	200000	199999.5	0.00
Channel Z + Input	20000	20000.45	0.00
Channel Z - Input	20000	-20000.24	0.00

Low Range	Input (μV)	Reading (μV)	Error (%)
Channel X + Input	2000	2000	0.00
Channel X + Input	200	199.52	-0.24
Channel X - Input	200	-199.25	-0.38
Channel Y + Input	2000	2000	0.00
Channel Y + Input	200	199.61	-0.19
Channel Y - Input	200	-199.68	-0.16
Channel Z + Input	2000	2000.1	0.00
Channel Z + Input	200	198.97	-0.51
Channel Z - Input	200	-200.89	0.44

2. Common mode sensitivity

DASY measurement parameters: Auto Zero Time: 3 sec; Measuring time: 3 sec

	Common mode Input Voltage (mV)	High Range Average Reading (μV)	Low Range Average Reading (μV)
Channel X	200	-4.55	-4.98
	- 200	5.39	5.72
Channel Y	200	-1.09	-1.66
	- 200	-0.37	-0.36
Channel Z	200	16.19	16.11
	- 200	-17.75	-17.97

3. Channel separation

DASY measurement parameters: Auto Zero Time: 3 sec; Measuring time: 3 sec

	Input Voltage (mV)	Channel X (μV)	Channel Y (μV)	Channel Z (μV)
Channel X	200	-	3.70	0.32
Channel Y	200	0.80	-	3.59
Channel Z	200	-3.13	-0.50	-

4. AD-Converter Values with inputs shorted

DASY measurement parameters: Auto Zero Time: 3 sec; Measuring time: 3 sec

	High Range (LSB)	Low Range (LSB)
Channel X	15722	15373
Channel Y	15735	14486
Channel Z	16044	16908

5. Input Offset Measurement

DASY measurement parameters: Auto Zero Time: 3 sec; Measuring time: 3 sec

Input 10M Ω

	Average (μ V)	min. Offset (μ V)	max. Offset (μ V)	Std. Deviation (μ V)
Channel X	0.98	-0.32	2.54	0.62
Channel Y	-1.57	-3.53	-0.17	0.62
Channel Z	-0.13	-1.30	1.18	0.51

6. Input Offset Current

Nominal Input circuitry offset current on all channels: <25fA

7. Input Resistance

	Zeroing (MOhm)	Measuring (MOhm)
Channel X	0.2000	198.1
Channel Y	0.2001	199.4
Channel Z	0.2001	196.4

8. Low Battery Alarm Voltage (verified during pre test)

Typical values	Alarm Level (VDC)
Supply (+ Vcc)	+7.9
Supply (- Vcc)	-7.6

9. Power Consumption (verified during pre test)

Typical values	Switched off (mA)	Stand by (mA)	Transmitting (mA)
Supply (+ Vcc)	+0.0	+6	+14
Supply (- Vcc)	-0.01	-8	-9

Annex B

Measurement Plots

Test Laboratory: Eurofins Product Service GmbH

Dipol Valid.2450 (m)_250mW_ELI 4 31.08.2009

DUT: Dipole 2450 MHz; Type: D2450V2; Serial: 722

Communication System: CW; Frequency: 2450 MHz; Duty Cycle: 1:1

Medium: Muscle 2450 MHz Medium parameters used (interpolated): $f = 2450$ MHz; $\sigma = 2.03$ mho/m; $\epsilon_r = 52.9$; $\rho = 1000$ kg/m³

Phantom section: Flat Section

DASY4 Configuration:

- Probe: ET3DV6 - SN1711; ConvF(3.81, 3.81, 3.81); Calibrated: 9/17/2008
- Sensor-Surface: 4mm (Mechanical And Optical Surface Detection)
- Electronics: DAE3 Sn522; Calibrated: 9/16/2008
- Phantom: Flat Phantom ELI4.0; Type: QDOVA001BB; Serial: SN:1013
- Measurement SW: DASY4, V4.7 Build 71; Postprocessing SW: SEMCAD, V1.8 Build 184

Dipol 2450 (250mW)/Area Scan (61x101x1): Measurement grid: dx=10mm, dy=10mm
Maximum value of SAR (interpolated) = 14.5 mW/g

Dipol 2450 (250mW)/Zoom Scan (7x7x7)/Cube 0: Measurement grid: dx=5mm, dy=5mm, dz=5mm

Reference Value = 85.2 V/m; Power Drift = -0.033 dB

Peak SAR (extrapolated) = 30.6 W/kg

SAR(1 g) = 13 mW/g; SAR(10 g) = 5.92 mW/g

Maximum value of SAR (measured) = 14.4 mW/g

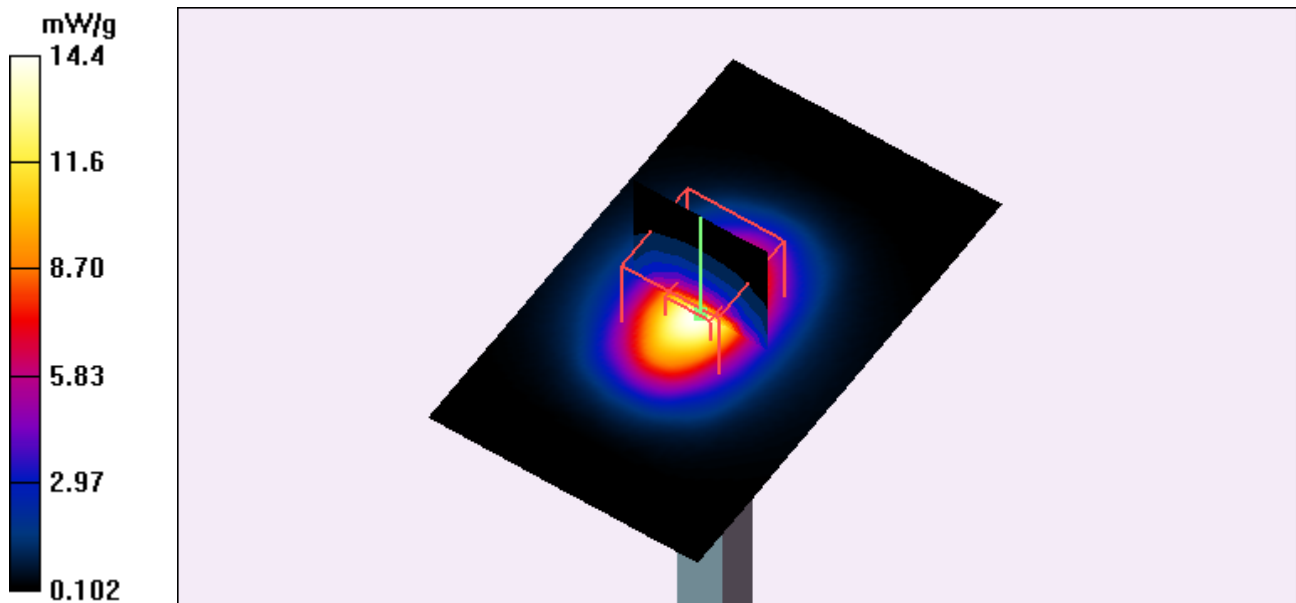

Test Laboratory: Eurofins Product Service GmbH

RCS_Ch 00_2G4 FHSS_GFSK_Flat_Front_0mm

DUT: CS10; Type: Field controller; Serial: P13-003

Communication System: RCS 2G4 FHSS; Frequency: 2401 MHz; Duty Cycle: 1:2

Medium: Muscle 2450 MHz Medium parameters used: $f = 2401$ MHz; $\sigma = 1.97$ mho/m; $\epsilon_r = 52.9$; $\rho = 1000$ kg/m³

Phantom section: Flat Section

DASY4 Configuration:

- Probe: ET3DV6 - SN1711; ConvF(3.81, 3.81, 3.81); Calibrated: 9/17/2008
- Sensor-Surface: 4mm (Mechanical And Optical Surface Detection)
- Electronics: DAE3 Sn522; Calibrated: 9/16/2008
- Phantom: Flat Phantom ELI4.0; Type: QDOVA001BB; Serial: SN:1013
- Measurement SW: DASY4, V4.7 Build 71; Postprocessing SW: SEMCAD, V1.8 Build 184

CS10/Area Scan (111x71x1): Measurement grid: dx=20mm, dy=20mm

Maximum value of SAR (interpolated) = 0.568 mW/g

CS10/Zoom Scan (7x7x7)/Cube 0: Measurement grid: dx=5mm, dy=5mm, dz=5mm

Reference Value = 2.54 V/m; Power Drift = -0.073 dB

Peak SAR (extrapolated) = 1.38 W/kg

SAR(1 g) = 0.583 mW/g; SAR(10 g) = 0.300 mW/g

Maximum value of SAR (measured) = 0.619 mW/g

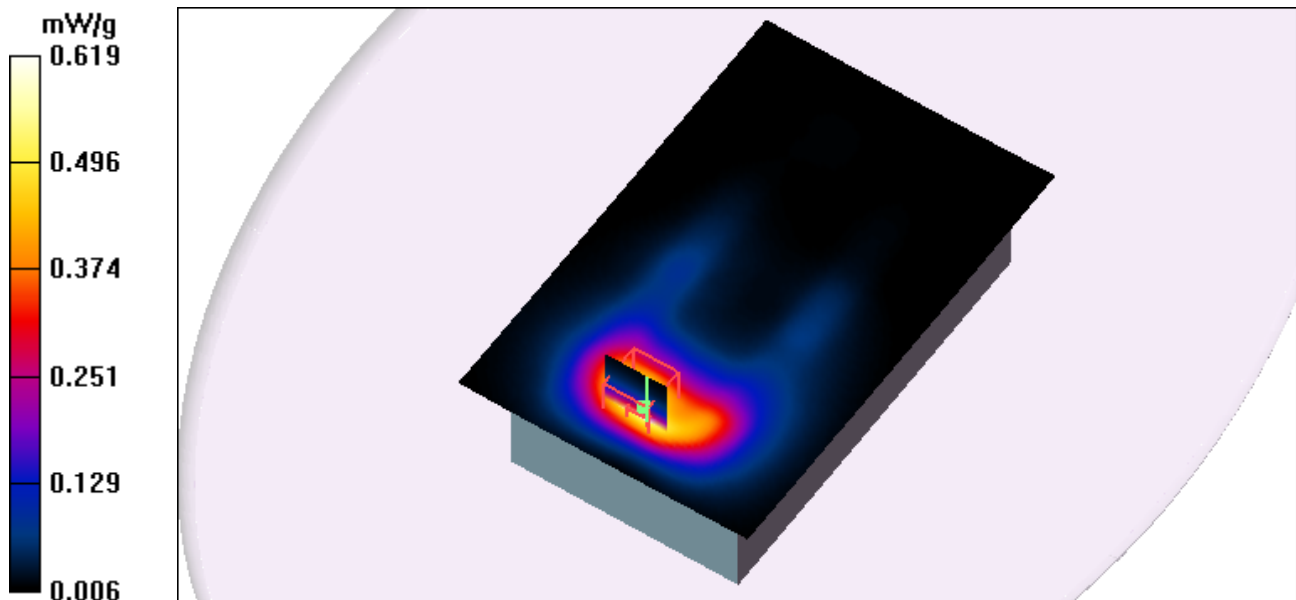

Test Laboratory: Eurofins Product Service GmbH

RCS_Ch 00_2G4 FHSS_GFSK_Flat_Back_0mm

DUT: CS10; Type: Field controller; Serial: P13-003

Communication System: RCS 2G4 FHSS; Frequency: 2401 MHz; Duty Cycle: 1:2

Medium: Muscle 2450 MHz Medium parameters used: $f = 2401$ MHz; $\sigma = 1.97$ mho/m; $\epsilon_r = 52.9$; $\rho = 1000$ kg/m³

Phantom section: Flat Section

DASY4 Configuration:

- Probe: ET3DV6 - SN1711; ConvF(3.81, 3.81, 3.81); Calibrated: 9/17/2008
- Sensor-Surface: 4mm (Mechanical And Optical Surface Detection)
- Electronics: DAE3 Sn522; Calibrated: 9/16/2008
- Phantom: Flat Phantom ELI4.0; Type: QDOVA001BB; Serial: SN:1013
- Measurement SW: DASY4, V4.7 Build 71; Postprocessing SW: SEMCAD, V1.8 Build 184

CS10/Area Scan (111x71x1): Measurement grid: dx=20mm, dy=20mm

Maximum value of SAR (interpolated) = 0.047 mW/g

CS10/Zoom Scan (7x7x7)/Cube 0: Measurement grid: dx=5mm, dy=5mm, dz=5mm

Reference Value = 1.80 V/m; Power Drift = -0.149 dB

Peak SAR (extrapolated) = 0.098 W/kg

SAR(1 g) = 0.045 mW/g; SAR(10 g) = 0.025 mW/g

Maximum value of SAR (measured) = 0.047 mW/g

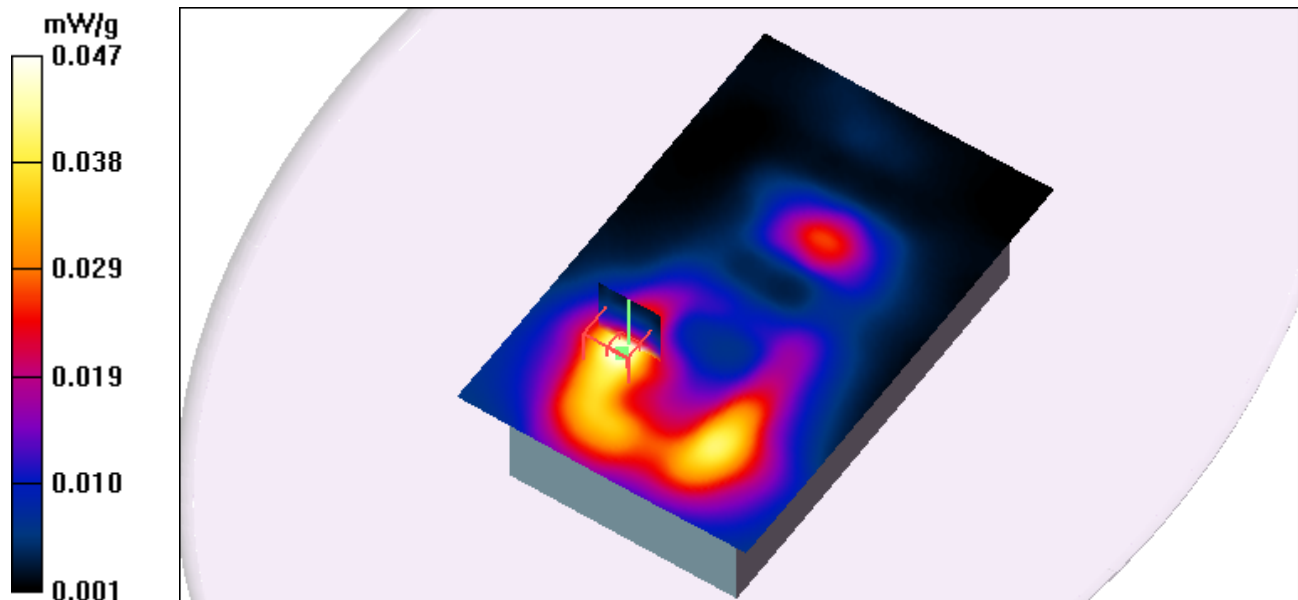

Test Laboratory: Eurofins Product Service GmbH

RCS_Ch 42_2G4 FHSS_GFSK_Flat_Front_0mm

DUT: CS10; Type: Field controller; Serial: P13-003

Communication System: RCS 2G4 FHSS; Frequency: 2437 MHz; Duty Cycle: 1:2

Medium: Muscle 2450 MHz Medium parameters used: $f = 2437$ MHz; $\sigma = 2.03$ mho/m; $\epsilon_r = 52.9$; $\rho = 1000$ kg/m³

Phantom section: Flat Section

DASY4 Configuration:

- Probe: ET3DV6 - SN1711; ConvF(3.81, 3.81, 3.81); Calibrated: 9/17/2008
- Sensor-Surface: 4mm (Mechanical And Optical Surface Detection)
- Electronics: DAE3 Sn522; Calibrated: 9/16/2008
- Phantom: Flat Phantom ELI4.0; Type: QDOVA001BB; Serial: SN:1013
- Measurement SW: DASY4, V4.7 Build 71; Postprocessing SW: SEMCAD, V1.8 Build 184

CS10/Area Scan (111x71x1): Measurement grid: dx=20mm, dy=20mm

Maximum value of SAR (interpolated) = 0.510 mW/g

CS10/Zoom Scan (7x7x7)/Cube 0: Measurement grid: dx=5mm, dy=5mm, dz=5mm

Reference Value = 2.40 V/m; Power Drift = 0.142 dB

Peak SAR (extrapolated) = 1.21 W/kg

SAR(1 g) = 0.504 mW/g; SAR(10 g) = 0.257 mW/g

Maximum value of SAR (measured) = 0.528 mW/g

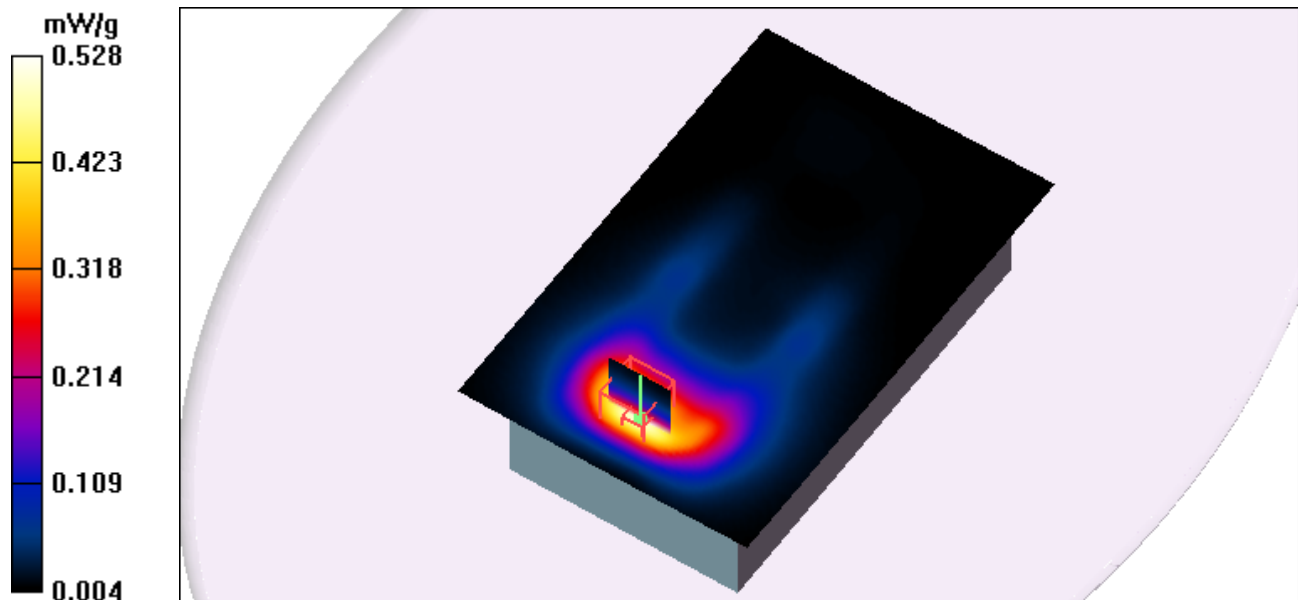

Test Laboratory: Eurofins Product Service GmbH

RCS_Ch 42_2G4 FHSS_GFSK_Flat_Back_0mm

DUT: CS10; Type: Field controller; Serial: P13-003

Communication System: RCS 2G4 FHSS; Frequency: 2437 MHz; Duty Cycle: 1:2

Medium: Muscle 2450 MHz Medium parameters used: $f = 2437$ MHz; $\sigma = 2.03$ mho/m; $\epsilon_r = 52.9$; $\rho = 1000$ kg/m³

Phantom section: Flat Section

DASY4 Configuration:

- Probe: ET3DV6 - SN1711; ConvF(3.81, 3.81, 3.81); Calibrated: 9/17/2008
- Sensor-Surface: 4mm (Mechanical And Optical Surface Detection)
- Electronics: DAE3 Sn522; Calibrated: 9/16/2008
- Phantom: Flat Phantom ELI4.0; Type: QDOVA001BB; Serial: SN:1013
- Measurement SW: DASY4, V4.7 Build 71; Postprocessing SW: SEMCAD, V1.8 Build 184

CS10/Area Scan (111x71x1): Measurement grid: dx=20mm, dy=20mm

Maximum value of SAR (interpolated) = 0.049 mW/g

CS10/Zoom Scan (7x7x7)/Cube 0: Measurement grid: dx=5mm, dy=5mm, dz=5mm

Reference Value = 2.06 V/m; Power Drift = 0.171 dB

Peak SAR (extrapolated) = 0.110 W/kg

SAR(1 g) = 0.049 mW/g; SAR(10 g) = 0.026 mW/g

Maximum value of SAR (measured) = 0.051 mW/g

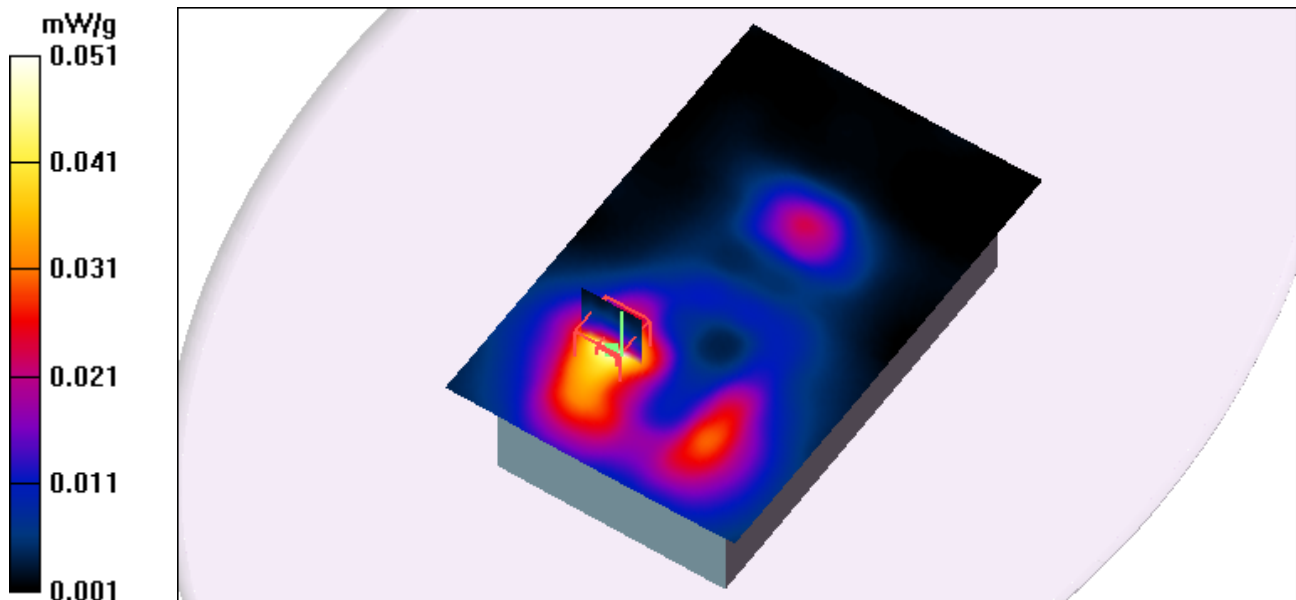

Test Laboratory: Eurofins Product Service GmbH

RCS_Ch 84_2G4 FHSS_GFSK_Flat_Front_0mm

DUT: CS10; Type: Field controller; Serial: P13-003

Communication System: RCS 2G4 FHSS; Frequency: 2474 MHz; Duty Cycle: 1:2

Medium: Muscle 2450 MHz Medium parameters used: $f = 2474$ MHz; $\sigma = 2.04$ mho/m; $\epsilon_r = 52.9$; $\rho = 1000$ kg/m³

Phantom section: Flat Section

DASY4 Configuration:

- Probe: ET3DV6 - SN1711; ConvF(3.81, 3.81, 3.81); Calibrated: 9/17/2008
- Sensor-Surface: 4mm (Mechanical And Optical Surface Detection)
- Electronics: DAE3 Sn522; Calibrated: 9/16/2008
- Phantom: Flat Phantom ELI4.0; Type: QDOVA001BB; Serial: SN:1013
- Measurement SW: DASY4, V4.7 Build 71; Postprocessing SW: SEMCAD, V1.8 Build 184

CS10/Area Scan (111x71x1): Measurement grid: dx=20mm, dy=20mm

Maximum value of SAR (interpolated) = 0.358 mW/g

CS10/Zoom Scan (7x7x7)/Cube 0: Measurement grid: dx=5mm, dy=5mm, dz=5mm

Reference Value = 1.73 V/m; Power Drift = 0.114 dB

Peak SAR (extrapolated) = 0.905 W/kg

SAR(1 g) = 0.376 mW/g; SAR(10 g) = 0.187 mW/g

Maximum value of SAR (measured) = 0.406 mW/g

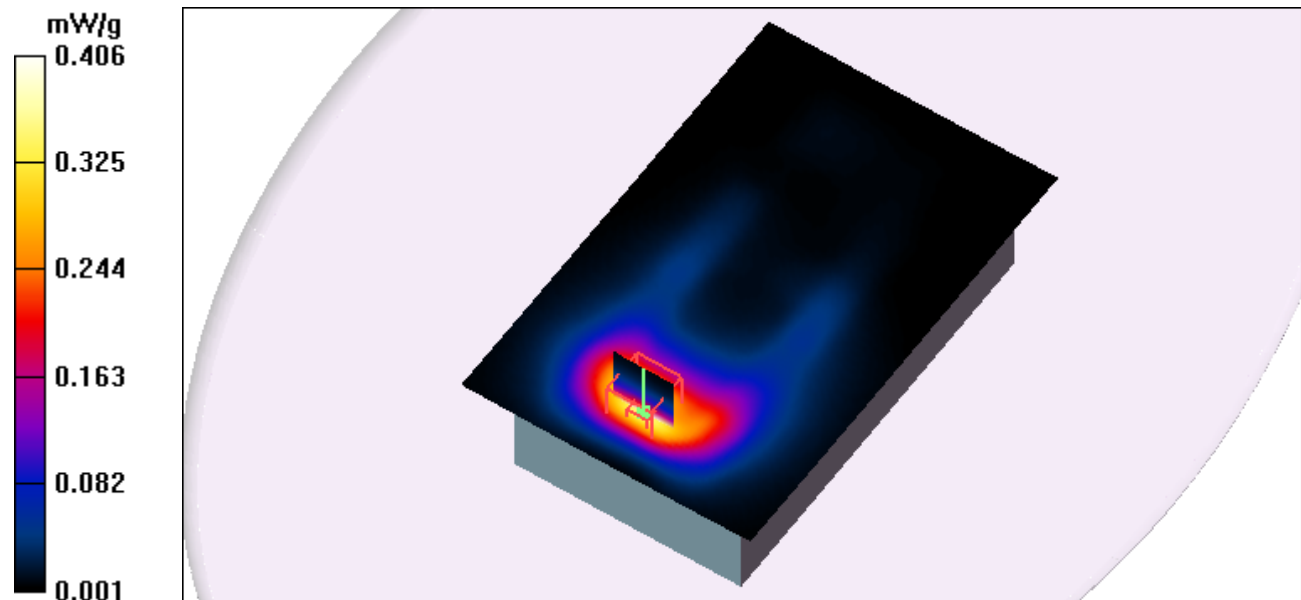

Test Laboratory: Eurofins Product Service GmbH

RCS_Ch 84_2G4 FHSS_GFSK_Flat_Back_0mm

DUT: CS10; Type: Field controller; Serial: P13-003

Communication System: RCS 2G4 FHSS; Frequency: 2474 MHz; Duty Cycle: 1:2

Medium: Muscle 2450 MHz Medium parameters used: $f = 2474$ MHz; $\sigma = 2.04$ mho/m; $\epsilon_r = 52.9$; $\rho = 1000$ kg/m³

Phantom section: Flat Section

DASY4 Configuration:

- Probe: ET3DV6 - SN1711; ConvF(3.81, 3.81, 3.81); Calibrated: 9/17/2008
- Sensor-Surface: 4mm (Mechanical And Optical Surface Detection)
- Electronics: DAE3 Sn522; Calibrated: 9/16/2008
- Phantom: Flat Phantom ELI4.0; Type: QDOVA001BB; Serial: SN:1013
- Measurement SW: DASY4, V4.7 Build 71; Postprocessing SW: SEMCAD, V1.8 Build 184

CS10/Area Scan (111x71x1): Measurement grid: dx=20mm, dy=20mm

Maximum value of SAR (interpolated) = 0.038 mW/g

CS10/Zoom Scan (7x7x7)/Cube 0: Measurement grid: dx=5mm, dy=5mm, dz=5mm

Reference Value = 2.09 V/m; Power Drift = -0.199 dB

Peak SAR (extrapolated) = 0.085 W/kg

SAR(1 g) = 0.037 mW/g; SAR(10 g) = 0.021 mW/g

Maximum value of SAR (measured) = 0.040 mW/g

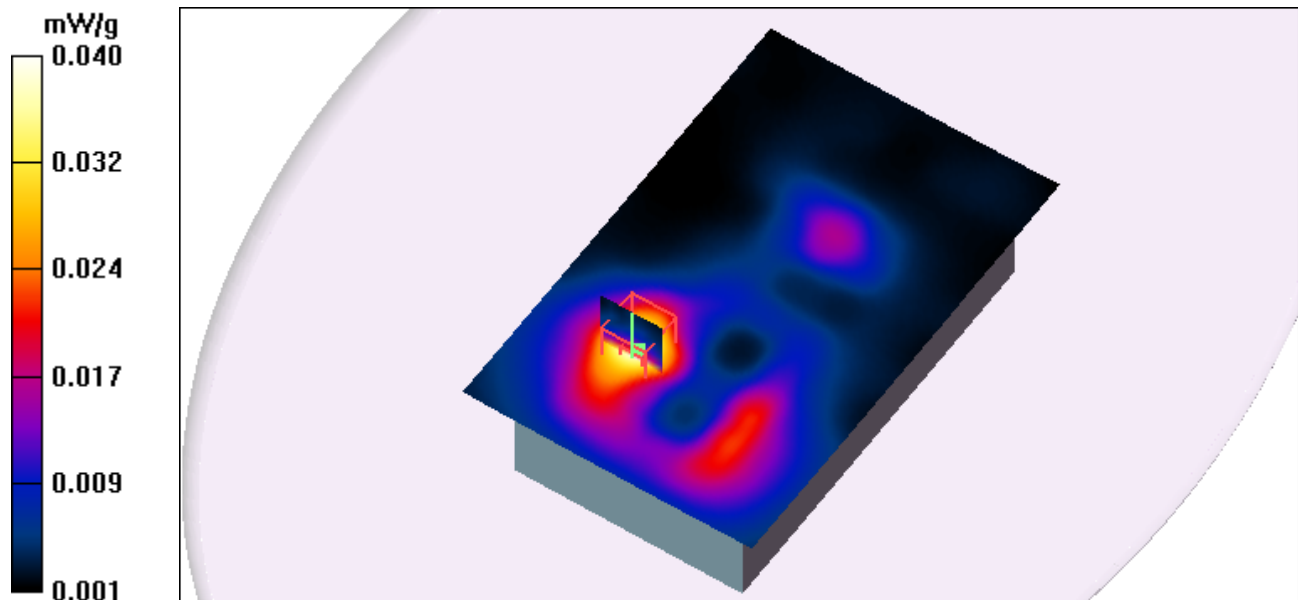

Test Laboratory: Eurofins Product Service GmbH

Z - axis scan

DUT: CS10; Type: Field controller; Serial: P13-003

Communication System: RCS 2G4 FHSS; Frequency: 2401 MHz; Duty Cycle: 1:2

Medium: Muscle 2450 MHz Medium parameters used: $f = 2401$ MHz; $\sigma = 1.97$ mho/m; $\epsilon_r = 52.9$; $\rho = 1000$ kg/m³

Phantom section: Flat Section

DASY4 Configuration:

- Probe: ET3DV6 - SN1711; ConvF(3.81, 3.81, 3.81); Calibrated: 9/17/2008
- Sensor-Surface: 4mm (Mechanical And Optical Surface Detection)
- Electronics: DAE3 Sn522; Calibrated: 9/16/2008
- Phantom: Flat Phantom ELI4.0; Type: QDOVA001BB; Serial: SN:1013
- Measurement SW: DASY4, V4.7 Build 71; Postprocessing SW: SEMCAD, V1.8 Build 184

CS10/Area Scan (111x71x1): Measurement grid: dx=20mm, dy=20mm

Maximum value of SAR (interpolated) = 0.568 mW/g

CS10/Zoom Scan (7x7x7)/Cube 0: Measurement grid: dx=5mm, dy=5mm, dz=5mm

Reference Value = 2.54 V/m; Power Drift = -0.073 dB

Peak SAR (extrapolated) = 1.38 W/kg

SAR(1 g) = 0.583 mW/g; SAR(10 g) = 0.300 mW/g

Maximum value of SAR (measured) = 0.619 mW/g

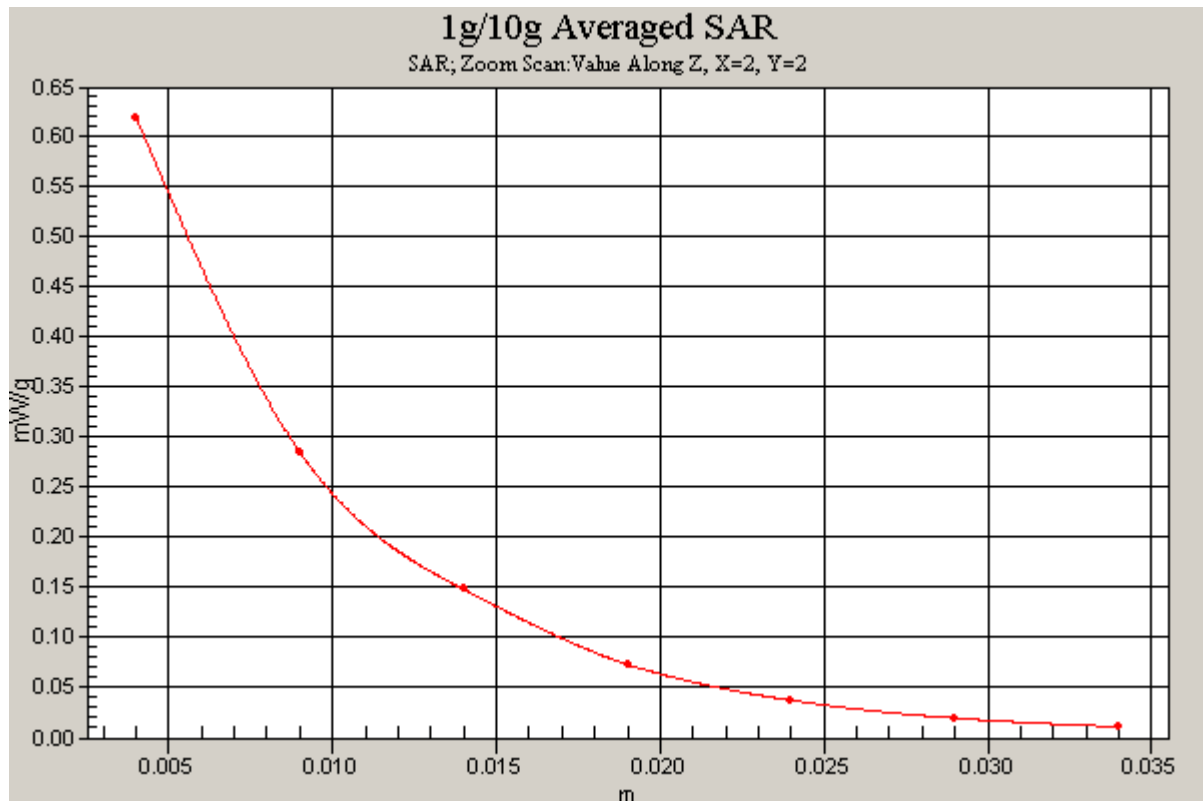

Test Laboratory: Eurofins Product Service GmbH

Dipol Valid.2450 (m)_250mW_ELI 4 25.08.2009

DUT: Dipole 2450 MHz; Type: D2450V2; Serial: 722

Communication System: CW; Frequency: 2450 MHz; Duty Cycle: 1:1

Medium: Muscle 2450 MHz Medium parameters used (interpolated): $f = 2450$ MHz; $\sigma = 2.03$ mho/m; $\epsilon_r = 52.9$; $\rho = 1000$ kg/m³

Phantom section: Flat Section

DASY4 Configuration:

- Probe: ET3DV6 - SN1711; ConvF(3.81, 3.81, 3.81); Calibrated: 9/17/2008
- Sensor-Surface: 4mm (Mechanical And Optical Surface Detection)
- Electronics: DAE3 Sn522; Calibrated: 9/16/2008
- Phantom: Flat Phantom ELI4.0; Type: QDOVA001BB; Serial: SN:1013
- Measurement SW: DASY4, V4.7 Build 71; Postprocessing SW: SEMCAD, V1.8 Build 184

Dipol 2450 (250mW)/Area Scan (61x101x1): Measurement grid: dx=10mm, dy=10mm
Maximum value of SAR (interpolated) = 14.3 mW/g

Dipol 2450 (250mW)/Zoom Scan (7x7x7)/Cube 0: Measurement grid: dx=5mm, dy=5mm, dz=5mm

Reference Value = 83.6 V/m; Power Drift = -0.055 dB

Peak SAR (extrapolated) = 29.3 W/kg

SAR(1 g) = 12.6 mW/g; SAR(10 g) = 5.79 mW/g

Maximum value of SAR (measured) = 14.1 mW/g

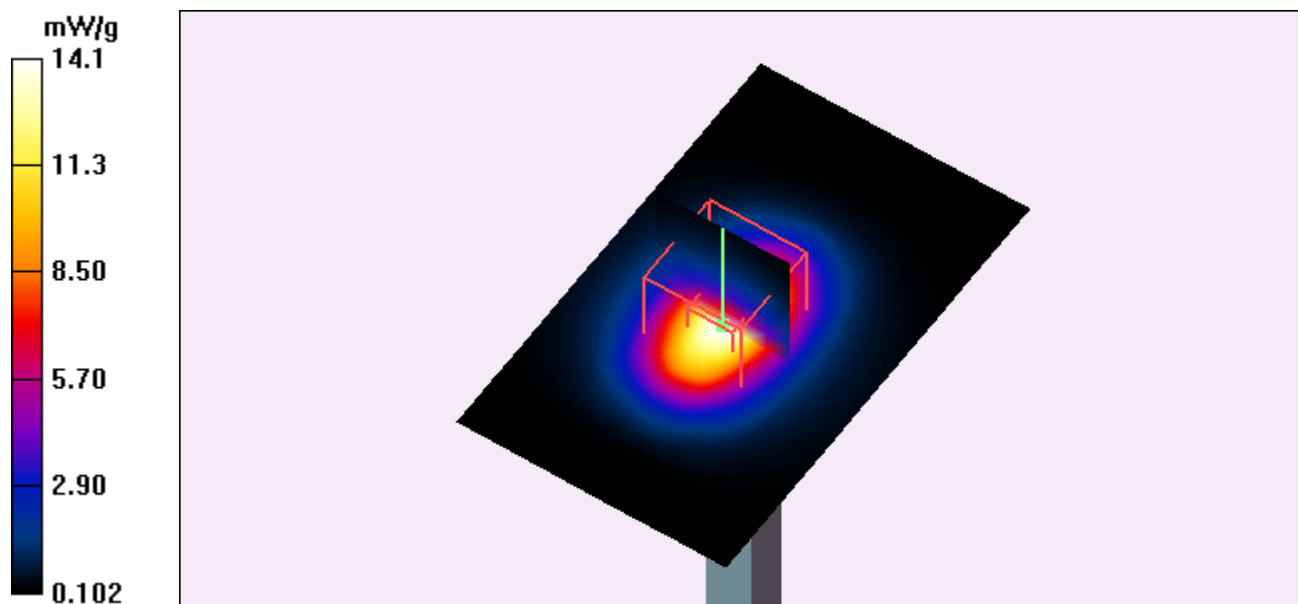

Test Laboratory: Eurofins Product Service GmbH

Dipol Valid.2450 (m)_250mW_ELI 4 26.08.2009

DUT: Dipole 2450 MHz; Type: D2450V2; Serial: 722

Communication System: CW; Frequency: 2450 MHz; Duty Cycle: 1:1

Medium: Muscle 2450 MHz Medium parameters used (interpolated): $f = 2450$ MHz; $\sigma = 2.03$ mho/m; $\epsilon_r = 52.9$; $\rho = 1000$ kg/m³

Phantom section: Flat Section

DASY4 Configuration:

- Probe: ET3DV6 - SN1711; ConvF(3.81, 3.81, 3.81); Calibrated: 9/17/2008
- Sensor-Surface: 4mm (Mechanical And Optical Surface Detection)
- Electronics: DAE3 Sn522; Calibrated: 9/16/2008
- Phantom: Flat Phantom ELI4.0; Type: QDOVA001BB; Serial: SN:1013
- Measurement SW: DASY4, V4.7 Build 71; Postprocessing SW: SEMCAD, V1.8 Build 184

Dipol 2450 (250mW)/Area Scan (61x101x1): Measurement grid: dx=10mm, dy=10mm
Maximum value of SAR (interpolated) = 14.1 mW/g

Dipol 2450 (250mW)/Zoom Scan (7x7x7)/Cube 0: Measurement grid: dx=5mm, dy=5mm, dz=5mm

Reference Value = 76.5 V/m; Power Drift = -0.048 dB

Peak SAR (extrapolated) = 28.4 W/kg

SAR(1 g) = 12.7 mW/g; SAR(10 g) = 5.88 mW/g

Maximum value of SAR (measured) = 13.8 mW/g

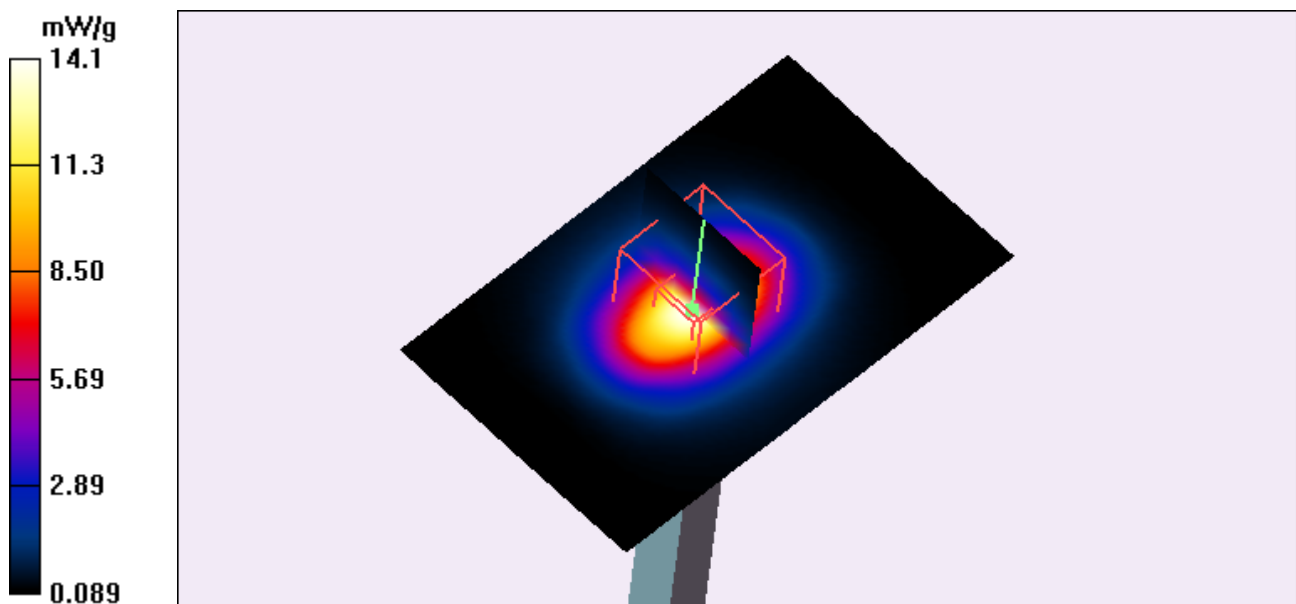

Test Laboratory: Eurofins Product Service GmbH

Wlan_Ch 1_DSSS_1Mbs_Flat_Front_0mm

DUT: CS10; Type: Field controller; Serial: 13-004

Communication System: WLAN 2450; Frequency: 2412 MHz; Duty Cycle: 1:1

Medium: Muscle 2450 MHz Medium parameters used: $f = 2412$ MHz; $\sigma = 2$ mho/m; $\epsilon_r = 52.9$; $\rho = 1000$ kg/m³

Phantom section: Flat Section

DASY4 Configuration:

- Probe: ET3DV6 - SN1711; ConvF(3.81, 3.81, 3.81); Calibrated: 9/17/2008
- Sensor-Surface: 4mm (Mechanical And Optical Surface Detection)
- Electronics: DAE3 Sn522; Calibrated: 9/16/2008
- Phantom: Flat Phantom ELI4.0; Type: QDOVA001BB; Serial: SN:1013
- Measurement SW: DASY4, V4.7 Build 71; Postprocessing SW: SEMCAD, V1.8 Build 184

CS10/Area Scan (111x71x1): Measurement grid: dx=20mm, dy=20mm

Maximum value of SAR (interpolated) = 0.011 mW/g

CS10/Zoom Scan (7x7x7)/Cube 0: Measurement grid: dx=5mm, dy=5mm, dz=5mm

Reference Value = 1.26 V/m; Power Drift = -0.106 dB

Peak SAR (extrapolated) = 0.022 W/kg

SAR(1 g) = 0.011 mW/g; SAR(10 g) = 0.00661 mW/g

Maximum value of SAR (measured) = 0.011 mW/g

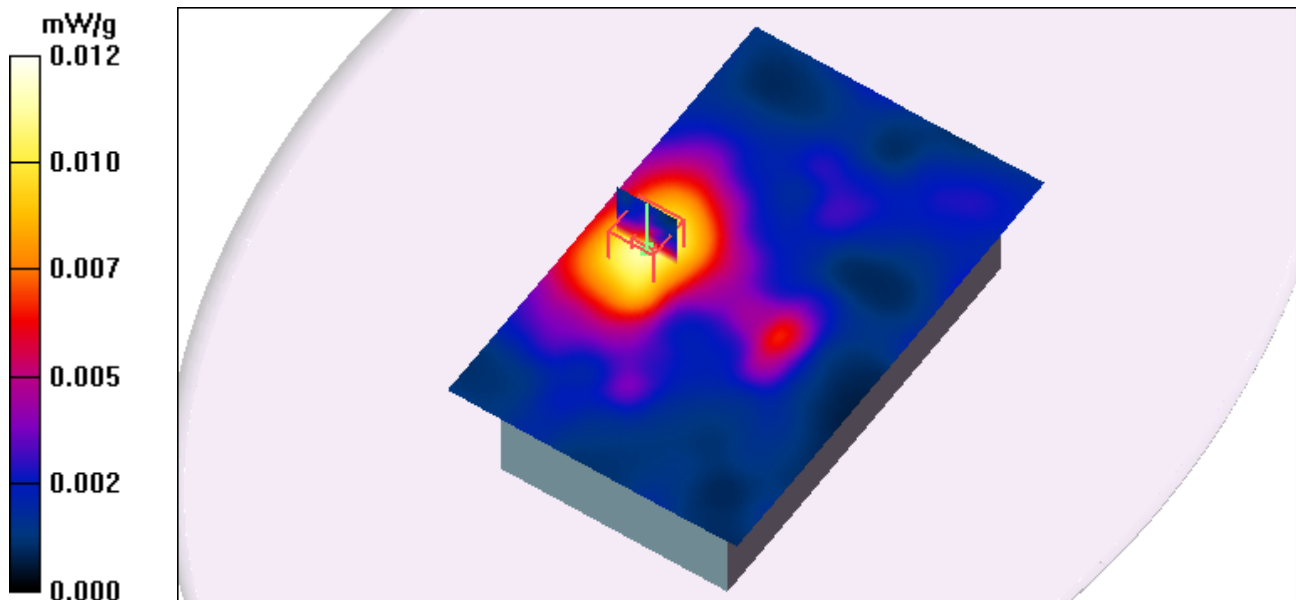

Test Laboratory: Eurofins Product Service GmbH

Wlan_Ch 1_DSSS_1Mbs_Flat_Back_0mm

DUT: CS10; Type: Field controller; Serial: 13-004

Communication System: WLAN 2450; Frequency: 2412 MHz; Duty Cycle: 1:1

Medium: Muscle 2450 MHz Medium parameters used: $f = 2412$ MHz; $\sigma = 2$ mho/m; $\epsilon_r = 52.9$; $\rho = 1000$ kg/m³

Phantom section: Flat Section

DASY4 Configuration:

- Probe: ET3DV6 - SN1711; ConvF(3.81, 3.81, 3.81); Calibrated: 9/17/2008
- Sensor-Surface: 4mm (Mechanical And Optical Surface Detection)
- Electronics: DAE3 Sn522; Calibrated: 9/16/2008
- Phantom: Flat Phantom ELI4.0; Type: QDOVA001BB; Serial: SN:1013
- Measurement SW: DASY4, V4.7 Build 71; Postprocessing SW: SEMCAD, V1.8 Build 184

CS10/Area Scan (111x71x1): Measurement grid: dx=20mm, dy=20mm

Maximum value of SAR (interpolated) = 0.182 mW/g

CS10/Zoom Scan (7x7x7)/Cube 0: Measurement grid: dx=5mm, dy=5mm, dz=5mm

Reference Value = 2.11 V/m; Power Drift = -0.194 dB

Peak SAR (extrapolated) = 0.465 W/kg

SAR(1 g) = 0.198 mW/g; SAR(10 g) = 0.093 mW/g

Maximum value of SAR (measured) = 0.214 mW/g

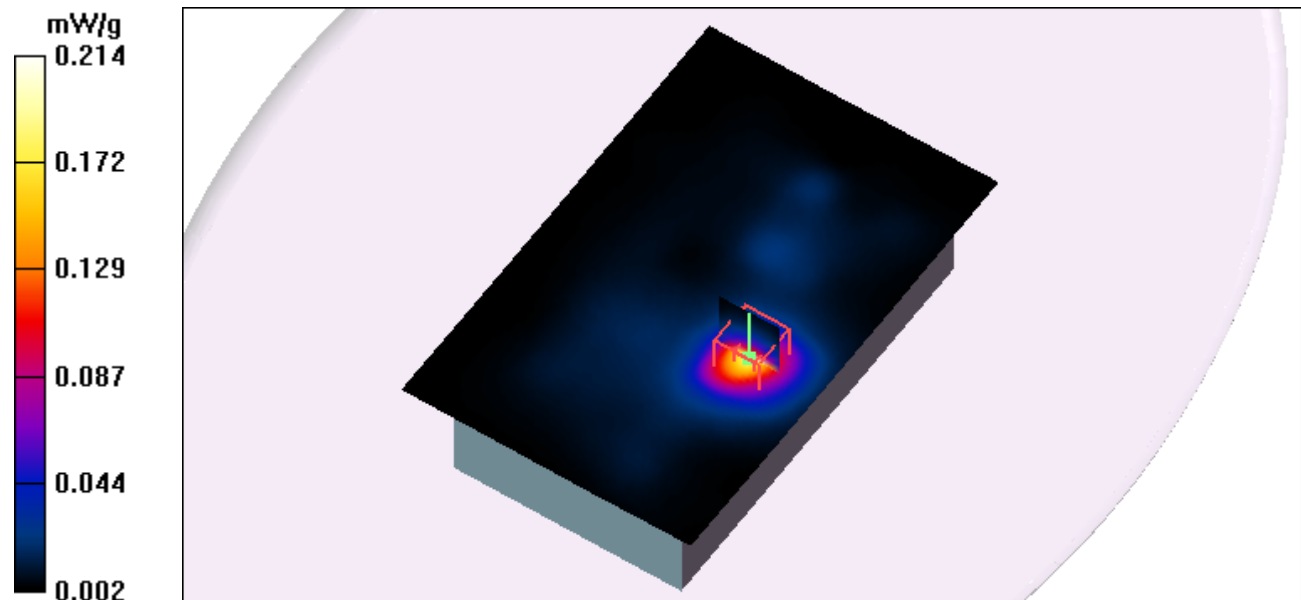

Test Laboratory: Eurofins Product Service GmbH

Wlan_Ch 6_DSSS_1Mbs_Flat_Front_0mm

DUT: CS10; Type: Field controller; Serial: 13-004

Communication System: WLAN 2450; Frequency: 2437 MHz; Duty Cycle: 1:1

Medium: Muscle 2450 MHz Medium parameters used (interpolated): $f = 2437$ MHz; $\sigma = 2.03$ mho/m; $\epsilon_r = 52.9$; $\rho = 1000$ kg/m³

Phantom section: Flat Section

DASY4 Configuration:

- Probe: ET3DV6 - SN1711; ConvF(3.81, 3.81, 3.81); Calibrated: 9/17/2008
- Sensor-Surface: 4mm (Mechanical And Optical Surface Detection)
- Electronics: DAE3 Sn522; Calibrated: 9/16/2008
- Phantom: Flat Phantom ELI4.0; Type: QDOVA001BB; Serial: SN:1013
- Measurement SW: DASY4, V4.7 Build 71; Postprocessing SW: SEMCAD, V1.8 Build 184

CS10/Area Scan (111x71x1): Measurement grid: dx=20mm, dy=20mm

Maximum value of SAR (interpolated) = 0.013 mW/g

CS10/Zoom Scan (7x7x7)/Cube 0: Measurement grid: dx=5mm, dy=5mm, dz=5mm

Reference Value = 1.18 V/m; Power Drift = -0.040 dB

Peak SAR (extrapolated) = 0.028 W/kg

SAR(1 g) = 0.012 mW/g; SAR(10 g) = 0.00768 mW/g

Maximum value of SAR (measured) = 0.014 mW/g

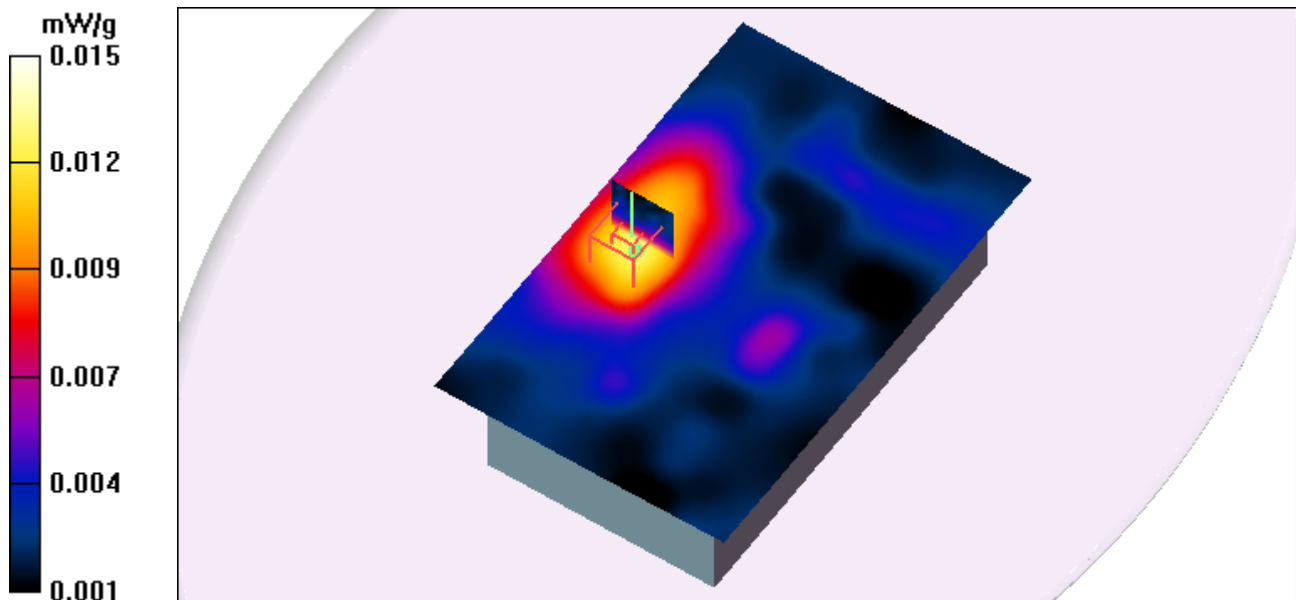

Test Laboratory: Eurofins Product Service GmbH

Wlan_Ch 6_DSSS_1Mbs_Flat_Back_0mm

DUT: CS10; Type: Field controller; Serial: 13-004

Communication System: WLAN 2450; Frequency: 2437 MHz; Duty Cycle: 1:1

Medium: Muscle 2450 MHz Medium parameters used (interpolated): $f = 2437$ MHz; $\sigma = 2.03$ mho/m; $\epsilon_r = 52.9$; $\rho = 1000$ kg/m³

Phantom section: Flat Section

DASY4 Configuration:

- Probe: ET3DV6 - SN1711; ConvF(3.81, 3.81, 3.81); Calibrated: 9/17/2008
- Sensor-Surface: 4mm (Mechanical And Optical Surface Detection)
- Electronics: DAE3 Sn522; Calibrated: 9/16/2008
- Phantom: Flat Phantom ELI4.0; Type: QDOVA001BB; Serial: SN:1013
- Measurement SW: DASY4, V4.7 Build 71; Postprocessing SW: SEMCAD, V1.8 Build 184

CS10/Area Scan (111x71x1): Measurement grid: dx=20mm, dy=20mm

Maximum value of SAR (interpolated) = 0.263 mW/g

CS10/Zoom Scan (7x7x7)/Cube 0: Measurement grid: dx=5mm, dy=5mm, dz=5mm

Reference Value = 2.35 V/m; Power Drift = -0.146 dB

Peak SAR (extrapolated) = 0.570 W/kg

SAR(1 g) = 0.245 mW/g; SAR(10 g) = 0.115 mW/g

Maximum value of SAR (measured) = 0.273 mW/g

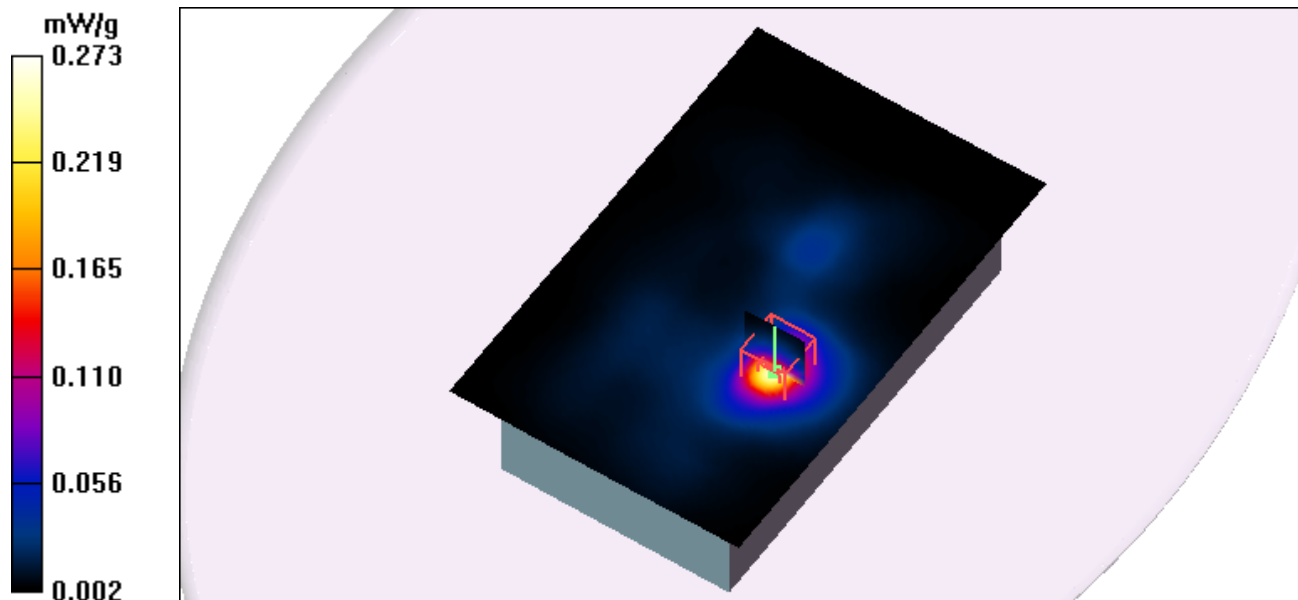

Test Laboratory: Eurofins Product Service GmbH

Wlan_Ch 11_DSSS_1Mbs_Flat_Front_0mm

DUT: CS10; Type: Field controller; Serial: 13-004

Communication System: WLAN 2450; Frequency: 2462 MHz; Duty Cycle: 1:1

Medium: Muscle 2450 MHz Medium parameters used: $f = 2462$ MHz; $\sigma = 2.04$ mho/m; $\epsilon_r = 52.9$; $\rho = 1000$ kg/m³

Phantom section: Flat Section

DASY4 Configuration:

- Probe: ET3DV6 - SN1711; ConvF(3.81, 3.81, 3.81); Calibrated: 9/17/2008
- Sensor-Surface: 4mm (Mechanical And Optical Surface Detection)
- Electronics: DAE3 Sn522; Calibrated: 9/16/2008
- Phantom: Flat Phantom ELI4.0; Type: QDOVA001BB; Serial: SN:1013
- Measurement SW: DASY4, V4.7 Build 71; Postprocessing SW: SEMCAD, V1.8 Build 184

CS10/Area Scan (111x71x1): Measurement grid: dx=20mm, dy=20mm

Maximum value of SAR (interpolated) = 0.018 mW/g

CS10/Zoom Scan (7x7x7)/Cube 0: Measurement grid: dx=5mm, dy=5mm, dz=5mm

Reference Value = 1.17 V/m; Power Drift = 0.193 dB

Peak SAR (extrapolated) = 0.027 W/kg

SAR(1 g) = 0.013 mW/g; SAR(10 g) = 0.0077 mW/g.

Maximum value of SAR (measured) = 0.018 mW/g

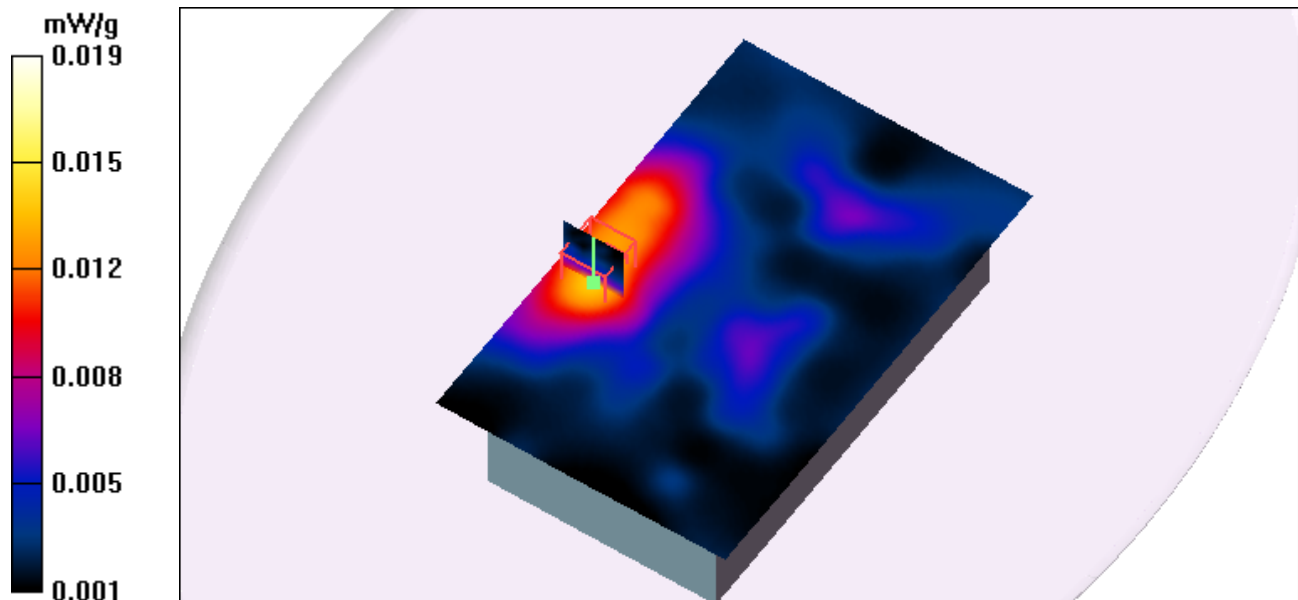

Test Laboratory: Eurofins Product Service GmbH

Wlan_Ch 11_DSSS_1Mbs_Flat_Back_0mm

DUT: CS10; Type: Field controller; Serial: 13-004

Communication System: WLAN 2450; Frequency: 2462 MHz; Duty Cycle: 1:1

Medium: Muscle 2450 MHz Medium parameters used: $f = 2462$ MHz; $\sigma = 2.04$ mho/m; $\epsilon_r = 52.9$; $\rho = 1000$ kg/m³

Phantom section: Flat Section

DASY4 Configuration:

- Probe: ET3DV6 - SN1711; ConvF(3.81, 3.81, 3.81); Calibrated: 9/17/2008
- Sensor-Surface: 4mm (Mechanical And Optical Surface Detection)
- Electronics: DAE3 Sn522; Calibrated: 9/16/2008
- Phantom: Flat Phantom ELI4.0; Type: QDOVA001BB; Serial: SN:1013
- Measurement SW: DASY4, V4.7 Build 71; Postprocessing SW: SEMCAD, V1.8 Build 184

CS10/Area Scan (111x71x1): Measurement grid: dx=20mm, dy=20mm

Maximum value of SAR (interpolated) = 0.267 mW/g

CS10/Zoom Scan (7x7x7)/Cube 0: Measurement grid: dx=5mm, dy=5mm, dz=5mm

Reference Value = 2.62 V/m; Power Drift = -0.152 dB

Peak SAR (extrapolated) = 0.695 W/kg

SAR(1 g) = 0.281 mW/g; SAR(10 g) = 0.128 mW/g

Maximum value of SAR (measured) = 0.314 mW/g

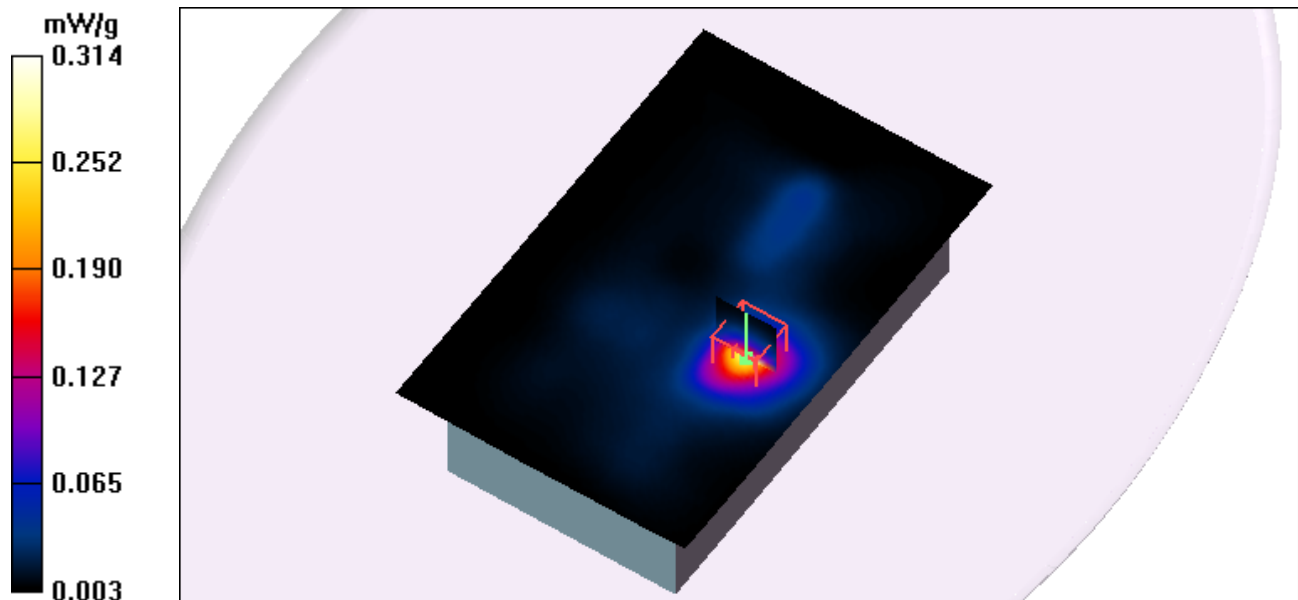

Test Laboratory: Eurofins Product Service GmbH

Wlan_Ch 1_OFDM_6Mbs_Flat_Back_0mm

DUT: CS10; Type: Field controller; Serial: 13-004

Communication System: WLAN 2450; Frequency: 2412 MHz; Duty Cycle: 1:1

Medium: Muscle 2450 MHz Medium parameters used: $f = 2412$ MHz; $\sigma = 2$ mho/m; $\epsilon_r = 52.9$; $\rho = 1000$ kg/m³

Phantom section: Flat Section

DASY4 Configuration:

- Probe: ET3DV6 - SN1711; ConvF(3.81, 3.81, 3.81); Calibrated: 9/17/2008
- Sensor-Surface: 4mm (Mechanical And Optical Surface Detection)
- Electronics: DAE3 Sn522; Calibrated: 9/16/2008
- Phantom: Flat Phantom ELI4.0; Type: QDOVA001BB; Serial: SN:1013
- Measurement SW: DASY4, V4.7 Build 71; Postprocessing SW: SEMCAD, V1.8 Build 184

CS10/Area Scan (111x71x1): Measurement grid: dx=20mm, dy=20mm

Maximum value of SAR (interpolated) = 0.164 mW/g

CS10/Zoom Scan (7x7x7)/Cube 0: Measurement grid: dx=5mm, dy=5mm, dz=5mm

Reference Value = 1.92 V/m; Power Drift = -0.041 dB

Peak SAR (extrapolated) = 0.468 W/kg

SAR(1 g) = 0.194 mW/g; SAR(10 g) = 0.090 mW/g

Maximum value of SAR (measured) = 0.214 mW/g

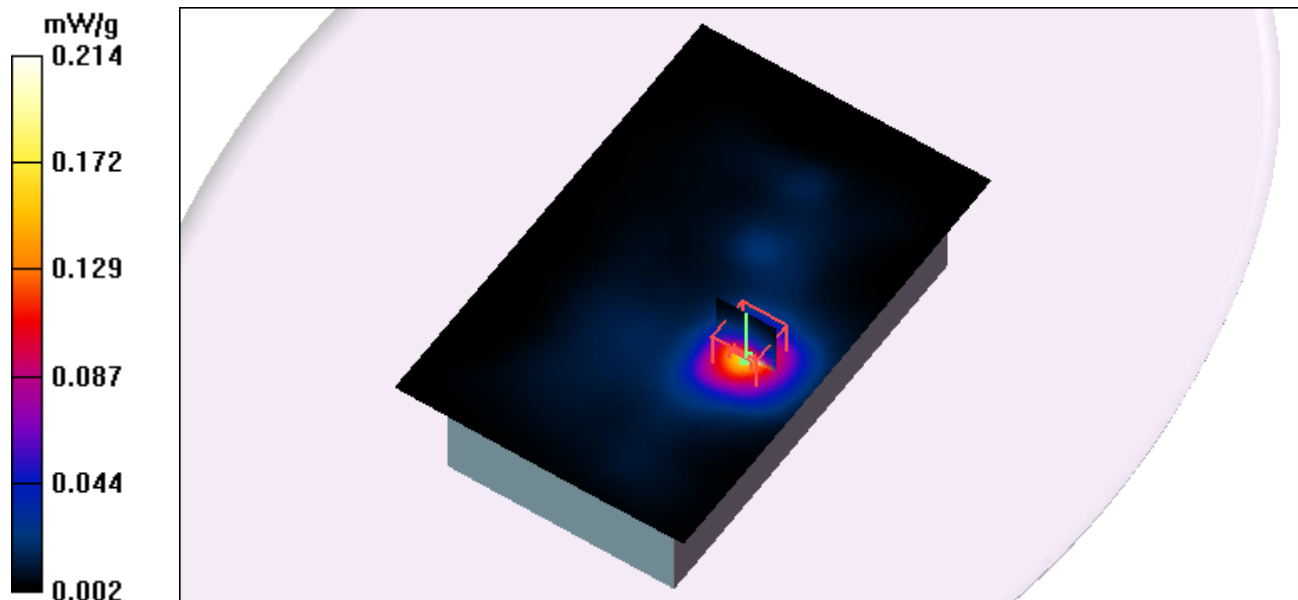

Test Laboratory: Eurofins Product Service GmbH

Wlan_Ch 6_OFDM_6Mbs_Flat_Front_0mm

DUT: CS10; Type: Field controller; Serial: 13-004

Communication System: WLAN 2450; Frequency: 2437 MHz; Duty Cycle: 1:1

Medium: Muscle 2450 MHz Medium parameters used: $f = 2437$ MHz; $\sigma = 2.03$ mho/m; $\epsilon_r = 52.9$; $\rho = 1000$ kg/m³

Phantom section: Flat Section

DASY4 Configuration:

- Probe: ET3DV6 - SN1711; ConvF(3.81, 3.81, 3.81); Calibrated: 9/17/2008
- Sensor-Surface: 4mm (Mechanical And Optical Surface Detection)
- Electronics: DAE3 Sn522; Calibrated: 9/16/2008
- Phantom: Flat Phantom ELI4.0; Type: QDOVA001BB; Serial: SN:1013
- Measurement SW: DASY4, V4.7 Build 71; Postprocessing SW: SEMCAD, V1.8 Build 184

CS10/Area Scan (111x71x1): Measurement grid: dx=20mm, dy=20mm

Maximum value of SAR (interpolated) = 0.014 mW/g

CS10/Zoom Scan (7x7x7)/Cube 0: Measurement grid: dx=5mm, dy=5mm, dz=5mm

Reference Value = 1.30 V/m; Power Drift = -0.167 dB

Peak SAR (extrapolated) = 0.026 W/kg

SAR(1 g) = 0.011 mW/g; SAR(10 g) = 0.00691 mW/g

Maximum value of SAR (measured) = 0.015 mW/g

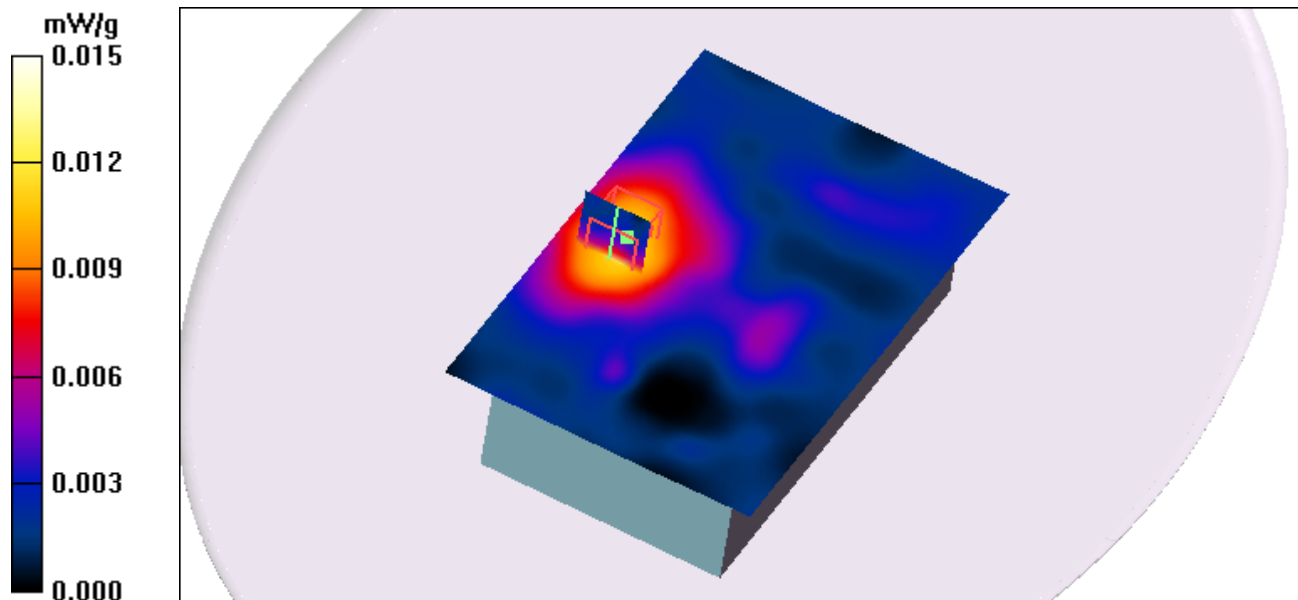

Test Laboratory: Eurofins Product Service GmbH

Wlan_Ch 6_OFDM_6Mbs_Flat_Back_0mm

DUT: CS10; Type: Field controller; Serial: 13-004

Communication System: WLAN 2450; Frequency: 2437 MHz; Duty Cycle: 1:1

Medium: Muscle 2450 MHz Medium parameters used (interpolated): $f = 2437$ MHz; $\sigma = 2.03$ mho/m; $\epsilon_r = 52.9$; $\rho = 1000$ kg/m³

Phantom section: Flat Section

DASY4 Configuration:

- Probe: ET3DV6 - SN1711; ConvF(3.81, 3.81, 3.81); Calibrated: 9/17/2008
- Sensor-Surface: 4mm (Mechanical And Optical Surface Detection)
- Electronics: DAE3 Sn522; Calibrated: 9/16/2008
- Phantom: Flat Phantom ELI4.0; Type: QDOVA001BB; Serial: SN:1013
- Measurement SW: DASY4, V4.7 Build 71; Postprocessing SW: SEMCAD, V1.8 Build 184

CS10/Area Scan (111x71x1): Measurement grid: dx=20mm, dy=20mm

Maximum value of SAR (interpolated) = 0.179 mW/g

CS10/Zoom Scan (7x7x7)/Cube 0: Measurement grid: dx=5mm, dy=5mm, dz=5mm

Reference Value = 1.82 V/m; Power Drift = -0.146 dB

Peak SAR (extrapolated) = 0.448 W/kg

SAR(1 g) = 0.189 mW/g; SAR(10 g) = 0.088 mW/g

Maximum value of SAR (measured) = 0.200 mW/g

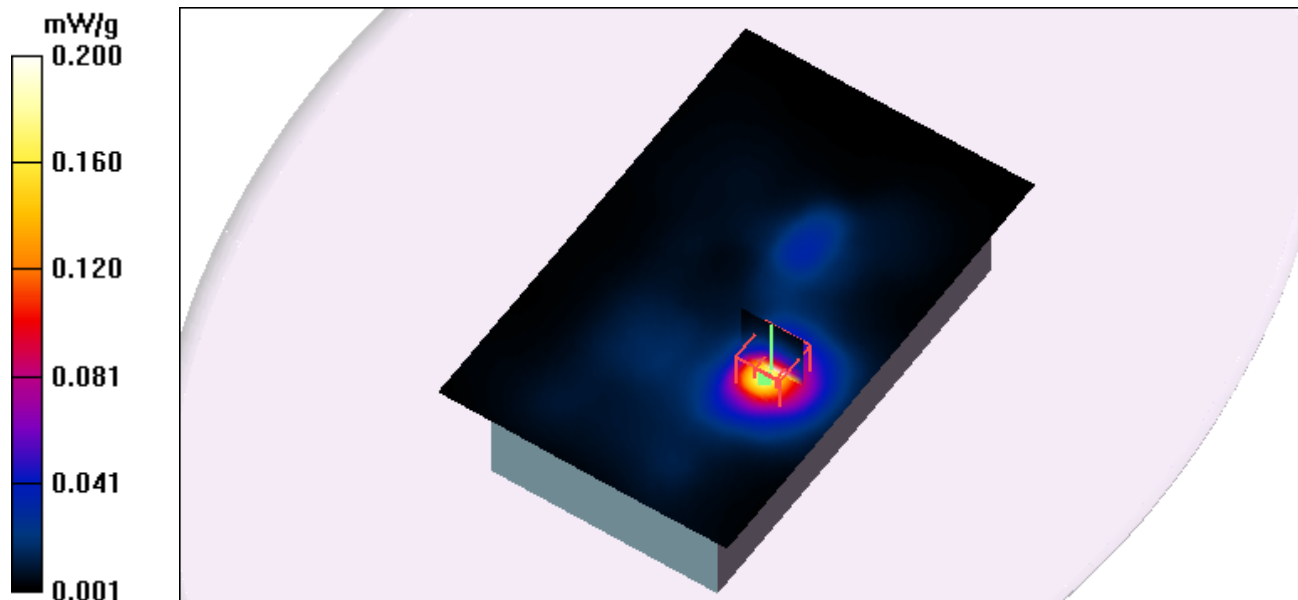

Test Laboratory: Eurofins Product Service GmbH

Wlan_Ch 11_OFDM_6Mbs_Flat_Back_0mm

DUT: CS10; Type: Field controller; Serial: 13-004

Communication System: WLAN 2450; Frequency: 2462 MHz; Duty Cycle: 1:1

Medium: Muscle 2450 MHz Medium parameters used: $f = 2462$ MHz; $\sigma = 2.04$ mho/m; $\epsilon_r = 52.9$; $\rho = 1000$ kg/m³

Phantom section: Flat Section

DASY4 Configuration:

- Probe: ET3DV6 - SN1711; ConvF(3.81, 3.81, 3.81); Calibrated: 9/17/2008
- Sensor-Surface: 4mm (Mechanical And Optical Surface Detection)
- Electronics: DAE3 Sn522; Calibrated: 9/16/2008
- Phantom: Flat Phantom ELI4.0; Type: QDOVA001BB; Serial: SN:1013
- Measurement SW: DASY4, V4.7 Build 71; Postprocessing SW: SEMCAD, V1.8 Build 184

CS10/Area Scan (111x71x1): Measurement grid: dx=20mm, dy=20mm

Maximum value of SAR (interpolated) = 0.210 mW/g

CS10/Zoom Scan (7x7x7)/Cube 0: Measurement grid: dx=5mm, dy=5mm, dz=5mm

Reference Value = 2.02 V/m; Power Drift = -0.079 dB

Peak SAR (extrapolated) = 0.594 W/kg

SAR(1 g) = 0.248 mW/g; SAR(10 g) = 0.116 mW/g

Maximum value of SAR (measured) = 0.271 mW/g

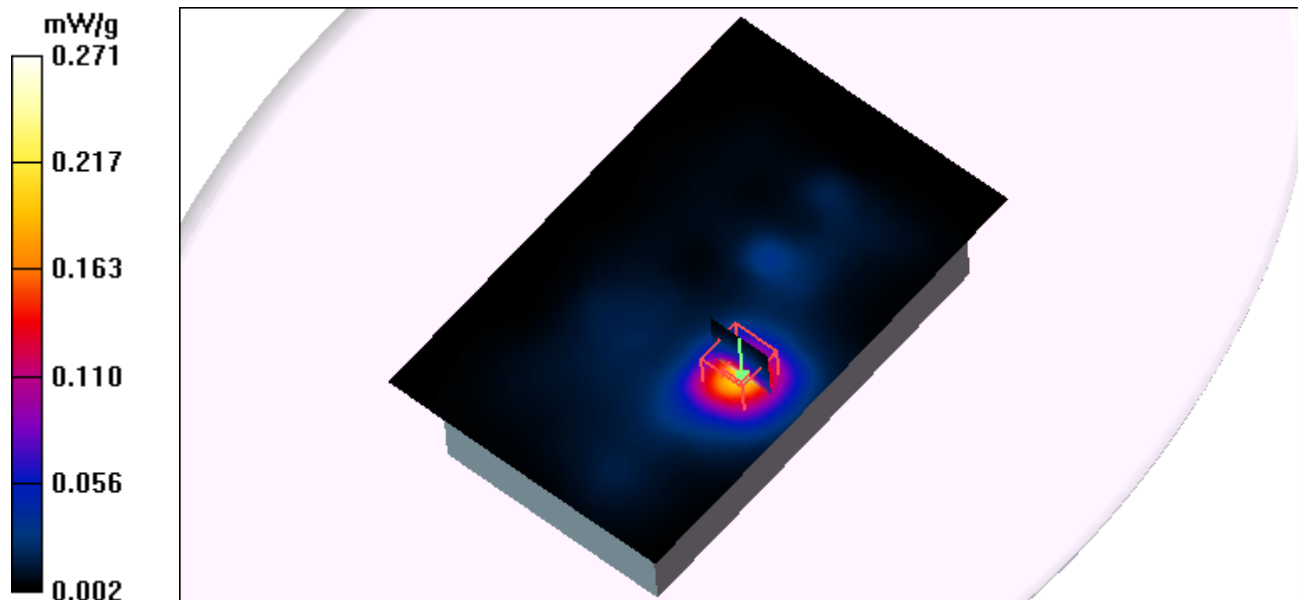

Test Laboratory: Eurofins Product Service GmbH

Z - axis scan

DUT: CS10; Type: Field controller; Serial: 13-004

Communication System: WLAN 2450; Frequency: 2462 MHz; Duty Cycle: 1:1

Medium: Muscle 2450 MHz Medium parameters used: $f = 2462$ MHz; $\sigma = 2.04$ mho/m; $\epsilon_r = 52.9$; $\rho = 1000$ kg/m³

Phantom section: Flat Section

DASY4 Configuration:

- Probe: ET3DV6 - SN1711; ConvF(3.81, 3.81, 3.81); Calibrated: 9/17/2008
- Sensor-Surface: 4mm (Mechanical And Optical Surface Detection)
- Electronics: DAE3 Sn522; Calibrated: 9/16/2008
- Phantom: Flat Phantom ELI4.0; Type: QDOVA001BB; Serial: SN:1013
- Measurement SW: DASY4, V4.7 Build 71; Postprocessing SW: SEMCAD, V1.8 Build 184

CS10/Area Scan (111x71x1): Measurement grid: dx=20mm, dy=20mm

Maximum value of SAR (interpolated) = 0.267 mW/g

CS10/Zoom Scan (7x7x7)/Cube 0: Measurement grid: dx=5mm, dy=5mm, dz=5mm

Reference Value = 2.62 V/m; Power Drift = -0.152 dB

Peak SAR (extrapolated) = 0.695 W/kg

SAR(1 g) = 0.281 mW/g; SAR(10 g) = 0.128 mW/g

Maximum value of SAR (measured) = 0.314 mW/g

