



EUROFINS PRODUCT SERVICE GMBH

# SAR

# TEST - REPORT

**SAR Compliance Test Report**

**Test report no.:**

**G0M21007-3512-S-1**

**Field Controller**

**CS15**

**FCC-ID: RFD-CS-S-BG**



Eurofins Product Service GmbH  
Storkower Str. 38c, 15526 Reichenwalde,  
Germany

Phone +49-33631-888 0  
Fax +49-33631-888 660

## TABLE OF CONTENTS

<b>1</b>	<b>General information</b>	<b>3</b>
1.1	Notes	3
1.2	Testing laboratory	4
1.3	Details of approval holder	4
1.4	Manufacturer	5
1.5	Application details	5
1.6	Test item	5
1.7	Test results	6
1.8	Test standards	6
<b>2</b>	<b>Technical test</b>	<b>7</b>
2.1	Summary of test results	7
2.2	Test environment	7
2.3	Test equipment utilized	8
2.4	Definitions	9
2.5	Measurement system description	10
2.6	Test system specification	15
2.7	Measurement procedure	16
2.8	Reference points	17
2.9	Test positions	19
2.10	Measurement uncertainty	23
<b>3</b>	<b>Tissue and system verification</b>	<b>24</b>
3.1	Tissue verification	24
3.2	System verification	25
<b>4</b>	<b>Test Results</b>	<b>26</b>
<b>5</b>	<b>Transmitter co-location performance evaluation</b>	<b>29</b>
<b>6</b>	<b>References</b>	<b>32</b>
<b>7</b>	<b>Annex</b>	<b>33</b>

## 1 General Information

### 1.1 Notes

The results of this test report relate exclusively to the item tested as specified in chapter "Description of test item" and are not transferable to any other test items.

Eurofins Product Service GmbH is not responsible for any generalisations and conclusions drawn from this report. Any modification of the test item can lead to invalidity of test results and this test report may therefore be not applicable to the modified test item.

The test report may only be reproduced or published in full. Reproducing or publishing extracts of the report requires the prior written approval of the Eurofins Product Service GmbH.

This document is subject to the General Terms and Conditions and the Testing and Certification System of Eurofins Product Service GmbH, available on request or accessible at [www.pt.eurofins.com](http://www.pt.eurofins.com)

I attest to the accuracy of data. All measurements reported herein were performed by me or were made under my supervision and are correct to the best of my knowledge and belief. I assume full responsibility for the completeness of these measurements and vouch for the qualification of all persons taking them.

#### Operator:

04.05.2011

B. Pudell



Date

Eurofins -Lab.

Name

Signature

#### Technical responsibility for area of testing:

04.05.2011

J. Zimmermann

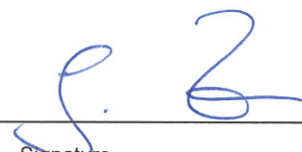

Date

Eurofins

Name

Signature

## 1.2 Testing laboratory

### 1.2.1 Location

EUROFINS PRODUCT SERVICE GMBH  
Storkower Straße 38c  
D-15526 Reichenwalde b. Berlin  
Germany  
Telephone : +49 33631 888 00  
Fax : +49 33631 888 660

### 1.2.2 Details of accreditation status

**DAR ACCREDITED TESTING LABORATORY**  
DAR-REGISTRATION NUMBER: DAT-P-268/08

**RECOGNIZED NOTIFIED BODY EMC**  
REGISTRATION NUMBER: BNetzA-bS EMV-07/61

**RECOGNIZED NOTIFIED BODY R&TTE**  
REGISTRATION NUMBER: BNetzA-bS-02/51-53

**FCC FILED TEST LABORATORY**  
REG.-NO. 96970

**A2LA ACCREDITED TESTING LABORATORY**  
CERTIFICATE NO. 1983.01

**BLUETOOTH QUALIFICATION TEST FACILITY (BQTF)**  
ACCREDITED BY BLUETOOTH QUALIFICATION REVIEW BOARD

**INDUSTRY CANADA FILED TEST LABORATORY**  
REG. NO. IC 3470

**Statement:** The tests documented within this report are carried out in accordance with the scope of accreditation of test laboratory Eurofins Product Service GmbH.

## 1.3 Details of approval holder

Name : Leica Geosystems AG  
Street : Heinrich Wild Strasse 1  
Town : CH-9435 Heerbrugg  
Country : Switzerland  
Telephone : +41 71 727 3098  
Fax : +41 71 726 5098  
  
Contact : Herr Hannes Juen  
E-Mail : Hannes.Juen@Leica-Geosystems.com

#### 1.4 Manufacturer: (if applicable)

Name :  
 Street :  
 Town :  
 Country :

#### 1.5 Application details

Date of receipt of application : 26.07.2010  
 Date of receipt of test item : 26.07.2010  
 Date of test : 17.08.2010 - 25.08.2010

#### 1.6 Test item

FCC ID : RFD-CS-S-BG  
 Description of test item : Field Controller  
 Type identification : CS15  
 Serial number : without; Identical prototype  
 Device category : PCT (Licensed Portable Transmitter Worn On Body)

#### Technical data

UMTS Frequency range	: <b><u>Operation Band V</u></b>	<b><u>Operation Band II</u></b>
TX Frequency range	: 824 - 849MHz	1850 - 1910 MHz
RX Frequency range	: 869 - 894MHz	1930 - 1990 MHz
Max. rad. RF output power	: 23.93 (0.25 W)	23.48 (0.22 W)

#### GSM / PCS / EGPRS

Frequency range	: <b><u>GSM 850 / EGPRS</u></b>	<b><u>PCS 1900 / EGPRS</u></b>
TX Frequency range	: 824.2 - 848.8 MHz	1850.2 - 1909.9 MHz
RX Frequency range	: 869.2 - 893.8 MHz	1930.2 - 1989.8 MHz
Max. rad. RF output power	: 33.07 dBm (2.03 W)	29.28 dBm (0.85 W)

#### WLAN

TX / RX Frequency range : 2400,0 - 2483,5 MHz  
 Tested Frequency : Ch.6 2437,0 MHz  
 Max.rad. RF output power : 20.60 dBm (0.11 W)

Power supply	: 7.4VDC rechargeable battery
Antenna Tx	: integral
Antenna RX	: integral
Additional information	: Tx and Rx. antenna are the same.

This test sample was tested according FCC OET Bulletin 65, Supplement C, Edition 01-01 on the used Frequency band..

## 1.7 Test Results

Max. SAR Measurement UMTS Band V (Body)	: 0.248mW/g (averaged over 1 gram)
Max. SAR Measurement UMTS Band II (Body)	: 0.416 mW/g (averaged over 1 gram)
Max. SAR Measurement GPRS/EGPRS 850 (Body)	: 0.800 mW/g (averaged over 1 gram)
Max. SAR Measurement GPRS/EGPRS 1900 (Body)	: 0.248 mW/g (averaged over 1 gram)
Max. SAR Measurement WLAN (Body)	: 0.162 mW/g (averaged over 1 gram)

This EUT has been shown to be capable of compliance for localized specific absorption rate (SAR) for uncontrolled environment/general population exposure limits specified in ANSI/IEEE Std. C95.1-1992 and had been tested in accordance with the measurement procedures specified in FCC/OET Bulletin 65 Supplement C (2001) and IEEE Std. 1528-2003, December 2003.

## 1.8 Test standards

Standards	: - IEEE Std. 1528-2003, December 2003
FCC Rule Part(s)	: - FCC OET Bulletin 65, Supplement C, Edition 01-01

## 2 Technical test

### 2.1 Summary of test results

#### Applicable Configuration

Handset (Head)	
Handset (Body)	
Headset (Head)	
Body Worn Equipment	X

EUT complies with the RF radiation exposure limits of the FCC as shown by the SAR measurement results. These measurements are taken to simulate the RF effects exposure under worst-case conditions. The EUT complies with the requirements in respect to all parameters subject to the test. The test results and statements relate only to the item(s) tested.

Please note that the absorption and distribution of electromagnetic energy in the body are very complex phenomena that depend on the mass, shape, and size of the body, the orientation of the body with respect to the field vectors, and the electrical properties of both the body and the environment. Other variables that may play a substantial role in possible biological effects are those that characterize the environment (e.g. ambient temperature, air velocity, relative humidity, and body insulation) and those that characterize the individual (e.g. age, gender, activity level, debilitation, or disease). Because innumerable factors may interact to determine the specific biological outcome of an exposure to electromagnetic fields, any protection guide shall consider maximal amplification of biological effects as a result of field-body interactions, environmental conditions, and physiological variables. [1]

In case of multiple hotspots the secondary hotspots within 2 dB of the maximum SAR value will be recorded and displayed in the measurement plots. The secondary hotspots with a peak SAR value below 0.5 W/kg will not be measured by the system, due to the high margin to the limits.

### 2.2 Test environment

Room temperature	: 22.1 - 22.6 °C
Liquid temperature	: 22.0 - 22.3 °C
Relative humidity content	: 20 ... 75 %
Air pressure	: 86 ... 103 kPa
Details of power supply	: 7.4VDC

### 2.3 Test equipment utilized

No.	Measurement device:	Type:	Manufacturer:
ETS 0449	Stäubli Robot	RX90B L	Stäubli
ETS 0450	Stäubli Robot Controller	CS/MBs&p	Stäubli
ETS 0451	DASY 4 Measurement Server		Schmid & Partner
ETS 0452	Control Pendant		Stäubli
ETS 0453	Compaq Computer	Pentium IV, 2 GHz,	Schmid & Partner
ETS 0454	Dabu Acquisition Electronics	DAE3V1	Schmid & Partner
ETS 0455	Dummy Probe		Schmid & Partner
ETS 0456	Dosimetric E-Field Probe	ET3DV6	Schmid & Partner
ETS 0457	Dosimetric E-Field Probe	ET3DV6	Schmid & Partner
ETS 0458	Dosimetric H-Field Probe	H3DV6	Schmid & Partner
ETS 0479	System Validation Kit	D300V3	Schmid & Partner
ETS 0480	System Validation Kit	D450V3	Schmid & Partner
ETS 0459	System Validation Kit	D900V2	Schmid & Partner
ETS 0460	System Validation Kit	D1800V2	Schmid & Partner
ETS 0461	System Validation Kit	D1900V2	Schmid & Partner
ETS 0462	System Validation Kit	D2450V2	Schmid & Partner
ETS 0463	Probe Alignment Unit	LBV2	Schmid & Partner
ETS 0464	SAM Twin phantom	V 4.0	Schmid & Partner
ETS 0513	Flat phantom	V 4.4	Schmid & Partner
ETS 0467	Oval flat phantom	ELI 4	Schmid & Partner
ETS 0465	Mounting Device	V 3.1	Schmid & Partner
ETS 0224a	Millivoltmeter	URV 5	Rohde & Schwarz
ETS 0219	Power sensor	NRV-Z2	Rohde & Schwarz
ETS 0268	RF signal generator	SMP 02	Rohde & Schwarz
ETS 0322	Insertion unit	URV5-Z4	Rohde & Schwarz
ETS 0466	Directional Coupler	HP 87300B	HP
ETS 0231	Radio Communication Tester	CMD65	Rohde & Schwarz
ETS 0484	Universal Radio Communication Tester	CMU 200	Rohde & Schwarz
ETS 0468	Network Analyzer 300 kHz to 3 GHz	8753C	Agilent
ETS 0469	Dielectric Probe Kit	85070C	Agilent



## 2.4 Definitions

### 2.4.1 SAR

The specific absorption rate (SAR) is defined as the time derivative of the incremental energy ( $dW$ ) absorbed by (dissipated in) an incremental mass ( $dm$ ) contained in a volume element ( $dV$ ) of a given density ( $\rho_t$ ), expressed in watts per kilogram (W/kg).

$$\text{SAR} = \frac{d}{dt} \left( \frac{dW}{dm} \right) = \frac{d}{dt} \left( \frac{dW}{\rho_t dV} \right) = \frac{\sigma}{\rho_t} |E_t|^2$$

where:

$$\frac{dW}{dt} = \int_v E \cdot J dV = \int_v \sigma E^2 dV$$

### 2.4.2 Uncontrolled Exposure

The general population/uncontrolled exposure limits are applicable to situations in which the general public may be exposed or in which persons who are exposed as a consequence of their employment may not be made fully aware of the potential for exposure or cannot exercise control over their exposure. Members of the general public would come under this category when exposure is not employment-related; for example, in the case of a wireless transmitter that exposes persons in its vicinity. Warning labels placed on low-power consumer devices such as cellular telephones are not considered sufficient to allow the device to be considered under the occupational/controlled category, and the general population/uncontrolled exposure limits apply to these devices. [2].

### 2.4.3 Controlled Exposure

In general, occupational/controlled exposure limits are applicable to situations in which persons are exposed as a consequence of their employment, who have been made fully aware of the potential for exposure and can exercise control over their exposure. This exposure category is also applicable when the exposure is of a transient nature due to incidental passage through a location where the exposure levels may be higher than the general population/uncontrolled limits, but the exposed person is fully aware of the potential for exposure and can exercise control over his or her exposure by leaving the area or by some other appropriate means. Awareness of the potential for RF exposure in a workplace or similar environment can be provided through specific training as part of a RF safety program. If appropriate, warning signs and labels can also be used to establish such awareness by providing prominent information on the risk of potential exposure and instructions on the risk of potential exposure and instructions on methods to minimize such exposure risks. [2].

## 2.5 Measurement System Description

### 2.5.1 System Setup

Measurements are performed using the DASY4 automated dosimetric assessment system (figure 1) made by Schmid & Partner Engineering AG (SPEAG) in Zurich, Switzerland.



Figure 1

The DASY4 system for performing compliance tests consists of the following items:

- A standard high precision 6-axis robot (Stäubli RX family) with controller, teach pendant and software. An arm extension for accommodating the data acquisition electronics (DAE).
- A dosimetric probe, i.e., an isotropic E-field probe optimized and calibrated for usage in tissue simulating liquid. The probe is equipped with an optical surface detector system.
- A data acquisition electronics (DAE) which performs the signal amplification, signal multiplexing, AD-conversion, offset measurements, mechanical surface detection, collision detection, etc. The unit is battery powered with standard or rechargeable batteries. The signal is optically transmitted to the EOC.
- An unit to operate the optical surface detector which is connected to the EOC.
- The Electro-optical converter (EOC) performs the conversion from the optical into a digital electric signal of the DAE. The EOC is connected to the measurement server.
- The functions of the measurement server is to perform the time critical task such as signal filtering, surveillance of the robot operation, fast movement interrupts.
- A probe alignment unit which improves the (absolute) accuracy of the probe positioning.
- A computer operating Windows 2000 or Windows NT.
- DASY4 software.
- Remote control with teach pendant and additional circuitry for robot safety such as warning lamps, etc.
- The SAM twin phantom enabling testing left-hand and right-hand usage.
- The device holder for handheld mobile phones.
- Tissue simulating liquid mixed according to the given recipes (see Application Notes).
- System validation dipoles allowing to validate the proper functioning of the system.

## 2.5.2 Phantom Description



(Figure 2.1)

The SAM twin phantom V4.0 (figure 2.1) is a fiberglass shell phantom with 2 mm shell thickness. It has three measurement areas:

- Left hand
- Right hand
- Flat phantom

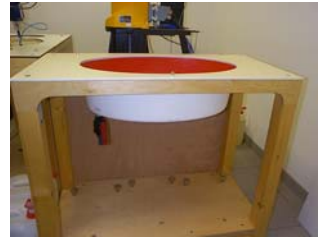

(Figure 2.2)

The Oval flat phantom (ELI 4) (figure 2.2) is a fiberglass shell phantom with 2 mm thickness.

The phantom is integrated in a wooden table.

The bottom plate of the table contains three pair of bolts for locking the device holder. The device holder positions are adjusted to the standard measurement positions in the three sections. Only one device holder is necessary if two phantoms are used (e.g., for different liquids).

A cover is provided to tap the phantom during off-periods to prevent water evaporation and changes in the liquid parameters. Free space scans of devices on the cover are possible.

On the phantom top, three reference markers are provided to identify the phantom positions with respect to the robot.

### 2.5.3 Tissue Simulating Liquids

The parameters of the tissue simulating liquid strongly influence the SAR. The parameters for the different frequencies are defined in the corresponding compliance standards (e.g., EN 62311, IEEE P1528-2003).

Tissue dielectric properties

Frequency (MHz)	Head		Body	
	Relative Dielectric Constant ( $\epsilon_r$ )	Conductivity ( $\sigma$ ) (S/m)	Relative Dielectric Constant ( $\epsilon_r$ )	Conductivity ( $\sigma$ ) (S/m)
300	45.3	0.87	58.2	0.92
450	43.5	0.87	56.7	0.94
835	41.5	0.90	55.2	0.97
900	41.5	0.97	55.0	1.05
1450	40.5	1.20	54.0	1.30
1800	40.0	1.40	53.3	1.52
1900	40.0	1.40	53.3	1.52
2000	40.0	1.40	53.3	1.52
2450	39.2	1.80	52.7	1.95
3000	38.5	2.40	52.0	2.73

## 2.5.4 Device Holder

The DASY device holder (figure 3.1 and 3.2) is designed to cope with different positions given in the standard. It has two scales for the device rotation (with respect to the body axis) and the device inclination (with respect to the line between the ear openings). The rotation centers for both scales is the ear opening. Thus the device needs no repositioning when changing the angles.



Figure 3.1



Figure 3.2

The DASY device holder has been made out of low-loss POM material having the following dielectric parameters: relative permittivity  $\epsilon = 3$  and loss tangent  $\delta = 0.02$ . The amount of dielectric material has been reduced in the closest vicinity of the device, since measurements have suggested that the influence of the clamp on the test results could thus be lowered.

## 2.5.5 Probes

The SAR measurements were conducted with the dosimetric probe ET3DV6 (figure 4), designed in the classical triangular configuration and optimized for dosimetric evaluation. [3] The probe is constructed using the thick film technique; with printed resistive lines on ceramic substrates. The probe is equipped with an optical multifiber line ending at the front of the probe tip. It is connected to the EOC box on the robot arm and provides an automatic detection of the phantom surface. Half of the fibers are connected to a pulsed infrared transmitter, the other half to a synchronized receiver. As the probe approaches the surface, the reflection from the surface produces a coupling from the transmitting to the receiving fibers. This reflection increases first during the approach, reaches maximum and then decreases. If the probe is flatly touching the surface, the coupling is zero. The distance of the coupling maximum to the surface is independent of the surface reflectivity and largely independent of the surface to probe angle. The DASY4 software reads the reflection during a software approach and looks for the maximum using a 2<sup>nd</sup> order fitting. The approach is stopped at reaching the maximum.



Figure 4

## Probe Specifications

Calibration:	In air from 10 MHz to 2.5 GHz In brain and muscle simulating tissue at Frequencies of 835 MHz, 900 MHz, 1800 MHz, 1900 MHz and 2450 MHz Calibration certificates please find attached.
Frequency:	10 MHz to > 3 GHz; Linearity: $\pm 0.2$ dB (30 MHz to 3 GHz)
Directivity:	$\pm 0.2$ dB in HSL (rotation around probe axis) $\pm 0.4$ dB in HSL (rotation normal probe axis)
Dynamic Range:	5 $\mu$ W/g to > 100 mW/g;
Linearity:	$\pm 0.2$ dB
Dimensions:	Overall length: 330 mm Tip length: 16 mm Body diameter: 12 mm Tip diameter: 6.8 mm Distance from probe tip to dipole centers: 2.7 mm
Application:	General dosimetry up to 3 GHz Compliance tests of mobile phones Fast automatic scanning in arbitrary phantoms

## 2.6 Test System Specification

### Positioner

Robot:	Stäubli Animation Corp. Robot Model: RX90B L
Repeatability:	0.02 mm
No. of axis:	6

### Data Acquisition Electronic (DAE) System

#### Cell Controller

Processor:	Pentium IV
Clock Speed:	2.0 GHz
Operating System:	Windows 2000
Data Card:	DASY4 PC-Board
Data Converter	
Features:	Signal Amplifier, multiplexer, A/D converter, & control logic
Software:	DASY4 software
Connecting Lines:	Optical downlink for data and status info. Optical uplink for commands and clock

#### PC Interface Card

Function:	24 bit (64 MHz) DSP for real time processing Link to DAE3 16 bit A/D converter for surface detection system serial link to robot direct emergency stop output for robot
-----------	---

#### E-Field Probes

Model:	ET3DV6 SN1711
Construction:	Triangular core fiber optic detection system
Frequency:	10 MHz to 6 GHz
Linearity:	$\pm 0.2$ dB (30MHz to 3 GHz)

#### Phantom

Phantom 1:	Oval flat phantom (ELI 4)
Shell Material:	Fiberglass
Thickness:	$2.0 \pm 0.2$ mm
Phantom 2:	SAM Twin Phantom (V4.0)
Shell Material:	Fiberglass
Thickness:	$2.0 \pm 0.2$ mm

## 2.7 Measurement Procedure

The evaluation was performed using the following procedure:

1. The SAR measurement was taken at a selected spatial reference point to monitor power variations during testing. This fixed location point was measured and used as a reference value.
2. The SAR distribution at the exposed side of the head was measured at a distance of 3.9 mm from the inner surface of the shell. The area covered the entire dimension of the head and the horizontal grid spacing was 10 mm x 10 mm.
3. Based on the area scan data, the area of the maximum absorption was determined by spline interpolation. Around this point, a volume of 30 mm x 30 mm x 30 mm (fine resolution volume scan, zoom scan) was assessed by measuring 5 x 5 x 5 points. On this basis of this data set, the spatial peak SAR value was evaluated with the following procedure:
  - a. The data at the surface was extrapolated, since the center of the dipoles is 2.7 mm away from the tip of the probe and the distance between the surface and the lowest measuring point is 1.2 mm. The extrapolation was based on a least square algorithm [4]. A polynomial of the fourth order was calculated through the points in z-axes. This polynomial was then used to evaluate the points between the surface and the probe tip.
  - b. The maximum interpolated value was searched with a straight-forward algorithm. Around this maximum the SAR values averaged over the spatial volumes (1 g or 10 g) were computed using the 3D-Spline interpolation algorithm. The 3D-spline is composed of three one-dimensional splines with the "Not a knot" condition (in x, y, and z directions) [4] [5]. The volume was integrated with the trapezoidal algorithm. One thousand points (10 x 10 x 10) were interpolated to calculate the average.
  - c. All neighboring volumes were evaluated until no neighboring volume with a higher average value was found.
4. The SAR reference value, at the same location as procedure # 1, was re-measured. If the value changed by more than 5 %, the evaluation is repeated.



## 2.8 Reference Points

### 2.8.1 Ear Reference Points

Figure 5.1 shows the front, back and side vies of SAM. The point "M" is the reference point for the center of mouth, "LE" is the left ear reference point (ERP), and "RE" is the right ERP. The ERPs are 15 mm posterior to the entrance to ear canal (EEC) along the B-M line (Back-Mouth), as shown in Figure 5.2. The plane passing through the two ear reference points and M is defined as the Reference Plane. The line N-F (Neck-Front) perpendicular to the reference plane and passing through the RE (or LE) is called the Reference Pivoting Line (see Figure 5.3). Line B-M is perpendicular to the N-F line. Both N-F and B-M lines should be marked on the external phantom shell to facilitate handset positioning. Posterior to the N-F line, the thickness of the N-F line, the ear is truncated as illustrated in Figure 5.2. The ear truncation is introduced to avoid the handset from touching the ear lobe, which can cause unstable handset positioning at the cheek. [6]

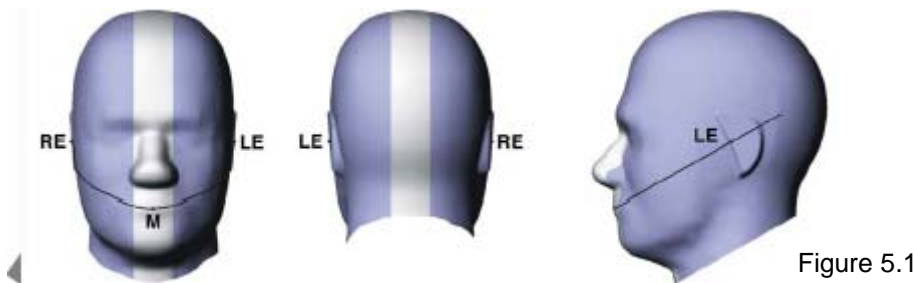

Figure 5.1

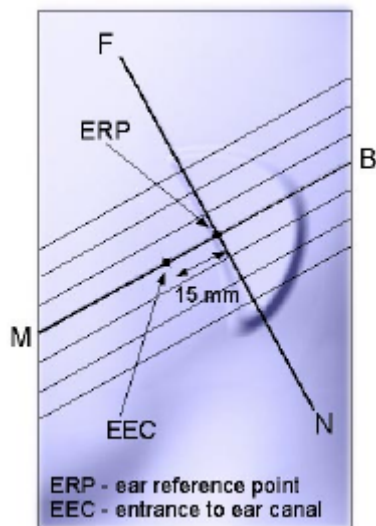

Figure 5.2

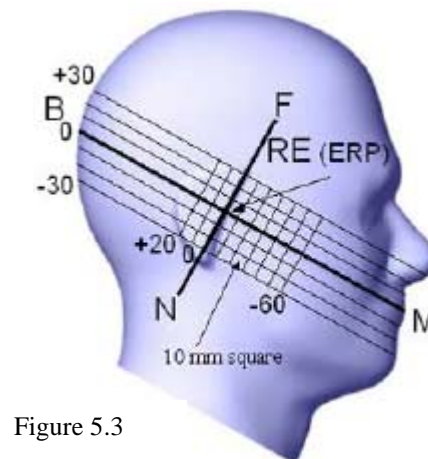

Figure 5.3

## 2.8.2 Handset Reference Points

Two imaginary lines on the handset were defined: the vertical centerline and the horizontal line. The vertical centerline passes through two points on the front side of the handset: the midpoint of the width  $w_t$  of the handset at the level of the acoustic output (point A on Figures 6.1 and 6.2), and the midpoint of the width  $w_b$  of the bottom of the handset (point B). The horizontal line is perpendicular to the vertical centerline and passes through the center of the acoustic output (see Figure 6.1). The two lines intersect at point A. For many handsets, point A coincides with the center of the acoustic output. However, the acoustic output may be located elsewhere on the horizontal line. The vertical centerline is not necessarily parallel to the front face of the handset (see Figure 6.2), especially for clamshell handsets, handsets with flip pieces, and other irregularly-shaped handsets. [6]

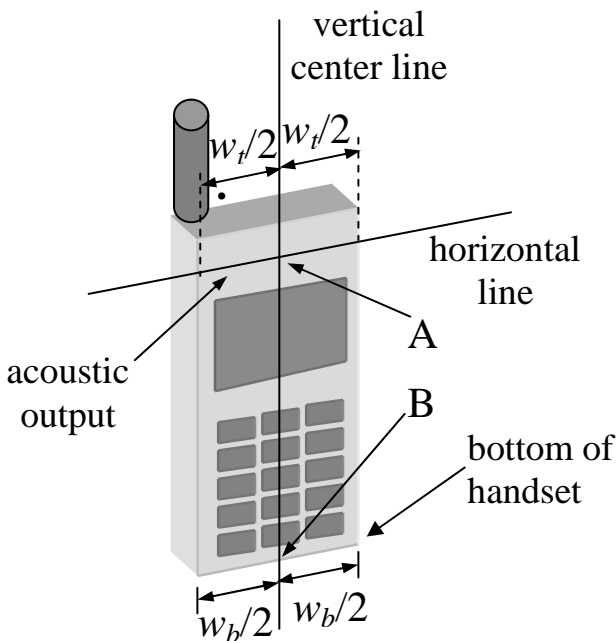

Figure 6.1

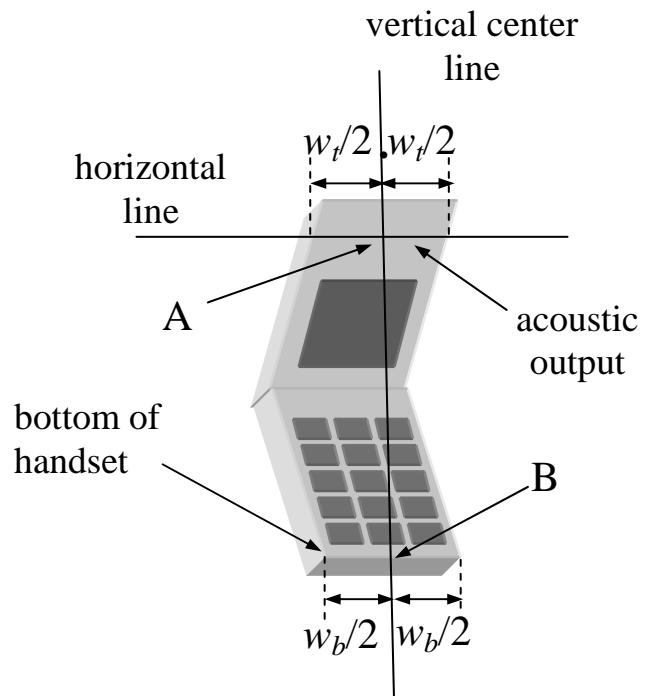

Figure 6.2

## 2.9 Test Positions

### 2.9.1 "Cheek" / "Touch" Position

The EUT was positioned close to the surface of the phantom such that point A is on the (virtual) extension of the line passing through points RE and LE on the phantom (see Figure 7), such that the plane defined by the vertical center line and the horizontal line of the handset is approximately parallel to the sagittal plane of the phantom.

The EUT was translated towards the phantom along the line passing through RE and LE until the handset touches the pinna.

While maintaining the handset in this plane, the EUT was rotated it around the LE-RE line until the vertical centerline was in the plane normal to MB-NF including the line MB (called the reference plane).

The EUT was rotated around the vertical centerline until the handset (horizontal line) was symmetrical with respect to the line NF.

While maintaining the vertical centerline in the reference plane, keeping point A on the line passing through RE and LE and maintaining the handset contact with the pinna, the EUT was rotated about the line NF until any point on the handset was in contact with a phantom point below the pinna (cheek). [6] See Figure 7.

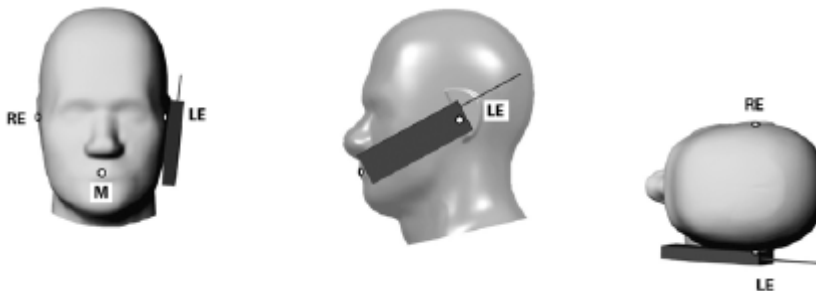

Figure 7

## 2.9.2 "Tilted" Position

The EUT was in "cheek position".

While maintaining the orientation of the handset move the handset away from the pinna along the line passing through RE and LE in order to enable a rotation of the handset by 15 degrees.

The EUT was rotated around the horizontal line by 15 degrees.

While maintaining the orientation of the handset, the EUT was moved towards the phantom on a line passing through RE and LE until any part of the handset touched the ear. The tilted position is obtained when the contact is on the pinna. If the contact was at any location other than the pinna (e.g., the antenna with the back of the phantom head), the angle of the handset would be reduced. In this case, the tilted position is obtained if any part of the handset was in contact with the pinna as well as a second part of the handset was in contact with the phantom (e.g., the antenna with the back of the head). [6] See Figure 8.

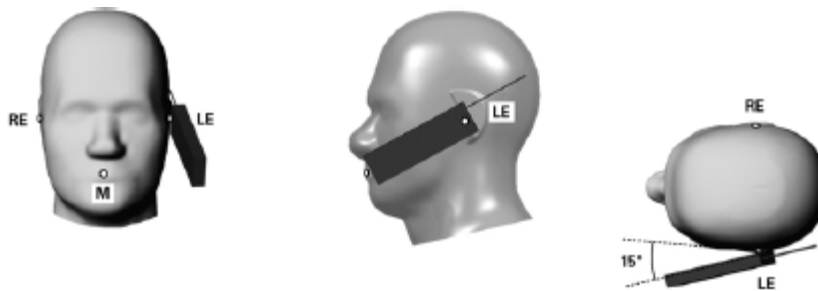

Figure 8

### 2.9.3 Belt Clip/Holster Configuration

Test configurations for body-worn operated EUTs are carried out while the belt-clip and/or holster is attached to the EUT and placed against a flat phantom in a regular configuration (see Figure 9). An EUT with a headset output is tested with a headset connected to the device.

Body dielectric parameters are used.

There are two categories for accessories for body-worn operation configurations:

1. accessories not containing metallic components
2. accessories containing metallic components.

When the EUT is equipped with accessories not containing metallic components the tests are done with the accessory that dictates the closest spacing to the body. For accessories containing metallic parts a test with each one is implemented. If the multiple accessories share an identical metallic component (e.g. the same metallic belt-clip used with different holsters with no other metallic components) only the accessory that has the closest spacing to the body is tested.

In case that a EUT authorized to be body-worn is not supplied or has no options to be operated with any accessories, a test configuration where a separation distance between the back of the device and the flat phantom is used. All test position spacings are documented.

Transmitters operating in front of a person's face (e.g. push-to-talk configurations) are tested for SAR compliance with the front of the device positioned to face the flat platform. SAR Compliance tests for shoulder, waist or chest-worn transmitters are carried out with the accessories including headsets and microphones attached to the device and placed against a flat phantom in a regular configuration.

The SAR measurements are performed to investigate the worst-case positioning. This is documented and used to perform Body SAR testing. [2].



Figure 9

## 2.9.4 Headset Configuration

Headsets which have their radiating structure in close proximity to the head are measured according to the following conditions.

- Head tissue liquid is used.
- The EUT is positioned on the surface of the head of phantom according the picture below. Right and left position is tested according to the normal use (see figure 10).
- Additional metallic parts like clips or others are subject of testing, too.



Figure 10

Headsets which have their radiating structure in close proximity to the body are tested as body worn equipment.

## 2.10 Measurement uncertainty

The uncertainty budget has been determined for the DASY4 system performance check according to IEEE Std. 1528-2003 December 2003.

Error Description	Tol. (± %)	Prob. dist.	Div.	$(c_j)^1$ (1 g)	Std. unc. (1 g) (± %)	$(v_j)^2$
<b>Measurement System</b>						
Probe Calibration	4.8	N	1	1	4.8	$\infty$
Axial Isotropy	4.7	R	$\sqrt{3}$	0.7	1.9	$\infty$
Hemispherical Isotropy	9.6	R	$\sqrt{3}$	0.7	3.9	$\infty$
Boundary Effects	1.0	R	$\sqrt{3}$	1	0.6	$\infty$
Linearity	4.7	R	$\sqrt{3}$	1	2.7	$\infty$
System Detection Limit	1.0	R	$\sqrt{3}$	1	0.6	$\infty$
Readout Electronics	1.0	N	1	1	1.0	$\infty$
Response Time	0.8	R	$\sqrt{3}$	1	0.5	$\infty$
Integration Time	2.6	R	$\sqrt{3}$	1	1.5	$\infty$
RF Ambient Conditions	3.0	R	$\sqrt{3}$	1	1.7	$\infty$
Probe Positioner	0.4	R	$\sqrt{3}$	1	0.2	$\infty$
Probe Positioning	2.9	R	$\sqrt{3}$	1	1.7	$\infty$
Algorithms for Max. SAR Eval.	1.0	R	$\sqrt{3}$	1	0.6	$\infty$
<b>Test Sample Related</b>						
Device Positioning	2.9	N	1	1	2.9	145
Device Holder	3.6	N	1	1	3.6	5
Power Drift	5.0	R	$\sqrt{3}$	1	2.9	$\infty$
<b>Phantom and Setup</b>						
Phantom Uncertainty	4.0	R	$\sqrt{3}$	1	2.3	$\infty$
Liquid Conductivity (target)	5.0	R.	$\sqrt{3}$	0.64	1.8	$\infty$
Liquid Conductivity (meas.)	2.6	N	1	0.64	1.7	$\infty$
Liquid Permittivity (target)	5.0	R	$\sqrt{3}$	0.6	1.7	$\infty$
Liquid Permittivity (meas.)	3.8	N	1	0.6	2.3	$\infty$
<b>Combined Standard Uncertainty</b>					<b>10.4</b>	<b>330</b>
<b>Expanded Uncertainty <math>k_p = 2</math></b>						
<b>Coverage Factor for 95 %</b>					<b>20.8</b>	

The budget is valid for the frequency range 300 MHz - 3 GHz and represent a worst case analysis. For specific tests and configurations, the uncertainty could be considerable smaller.

### 3 Tissue and System Verification

#### 3.1 Tissue Verification

Dielectric parameters of the simulating liquids were verified using a Dielectric Probe Kit Agilent 85070D to a tolerance of  $\pm 5\%$ .

Room Temperature: 22.1 - 22.6 ° C

	Measured Tissue Parameters			
	900 MHz Muscle		1900 MHz Muscle	
	Target	Measured	Target	Measured
Date:		17.08.2010 18.08.2010		20.08.2010 23.08.2010
Liquid Temperature: ° C		22,1		22,1
Dielectric Constant: $\epsilon$	55,0	54,1	53,3	51,9
Conductivity: $\sigma$	1,05	1,01	1,52	1,56

	Measured Tissue Parameters	
	2450 MHz Muscle	
	Target	Measured
Date:		24.08.2010 25.08.2010
Liquid Temperature: ° C		22,1
Dielectric Constant: $\epsilon$	52,7	52,9
Conductivity: $\sigma$	1,95	2,03



### 3.2 System Verification

Prior to the assessment, the system was verified by using a 850 / 1900 and 2450MHz validation dipole. Power level of 250 mW was supplied to the dipole antenna placed under the flat section of SAM Phantom.

The system was verified to a tolerance of  $\pm 10 \%$ .

**Liquid Temperature:** 22.0 - 22.3 °C  
**Room Temperature:** 22.1 - 22.6 °C  
**Liquid Depth:** >15.5 cm

System Dipole Validation Target & Measurement					
Date	System Validation Kit:	Liquid	Targeted SAR 1 g (mW/g)	Measured SAR 1 g (mW/g)	Deviation (%)
17.08.2010	D900V2 SN164	900 MHz Muscle	11.2	10.64	-5
18.08.2010	D900V2 SN164	900 MHz Muscle	11.2	10.76	-3.929
20.08.2010	D1900V2 SN5d025	1900 MHz Muscle	45.6	42.8	-6.14
23.08.2010	D1900V2 SN5d025	1900 MHz Muscle	45.6	42.4	-7.02
24.08.2010	D2450V2 SN722	2450 MHz Muscle	54.8	54.4	-0.73

Comment: Please find attached the measurement plots.

## 4 Test Results

### Procedures Used To Establish Test Signal

The EUT was placed into simulated call mode (e.g. AMPS, Cellular CDMA & PCS CDMA modes) using manufacturers test codes. Such test signals offer a consistent means for testing SAR and are recommended for evaluating SAR [2]. The actual transmission is activated through a base station simulator or similar when test modes are not available or inappropriate for testing the EUT.

The EUT is rechargeable battery operated. The battery used for the SAR measurements was completely charged. The device was tested at full power verified by implementing conducted output power measurements. For confirming of the output power it was tested before and after each SAR measurement. The test was repeated if a conducted power deviation of more than 5 % occurred.

**Frequency band:** GSM 850  
**Liquid Temperature:** 22.0 - 22.3 °C **Room Temperature:** 22.1 - 22.6 °C  
**Mixture Type:** 900 MHz Muscle  
**Date:** 17.08.2010

Frequency			Power Drift dBm	Antenna Pos.	Phantom Section	Test Position 10 mm	SAR (mW/g)
MHz	Channel	Modulation					
824,2	128	EGPRS	-0.845	Integral	Flat	Front	0.795
824,2	128	GPRS	-0.185	Integral	Flat	Back	0.536
824,2	128	GPRS	-0.121	Integral	Flat	Front	<b>0.800</b>
836,2	188	GPRS	-0.167	Integral	Flat	Back	0.482
836,2	188	GPRS	-0.129	Integral	Flat	Front	0.694
848,8	251	GPRS	-0.101	Integral	Flat	Back	0.402
848,8	251	GPRS	-0.149	Integral	Flat	Front	0.644

**Frequency band:** GSM 1900  
**Liquid Temperature:** 22.0 - 22.3 °C **Room Temperature:** 22.1 - 22.6 °C  
**Mixture Type:** 1900 MHz Muscle  
**Date:** 23.08.2010

Frequency			Power Drift dBm	Antenna Pos.	Phantom Section	Test Position 10 mm	SAR (mW/g)
MHz	Channel	Modulation					
1850,2	512	EGPRS	-0.144	Integral	Flat	Back	0.249
1850,2	512	GPRS	-0.128	Integral	Flat	Back	<b>0.253</b>
1880,0	661	GPRS	-0.133	Integral	Flat	Back	0.249
1880,0	661	GPRS	-0.139	Integral	Flat	Front	0.236
1909,8	810	GPRS	-0.177	Integral	Flat	Back	0.200

**Frequency band:** UMTS Operation Band V  
**Mixture Type:** 900 MHz Muscle  
**Date:** 18.08.2010  
**Liquid Temperature:** 22.0 - 22.3 °C **Room Temperature:** 22.1 - 22.6 °C

Frequency			Power Drift dBm	Antenna Pos.	Phantom Section	Test Position 10 mm	SAR (mW/g)
MHz	Channel	Modulation					
826,6	4133	HSDPA	0.123	Integral	Flat	Back	0.210
826,6	4133	HSDPA	0.086	Integral	Flat	Front	<b>0.248</b>
835,0	4175	HSDPA	-0.167	Integral	Flat	Back	0.189
835,0	4175	HSDPA	0.041	Integral	Flat	Front	0.227
846,4	4232	HSDPA	0.159	Integral	Flat	Back	0.173
846,4	4232	HSDPA	0.146	Integral	Flat	Front	0.209

**Frequency band:** UMTS Operation Band II  
**Mixture Type:** 1900 MHz Muscle  
**Date:** 20.08.2010  
**Liquid Temperature:** 22.0 - 22.3 °C **Room Temperature:** 22.1 - 22.6 °C

Frequency			Power Drift dBm	Antenna Pos.	Phantom Section	Test Position 10 mm	SAR (mW/g)
MHz	Channel	Modulation					
1852,6	9263	HSDPA	0.087	Integral	Flat	Back	0.304
1880,0	9400	HSDPA	-0.101	Integral	Flat	Back	<b>0.416</b>
1880,0	9400	HSDPA	0.156	Integral	Flat	Front	0.185
1907,4	9537	HSDPA	-0.101	Integral	Flat	Back	0.362

**Mixture Type:** 2450 MHz Muscle  
**Date:** 25.08.2010  
**Liquid Temperature:** 22.0 - 22.3 °C **Room Temperature:** 22.1 - 22.6 °C

Frequency			Power Drift dBm	Antenna Pos.	Phantom Section	Test Position 10mm	SAR (W/kg)
MHz	Channel	Modulation					
2437	6	OFDM	-0.132	Integral	Flat	Front	0.003
2437	6	OFDM	-0.185	Integral	Flat	Back	<b>0.162</b>

WLAN 802.11b DSSS transmission mode SAR values are lower than the values for the OFDM 802.11g transmission mode and have been omitted.

Limits:

Exposure Limits	SAR (W/kg)					
	Uncontrolled Exposure/General Population Environment			Controlled Exposure/Occupational Environment		
	Region	Australia	US	EU	Australia	US
Spatial Average SAR (averaged over the whole body)	0.08	0.08	0.08	0.40	0.40	0.40
Spatial Peak SAR (averaged over any 1 g of tissue)	2.00	1.60	2.00	10.0	8.00	10.0
Spatial Peak SAR (Hands, Feet, Ankles, Wrist) (averaged over any 10 g of tissue)	4.00	4.00	4.00	20.0	20.0	20.0

Notes:

1. Test data represent the worst case SAR value and test procedure used are according to OET Bulletin 65, Supplement C (01-01).
2. All modes of operation were investigated.

## 5. Transmitter co-location performance evaluation

The following transmitters are implemented in the device:

- Bluetooth
- WLAN 802.11b/g
- GSM/UMTS

For co-location calculation a transmitter has to fulfill multiple conditions before it has to be taken into account. The mutual distance of the antennas of two transmitters has to be lower than 200mm and the transmitter has to have a transmitter power above a certain threshold value before it is of any concern regarding transmitter co-transmission or co-location.

The euclidean distances between the various transmitter antennas in the device are summarized in the table below. Again each technology that is closer than 200mm to another transmitter is relevant.

Distance Antenna to Antenna [mm]			
	Bluetooth	WLAN	GSM/UMTS
Bluetooth		195	100
WLAN	195		125
GSM/UMTS	100	125	

The power threshold is given by the expression  $60/f$  [GHz]. Any transmitter whose power level is larger than the value given by this threshold has to be taken into account.

Conducted Power Threshold					
Transmitter	Highest Frequency [MHz]	Conducted Power [dBm]	Conducted Power [mW]	$60/f$ [GHz] Threshold [mW]	Over Threshold
Bluetooth	2480	0.75	1.19	24.19	No
WLAN 802.11g	2462	20.6	114.8	24.37	Yes
GSM850	848.8	33.07	2027.68	70.69	Yes
GSM1900	1909.8	29.28	847.23	31.42	Yes
UMTS Band V	846.6	23.93	247.17	70.87	Yes
UMTS Band II	1907.6	23.48	222.84	31.45	Yes

The following table list the co-transmission capability of the transmitters of the device.

Co-transmission capability			
	Bluetooth	WLAN	GSM/UMTS
Bluetooth		Yes	Yes
WLAN	Yes		Yes
GSM/UMTS	Yes	Yes	

Regarding the data given in the tables the following transmitter modes have to be taken into account:

- WLAN 802.11b/g
- GSM/UMTS

For these transmitter modes the co-transmission SAR values are obtained:

SAR co-location results							
Worst Case Position	GSM 850	GSM 1900	UMTS Band II	UMTS Band V	WLAN 802.11b	WLAN 802.11g	Σ SAR
	848.8MHz	1909.8MHz	1907.6MHz	846.6MHz	2462MHz	2462MHz	
Flat Front	0.800					0.003	0.803
Flat Back		0.253				0.162	0.415
Flat Back			0.416			0.162	0.578
Flat Front				0.248		0.003	0.251

Limits:

Exposure Limits	SAR (W/kg)					
	Uncontrolled Exposure/General Population Environment			Controlled Exposure/Occupational Environment		
Region	Australia	US	EU	Australia	US	EU
Spatial Average SAR (averaged over the whole body)	0.08	0.08	0.08	0.40	0.40	0.40
Spatial Peak SAR (averaged over any 1 g of tissue)	2.00	1.60	2.00	10.0	8.00	10.0
Spatial Peak SAR (Hands, Feet, Ankles, Wrist) (averaged over any 10 g of tissue)	4.00	4.00	4.00	20.0	20.0	20.0

## 6 References

- [1] ANSI/IEEE C95.3 - 1991, *IEEE Recommended Practice for the Measurement of Potentially Hazardous Electromagnetic fields, 300 kHz to 100 GHz*, New York: IEEE, Aug. 1992
- [2] Federal Communications Commission, OET Bulletin 65 (Edition 97-01), Supplement C (Edition 01-01), *Evaluating Compliance with FCC Guidelines for Human Exposure to Radiofrequency Electromagnetic Fields*, July 2001.
- [3] T. Schmid, O. Egger, N. Kuster, *Automated E-field scanning system for dosimetric assessments*, IEEE Transaction on Microwave Theory and Techniques, vol. 44, Jan. 1996, pp. 105-113.
- [4] W. Gander, *Computer mathematics*, Birkhaeuser, Basel, 1992.
- [5] W.H. Press, S.A. Teukolsky, W.T. Vetterling, and B.P. Flannery, *Numerical Recipes in C, The Art of Scientific Computing*, Second edition, Cambridge University Press, 1992.
- [6] IEEE Standards Coordinating Committee 34 – IEEE Std. 1528-2003, December 2003 *Recommended Practice for Determining the Peak Spatial-Average Absorption Rate (SAR in the Human Body Due to Wireless Communications Devices: Experimental Techniques*.
- [7] *DASY4 Dosimetric Assessment System Manual*; Draft; September 6, 2002; Schmid & Partner Engineering AG



## 7 Annex

1. Annex A Calibration Certificate  
D1900V2 SN5d025  
D900V2 SN164  
D2450V2 SN722  
ET3DV6 SN1711  
DAE3V1-522
2. Annex B Measurement Plots
3. Annex C Pictures

## Annex A

### Calibration Certificate

Note:

The calibration cycle for SAR field probes and related equipment is determined to one year. According to Eurofins's internal quality management instruction based on EN 17025 the calibration cycle for other test equipment is determined to 2 years. Additionally, Eurofins has prolonged the calibration interval for SPEAG System Validation Dipoles by two additional years. These QM procedures are acknowledged by the accreditation bodies mentioned on page 3 of this report during several accreditation audits.



Accredited by the Swiss Accreditation Service (SAS)  
 The Swiss Accreditation Service is one of the signatories to the EA  
 Multilateral Agreement for the recognition of calibration certificates

Accreditation No.: **SCS 108**

Client **Eurofins**

Certificate No: **D900V2-164\_Sep09**

## CALIBRATION CERTIFICATE

Object **D900V2 - SN: 164**

Calibration procedure(s) **QA CAL-05.v7**  
**Calibration procedure for dipole validation kits**

Calibration date: **September 14, 2009**

Condition of the calibrated item **In Tolerance**

This calibration certificate documents the traceability to national standards, which realize the physical units of measurements (SI).  
 The measurements and the uncertainties with confidence probability are given on the following pages and are part of the certificate.

All calibrations have been conducted in the closed laboratory facility: environment temperature (22 ± 3)°C and humidity < 70%.

Calibration Equipment used (M&TE critical for calibration)

Primary Standards	ID #	Cal Date (Certificate No.)	Scheduled Calibration
Power meter EPM-442A	GB37480704	08-Oct-08 (No. 217-00898)	Oct-09
Power sensor HP 8481A	US37292783	08-Oct-08 (No. 217-00898)	Oct-09
Reference 20 dB Attenuator	SN: 5086 (20g)	31-Mar-09 (No. 217-01025)	Mar-10
Type-N mismatch combination	SN: 5047.2 / 06327	31-Mar-09 (No. 217-01029)	Mar-10
Reference Probe ES3DV3	SN: 3205	26-Jun-09 (No. ES3-3205_Jun09)	Jun-10
DAE4	SN: 601	07-Mar-09 (No. DAE4-601_Mar09)	Mar-10

Secondary Standards	ID #	Check Date (in house)	Scheduled Check
Power sensor HP 8481A	MY41092317	18-Oct-02 (in house check Oct-07)	In house check: Oct-09
RF generator R&S SMT-06	100005	4-Aug-99 (in house check Oct-07)	In house check: Oct-09
Network Analyzer HP 8753E	US37390585 S4206	18-Oct-01 (in house check Oct-08)	In house check: Oct-09

Calibrated by: **Jeton Kastrati**      Name: **Jeton Kastrati**      Function: **Laboratory Technician**

Approved by: **Katja Pokovic**      Name: **Katja Pokovic**      Function: **Technical Manager**

Signature

Issued: September 15, 2009

This calibration certificate shall not be reproduced except in full without written approval of the laboratory.



Accredited by the Swiss Accreditation Service (SAS)

The Swiss Accreditation Service is one of the signatories to the EA  
Multilateral Agreement for the recognition of calibration certificates

Accreditation No.: **SCS 108**

### Glossary:

TSL	tissue simulating liquid
ConvF	sensitivity in TSL / NORM x,y,z
N/A	not applicable or not measured

### Calibration is Performed According to the Following Standards:

- IEEE Std 1528-2003, "IEEE Recommended Practice for Determining the Peak Spatial-Averaged Specific Absorption Rate (SAR) in the Human Head from Wireless Communications Devices: Measurement Techniques", December 2003
- IEC 62209-1, "Procedure to measure the Specific Absorption Rate (SAR) for hand-held devices used in close proximity to the ear (frequency range of 300 MHz to 3 GHz)", February 2005
- Federal Communications Commission Office of Engineering & Technology (FCC OET), "Evaluating Compliance with FCC Guidelines for Human Exposure to Radiofrequency Electromagnetic Fields; Additional Information for Evaluating Compliance of Mobile and Portable Devices with FCC Limits for Human Exposure to Radiofrequency Emissions", Supplement C (Edition 01-01) to Bulletin 65

### Additional Documentation:

- DASY4/5 System Handbook

### Methods Applied and Interpretation of Parameters:

- Measurement Conditions:** Further details are available from the Validation Report at the end of the certificate. All figures stated in the certificate are valid at the frequency indicated.
- Antenna Parameters with TSL:** The dipole is mounted with the spacer to position its feed point exactly below the center marking of the flat phantom section, with the arms oriented parallel to the body axis.
- Feed Point Impedance and Return Loss:** These parameters are measured with the dipole positioned under the liquid filled phantom. The impedance stated is transformed from the measurement at the SMA connector to the feed point. The Return Loss ensures low reflected power. No uncertainty required.
- Electrical Delay:** One-way delay between the SMA connector and the antenna feed point. No uncertainty required.
- SAR measured:** SAR measured at the stated antenna input power.
- SAR normalized:** SAR as measured, normalized to an input power of 1 W at the antenna connector.
- SAR for nominal TSL parameters:** The measured TSL parameters are used to calculate the nominal SAR result.

## Measurement Conditions

DASY system configuration, as far as not given on page 1.

<b>DASY Version</b>	DASY5	V5.0
<b>Extrapolation</b>	Advanced Extrapolation	
<b>Phantom</b>	Modular Flat Phantom V4.9	
<b>Distance Dipole Center - TSL</b>	15 mm	with Spacer
<b>Zoom Scan Resolution</b>	dx, dy, dz = 5 mm	
<b>Frequency</b>	900 MHz $\pm$ 1 MHz	

## Head TSL parameters

The following parameters and calculations were applied.

	<b>Temperature</b>	<b>Permittivity</b>	<b>Conductivity</b>
<b>Nominal Head TSL parameters</b>	22.0 °C	41.5	0.97 mho/m
<b>Measured Head TSL parameters</b>	(22.0 $\pm$ 0.2) °C	40.4 $\pm$ 6 %	0.96 mho/m $\pm$ 6 %
<b>Head TSL temperature during test</b>	(21.7 $\pm$ 0.2) °C	---	---

## SAR result with Head TSL

<b>SAR averaged over 1 cm<sup>3</sup> (1 g) of Head TSL</b>	Condition	
SAR measured	250 mW input power	2.79 mW / g
SAR normalized	normalized to 1W	11.2 mW / g
SAR for nominal Head TSL parameters <sup>1</sup>	normalized to 1W	<b>11.2 mW / g <math>\pm</math> 17.0 % (k=2)</b>

<b>SAR averaged over 10 cm<sup>3</sup> (10 g) of Head TSL</b>	condition	
SAR measured	250 mW input power	1.78 mW / g
SAR normalized	normalized to 1W	7.12 mW / g
SAR for nominal Head TSL parameters <sup>1</sup>	normalized to 1W	<b>7.13 mW / g <math>\pm</math> 16.5 % (k=2)</b>

<sup>1</sup> Correction to nominal TSL parameters according to d), chapter "SAR Sensitivities"

## Body TSL parameters

The following parameters and calculations were applied.

	Temperature	Permittivity	Conductivity
Nominal Body TSL parameters	22.0 °C	55.0	1.05 mho/m
Measured Body TSL parameters	(22.0 ± 0.2) °C	52.7 ± 6 %	1.06 mho/m ± 6 %
Body TSL temperature during test	(22.0 ± 0.2) °C	---	---

## SAR result with Body TSL

SAR averaged over 1 cm <sup>3</sup> (1 g) of Body TSL	Condition	
SAR measured	250 mW input power	2.84 mW / g
SAR normalized	normalized to 1W	11.4 mW / g
SAR for nominal Body TSL parameters <sup>2</sup>	normalized to 1W	<b>11.2 mW / g ± 17.0 % (k=2)</b>

SAR averaged over 10 cm <sup>3</sup> (10 g) of Body TSL	condition	
SAR measured	250 mW input power	1.83 mW / g
SAR normalized	normalized to 1W	7.32 mW / g
SAR for nominal Body TSL parameters <sup>2</sup>	normalized to 1W	<b>7.24 mW / g ± 16.5 % (k=2)</b>

<sup>2</sup> Correction to nominal TSL parameters according to d), chapter "SAR Sensitivities"

## Appendix

### Antenna Parameters with Head TSL

Impedance, transformed to feed point	50.1 $\Omega$ - 7.4 j $\Omega$
Return Loss	- 22.7 dB

### Antenna Parameters with Body TSL

Impedance, transformed to feed point	46.0 $\Omega$ - 8.7 j $\Omega$
Return Loss	- 20.0 dB

### General Antenna Parameters and Design

Electrical Delay (one direction)	1.410 ns
----------------------------------	----------

After long term use with 100W radiated power, only a slight warming of the dipole near the feedpoint can be measured.

The dipole is made of standard semirigid coaxial cable. The center conductor of the feeding line is directly connected to the second arm of the dipole. The antenna is therefore short-circuited for DC-signals.

No excessive force must be applied to the dipole arms, because they might bend or the soldered connections near the feedpoint may be damaged.

### Additional EUT Data

Manufactured by	SPEAG
Manufactured on	May 16, 2002

## DASY5 Validation Report for Head TSL

Date/Time: 14.09.2009 09:39:14

Test Laboratory: SPEAG, Zurich, Switzerland

**DUT: Dipole 900 MHz; Type: D900V2; Serial: D900V2 - SN:164**

Communication System: CW-900; Frequency: 900 MHz; Duty Cycle: 1:1

Medium: HSL 900 MHz

Medium parameters used:  $f = 900$  MHz;  $\sigma = 0.96$  mho/m;  $\epsilon_r = 40.3$ ;  $\rho = 1000$  kg/m<sup>3</sup>

Phantom section: Flat Section

Measurement Standard: DASY5 (IEEE/IEC)

DASY5 Configuration:

- Probe: ES3DV3 - SN3205; ConvF(5.88, 5.88, 5.88); Calibrated: 26.06.2009
- Sensor-Surface: 3mm (Mechanical Surface Detection)
- Electronics: DAE4 Sn601; Calibrated: 07.03.2009
- Phantom: Flat Phantom 4.9L; Type: QD000P49AA; Serial: 1001
- Measurement SW: DASY 5, V5.0 Build 120; SEMCAD X Version 13.4 Build 45

**Pin=250mW; dip=15mm/Zoom Scan (7x7x7)/Cube 0:** Measurement grid: dx=5mm, dy=5mm, dz=5mm

Reference Value = 59.9 V/m; Power Drift = -0.013 dB

Peak SAR (extrapolated) = 4.23 W/kg

**SAR(1 g) = 2.79 mW/g; SAR(10 g) = 1.78 mW/g**

Maximum value of SAR (measured) = 3.28 mW/g

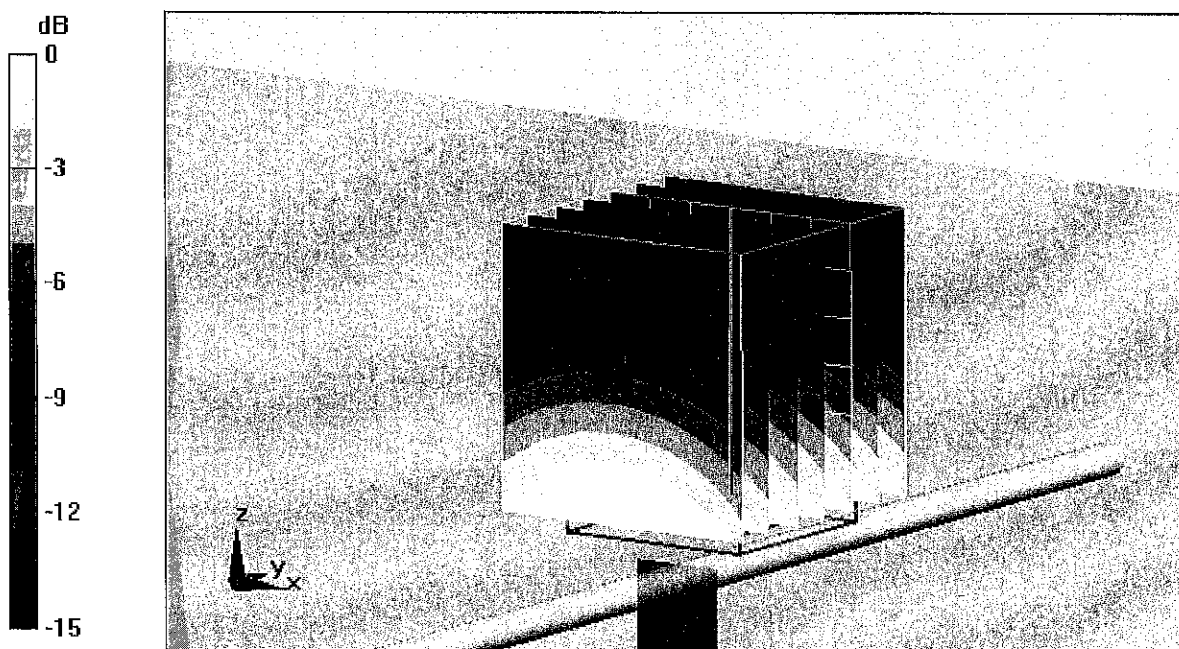

0 dB = 3.28mW/g



# Impedance Measurement Plot for Head TSL

14 Sep 2009 08:39:55

CH1 S11 1 U FS 2: 50.131  $\Omega$  -7.3672  $\Omega$  24.004 pF 900.000 000 MHz

\*  
De1  
Cor  
Avg  
16

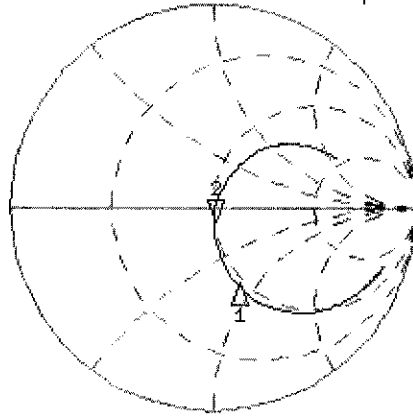

CH1 Markers  
1: 45.789  $\Omega$   
-41.656  $\Omega$   
835.000 MHz

CH2 S11 LOG 5 dB/REF -20 dB 2: -22.687 dB 900.000 000 MHz

Cor  
Avg  
16

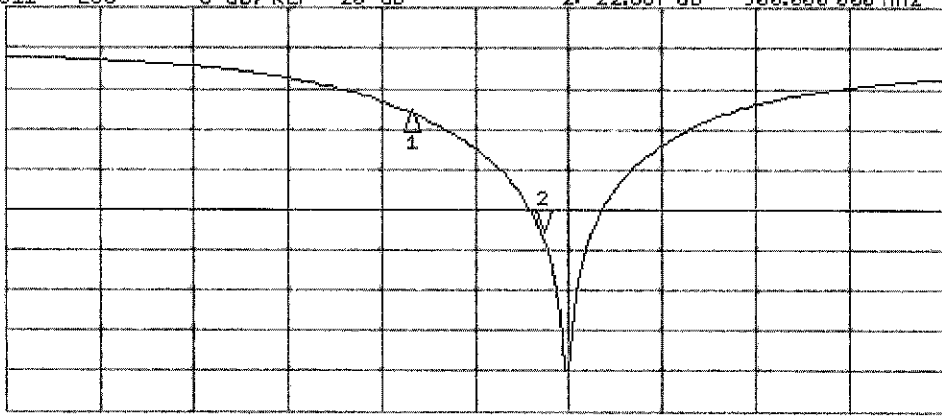

CH2 Markers  
1: -7.9408 dB  
835.000 MHz

START 635.000 000 MHz

STOP 1 100.000 000 MHz

## DASY5 Validation Report for Body

Date/Time: 14.09.2009 10:47:13

Test Laboratory: SPEAG, Zurich, Switzerland

**DUT: Dipole 900 MHz; Type: D900V2; Serial: D900V2 - SN:164**

Communication System: CW-900; Frequency: 900 MHz; Duty Cycle: 1:1

Medium: MSL900

Medium parameters used:  $f = 900$  MHz;  $\sigma = 1.06$  mho/m;  $\epsilon_r = 52.7$ ;  $\rho = 1000$  kg/m<sup>3</sup>

Phantom section: Flat Section

Measurement Standard: DASY5 (IEEE/IEC)

### DASY5 Configuration:

- Probe: ES3DV3 - SN3205; ConvF(5.81, 5.81, 5.81); Calibrated: 26.06.2009
- Sensor-Surface: 3mm (Mechanical Surface Detection)
- Electronics: DAE4 Sn601; Calibrated: 07.03.2009
- Phantom: Flat Phantom 4.9L; Type: QD000P49AA; Serial: 1001
- Measurement SW: DASY 5, V5.0 Build 120; SEMCAD X Version 13.4 Build 45

**Pin=250mW; dip=15mm/Zoom Scan (7x7x7)/Cube 0:** Measurement grid: dx=5mm, dy=5mm, dz=5mm

Reference Value = 57.7 V/m; Power Drift = 0.00836 dB

Peak SAR (extrapolated) = 4.23 W/kg

**SAR(1 g) = 2.84 mW/g; SAR(10 g) = 1.83 mW/g**

Maximum value of SAR (measured) = 3.31 mW/g

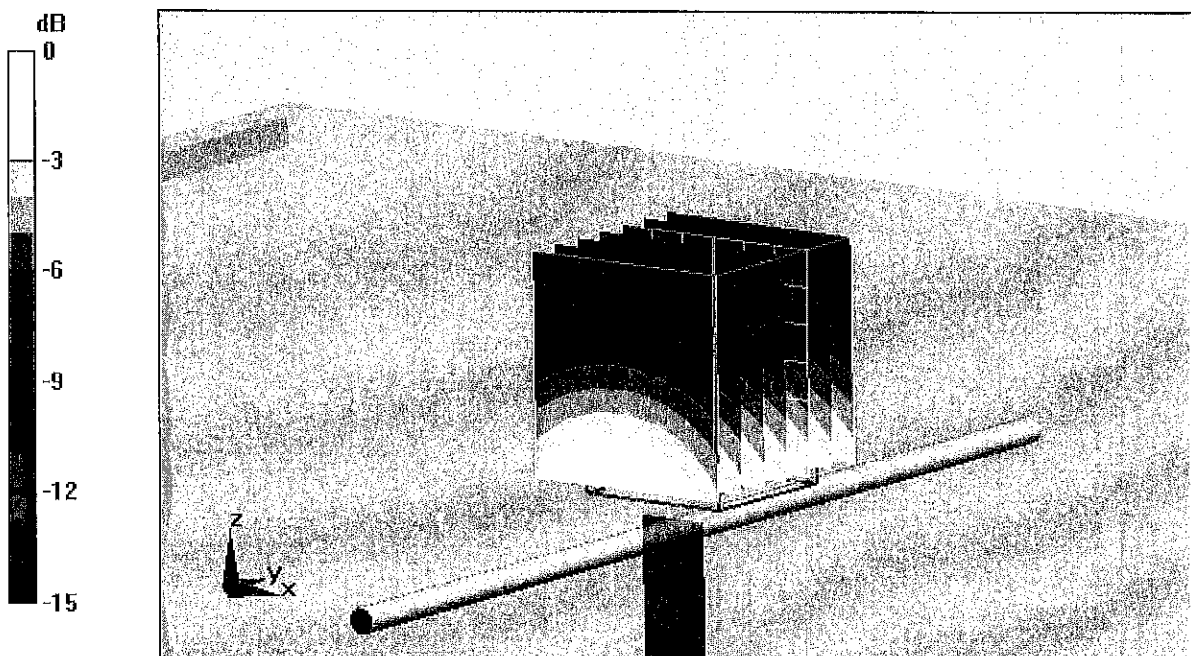

0 dB = 3.31mW/g

# Impedance Measurement Plot for Body TSL

14 Sep 2009 10:00:27

CH1 S11 1 U FS 2: 45.961  $\Omega$  -8.7227  $\Omega$  20.274 pF 900.000 000 MHz

\*  
Del  
Cor

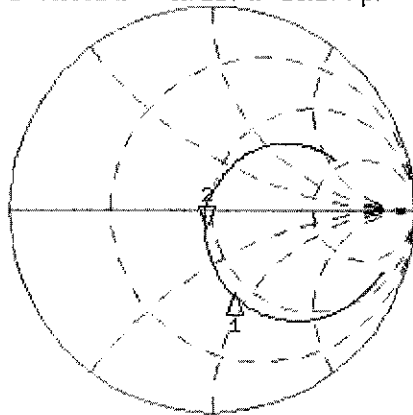

CH1 Markers  
1: 41.797  $\Omega$   
-42.623  $\Omega$   
835.000 MHz

Avg  
16

CH2 S11 LOG 5 dB/REF -20 dB 2: -20.022 dB 900.000 000 MHz

Cor

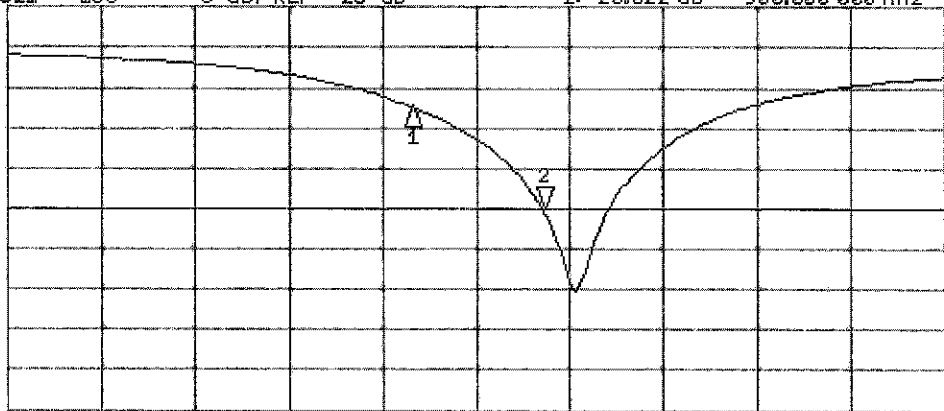

CH2 Markers  
1: -7.3534 dB  
835.000 MHz

Avg  
16

START 635.000 000 MHz

STOP 1 100.000 000 MHz



Accredited by the Swiss Accreditation Service (SAS)  
The Swiss Accreditation Service is one of the signatories to the EA  
Multilateral Agreement for the recognition of calibration certificates

Accreditation No.: **SCS 108**

Client **Eurofins**

Certificate No: **D1900V2-5d025-Sep09**

## CALIBRATION CERTIFICATE

Object **D1900V2 - SN: 5d025**

Calibration procedure(s) **QA CAL-05.v7**  
**Calibration procedure for dipole validation kits**

Calibration date: **September 15, 2009**

Condition of the calibrated item **In Tolerance**

This calibration certificate documents the traceability to national standards, which realize the physical units of measurements (SI).  
The measurements and the uncertainties with confidence probability are given on the following pages and are part of the certificate.

All calibrations have been conducted in the closed laboratory facility: environment temperature ( $22 \pm 3$ )°C and humidity < 70%.

Calibration Equipment used (M&TE critical for calibration)

Primary Standards	ID #	Cal Date (Calibrated by, Certificate No.)	Scheduled Calibration
Power meter EPM-442A	GB37480704	08-Oct-08 (No. 217-00898)	Oct-09
Power sensor HP 8481A	US37292783	08-Oct-08 (No. 217-00898)	Oct-09
Reference 20 dB Attenuator	SN: 5086 (20g)	31-Mar-09 (No. 217-01025)	Mar-10
Type-N mismatch combination	SN: 5047.2 / 06327	31-Mar-09 (No. 217-01029)	Mar-10
Reference Probe ES3DV3	SN: 3205	26-Jun-09 (No. ES3-3205_Jun09)	Jun-10
DAE4	SN: 601	07-Mar-09 (No. DAE4-601_Mar09)	Mar-10
Secondary Standards	ID #	Check Date (in house)	Scheduled Check
Power sensor HP 8481A	MY41092317	18-Oct-02 (in house check Oct-07)	In house check: Oct-09
RF generator R&S SMT-06	100005	4-Aug-99 (in house check Oct-07)	In house check: Oct-09
Network Analyzer HP 8753E	US37390585 S4206	18-Oct-01 (in house check Oct-08)	In house check: Oct-09

Calibrated by: **Jeton Kastrati**      Name: **Jeton Kastrati**      Function: **Laboratory Technician**

Approved by: **Katja Pokovic**      Name: **Katja Pokovic**      Function: **Technical Manager**

Signature

Issued: September 16, 2009

This calibration certificate shall not be reproduced except in full without written approval of the laboratory.



Accredited by the Swiss Accreditation Service (SAS)  
The Swiss Accreditation Service is one of the signatories to the EA  
Multilateral Agreement for the recognition of calibration certificates

Accreditation No.: **SCS 108**

**Glossary:**

TSL	tissue simulating liquid
ConvF	sensitivity in TSL / NORM x,y,z
N/A	not applicable or not measured

**Calibration is Performed According to the Following Standards:**

- IEEE Std 1528-2003, "IEEE Recommended Practice for Determining the Peak Spatial-Averaged Specific Absorption Rate (SAR) in the Human Head from Wireless Communications Devices: Measurement Techniques", December 2003
- CENELEC EN 50361, "Basic standard for the measurement of Specific Absorption Rate related to human exposure to electromagnetic fields from mobile phones (300 MHz - 3 GHz), July 2001
- Federal Communications Commission Office of Engineering & Technology (FCC OET), "Evaluating Compliance with FCC Guidelines for Human Exposure to Radiofrequency Electromagnetic Fields; Additional Information for Evaluating Compliance of Mobile and Portable Devices with FCC Limits for Human Exposure to Radiofrequency Emissions", Supplement C (Edition 01-01) to Bulletin 65

**Additional Documentation:**

- DASY4/5 System Handbook

**Methods Applied and Interpretation of Parameters:**

- Measurement Conditions:* Further details are available from the Validation Report at the end of the certificate. All figures stated in the certificate are valid at the frequency indicated.
- Antenna Parameters with TSL:* The dipole is mounted with the spacer to position its feed point exactly below the center marking of the flat phantom section, with the arms oriented parallel to the body axis.
- Feed Point Impedance and Return Loss:* These parameters are measured with the dipole positioned under the liquid filled phantom. The impedance stated is transformed from the measurement at the SMA connector to the feed point. The Return Loss ensures low reflected power. No uncertainty required.
- Electrical Delay:* One-way delay between the SMA connector and the antenna feed point. No uncertainty required.
- SAR measured:* SAR measured at the stated antenna input power.
- SAR normalized:* SAR as measured, normalized to an input power of 1 W at the antenna connector.
- SAR for nominal TSL parameters:* The measured TSL parameters are used to calculate the nominal SAR result.

## Measurement Conditions

DASY system configuration, as far as not given on page 1.

<b>DASY Version</b>	DASY5	V5.0
<b>Extrapolation</b>	Advanced Extrapolation	
<b>Phantom</b>	Modular Flat Phantom V5.0	
<b>Distance Dipole Center - TSL</b>	10 mm	with Spacer
<b>Zoom Scan Resolution</b>	dx, dy, dz = 5 mm	
<b>Frequency</b>	1900 MHz ± 1 MHz	

## Head TSL parameters

The following parameters and calculations were applied.

	Temperature	Permittivity	Conductivity
<b>Nominal Head TSL parameters</b>	22.0 °C	40.0	1.40 mho/m
<b>Measured Head TSL parameters</b>	(22.0 ± 0.2) °C	40.8 ± 6 %	1.45 mho/m ± 6 %
<b>Head TSL temperature during test</b>	(21.5 ± 0.2) °C	----	----

## SAR result with Head TSL

<b>SAR averaged over 1 cm<sup>3</sup> (1 g) of Head TSL</b>	condition	
SAR measured	250 mW input power	10.3 mW / g
SAR normalized	normalized to 1W	41.2 mW / g
SAR for nominal Head TSL parameters <sup>1</sup>	normalized to 1W	<b>40.6 mW / g ± 17.0 % (k=2)</b>

<b>SAR averaged over 10 cm<sup>3</sup> (10 g) of Head TSL</b>	Condition	
SAR measured	250 mW input power	5.39 mW / g
SAR normalized	normalized to 1W	21.6 mW / g
SAR for nominal Head TSL parameters <sup>1</sup>	normalized to 1W	<b>21.4 mW / g ± 16.5 % (k=2)</b>

<sup>1</sup> Correction to nominal TSL parameters according to d), chapter "SAR Sensitivities"

## Body TSL parameters

The following parameters and calculations were applied.

	Temperature	Permittivity	Conductivity
<b>Nominal Body TSL parameters</b>	22.0 °C	53.3	1.52 mho/m
<b>Measured Body TSL parameters</b>	(22.0 ± 0.2) °C	53.9 ± 6 %	1.57 mho/m ± 6 %
<b>Body TSL temperature during test</b>	(22.0 ± 0.2) °C	---	---

## SAR result with Body TSL

<b>SAR averaged over 1 cm<sup>3</sup> (1 g) of Body TSL</b>	Condition	
SAR measured	250 mW input power	9.94 mW / g
SAR normalized	normalized to 1W	39.8 mW / g
SAR for nominal Body TSL parameters <sup>2</sup>	normalized to 1W	<b>39.1 mW / g ± 17.0 % (k=2)</b>

<b>SAR averaged over 10 cm<sup>3</sup> (10 g) of Body TSL</b>	condition	
SAR measured	250 mW input power	5.23 mW / g
SAR normalized	normalized to 1W	20.9 mW / g
SAR for nominal Body TSL parameters <sup>2</sup>	normalized to 1W	<b>20.8 mW / g ± 16.5 % (k=2)</b>

<sup>2</sup> Correction to nominal TSL parameters according to d), chapter "SAR Sensitivities"

## Appendix

### Antenna Parameters with Head TSL

Impedance, transformed to feed point	$50.3 \Omega + 5.9 j\Omega$
Return Loss	- 24.6 dB

### Antenna Parameters with Body TSL

Impedance, transformed to feed point	$45.2 \Omega + 5.5 j\Omega$
Return Loss	- 22.3 dB

### General Antenna Parameters and Design

Electrical Delay (one direction)	1.202 ns

After long term use with 100W radiated power, only a slight warming of the dipole near the feedpoint can be measured.

The dipole is made of standard semirigid coaxial cable. The center conductor of the feeding line is directly connected to the second arm of the dipole. The antenna is therefore short-circuited for DC-signals.

No excessive force must be applied to the dipole arms, because they might bend or the soldered connections near the feedpoint may be damaged.

### Additional EUT Data

Manufactured by	SPEAG
Manufactured on	July 29, 2002



# DASY5 Validation Report for Head TSL

Date/Time: 15.09.2009 14:19:40

Test Laboratory: SPEAG, Zurich, Switzerland

**DUT: Dipole 1900 MHz; Type: D1900V2; Serial: D1900V2 - SN:5d025**

Communication System: CW; Frequency: 1900 MHz; Duty Cycle: 1:1

Medium: HSL U11 BB

Medium parameters used:  $f = 1900$  MHz;  $\sigma = 1.45$  mho/m;  $\epsilon_r = 40.9$ ;  $\rho = 1000$  kg/m<sup>3</sup>

Phantom section: Flat Section

Measurement Standard: DASY5 (IEEE/IEC)

DASY5 Configuration:

- Probe: ES3DV3 - SN3205; ConvF(5.09, 5.09, 5.09); Calibrated: 26.06.2009
- Sensor-Surface: 3mm (Mechanical Surface Detection)
- Electronics: DAE4 Sn601; Calibrated: 07.03.2009
- Phantom: Flat Phantom 5.0 (front); Type: QD000P50AA; Serial: 1001
- Measurement SW: DASY 5, V5.0 Build 120; SEMCAD X Version 13.4 Build 45

**Pin = 250 mW; dip = 10 mm/Zoom Scan (dist=3.0 mm, probe 0deg) (7x7x7)/Cube 0:**

Measurement grid: dx=5mm, dy=5mm, dz=5mm

Reference Value = 97 V/m; Power Drift = 0.025 dB

Peak SAR (extrapolated) = 18.8 W/kg

**SAR(1 g) = 10.3 mW/g; SAR(10 g) = 5.39 mW/g**

Maximum value of SAR (measured) = 12.7 mW/g

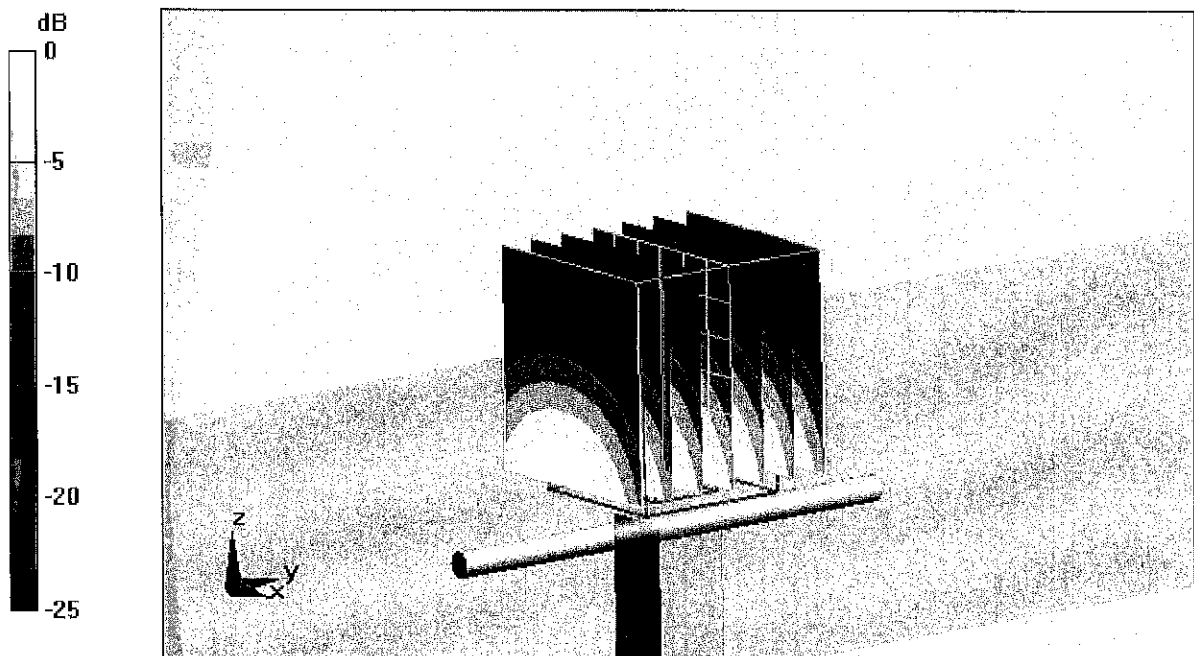

0 dB = 12.7mW/g

# Impedance Measurement Plot for Head TSL

15 Sep 2009 08:58:18

CH1 S11 1 U FS 2: 50.293  $\Omega$  5.8848  $\Omega$  492.94  $\mu\text{H}$  1 900.000 000 MHz

\*  
De1  
Cor

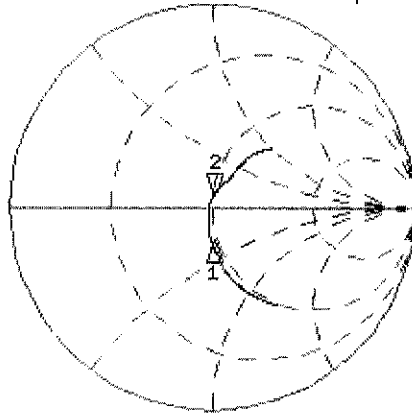

CH1 Markers  
1: 47.150  $\Omega$   
-16.793  $\Omega$   
1.80000 GHz

Avg  
16  
↑

CH2 S11 LOG 5 dB/REF -20 dB 2: -24.632 dB 1 900.000 000 MHz

Cor  
Avg  
16  
↑

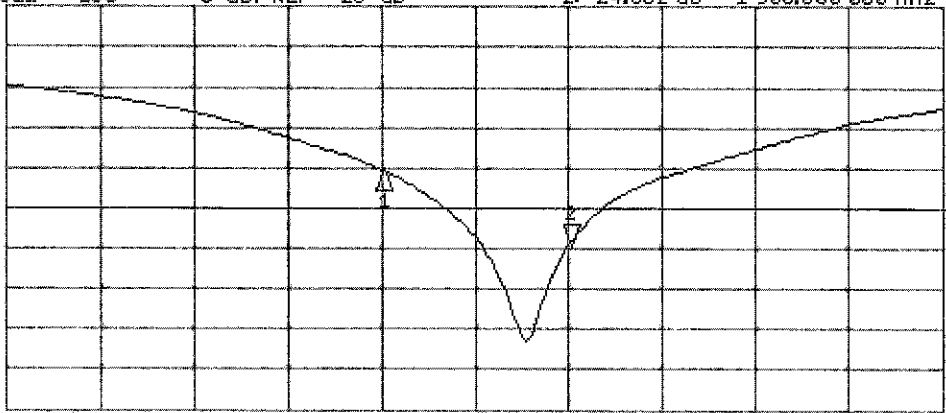

CH2 Markers  
1: -15.252 dB  
1.80000 GHz

# DASY5 Validation Report for Body TSL

Date/Time: 15.09.2009 12:45:32

Test Laboratory: SPEAG, Zurich, Switzerland

**DUT: Dipole 1900 MHz; Type: D1900V2; Serial: D1900V2 - SN:5d025**

Communication System: CW; Frequency: 1900 MHz; Duty Cycle: 1:1

Medium: MSL U10 BB

Medium parameters used:  $f = 1900$  MHz;  $\sigma = 1.57$  mho/m;  $\epsilon_r = 53.9$ ;  $\rho = 1000$  kg/m<sup>3</sup>

Phantom section: Flat Section

Measurement Standard: DASY5 (IEEE/IEC)

## DASY5 Configuration:

- Probe: ES3DV3 - SN3205; ConvF(4.59, 4.59, 4.59); Calibrated: 26.06.2009
- Sensor-Surface: 3mm (Mechanical Surface Detection)
- Electronics: DAE4 Sn601; Calibrated: 07.03.2009
- Phantom: Flat Phantom 5.0 (back); Type: QD000P50AA; Serial: 1001
- Measurement SW: DASY 5, V5.0 Build 120; SEMCAD X Version 13.4 Build 45

**Pin = 250 mW; dip = 10 mm/Zoom Scan (dist=3.0mm, probe 0deg) (7x7x7)/Cube 0:**

Measurement grid: dx=5mm, dy=5mm, dz=5mm

Reference Value = 94.1 V/m; Power Drift = 0.00862 dB

Peak SAR (extrapolated) = 16.9 W/kg

**SAR(1 g) = 9.94 mW/g; SAR(10 g) = 5.23 mW/g**

Maximum value of SAR (measured) = 12.5 mW/g

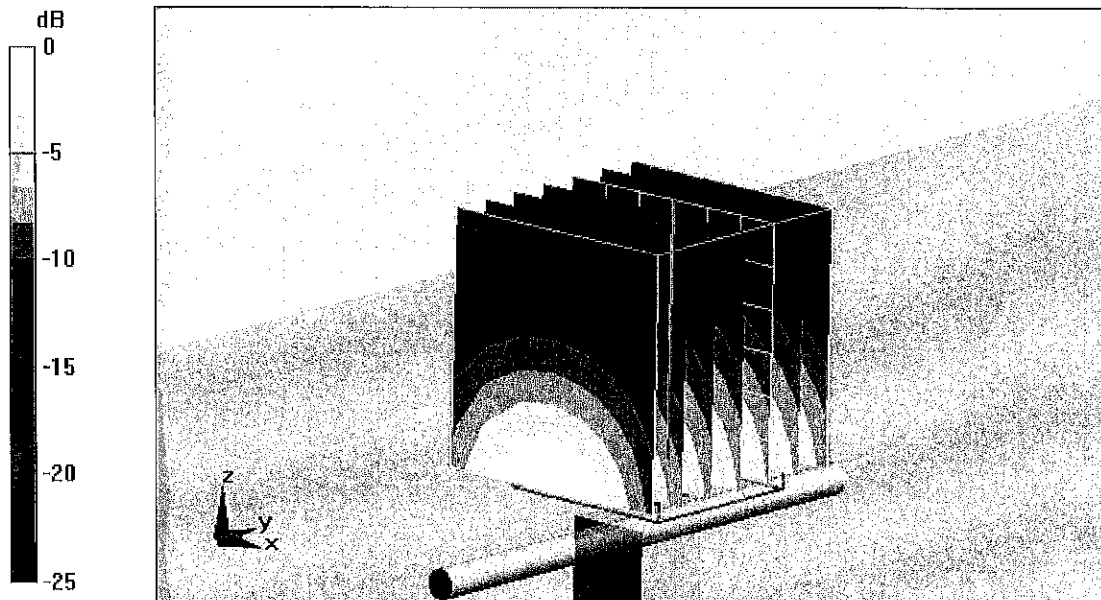

0 dB = 12.5mW/g

# Impedance Measurement Plot for Body TSL

15 Sep 2009 08:58:41

CH1 S11 1 U FS 2: 45.225  $\Omega$  5.5215  $\Omega$  462.51  $\mu$ H 1 900.000 000 MHz

\*  
De1  
Cor  
Avg  
16

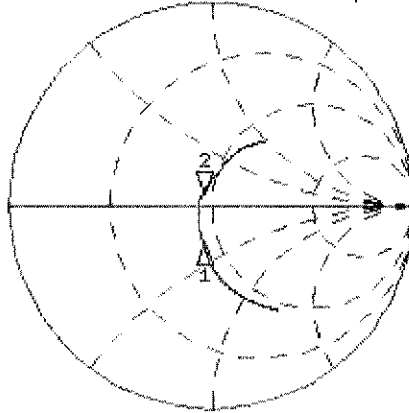

CH1 Markers  
1: 42.797  $\Omega$   
-15.688  $\Omega$   
1.80000 GHz

CH2 S11 LOG 5 dB/REF -20 dB 2: -22.325 dB 1 900.000 000 MHz

Cor  
Avg  
16

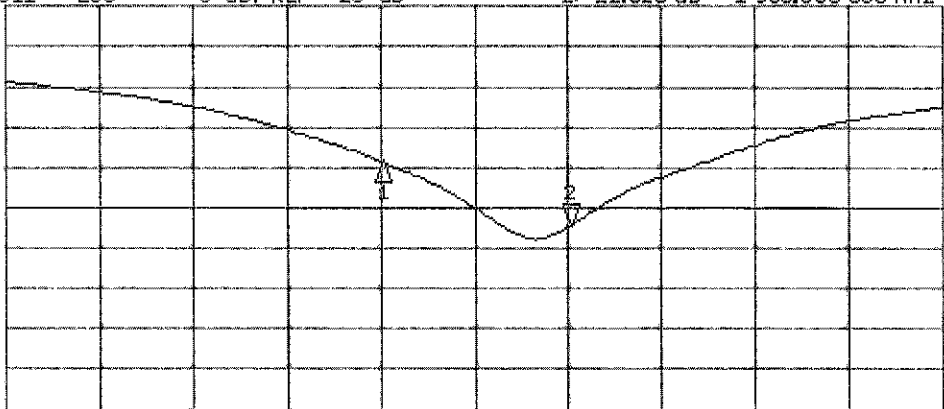

CH2 Markers  
1: -14.299 dB  
1.80000 GHz

START 1 600.000 000 MHz

STOP 2 100.000 000 MHz



Accredited by the Swiss Accreditation Service (SAS)  
The Swiss Accreditation Service is one of the signatories to the EA  
Multilateral Agreement for the recognition of calibration certificates

Accreditation No.: **SCS 108**

Client **Eurofins**

Certificate No: **D2450V2-722\_Sep09**

## CALIBRATION CERTIFICATE

Object **D2450V2 - SN: 722**

Calibration procedure(s) **QA CAL-05.v7**  
**Calibration procedure for dipole validation kits**

Calibration date: **September 15, 2009**

Condition of the calibrated item **In Tolerance**

This calibration certificate documents the traceability to national standards, which realize the physical units of measurements (SI).  
The measurements and the uncertainties with confidence probability are given on the following pages and are part of the certificate.

All calibrations have been conducted in the closed laboratory facility: environment temperature ( $22 \pm 3$ )°C and humidity < 70%.

Calibration Equipment used (M&TE critical for calibration)



Primary Standards	ID #	Cal Date (Calibrated by, Certificate No.)	Scheduled Calibration
Power meter EPM-442A	GB37480704	08-Oct-08 (No. 217-00898)	Oct-09
Power sensor HP 8481A	US37292783	08-Oct-08 (No. 217-00898)	Oct-09
Reference 20 dB Attenuator	SN: 5086 (20g)	31-Mar-09 (No. 217-01025)	Mar-10
Type-N mismatch combination	SN: 5047.2 / 06327	31-Mar-09 (No. 217-01029)	Mar-10
Reference Probe ES3DV3	SN: 3205	26-Jun-09 (No. ES3-3205_Jun09)	Jun-10
DAE4	SN: 601	07-Mar-09 (No. DAE4-601_Mar09)	Mar-10

Secondary Standards	ID #	Check Date (in house)	Scheduled Check
Power sensor HP 8481A	MY41092317	18-Oct-02 (in house check Oct-07)	In house check: Oct-09
RF generator R&S SMT-06	100005	4-Aug-99 (in house check Oct-07)	In house check: Oct-09
Network Analyzer HP 8753E	US37390585 S4206	18-Oct-01 (in house check Oct-08)	In house check: Oct-09

Calibrated by: **Jeton Kastrati**      Name: **Jeton Kastrati**      Function: **Laboratory Technician**

Approved by: **Katja Pokovic**      Name: **Katja Pokovic**      Function: **Technical Manager**

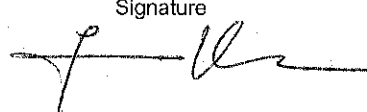
Signature

Issued: September 16, 2009

This calibration certificate shall not be reproduced except in full without written approval of the laboratory.



Accredited by the Swiss Accreditation Service (SAS)  
The Swiss Accreditation Service is one of the signatories to the EA  
Multilateral Agreement for the recognition of calibration certificates

Accreditation No.: **SCS 108**

### Glossary:

TSL	tissue simulating liquid
ConvF	sensitivity in TSL / NORM x,y,z
N/A	not applicable or not measured

### Calibration is Performed According to the Following Standards:

- IEEE Std 1528-2003, "IEEE Recommended Practice for Determining the Peak Spatial-Averaged Specific Absorption Rate (SAR) in the Human Head from Wireless Communications Devices: Measurement Techniques", December 2003
- IEC 62209-1, "Procedure to measure the Specific Absorption Rate (SAR) for hand-held devices used in close proximity to the ear (frequency range of 300 MHz to 3 GHz)", February 2005
- Federal Communications Commission Office of Engineering & Technology (FCC OET), "Evaluating Compliance with FCC Guidelines for Human Exposure to Radiofrequency Electromagnetic Fields; Additional Information for Evaluating Compliance of Mobile and Portable Devices with FCC Limits for Human Exposure to Radiofrequency Emissions", Supplement C (Edition 01-01) to Bulletin 65

### Additional Documentation:

- DASY4/5 System Handbook

### Methods Applied and Interpretation of Parameters:

- Measurement Conditions:** Further details are available from the Validation Report at the end of the certificate. All figures stated in the certificate are valid at the frequency indicated.
- Antenna Parameters with TSL:** The dipole is mounted with the spacer to position its feed point exactly below the center marking of the flat phantom section, with the arms oriented parallel to the body axis.
- Feed Point Impedance and Return Loss:** These parameters are measured with the dipole positioned under the liquid filled phantom. The impedance stated is transformed from the measurement at the SMA connector to the feed point. The Return Loss ensures low reflected power. No uncertainty required.
- Electrical Delay:** One-way delay between the SMA connector and the antenna feed point. No uncertainty required.
- SAR measured:** SAR measured at the stated antenna input power.
- SAR normalized:** SAR as measured, normalized to an input power of 1 W at the antenna connector.
- SAR for nominal TSL parameters:** The measured TSL parameters are used to calculate the nominal SAR result.

## Measurement Conditions

DASY system configuration, as far as not given on page 1.

<b>DASY Version</b>	DASY5	V5.0
<b>Extrapolation</b>	Advanced Extrapolation	
<b>Phantom</b>	Modular Flat Phantom V5.0	
<b>Distance Dipole Center - TSL</b>	10 mm	with Spacer
<b>Zoom Scan Resolution</b>	dx, dy, dz = 5 mm	
<b>Frequency</b>	2450 MHz ± 1 MHz	

## Head TSL parameters

The following parameters and calculations were applied.

	Temperature	Permittivity	Conductivity
<b>Nominal Head TSL parameters</b>	22.0 °C	39.2	1.80 mho/m
<b>Measured Head TSL parameters</b>	(22.0 ± 0.2) °C	40.1 ± 6 %	1.80 mho/m ± 6 %
<b>Head TSL temperature during test</b>	(22.0 ± 0.2) °C	----	----

## SAR result with Head TSL

<b>SAR averaged over 1 cm<sup>3</sup> (1 g) of Head TSL</b>	Condition	
SAR measured	250 mW input power	13.6 mW / g
SAR normalized	normalized to 1W	54.4 mW / g
SAR for nominal Head TSL parameters <sup>1</sup>	normalized to 1W	<b>54.7 mW / g ± 17.0 % (k=2)</b>

<b>SAR averaged over 10 cm<sup>3</sup> (10 g) of Head TSL</b>	condition	
SAR measured	250 mW input power	6.37 mW / g
SAR normalized	normalized to 1W	25.5 mW / g
SAR for nominal Head TSL parameters <sup>1</sup>	normalized to 1W	<b>25.6 mW / g ± 16.5 % (k=2)</b>

<sup>1</sup> Correction to nominal TSL parameters according to d), chapter "SAR Sensitivities"

## Body TSL parameters

The following parameters and calculations were applied.

	Temperature	Permittivity	Conductivity
Nominal Body TSL parameters	22.0 °C	52.7	1.95 mho/m
Measured Body TSL parameters	(22.0 ± 0.2) °C	53.2 ± 6 %	2.01 mho/m ± 6 %
Body TSL temperature during test	(22.0 ± 0.2) °C	----	----

## SAR result with Body TSL

SAR averaged over 1 cm <sup>3</sup> (1 g) of Body TSL	Condition	
SAR measured	250 mW input power	13.2 mW / g
SAR normalized	normalized to 1W	52.8 mW / g
SAR for nominal Body TSL parameters <sup>2</sup>	normalized to 1W	<b>52.1 mW /g ± 17.0 % (k=2)</b>

SAR averaged over 10 cm <sup>3</sup> (10 g) of Body TSL	condition	
SAR measured	250 mW input power	6.08 mW / g
SAR normalized	normalized to 1W	24.3 mW / g
SAR for nominal Body TSL parameters <sup>2</sup>	normalized to 1W	<b>24.2 mW /g ± 16.5 % (k=2)</b>

<sup>2</sup> Correction to nominal TSL parameters according to d), chapter "SAR Sensitivities"



## Appendix

### Antenna Parameters with Head TSL

Impedance, transformed to feed point	$52.0 \Omega + 6.9 j\Omega$
Return Loss	- 23.1 dB

### Antenna Parameters with Body TSL

Impedance, transformed to feed point	$46.7 \Omega + 9.1 j\Omega$
Return Loss	- 20.0 dB

### General Antenna Parameters and Design

Electrical Delay (one direction)	1.152 ns
----------------------------------	----------

After long term use with 100W radiated power, only a slight warming of the dipole near the feedpoint can be measured.

The dipole is made of standard semirigid coaxial cable. The center conductor of the feeding line is directly connected to the second arm of the dipole. The antenna is therefore short-circuited for DC-signals.

No excessive force must be applied to the dipole arms, because they might bend or the soldered connections near the feedpoint may be damaged.

### Additional EUT Data

Manufactured by	SPEAG
Manufactured on	October 16, 2002

## DASY5 Validation Report for Head TSL

Date/Time: 15.09.2009 15:14:17

Test Laboratory: SPEAG, Zurich, Switzerland

**DUT: Dipole 2450 MHz; Type: D2450V2; Serial: D2450V2 - SN722**

Communication System: CW; Frequency: 2450 MHz; Duty Cycle: 1:1

Medium: HSL U11 BB

Medium parameters used:  $f = 2450$  MHz;  $\sigma = 1.8$  mho/m;  $\epsilon_r = 40.1$ ;  $\rho = 1000$  kg/m<sup>3</sup>

Phantom section: Flat Section

Measurement Standard: DASY5 (IEEE/IEC)

DASY5 Configuration:

- Probe: ES3DV3 - SN3205; ConvF(4.53, 4.53, 4.53); Calibrated: 26.06.2009
- Sensor-Surface: 3mm (Mechanical Surface Detection)
- Electronics: DAE4 Sn601; Calibrated: 07.03.2009
- Phantom: Flat Phantom 5.0 (front); Type: QD000P50AA; Serial: 1001
- Measurement SW: DASY5, V5.0 Build 120; SEMCAD X Version 13.4 Build 45

**Pin = 250 mW; d = 10 mm/Zoom Scan (7x7x7)/Cube 0:** Measurement grid: dx=5mm, dy=5mm, dz=5mm

Reference Value = 102.0 V/m; Power Drift = 0.032 dB

Peak SAR (extrapolated) = 27.8 W/kg

**SAR(1 g) = 13.6 mW/g; SAR(10 g) = 6.37 mW/g**

Maximum value of SAR (measured) = 17.5 mW/g

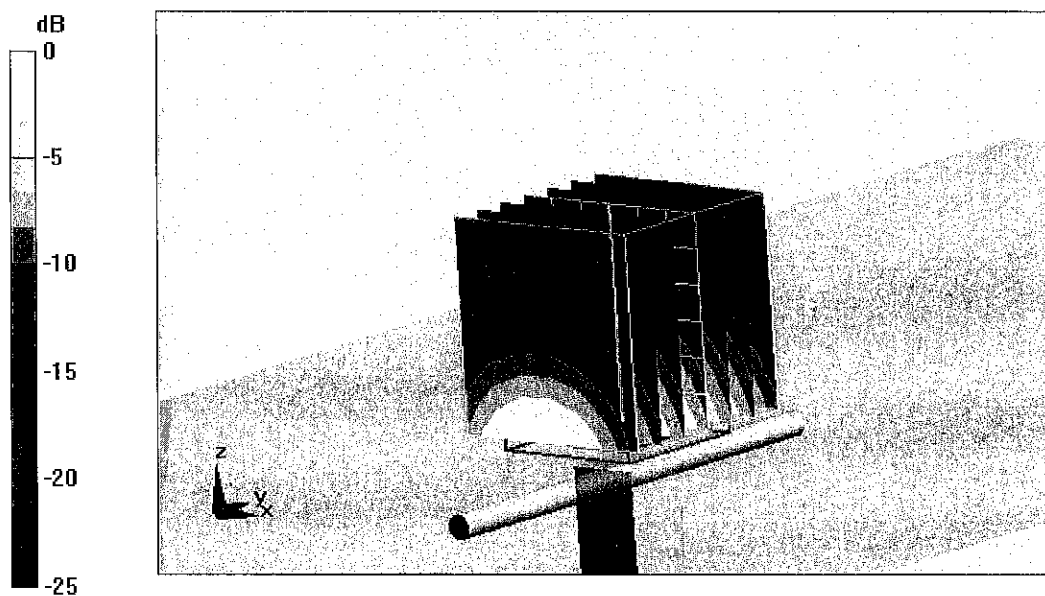

0 dB = 17.5mW/g

# Impedance Measurement Plot for Head TSL

15 Sep 2009 14:21:38

CH1 S11 1 U FS 1: 52.020  $\Omega$  6.8965  $\Omega$  448.00 pF 2 450.000 000 MHz

\*  
Del  
Cor

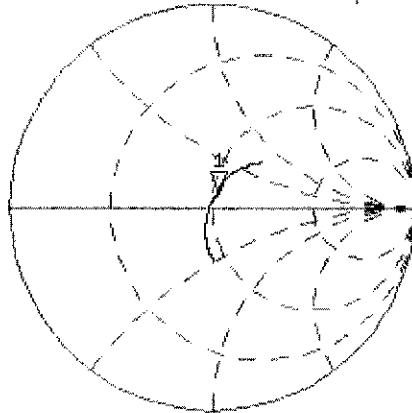

Avg  
15

↑

CH2 S11 LOG 5 dB/REF -20 dB 1:-23.055 dB 2 450.000 000 MHz

Cor

Avg  
16

↑

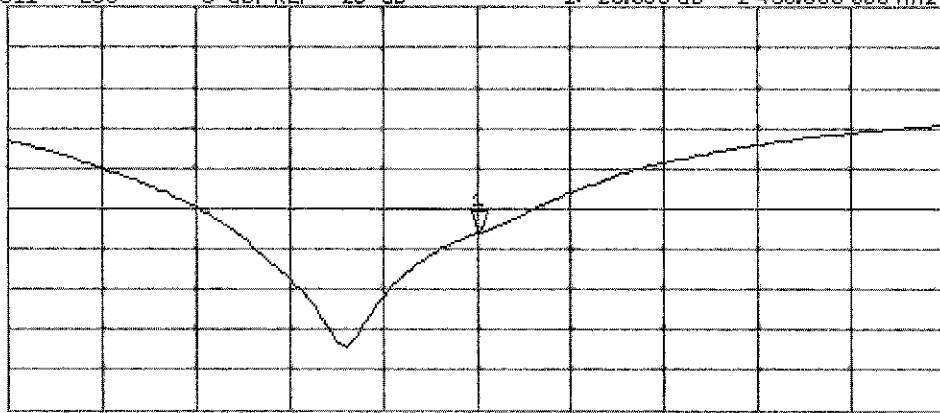

START 2 250.000 000 MHz

STOP 2 650.000 000 MHz

## DASY5 Validation Report for Body TSL

Date/Time: 15.09.2009 16:00:06

Test Laboratory: SPEAG, Zurich, Switzerland

**DUT: Dipole 2450 MHz; Type: D2450V2; Serial: D2450V2 - SN:722**

Communication System: CW; Frequency: 2450 MHz; Duty Cycle: 1:1

Medium: MSL U10 BB

Medium parameters used:  $f = 2450$  MHz;  $\sigma = 2.01$  mho/m;  $\epsilon_r = 53.2$ ;  $\rho = 1000$  kg/m<sup>3</sup>

Phantom section: Flat Section

Measurement Standard: DASY5 (IEEE/IEC)

DASY5 Configuration:

- Probe: ES3DV3 - SN3205; ConvF(4.31, 4.31, 4.31); Calibrated: 26.06.2009
- Sensor-Surface: 3mm (Mechanical Surface Detection)
- Electronics: DAE4 Sn601; Calibrated: 07.03.2009
- Phantom: Flat Phantom 5.0 (back); Type: QD000P50AA; Serial: 1002
- Measurement SW: DASY5, V5.0 Build 120; SEMCAD X Version 13.4 Build 45

**Pin = 250 mW; d = 10 mm/Zoom Scan (7x7x7)/Cube 0:** Measurement grid: dx=5mm, dy=5mm, dz=5mm

Reference Value = 95.7 V/m; Power Drift = -0.013 dB

Peak SAR (extrapolated) = 27.5 W/kg

**SAR(1 g) = 13.2 mW/g; SAR(10 g) = 6.08 mW/g**

Maximum value of SAR (measured) = 17.3 mW/g

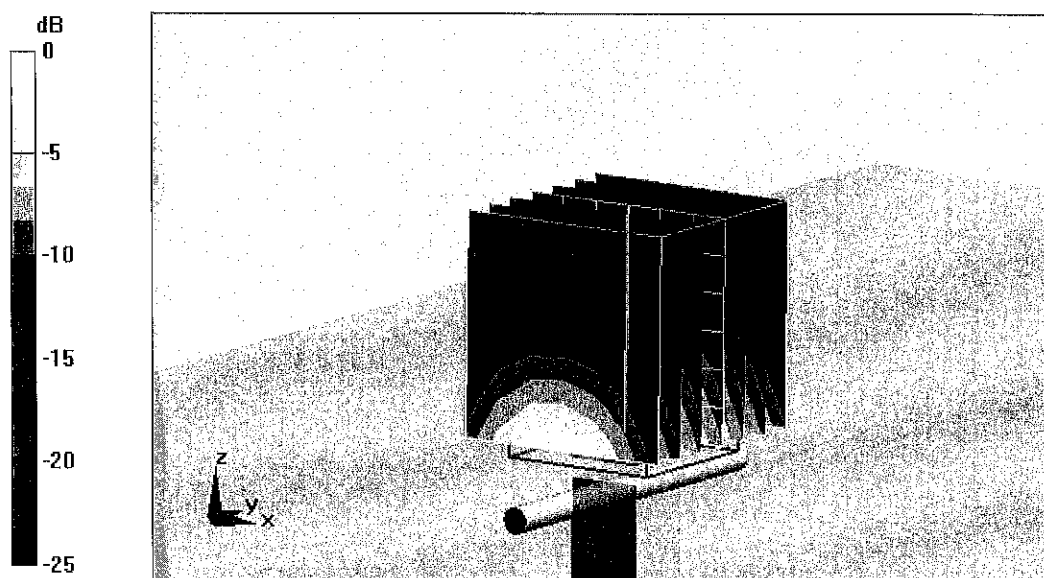

0 dB = 17.3mW/g

# Impedance Measurement Plot for Body TSL

15 Sep 2009 14:22:07

CH1 S11 1 U FS 1: 46.695  $\Omega$  9.0879  $\Omega$  590.36 pF 2 450.000 000 MHz

\*  
Del  
Cor

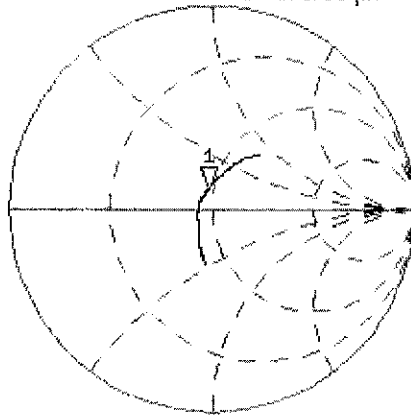

Avg  
16

↑

CH2 S11 LOG 5 dB/REF -20 dB 1: -20.039 dB 2 450.000 000 MHz

Cor

Avg  
16

↑

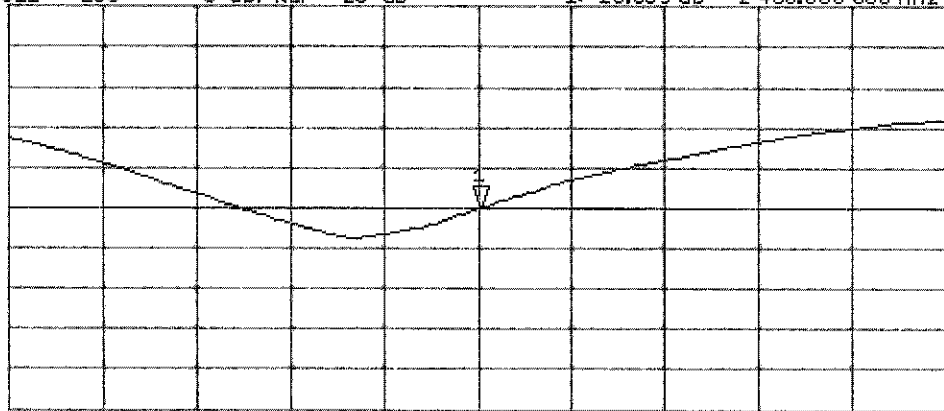

START 2 250.000 000 MHz

STOP 2 650.000 000 MHz



Accredited by the Swiss Accreditation Service (SAS)  
The Swiss Accreditation Service is one of the signatories to the EA  
Multilateral Agreement for the recognition of calibration certificates

Accreditation No.: **SCS 108**

Client **Eurofins**

Certificate No: **DAE3-522\_Sep10**

**CALIBRATION CERTIFICATE**

Object **DAE3 - SD 000 D03 AA - SN 522**

Calibration procedure(s) **QA CAL-06 v22  
Calibration procedure for the data acquisition electronics (DAE)**

Calibration date: **September 20, 2010**

This calibration certificate documents the traceability to national standards, which realize the physical units of measurements (SI).  
The measurements and the uncertainties with confidence probability are given on the following pages and are part of the certificate.

All calibrations have been conducted in the closed laboratory facility: environment temperature (22 ± 3)°C and humidity < 70%.

Calibration Equipment used (M&TE critical for calibration)

Primary Standards	ID #	Cal Date (Certificate No.)	Scheduled Calibration
Keithley Multimeter Type 2001	SN: 0810278	1-Oct-09 (No: 9055)	Oct-10
Secondary Standards	ID #	Check Date (in house)	Scheduled Check
Calibrator Box V1.1	SE UMS 006 AB 1004	07-Jun-10 (in house check)	In house check: Jun-11

	Name	Function	Signature
Calibrated by:	Dominique Steffen	Technician	
Approved by:	Flm Bombolt	R&D Director	

Issued: September 20, 2010

This calibration certificate shall not be reproduced except in full without written approval of the laboratory.



Accredited by the Swiss Accreditation Service (SAS)  
The Swiss Accreditation Service is one of the signatories to the EA  
Multilateral Agreement for the recognition of calibration certificates

## Glossary

DAE data acquisition electronics  
Connector angle information used in DASY system to align probe sensor X to the robot coordinate system.

## Methods Applied and Interpretation of Parameters

- *DC Voltage Measurement:* Calibration Factor assessed for use in DASY system by comparison with a calibrated instrument traceable to national standards. The figure given corresponds to the full scale range of the voltmeter in the respective range.
- *Connector angle:* The angle of the connector is assessed measuring the angle mechanically by a tool inserted. Uncertainty is not required.
- The following parameters as documented in the Appendix contain technical information as a result from the performance test and require no uncertainty.
  - *DC Voltage Measurement Linearity:* Verification of the Linearity at +10% and -10% of the nominal calibration voltage. Influence of offset voltage is included in this measurement.
  - *Common mode sensitivity:* Influence of a positive or negative common mode voltage on the differential measurement.
  - *Channel separation:* Influence of a voltage on the neighbor channels not subject to an input voltage.
  - *AD Converter Values with inputs shorted:* Values on the internal AD converter corresponding to zero input voltage
  - *Input Offset Measurement:* Output voltage and statistical results over a large number of zero voltage measurements.
  - *Input Offset Current:* Typical value for information; Maximum channel input offset current, not considering the input resistance.
  - *Input resistance:* Typical value for information: DAE input resistance at the connector, during internal auto-zeroing and during measurement.
  - *Low Battery Alarm Voltage:* Typical value for information. Below this voltage, a battery alarm signal is generated.
  - *Power consumption:* Typical value for information. Supply currents in various operating modes.

## DC Voltage Measurement

A/D - Converter Resolution nominal

High Range: 1LSB = 6.1 $\mu$ V, full range = -100...+300 mV

Low Range: 1LSB = 61nV, full range = -1.....+3mV

DASY measurement parameters: Auto Zero Time: 3 sec; Measuring time: 3 sec

Calibration Factors	X	Y	Z
High Range	404.261 $\pm$ 0.1% (k=2)	403.925 $\pm$ 0.1% (k=2)	404.752 $\pm$ 0.1% (k=2)
Low Range	3.96700 $\pm$ 0.7% (k=2)	3.95919 $\pm$ 0.7% (k=2)	3.97458 $\pm$ 0.7% (k=2)

## Connector Angle

Connector Angle to be used in DASY system	58.5 $^{\circ}$ $\pm$ 1 $^{\circ}$
---	------------------------------------



## Appendix

### 1. DC Voltage Linearity

High Range	Reading ( $\mu\text{V}$ )	Difference ( $\mu\text{V}$ )	Error (%)
Channel X + Input	200004.1	1.35	0.00
Channel X + Input	20000.26	0.86	0.00
Channel X - Input	-19994.81	5.59	-0.03
Channel Y + Input	199992.1	-0.20	-0.00
Channel Y + Input	20002.06	1.96	0.01
Channel Y - Input	-19998.16	1.94	-0.01
Channel Z + Input	200003.1	2.12	0.00
Channel Z + Input	19998.40	-1.50	-0.01
Channel Z - Input	-19999.91	0.29	-0.00

Low Range	Reading ( $\mu\text{V}$ )	Difference ( $\mu\text{V}$ )	Error (%)
Channel X + Input	2000.2	0.19	0.01
Channel X + Input	201.04	1.04	0.52
Channel X - Input	-201.29	-1.29	0.64
Channel Y + Input	2000.6	0.49	0.02
Channel Y + Input	199.39	-0.51	-0.26
Channel Y - Input	-201.40	-1.60	0.80
Channel Z + Input	2000.5	0.73	0.04
Channel Z + Input	198.64	-1.66	-0.83
Channel Z - Input	-201.22	-1.12	0.56

### 2. Common mode sensitivity

DASY measurement parameters: Auto Zero Time: 3 sec; Measuring time: 3 sec

	Common mode Input Voltage (mV)	High Range Average Reading ( $\mu\text{V}$ )	Low Range Average Reading ( $\mu\text{V}$ )
Channel X	200	-4.17	-5.74
	- 200	7.33	5.67
Channel Y	200	-0.78	-1.07
	- 200	-0.05	-0.27
Channel Z	200	16.53	16.33
	- 200	-17.70	-17.88

### 3. Channel separation

DASY measurement parameters: Auto Zero Time: 3 sec; Measuring time: 3 sec

	Input Voltage (mV)	Channel X ( $\mu\text{V}$ )	Channel Y ( $\mu\text{V}$ )	Channel Z ( $\mu\text{V}$ )
Channel X	200	-	1.87	-0.02
Channel Y	200	1.47	-	2.49
Channel Z	200	0.96	-0.39	-

#### 4. AD-Converter Values with inputs shorted

DASY measurement parameters: Auto Zero Time: 3 sec; Measuring time: 3 sec

	High Range (LSB)	Low Range (LSB)
Channel X	15731	15714
Channel Y	15726	15841
Channel Z	16061	16791

#### 5. Input Offset Measurement

DASY measurement parameters: Auto Zero Time: 3 sec; Measuring time: 3 sec

Input 10M $\Omega$

	Average ( $\mu$ V)	min. Offset ( $\mu$ V)	max. Offset ( $\mu$ V)	Std. Deviation ( $\mu$ V)
Channel X	0.59	-1.57	2.61	0.66
Channel Y	-1.07	-2.64	0.60	0.58
Channel Z	-0.07	-1.88	1.68	0.57

#### 6. Input Offset Current

Nominal Input circuitry offset current on all channels: <25fA

#### 7. Input Resistance (Typical values for information)

	Zeroing (kOhm)	Measuring (MOhm)
Channel X	200	200
Channel Y	200	200
Channel Z	200	200

#### 8. Low Battery Alarm Voltage (Typical values for information)

Typical values	Alarm Level (VDC)
Supply (+ Vcc)	+7.9
Supply (- Vcc)	-7.6

#### 9. Power Consumption (Typical values for information)

Typical values	Switched off (mA)	Stand by (mA)	Transmitting (mA)
Supply (+ Vcc)	+0.01	+6	+14
Supply (- Vcc)	-0.01	-8	-9



Accredited by the Swiss Accreditation Service (SAS)  
The Swiss Accreditation Service is one of the signatories to the EA  
Multilateral Agreement for the recognition of calibration certificates

Accreditation No.: **SCS 108**

Client **Eurofins**

Certificate No: **ER3-2299\_Sep10**

## CALIBRATION CERTIFICATE

Object **ER3DV6 - SN:2299**

Calibration procedure(s) **QA CAL-02.v5 and QA CAL-25.v2  
Calibration procedure for E-field probes optimized for close near field  
evaluations in air**

Calibration date: **September 20, 2010**

This calibration certificate documents the traceability to national standards, which realize the physical units of measurements (SI).  
The measurements and the uncertainties with confidence probability are given on the following pages and are part of the certificate.

All calibrations have been conducted in the closed laboratory facility: environment temperature  $(22 \pm 3)^\circ\text{C}$  and humidity  $< 70\%$ .

Calibration Equipment used (M&TE critical for calibration)

Primary Standards	ID #	Cal Date (Certificate No.)	Scheduled Calibration
Power meter E4419B	GB41293874	1-Apr-10 (No. 217-01136)	Apr-11
Power sensor E4412A	MY41495277	1-Apr-10 (No. 217-01136)	Apr-11
Power sensor E4412A	MY41498087	1-Apr-10 (No. 217-01136)	Apr-11
Reference 3 dB Attenuator	SN: S5054 (3c)	30-Mar-10 (No. 217-01159)	Mar-11
Reference 20 dB Attenuator	SN: S5086 (20b)	30-Mar-10 (No. 217-01161)	Mar-11
Reference 30 dB Attenuator	SN: S5129 (30b)	30-Mar-10 (No. 217-01160)	Mar-11
Reference Probe ER3DV6	SN: 2328	3-Oct-09 (No. ER3-2328_Oct09)	Oct-10
DAE4	SN: 789	31-Aug-10 (No. DAE4-789_Aug10)	Aug-11
Secondary Standards	ID #	Check Date (in house)	Scheduled Check
RF generator HP 8648C	US3642U01700	4-Aug-99 (in house check Oct-09)	In house check: Oct-11
Network Analyzer HP 8753E	US37390585	18-Oct-01 (in house check Oct-09)	In house check: Oct10

	Name	Function	Signature
Calibrated by:	Katja Pokovic	Technical Manager	
Approved by:	Fin Bomholt	R&D Director	

Issued: September 20, 2010

This calibration certificate shall not be reproduced except in full without written approval of the laboratory.



Accredited by the Swiss Accreditation Service (SAS)

Accreditation No.: **SCS 108**

The Swiss Accreditation Service is one of the signatories to the EA  
Multilateral Agreement for the recognition of calibration certificates

**Glossary:**

NORM <sub>x,y,z</sub>	sensitivity in free space
DCP	diode compression point
CF	crest factor (1/duty_cycle) of the RF signal
A, B, C	modulation dependent linearization parameters
Polarization $\phi$	$\phi$ rotation around probe axis
Polarization $\vartheta$	$\vartheta$ rotation around an axis that is in the plane normal to probe axis (at measurement center), i.e., $\vartheta = 0$ is normal to probe axis
Connector Angle	information used in DASY system to align probe sensor X to the robot coordinate system

**Calibration is Performed According to the Following Standards:**

- a) IEEE Std 1309-2005, " IEEE Standard for calibration of electromagnetic field sensors and probes, excluding antennas, from 9 kHz to 40 GHz", December 2005.

**Methods Applied and Interpretation of Parameters:**

- *NORM<sub>x,y,z</sub>*: Assessed for E-field polarization  $\vartheta = 0$  for XY sensors and  $\vartheta = 90$  for Z sensor ( $f \leq 900$  MHz in TEM-cell;  $f > 1800$  MHz: R22 waveguide).
- *NORM(f)<sub>x,y,z</sub>* = *NORM<sub>x,y,z</sub>* \* *frequency\_response* (see Frequency Response Chart).
- *DCP<sub>x,y,z</sub>*: DCP are numerical linearization parameters assessed based on the data of power sweep with CW signal (no uncertainty required). DCP does not depend on frequency nor media.
- *A<sub>x,y,z</sub>; B<sub>x,y,z</sub>; C<sub>x,y,z</sub>, VR<sub>x,y,z</sub>*: *A, B, C* are numerical linearization parameters assessed based on the data of power sweep for specific modulation signal. The parameters do not depend on frequency nor media. *VR* is the maximum calibration range expressed in RMS voltage across the diode.
- *Spherical isotropy (3D deviation from isotropy)*: in a locally homogeneous field realized using an open waveguide setup.
- *Sensor Offset*: The sensor offset corresponds to the offset of virtual measurement center from the probe tip (on probe axis). No tolerance required.
- *Connector Angle*: The angle is assessed using the information gained by determining the *NORM<sub>x</sub>* (no uncertainty required).

# Probe ER3DV6

## SN:2299

Manufactured:	November 6, 2002
Last calibrated:	September 11, 2009
Recalibrated:	September 20, 2010

Calibrated for DASY/EASY Systems

(Note: non-compatible with DASY2 system!)

**DASY/EASY - Parameters of Probe: ER3DV6 SN:2299****Basic Calibration Parameters**

	Sensor X	Sensor Y	Sensor Z	Unc (k=2)
Norm ( $\mu\text{V}/(\text{V}/\text{m})^2$ )	1.06	1.21	1.46	$\pm 10.1\%$
DCP (mV) <sup>A</sup>	93.3	93.6	98.4	

**Modulation Calibration Parameters**

UID	Communication System Name	PAR		A dB	B dBuV	C	VR mV	Unc <sup>E</sup> (k=2)
10000	CW	0.00	X	0.00	0.00	1.00	300	$\pm 1.5\%$
			Y	0.00	0.00	1.00	300	
			Z	0.00	0.00	1.00	300	

The reported uncertainty of measurement is stated as the standard uncertainty of measurement multiplied by the coverage factor k=2, which for a normal distribution corresponds to a coverage probability of approximately 95%.

<sup>A</sup> numerical linearization parameter; uncertainty not required

<sup>E</sup> Uncertainty is determined using the maximum deviation from linear response applying recatangular distribution and is expressed for the square of the field value.

# Frequency Response of E-Field

(TEM-Cell:ifi110 EXX, Waveguide R22)

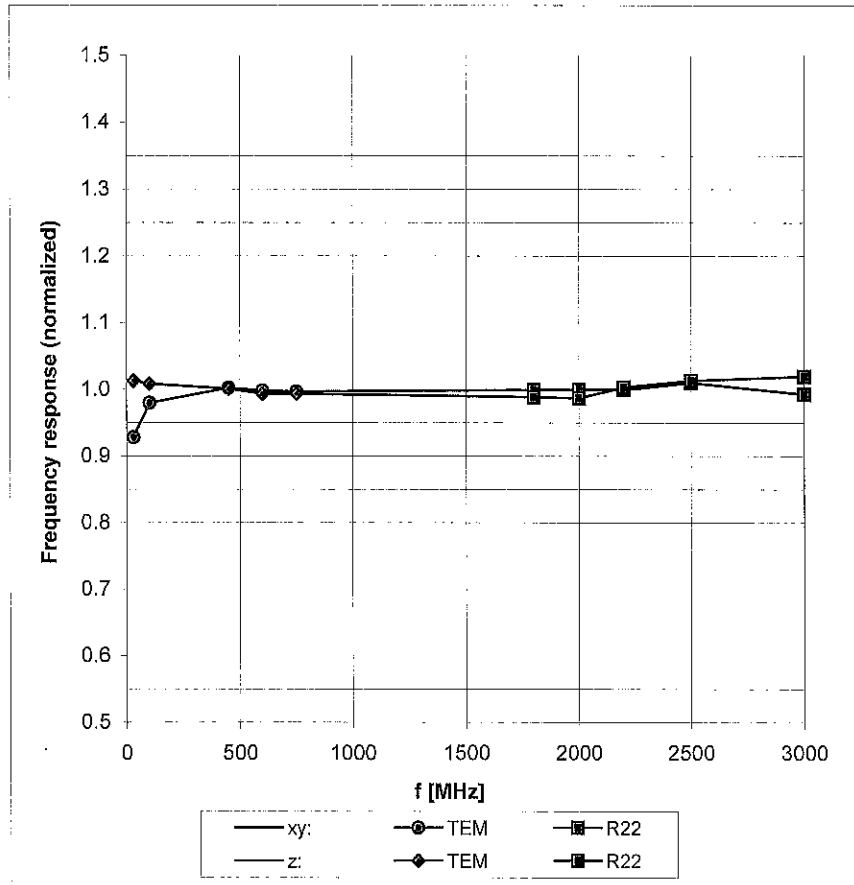

Uncertainty of Frequency Response of E-field:  $\pm 6.3\%$  (k=2)

### Receiving Pattern ( $\phi$ ), $\vartheta = 0^\circ$

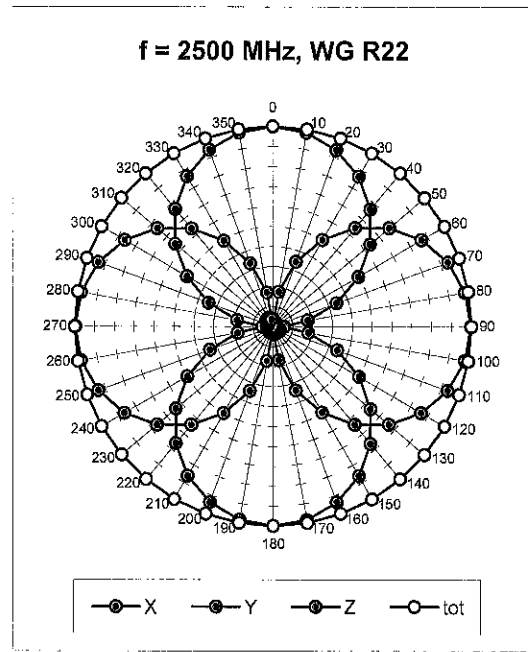
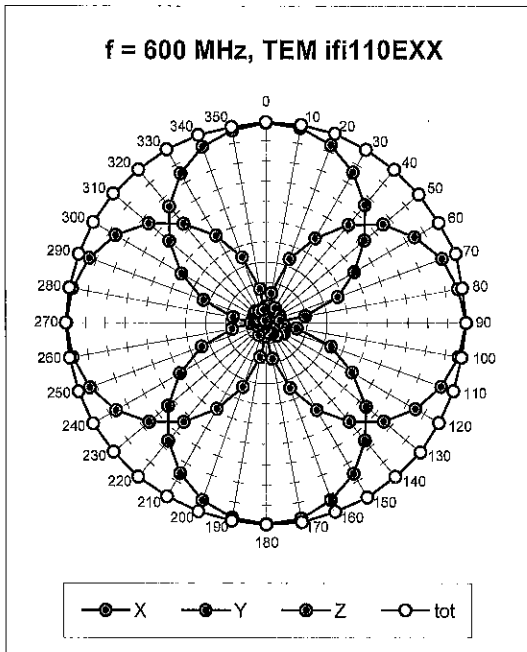

### Receiving Pattern ( $\phi$ ), $\vartheta = 90^\circ$

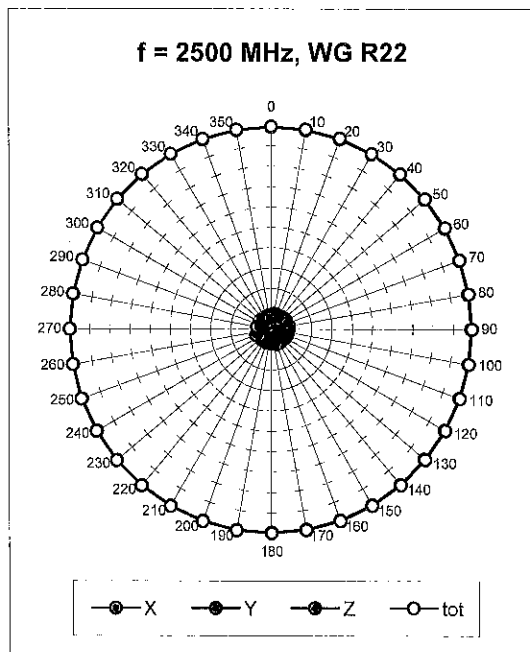
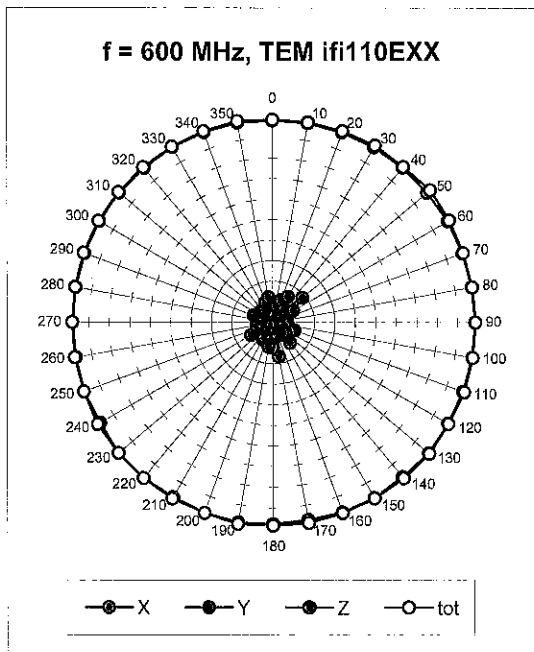



### Receiving Pattern ( $\phi$ ), $\vartheta = 0^\circ$

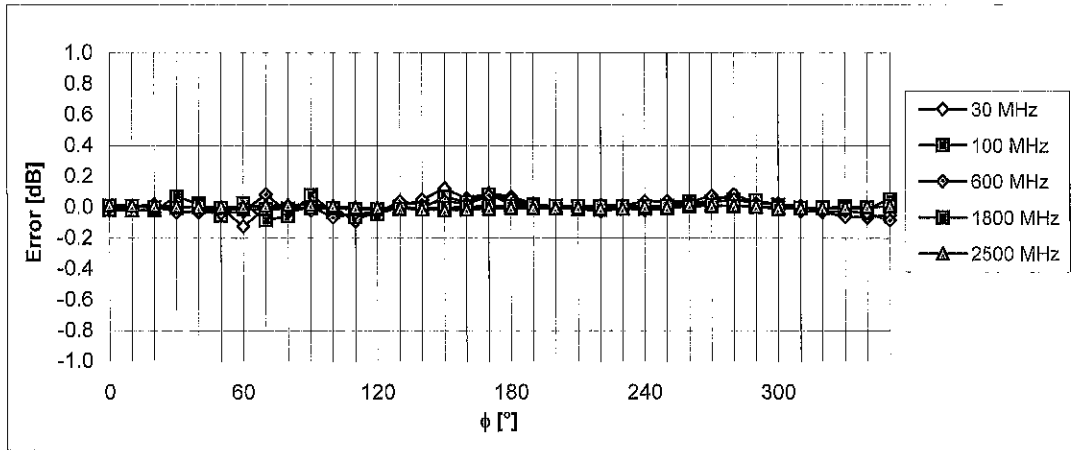

Uncertainty of Axial Isotropy Assessment:  $\pm 0.5\%$  ( $k=2$ )

### Receiving Pattern ( $\phi$ ), $\vartheta = 90^\circ$

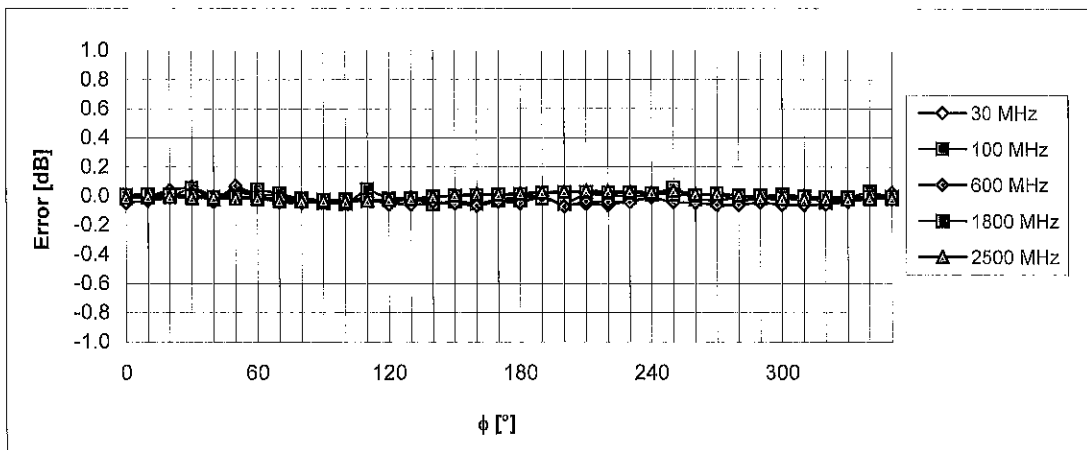

Uncertainty of Axial Isotropy Assessment:  $\pm 0.5\%$  ( $k=2$ )

### Dynamic Range f(E-field) (Waveguide R22, f = 1800 MHz)

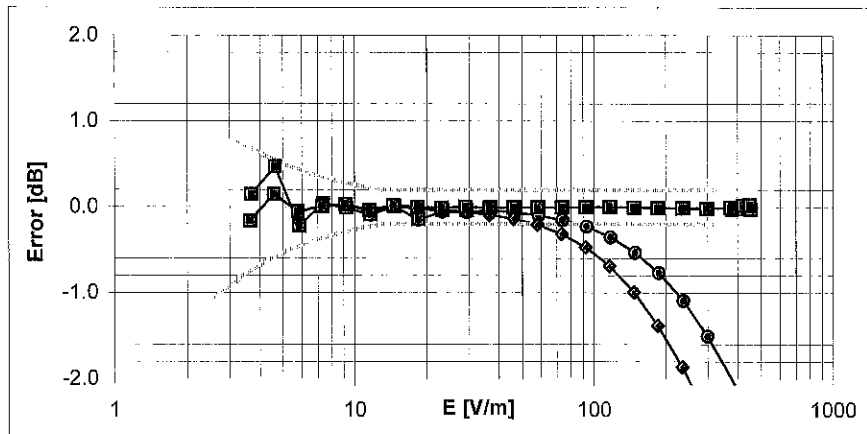
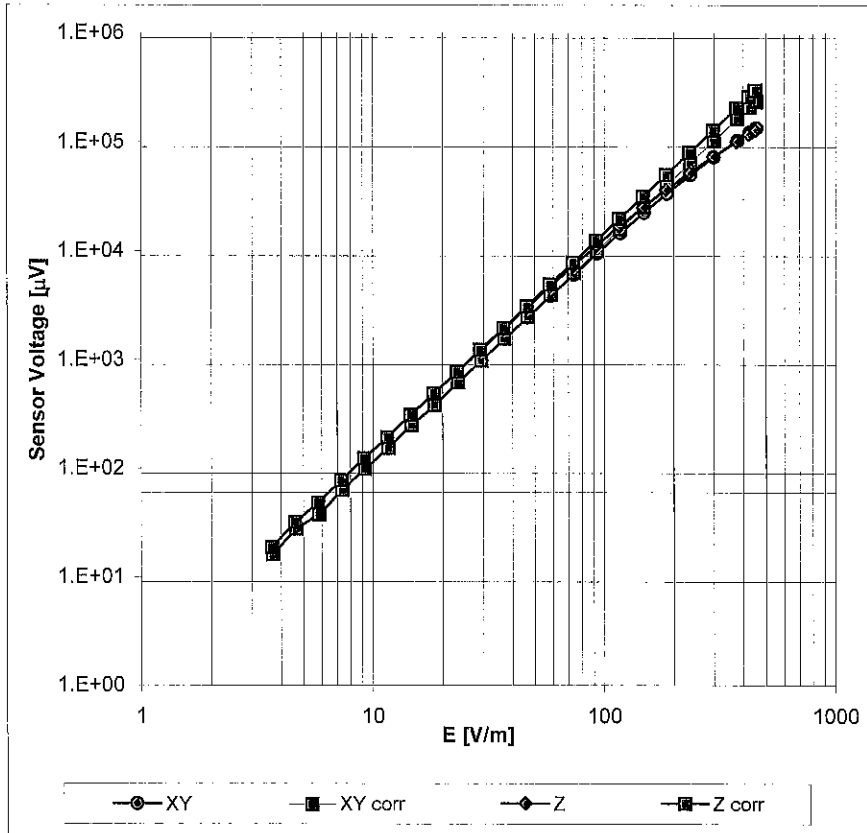

Uncertainty of Linearity Assessment:  $\pm 0.6\%$  (k=2)

### Deviation from Isotropy in Air Error ( $\phi, \vartheta$ ), $f = 900$ MHz

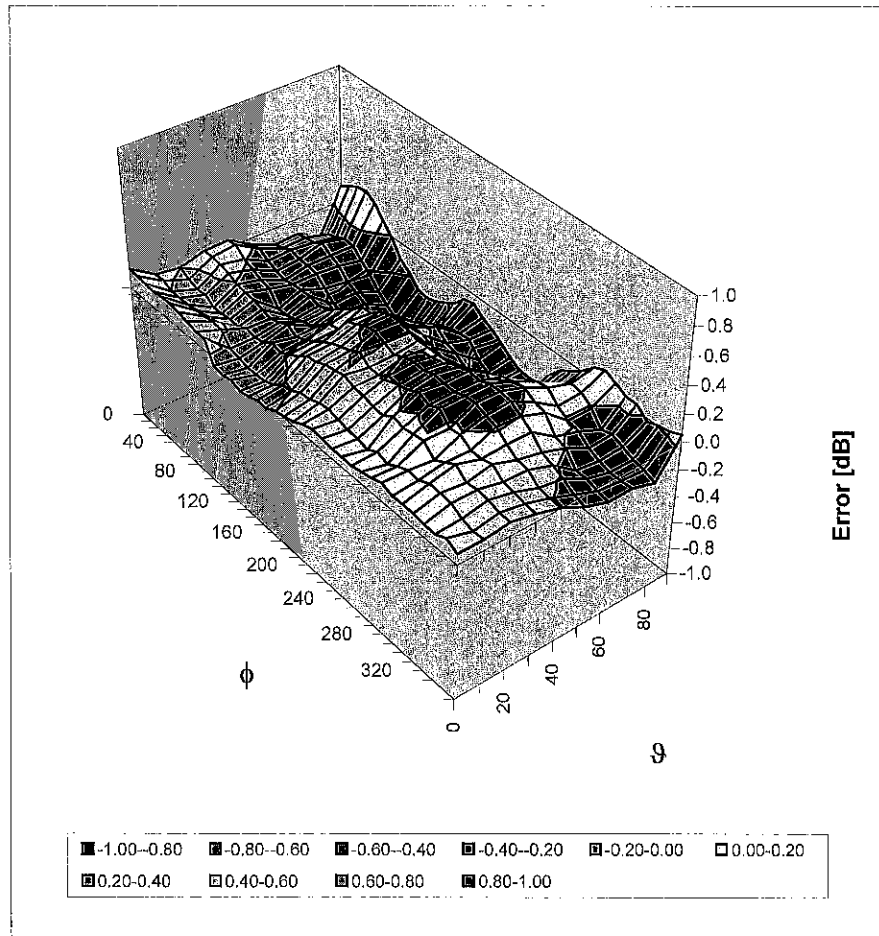

Uncertainty of Spherical Isotropy Assessment:  $\pm 2.6\%$  ( $k=2$ )

## Other Probe Parameters

Sensor Arrangement	Rectangular
Connector Angle (°)	-50.9
Mechanical Surface Detection Mode	enabled
Optical Surface Detection Mode	disabled
Probe Overall Length	337 mm
Probe Body Diameter	10 mm
Tip Length	10 mm
Tip Diameter	8.0 mm
Probe Tip to Sensor X Calibration Point	2.5 mm
Probe Tip to Sensor Y Calibration Point	2.5 mm
Probe Tip to Sensor Z Calibration Point	2.5 mm

**Annex B****Measurement Plots**

Test Laboratory: Eurofins Product Service GmbH

### Dipol Valid.900 (m)\_250mW\_ELI4\_17.08.2010

**DUT: Dipole 900 MHz; Type: D900V2; Serial: 164**

Communication System: CW; Frequency: 900 MHz; Duty Cycle: 1:1

Medium: Muscle 900 MHz Medium parameters used:  $f = 900$  MHz;  $\sigma = 1.01$  mho/m;  $\epsilon_r = 54.1$ ;  $\rho = 1000$  kg/m<sup>3</sup>

Phantom section: Flat Section

DASY4 Configuration:

- Probe: ET3DV6 - SN1711; ConvF(5.85, 5.85, 5.85); Calibrated: 9/15/2009
- Sensor-Surface: 4mm (Mechanical And Optical Surface Detection)
- Electronics: DAE3 Sn522; Calibrated: 9/11/2009
- Phantom: Flat Phantom ELI4.0; Type: QDOVA001BB; Serial: SN:1013
- Measurement SW: DASY4, V4.7 Build 71; Postprocessing SW: SEMCAD, V1.8 Build 184

**Dipol 900 (250mW)/Area Scan (61x101x1):** Measurement grid: dx=10mm, dy=10mm  
Maximum value of SAR (interpolated) = 2.95 mW/g

**Dipol 900 (250mW)/Zoom Scan (7x7x7)/Cube 0:** Measurement grid: dx=5mm, dy=5mm, dz=5mm

Reference Value = 56.9 V/m; Power Drift = -0.011 dB

Peak SAR (extrapolated) = 3.82 W/kg

**SAR(1 g) = 2.66 mW/g; SAR(10 g) = 1.73 mW/g**

Maximum value of SAR (measured) = 2.90 mW/g

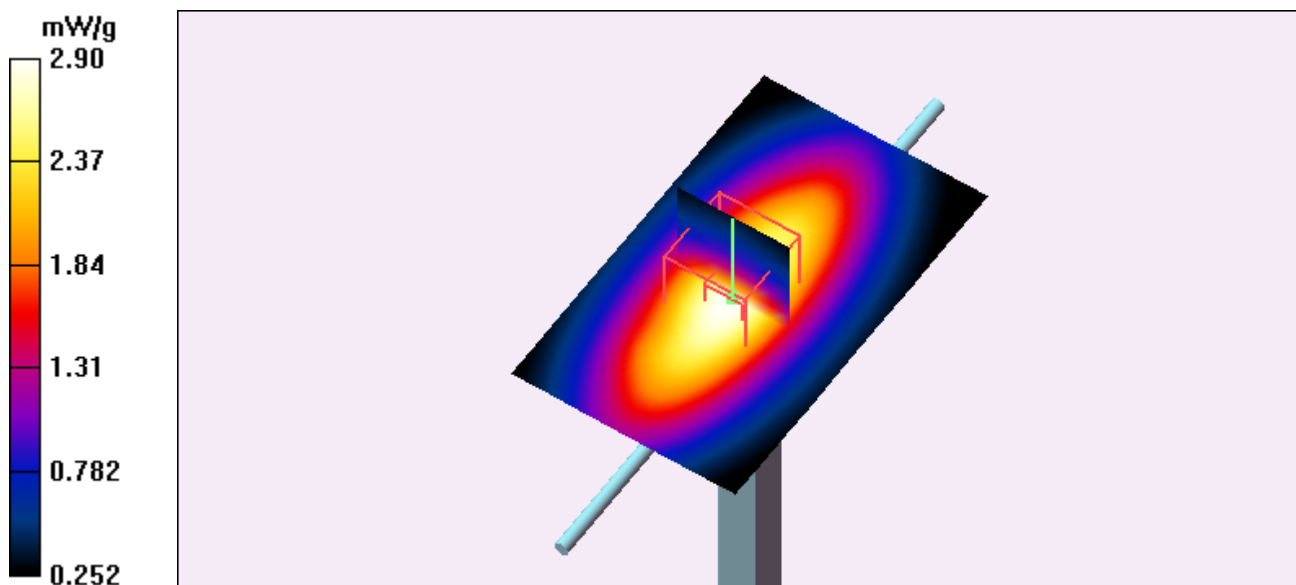

Test Laboratory: Eurofins Product Service GmbH

## Dipol Valid.900 (m)\_250mW\_ELI4\_18.08.2010

**DUT: Dipole 900 MHz; Type: D900V2; Serial: 164**

Communication System: CW; Frequency: 900 MHz; Duty Cycle: 1:1

Medium: Muscle 900 MHz Medium parameters used:  $f = 900$  MHz;  $\sigma = 1.01$  mho/m;  $\epsilon_r = 54.1$ ;  $\rho = 1000$  kg/m<sup>3</sup>

Phantom section: Flat Section

DASY4 Configuration:

- Probe: ET3DV6 - SN1711; ConvF(5.85, 5.85, 5.85); Calibrated: 9/15/2009
- Sensor-Surface: 4mm (Mechanical And Optical Surface Detection)
- Electronics: DAE3 Sn522; Calibrated: 9/11/2009
- Phantom: Flat Phantom ELI4.0; Type: QDOVA001BB; Serial: SN:1013
- Measurement SW: DASY4, V4.7 Build 71; Postprocessing SW: SEMCAD, V1.8 Build 184

**Dipol 900 (250mW)/Area Scan (61x101x1):** Measurement grid: dx=10mm, dy=10mm  
Maximum value of SAR (interpolated) = 2.85 mW/g

**Dipol 900 (250mW)/Zoom Scan (7x7x7)/Cube 0:** Measurement grid: dx=5mm, dy=5mm, dz=5mm

Reference Value = 56.0 V/m; Power Drift = -0.025 dB

Peak SAR (extrapolated) = 3.93 W/kg

**SAR(1 g) = 2.69 mW/g; SAR(10 g) = 1.74 mW/g**

Maximum value of SAR (measured) = 2.90 mW/g

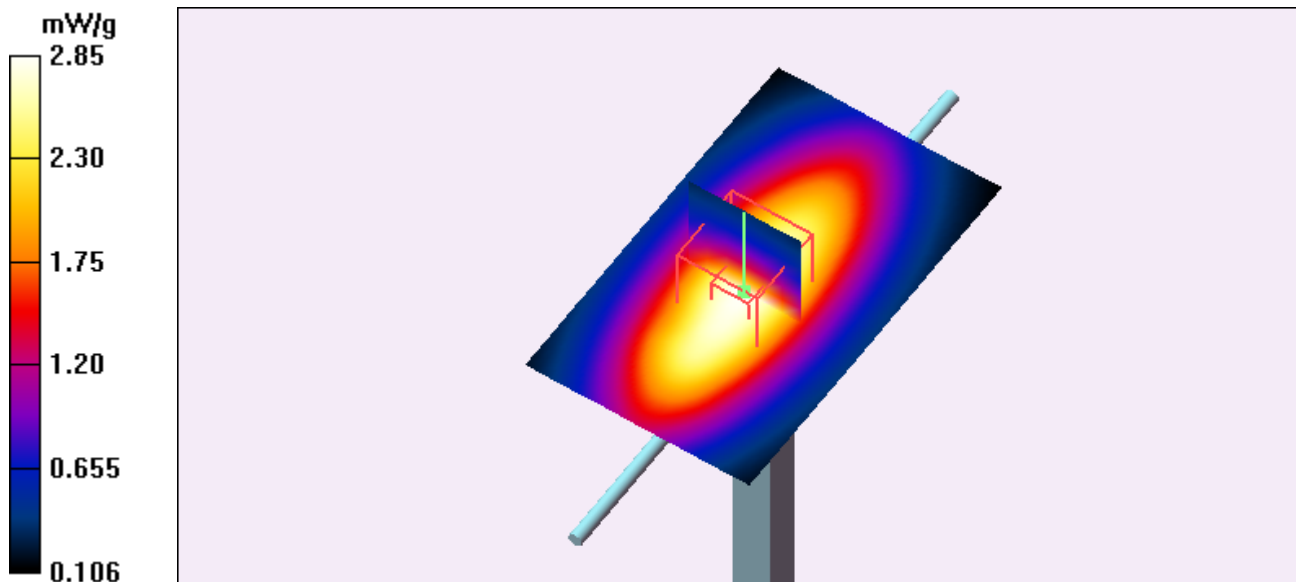

Test Laboratory: Eurofins Product Service GmbH

### Dipol Valid.1900 (m)\_250mW\_ELI4\_20.08.2010

**DUT: Dipole 1900 MHz; Type: D1900V2; Serial: 5d025**

Communication System: CW; Frequency: 1900 MHz; Duty Cycle: 1:1

Medium: Muscle 1900 MHz Medium parameters used:  $f = 1900$  MHz;  $\sigma = 1.56$  mho/m;  $\epsilon_r = 51.9$ ;  $\rho = 1000$  kg/m<sup>3</sup>

Phantom section: Flat Section

DASY4 Configuration:

- Probe: ET3DV6 - SN1711; ConvF(4.6, 4.6, 4.6); Calibrated: 9/15/2009
- Sensor-Surface: 4mm (Mechanical And Optical Surface Detection)
- Electronics: DAE3 Sn522; Calibrated: 9/11/2009
- Phantom: Flat Phantom ELI4.0; Type: QDOVA001BB; Serial: SN:1013
- Measurement SW: DASY4, V4.7 Build 71; Postprocessing SW: SEMCAD, V1.8 Build 184

**Dipol 1900 (250mW)/Area Scan (61x101x1):** Measurement grid: dx=10mm, dy=10mm  
Maximum value of SAR (interpolated) = 12.3 mW/g

**Dipol 1900 (250mW)/Zoom Scan (7x7x7)/Cube 0:** Measurement grid: dx=5mm, dy=5mm, dz=5mm

Reference Value = 97.7 V/m; Power Drift = -0.057 dB

Peak SAR (extrapolated) = 16.5 W/kg

**SAR(1 g) = 10.7 mW/g; SAR(10 g) = 5.78 mW/g**

Maximum value of SAR (measured) = 12.3 mW/g

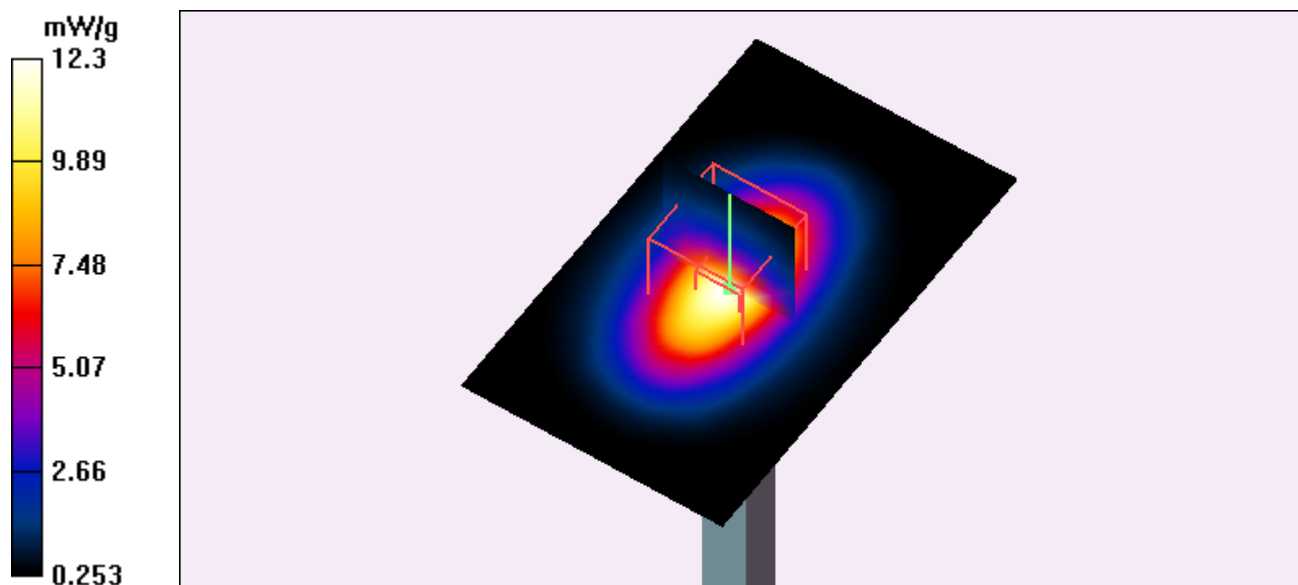



Test Laboratory: Eurofins Product Service GmbH

### Dipol Valid.1900 (m)\_250mW\_ELI4\_23.08.2010

**DUT: Dipole 1900 MHz; Type: D1900V2; Serial: 5d025**

Communication System: CW; Frequency: 1900 MHz; Duty Cycle: 1:1

Medium: Muscle 1900 MHz Medium parameters used:  $f = 1900$  MHz;  $\sigma = 1.56$  mho/m;  $\epsilon_r = 51.9$ ;  $\rho = 1000$  kg/m<sup>3</sup>

Phantom section: Flat Section

DASY4 Configuration:

- Probe: ET3DV6 - SN1711; ConvF(4.6, 4.6, 4.6); Calibrated: 9/15/2009
- Sensor-Surface: 4mm (Mechanical And Optical Surface Detection)
- Electronics: DAE3 Sn522; Calibrated: 9/11/2009
- Phantom: Flat Phantom ELI4.0; Type: QDOVA001BB; Serial: SN:1013
- Measurement SW: DASY4, V4.7 Build 71; Postprocessing SW: SEMCAD, V1.8 Build 184

**Dipol 1900 (250mW)/Area Scan (61x101x1):** Measurement grid: dx=10mm, dy=10mm  
Maximum value of SAR (interpolated) = 12.4 mW/g

**Dipol 1900 (250mW)/Zoom Scan (7x7x7)/Cube 0:** Measurement grid: dx=5mm, dy=5mm, dz=5mm

Reference Value = 97.2 V/m; Power Drift = -0.023 dB

Peak SAR (extrapolated) = 16.3 W/kg

**SAR(1 g) = 10.6 mW/g; SAR(10 g) = 5.72 mW/g**

Maximum value of SAR (measured) = 12.3 mW/g

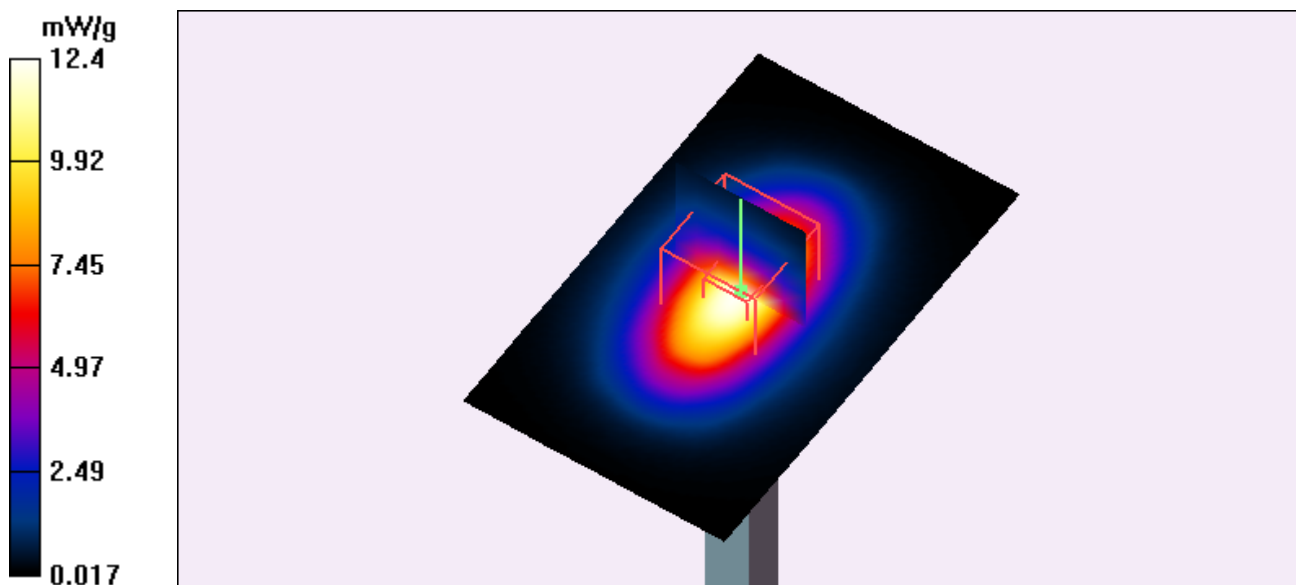

Test Laboratory: Eurofins Product Service GmbH

### GSM-850\_CH\_128\_EGPRS\_flat\_front\_10mm

**DUT: Field controller Tornado; Type: CS 15; Serial: 022**

Communication System: GSM 850; Frequency: 824.2 MHz; Duty Cycle: 1:8.3

Medium: Muscle 900 MHz Medium parameters used:  $f = 824.2$  MHz;  $\sigma = 0.927$  mho/m;  $\epsilon_r = 54.9$ ;  $\rho = 1000$  kg/m<sup>3</sup>

Phantom section: Flat Section

DASY4 Configuration:

- Probe: ET3DV6 - SN1711; ConvF(5.85, 5.85, 5.85); Calibrated: 9/15/2009
- Sensor-Surface: 4mm (Mechanical And Optical Surface Detection)
- Electronics: DAE3 Sn522; Calibrated: 9/11/2009
- Phantom: Flat Phantom ELI4.0; Type: QDOVA001BB; Serial: SN:1013
- Measurement SW: DASY4, V4.7 Build 71; Postprocessing SW: SEMCAD, V1.8 Build 184

**CS 15/Area Scan (171x91x1):** Measurement grid: dx=15mm, dy=15mm

Maximum value of SAR (interpolated) = 0.845 mW/g

**CS 15/Zoom Scan (7x7x7)/Cube 0:** Measurement grid: dx=5mm, dy=5mm, dz=5mm

Reference Value = 13.9 V/m; Power Drift = -0.198 dB

Peak SAR (extrapolated) = 1.03 W/kg

**SAR(1 g) = 0.795 mW/g; SAR(10 g) = 0.584 mW/g**

Maximum value of SAR (measured) = 0.838 mW/g

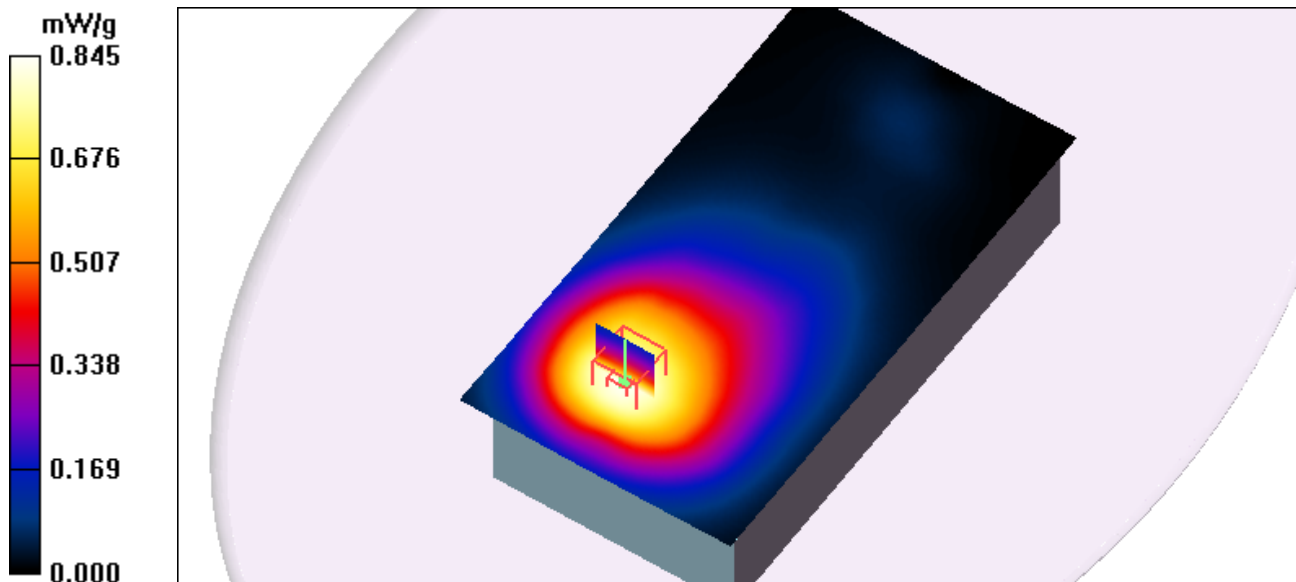

Test Laboratory: Eurofins Product Service GmbH

### GSM-850\_CH\_128\_GPRS\_flat\_back\_10mm

**DUT: Field controller Tornado; Type: CS 15; Serial: 022**

Communication System: GSM 850; Frequency: 824.2 MHz; Duty Cycle: 1:8.3

Medium: Muscle 900 MHz Medium parameters used:  $f = 824.2$  MHz;  $\sigma = 0.927$  mho/m;  $\epsilon_r = 54.9$ ;  $\rho = 1000$  kg/m<sup>3</sup>

Phantom section: Flat Section

DASY4 Configuration:

- Probe: ET3DV6 - SN1711; ConvF(5.85, 5.85, 5.85); Calibrated: 9/15/2009
- Sensor-Surface: 4mm (Mechanical And Optical Surface Detection)
- Electronics: DAE3 Sn522; Calibrated: 9/11/2009
- Phantom: Flat Phantom ELI4.0; Type: QDOVA001BB; Serial: SN:1013
- Measurement SW: DASY4, V4.7 Build 71; Postprocessing SW: SEMCAD, V1.8 Build 184

**CS 15/Area Scan (171x91x1):** Measurement grid: dx=15mm, dy=15mm

Maximum value of SAR (interpolated) = 0.587 mW/g

**CS 15/Zoom Scan (7x7x7)/Cube 0:** Measurement grid: dx=5mm, dy=5mm, dz=5mm

Reference Value = 12.1 V/m; Power Drift = -0.185 dB

Peak SAR (extrapolated) = 0.703 W/kg

**SAR(1 g) = 0.536 mW/g; SAR(10 g) = 0.394 mW/g**

Maximum value of SAR (measured) = 0.570 mW/g

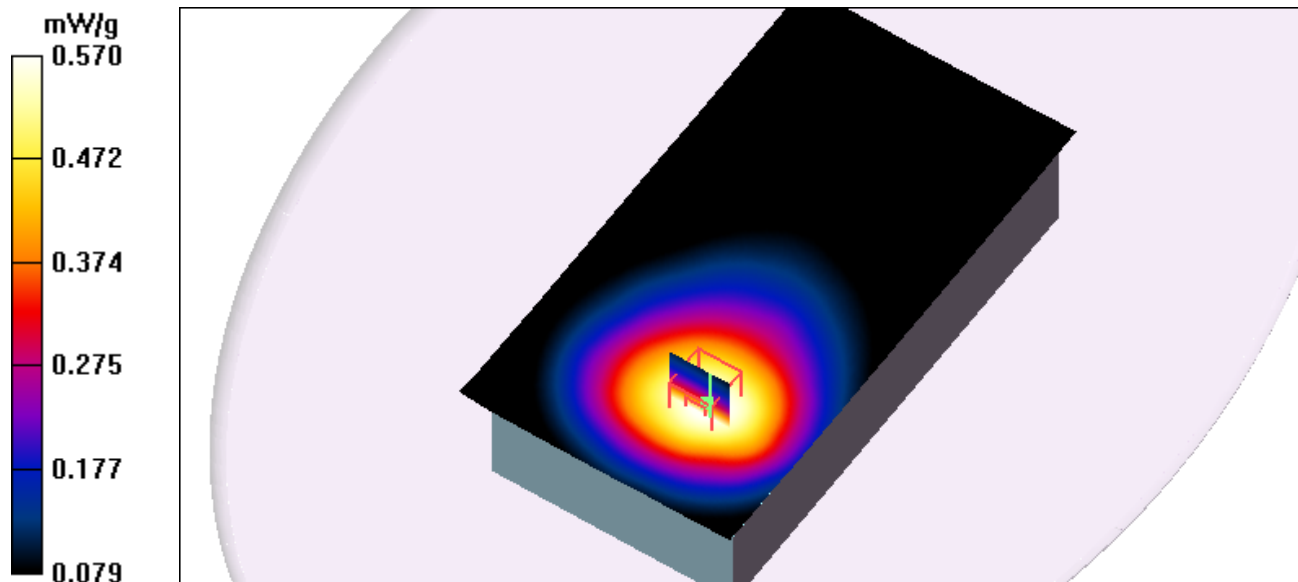

Test Laboratory: Eurofins Product Service GmbH

## GSM-850\_CH\_128\_GPRS\_flat\_front\_10mm

**DUT: Field controller Tornado; Type: CS 15; Serial: 022**

Communication System: GSM 850; Frequency: 824.2 MHz; Duty Cycle: 1:8.3

Medium: Muscle 900 MHz Medium parameters used:  $f = 824.2$  MHz;  $\sigma = 0.927$  mho/m;  $\epsilon_r = 54.9$ ;  $\rho = 1000$  kg/m<sup>3</sup>

Phantom section: Flat Section

DASY4 Configuration:

- Probe: ET3DV6 - SN1711; ConvF(5.85, 5.85, 5.85); Calibrated: 9/15/2009
- Sensor-Surface: 4mm (Mechanical And Optical Surface Detection)
- Electronics: DAE3 Sn522; Calibrated: 9/11/2009
- Phantom: Flat Phantom ELI4.0; Type: QDOVA001BB; Serial: SN:1013
- Measurement SW: DASY4, V4.7 Build 71; Postprocessing SW: SEMCAD, V1.8 Build 184

**CS 15/Area Scan (171x91x1):** Measurement grid: dx=15mm, dy=15mm

Maximum value of SAR (interpolated) = 0.837 mW/g

**CS 15/Zoom Scan (7x7x7)/Cube 0:** Measurement grid: dx=5mm, dy=5mm, dz=5mm

Reference Value = 14.2 V/m; Power Drift = -0.121 dB

Peak SAR (extrapolated) = 1.04 W/kg

**SAR(1 g) = 0.800 mW/g; SAR(10 g) = 0.586 mW/g**

Maximum value of SAR (measured) = 0.846 mW/g

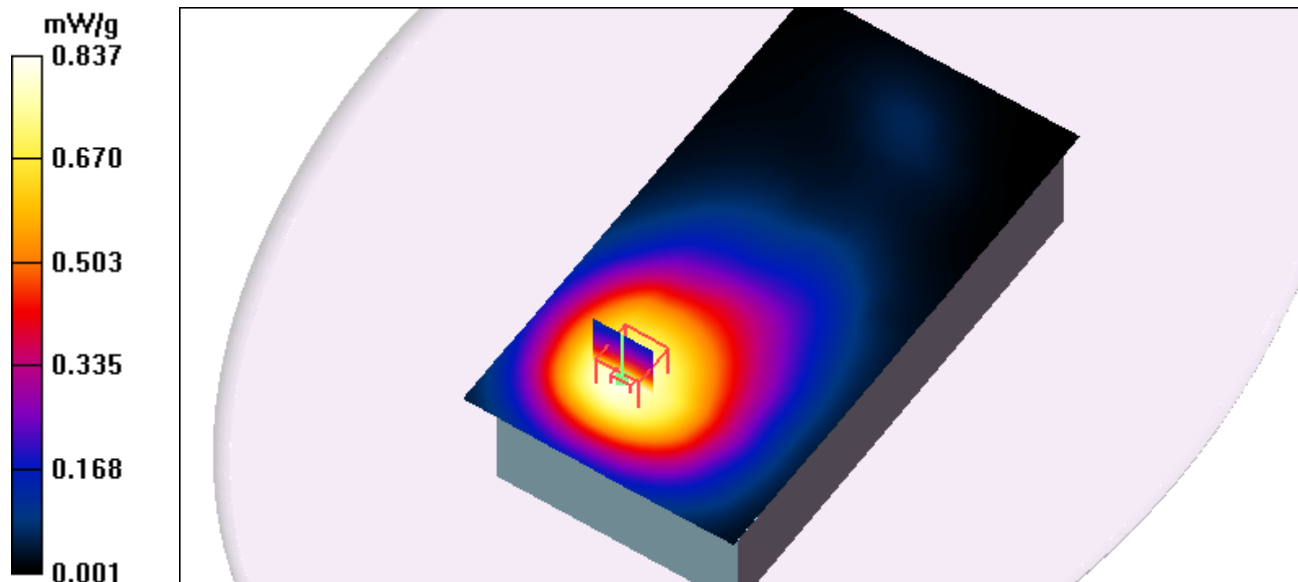

Test Laboratory: Eurofins Product Service GmbH

## GSM-850\_CH\_188\_GPRS\_flat\_back\_10mm

**DUT: Field controller Tornado; Type: CS 15; Serial: 022**

Communication System: GSM 850; Frequency: 836.2 MHz; Duty Cycle: 1:8.3

Medium: Muscle 900 MHz Medium parameters used:  $f = 836.2$  MHz;  $\sigma = 0.936$  mho/m;  $\epsilon_r = 54.8$ ;  $\rho = 1000$  kg/m<sup>3</sup>

Phantom section: Flat Section

DASY4 Configuration:

- Probe: ET3DV6 - SN1711; ConvF(5.85, 5.85, 5.85); Calibrated: 9/15/2009
- Sensor-Surface: 4mm (Mechanical And Optical Surface Detection)
- Electronics: DAE3 Sn522; Calibrated: 9/11/2009
- Phantom: Flat Phantom ELI4.0; Type: QDOVA001BB; Serial: SN:1013
- Measurement SW: DASY4, V4.7 Build 71; Postprocessing SW: SEMCAD, V1.8 Build 184

**CS 15/Area Scan (171x91x1):** Measurement grid: dx=15mm, dy=15mm

Maximum value of SAR (interpolated) = 0.515 mW/g

**CS 15/Zoom Scan (7x7x7)/Cube 0:** Measurement grid: dx=5mm, dy=5mm, dz=5mm

Reference Value = 11.8 V/m; Power Drift = -0.167 dB

Peak SAR (extrapolated) = 0.635 W/kg

**SAR(1 g) = 0.482 mW/g; SAR(10 g) = 0.354 mW/g**

Maximum value of SAR (measured) = 0.511 mW/g

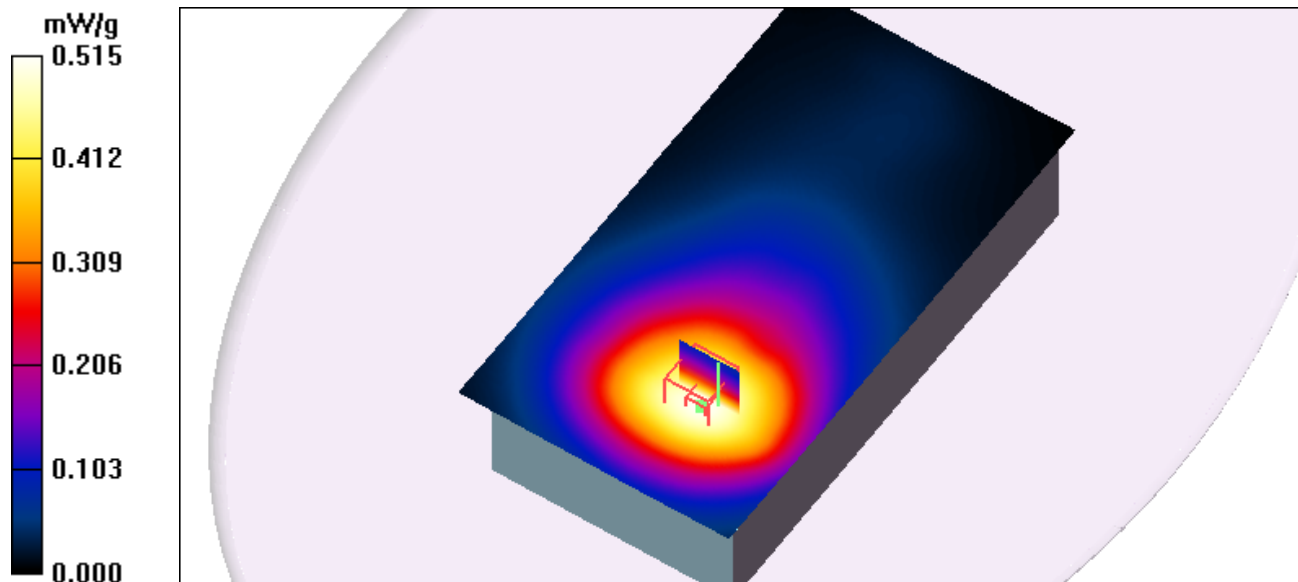

Test Laboratory: Eurofins Product Service GmbH

### GSM-850\_CH\_188\_GPRS\_flat\_front\_10mm

**DUT: Field controller Tornado; Type: CS 15; Serial: 022**

Communication System: GSM 850; Frequency: 836.2 MHz; Duty Cycle: 1:8.3

Medium: Muscle 900 MHz Medium parameters used:  $f = 836.2$  MHz;  $\sigma = 0.936$  mho/m;  $\epsilon_r = 54.8$ ;  $\rho = 1000$  kg/m<sup>3</sup>

Phantom section: Flat Section

DASY4 Configuration:

- Probe: ET3DV6 - SN1711; ConvF(5.85, 5.85, 5.85); Calibrated: 9/15/2009
- Sensor-Surface: 4mm (Mechanical And Optical Surface Detection)
- Electronics: DAE3 Sn522; Calibrated: 9/11/2009
- Phantom: Flat Phantom ELI4.0; Type: QDOVA001BB; Serial: SN:1013
- Measurement SW: DASY4, V4.7 Build 71; Postprocessing SW: SEMCAD, V1.8 Build 184

**CS 15/Area Scan (171x91x1):** Measurement grid: dx=15mm, dy=15mm

Maximum value of SAR (interpolated) = 0.751 mW/g

**CS 15/Zoom Scan (7x7x7)/Cube 0:** Measurement grid: dx=5mm, dy=5mm, dz=5mm

Reference Value = 14.7 V/m; Power Drift = -0.129 dB

Peak SAR (extrapolated) = 0.892 W/kg

**SAR(1 g) = 0.694 mW/g; SAR(10 g) = 0.515 mW/g**

Maximum value of SAR (measured) = 0.736 mW/g

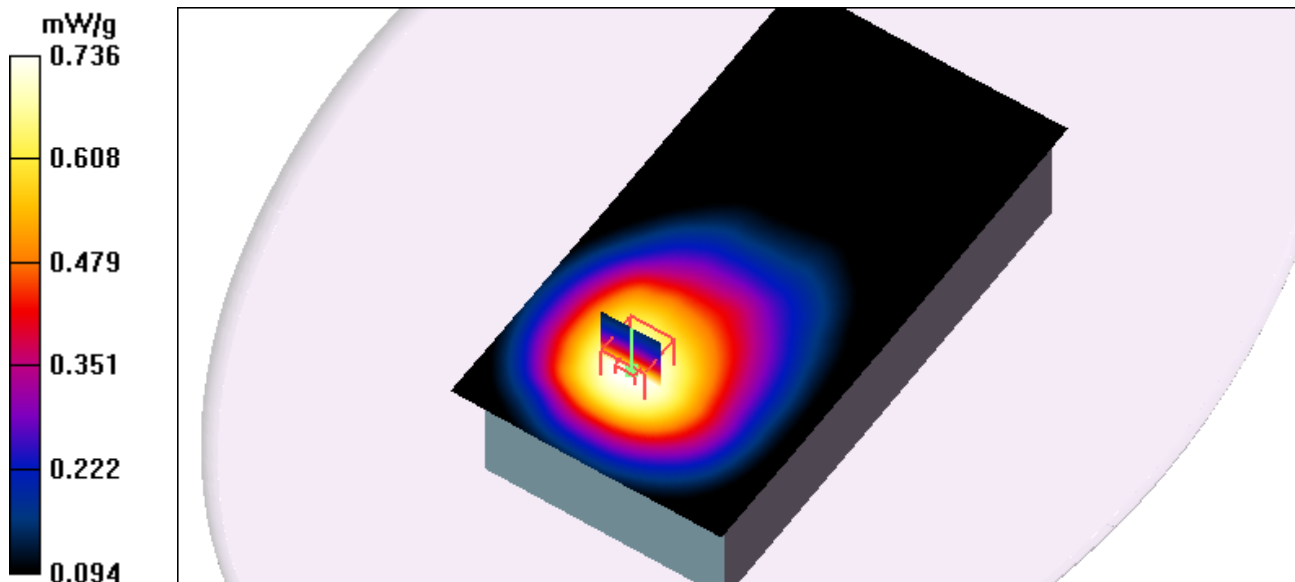

Test Laboratory: Eurofins Product Service GmbH

### GSM-850\_CH\_251\_GPRS\_flat\_back\_10mm

**DUT: Field controller Tornado; Type: CS 15; Serial: 022**

Communication System: GSM 850; Frequency: 848.8 MHz; Duty Cycle: 1:8.3

Medium: Muscle 900 MHz Medium parameters used:  $f = 848.8$  MHz;  $\sigma = 0.944$  mho/m;  $\epsilon_r = 54.7$ ;  $\rho = 1000$  kg/m<sup>3</sup>

Phantom section: Flat Section

DASY4 Configuration:

- Probe: ET3DV6 - SN1711; ConvF(5.85, 5.85, 5.85); Calibrated: 9/15/2009
- Sensor-Surface: 4mm (Mechanical And Optical Surface Detection)
- Electronics: DAE3 Sn522; Calibrated: 9/11/2009
- Phantom: Flat Phantom ELI4.0; Type: QDOVA001BB; Serial: SN:1013
- Measurement SW: DASY4, V4.7 Build 71; Postprocessing SW: SEMCAD, V1.8 Build 184

**CS 15/Area Scan (171x91x1):** Measurement grid: dx=15mm, dy=15mm

Maximum value of SAR (interpolated) = 0.423 mW/g

**CS 15/Zoom Scan (7x7x7)/Cube 0:** Measurement grid: dx=5mm, dy=5mm, dz=5mm

Reference Value = 10.7 V/m; Power Drift = -0.101 dB

Peak SAR (extrapolated) = 0.531 W/kg

**SAR(1 g) = 0.402 mW/g; SAR(10 g) = 0.294 mW/g**

Maximum value of SAR (measured) = 0.431 mW/g

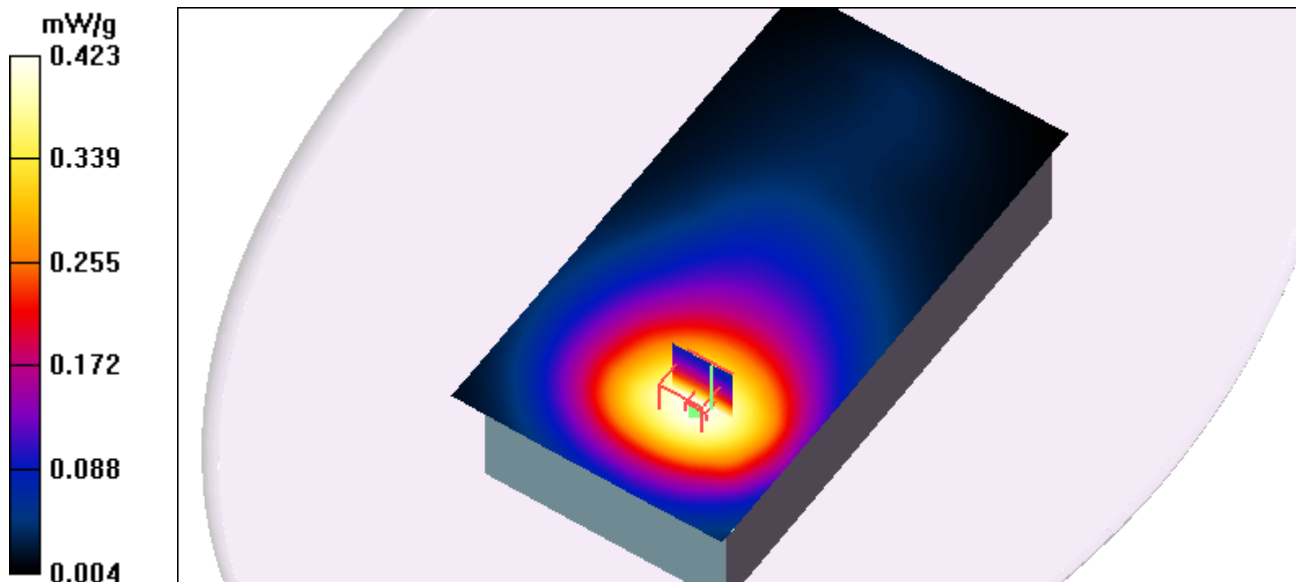

Test Laboratory: Eurofins Product Service GmbH

### GSM-850\_CH\_251\_GPRS\_flat\_front\_10mm

**DUT: Field controller Tornado; Type: CS 15; Serial: 022**

Communication System: GSM 850; Frequency: 848.8 MHz; Duty Cycle: 1:8.3

Medium: Muscle 900 MHz Medium parameters used:  $f = 848.8$  MHz;  $\sigma = 0.944$  mho/m;  $\epsilon_r = 54.7$ ;  $\rho = 1000$  kg/m<sup>3</sup>

Phantom section: Flat Section

DASY4 Configuration:

- Probe: ET3DV6 - SN1711; ConvF(5.85, 5.85, 5.85); Calibrated: 9/15/2009
- Sensor-Surface: 4mm (Mechanical And Optical Surface Detection)
- Electronics: DAE3 Sn522; Calibrated: 9/11/2009
- Phantom: Flat Phantom ELI4.0; Type: QDOVA001BB; Serial: SN:1013
- Measurement SW: DASY4, V4.7 Build 71; Postprocessing SW: SEMCAD, V1.8 Build 184

**CS 15/Area Scan (171x91x1):** Measurement grid: dx=15mm, dy=15mm

Maximum value of SAR (interpolated) = 0.701 mW/g

**CS 15/Zoom Scan (7x7x7)/Cube 0:** Measurement grid: dx=5mm, dy=5mm, dz=5mm

Reference Value = 12.9 V/m; Power Drift = -0.149 dB

Peak SAR (extrapolated) = 0.792 W/kg

**SAR(1 g) = 0.644 mW/g; SAR(10 g) = 0.510 mW/g**

Maximum value of SAR (measured) = 0.686 mW/g

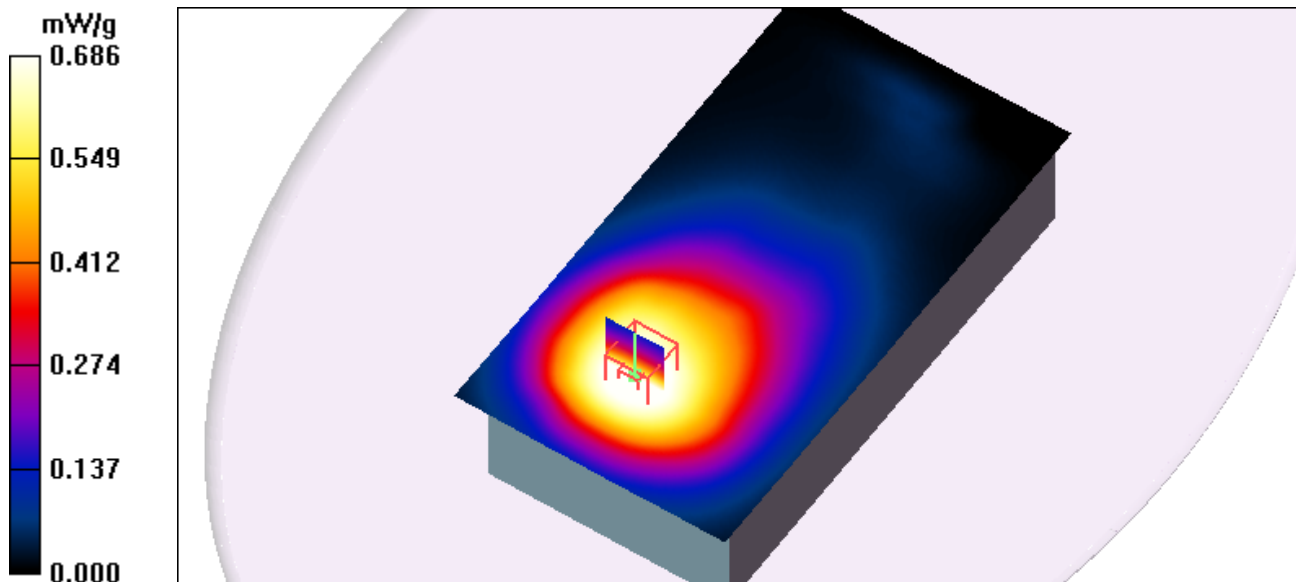



Test Laboratory: Eurofins Product Service GmbH

## Z - axis scan

**DUT: Field controller Tornado; Type: CS 15; Serial: 022**

Communication System: GSM 850; Frequency: 824.2 MHz; Duty Cycle: 1:8.3

Medium: Muscle 900 MHz Medium parameters used:  $f = 824.2$  MHz;  $\sigma = 0.927$  mho/m;  $\epsilon_r = 54.9$ ;  $\rho = 1000$  kg/m<sup>3</sup>

Phantom section: Flat Section

DASY4 Configuration:

- Probe: ET3DV6 - SN1711; ConvF(5.85, 5.85, 5.85); Calibrated: 9/15/2009
- Sensor-Surface: 0mm (Fix Surface)
- Electronics: DAE3 Sn522; Calibrated: 9/11/2009
- Phantom: Flat Phantom ELI4.0; Type: QDOVA001BB; Serial: SN:1013
- Measurement SW: DASY4, V4.7 Build 71; Postprocessing SW: SEMCAD, V1.8 Build 184

**CS 15/Z Scan (1x1x16):** Measurement grid: dx=20mm, dy=20mm, dz=20mm  
Maximum value of SAR (interpolated) = 0.127 mW/g

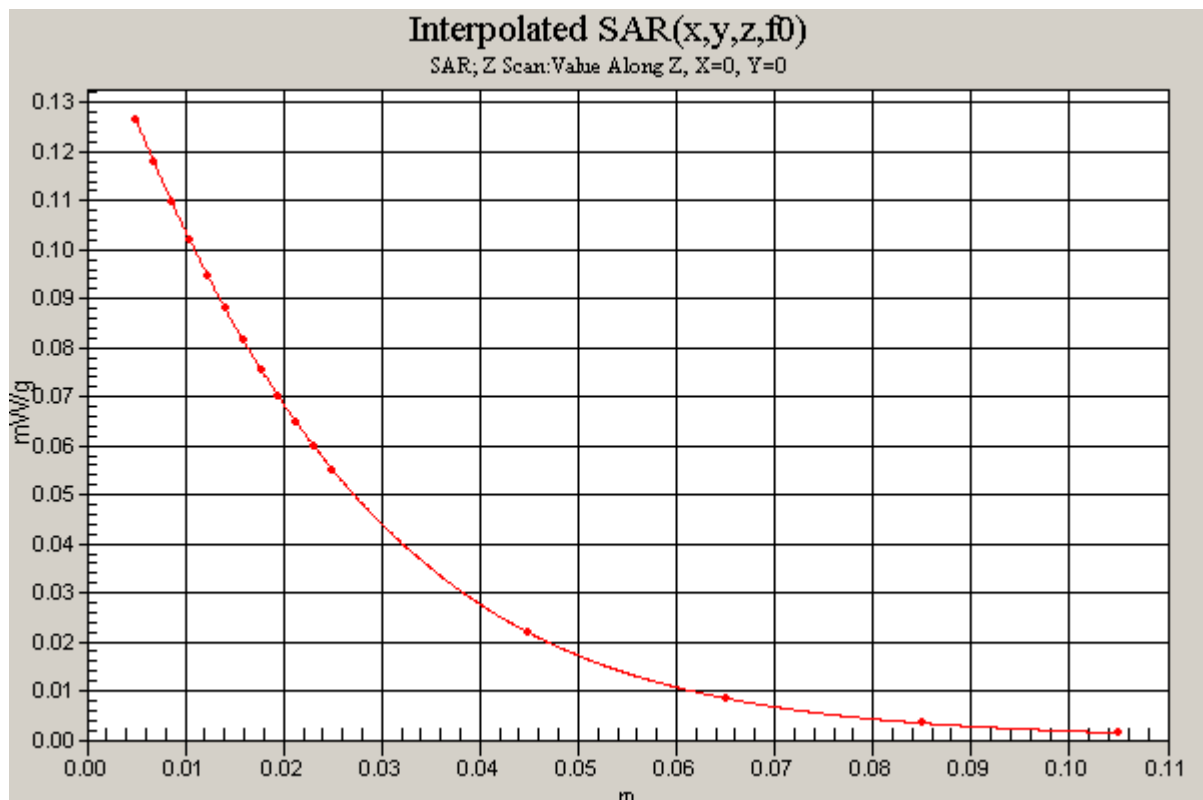

Test Laboratory: Eurofins Product Service GmbH

## GSM-1900\_CH\_512\_EGPRS\_flat\_back\_10mm

**DUT: Field controller Tornado; Type: CS 15; Serial: 022**

Communication System: GSM 1900; Frequency: 1850.2 MHz; Duty Cycle: 1:8.3

Medium: Muscle 1900 MHz Medium parameters used:  $f = 1850.2$  MHz;  $\sigma = 1.51$  mho/m;  $\epsilon_r = 52$ ;  $\rho = 1000$  kg/m<sup>3</sup>

Phantom section: Flat Section

DASY4 Configuration:

- Probe: ET3DV6 - SN1711; ConvF(4.6, 4.6, 4.6); Calibrated: 9/15/2009
- Sensor-Surface: 4mm (Mechanical And Optical Surface Detection)
- Electronics: DAE3 Sn522; Calibrated: 9/11/2009
- Phantom: Flat Phantom ELI4.0; Type: QDOVA001BB; Serial: SN:1013
- Measurement SW: DASY4, V4.7 Build 71; Postprocessing SW: SEMCAD, V1.8 Build 184

**CS 15/Area Scan (171x91x1):** Measurement grid: dx=15mm, dy=15mm

Maximum value of SAR (interpolated) = 0.273 mW/g

**CS 15/Zoom Scan (7x7x7)/Cube 0:** Measurement grid: dx=5mm, dy=5mm, dz=5mm

Reference Value = 8.30 V/m; Power Drift = -0.144 dB

Peak SAR (extrapolated) = 0.354 W/kg

**SAR(1 g) = 0.249 mW/g; SAR(10 g) = 0.160 mW/g**

Maximum value of SAR (measured) = 0.268 mW/g

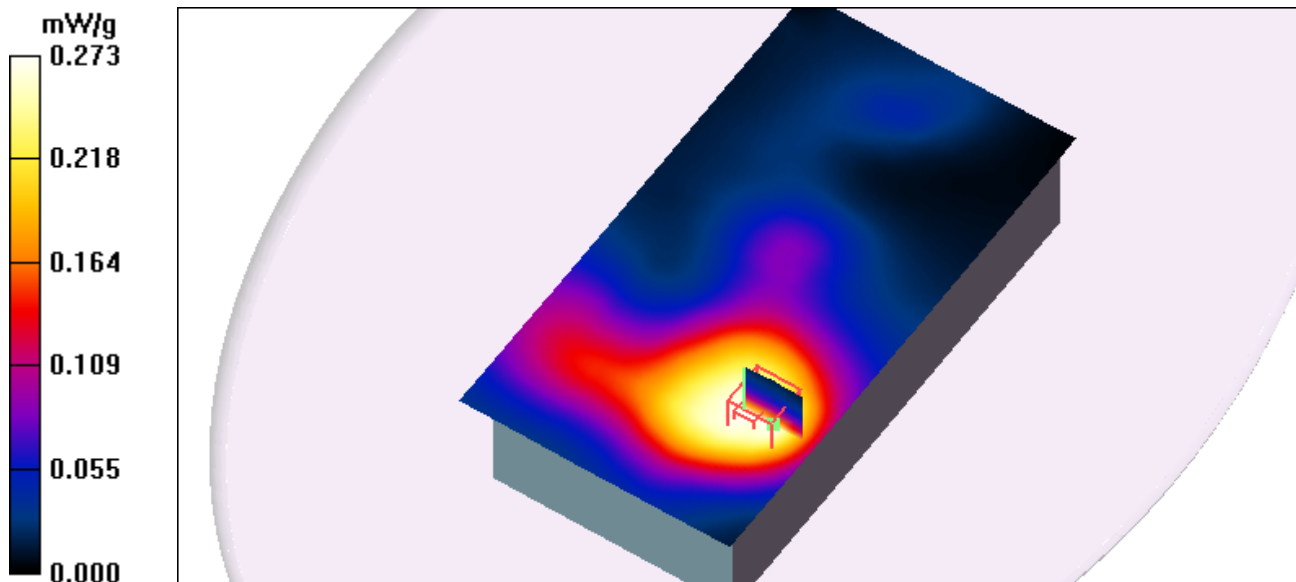

Test Laboratory: Eurofins Product Service GmbH

## GSM-1900\_CH\_512\_GPRS\_flat\_back\_10mm

**DUT: Field controller Tornado; Type: CS 15; Serial: 022**

Communication System: GSM 1900; Frequency: 1850.2 MHz; Duty Cycle: 1:8.3

Medium: Muscle 1900 MHz Medium parameters used:  $f = 1850.2 \text{ MHz}$ ;  $\sigma = 1.51 \text{ mho/m}$ ;  $\epsilon_r = 52$ ;  $\rho = 1000 \text{ kg/m}^3$

Phantom section: Flat Section

DASY4 Configuration:

- Probe: ET3DV6 - SN1711; ConvF(4.6, 4.6, 4.6); Calibrated: 9/15/2009
- Sensor-Surface: 4mm (Mechanical And Optical Surface Detection)
- Electronics: DAE3 Sn522; Calibrated: 9/11/2009
- Phantom: Flat Phantom ELI4.0; Type: QDOVA001BB; Serial: SN:1013
- Measurement SW: DASY4, V4.7 Build 71; Postprocessing SW: SEMCAD, V1.8 Build 184

**CS 15/Area Scan (171x91x1):** Measurement grid:  $dx=15\text{mm}$ ,  $dy=15\text{mm}$

Maximum value of SAR (interpolated) =  $0.272 \text{ mW/g}$

**CS 15/Zoom Scan (7x7x7)/Cube 0:** Measurement grid:  $dx=5\text{mm}$ ,  $dy=5\text{mm}$ ,  $dz=5\text{mm}$

Reference Value =  $8.34 \text{ V/m}$ ; Power Drift =  $-0.128 \text{ dB}$

Peak SAR (extrapolated) =  $0.363 \text{ W/kg}$

**SAR(1 g) =  $0.253 \text{ mW/g}$ ; SAR(10 g) =  $0.168 \text{ mW/g}$**

Maximum value of SAR (measured) =  $0.276 \text{ mW/g}$

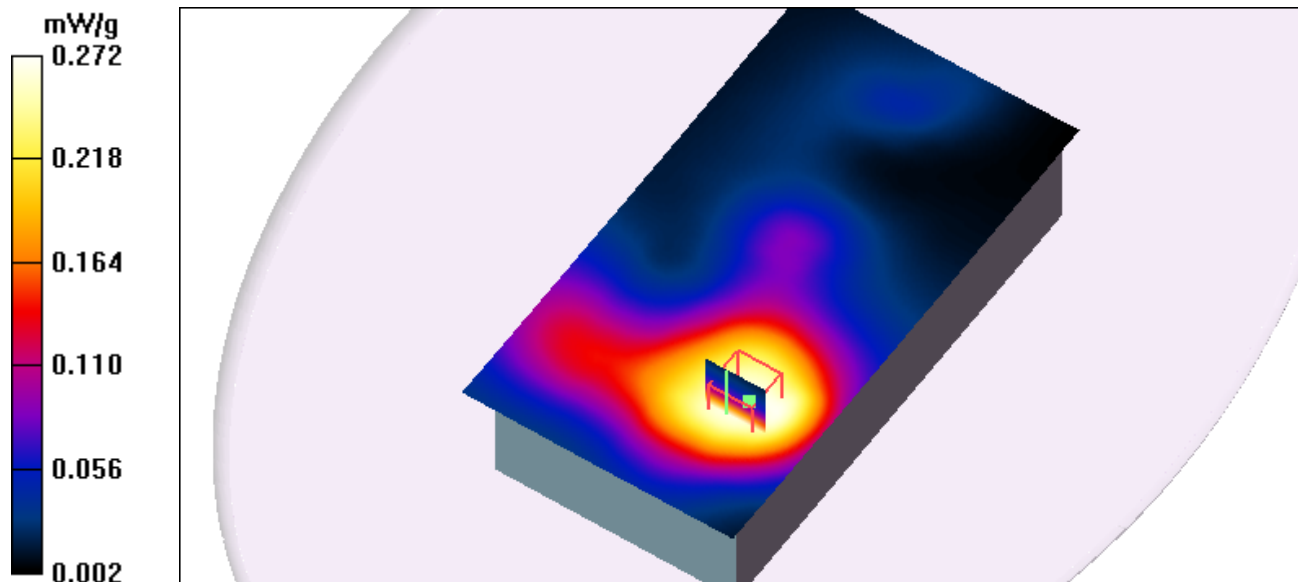

Test Laboratory: Eurofins Product Service GmbH

## GSM-1900\_CH\_661\_GPRS\_flat\_back\_10mm

**DUT: Field controller Tornado; Type: CS 15; Serial: 022**

Communication System: GSM 1900; Frequency: 1880 MHz; Duty Cycle: 1:8.3

Medium: Muscle 1900 MHz Medium parameters used:  $f = 1880$  MHz;  $\sigma = 1.55$  mho/m;  $\epsilon_r = 51.9$ ;  $\rho = 1000$  kg/m<sup>3</sup>

Phantom section: Flat Section

DASY4 Configuration:

- Probe: ET3DV6 - SN1711; ConvF(4.6, 4.6, 4.6); Calibrated: 9/15/2009
- Sensor-Surface: 4mm (Mechanical And Optical Surface Detection)
- Electronics: DAE3 Sn522; Calibrated: 9/11/2009
- Phantom: Flat Phantom ELI4.0; Type: QDOVA001BB; Serial: SN:1013
- Measurement SW: DASY4, V4.7 Build 71; Postprocessing SW: SEMCAD, V1.8 Build 184

**CS 15/Area Scan (171x91x1):** Measurement grid: dx=15mm, dy=15mm

Maximum value of SAR (interpolated) = 0.290 mW/g

**CS 15/Zoom Scan (7x7x7)/Cube 0:** Measurement grid: dx=5mm, dy=5mm, dz=5mm

Reference Value = 8.13 V/m; Power Drift = -0.133 dB

Peak SAR (extrapolated) = 0.365 W/kg

**SAR(1 g) = 0.249 mW/g; SAR(10 g) = 0.160 mW/g**

Maximum value of SAR (measured) = 0.268 mW/g

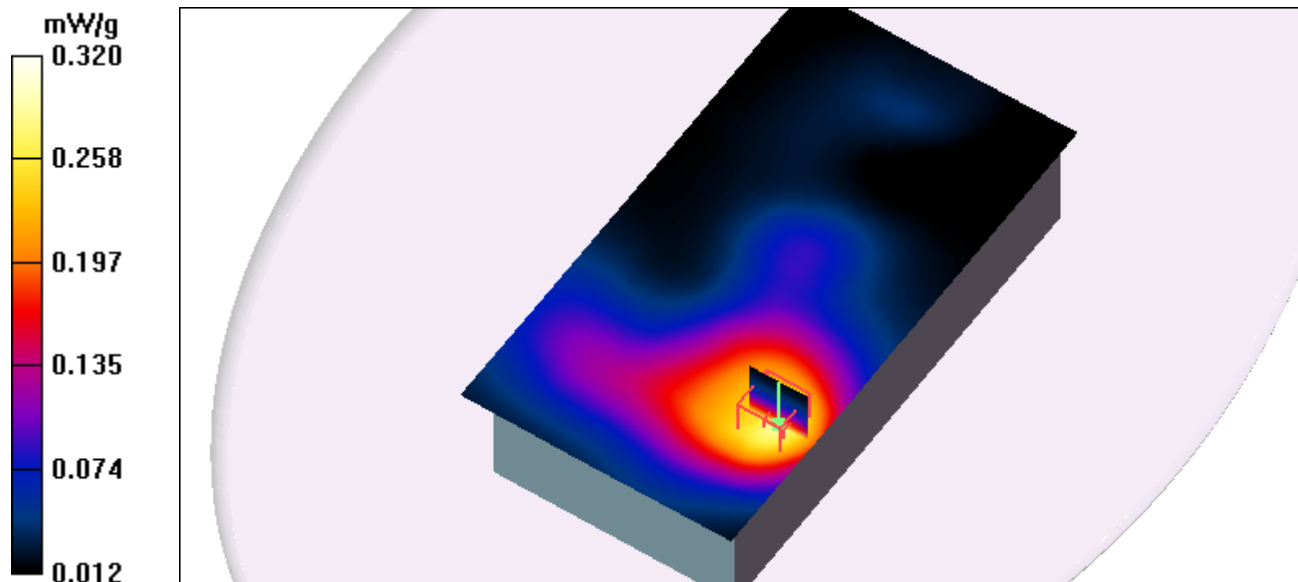

Test Laboratory: Eurofins Product Service GmbH

## GSM-1900\_CH\_661\_GPRS\_flat\_front\_10mm

**DUT: Field controller Tornado; Type: CS 15; Serial: 022**

Communication System: GSM 1900; Frequency: 1880 MHz; Duty Cycle: 1:8.3

Medium: Muscle 1900 MHz Medium parameters used:  $f = 1880$  MHz;  $\sigma = 1.55$  mho/m;  $\epsilon_r = 51.9$ ;  $\rho = 1000$  kg/m<sup>3</sup>

Phantom section: Flat Section

DASY4 Configuration:

- Probe: ET3DV6 - SN1711; ConvF(4.6, 4.6, 4.6); Calibrated: 9/15/2009
- Sensor-Surface: 4mm (Mechanical And Optical Surface Detection)
- Electronics: DAE3 Sn522; Calibrated: 9/11/2009
- Phantom: Flat Phantom ELI4.0; Type: QDOVA001BB; Serial: SN:1013
- Measurement SW: DASY4, V4.7 Build 71; Postprocessing SW: SEMCAD, V1.8 Build 184

**CS 15/Area Scan (171x91x1):** Measurement grid: dx=15mm, dy=15mm

Maximum value of SAR (interpolated) = 0.275 mW/g

**CS 15/Zoom Scan (7x7x7)/Cube 0:** Measurement grid: dx=5mm, dy=5mm, dz=5mm

Reference Value = 3.30 V/m; Power Drift = -0.139 dB

Peak SAR (extrapolated) = 0.323 W/kg

**SAR(1 g) = 0.236 mW/g; SAR(10 g) = 0.153 mW/g**

Maximum value of SAR (measured) = 0.257 mW/g

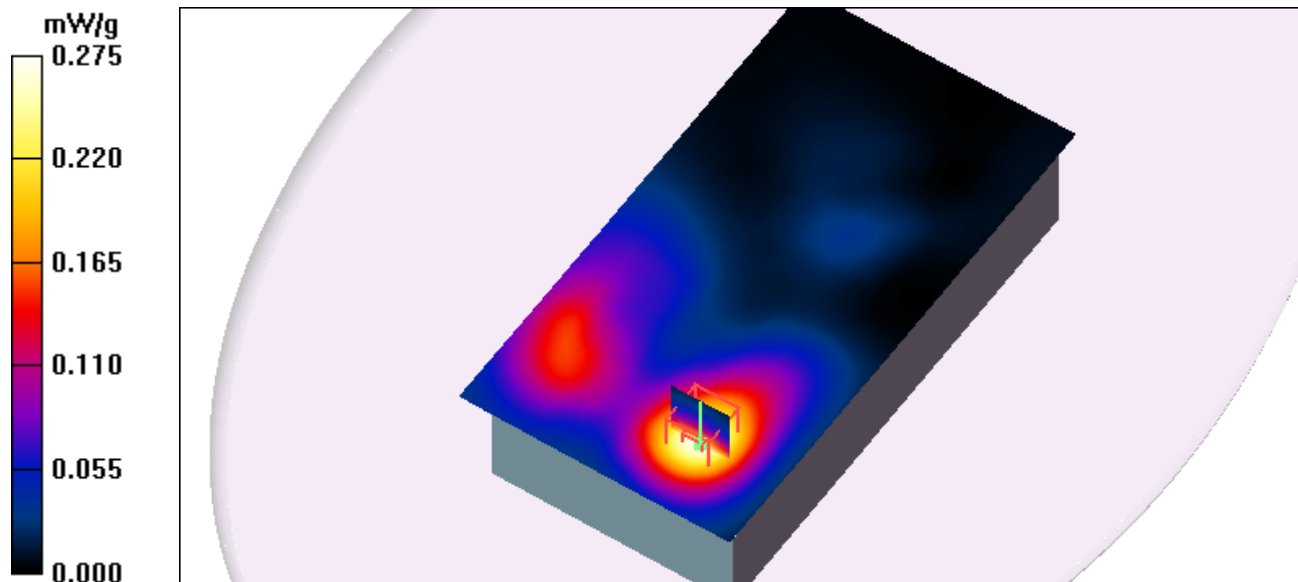

Test Laboratory: Eurofins Product Service GmbH

## GSM-1900\_CH\_810\_GPRS\_flat\_back\_10mm

**DUT: Field controller Tornado; Type: CS 15; Serial: 022**

Communication System: GSM 1900; Frequency: 1909.8 MHz; Duty Cycle: 1:8.3

Medium: Muscle 1900 MHz Medium parameters used:  $f = 1909.8$  MHz;  $\sigma = 1.58$  mho/m;  $\epsilon_r = 51.9$ ;

$\rho = 1000$  kg/m<sup>3</sup>

Phantom section: Flat Section

DASY4 Configuration:

- Probe: ET3DV6 - SN1711; ConvF(4.6, 4.6, 4.6); Calibrated: 9/15/2009
- Sensor-Surface: 4mm (Mechanical And Optical Surface Detection)
- Electronics: DAE3 Sn522; Calibrated: 9/11/2009
- Phantom: Flat Phantom ELI4.0; Type: QDOVA001BB; Serial: SN:1013
- Measurement SW: DASY4, V4.7 Build 71; Postprocessing SW: SEMCAD, V1.8 Build 184

**CS 15/Area Scan (171x91x1):** Measurement grid: dx=15mm, dy=15mm

Maximum value of SAR (interpolated) = 0.218 mW/g

**CS 15/Zoom Scan (7x7x7)/Cube 0:** Measurement grid: dx=5mm, dy=5mm, dz=5mm

Reference Value = 7.52 V/m; Power Drift = -0.177 dB

Peak SAR (extrapolated) = 0.294 W/kg

**SAR(1 g) = 0.200 mW/g; SAR(10 g) = 0.127 mW/g**

Maximum value of SAR (measured) = 0.216 mW/g

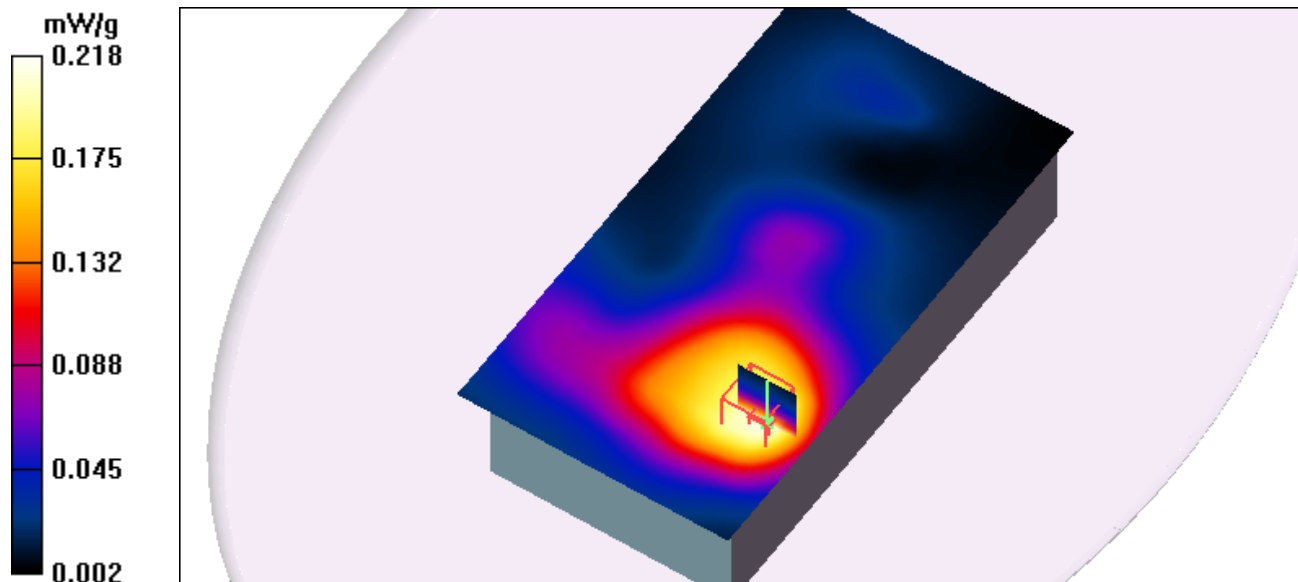

Test Laboratory: Eurofins Product Service GmbH

## Z - axis scan

**DUT: Field controller Tornado; Type: CS 15; Serial: 022**

Communication System: GSM 1900; Frequency: 1850.2 MHz; Duty Cycle: 1:8.3

Medium: Muscle 1900 MHz Medium parameters used:  $f = 1850.2$  MHz;  $\sigma = 1.51$  mho/m;  $\epsilon_r = 52$ ;  $\rho = 1000$  kg/m<sup>3</sup>

Phantom section: Flat Section

DASY4 Configuration:

- Probe: ET3DV6 - SN1711; ConvF(4.6, 4.6, 4.6); Calibrated: 9/15/2009
- Sensor-Surface: 0mm (Fix Surface)
- Electronics: DAE3 Sn522; Calibrated: 9/11/2009
- Phantom: Flat Phantom ELI4.0; Type: QDOVA001BB; Serial: SN:1013
- Measurement SW: DASY4, V4.7 Build 71; Postprocessing SW: SEMCAD, V1.8 Build 184

**CS 15/Z Scan (1x1x16):** Measurement grid: dx=20mm, dy=20mm, dz=20mm

Maximum value of SAR (interpolated) = 0.046 mW/g

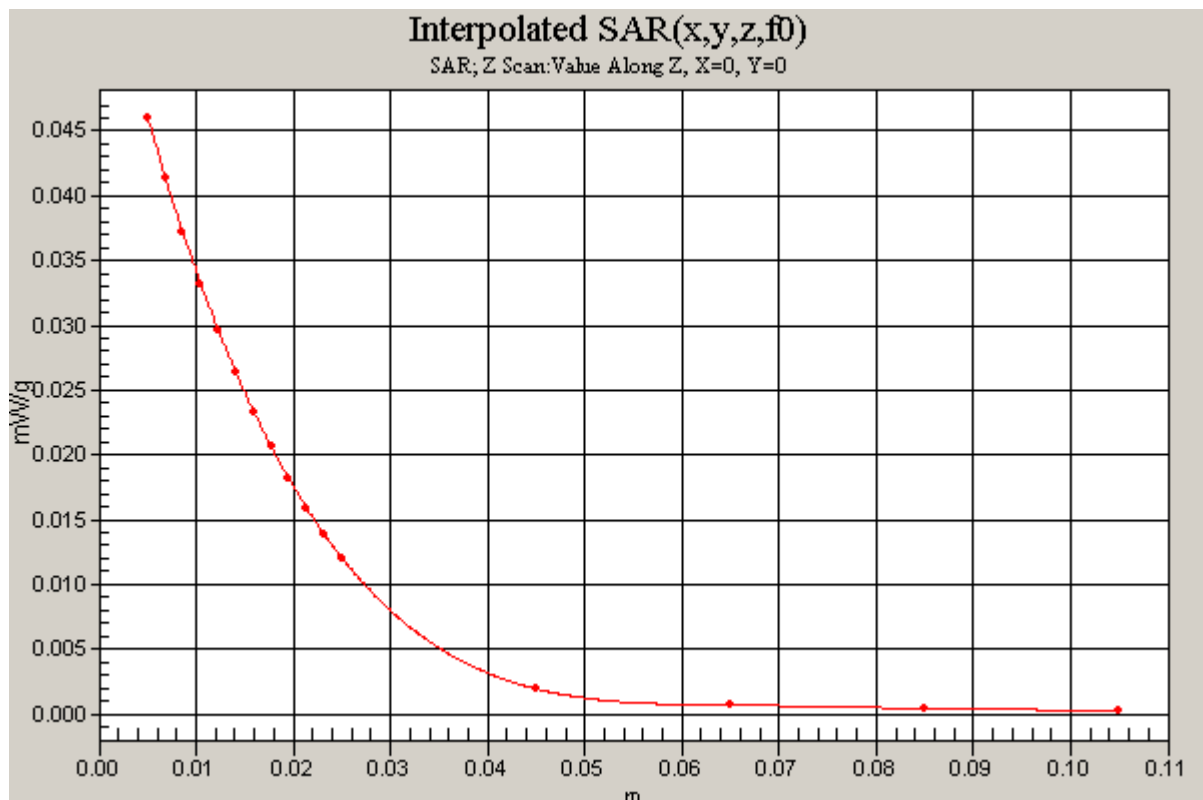

Test Laboratory: Eurofins Product Service GmbH

## FDD-II\_CH\_9263\_HSDPA\_flat\_back\_10mm

**DUT: Field controller Tornado; Type: CS 15; Serial: 022**

Communication System: UMTS Up Band II; Frequency: 1852.6 MHz; Duty Cycle: 1:1  
Medium: Muscle 1900 MHz Medium parameters used (interpolated):  $f = 1852.6$  MHz;  $\sigma = 1.52$  mho/m;  $\epsilon_r = 52$ ;  $\rho = 1000$  kg/m<sup>3</sup>  
Phantom section: Flat Section

DASY4 Configuration:

- Probe: ET3DV6 - SN1711; ConvF(4.6, 4.6, 4.6); Calibrated: 9/15/2009
- Sensor-Surface: 4mm (Mechanical And Optical Surface Detection)
- Electronics: DAE3 Sn522; Calibrated: 9/11/2009
- Phantom: Flat Phantom ELI4.0; Type: QDOVA001BB; Serial: SN:1013
- Measurement SW: DASY4, V4.7 Build 71; Postprocessing SW: SEMCAD, V1.8 Build 184

**CS 15/Area Scan (171x91x1):** Measurement grid: dx=15mm, dy=15mm  
Maximum value of SAR (interpolated) = 0.226 mW/g

**CS 15/Zoom Scan (7x7x7)/Cube 0:** Measurement grid: dx=5mm, dy=5mm, dz=5mm  
Reference Value = 7.38 V/m; Power Drift = 0.136 dB  
Peak SAR (extrapolated) = 0.359 W/kg  
**SAR(1 g) = 0.232 mW/g; SAR(10 g) = 0.150 mW/g**  
Maximum value of SAR (measured) = 0.255 mW/g

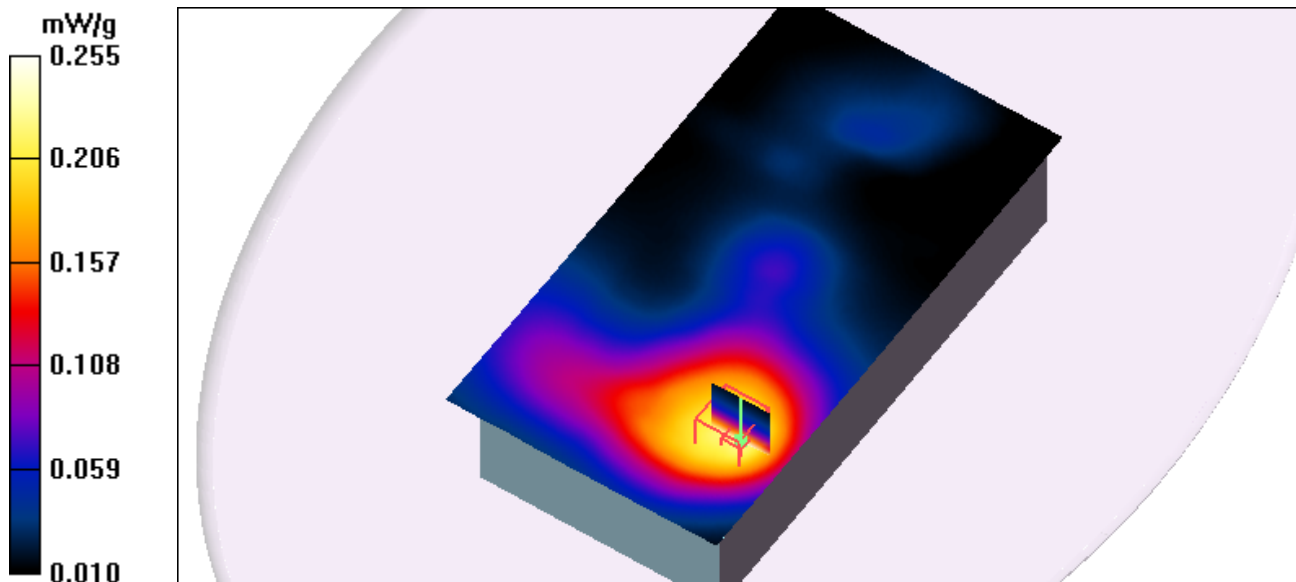



Test Laboratory: Eurofins Product Service GmbH

## FDD-II\_CH\_9400\_HSDPA\_flat\_back\_10mm

**DUT: Field controller Tornado; Type: CS 15; Serial: 022**

Communication System: UMTS Up Band II; Frequency: 1880 MHz; Duty Cycle: 1:1

Medium: Muscle 1900 MHz Medium parameters used:  $f = 1880$  MHz;  $\sigma = 1.55$  mho/m;  $\epsilon_r = 51.9$ ;  $\rho = 1000$  kg/m<sup>3</sup>

Phantom section: Flat Section

DASY4 Configuration:

- Probe: ET3DV6 - SN1711; ConvF(4.6, 4.6, 4.6); Calibrated: 9/15/2009
- Sensor-Surface: 4mm (Mechanical And Optical Surface Detection)
- Electronics: DAE3 Sn522; Calibrated: 9/11/2009
- Phantom: Flat Phantom ELI4.0; Type: QDOVA001BB; Serial: SN:1013
- Measurement SW: DASY4, V4.7 Build 71; Postprocessing SW: SEMCAD, V1.8 Build 184

**CS 15/Area Scan (171x91x1):** Measurement grid: dx=15mm, dy=15mm

Maximum value of SAR (interpolated) = 0.341 mW/g

**CS 15/Zoom Scan (7x7x7)/Cube 0:** Measurement grid: dx=5mm, dy=5mm, dz=5mm

Reference Value = 9.20 V/m; Power Drift = -0.051 dB

Peak SAR (extrapolated) = 0.442 W/kg

**SAR(1 g) = 0.306 mW/g; SAR(10 g) = 0.200 mW/g**

Maximum value of SAR (measured) = 0.331 mW/g

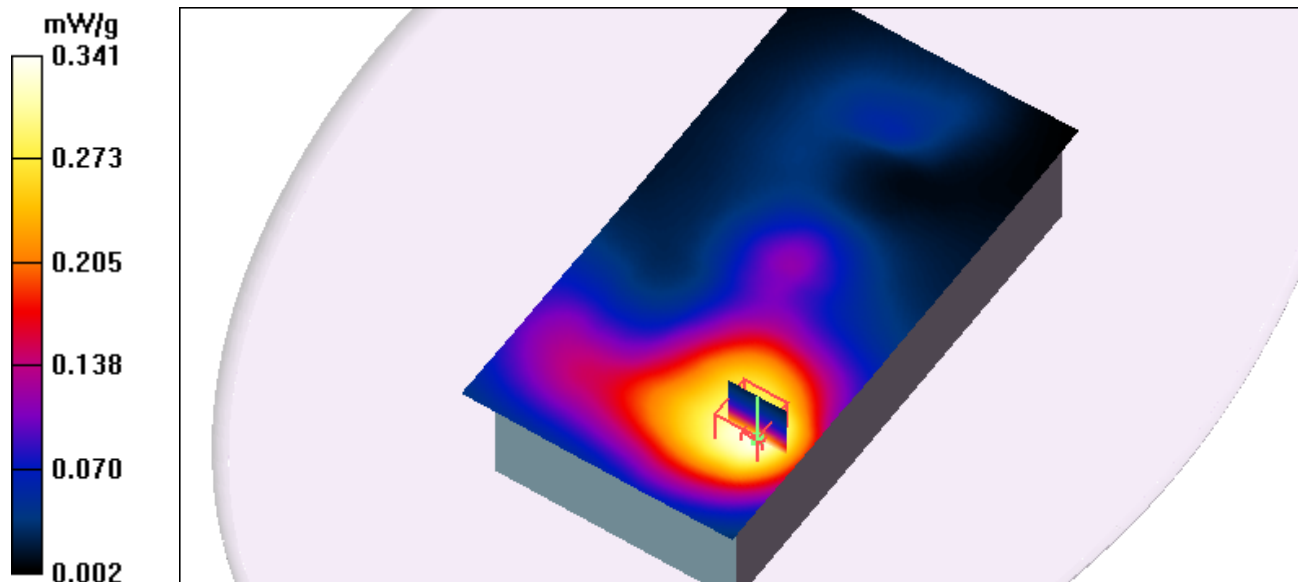

Test Laboratory: Eurofins Product Service GmbH

## FDD-II\_CH\_9400\_HSDPA\_flat\_front\_10mm

**DUT: Field controller Tornado; Type: CS 15; Serial: 022**

Communication System: UMTS Up Band II; Frequency: 1880 MHz; Duty Cycle: 1:1

Medium: Muscle 1900 MHz Medium parameters used:  $f = 1880$  MHz;  $\sigma = 1.55$  mho/m;  $\epsilon_r = 51.9$ ;  $\rho = 1000$  kg/m<sup>3</sup>

Phantom section: Flat Section

DASY4 Configuration:

- Probe: ET3DV6 - SN1711; ConvF(4.6, 4.6, 4.6); Calibrated: 9/15/2009
- Sensor-Surface: 4mm (Mechanical And Optical Surface Detection)
- Electronics: DAE3 Sn522; Calibrated: 9/11/2009
- Phantom: Flat Phantom ELI4.0; Type: QDOVA001BB; Serial: SN:1013
- Measurement SW: DASY4, V4.7 Build 71; Postprocessing SW: SEMCAD, V1.8 Build 184

**CS 15/Area Scan (171x91x1):** Measurement grid: dx=15mm, dy=15mm

Maximum value of SAR (interpolated) = 0.252 mW/g

**CS 15/Zoom Scan (7x7x7)/Cube 0:** Measurement grid: dx=5mm, dy=5mm, dz=5mm

Reference Value = 3.54 V/m; Power Drift = 0.130 dB

Peak SAR (extrapolated) = 0.333 W/kg

**SAR(1 g) = 0.247 mW/g; SAR(10 g) = 0.159 mW/g**

Maximum value of SAR (measured) = 0.275 mW/g

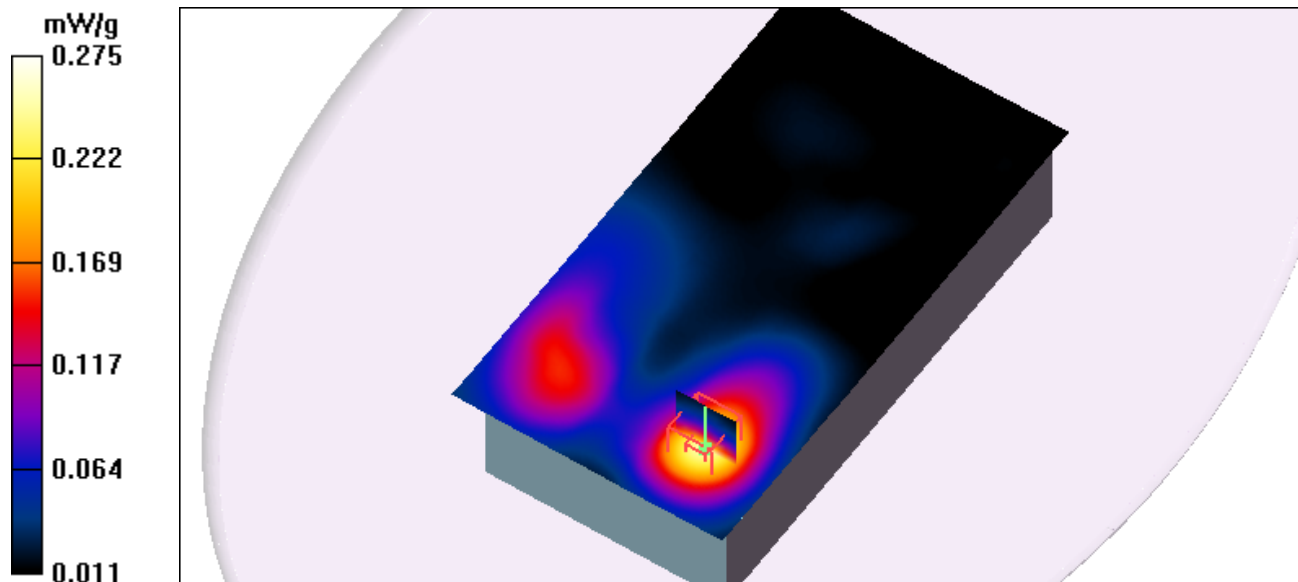

Test Laboratory: Eurofins Product Service GmbH

## FDD-II\_CH\_9537\_HSDPA\_flat\_back\_10mm

**DUT: Field controller Tornado; Type: CS 15; Serial: 022**

Communication System: UMTS Up Band II; Frequency: 1907.4 MHz; Duty Cycle: 1:1  
Medium: Muscle 1900 MHz Medium parameters used (interpolated):  $f = 1907.4$  MHz;  $\sigma = 1.57$  mho/m;  $\epsilon_r = 51.9$ ;  $\rho = 1000$  kg/m<sup>3</sup>  
Phantom section: Flat Section

DASY4 Configuration:

- Probe: ET3DV6 - SN1711; ConvF(4.6, 4.6, 4.6); Calibrated: 9/15/2009
- Sensor-Surface: 4mm (Mechanical And Optical Surface Detection)
- Electronics: DAE3 Sn522; Calibrated: 9/11/2009
- Phantom: Flat Phantom ELI4.0; Type: QDOVA001BB; Serial: SN:1013
- Measurement SW: DASY4, V4.7 Build 71; Postprocessing SW: SEMCAD, V1.8 Build 184

**CS 15/Area Scan (171x91x1):** Measurement grid: dx=15mm, dy=15mm  
Maximum value of SAR (interpolated) = 0.261 mW/g

**CS 15/Zoom Scan (7x7x7)/Cube 0:** Measurement grid: dx=5mm, dy=5mm, dz=5mm  
Reference Value = 8.89 V/m; Power Drift = -0.137 dB  
Peak SAR (extrapolated) = 0.309 W/kg  
**SAR(1 g) = 0.207 mW/g; SAR(10 g) = 0.132 mW/g**  
Maximum value of SAR (measured) = 0.224 mW/g

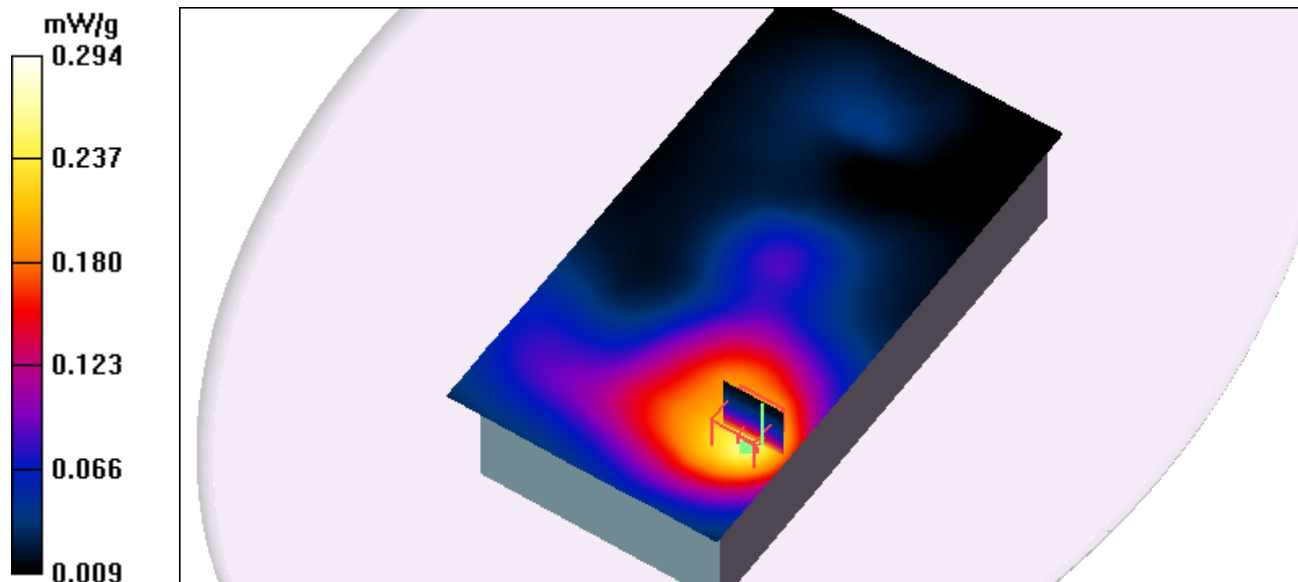

Test Laboratory: Eurofins Product Service GmbH

## Z - axis scan

**DUT: Field controller Tornado; Type: CS 15; Serial: 022**

Communication System: UMTS Up Band II; Frequency: 1880 MHz; Duty Cycle: 1:1

Medium: Muscle 1900 MHz Medium parameters used:  $f = 1880$  MHz;  $\sigma = 1.55$  mho/m;  $\epsilon_r = 51.9$ ;  $\rho = 1000$  kg/m<sup>3</sup>

Phantom section: Flat Section

DASY4 Configuration:

- Probe: ET3DV6 - SN1711; ConvF(4.6, 4.6, 4.6); Calibrated: 9/15/2009
- Sensor-Surface: 0mm (Fix Surface)
- Electronics: DAE3 Sn522; Calibrated: 9/11/2009
- Phantom: Flat Phantom ELI4.0; Type: QDOVA001BB; Serial: SN:1013
- Measurement SW: DASY4, V4.7 Build 71; Postprocessing SW: SEMCAD, V1.8 Build 184

**CS 15/Z Scan (1x1x16):** Measurement grid: dx=20mm, dy=20mm, dz=20mm

Maximum value of SAR (interpolated) = 0.056 mW/g

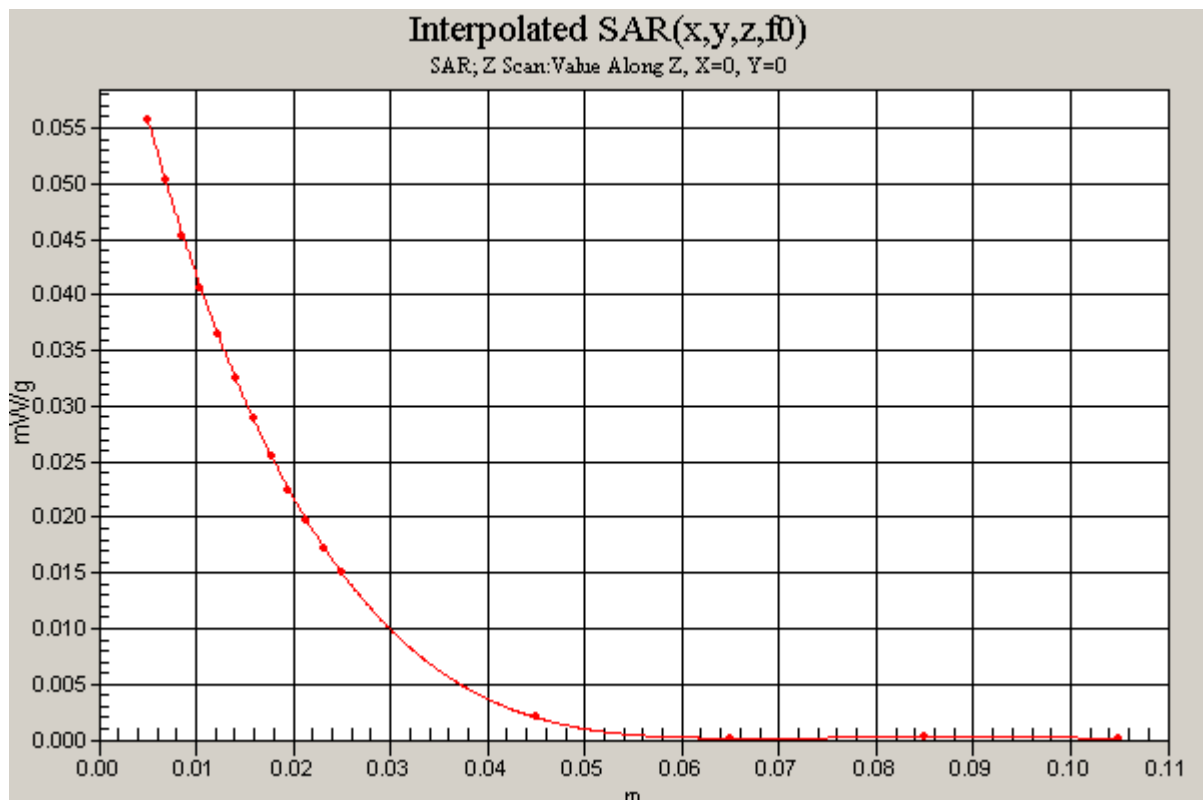

Test Laboratory: Eurofins Product Service GmbH

### FDD-V\_CH\_4133\_HSDPA\_flat\_back\_10mm

**DUT: Field controller Tornado; Type: CS 15; Serial: 022**

Communication System: UMTS Up Band V; Frequency: 826.6 MHz; Duty Cycle: 1:1

Medium: Muscle 900 MHz Medium parameters used:  $f = 826.6 \text{ MHz}$ ;  $\sigma = 0.929 \text{ mho/m}$ ;  $\epsilon_r = 54.8$ ;  $\rho = 1000 \text{ kg/m}^3$

Phantom section: Flat Section

DASY4 Configuration:

- Probe: ET3DV6 - SN1711; ConvF(5.85, 5.85, 5.85); Calibrated: 9/15/2009
- Sensor-Surface: 4mm (Mechanical And Optical Surface Detection)
- Electronics: DAE3 Sn522; Calibrated: 9/11/2009
- Phantom: Flat Phantom ELI4.0; Type: QDOVA001BB; Serial: SN:1013
- Measurement SW: DASY4, V4.7 Build 71; Postprocessing SW: SEMCAD, V1.8 Build 184

**CS 15/Area Scan (171x91x1):** Measurement grid:  $dx=15\text{mm}$ ,  $dy=15\text{mm}$

Maximum value of SAR (interpolated) = 0.228 mW/g

**CS 15/Zoom Scan (7x7x7)/Cube 0:** Measurement grid:  $dx=5\text{mm}$ ,  $dy=5\text{mm}$ ,  $dz=5\text{mm}$

Reference Value = 8.26 V/m; Power Drift = 0.123 dB

Peak SAR (extrapolated) = 0.266 W/kg

**SAR(1 g) = 0.210 mW/g; SAR(10 g) = 0.157 mW/g**

Maximum value of SAR (measured) = 0.222 mW/g

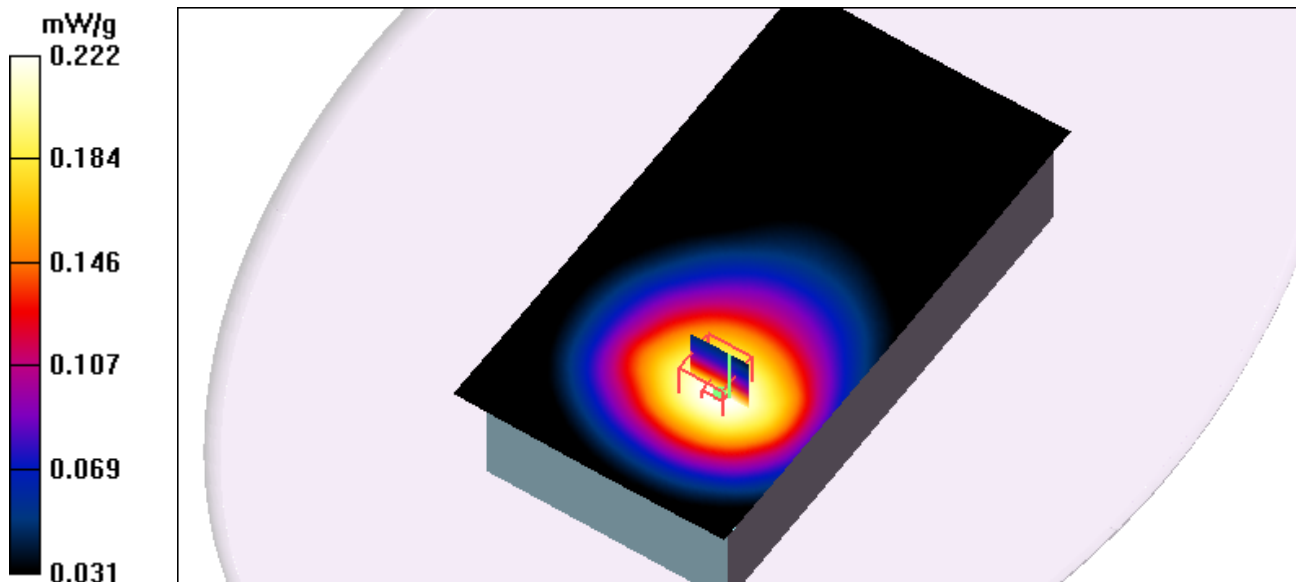

Test Laboratory: Eurofins Product Service GmbH

### FDD-V\_CH\_4133\_HSDPA\_flat\_front\_10mm

**DUT: Field controller Tornado; Type: CS 15; Serial: 022**

Communication System: UMTS Up Band V; Frequency: 826.6 MHz; Duty Cycle: 1:1

Medium: Muscle 900 MHz Medium parameters used:  $f = 826.6 \text{ MHz}$ ;  $\sigma = 0.929 \text{ mho/m}$ ;  $\epsilon_r = 54.8$ ;  $\rho = 1000 \text{ kg/m}^3$

Phantom section: Flat Section

DASY4 Configuration:

- Probe: ET3DV6 - SN1711; ConvF(5.85, 5.85, 5.85); Calibrated: 9/15/2009
- Sensor-Surface: 4mm (Mechanical And Optical Surface Detection)
- Electronics: DAE3 Sn522; Calibrated: 9/11/2009
- Phantom: Flat Phantom ELI4.0; Type: QDOVA001BB; Serial: SN:1013
- Measurement SW: DASY4, V4.7 Build 71; Postprocessing SW: SEMCAD, V1.8 Build 184

**CS 15/Area Scan (171x91x1):** Measurement grid:  $dx=15\text{mm}$ ,  $dy=15\text{mm}$

Maximum value of SAR (interpolated) = 0.267 mW/g

**CS 15/Zoom Scan (7x7x7)/Cube 0:** Measurement grid:  $dx=5\text{mm}$ ,  $dy=5\text{mm}$ ,  $dz=5\text{mm}$

Reference Value = 8.47 V/m; Power Drift = 0.086 dB

Peak SAR (extrapolated) = 0.312 W/kg

**SAR(1 g) = 0.248 mW/g; SAR(10 g) = 0.188 mW/g**

Maximum value of SAR (measured) = 0.269 mW/g

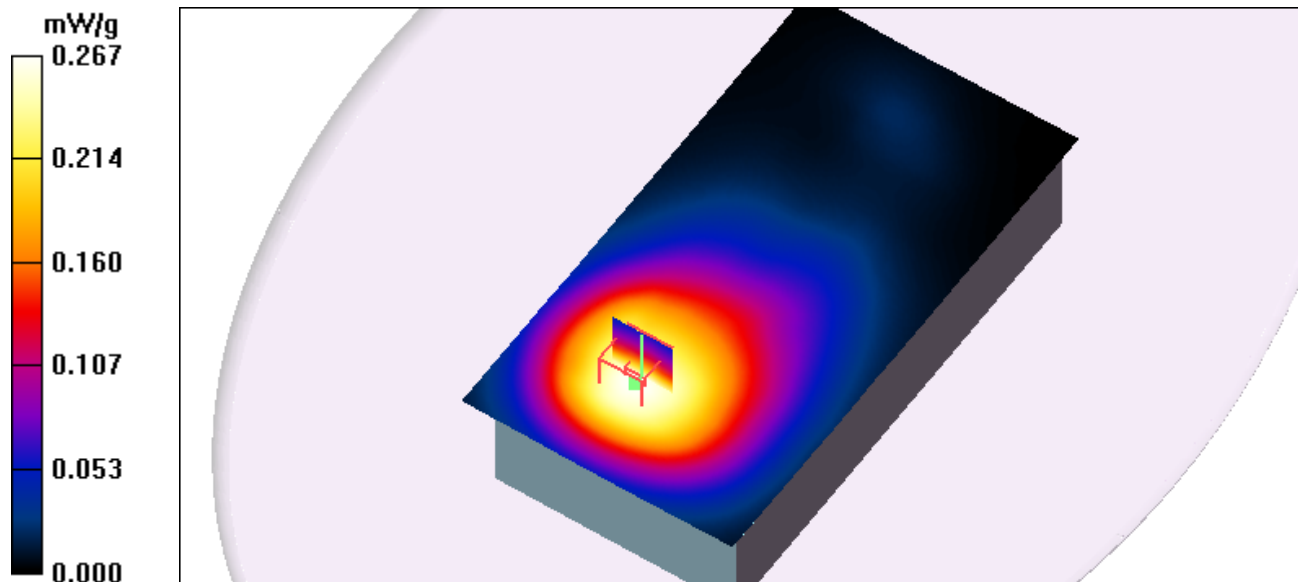

Test Laboratory: Eurofins Product Service GmbH

### FDD-V\_CH\_4175\_HSDPA\_flat\_back\_10mm

**DUT: Field controller Tornado; Type: CS 15; Serial: 022**

Communication System: UMTS Up Band V; Frequency: 835 MHz; Duty Cycle: 1:1

Medium: Muscle 900 MHz Medium parameters used:  $f = 835 \text{ MHz}$ ;  $\sigma = 0.931 \text{ mho/m}$ ;  $\epsilon_r = 54.8$ ;  $\rho = 1000 \text{ kg/m}^3$

Phantom section: Flat Section

DASY4 Configuration:

- Probe: ET3DV6 - SN1711; ConvF(5.85, 5.85, 5.85); Calibrated: 9/15/2009
- Sensor-Surface: 4mm (Mechanical And Optical Surface Detection)
- Electronics: DAE3 Sn522; Calibrated: 9/11/2009
- Phantom: Flat Phantom ELI4.0; Type: QDOVA001BB; Serial: SN:1013
- Measurement SW: DASY4, V4.7 Build 71; Postprocessing SW: SEMCAD, V1.8 Build 184

**CS 15/Area Scan (171x91x1):** Measurement grid:  $dx=15\text{mm}$ ,  $dy=15\text{mm}$

Maximum value of SAR (interpolated) =  $0.212 \text{ mW/g}$

**CS 15/Zoom Scan (7x7x7)/Cube 0:** Measurement grid:  $dx=5\text{mm}$ ,  $dy=5\text{mm}$ ,  $dz=5\text{mm}$

Reference Value =  $8.06 \text{ V/m}$ ; Power Drift =  $-0.167 \text{ dB}$

Peak SAR (extrapolated) =  $0.235 \text{ W/kg}$

**SAR(1 g) =  $0.189 \text{ mW/g}$ ; SAR(10 g) =  $0.142 \text{ mW/g}$**

Maximum value of SAR (measured) =  $0.198 \text{ mW/g}$

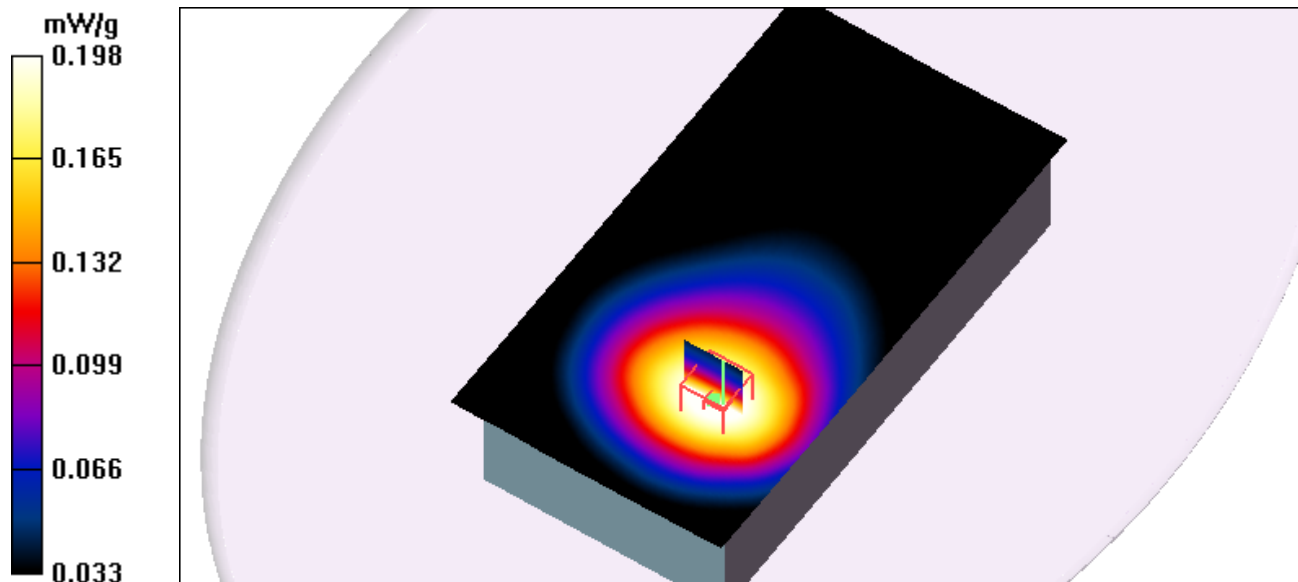

Test Laboratory: Eurofins Product Service GmbH

### FDD-V\_CH\_4175\_HSDPA\_flat\_front\_10mm

**DUT: Field controller Tornado; Type: CS 15; Serial: 022**

Communication System: UMTS Up Band V; Frequency: 835 MHz; Duty Cycle: 1:1

Medium: Muscle 900 MHz Medium parameters used:  $f = 835 \text{ MHz}$ ;  $\sigma = 0.931 \text{ mho/m}$ ;  $\epsilon_r = 54.8$ ;  $\rho = 1000 \text{ kg/m}^3$

Phantom section: Flat Section

DASY4 Configuration:

- Probe: ET3DV6 - SN1711; ConvF(5.85, 5.85, 5.85); Calibrated: 9/15/2009
- Sensor-Surface: 4mm (Mechanical And Optical Surface Detection)
- Electronics: DAE3 Sn522; Calibrated: 9/11/2009
- Phantom: Flat Phantom ELI4.0; Type: QDOVA001BB; Serial: SN:1013
- Measurement SW: DASY4, V4.7 Build 71; Postprocessing SW: SEMCAD, V1.8 Build 184

**CS 15/Area Scan (171x91x1):** Measurement grid:  $dx=15\text{mm}$ ,  $dy=15\text{mm}$

Maximum value of SAR (interpolated) = 0.240 mW/g

**CS 15/Zoom Scan (7x7x7)/Cube 0:** Measurement grid:  $dx=5\text{mm}$ ,  $dy=5\text{mm}$ ,  $dz=5\text{mm}$

Reference Value = 8.06 V/m; Power Drift = 0.041 dB

Peak SAR (extrapolated) = 0.278 W/kg

**SAR(1 g) = 0.227 mW/g; SAR(10 g) = 0.173 mW/g**

Maximum value of SAR (measured) = 0.240 mW/g

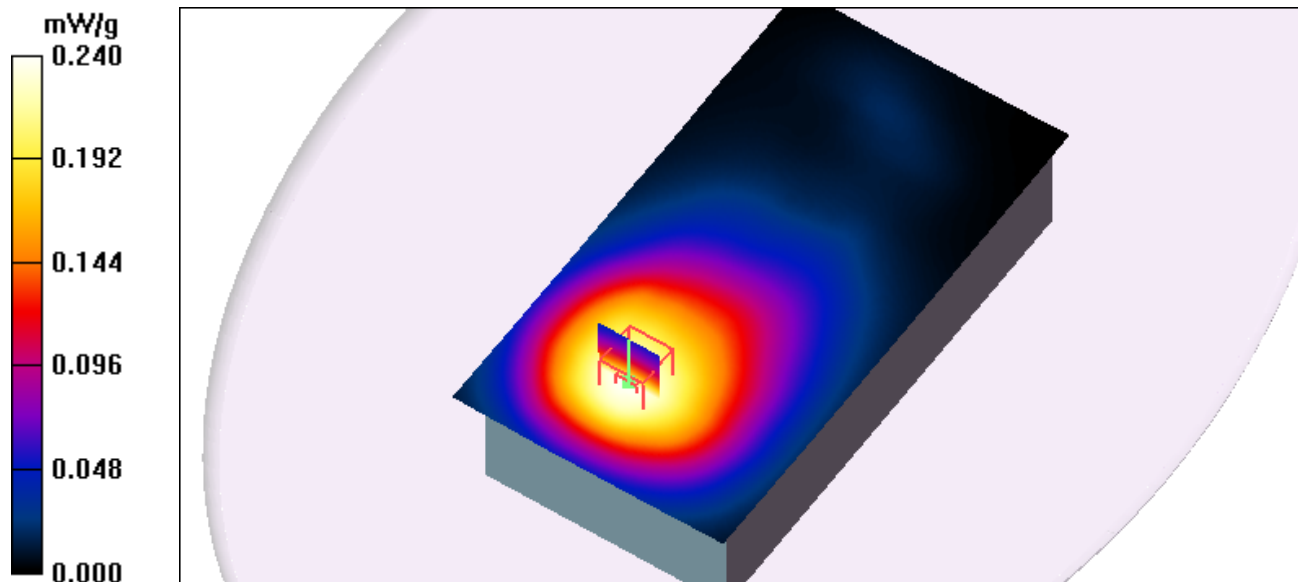



Test Laboratory: Eurofins Product Service GmbH

### FDD-V\_CH\_4232\_HSDPA\_flat\_back\_10mm

**DUT: Field controller Tornado; Type: CS 15; Serial: 022**

Communication System: UMTS Up Band V; Frequency: 846.4 MHz; Duty Cycle: 1:1

Medium: Muscle 900 MHz Medium parameters used:  $f = 846.4 \text{ MHz}$ ;  $\sigma = 0.942 \text{ mho/m}$ ;  $\epsilon_r = 54.8$ ;  $\rho = 1000 \text{ kg/m}^3$

Phantom section: Flat Section

DASY4 Configuration:

- Probe: ET3DV6 - SN1711; ConvF(5.85, 5.85, 5.85); Calibrated: 9/15/2009
- Sensor-Surface: 4mm (Mechanical And Optical Surface Detection)
- Electronics: DAE3 Sn522; Calibrated: 9/11/2009
- Phantom: Flat Phantom ELI4.0; Type: QDOVA001BB; Serial: SN:1013
- Measurement SW: DASY4, V4.7 Build 71; Postprocessing SW: SEMCAD, V1.8 Build 184

**CS 15/Area Scan (171x91x1):** Measurement grid:  $dx=15\text{mm}$ ,  $dy=15\text{mm}$

Maximum value of SAR (interpolated) = 0.183 mW/g

**CS 15/Zoom Scan (7x7x7)/Cube 0:** Measurement grid:  $dx=5\text{mm}$ ,  $dy=5\text{mm}$ ,  $dz=5\text{mm}$

Reference Value = 7.53 V/m; Power Drift = 0.159 dB

Peak SAR (extrapolated) = 0.214 W/kg

**SAR(1 g) = 0.173 mW/g; SAR(10 g) = 0.130 mW/g**

Maximum value of SAR (measured) = 0.184 mW/g

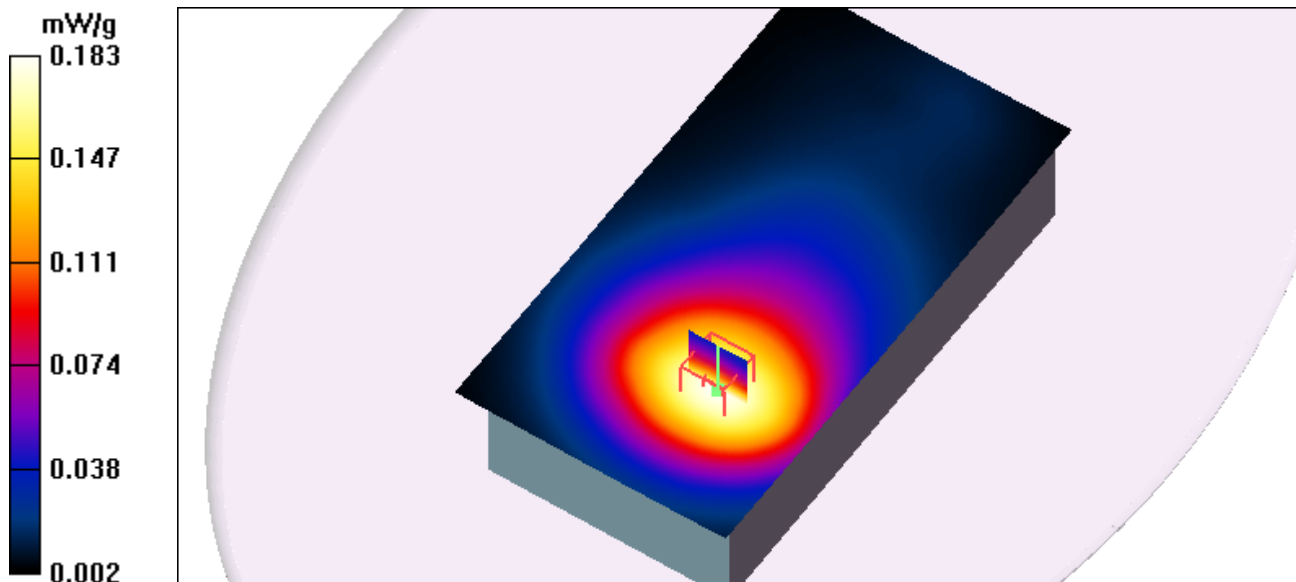

Test Laboratory: Eurofins Product Service GmbH

### FDD-V\_CH\_4232\_HSDPA\_flat\_front\_10mm

**DUT: Field controller Tornado; Type: CS 15; Serial: 022**

Communication System: UMTS Up Band V; Frequency: 846.4 MHz; Duty Cycle: 1:1

Medium: Muscle 900 MHz Medium parameters used:  $f = 846.4$  MHz;  $\sigma = 0.942$  mho/m;  $\epsilon_r = 54.8$ ;  $\rho = 1000$  kg/m<sup>3</sup>

Phantom section: Flat Section

DASY4 Configuration:

- Probe: ET3DV6 - SN1711; ConvF(5.85, 5.85, 5.85); Calibrated: 9/15/2009
- Sensor-Surface: 4mm (Mechanical And Optical Surface Detection)
- Electronics: DAE3 Sn522; Calibrated: 9/11/2009
- Phantom: Flat Phantom ELI4.0; Type: QDOVA001BB; Serial: SN:1013
- Measurement SW: DASY4, V4.7 Build 71; Postprocessing SW: SEMCAD, V1.8 Build 184

**CS 15/Area Scan (171x91x1):** Measurement grid: dx=15mm, dy=15mm

Maximum value of SAR (interpolated) = 0.211 mW/g

**CS 15/Zoom Scan (7x7x7)/Cube 0:** Measurement grid: dx=5mm, dy=5mm, dz=5mm

Reference Value = 8.02 V/m; Power Drift = 0.146 dB

Peak SAR (extrapolated) = 0.261 W/kg

**SAR(1 g) = 0.209 mW/g; SAR(10 g) = 0.157 mW/g**

Maximum value of SAR (measured) = 0.220 mW/g

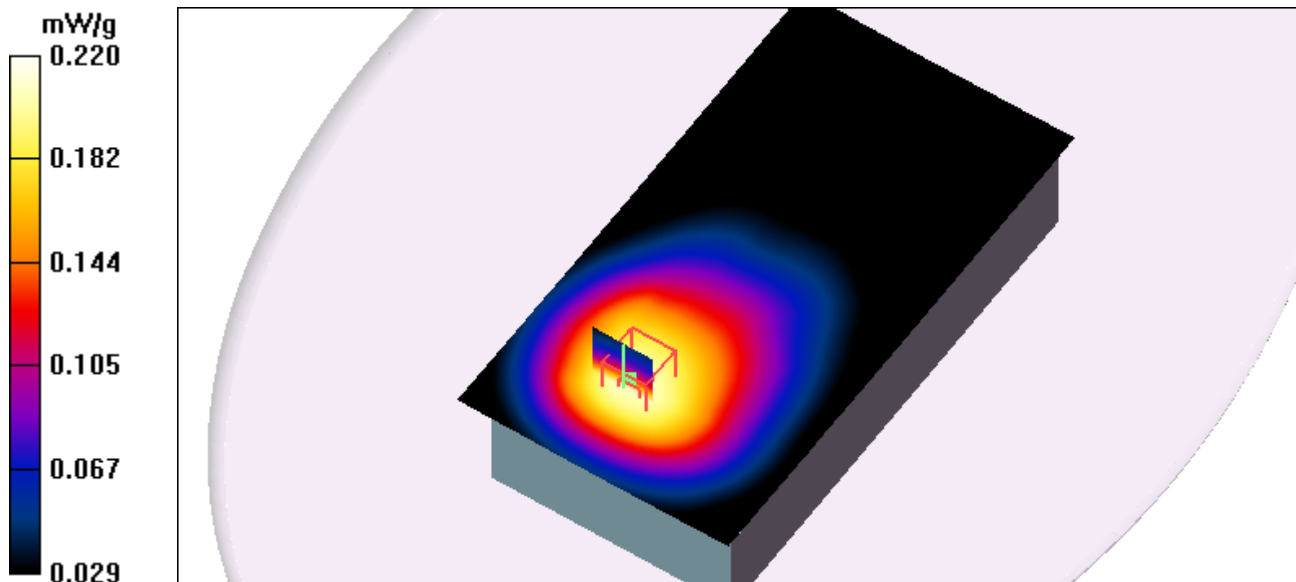

Test Laboratory: Eurofins Product Service GmbH

## Z - axis scan

**DUT: Field controller Tornado; Type: CS 15; Serial: 022**

Communication System: UMTS Up Band V; Frequency: 826.6 MHz; Duty Cycle: 1:1

Medium: Muscle 900 MHz Medium parameters used:  $f = 826.6$  MHz;  $\sigma = 0.929$  mho/m;  $\epsilon_r = 54.8$ ;  $\rho = 1000$  kg/m<sup>3</sup>

Phantom section: Flat Section

DASY4 Configuration:

- Probe: ET3DV6 - SN1711; ConvF(5.85, 5.85, 5.85); Calibrated: 9/15/2009
- Sensor-Surface: 0mm (Fix Surface)
- Electronics: DAE3 Sn522; Calibrated: 9/11/2009
- Phantom: Flat Phantom ELI4.0; Type: QDOVA001BB; Serial: SN:1013
- Measurement SW: DASY4, V4.7 Build 71; Postprocessing SW: SEMCAD, V1.8 Build 184

**CS 15/Z Scan (1x1x16):** Measurement grid: dx=20mm, dy=20mm, dz=20mm

Maximum value of SAR (interpolated) = 0.048 mW/g

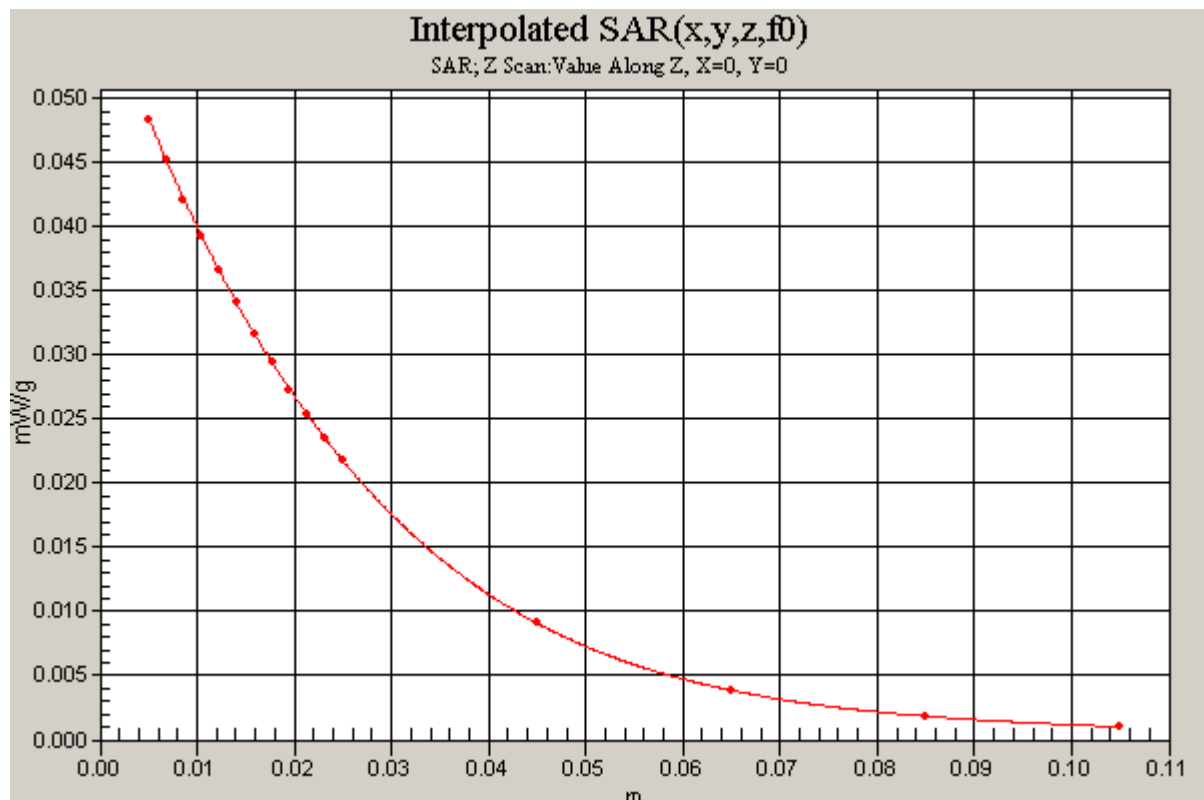

Test Laboratory: Eurofins Product Service GmbH

**Dipol Valid.2450 (m)\_250mW\_ELI 4 25.08.2010**

**DUT: Dipole 2450 MHz; Type: D2450V2; Serial: 722**

Communication System: CW; Frequency: 2450 MHz; Duty Cycle: 1:1

Medium: Muscle 2450 MHz Medium parameters used :  $f = 2450$  MHz;  $\sigma = 2.03$  mho/m;  $\epsilon_r = 52.9$ ;  $\rho = 1000$  kg/m<sup>3</sup>

Phantom section: Flat Section

DASY4 Configuration:

- Probe: ET3DV6 - SN1711; ConvF(4.07, 4.07, 4.07); Calibrated: 9/15/2009
- Sensor-Surface: 4mm (Mechanical And Optical Surface Detection)
- Electronics: DAE3 Sn522; Calibrated: 9/11/2009
- Phantom: Flat Phantom ELI4.0; Type: QDOVA001BB; Serial: SN:1013
- Measurement SW: DASY4, V4.7 Build 71; Postprocessing SW: SEMCAD, V1.8 Build 184

**Dipol 2450 (250mW)/Area Scan (61x101x1):** Measurement grid: dx=10mm, dy=10mm  
Maximum value of SAR (interpolated) = 15.5 mW/g

**Dipol 2450 (250mW)/Zoom Scan (7x7x7)/Cube 0:** Measurement grid: dx=5mm, dy=5mm, dz=5mm

Reference Value = 84.0 V/m; Power Drift = -0.025 dB

Peak SAR (extrapolated) = 33.6 W/kg

**SAR(1 g) = 13.6 mW/g; SAR(10 g) = 6.13 mW/g**

Maximum value of SAR (measured) = 14.8 mW/g

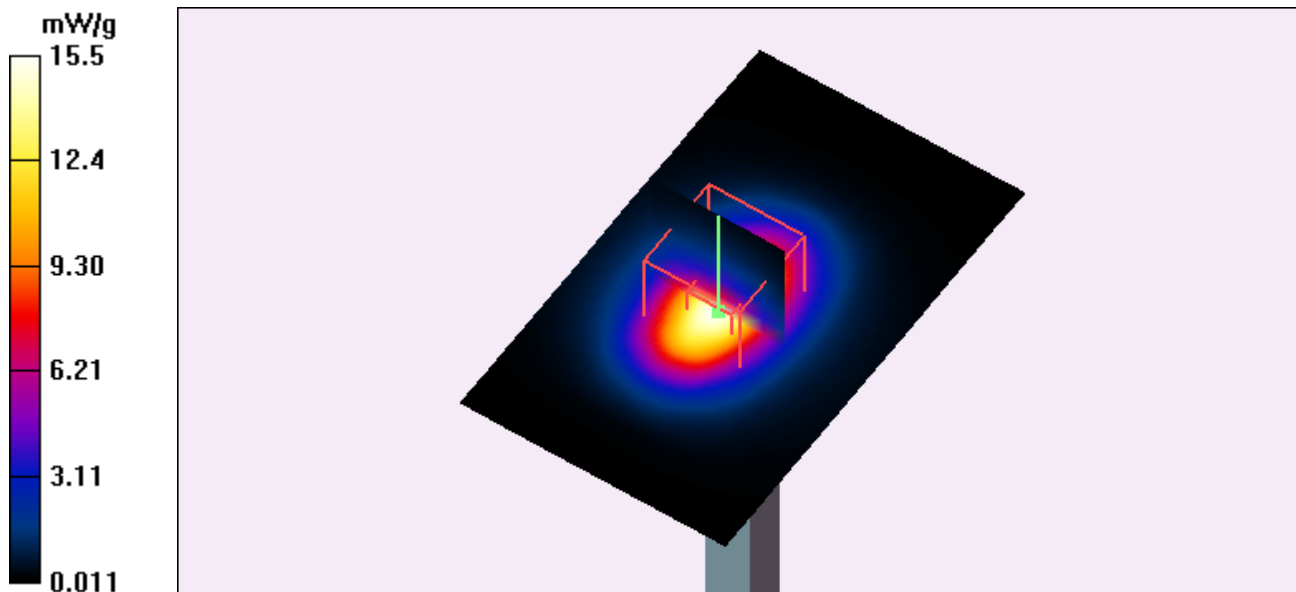

Test Laboratory: Eurofins Product Service GmbH

## Wlan\_Ch 6\_OFDM\_6Mbs\_Flat\_Back\_10mm

**DUT: Field controller; Type: CS15; Serial: 022**

Communication System: WLAN 2450; Frequency: 2437 MHz; Duty Cycle: 1:1

Medium: Muscle 2450 MHz Medium parameters used:  $f = 2437$  MHz;  $\sigma = 2.03$  mho/m;  $\epsilon_r = 52.9$ ;  $\rho = 1000$  kg/m<sup>3</sup>

Phantom section: Flat Section

DASY4 Configuration:

- Probe: ET3DV6 - SN1711; ConvF(4.07, 4.07, 4.07); Calibrated: 9/15/2009
- Sensor-Surface: 4mm (Mechanical And Optical Surface Detection)
- Electronics: DAE3 Sn522; Calibrated: 9/11/2009
- Phantom: Flat Phantom ELI4.0; Type: QDOVA001BB; Serial: SN:1013
- Measurement SW: DASY4, V4.7 Build 71; Postprocessing SW: SEMCAD, V1.8 Build 184

**CS15/Area Scan (131x81x1):** Measurement grid: dx=20mm, dy=20mm

Maximum value of SAR (interpolated) = 0.173 mW/g

**CS15/Zoom Scan (7x7x7)/Cube 0:** Measurement grid: dx=5mm, dy=5mm, dz=5mm

Reference Value = 2.84 V/m; Power Drift = -0.185 dB

Peak SAR (extrapolated) = 0.333 W/kg

**SAR(1 g) = 0.162 mW/g; SAR(10 g) = 0.090 mW/g**

Maximum value of SAR (measured) = 0.171 mW/g

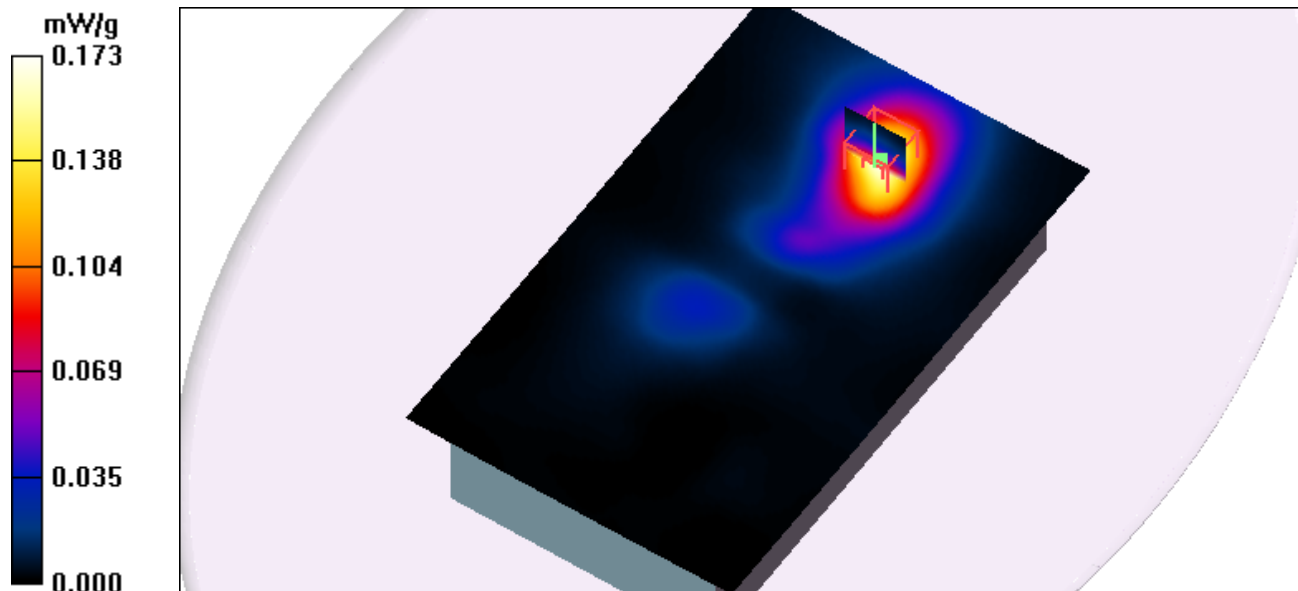

Test Laboratory: Eurofins Product Service GmbH

## Wlan\_Ch 6\_OFDM\_6Mbs\_Flat\_Front\_10mm

**DUT: Field controller; Type: CS15; Serial: 022**

Communication System: WLAN 2450; Frequency: 2437 MHz; Duty Cycle: 1:1

Medium: Muscle 2450 MHz Medium parameters used:  $f = 2437$  MHz;  $\sigma = 2.03$  mho/m;  $\epsilon_r = 52.9$ ;  $\rho = 1000$  kg/m<sup>3</sup>

Phantom section: Flat Section

DASY4 Configuration:

- Probe: ET3DV6 - SN1711; ConvF(4.07, 4.07, 4.07); Calibrated: 9/15/2009
- Sensor-Surface: 4mm (Mechanical And Optical Surface Detection)
- Electronics: DAE3 Sn522; Calibrated: 9/11/2009
- Phantom: Flat Phantom ELI4.0; Type: QDOVA001BB; Serial: SN:1013
- Measurement SW: DASY4, V4.7 Build 71; Postprocessing SW: SEMCAD, V1.8 Build 184

**CS15/Area Scan (131x81x1):** Measurement grid: dx=20mm, dy=20mm

Maximum value of SAR (interpolated) = 0.007 mW/g

**CS15/Zoom Scan (7x7x7)/Cube 0:** Measurement grid: dx=5mm, dy=5mm, dz=5mm

Reference Value = 0.593 V/m; Power Drift = -0.132 dB

Peak SAR (extrapolated) = 0.014 W/kg

**SAR(1 g) = 0.00337 mW/g; SAR(10 g) = 0.00145 mW/g**

Maximum value of SAR (measured) = 0.004 mW/g

