

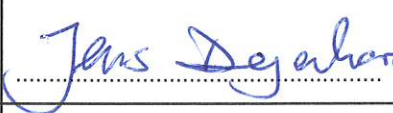
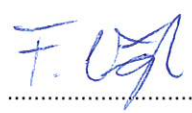

<b>FCC TEST REPORT</b>	
<b>Co-Location</b>	
<b>Report Reference No</b>	G0M-2108-9972-TFCCOLOC-V02
<b>Testing Laboratory</b>	Eurofins Product Service GmbH
<b>Address</b>	Storkower Str. 38c 15526 Reichenwalde Germany
<b>Accreditation</b>	    <p>                     DAkks - Registration number : D-PL-12092-01-03 (ISED)                      ISED Testing Laboratory site: 3470A                      DAkks - Registration number : D-PL-12092-01-04 (FCC)                      FCC Filed Test Laboratory, Reg.-No.: 96970                 </p>
<b>Applicant</b>	Leica Geosystems AG
<b>Address</b>	Heinrich-Wild-Strasse 9435 Heerbrugg SWITZERLAND
<b>Test Specification</b>	47 CFR Part 15.407 47 CFR Part 15.247 RSS-247, Issue 2, 2017-02
<b>Non-Standard Test Method</b>	None
<b>Equipment under Test (EUT):</b>	
<b>Product Description</b>	Imaging Laser Scanner
<b>Model(s)</b>	BLK360 G2
<b>Additional Model(s)</b>	None
<b>Brand Name(s)</b>	Leica
<b>Hardware Version(s)</b>	918900_B BLK360 G2 Scanner
<b>Software Version(s)</b>	0.1.7-cert
<b>FCC ID</b>	RFD-BLK360G2
<b>IC</b>	3177A-BLK360G2
<b>Test Result</b>	<b>PASSED</b>

<b>Possible test case verdicts:</b>		
Required by standard but not tested	N/T	
Not required by standard	N/R	
Not applicable to EUT	N/A	
Test object does meet the requirement	P(PASS)	
Test object does not meet the requirement	F(FAIL)	
<b>Testing:</b>		
Test Lab Temperature	20 °C - 30 °C	
Test Lab Humidity	25 % - 55 %	
Date of receipt of test item	2021-10-04	
<b>Report:</b>		
Compiled by	Wilfried Treffke	
Tested by (+ signature)	Jens Degenhardt	
Supervised by (+ signature) (Responsible for Test)	Florian Voigt	
Approved by (+ signature) (Deputy Head of Lab)	Toralf Jahn	
Date of Issue	2021-12-09	
Total number of pages	39	
<b>General Remarks:</b>		
<p>The test results presented in this report relate only to the object tested.</p> <p>The results contained in this report reflect the results for this particular model and serial number. It is the responsibility of the manufacturer to ensure that all production models meet the intent of the requirements detailed within this report.</p> <p>This report shall not be reproduced, except in full, without the written approval of the Issuing testing laboratory.</p>		
<b>Additional Comments:</b>		

**VERSION HISTORY**

Version History			
Version	Issue Date	Remarks	Revised By
01	2021-11-09	Initial Release	
02	2021-12-09	New radio module applicable	W. Treffke

**ABBREVIATIONS AND ACRONYMS**

Acronyms	
Acronym	Description
EUT	Equipment Under Test
FCC	Federal Communications Commission
ISED	Innovation, Science and Economic Development Canada
RBW	Resolution bandwidth
RMS	Root mean square
VBW	Video bandwidth
V <sub>NOM</sub>	Nominal supply voltage

**REPORT INDEX**

<b>1</b>	<b>Equipment (Test Item) Under Test</b> .....	<b>6</b>
1.1	Photos – Equipment External.....	7
1.2	Photos – Equipment Internal.....	9
1.3	Photos – Test Setup.....	14
1.4	Support Equipment.....	17
1.5	Test Modes.....	18
1.6	Test Frequencies.....	19
1.7	Sample emission level calculation.....	20
<b>2</b>	<b>Result Summary</b> .....	<b>21</b>
<b>3</b>	<b>Test Conditions and Results</b> .....	<b>22</b>
3.1	Test Conditions and Results - Transmitter radiated emissions.....	22
ANNEX A	Transmitter spurious emissions WiFi 2.4 + BT.....	25
ANNEX B	Transmitter spurious emissions WiFi 5 + BT.....	33

## 1 Equipment (Test Item) Under Test

Description	Imaging Laser Scanner	
Model	BLK360 G2	
Additional Model(s)	None	
Brand Name(s)	Leica	
Serial Number(s)	2060092	
Test Sample Id(s)	36490	
Hardware Version(s)	918900_B BLK360 G2 Scanner	
Software Version(s)	0.1.7-cert	
PMN	BLK360 G2	
HVIN	BLK360 G2	
FVIN	0.1.7-cert	
HMN	n/a	
FCC ID	RFD-BLK360G2	
IC	3177A-BLK360G2	
Equipment type	End Product	
Radio type	Transceiver	
Assigned frequency bands	5150 - 5250 MHz, 5250 - 5350 MHz, 5470 - 5725 MHz 2400 – 2480 MHz	
Radio technologies	IEEE802.11 a/b/g/n/ac, Bluetooth classic	
Modulation	OFDM/BPSK, GFSK	
Number of modules	1	
Radio Module	Type	WiFi + Bluetooth Module
	Model	QCNFA324
	Manufacturer	Qualcomm Atheros, Inc.
	HW Version	V02
	SW Version	BSP 3.2
	FCC ID	PPD-QCNFA324
	IC	4104A-QCNFA324
Antenna 1 (Bluetooth, BLE; IEEE802.11 b/g/n)	Type	Integrated antenna
	Model	Kingfisher Antenna
	Manufacturer	Leica Geosystems AG
	Gain	1.87 dBi (manufacturer delaration)
Antenna 2 (IEEE802.11 a/ac)	Type	Integrated antenna
	Model	Kingfisher Antenna
	Manufacturer	Leica Geosystems AG
	Gain	U-NII-1 +3.66 U-NII-2A +4.42 U-NII-2C +1.6 (manufacturer delaration)
Supply Voltage	V <sub>NOM</sub>	7.2 VDC
Operating Temperature	T <sub>NOM</sub>	25 °C
AC/DC-Adaptor (battery charger)	Model	GKL825
	Vendor	Leica Geosystems AG
	Input	19 VDC
	Output	8.7 DDC
Manufacturer	Leica Geosystems AG Heinrich-Wild-Strasse 9435 Heerbrugg SWITZERLAND	

### 1.1 Photos – Equipment External



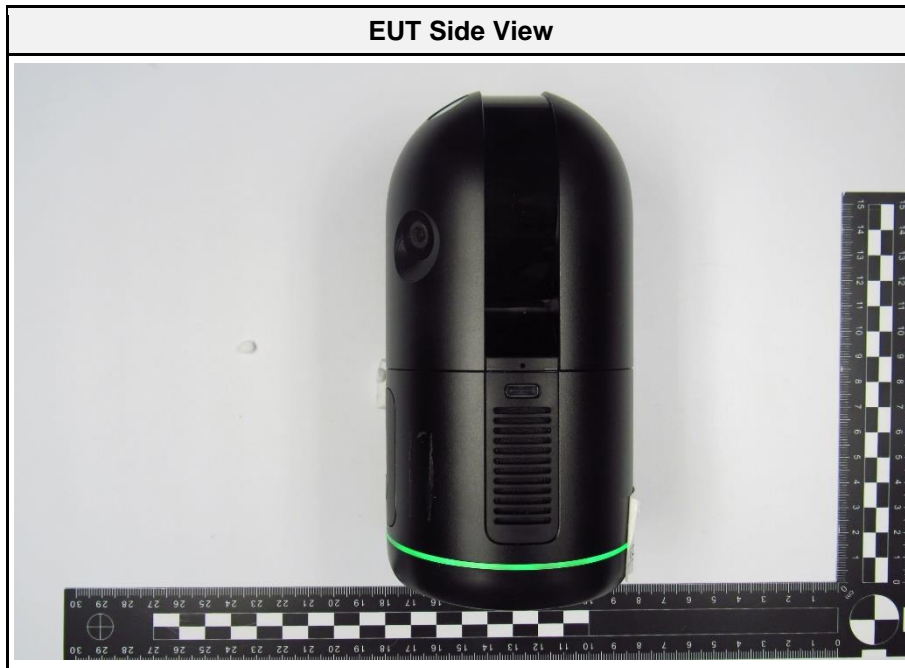



## 1.2 Photos – Equipment Internal

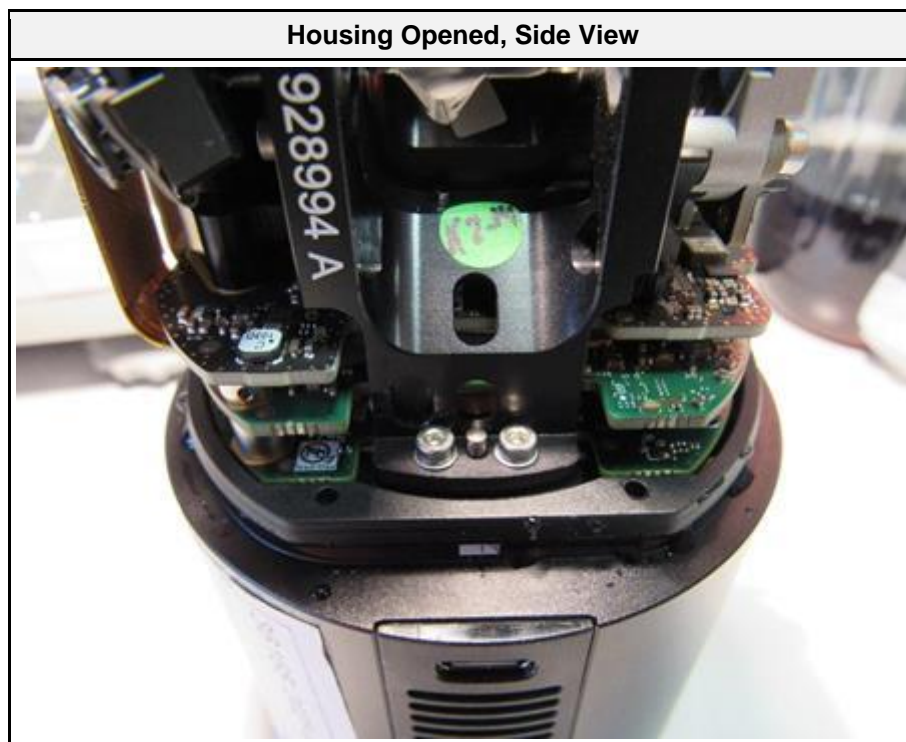
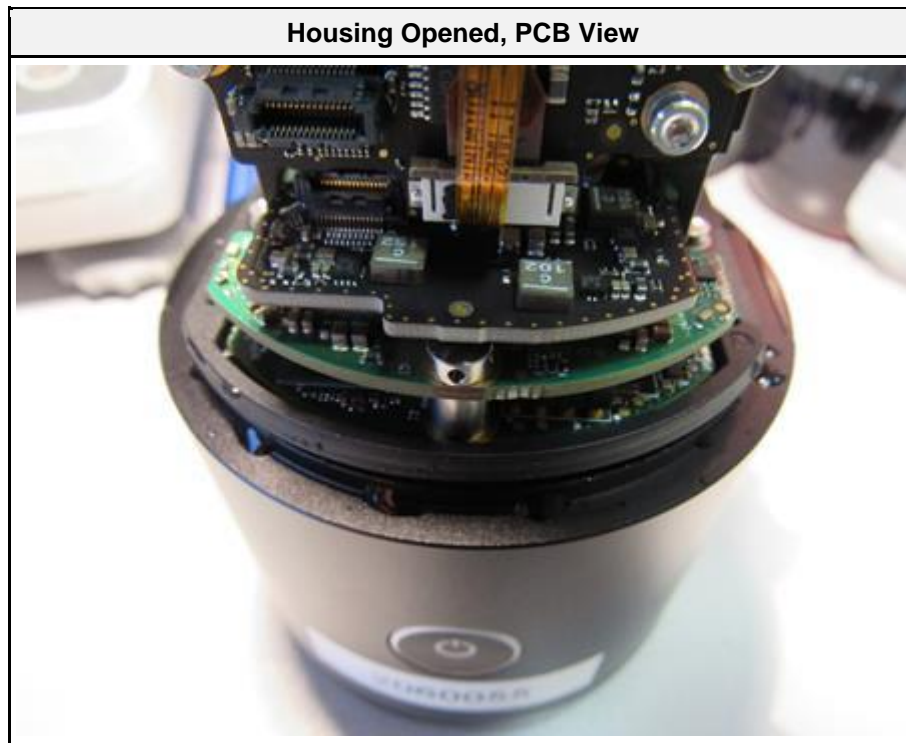

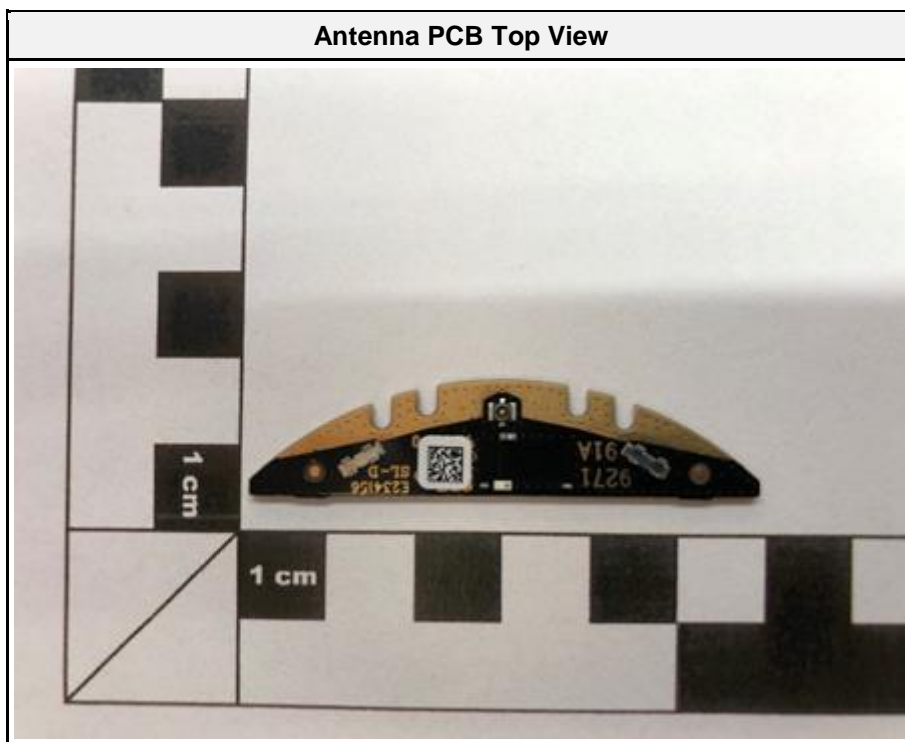

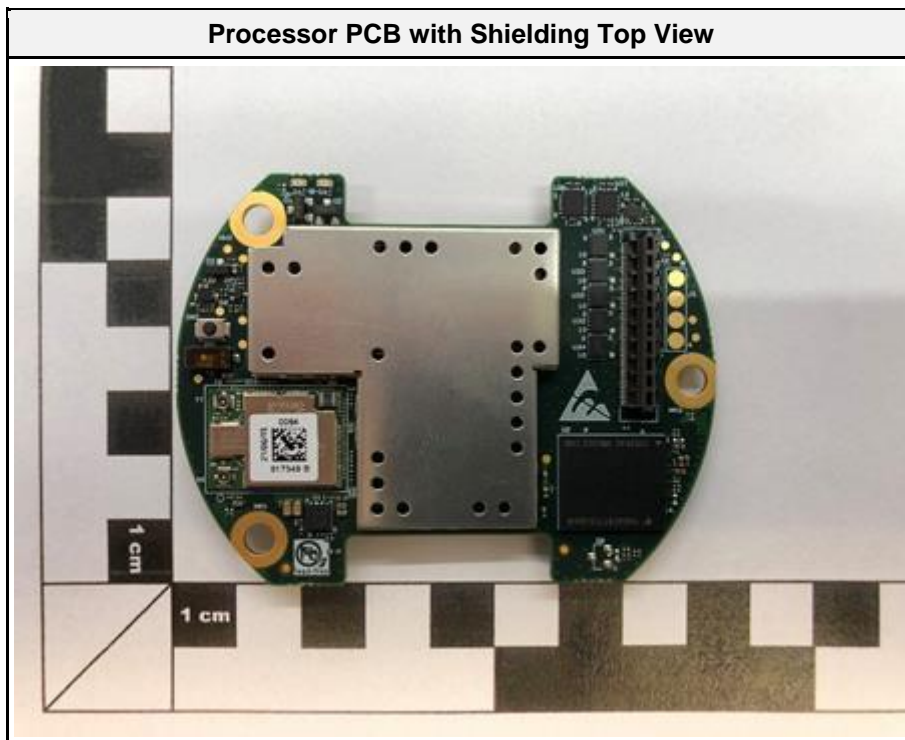
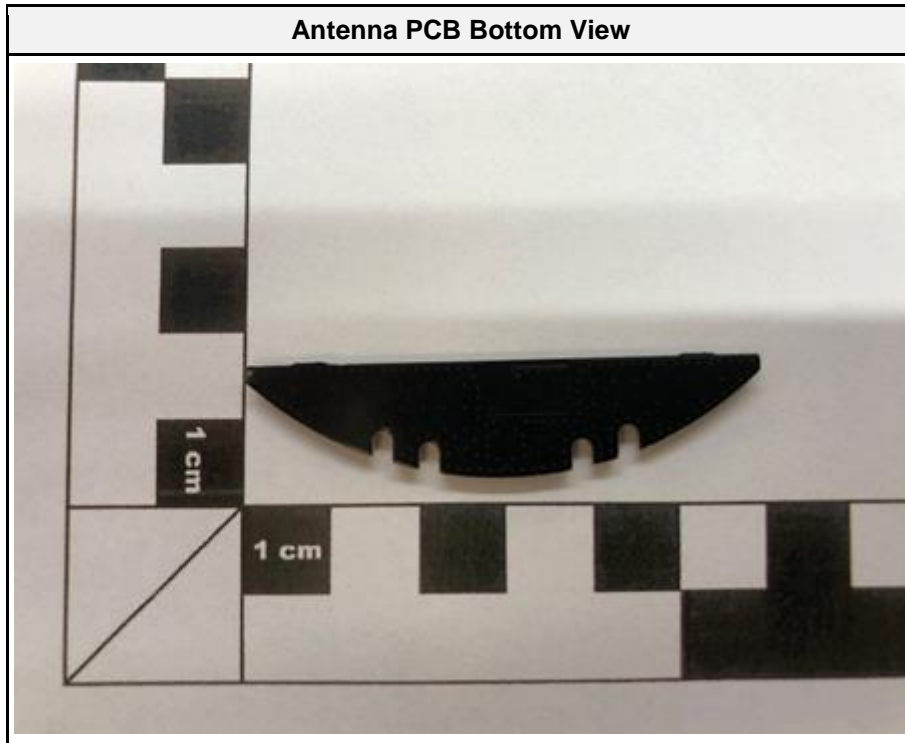

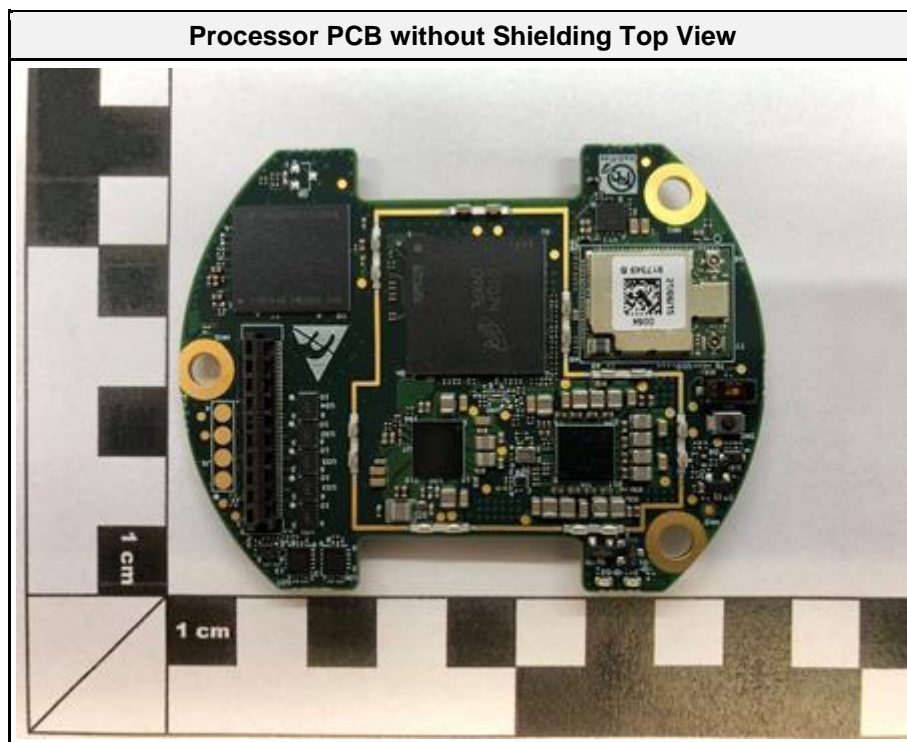
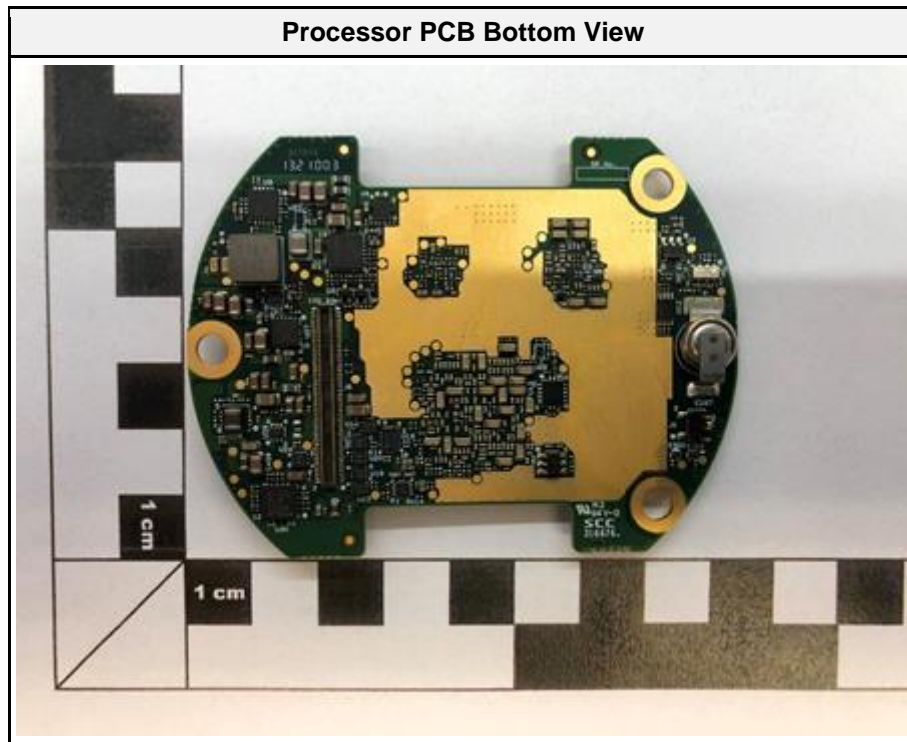



### 1.3 Photos – Test Setup

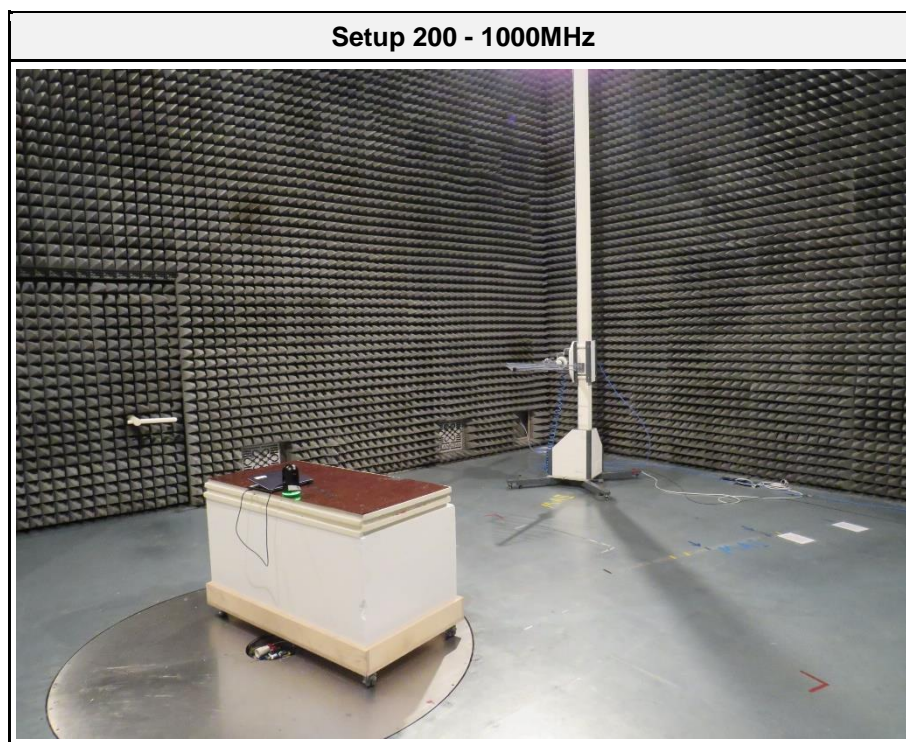
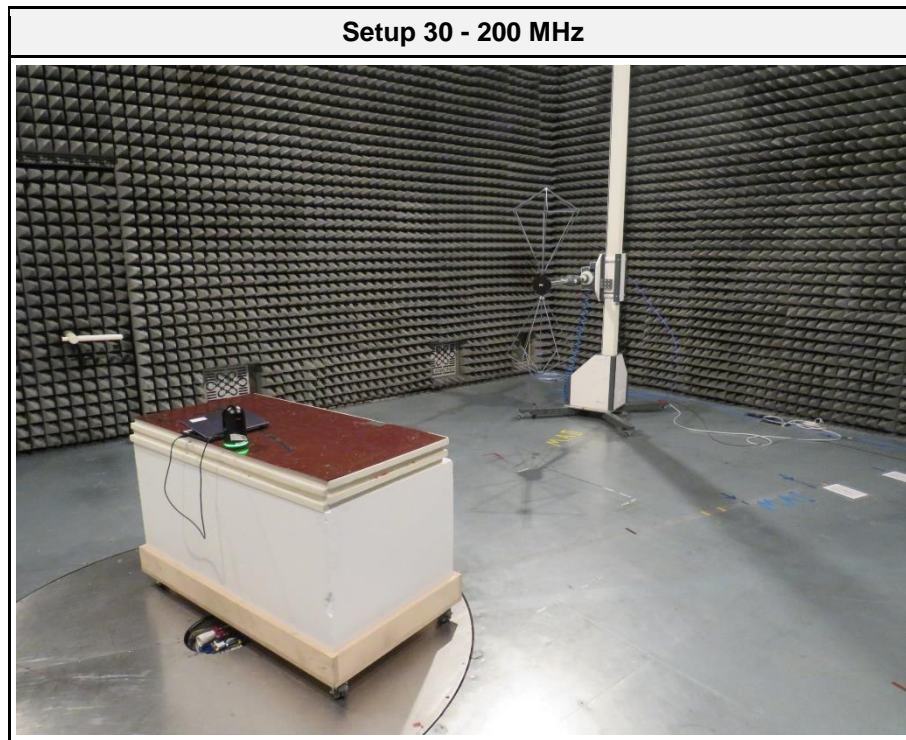

Setup 1-6.5 GHz

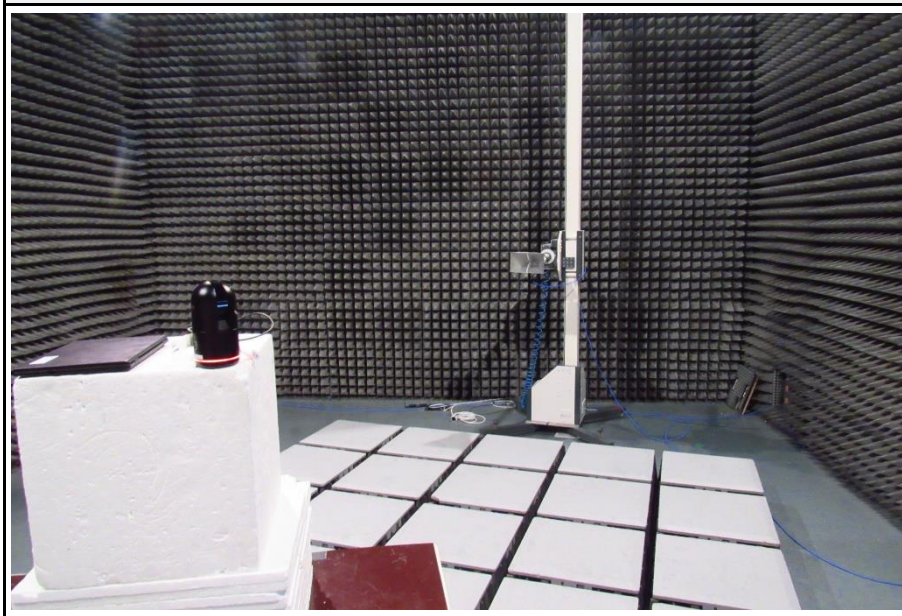

Setup 6.5-18 GHz

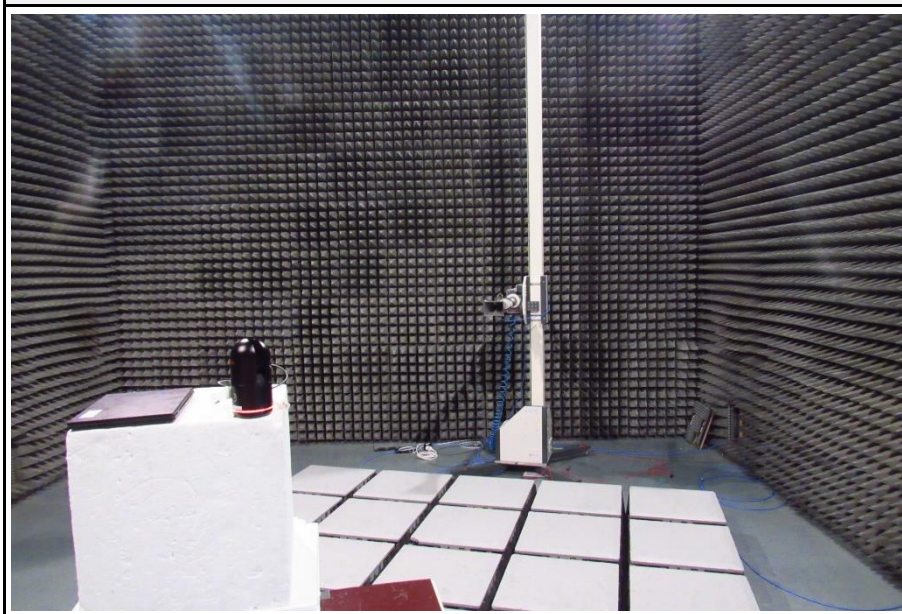

Setup 18-26 GHz

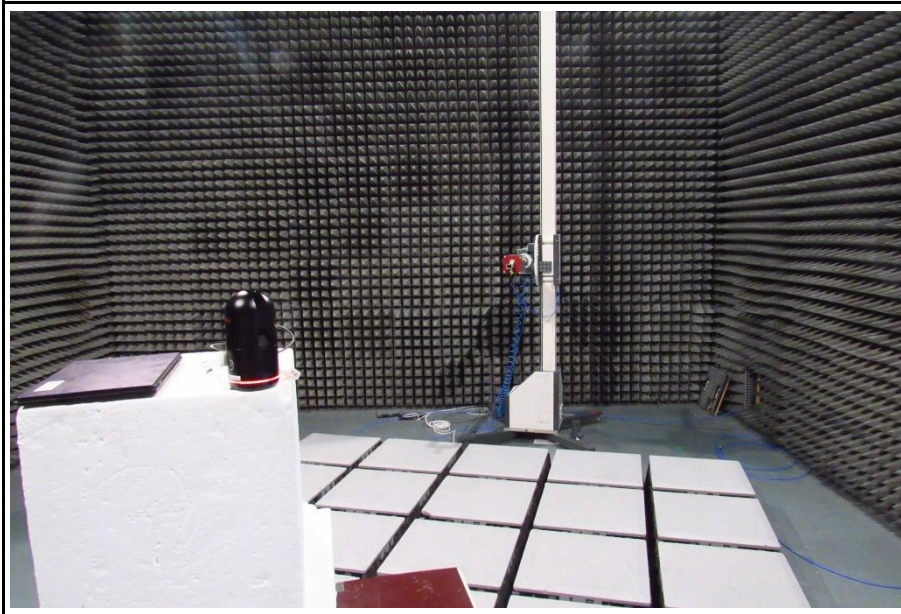

Setup 26 - 40 GHz

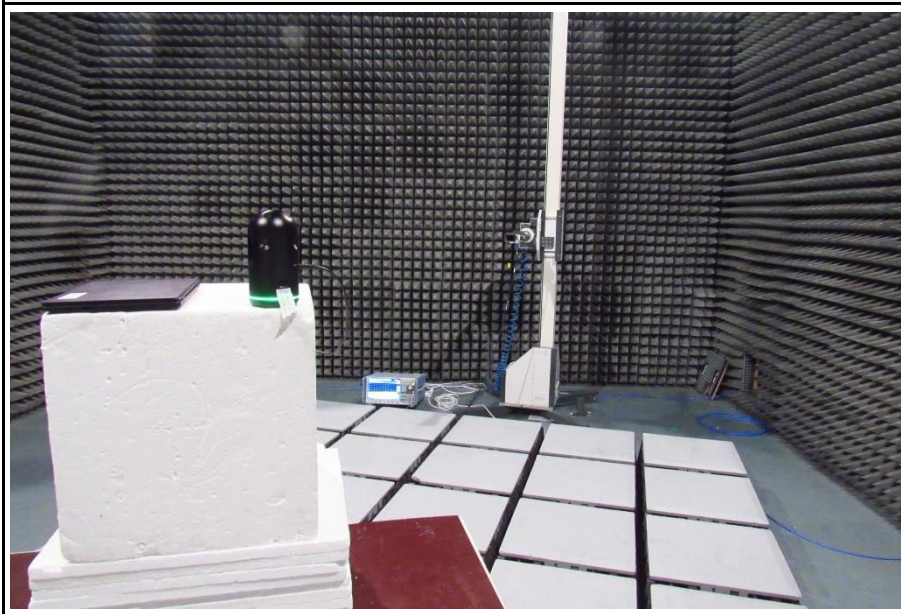



#### 1.4 Support Equipment

Product Type	Device	Manufacturer	Model	Comment
SFT	Customer Laptop	Qualcomm	QRCT	Test mode tool
Description:				
AE	Auxiliary Equipment			
SIM	Simulator			
CBL	Connecting Cable			
SFT	Software			
SFT Note: The Equipment Under Test used an operating system with a test firmware. The driver for the tested technology was running in a manufacturer mode.				
Comment:				

## 1.5 Test Modes

Mode	Description
IEEE802.11g + BT	OFDM (IEEE 802.11g) Mode = Transmit Modulation = OFDM Bandwidth = 20 MHz Power setting = 15 Data rate = 6 Mbps
	DH5 Single Mode = Transmit Modulation = GFSK Spreading = None Packet type = DH5 Duty cycle = 78%
IEEE802.11a + BT	OFDM (IEEE 802.11a) Mode = Transmit Modulation = OFDM Bandwidth = 20 MHz Power setting = 15 Data rate = 6 Mbps
	DH5 Single Mode = Transmit Modulation = GFSK Spreading = None Packet type = DH5 Duty cycle = 78%
Receive	Mode = Receive

## 1.6 Test Frequencies

Designator	Mode	Channel	Frequency [MHz]
F1	Tx, Rx	6	2437
F2	Tx, Rx	48	5240
F3	Tx, Rx	78	2480

Comment: F1 was tested in conjunction with F3, also F2 was tested in conjunction with F3.

### 1.7 Sample emission level calculation

The following is a description of terms and a sample calculation, as appears in the radiated emissions data table. The numbers used in the calculation are for example only. There is no direct correlation to the specific data taken for the product described in this document:

Reading:

This is the reading obtained on the spectrum analyzer in dBµV. Any external preamplifiers used are taken into account through internal analyzer settings.

A.F.:

This is the antenna factor for the receiving antenna. It is a conversion factor, which converts electric fields strengths to voltages, which can be measured directly on the spectrum analyzer. It is treated as a loss in dB. Cable losses have been included with the A.F. to simplify the calculations. The antenna factor is used in calculations as follows:

$$\text{Reading on Analyzer (dB}\mu\text{V)} + \text{A.F. (dB/m)} = \text{Net field strength (dB}\mu\text{V/m)}$$

Net:

This is the net field strength measurement (as shown above).

Limit:

This is the FCC Class B radiated emission limit (in units of dBµV/m). The FCC limits are given in units of µV/m. The following formula is used to convert the units of µV/m to dBµV/m:

$$\text{Limit (dB}\mu\text{V/m)} = 20 \cdot \log(\mu\text{V/m})$$

Margin:

This is the margin of compliance below the FCC limit. The units are given in dB. A negative margin indicates the emission was below the limit. A positive margin indicates that the emission exceeds the limit.

Example only:

Reading + AF	=	Net Reading	:	Net reading - FCC limit	=	Margin
+21.5 dBµV + 26 dB/m		= 47.5 dBµV/m		47.5 dBµV/m - 57.0 dBµV/m		= -9.5 dB

## 2 Result Summary

FCC 47 CFR Part 15C, FCC 47 CFR Part 15E, ISED RSS-247				
Product Standard Reference	Requirement	Reference Method	Result	Remarks
FCC § 15.247(d) FCC § 15.209 RSS-247 6.2.1.2, 6.2.2.2, 6.2.3.2, 6.2.4.2	Transmitter radiated spurious emissions	KDB 558074 D01 KDB 789033 D02 KDB 996369 D04 ANSI C63.10 12.7	PASS	
Comment:				

Possible Test Case Verdicts	
PASS	Test object does meet the requirements
FAIL	Test object does not meet the requirements
N/T	Required by standard but not tested
N/R	Not required by standard for the test object

### 3 Test Conditions and Results

#### 3.1 Test Conditions and Results - Transmitter radiated emissions

##### 3.1.1 Information

Test Information	
Reference	FCC § 15.247(d) FCC § 15.209 RSS-247 6.2.1.2, 6.2.2.2, 6.2.3.2, 6.2.4.2
Measurement Method	KDB 558074 D01, KDB 789033 D02, KDB 996369 D04, ANSI C63.10 12.7
Measurement Uncertainty	± 5.95 dB
Operator	Jens Degenhardt
Date	2021-10-15

##### 3.1.2 Limits

Limits - Restricted frequency bands and below 1 GHz			
Frequency [MHz]	Detector	Field strength [ $\mu\text{V}/\text{m}$ ]	Measurement distance [m]
30 - 88	Quasi-Peak	100	3
88 - 216	Quasi-Peak	150	3
216 - 960	Quasi-Peak	200	3
960 - 1000	Quasi-Peak	500	3
>1000	Average	500	3

Limits - Outside restricted frequency bands above 1 GHz			
Frequency band [MHz]	Power limit [dBm EIRP]	Field strength limit [dB $\mu\text{V}/\text{m}$ ]	Measurement distance [m]
5150 - 5250	-27 dBm/MHz	68.2	3
5250 - 5350	-27 dBm/MHz	68.2	3
5470 - 5725	-27 dBm/MHz	68.2	3
5725 - 5850	-27 dBm/MHz @ $\pm 75$ MHz from band edge	68.2	3
5725 - 5850	10 to -27 dBm/MHz @ $\pm 25$ to $\pm 75$ MHz from band edge	105.2 to 68.2	3
5725 - 5850	15.6 to 10 dBm/MHz @ $\pm 5$ to $\pm 25$ MHz from band edge	110.8 to 105.2	3
5725 - 5850	27 to 15.6 dBm/MHz @ $\pm 0$ to $\pm 5$ MHz from band edge	122.2 to 110.8	3

3.1.3 Setup

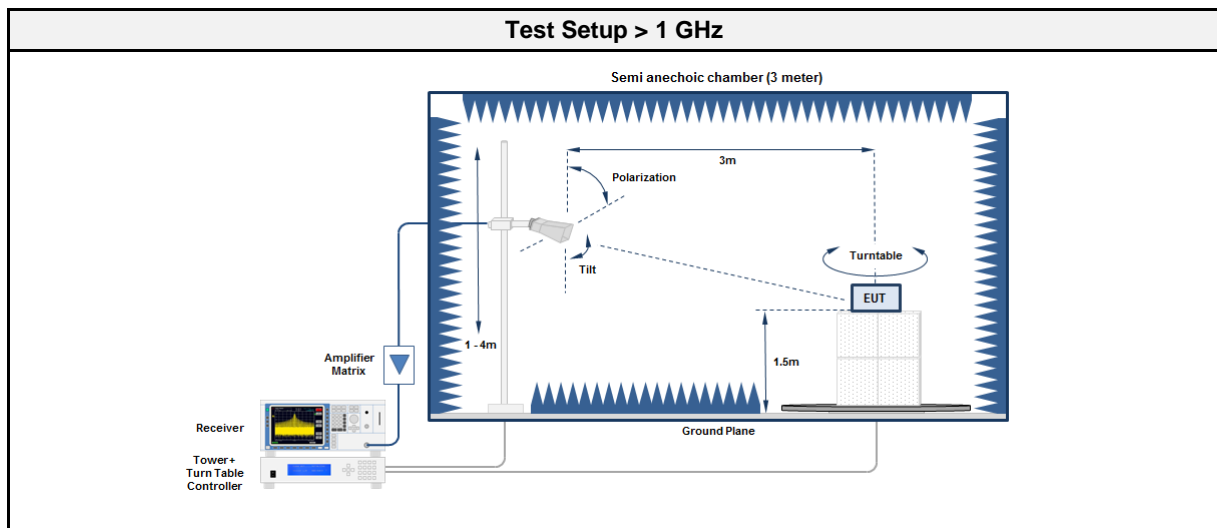
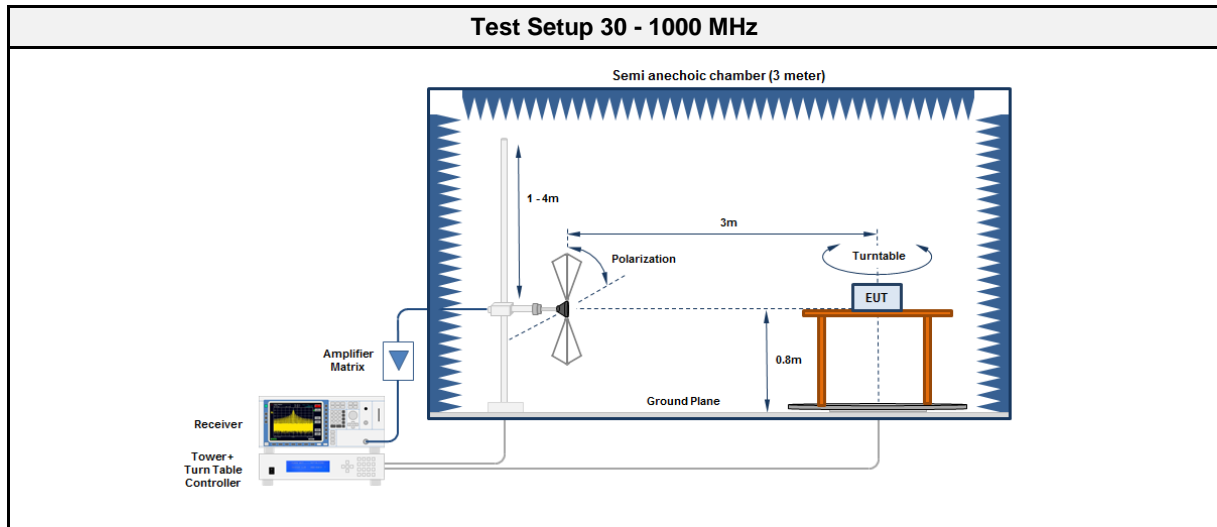

3.1.4 Equipment

Test Equipment 30 - 1000 MHz					
Description	Manufacturer	Model	Identifier	Cal. Date	Cal. Due
Anechoic Chamber	Frankonia	AC1	EF00062	2021-02	2024-02
Measurement Receiver	Agilent	N9038A-526/WXP	EF01070	2021-07	2022-07
Antenna	R&S	HK 116	EF00030	2021-05	2024-05
Antenna	R&S	HL 223	EF00212	2019-05	2022-05

Test Equipment > 1 GHz					
Description	Manufacturer	Model	Identifier	Cal. Date	Cal. Due
Anechoic Chamber	Frankonia	AC1	EF00062	2021-02	2024-02
Measurement Receiver	Agilent	N9038A-526/WXP	EF01070	2021-07	2022-07
Antenna	Schwarzbeck	BBHA 9120D	EF00018	2019-10	2022-10
Antenna	Schwarzbeck	BBHA 9120D	EF01153	2020-11	2021-11
Antenna	Amplifier Research	AT4560	EF00302	2021-06	2023-06
Antenna	Flann Microwave	22240-25	EF00301	2019-12	2022-12

Test Report No.: G0M-2108-9972-TFCCOLOC-V02

Eurofins Product Service GmbH  
Storkower Str. 38c, D-15526 Reichenwalde, Germany

3.1.5 Procedure

Test Procedure 30 - 1000 MHz
1. EUT is placed on a non conducting support at the center of a turn table 0.8 m above the ground
2. EUT set to test mode
3. The receiver is set to peak detection with max hold
4. The EUT is rotated through 360° and the height of the antenna is varied from 1 m to 4 m
5. All significant emissions are measured again using the corresponding final detector

Test Procedure > 1 GHz
1. EUT is placed on a non conducting support at the center of a turn table 1.5 m above the ground
2. EUT set to test mode
3. The receiver is set to peak detection with max hold
4. The EUT is rotated through 360° and the height of the antenna is varied from 1 m to 4 m
5. All significant emissions are measured again using the corresponding final detector

3.1.6 Results

Test Results - IEEE802.11g+ BT						
Frequency [MHz]	Emission [MHz]	Level [dBµV/m]	Detector	Pol.	Limit [dBµV/m]	Margin [dB]
2437 + 2480	136.9045	37.10	qpk	ver	43.50	-06.38
2437 + 2480	137.4273	40.20	qpk	ver	43.50	-03.35
2437 + 2480	262.4532	42.60	qpk	ver	46.00	-03.40
2437 + 2480	1122.4	39.60	avg	ver	74.00	-34.40

Test Results - IEEE802.11a+ BT						
Frequency [MHz]	Emission [MHz]	Level [dBµV/m]	Detector	Pol.	Limit [dBµV/m]	Margin [dB]
5240 + 2480	137.4273	39.7	qpk	ver	43.5	-03.77
5240 + 2480	162.413	27.4	qpk	ver	43.5	-16.14
5240 + 2480	261.3445	37.9	qpk	ver	46	-08.08
5240 + 2480	2480	98.06	avg	ver	68.2	29.86
5240 + 2480	2758	51	avg	ver	74	-23.00
5240 + 2480	2758	36.74	avg	ver	54	-17.26



## ANNEX A Transmitter spurious emissions WiFi 2.4 + BT

### Radiated Spurious Emissions according to RSS-247 Issue 2, FCC 15.247

Project Number: G0M-2108-9971  
 Applicant: Leica Geosystems AG  
 Model Description: Imaging Laser Scanner  
 Model: BLK360 G2  
 Test Sample ID: 36490  
 Test Site: Eurofins Product Service GmbH  
 Operator: Mr. Degenhardt  
 Measurement software: RadiMation, version 2020.1.8  
 Test Conditions: Tnom: 23 °Celsius, Vnom: 7.2 V (lithium battery), type: GEB825  
 Antenna: Rohde & Schwarz HK 116  
 Measurement distance: 3 m  
 Mode: Tx; 802.11g, CH6, 2437MHz, 6Mbit, BT CH78  
 Test Date: 2021-10-15  
 Note:

Index 25

**RadiMation**

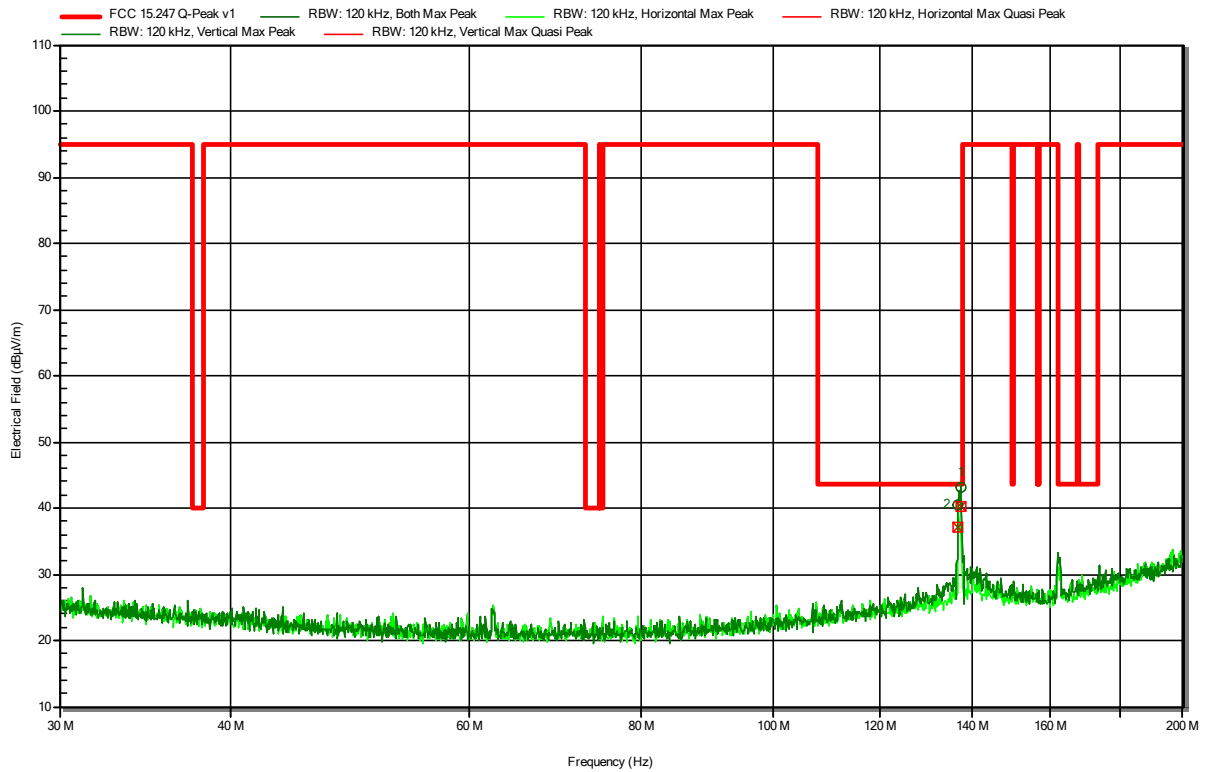

Frequency	Peak	Peak Limit	Peak Difference	Peak Status
136.9045 MHz	40.5 dBµV/m	43.5 dBµV/m	-3.01 dB	Pass
137.4273 MHz	43.1 dBµV/m	43.5 dBµV/m	-0.39 dB	Pass

Frequency	Quasi-Peak	Quasi-Peak Limit	Quasi-Peak Difference	Quasi-Peak Status
136.9045 MHz	37.1 dBµV/m	43.5 dBµV/m	-6.38 dB	Pass
137.4273 MHz	40.2 dBµV/m	43.5 dBµV/m	-3.35 dB	Pass

Test Report No.: G0M-2108-9972-TFCCOLOC-V02

Eurofins Product Service GmbH  
 Storkower Str. 38c, D-15526 Reichenwalde, Germany

**Radiated Spurious Emissions according to RSS-247 Issue 2, FCC 15.247**

Project Number: G0M-2108-9971  
 Applicant: Leica Geosystems AG  
 Model Description: Imaging Laser Scanner  
 Model: BLK360 G2  
 Test Sample ID: 36490  
 Test Site: Eurofins Product Service GmbH  
 Operator: Mr. Degenhardt  
 Measurement software: RadiMation, version 2020.1.8  
 Test Conditions: Tnom: 23 °Celsius, Vnom: 7.2 V (lithium battery), type: GEB825  
 Antenna: Rohde & Schwarz HL 223  
 Measurement distance: 3 m  
 Mode: Tx; 802.11g, CH6, 2437MHz, 6Mbit, BT CH78  
 Test Date: 2021-10-15  
 Note:

Index 24

**RadiMation**

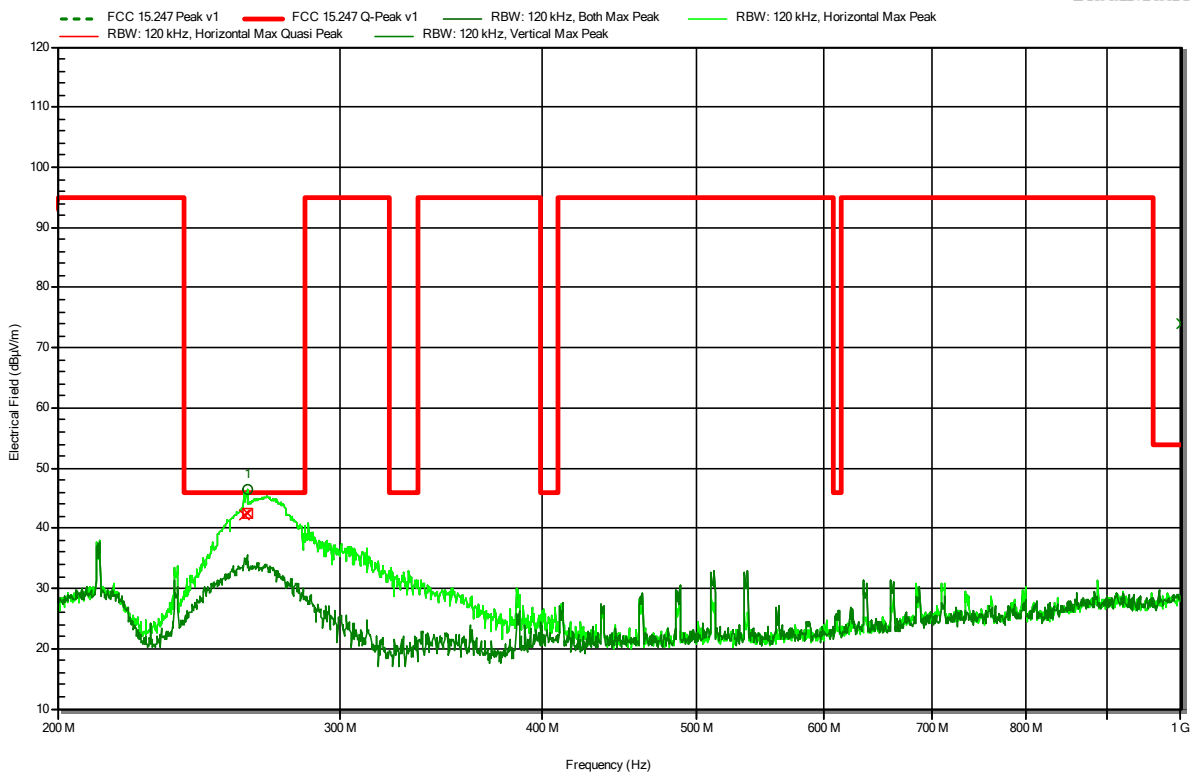

Frequency	Quasi-Peak	Quasi-Peak Limit	Quasi-Peak Difference	Quasi-Peak Status
262.4532 MHz	42.6 dBµV/m	46 dBµV/m	-3.4 dB	Pass

**Radiated Spurious Emissions according to RSS-247 Issue 2, FCC 15.247**

Project Number: G0M-2108-9971  
 Applicant: Leica Geosystems AG  
 Model Description: Imaging Laser Scanner  
 Model: BLK360 G2  
 Test Sample ID: 36490  
 Test Site: Eurofins Product Service GmbH  
 Operator: Mr. Degenhardt  
 Measurement software: RadiMation, version 2020.1.8  
 Test Conditions: Tnom: 23 °Celsius, Vnom: 7.2 V (lithium battery), type: GEB825  
 Antenna: Schwarzbeck BBHA 9120D  
 Measurement distance: 3 m  
 Mode: Tx; 802.11g, CH6, 2437MHz, 6Mbit, BT CH78  
 Test Date: 2021-10-19  
 Note:

Index 49

**RadiMation**

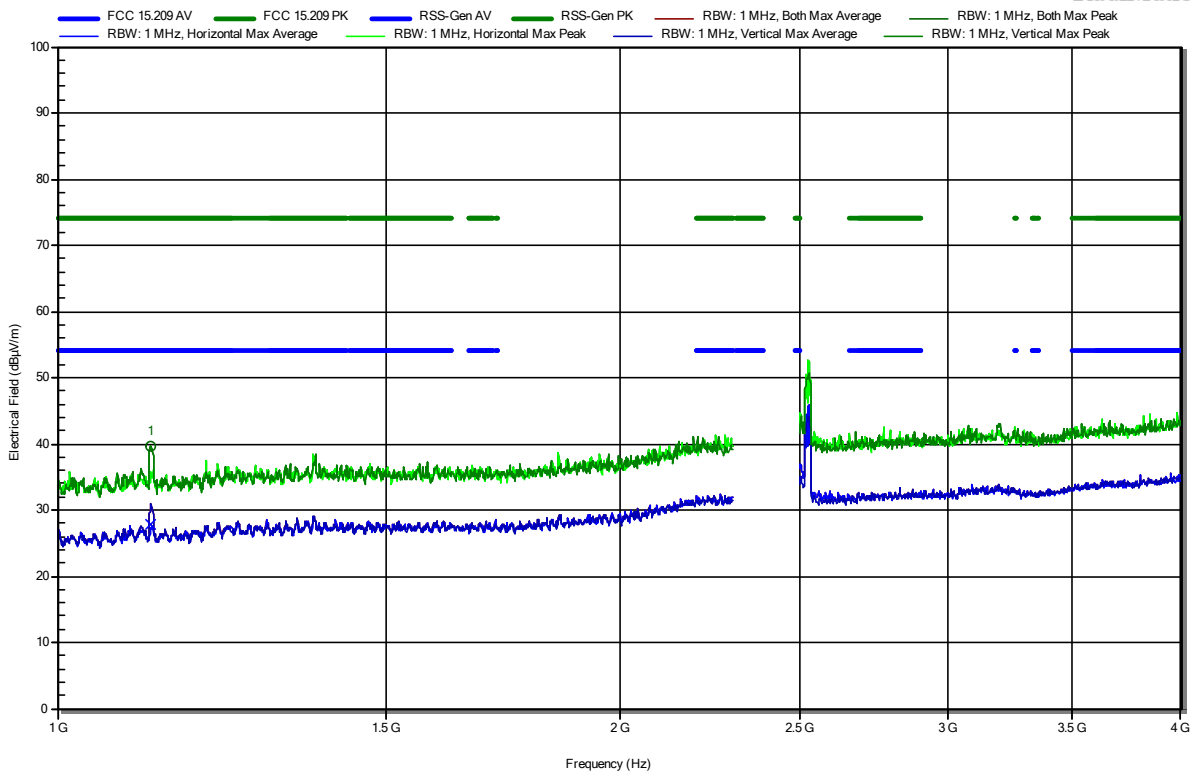

Frequency	Peak	Peak Limit	Peak Difference	Peak Status
1.1224 GHz	39.6 dBµV/m	74 dBµV/m	-34.4 dB	Pass
Frequency	Average	Average Limit	Average Difference	Average Status
1.1224 GHz	27.91 dBµV/m	54 dBµV/m	-26.09 dB	Pass

**Radiated Spurious Emissions according to RSS-247 Issue 2, FCC 15.247**

Project Number: G0M-2108-9971  
 Applicant: Leica Geosystems AG  
 Model Description: Imaging Laser Scanner  
 Model: BLK360 G2  
 Test Sample ID: 36490  
 Test Site: Eurofins Product Service GmbH  
 Operator: Mr. Degenhardt  
 Measurement software: RadiMation, version 2020.1.8  
 Test Conditions: Tnom: 23 °Celsius, Vnom: 7.2 V (lithium battery), type: GEB825  
 Antenna: Schwarzbeck BBHA 9120D  
 Measurement distance: 3 m  
 Mode: Tx; 802.11g, CH6, 2437MHz, 6Mbit, BT CH78  
 Test Date: 2021-10-19  
 Note:

Index 50

**RadiMation**

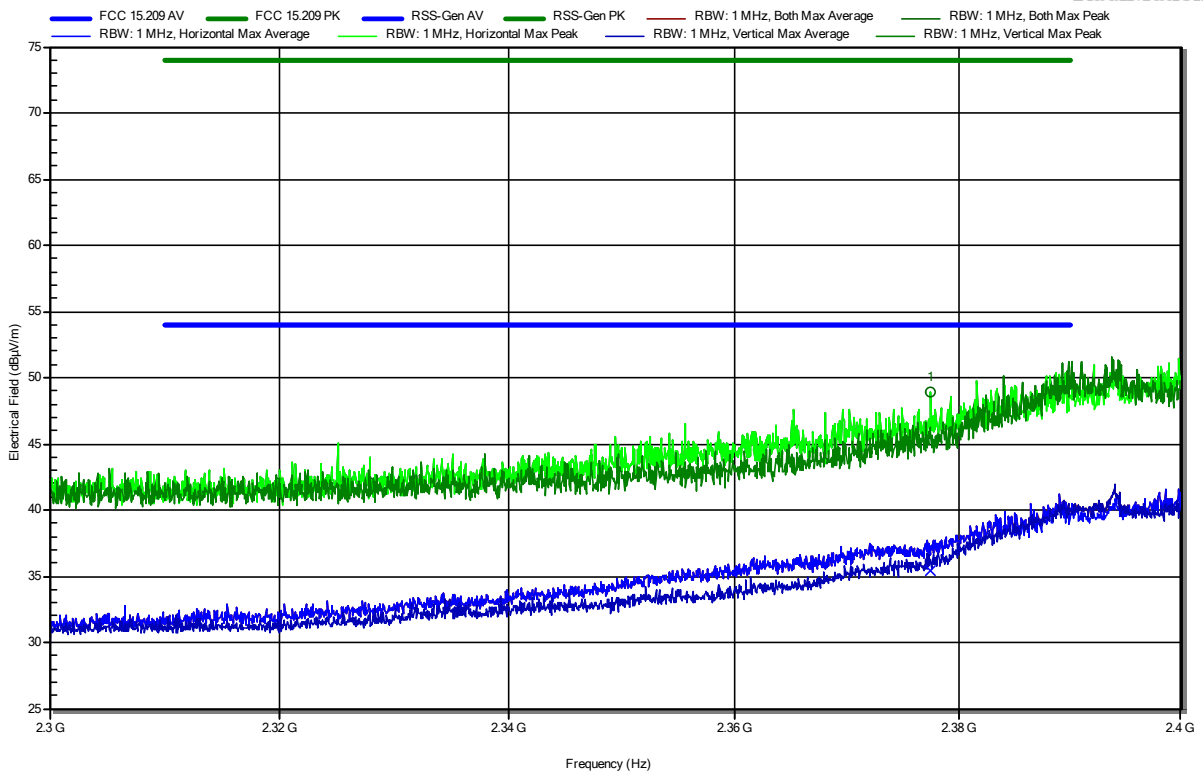

Frequency	Peak	Peak Limit	Peak Difference	Peak Status
2.3775 GHz	48.95 dBµV/m	74 dBµV/m	-25.05 dB	Pass
Frequency	Average	Average Limit	Average Difference	Average Status
2.3775 GHz	35.37 dBµV/m	54 dBµV/m	-18.63 dB	Pass

**Radiated Spurious Emissions according to RSS-247 Issue 2, FCC 15.247**

Project Number: G0M-2108-9971  
 Applicant: Leica Geosystems AG  
 Model Description: Imaging Laser Scanner  
 Model: BLK360 G2  
 Test Sample ID: 36490  
 Test Site: Eurofins Product Service GmbH  
 Operator: Mr. Degenhardt  
 Measurement software: RadiMation, version 2020.1.8  
 Test Conditions: Tnom: 23 °Celsius, Vnom: 7.2 V (lithium battery), type: GEB825  
 Antenna: Schwarzbeck BBHA 9120D  
 Measurement distance: 3 m  
 Mode: Tx; 802.11g, CH6, 2437MHz, 6Mbit, BT CH78  
 Test Date: 2021-10-19  
 Note:

Index 51

**RadiMation**

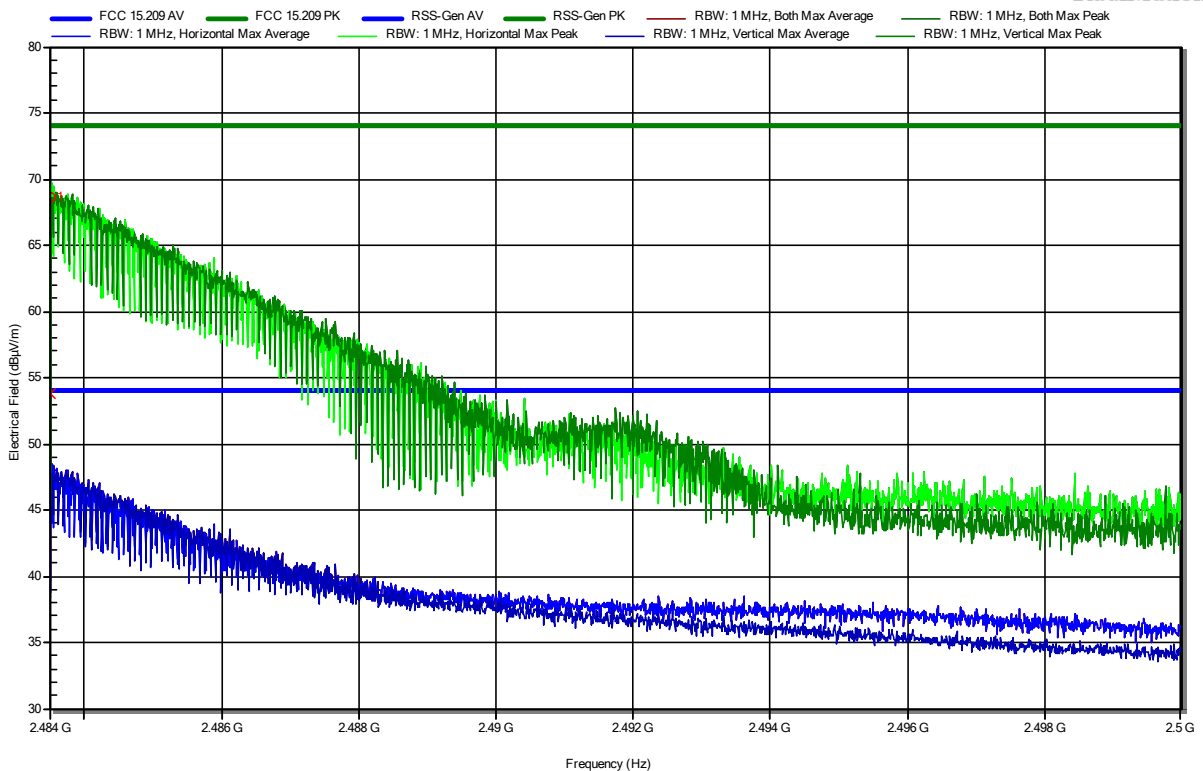

Frequency	Peak	Peak Limit	Peak Difference	Peak Status
2.4835 GHz	68.66 dBµV/m	74 dBµV/m	-5.34 dB	Pass
Frequency	Average	Average Limit	Average Difference	Average Status
2.4835 GHz	53.85 dBµV/m	54 dBµV/m	-0.15 dB	Pass

**Radiated Spurious Emissions according to RSS-247 Issue 2, FCC 15.247**

Project Number: G0M-2108-9971  
 Applicant: Leica Geosystems AG  
 Model Description: Imaging Laser Scanner  
 Model: BLK360 G2  
 Test Sample ID: 36490  
 Test Site: Eurofins Product Service GmbH  
 Operator: Mr. Degenhardt  
 Measurement software: RadiMation, version 2020.1.8  
 Test Conditions: Tnom: 23 °Celsius, Vnom: 7.2 V (lithium battery), type: GEB825  
 Antenna: Schwarzbeck BBHA 9120D  
 Measurement distance: 3 m  
 Mode: Tx; 802.11g, CH6, 2437MHz, 6Mbit, BT CH78  
 Test Date: 2021-10-19  
 Note:

Index 54

**RadiMation**

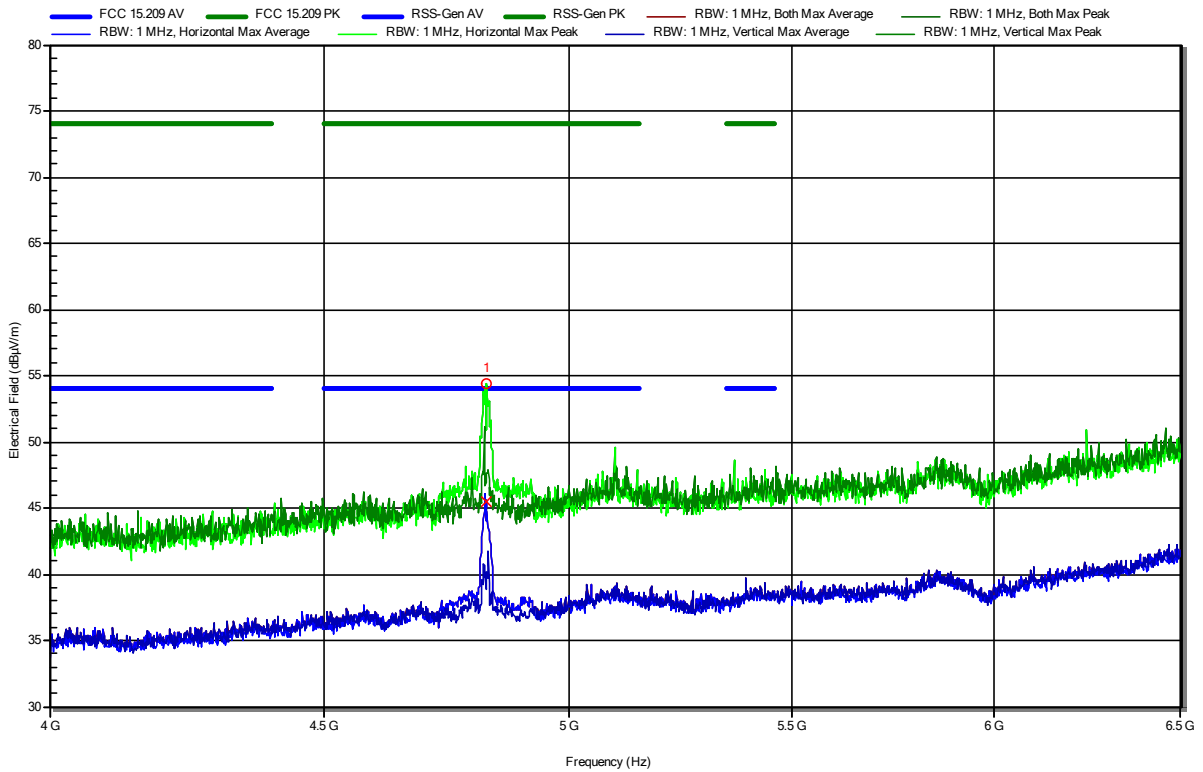

Frequency	Peak	Peak Limit	Peak Difference	Peak Status
4.824 GHz	54.36 dBµV/m	74 dBµV/m	-19.64 dB	Pass
Frequency	Average	Average Limit	Average Difference	Average Status
4.824 GHz	45.53 dBµV/m	54 dBµV/m	-8.47 dB	Pass

**Radiated Spurious Emissions according to RSS-247 Issue 2, FCC 15.247**

Project Number: G0M-2108-9971  
 Applicant: Leica Geosystems AG  
 Model Description: Imaging Laser Scanner  
 Model: BLK360 G2  
 Test Sample ID: 36490  
 Test Site: Eurofins Product Service GmbH  
 Operator: Mr. Degenhardt  
 Measurement software: RadiMation, version 2020.1.8  
 Test Conditions: Tnom: 23 °Celsius, Vnom: 7.2 V (lithium battery), type: GEB825  
 Antenna: Schwarzbeck HWRD 650  
 Measurement distance: 3 m  
 Mode: Tx; 802.11g, CH6, 2437MHz, 6Mbit, BT CH78  
 Test Date: 2021-10-19  
 Note:

Index 55

**RadiMation**

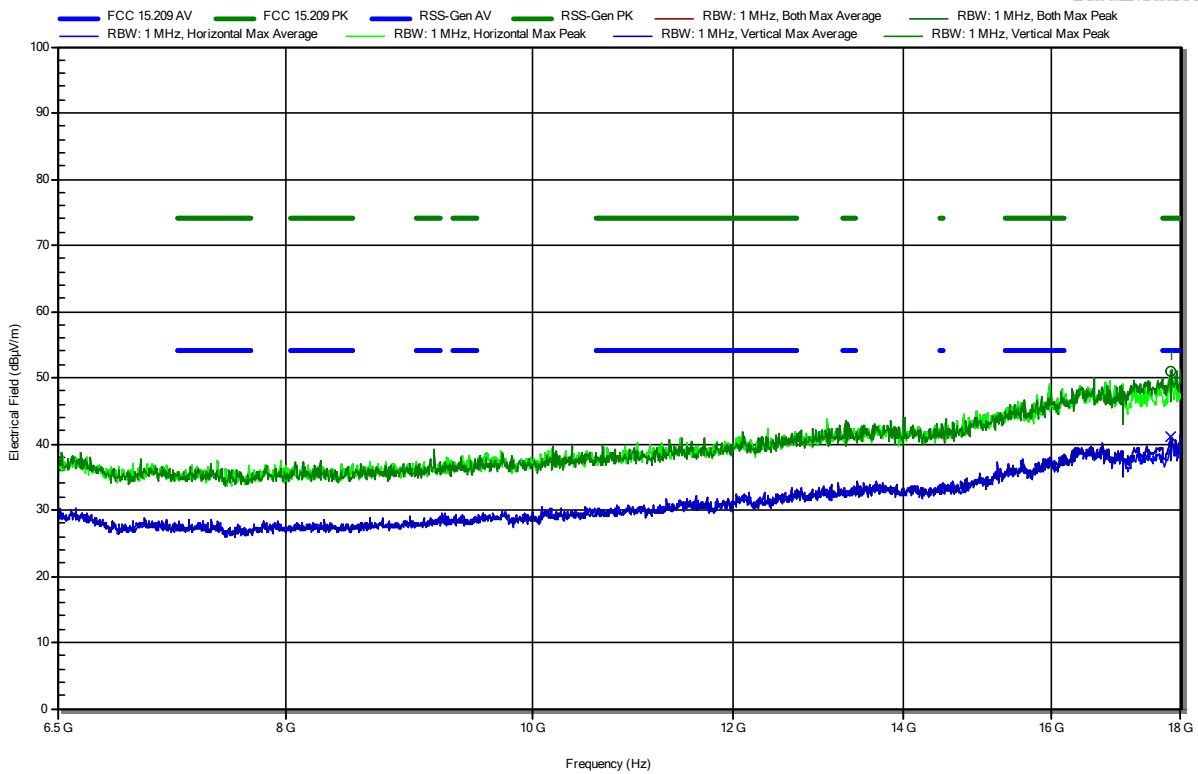

Frequency	Peak	Peak Limit	Peak Difference	Peak Status
17.84 GHz	51 dBµV/m	74 dBµV/m	-23 dB	Pass
Frequency	Average	Average Limit	Average Difference	Average Status
17.84 GHz	41.03 dBµV/m	54 dBµV/m	-12.97 dB	Pass

**Radiated Spurious Emissions according to RSS-247 Issue 2, FCC 15.247**

Project Number: G0M-2108-9971  
 Applicant: Leica Geosystems AG  
 Model Description: Imaging Laser Scanner  
 Model: BLK360 G2  
 Test Sample ID: 36490  
 Test Site: Eurofins Product Service GmbH  
 Operator: Mr. Degenhardt  
 Measurement software: RadiMation, version 2020.1.8  
 Test Conditions: Tnom: 23 °Celsius, Vnom: 7.2 V (lithium battery), type: GEB825  
 Antenna: Amplifier Research AT4560  
 Measurement distance: 3 m  
 Mode: Tx; 802.11g, CH6, 2437MHz, 6Mbit, BT CH78  
 Test Date: 2021-10-19  
 Note:

Index 56

**RadiMation**

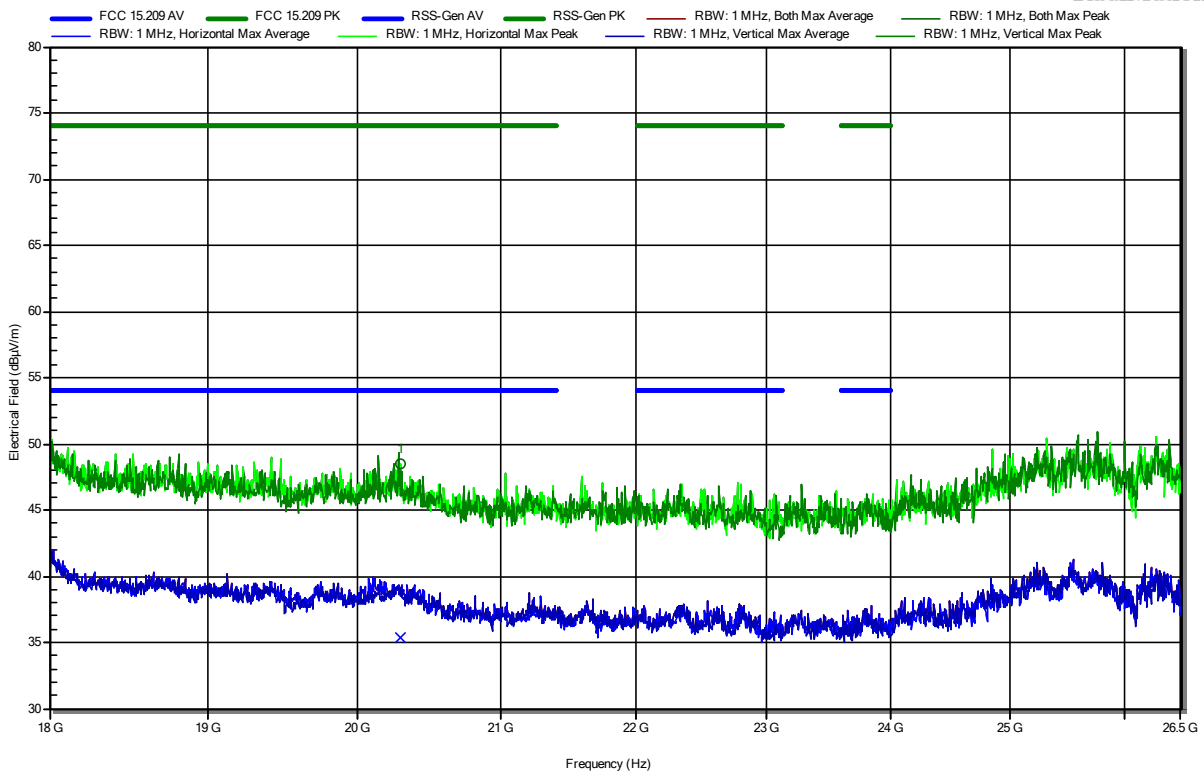

Frequency	Peak	Peak Limit	Peak Difference	Peak Status
20.29 GHz	48.55 dBµV/m	74 dBµV/m	-25.45 dB	Pass
Frequency	Average	Average Limit	Average Difference	Average Status
20.29 GHz	35.34 dBµV/m	54 dBµV/m	-18.66 dB	Pass



## ANNEX B Transmitter spurious emissions WiFi 5 + BT

### Radiated Spurious Emissions according to RSS-247 Issue 2, FCC 15.407

Project Number: G0M-2108-9971  
 Applicant: Leica Geosystems AG  
 Model Description: Imaging Laser Scanner  
 Model: BLK360 G2  
 Test Sample ID: 36490  
 Test Site: Eurofins Product Service GmbH  
 Operator: Mr. Degenhardt  
 Measurement software: RadiMation, version 2020.1.8  
 Test Conditions: Tnom: 23 °Celsius, Vnom: 7.2 V (lithium battery), type: GEB825  
 Antenna: Rohde & Schwarz HK 116  
 Measurement distance: 3 m  
 Mode: Tx; 802.11a, CH48, 5240MHz, 6Mbit, BT CH78  
 Test Date: 2021-10-15  
 Note:

Index 28

RadiMation

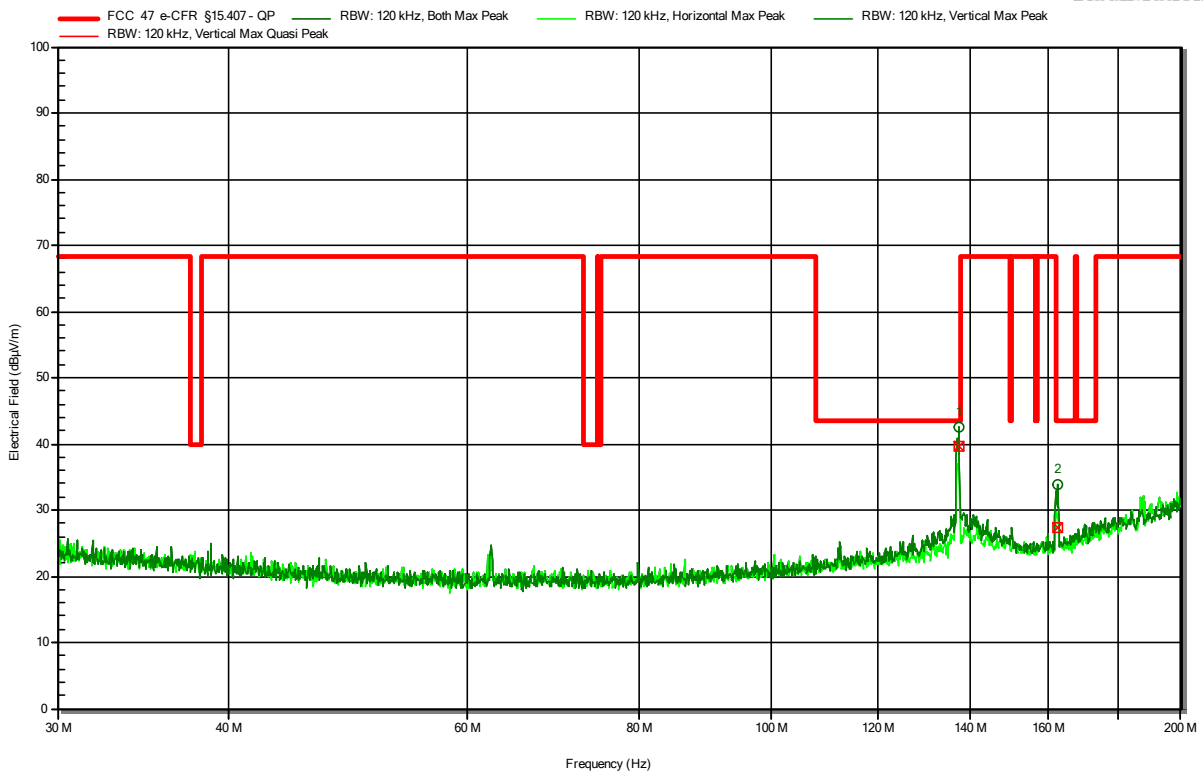

Frequency	Peak	Peak Limit	Peak Difference	Peak Status
137.4273 MHz	42.6 dBµV/m	43.5 dBµV/m	-0.95 dB	Pass
162.413 MHz	33.8 dBµV/m	43.5 dBµV/m	-9.68 dB	Pass
Frequency	Quasi-Peak	Quasi-Peak Limit	Quasi-Peak Difference	Quasi-Peak Status
137.4273 MHz	39.7 dBµV/m	43.5 dBµV/m	-3.77 dB	Pass
162.413 MHz	27.4 dBµV/m	43.5 dBµV/m	-16.14 dB	Pass

Test Report No.: G0M-2108-9972-TFCCOLOC-V02

Eurofins Product Service GmbH  
 Storkower Str. 38c, D-15526 Reichenwalde, Germany

**Radiated Spurious Emissions according to RSS-247 Issue 2, FCC 15.407**

Project Number: G0M-2108-9971  
 Applicant: Leica Geosystems AG  
 Model Description: Imaging Laser Scanner  
 Model: BLK360 G2  
 Test Sample ID: 36490  
 Test Site: Eurofins Product Service GmbH  
 Operator: Mr. Degenhardt  
 Measurement software: RadiMation, version 2020.1.8  
 Test Conditions: Tnom: 23 °Celsius, Vnom: 7.2 V (lithium battery), type: GEB825  
 Antenna: Rohde & Schwarz HL 223  
 Measurement distance: 3 m  
 Mode: Tx; 802.11a, CH48, 5240MHz, 6Mbit, BT CH78  
 Test Date: 2021-10-15  
 Note:

Index 29

**RadiMation**

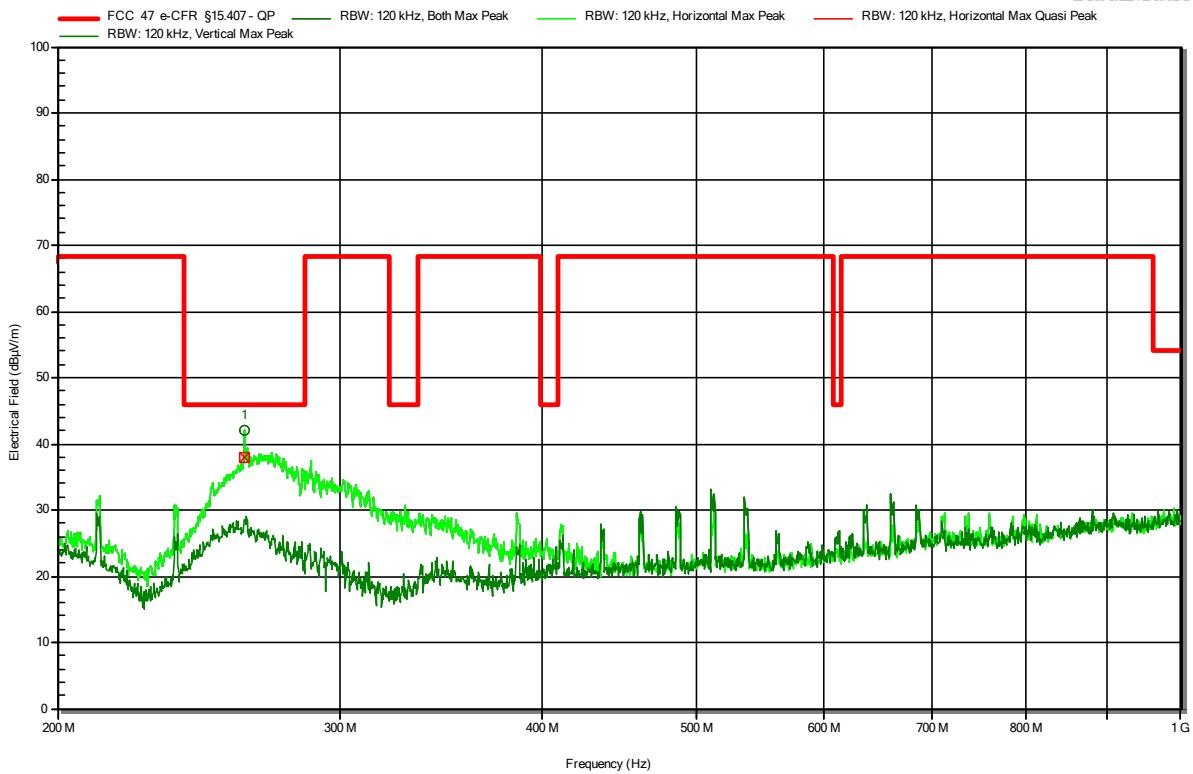

Frequency	Peak	Peak Limit	Peak Difference	Peak Status
261.3445 MHz	42 dBµV/m	46 dBµV/m	-4.03 dB	Pass
Frequency	Quasi-Peak	Quasi-Peak Limit	Quasi-Peak Difference	Quasi-Peak Status
261.3445 MHz	37.9 dBµV/m	46 dBµV/m	-8.08 dB	Pass

### Radiated Spurious Emissions according to RSS-247 Issue 2, FCC 15.407

Project Number: G0M-2108-9971  
 Applicant: Leica Geosystems AG  
 Model Description: Imaging Laser Scanner  
 Model: BLK360 G2  
 Test Sample ID: 36490  
 Test Site: Eurofins Product Service GmbH  
 Operator: Mr. Degenhardt  
 Measurement software: RadiMation, version 2020.1.8  
 Test Conditions: Tnom: 23 °Celsius, Vnom: 7.2 V (lithium battery), type: GEB825  
 Antenna: Schwarzbeck BBHA 9120D  
 Measurement distance: 3 m  
 Mode: Tx; 802.11a, CH48, 5240MHz, 6Mbit, BT CH78  
 Test Date: 2021-10-19  
 Note:

Index 66

RadiMation

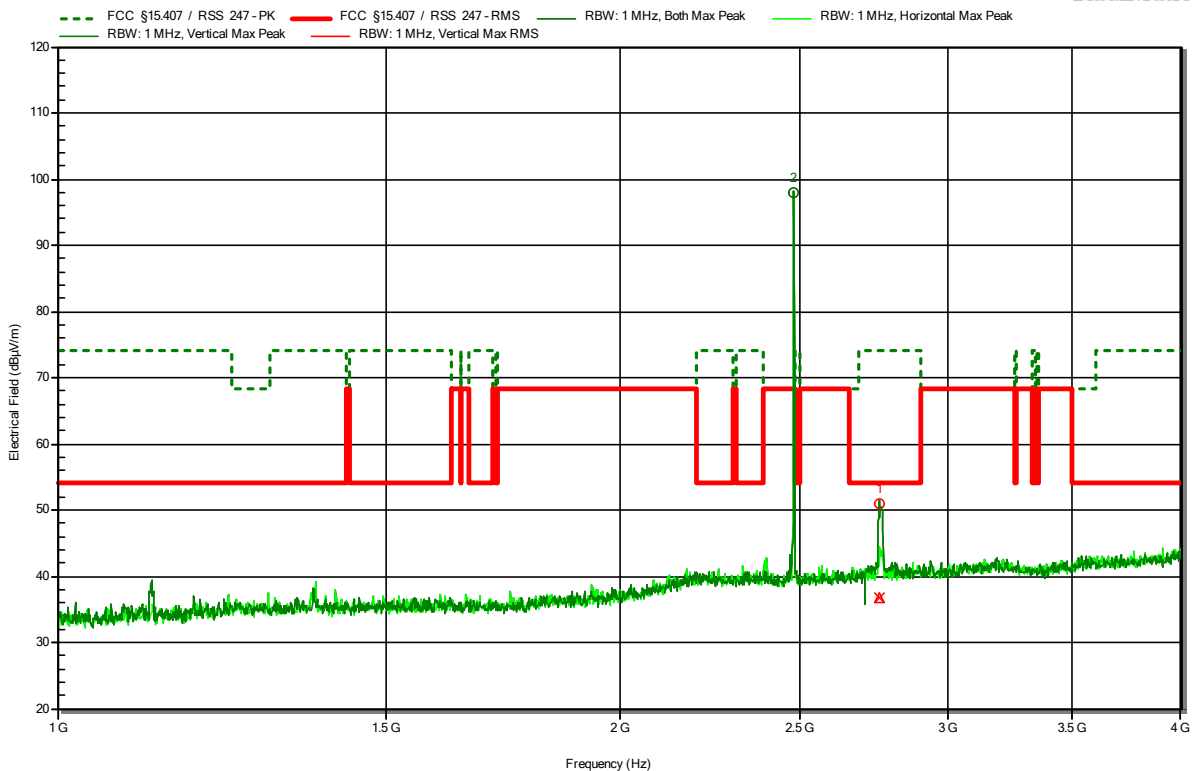

Frequency	Peak	Peak Limit	Peak Difference	Peak Status
2.48 GHz	98.06 dBµV/m	68.2 dBµV/m	29.86 dB	BT uplink
2.758 GHz	51 dBµV/m	74 dBµV/m	-23 dB	Pass
Frequency	RMS	RMS Limit	RMS Difference	RMS Status
2.758 GHz	36.74 dBµV/m	54 dBµV/m	-17.26 dB	Pass

Test Report No.: G0M-2108-9972-TFCCOLOC-V02

Eurofins Product Service GmbH  
 Storkower Str. 38c, D-15526 Reichenwalde, Germany

### Radiated Spurious Emissions according to RSS-247 Issue 2, FCC 15.407

Project Number: G0M-2108-9971  
 Applicant: Leica Geosystems AG  
 Model Description: Imaging Laser Scanner  
 Model: BLK360 G2  
 Test Sample ID: 36490  
 Test Site: Eurofins Product Service GmbH  
 Operator: Mr. Degenhardt  
 Measurement software: RadiMation, version 2020.1.8  
 Test Conditions: Tnom: 23 °Celsius, Vnom: 7.2 V (lithium battery), type: GEB825  
 Antenna: Schwarzbeck BBHA 9120D  
 Measurement distance: 3 m  
 Mode: Tx; 802.11a, CH48, 5240MHz, 6Mbit, BT CH78  
 Test Date: 2021-10-19  
 Note:

Index 72

RadiMation

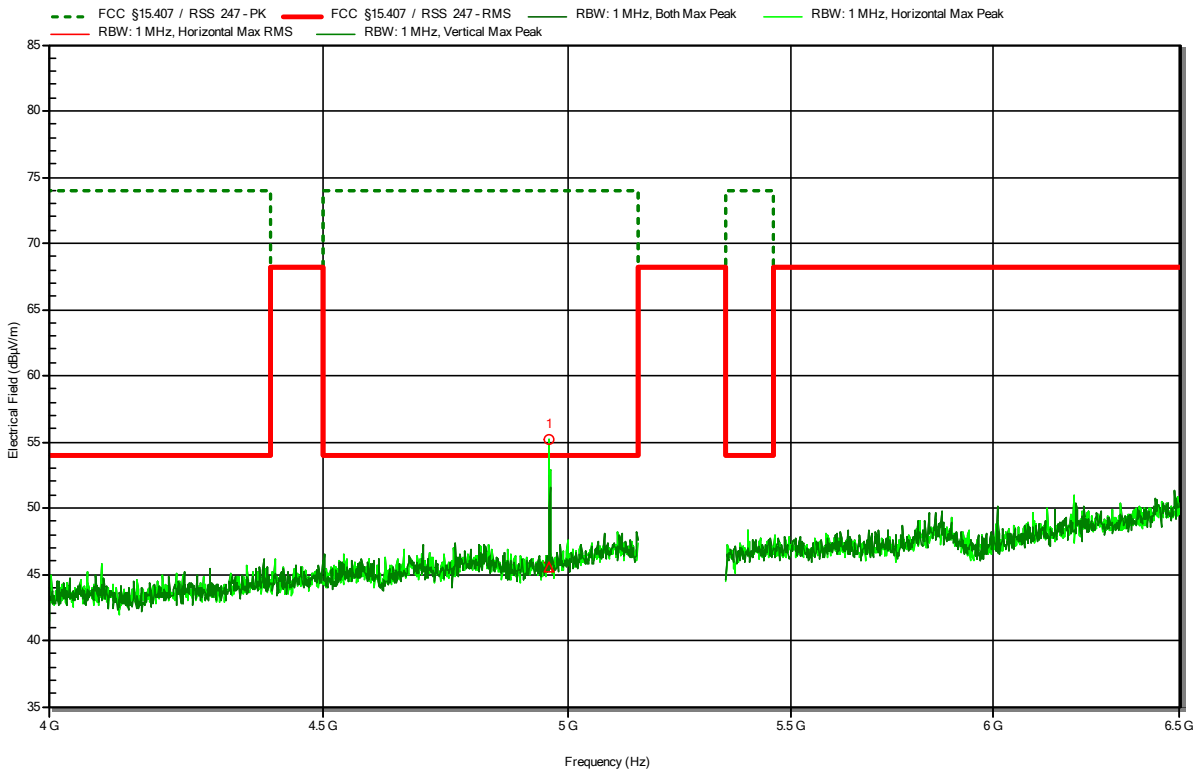

Frequency	Peak	Peak Limit	Peak Difference	Peak Status
4.96 GHz	55.2 dBµV/m	74 dBµV/m	-18.8 dB	Pass

Frequency	RMS	RMS Limit	RMS Difference	RMS Status
4.96 GHz	45.55 dBµV/m	54 dBµV/m	-8.45 dB	Pass

**Radiated Spurious Emissions according to RSS-247 Issue 2, FCC 15.407**

Project Number: G0M-2108-9971  
 Applicant: Leica Geosystems AG  
 Model Description: Imaging Laser Scanner  
 Model: BLK360 G2  
 Test Sample ID: 36490  
 Test Site: Eurofins Product Service GmbH  
 Operator: Mr. Degenhardt  
 Measurement software: RadiMation, version 2020.1.8  
 Test Conditions: Tnom: 23 °Celsius, Vnom: 7.2 V (lithium battery), type: GEB825  
 Antenna: Schwarzbeck HWRD 650  
 Measurement distance: 3 m  
 Mode: Tx; 802.11a, CH48, 5240MHz, 6Mbit, BT CH78  
 Test Date: 2021-10-19  
 Note:

Index 73

**RadiMation**

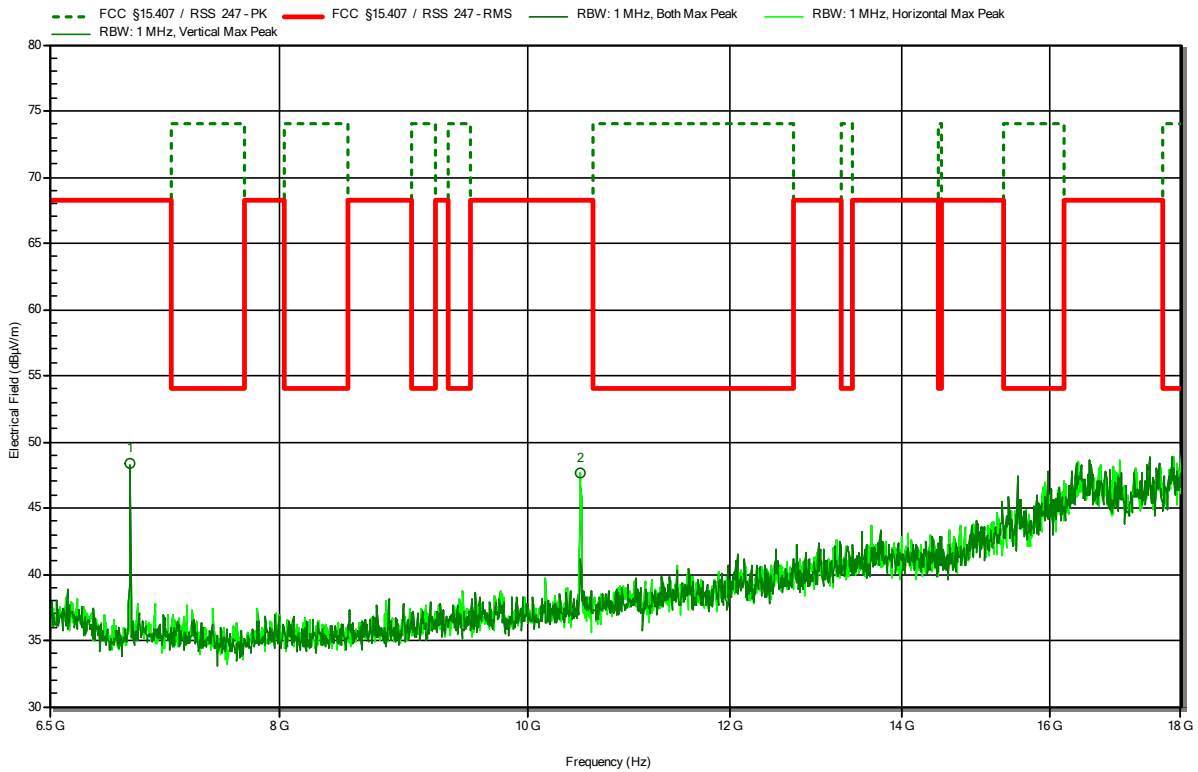

Frequency	Peak	Peak Limit	Peak Difference	Peak Status
6.987 GHz	48.34 dBµV/m	68.2 dBµV/m	-19.86 dB	Pass
10.48 GHz	47.62 dBµV/m	68.2 dBµV/m	-20.58 dB	Pass

**Radiated Spurious Emissions according to RSS-247 Issue 2, FCC 15.407**

Project Number: G0M-2108-9971  
 Applicant: Leica Geosystems AG  
 Model Description: Imaging Laser Scanner  
 Model: BLK360 G2  
 Test Sample ID: 36490  
 Test Site: Eurofins Product Service GmbH  
 Operator: Mr. Degenhardt  
 Measurement software: RadiMation, version 2020.1.8  
 Test Conditions: Tnom: 23 °Celsius, Vnom: 7.2 V (lithium battery), type: GEB825  
 Antenna: Amplifier Research AT4560  
 Measurement distance: 3 m  
 Mode: Tx; 802.11a, CH48, 5240MHz, 6Mbit, BT CH78  
 Test Date: 2021-10-19  
 Note:

Index 83

**RadiMation**

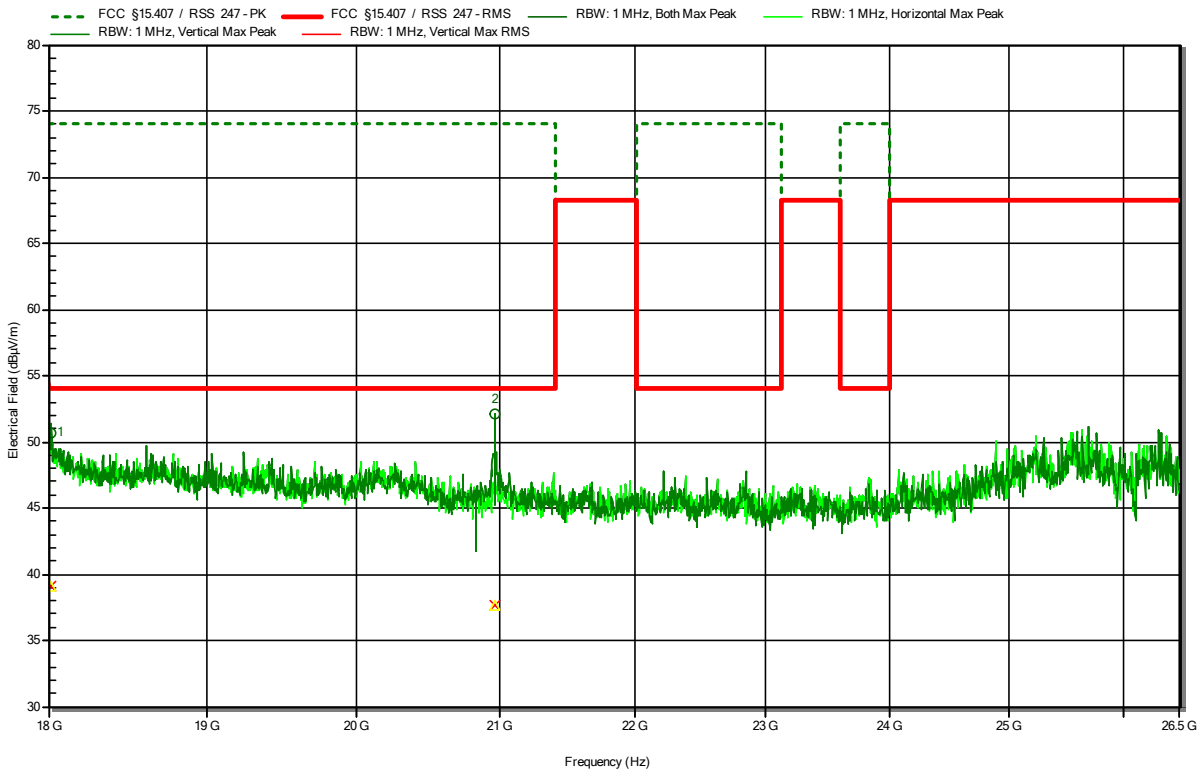

Frequency	Peak	Peak Limit	Peak Difference	Peak Status
18.019 GHz	50.71 dBµV/m	74 dBµV/m	-23.29 dB	Pass
20.969 GHz	52.13 dBµV/m	74 dBµV/m	-21.87 dB	Pass

Frequency	RMS	RMS Limit	RMS Difference	RMS Status
18.019 GHz	39.05 dBµV/m	54 dBµV/m	-14.95 dB	Pass
20.969 GHz	37.63 dBµV/m	54 dBµV/m	-16.37 dB	Pass

**Radiated Spurious Emissions according to RSS-247 Issue 2, FCC 15.407**

Project Number: G0M-2108-9971  
 Applicant: Leica Geosystems AG  
 Model Description: Imaging Laser Scanner  
 Model: BLK360 G2  
 Test Sample ID: 36490  
 Test Site: Eurofins Product Service GmbH  
 Operator: Mr. Degenhardt  
 Measurement software: RadiMation, version 2020.1.8  
 Test Conditions: Tnom: 23 °Celsius, Vnom: 7.2 V (lithium battery), type: GEB825  
 Antenna: 22240-25  
 Measurement distance: 3 m  
 Mode: Tx; 802.11a, CH48, 5240MHz, 6Mbit, BT CH78  
 Test Date: 2021-10-19  
 Note:

Index 87

**RadiMation**

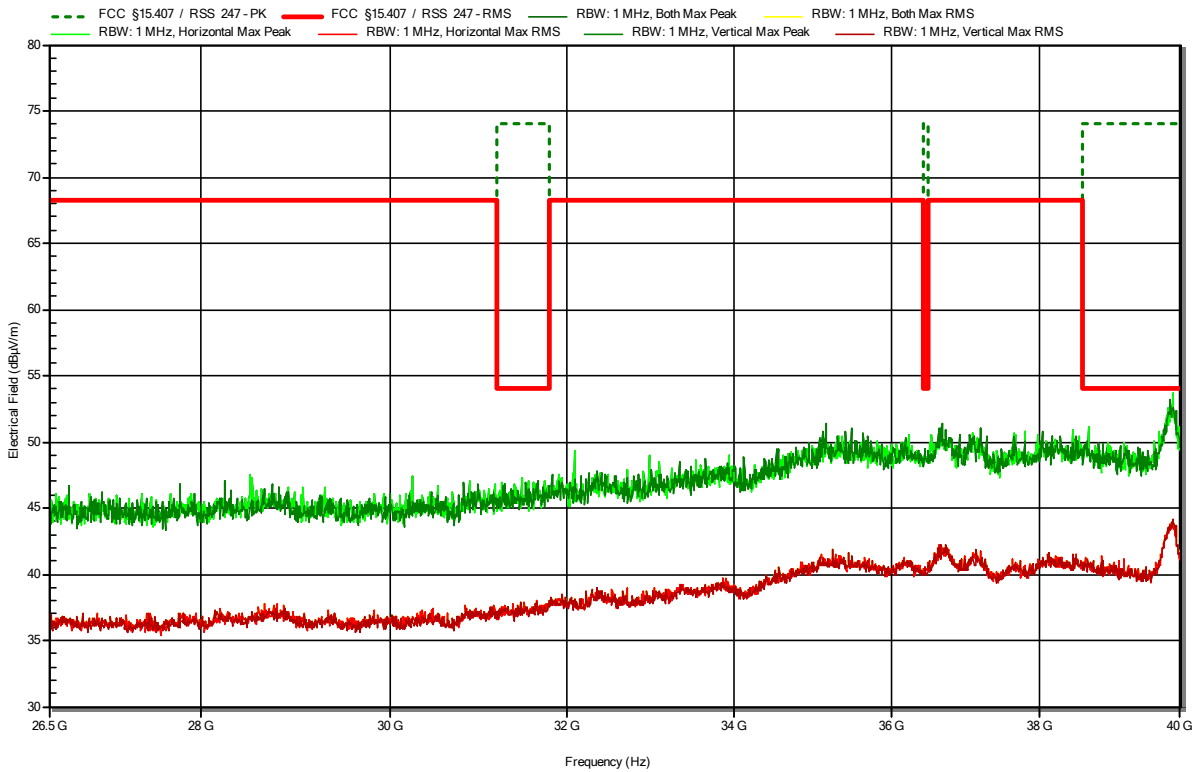

=== END OF TEST REPORT ===