



FCC TEST REPORT (BLUETOOTH/DTS)

REPORT NO.: RF140808E04-2

MODEL NO.: QCNFA324

FCC ID: PPD-QCNFA324

IC: 4104A-QCNFA324

RECEIVED: Aug. 08, 2014

TESTED: Aug. 27 to Oct. 16, 2014

ISSUED: Oct. 23, 2014

APPLICANT: Qualcomm Atheros, Inc.

ADDRESS: 1700 Technology Drive, San Jose, CA 95110

ISSUED BY: Bureau Veritas Consumer Products Services (H.K.) Ltd., Taoyuan Branch Hsin Chu Laboratory

LAB ADDRESS: No. 81-1, Lu Liao Keng, 9th Ling, Wu Lung Tsuen, Chiung Lin Hsiang, Hsin Chu Hsien 307, Taiwan, R.O.C.

TEST LOCATION (1): No. 81-1, Lu Liao Keng, 9th Ling, Wu Lung Tsuen, Chiung Lin Hsiang, Hsin Chu Hsien 307, Taiwan, Taiwan, R.O.C.

TEST LOCATION (2): No.49, Ln. 206, Wende Rd., Shangshan Tsuen, Chiung Lin Hsiang, Hsin Chu Hsien 307, Taiwan, Taiwan, R.O.C.

This report should not be used by the client to claim product certification, approval, or endorsement by TAF or any government agencies.



This report is for your exclusive use. Any copying or replication of this report to or for any other person or entity, or use of our name or trademark, is permitted only with our prior written permission. This report sets forth our findings solely with respect to the test samples identified herein. The results set forth in this report are not indicative or representative of the quality or characteristics of the lot from which a test sample was taken or any similar or identical product unless specifically and expressly noted. Our report includes all of the tests requested by you and the results thereof based upon the information that you provided to us. You have 60 days from date of issuance of this report to notify us of any material error or omission caused by our negligence, provided, however, that such notice shall be in writing and shall specifically address the issue you wish to raise. A failure to raise such issue within the prescribed time shall constitute your unqualified acceptance of the completeness of this report, the tests conducted and the correctness of the report contents. Unless specific mention, the uncertainty of measurement has been explicitly taken into account to declare the compliance or non-compliance to the specification

TABLE OF CONTENTS

RELEASE CONTROL RECORD	6
1 CERTIFICATION	7
2 SUMMARY OF TEST RESULTS	8
2.1 MEASUREMENT UNCERTAINTY	10
3 GENERAL INFORMATION	11
3.1 GENERAL DESCRIPTION OF EUT(BLUETOOTH/DTS).....	11
3.2 DESCRIPTION OF ANTENNA.....	12
3.3 DESCRIPTION OF TEST MODES	13
3.4 TEST MODE APPLICABILITY AND TESTED CHANNEL DETAIL:	14
3.5 GENERAL DESCRIPTION OF APPLIED STANDARDS	18
3.6 DUTY CYCLE OF TEST SIGNAL	19
3.7 DESCRIPTION OF SUPPORT UNITS	20
3.8 CONFIGURATION OF SYSTEM UNDER TEST	20
4 TEST PROCEDURES AND RESULTS(BT-EDR)	21
4.1 MAXIMUM PEAK OUTPUT POWER.....	21
4.1.1 LIMITS OF MAXIMUM PEAK OUTPUT POWER MEASUREMENT	21
4.1.2 INSTRUMENTS	21
4.1.3 TEST PROCEDURES.....	21
4.1.4 DEVIATION FROM TEST STANDARD	21
4.1.5 TEST SETUP	22
4.1.6 EUT OPERATING CONDITION	22
4.1.7 TEST RESULTS	23
4.2 AVERAGE OUTPUT POWER.....	25
4.2.1 FOR REFERENCE.....	25
4.2.2 INSTRUMENTS	25
4.2.3 TEST PROCEDURES.....	25
4.2.4 TEST SETUP	25
4.2.5 EUT OPERATING CONDITION	25
4.2.6 TEST RESULTS	26
4.3 CHANNEL BANDWIDTH	27
4.3.1 LIMITS OF CHANNEL BANDWIDTH.....	27
4.3.2 TEST INSTRUMENTS	27
4.3.3 TEST PROCEDURE	27
4.3.4 DEVIATION FROM TEST STANDARD	27
4.3.5 TEST SETUP	28
4.3.6 EUT OPERATING CONDITION	28
4.3.7 TEST RESULTS	29
4.4 OCCUPIED BANDWIDTH MEASUREMENT	31
4.4.1 TEST INSTRUMENTS	31
4.4.2 TEST PROCEDURE	31
4.4.3 DEVIATION FROM TEST STANDARD	31
4.4.4 TEST SETUP	31
4.4.5 EUT OPERATING CONDITION	31
4.4.6 TEST RESULTS.....	32



4.5	HOPPING CHANNEL SEPARATION	34
4.5.1	LIMIT OF HOPPING CHANNEL SEPARATION.....	34
4.5.2	TEST INSTRUMENTS	34
4.5.3	TEST PROCEDURES.....	34
4.5.4	DEVIATION FROM TEST STANDARD.....	34
4.5.5	TEST SETUP	34
4.5.6	TEST RESULTS.....	35
4.6	NUMBER OF HOPPING FREQUENCY USED	37
4.6.1	LIMIT OF HOPPING FREQUENCY USED.....	37
4.6.2	TEST INSTRUMENTS	37
4.6.3	TEST PROCEDURES.....	37
4.6.4	DEVIATION FROM TEST STANDARD.....	37
4.6.5	TEST SETUP	38
4.6.6	TEST RESULTS.....	38
4.7	DWELL TIME ON EACH CHANNEL.....	39
4.7.1	LIMIT OF DWELL TIME USED	39
4.7.2	TEST INSTRUMENTS	39
4.7.3	TEST PROCEDURES.....	39
4.7.4	DEVIATION FROM TEST STANDARD.....	39
4.7.5	TEST SETUP	40
4.7.6	TEST RESULTS.....	41
4.8	CONDUCTED OUT-BAND EMISSION MEASUREMENT	49
4.8.1	LIMITS OF CONDUCTED OUT-BAND EMISSION MEASUREMENT	49
4.8.2	TEST INSTRUMENTS	49
4.8.3	TEST PROCEDURE	49
4.8.4	DEVIATION FROM TEST STANDARD.....	49
4.8.1	TEST SETUP	49
4.8.5	EUT OPERATING CONDITION.....	49
4.8.6	TEST RESULTS.....	50
4.9	RADIATED EMISSION MEASUREMENT.....	53
4.9.1	LIMITS OF RADIATED EMISSION MEASUREMENT	53
4.9.2	TEST INSTRUMENTS	54
4.9.3	TEST PROCEDURES.....	56
4.9.4	DEVIATION FROM TEST STANDARD.....	56
4.9.5	TEST SETUP	57
4.9.6	EUT OPERATING CONDITIONS.....	58
4.9.7	TEST RESULTS(MODE 1).....	59
4.9.8	TEST RESULTS(MODE 2).....	66
4.10	CONDUCTED EMISSION MEASUREMENT	73
4.10.1	LIMITS OF CONDUCTED EMISSION MEASUREMENT.....	73
4.10.2	TEST INSTRUMENTS	73
4.10.3	TEST PROCEDURES.....	74
4.10.4	DEVIATION FROM TEST STANDARD.....	74
4.10.5	TEST SETUP	74
4.10.6	EUT OPERATING CONDITIONS.....	75
4.10.7	TEST RESULTS.....	76
5	TEST TYPES AND RESULTS (DTS).....	78
5.1	CONDUCTED OUTPUT POWER MEASUREMENT.....	78



5.1.1	LIMITS OF MAXIMUM OUTPUT POWER MEASUREMENT.....	78
5.1.2	INSTRUMENTS	78
5.1.3	TEST PROCEDURES.....	78
5.1.4	DEVIATION FROM TEST STANDARD.....	78
5.1.5	TEST SETUP	79
5.1.6	EUT OPERATING CONDITIONS.....	79
5.1.7	TEST RESULTS.....	80
5.2	POWER SPECTRAL DENSITY MEASUREMENT	81
5.2.1	LIMITS OF POWER SPECTRAL DENSITY MEASUREMENT	81
5.2.2	TEST INSTRUMENTS	81
5.2.3	TEST PROCEDURE	81
5.2.4	DEVIATION FROM TEST STANDARD.....	81
5.2.5	TEST SETUP	81
5.2.6	EUT OPERATING CONDITION.....	81
5.2.7	TEST RESULTS.....	82
5.3	6DB BANDWIDTH MEASUREMENT	83
5.3.1	LIMITS OF 6DB BANDWIDTH MEASUREMENT.....	83
5.3.2	TEST INSTRUMENTS	83
5.3.3	TEST PROCEDURE	83
5.3.4	DEVIATION FROM TEST STANDARD.....	83
5.3.5	TEST SETUP	83
5.3.6	EUT OPERATING CONDITIONS.....	83
5.3.7	TEST RESULTS.....	84
5.4	OCCUPIED BANDWIDTH MEASUREMENT	85
5.4.1	TEST INSTRUMENTS	85
5.4.2	TEST PROCEDURE	85
5.4.3	TEST SETUP	85
5.4.4	EUT OPERATING CONDITIONS.....	85
5.4.5	TEST RESULTS.....	86
5.5	CONDUCTED OUT-BAND EMISSION MEASUREMENT.....	87
5.5.1	LIMITS OF CONDUCTED OUT-BAND EMISSION MEASUREMENT	87
5.5.2	TEST INSTRUMENTS	87
5.5.3	TEST PROCEDURE	87
5.5.4	DEVIATION FROM TEST STANDARD.....	88
5.5.5	EUT OPERATING CONDITION.....	88
5.5.6	TEST RESULTS.....	88
5.6	UNWANTED EMISSION MEASUREMENT(RADIATED VERSUS CONDUCTED)	90
5.6.1	LIMITS OF UNWANTED EMISSION MEASUREMENT	90
5.6.2	TEST INSTRUMENTS	91
5.6.3	TEST PROCEDURES.....	93
5.6.4	DEVIATION FROM TEST STANDARD.....	93
5.6.5	TEST SETUP	94
5.6.6	EUT OPERATING CONDITIONS.....	95
5.6.7	TEST RESULTS(MODE 1).....	96
5.6.8	TEST RESULTS(MODE 2).....	100
5.7	AC POWER LINE CONDUCTED EMISSION MEASUREMENT.....	104
5.7.1	LIMITS OF AC POWER LINE CONDUCTED EMISSION MEASUREMENT	104
5.7.2	TEST INSTRUMENTS	104



A D T

5.7.3	TEST PROCEDURES.....	105
5.7.4	DEVIATION FROM TEST STANDARD.....	105
5.7.5	TEST SETUP.....	106
5.7.6	EUT OPERATING CONDITIONS.....	106
5.7.7	TEST RESULTS.....	107
6	PHOTOGRAPHS OF THE TEST CONFIGURATION.....	109
7	INFORMATION ON THE TESTING LABORATORIES.....	110
8	APPENDIX A - MODIFICATIONS RECORDERS FOR ENGINEERING CHANGES TO THE EUT BY THE LAB.....	111



A D T

RELEASE CONTROL RECORD

ISSUE NO.	REASON FOR CHANGE	DATE ISSUED
RF140808E04-2	Original release	Oct. 23, 2014



A D T

1 CERTIFICATION

PRODUCT : 2x2 802.11A/B/G/N/AC WiFi + Bluetooth Module
BRAND NAME : Qualcomm Atheros
MODEL NO. : QCNFA324
TEST SAMPLE : R&D SAMPLE
APPLICANT : Qualcomm Atheros, Inc.
TESTED DATE : Aug. 27 to Oct. 16, 2014
STANDARDS : **FCC Part 15, Subpart C (Section 15.247)**
ANSI C63.10-2009
Canada RSS-210 Issue 8 (2010-12)
Canada RSS-Gen Issue 3 (2010-12)

The above equipment (Model: QCNFA324) has been tested by **Bureau Veritas Consumer Products Services (H.K.) Ltd., Taoyuan Branch**, and found compliance with the requirement of the above standards. The test record, data evaluation & Equipment Under Test (EUT) configurations represented herein are true and accurate accounts of the measurements of the sample's EMC characteristics under the conditions specified in this report.

PREPARED BY :  , **DATE:** Oct. 23, 2014
(Claire Kuan, Specialist)

APPROVED BY :  , **DATE:** Oct. 23, 2014
(May Chen, Manager)

2 SUMMARY OF TEST RESULTS

The EUT has been tested according to the following specifications:

For BT-EDR mode:

APPLIED STANDARD: FCC Part 15, Subpart C; RSS-210; RSS-Gen				
STANDARD SECTION		TEST TYPE AND LIMIT	RESULT	REMARK
FCC Part 15	RSS-Gen RSS-210			
15.207	RSS-Gen 7.2.4	AC Power Conducted Emission	PASS	Meet the requirement of limit. Minimum passing margin is -22.42dB at 0.15781MHz.
15.247(a)(1)(iii)	RSS-210 A8.1(b)	Number of Hopping Frequency Used	PASS	Meet the requirement of limit.
15.247(a)(1)(iii)	RSS-210 A8.1(d)	Dwell Time on Each Channel	PASS	Meet the requirement of limit.
15.247(a)(1)	RSS-210 A8.1(d)	1. Hopping Channel Separation 2. Spectrum Bandwidth of a Frequency Hopping Sequence Spread Spectrum System	PASS	Meet the requirement of limit.
15.247(b)	RSS-210 A8.4(2)	Maximum Peak Output Power	PASS	Meet the requirement of limit.
15.247(d)	RSS-210 A8.5	Transmitter Radiated Emissions	PASS	Meet the requirement of limit. Minimum passing margin is -5.1dB at 87.62MHz.
15.247(d)	RSS-210 A8.5	Conducted Out-Band Emission Measurement	PASS	Meet the requirement of limit.
-	RSS-Gen 4.6	Occupied Bandwidth Measurement	-	Meet the requirement.
15.203	-	Antenna Requirement	PASS	Antenna connector is IPEX not a standard connector.

NOTE: Frequency Hopping System operating in 2400-2483.5MHz band and the output power less than 125mW. The hopping channel carrier frequencies separated by a minimum of 25kHz or two-thirds of the 20dB bandwidth of hopping channel whichever is greater.



A D T

For BT-LE mode:

APPLIED STANDARD: FCC PART 15, SUBPART C (SECTION 15.247) ; RSS-210; RSS-Gen				
STANDARD SECTION		TEST TYPE	RESULT	REMARK
FCC Part 15	RSS-Gen			
15.207	RSS-Gen 7.2.4	AC Power Conducted Emission	PASS	Meet the requirement of limit. Minimum passing margin is -15.91dB at 0.20078MHz
15.247(d) 15.209	RSS-210 A8.5	Radiated Emissions	PASS	Meet the requirement of limit. Minimum passing margin is -7.3dB at 31.50MHz & 87.04MHz
15.247(d)	RSS-210 A8.5	Band Edge Measurement	PASS	Meet the requirement of limit.
15.247(a)(2)	RSS-210 A8.2 (a)	6dB bandwidth	PASS	Meet the requirement of limit.
15.247(b)	RSS-210 A8.2 (4)	Conducted power	PASS	Meet the requirement of limit.
15.247(e)	RSS-210 A8.2 (b)	Power Spectral Density	PASS	Meet the requirement of limit.
-	RSS-Gen 4.6	Occupied Bandwidth Measurement	-	Meet the requirement
15.203	-	Antenna Requirement	PASS	Antenna connector is IPEX not a standard connector.

2.1 MEASUREMENT UNCERTAINTY

Where relevant, the following measurement uncertainty levels have been estimated for tests performed on the EUT as specified in CISPR 16-4-2:

This uncertainty represents an expanded uncertainty expressed at approximately the 95% confidence level using a coverage factor of $k=2$.

Measurement	Value
Conducted emissions	2.86 dB
Radiated emissions (30MHz-1GHz)	5.37 dB
Radiated emissions (1GHz -6GHz)	3.65 dB
Radiated emissions (6GHz -18GHz)	3.88 dB
Radiated emissions (18GHz -40GHz)	4.11 dB



3 GENERAL INFORMATION

3.1 GENERAL DESCRIPTION OF EUT(BLUETOOTH/DTS)

PRODUCT	2x2 802.11A/B/G/N/AC WiFi + Bluetooth Module
MODEL NO.	QCNFA324
POWER SUPPLY	3.3Vdc from host equipment
MODULATION TYPE	GFSK, $\pi/4$ -DQPSK, 8DPSK for FHSS 16QAM, QPSK, BPSK for OFDM GFSK for DTS
MODULATION TECHNOLOGY	FHSS, OFDM, DTS
DATE RATE	Up to 3Mbps for BT-EDR mode Up to 24Mbps for BT-HS mode Up to 1Mbps for BT-LE mode
FREQUENCY RANGE	BT-EDR, BT-LE mode: 2402MHz ~ 2480MHz BT-HS mode: 2412MHz ~ 2462MHz
NUMBER OF CHANNEL	BT-EDR mode: 79 BT-HS mode: 11 BT-LE mode: 40
MAX. OUTPUT POWER	BT-EDR mode: 14.555mW BT-LE mode: 1.972mW
ANTENNA TYPE	Please see NOTE
DATA CABLE	NA
I/O PORTS	Refer to user's manual
ASSOCIATED DEVICES	NA

NOTE:

1. There are Bluetooth technology and WLAN technology used for the EUT.
2. The EUT support multiple function, therefore the WLAN OFDM will be cover BT OFDM (low power) scenario.
3. QCNFA324 supports two digital interfaces (USB and UART) for Bluetooth digital end data communication. The Bluetooth RF end is exactly same in both implementations.

Variant No.	Interface
SKU #1	USB interface for BT
SKU #2	UART interface for BT

From the above Variants, SKU #1 was selected as representative model for the test and its data was recorded in this report.



- 4. Spurious Emission (conducted & radiated emission) of the simultaneous operation (WiFi <5GHz> & Bluetooth) have been evaluated and no non-compliance found. The detail combinations of transmitters / frequencies / modes as below table

Mode	Available Channel	Tested Channel	Modulation Technology
5 GHz (802.11a) + Bluetooth (GFSK)	149 to 165	165	OFDM
	0 to 78	0	FHSS

- 5. The above EUT information was declared by manufacturer and for more detailed features description, please refer to the manufacturer's specifications or user's manual.

3.2 DESCRIPTION OF ANTENNA

The antenna gain was declared by client; please refer to the following table:

Antenna set 1									
Transmitter Circuit	Brand	Model	Antenna Type	2.4GHz Gain with cable loss (dBi)	5GHz Gain with cable loss (dBi)	2.4GHz Cable Loss (dBi)	5G Cable Loss (dBi)	Connector Type	Cable Length (mm)
Chain (0)	WNC	81-EBJ15.005	PIFA	3.62	Band 1&2: 3.08 Band 3: 4.76 Band 4: 4.76	1.15	Band 1&2: 1.70 Band 3: 1.74 Band 4: 1.79	IPEX	300
Chain (1)	WNC	81-EBJ15.005	PIFA	3.62	Band 1&2: 3.08 Band 3: 4.76 Band 4: 4.76	1.15	Band 1&2: 1.70 Band 3: 1.74 Band 4: 1.79	IPEX	300
Antenna set 2									
Transmitter Circuit	Brand	Model	Antenna Type	2.4GHz Gain with cable loss (dBi)	5GHz Gain with cable loss (dBi)	Cable Loss (dBi)	Connector Type	Cable Length (mm)	
Chain (0)	Tongda	T-543-8201044-A (Ant 1)	PIFA	3.572	Band 1&2: 3.002 Band 3: 4.546 Band 4: 4.416	NA	IPEX	77	
Chain (1)	Tongda	T-543-8201044-A (Ant 2)	PIFA	3.325	Band 1&2: 2.942 Band 3: 4.622 Band 4: 4.586	NA	IPEX	71	

- Note: 1. Above antenna gains of antenna are Total (H+V).
 2. All of antenna can be application for WLAN and Bluetooth.



3.3 DESCRIPTION OF TEST MODES

79 channels are provided for BT-EDR mode

Channel	Freq. (MHz)	Channel	Freq. (MHz)	Channel	Freq. (MHz)	Channel	Freq. (MHz)
0	2402	20	2422	40	2442	60	2462
1	2403	21	2423	41	2443	61	2463
2	2404	22	2424	42	2444	62	2464
3	2405	23	2425	43	2445	63	2465
4	2406	24	2426	44	2446	64	2466
5	2407	25	2427	45	2447	65	2467
6	2408	26	2428	46	2448	66	2468
7	2409	27	2429	47	2449	67	2469
8	2410	28	2430	48	2450	68	2470
9	2411	29	2431	49	2451	69	2471
10	2412	30	2432	50	2452	70	2472
11	2413	31	2433	51	2453	71	2473
12	2414	32	2434	52	2454	72	2474
13	2415	33	2435	53	2455	73	2475
14	2416	34	2436	54	2456	74	2476
15	2417	35	2437	55	2457	75	2477
16	2418	36	2438	56	2458	76	2478
17	2419	37	2439	57	2459	77	2479
18	2420	38	2440	58	2460	78	2480
19	2421	39	2441	59	2461		

40 channels are provided for BT-LE mode:

CHANNEL	FREQ. (MHZ)	CHANNEL	FREQ. (MHZ)	CHANNEL	FREQ. (MHZ)	CHANNEL	FREQ. (MHZ)
0	2402	10	2422	20	2442	30	2462
1	2404	11	2424	21	2444	31	2464
2	2406	12	2426	22	2446	32	2466
3	2408	13	2428	23	2448	33	2468
4	2410	14	2430	24	2450	34	2470
5	2412	15	2432	25	2452	35	2472
6	2414	16	2434	26	2454	36	2474
7	2416	17	2436	27	2456	37	2476
8	2418	18	2438	28	2458	38	2478
9	2420	19	2440	29	2460	39	2480



3.4 TEST MODE APPLICABILITY AND TESTED CHANNEL DETAIL:

For BT-EDR mode:

EUT CONFIGURE MODE	APPLICABLE TO					DESCRIPTION
	PLC	RE < 1G	RE ≥ 1G	APCM	OB	
1	√	√	√	√	√	Antenna set 1
2	-	√	√	-	-	Antenna set 2

Where **PLC**: Power Line Conducted Emission **RE < 1G**: Radiated Emission below 1GHz
RE ≥ 1G: Radiated Emission above 1GHz **APCM**: Antenna Port Conducted Measurement
OB: Conducted Out-Band Emission Measurement

- Note
1. "-" means no effect.
 2. Mode 1, the EUT's antenna had been pre-tested on the positioned of each 3 axis. The worst case was found when positioned on **X-plane**.
 3. Mode 2, the EUT's antenna had been pre-tested on the positioned of each 3 axis. The worst case was found when positioned on **Y-plane**.

Power Line Conducted Emission Test:

- Pre-Scan has been conducted to determine the worst-case mode from all possible combinations between available modulations, data rates and antenna ports (if EUT with antenna diversity architecture).
- Following channel(s) was (were) selected for the final test as listed below.

Available Channel	Tested Channel	Modulation Type	Packet Type
0 to 78	78	GFSK	DH5

Radiated Emission Test (Below 1 GHz):

- Pre-Scan has been conducted to determine the worst-case mode from all possible combinations between available modulations, data rates and antenna ports (if EUT with antenna diversity architecture).
- Following channel(s) was (were) selected for the final test as listed below.

Available Channel	Tested Channel	Modulation Type	Packet Type
0 to 78	78	GFSK	DH5

Radiated Emission Test (Above 1 GHz):

- Pre-Scan has been conducted to determine the worst-case mode from all possible combinations between available modulations, data rates and antenna ports (if EUT with antenna diversity architecture).
- Following channel(s) was (were) selected for the final test as listed below.

Available Channel	Tested Channel	Modulation Type	Packet Type
0 to 78	0, 39, 78	GFSK	DH5
0 to 78	0, 39, 78	8DPSK	3DH5

Antenna Port Conducted Measurement:

- Pre-Scan has been conducted to determine the worst-case mode from all possible combinations between available modulations, data rates and antenna ports (if EUT with antenna diversity architecture).
- Following channel(s) was (were) selected for the final test as listed below.

Available Channel	Tested Channel	Modulation Type	Packet Type
0 to 78	0, 39, 78	GFSK	DH5
0 to 78	0, 39, 78	8DPSK	3DH5

Conducted Out-Band Measurement:

- Pre-Scan has been conducted to determine the worst-case mode from all possible combinations between available modulations, data rates and antenna ports (if EUT with antenna diversity architecture).
- Following channel(s) was (were) selected for the final test as listed below.

Available Channel	Tested Channel	Modulation Type	Packet Type
0 to 78	0, 78	GFSK	DH5
0 to 78	0, 78	8DPSK	3DH5

TEST CONDITION:

APPLICABLE TO	ENVIRONMENTAL CONDITIONS	INPUT POWER (SYSTEM)	TESTED BY
PLC	30deg. C, 70%RH	120Vac, 60Hz	Mike Hsieh
RE<1G	19deg. C, 65%RH	120Vac, 60Hz	Andy Ho
RE≥1G	24deg. C, 68%RH	120Vac, 60Hz	Andy Ho
APCM	25deg. C, 60%RH	120Vac, 60Hz	James Chan
OB	25deg. C, 60%RH	120Vac, 60Hz	James Chan



For BT-LE mode:

EUT CONFIGURE MODE	APPLICABLE TO					DESCRIPTION
	PLC	RE < 1G	RE ≥ 1G	APCM	OB	
1	√	√	√	√	√	Antenna set 1
2	-	√	√	-	-	Antenna set 2

Where **PLC**: Power Line Conducted Emission **RE < 1G**: Radiated Emission below 1GHz
RE ≥ 1G: Radiated Emission above 1GHz **APCM**: Antenna Port Conducted Measurement
OB: Conducted Out-Band Emission Measurement

- Note
1. “-” means no effect.
 2. Mode 1, the EUT’s antenna had been pre-tested on the positioned of each 3 axis. The worst case was found when positioned on **X-plane**.
 3. Mode 2, the EUT’s antenna had been pre-tested on the positioned of each 3 axis. The worst case was found when positioned on **Y-plane**.

POWER LINE CONDUCTED EMISSION TEST:

- Pre-Scan has been conducted to determine the worst-case mode from all possible combinations between available modulations, data rates and antenna ports (if EUT with antenna diversity architecture).
- Following channel(s) was (were) selected for the final test as listed below.

MODE	AVAILABLE CHANNEL	TESTED CHANNEL	MODULATION TYPE	DATA RATE (Mbps)
BT-LE	0 to 39	19	GFSK	1

RADIATED EMISSION TEST (BELOW 1 GHz):

- Pre-Scan has been conducted to determine the worst-case mode from all possible combinations between available modulations, data rates and antenna ports (if EUT with antenna diversity architecture).
- Following channel(s) was (were) selected for the final test as listed below.

MODE	AVAILABLE CHANNEL	TESTED CHANNEL	MODULATION TYPE	DATA RATE (Mbps)
BT-LE	0 to 39	19	GFSK	1

RADIATED EMISSION TEST (ABOVE 1 GHz):

- Pre-Scan has been conducted to determine the worst-case mode from all possible combinations between available modulations, data rates and antenna ports (if EUT with antenna diversity architecture).
- Following channel(s) was (were) selected for the final test as listed below.

MODE	AVAILABLE CHANNEL	TESTED CHANNEL	MODULATION TYPE	DATA RATE (Mbps)
BT-LE	0 to 39	0, 19, 39	GFSK	1

ANTENNA PORT CONDUCTED MEASUREMENT:

- Pre-Scan has been conducted to determine the worst-case mode from all possible combinations between available modulations, data rates and antenna ports (if EUT with antenna diversity architecture).
- Following channel(s) was (were) selected for the final test as listed below.

MODE	AVAILABLE CHANNEL	TESTED CHANNEL	MODULATION TYPE	DATA RATE (Mbps)
BT-LE	0 to 39	0, 19, 39	GFSK	1

CONDUCTED OUT-BAND EMISSION MEASUREMENT:

- Pre-Scan has been conducted to determine the worst-case mode from all possible combinations between available modulations, data rates and antenna ports (if EUT with antenna diversity architecture).
- Following channel(s) was (were) selected for the final test as listed below.

MODE	AVAILABLE CHANNEL	TESTED CHANNEL	MODULATION TYPE	DATA RATE (Mbps)
BT-LE	0 to 39	0, 19, 39	GFSK	1

TEST CONDITION:

APPLICABLE TO	ENVIRONMENTAL CONDITIONS	INPUT POWER (SYSTEM)	TESTED BY
PLC	30deg. C, 70%RH	120Vac, 60Hz	Mike Hsieh
RE<1G	19deg. C, 65%RH	120Vac, 60Hz	Andy Ho
RE≥1G	20deg. C, 63%RH	120Vac, 60Hz	Andy Ho
APCM	25deg. C, 60%RH	120Vac, 60Hz	James Chan
OB	25deg. C, 60%RH	120Vac, 60Hz	James Chan



3.5 GENERAL DESCRIPTION OF APPLIED STANDARDS

The EUT is a RF Product. According to the specifications of the manufacturer, it must comply with the requirements of the following standards:

FCC Part 15, Subpart C (Section 15.247)

ANSI C63.10-2009

Canada RSS-210 Issue 8 (2010-12)

Canada RSS-Gen Issue 3 (2010-12)

All test items have been performed and recorded as per the above standards.

3.6 DUTY CYCLE OF TEST SIGNAL

Duty cycle of test signal is < 98 %, duty factor shall be considered.

For BT_LE-GFSK:

Duty cycle = $0.389 \text{ ms} / 0.623 \text{ ms} = 0.639$, Duty factor = $10 * \log(1/0.639) = 1.9$

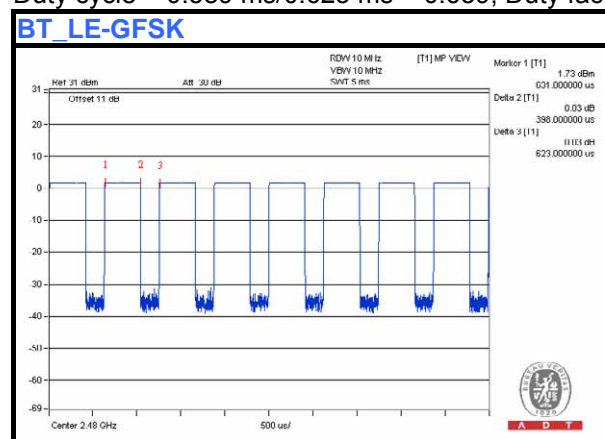



3.7 DESCRIPTION OF SUPPORT UNITS

The EUT has been tested as an independent unit together with other necessary accessories or support units. The following support units or accessories were used to form a representative test configuration during the tests.

No.	Product	Brand	Model No.	Serial No.	FCC ID	Remark
A	NOTEBOOK COMPUTER	DELL	E6420	H62T3R1	FCC DoC	Provided by Lab
B	PCI-E Test tool	Qualcomm Atheros	NA	NA	NA	Supplied by Client

3.8 CONFIGURATION OF SYSTEM UNDER TEST

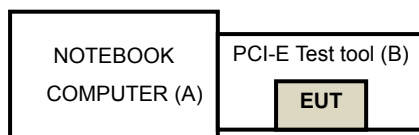

4 TEST PROCEDURES AND RESULTS(BT-EDR)

4.1 MAXIMUM PEAK OUTPUT POWER

4.1.1 LIMITS OF MAXIMUM PEAK OUTPUT POWER MEASUREMENT

The Maximum Peak Output Power Limit is 125mW.

4.1.2 INSTRUMENTS

DESCRIPTION & MANUFACTURER	MODEL NO.	SERIAL NO.	CALIBRATED DATE	CALIBRATED UNTIL
SPECTRUM ANALYZER R&S	FSV 40	100060	May 08, 2014	May 07, 2015

Note:

1. The calibration interval of the above test instruments is 12 months and the calibrations are traceable to NML/ROC and NIST/USA.
2. Tested date : Oct. 15, 2014

4.1.3 TEST PROCEDURES

- a. Check the calibration of the measuring instrument using either an internal calibrator or a known signal from an external generator.
- b. Turn on the EUT and connect it to measurement instrument. Then set it to any one convenient frequency within its operating range. Set a reference level on the measuring instrument equal to the highest peak value.
- c. The center frequency of the spectrum analyzer is set to the fundamental frequency and using 3MHz RBW and 10 MHz VBW.
- d. Measure the captured power within the band and recording the plot.
- e. Repeat above procedures until all frequencies required were complete.

4.1.4 DEVIATION FROM TEST STANDARD

No deviation

4.1.5 TEST SETUP

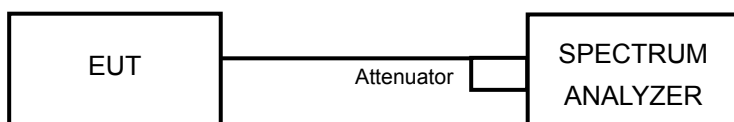

For the actual test configuration, please refer to the related Item – Photographs of the Test Configuration.

4.1.6 EUT OPERATING CONDITION

The software provided by client enabled the EUT to transmit and receive data at lowest, middle and highest channel frequencies individually.



A D T

4.1.7 TEST RESULTS

CHANNEL	FREQUENCY (MHz)	OUTPUT POWER (mW)		OUTPUT POWER (dBm)		POWER LIMIT (mW)	PASS / FAIL
		GFSK	8DPSK	GFSK	8DPSK		
0	2402	10.839	11.776	10.35	10.71	125	PASS
39	2441	13.428	11.143	11.28	10.47	125	PASS
78	2480	14.555	9.572	11.63	9.81	125	PASS

For GFSK

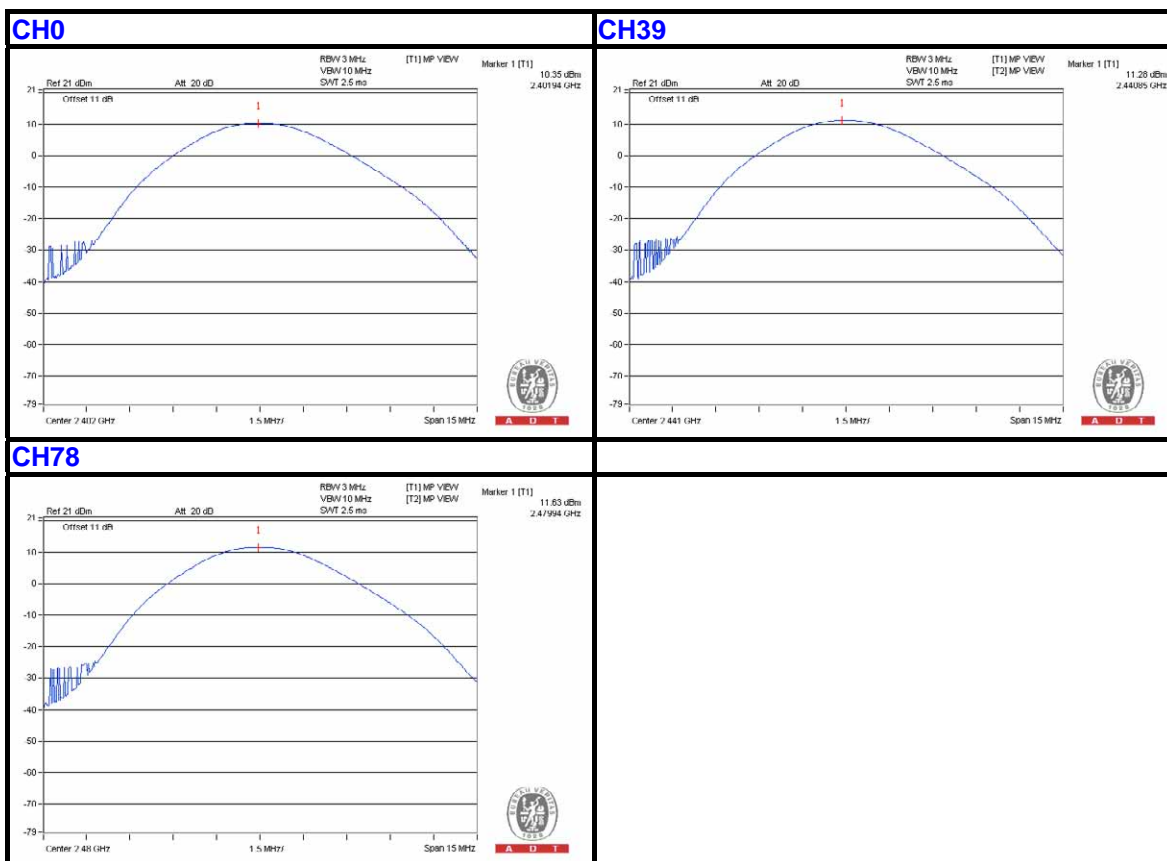



A D T

For 8DPSK

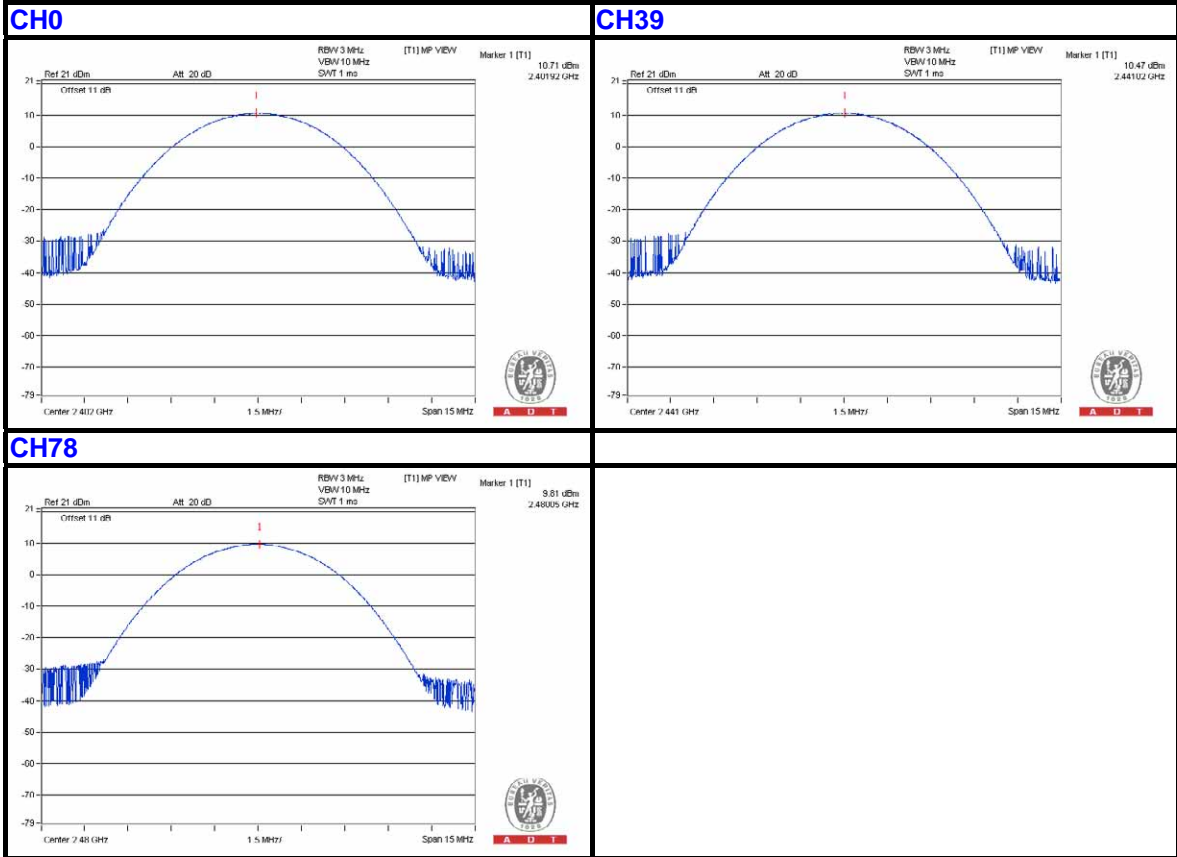

4.2 AVERAGE OUTPUT POWER

4.2.1 FOR REFERENCE.

4.2.2 INSTRUMENTS

DESCRIPTION & MANUFACTURER	MODEL NO.	SERIAL NO.	CALIBRATED DATE	CALIBRATED UNTIL
Power Meter Anritsu	ML2495A	1014008	Apr. 30, 2014	Apr. 29, 2015
Power Sensor Anritsu	MA2411B	0917122	Apr. 30, 2014	Apr. 29, 2015

Note:

1. The calibration interval of the above test instruments is 12 months and the calibrations are traceable to NML/ROC and NIST/USA.
2. Tested date : Oct. 15, 2014

4.2.3 TEST PROCEDURES

The average power sensor was used on the output port of the EUT. A power meter was used to read the response of the average power sensor. Record the peak power level.

4.2.4 TEST SETUP

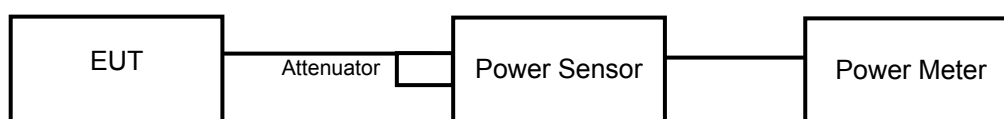

4.2.5 EUT OPERATING CONDITION

The software provided by client enabled the EUT to transmit and receive data at lowest, middle and highest channel frequencies individually.

4.2.6 TEST RESULTS

CHANNEL	FREQUENCY (MHz)	AVERAGE POWER OUTPUT (dBm)	
		GFSK	8DPSK
0	2402	10.14	9.20
39	2441	11.18	8.93
78	2480	11.55	8.35

4.3 CHANNEL BANDWIDTH

4.3.1 LIMITS OF CHANNEL BANDWIDTH

For frequency hopping system operating in the 2400-2483.5MHz, If the 20dB bandwidth of hopping channel is greater than 25kHz, two-thirds 20dB bandwidth of hopping channel shall be a minimum limit for the hopping channel separation.

4.3.2 TEST INSTRUMENTS

DESCRIPTION & MANUFACTURER	MODEL NO.	SERIAL NO.	CALIBRATED DATE	CALIBRATED UNTIL
SPECTRUM ANALYZER R&S	FSV 40	100060	May 08, 2014	May 07, 2015

Note:

1. The calibration interval of the above test instruments is 12 months and the calibrations are traceable to NML/ROC and NIST/USA.
2. Tested date : Oct. 15, 2014

4.3.3 TEST PROCEDURE

- a. Check the calibration of the measuring instrument using either an internal calibrator or a known signal from an external generator.
- b. Turn on the EUT and connect it to measurement instrument. Then set it to any one convenient frequency within its operating range. Set a reference level on the measuring instrument equal to the highest peak value.
- c. Measure the frequency difference of two frequencies that were attenuated 20dB from the reference level. Record the frequency difference as the emission bandwidth.
- d. Repeat above procedures until all frequencies measured were complete.

4.3.4 DEVIATION FROM TEST STANDARD

No deviation

4.3.5 TEST SETUP

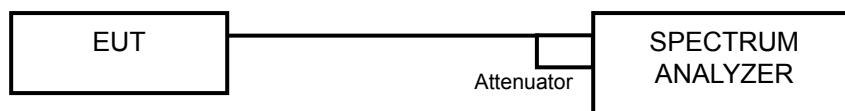

4.3.6 EUT OPERATING CONDITION

The software provided by client enabled the EUT to transmit and receive data at lowest, middle and highest channel frequencies individually.



A D T

4.3.7 TEST RESULTS

CHANNEL	FREQUENCY (MHz)	20dB BANDWIDTH (MHz)	
		GFSK	8DPSK
0	2402	0.97	1.31
39	2441	0.97	1.30
78	2480	0.95	1.30

For GFSK

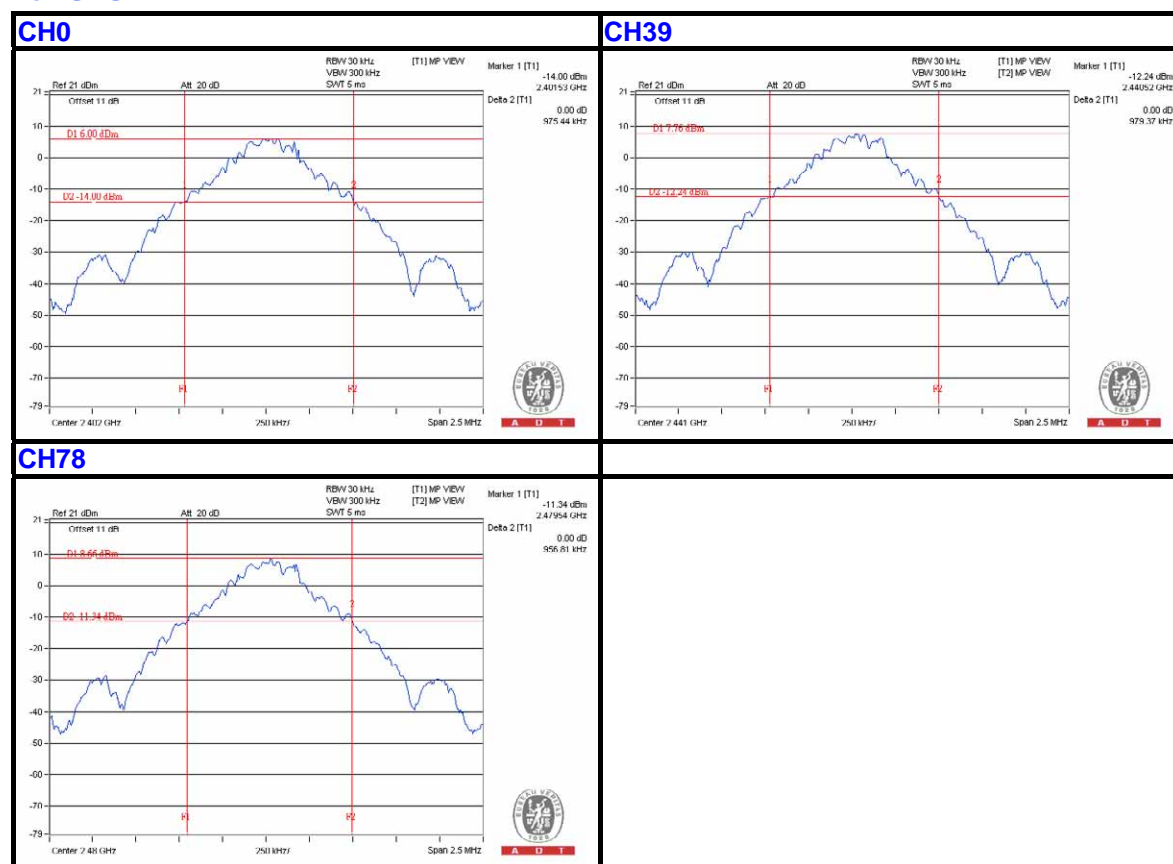



A D T

For 8DPSK

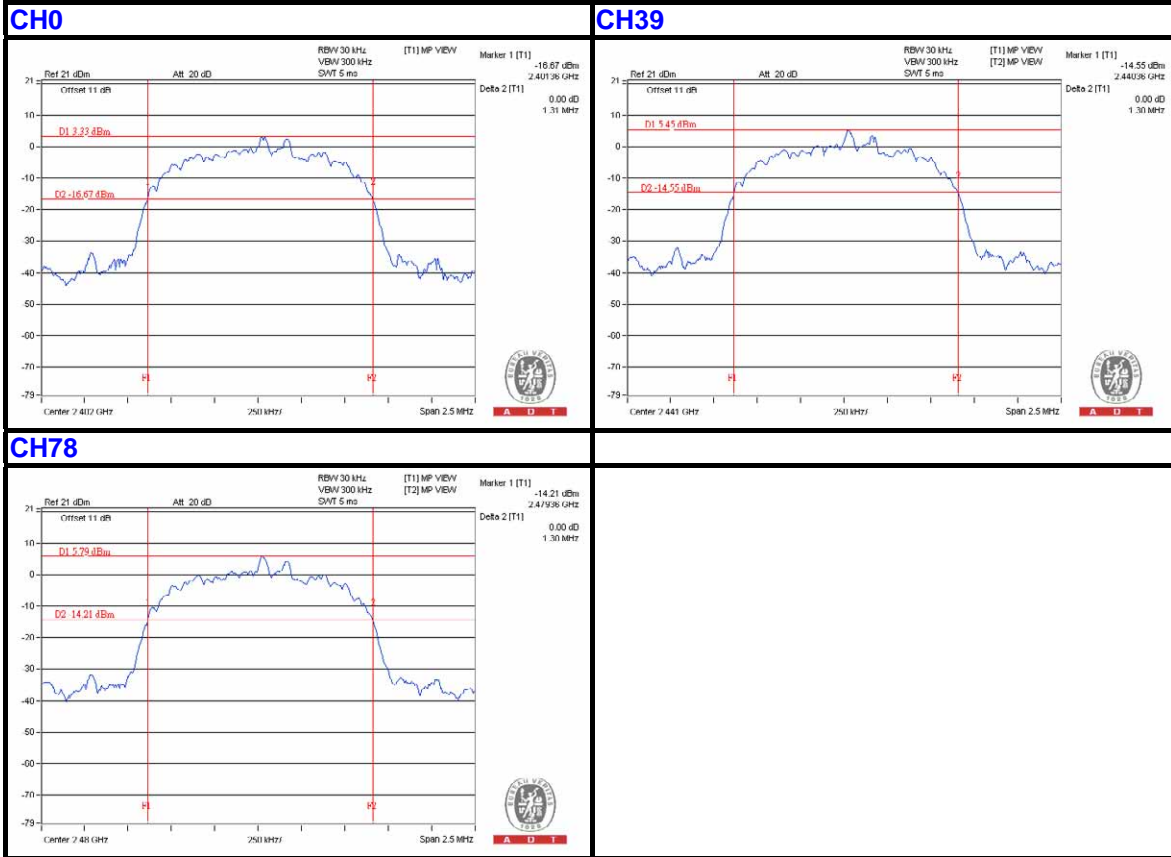



4.4 OCCUPIED BANDWIDTH MEASUREMENT

4.4.1 TEST INSTRUMENTS

DESCRIPTION & MANUFACTURER	MODEL NO.	SERIAL NO.	CALIBRATED DATE	CALIBRATED UNTIL
SPECTRUM ANALYZER R&S	FSV 40	100060	May 08, 2014	May 07, 2015

Note:

1. The calibration interval of the above test instruments is 12 months and the calibrations are traceable to NML/ROC and NIST/USA.
2. Tested date : Oct. 15, 2014

4.4.2 TEST PROCEDURE

The transmitter output was connected to the spectrum analyzer through an attenuator. The bandwidth of the fundamental frequency was measured by spectrum analyzer with 100 kHz RBW and 300 kHz VBW. The width of a frequency band such that, below the lower and above the upper frequency limits, the mean powers emitted are each equal to a specified percentage 0.5 %of the total mean power of a given emission.

4.4.3 DEVIATION FROM TEST STANDARD

No deviation

4.4.4 TEST SETUP

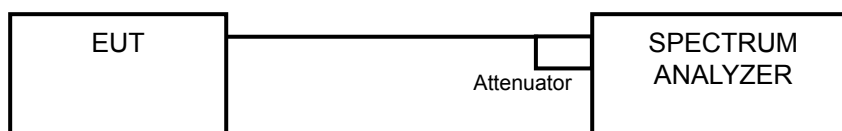

4.4.5 EUT OPERATING CONDITION

The software provided by client to enable the EUT under transmission condition continuously at lowest, middle and highest channel frequencies individually.



A D T

4.4.6 TEST RESULTS

CHANNEL	FREQUENCY (MHz)	OCCUPIED BANDWIDTH (MHz)	
		GFSK	8DPSK
0	2402	0.98	1.21
39	2441	0.99	1.23
78	2480	0.99	1.23

For GFSK

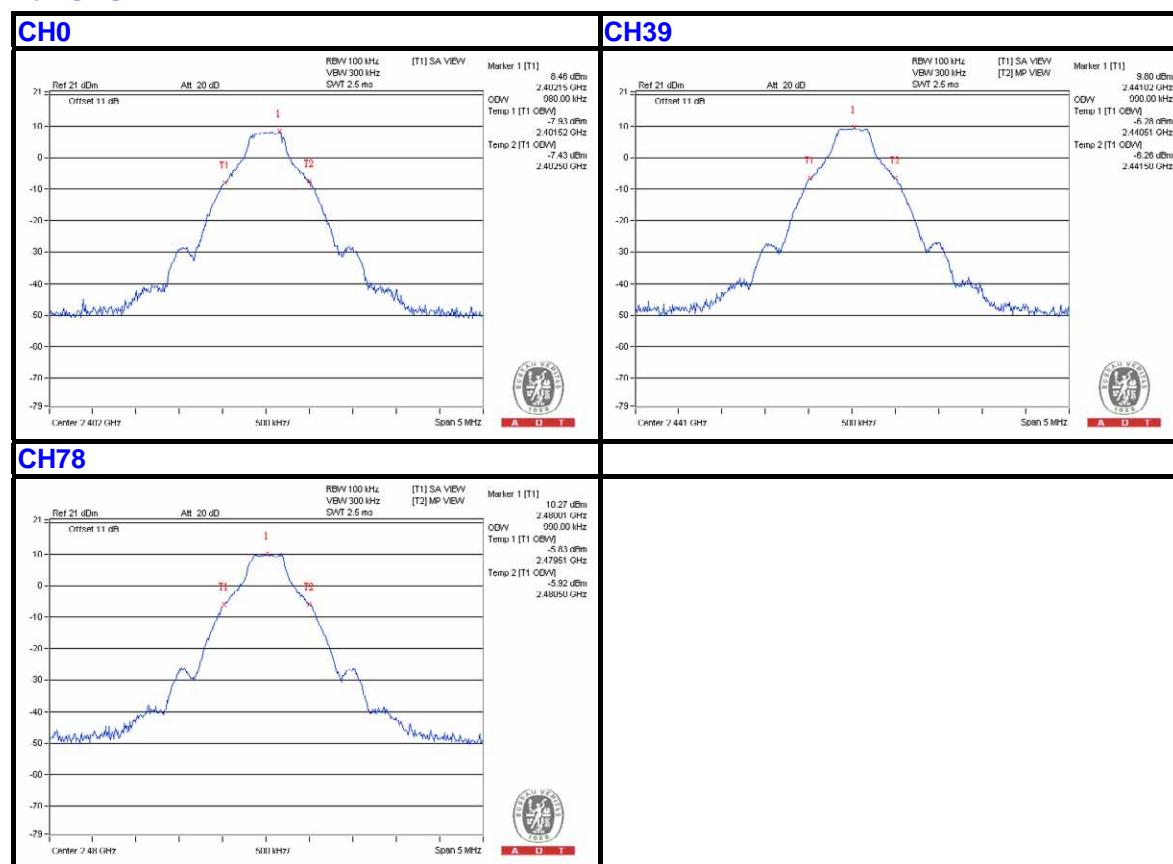



A D T

For 8DPSK

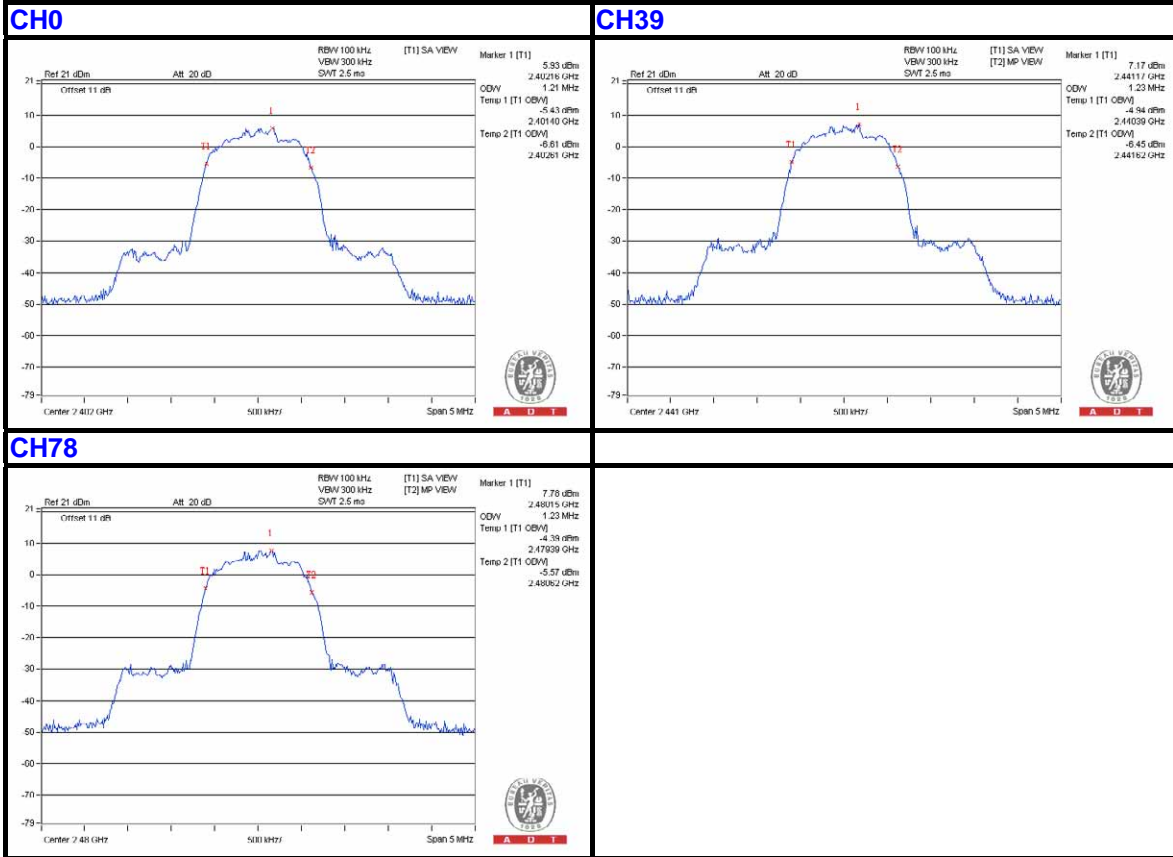

4.5 HOPPING CHANNEL SEPARATION

4.5.1 LIMIT OF HOPPING CHANNEL SEPARATION

At least 25 kHz or two-thirds of 20dB hopping channel bandwidth (whichever is greater).

4.5.2 TEST INSTRUMENTS

DESCRIPTION & MANUFACTURER	MODEL NO.	SERIAL NO.	CALIBRATED DATE	CALIBRATED UNTIL
SPECTRUM ANALYZER R&S	FSV 40	100060	May 08, 2014	May 07, 2015

Note:

1. The calibration interval of the above test instruments is 12 months and the calibrations are traceable to NML/ROC and NIST/USA.
2. Tested date : Oct. 15, 2014

4.5.3 TEST PROCEDURES

- a. Check the calibration of the measuring instrument using either an internal calibrator or a known signal from an external generator.
- b. Turn on the EUT and connect it to measurement instrument. Then set it to any one convenient frequency within its operating range.
- c. By using the MaxHold function record the separation of two adjacent channels.
- d. Measure the frequency difference of these two adjacent channels by SA MARK function. And then plot the result on SA screen.
- e. Repeat above procedures until all frequencies measured were complete.

4.5.4 DEVIATION FROM TEST STANDARD

No deviation

4.5.5 TEST SETUP





A D T

4.5.6 TEST RESULTS

CHANNEL	FREQUENCY (MHz)	ADJACENT CHANNEL SEPARATION (MHz)		20dB BANDWIDTH (MHz)		MINIMUM LIMIT (MHz)		PASS / FAIL
		GFSK	8DPSK	GFSK	8DPSK	GFSK	8DPSK	
0	2402	1.00	1.01	0.97	1.31	0.65	0.88	PASS
39	2441	1.00	1.00	0.97	1.30	0.65	0.87	PASS
78	2480	1.00	1.00	0.95	1.30	0.64	0.87	PASS

NOTE: The minimum limit is two-third 20dB bandwidth.

For GFSK

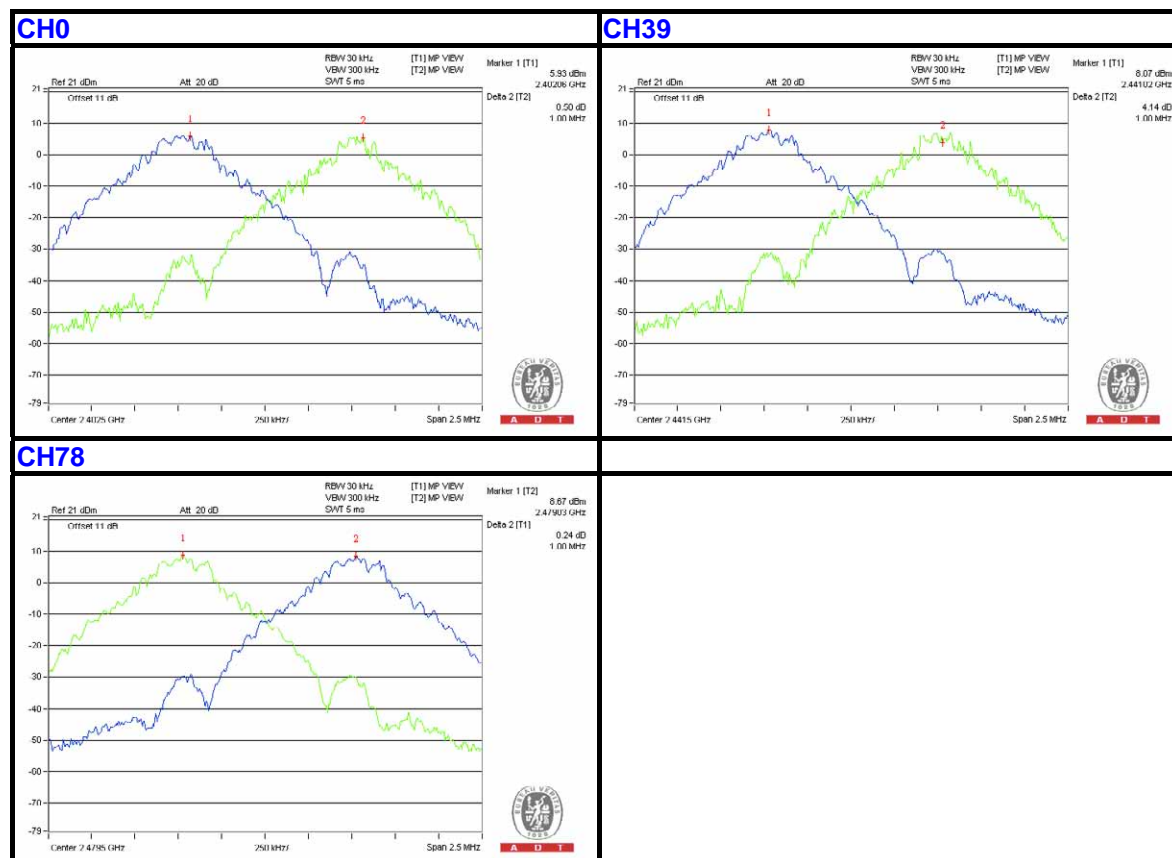



A D T

For 8DPSK

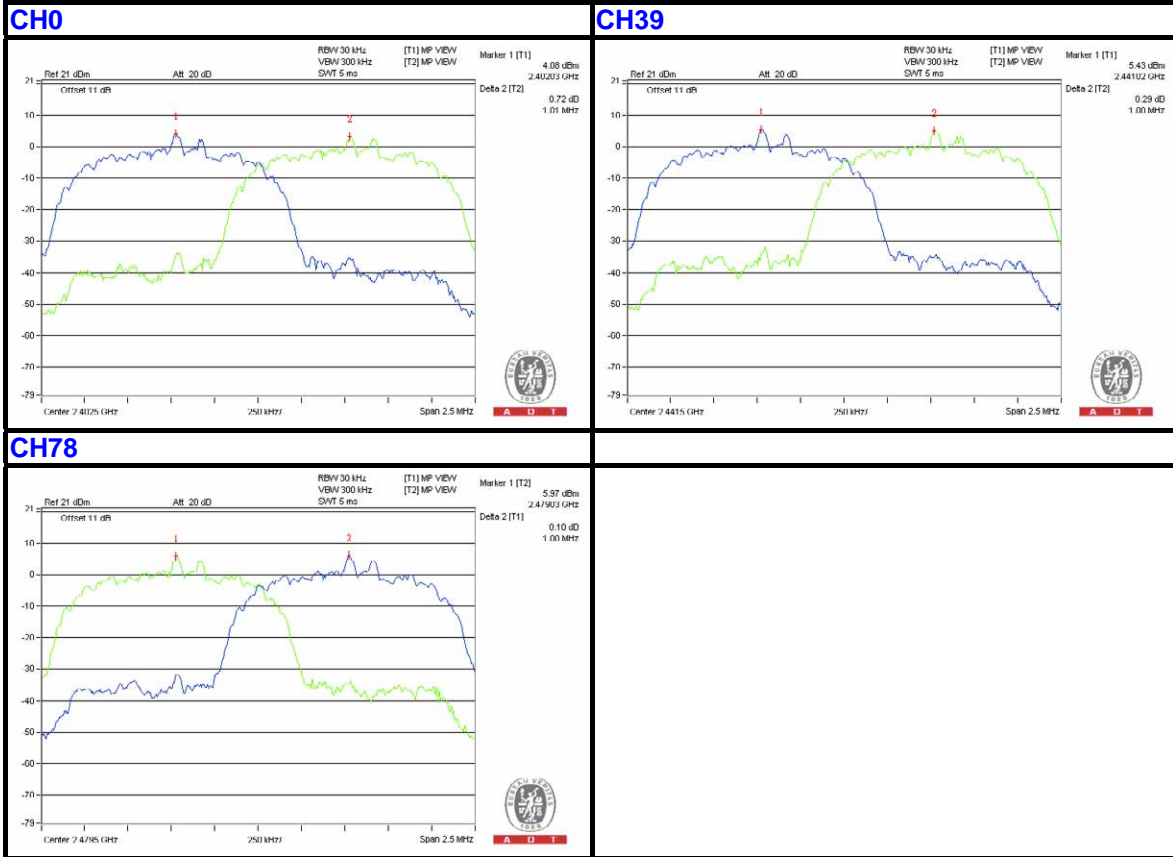

4.6 NUMBER OF HOPPING FREQUENCY USED

4.6.1 LIMIT OF HOPPING FREQUENCY USED

At least 15 hopping frequencies, and should be equally spaced.

4.6.2 TEST INSTRUMENTS

DESCRIPTION & MANUFACTURER	MODEL NO.	SERIAL NO.	CALIBRATED DATE	CALIBRATED UNTIL
SPECTRUM ANALYZER R&S	FSV 40	100060	May 08, 2014	May 07, 2015

Note:

1. The calibration interval of the above test instruments is 12 months and the calibrations are traceable to NML/ROC and NIST/USA.
2. Tested date : Oct. 15, 2014

4.6.3 TEST PROCEDURES

- a. Check the calibration of the measuring instrument (SA) using either an internal calibrator or a known signal from an external generator.
- b. Turn on the EUT and connect its antenna terminal to measurement via a low loss cable. Then set it to any one measured frequency within its operating range and make sure the instrument is operated in its linear range.
- c. Set the SA on MaxHold Mode, and then keep the EUT in hopping mode. Record all the signals from each channel until each one has been recorded.
- d. Set the SA on View mode and then plot the result on SA screen.
- e. Repeat above procedures until all frequencies measured were complete.

4.6.4 DEVIATION FROM TEST STANDARD

No deviation

4.6.5 TEST SETUP



4.6.6 TEST RESULTS

There are 79 hopping frequencies in the hopping mode. Please refer to next pages for the test result. On the plots, it shows that the hopping frequencies are equally spaced.

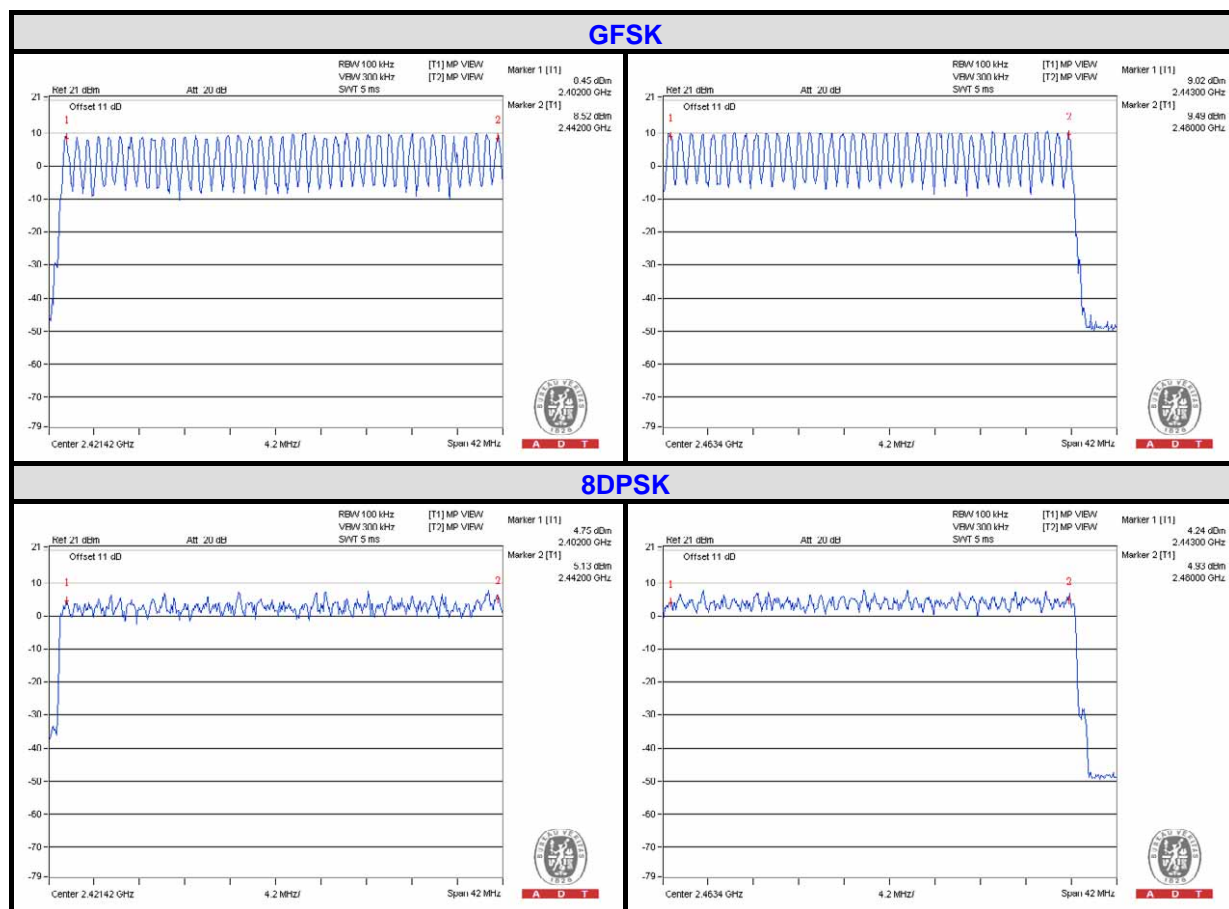

4.7 DWELL TIME ON EACH CHANNEL

4.7.1 LIMIT OF DWELL TIME USED

The average time of occupancy on any channel shall not be greater than 0.4 seconds within a period of 0.4 seconds multiplied by the number of hopping channels employed.

4.7.2 TEST INSTRUMENTS

DESCRIPTION & MANUFACTURER	MODEL NO.	SERIAL NO.	CALIBRATED DATE	CALIBRATED UNTIL
SPECTRUM ANALYZER R&S	FSV 40	100060	May 08, 2014	May 07, 2015

Note:

1. The calibration interval of the above test instruments is 12 months and the calibrations are traceable to NML/ROC and NIST/USA.
2. Tested date : Oct. 15, 2014

4.7.3 TEST PROCEDURES

- a. Check the calibration of the measuring instrument (SA) using either an internal calibrator or a known signal from an external generator.
- b. Turn on the EUT and connect its antenna terminal to measurement via a low loss cable. Then set it to any one measured frequency within its operating range and make sure the instrument is operated in its linear range.
- c. Adjust the center frequency of SA on any frequency be measured and set SA to zero span mode. And then, set RBW and VBW of spectrum analyzer to proper value.
- d. Measure the time duration of one transmission on the measured frequency. And then plot the result with time difference of this time duration.
- e. Repeat above procedures until all different time-slot modes have been completed.

4.7.4 DEVIATION FROM TEST STANDARD

No deviation

4.7.5 TEST SETUP

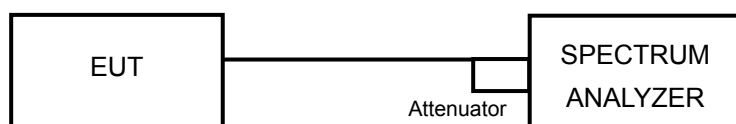

4.7.6 TEST RESULTS

For GFSK:

Mode	Number of transmission in a 31.6 (79Hopping*0.4)	Length of transmission time (msec)	Result (msec)	Limit (msec)
DH1	51 (times / 5 sec) *6.32=322.32 times	0.462	148.91	400
DH3	26 (times / 5 sec) *6.32=164.32 times	1.69	277.7	400
DH5	17 (times / 5 sec) *6.32=107.44 times	3.024	324.9	400

NOTE: Test plots of the transmitting time slot are shown on next page.



A D T

DH1

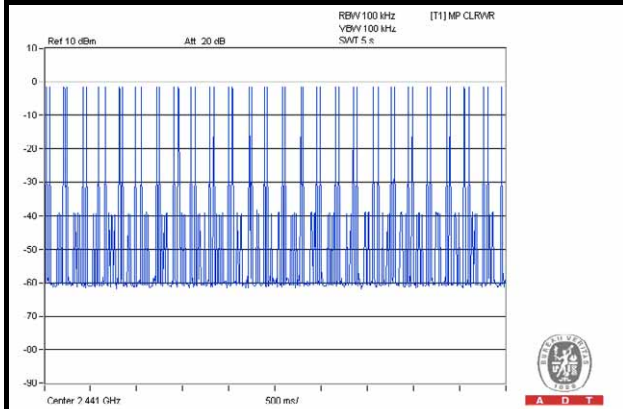

A D T



A D T

DH3

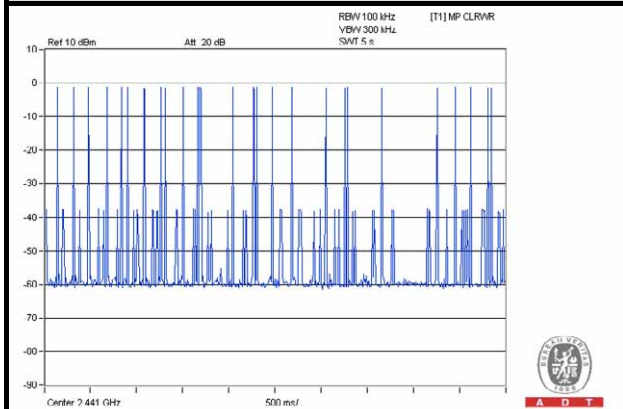

A D T

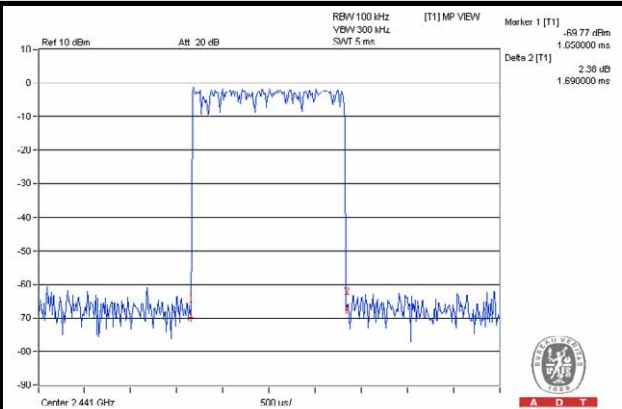

A D T

DH5

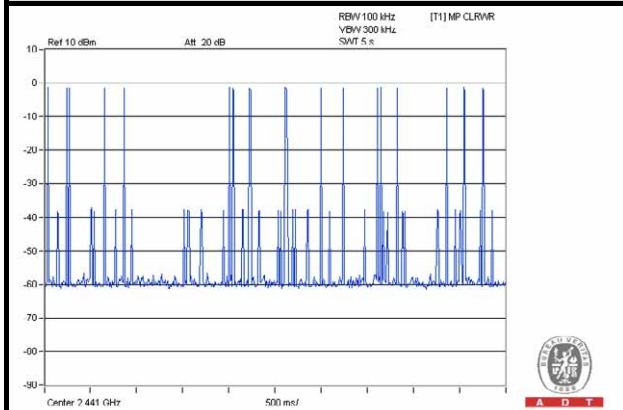

A D T

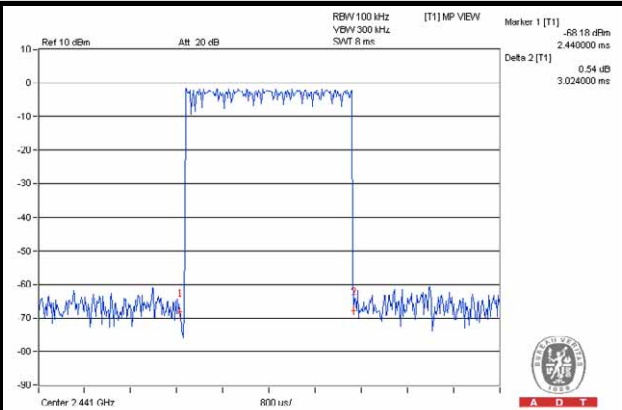

A D T



A D T

For GFSK(AFH):

Mode	Number of transmission in a 8 (20Hopping*0.4)	Length of transmission time (msec)	Result (msec)	Limit (msec)
DH1	50 (times / 5 sec) *1.6=80 times	0.468	37.44	400
DH3	25 (times / 5 sec) *1.6=40 times	1.69	67.6	400
DH5	17 (times / 5 sec) *1.6=27.2 times	3.024	82.253	400

NOTE:

1. Test plots of the transmitting time slot are shown on next page.
2. Minimum number of hopping channels for AFH is 20 channels.



A D T

DH1

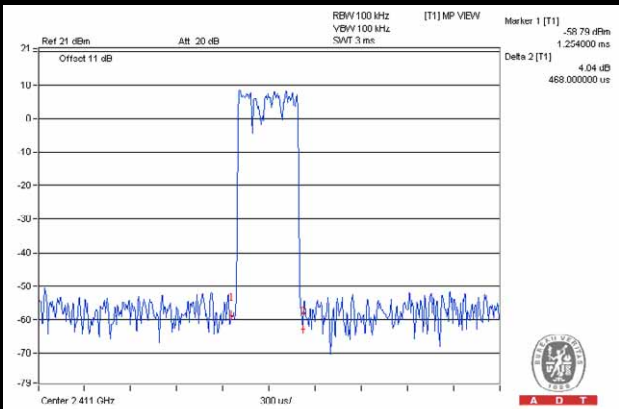
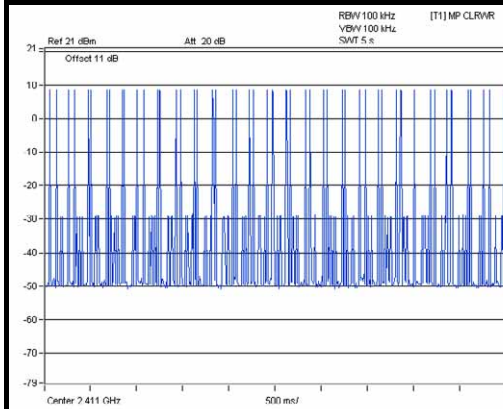

DH3

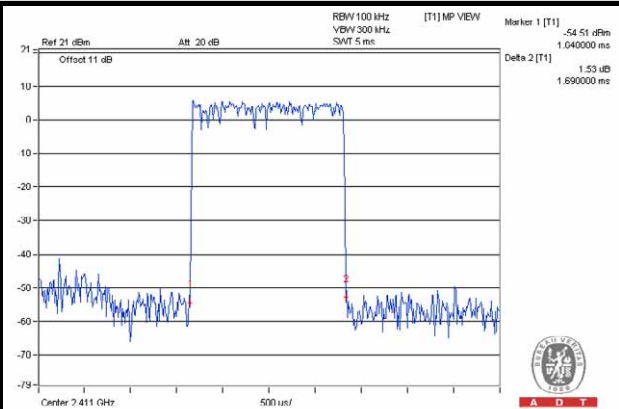
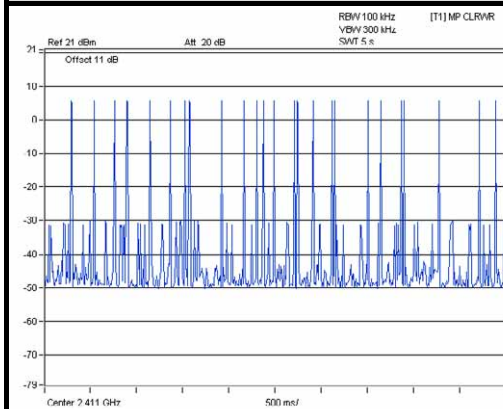

DH5

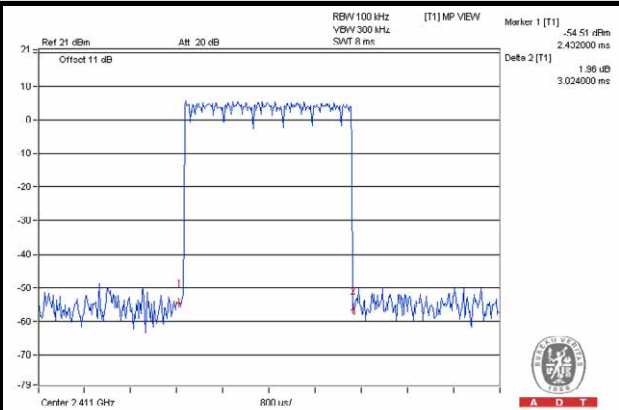
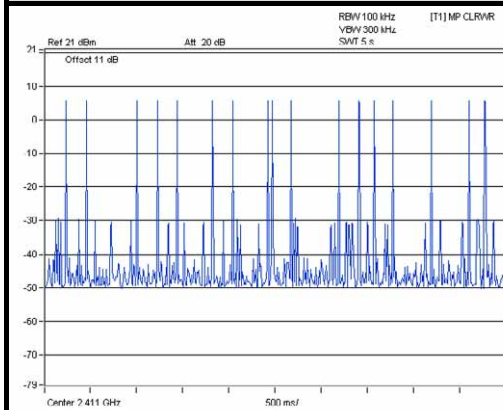



A D T

For 8DPSK:

Mode	Number of transmission in a 31.6 (79Hopping*0.4)	Length of transmission time (msec)	Result (msec)	Limit (msec)
DH1	51 times / 5 sec) *6.32=322.32 times	0.426	137.31	400
DH3	26 (times / 5 sec) *6.32=164.32 times	1.73	284.27	400
DH5	17 (times / 5 sec) *6.32=107.44 times	3.008	323.18	400

NOTE: Test plots of the transmitting time slot are shown on next page.



A D T

3DH1

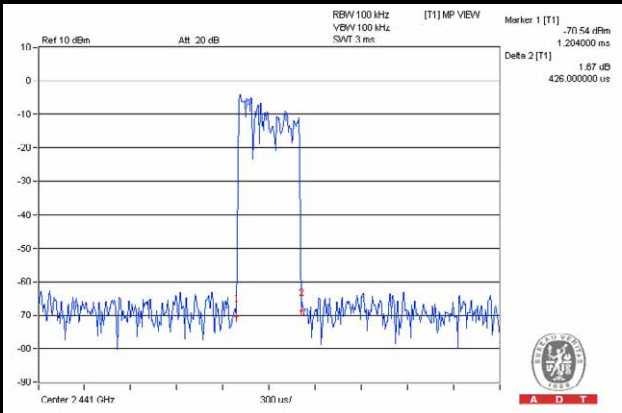
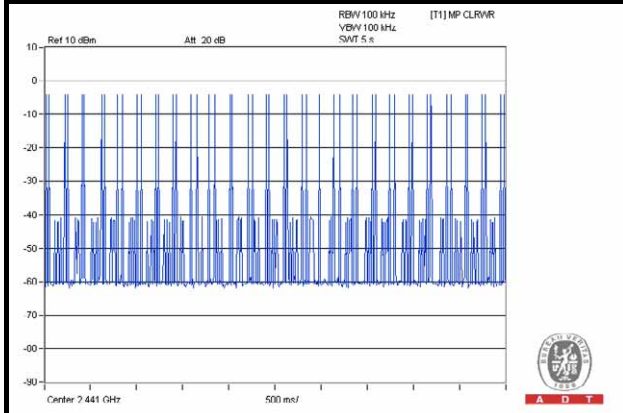

3DH3

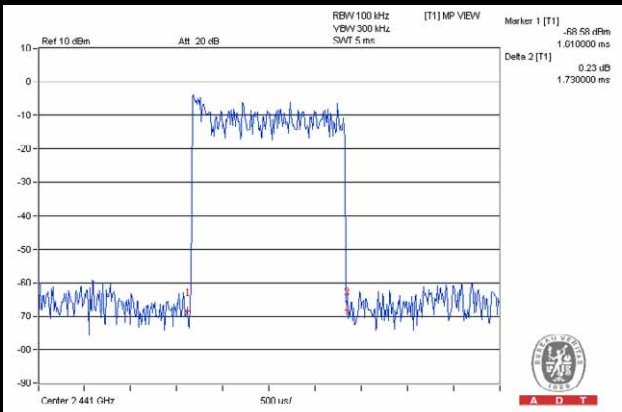
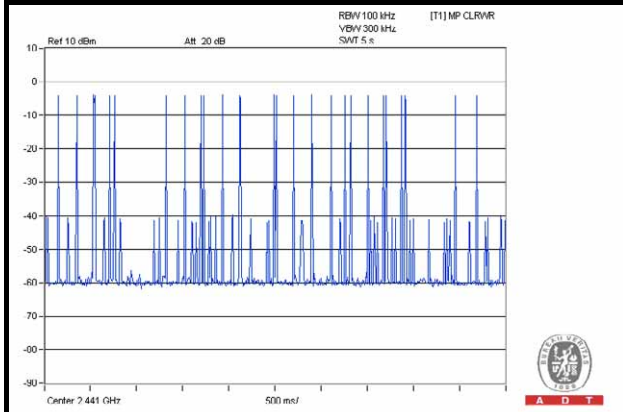

3DH5

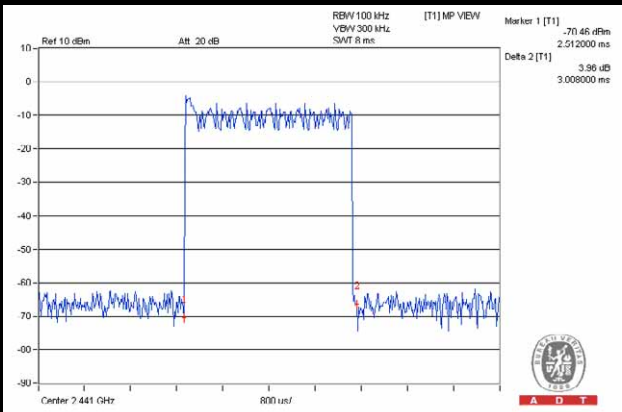
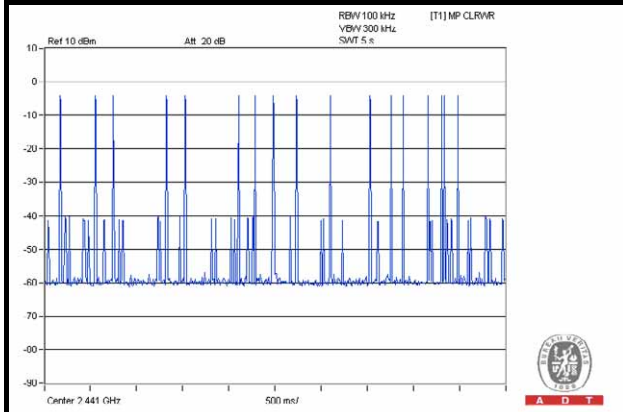



A D T

For 8DPSK(AFH):

Mode	Number of transmission in a 8 (20Hopping*0.4)	Length of transmission time (msec)	Result (msec)	Limit (msec)
DH1	50 (times / 5 sec) *1.6=80 times	0.456	37.21	400
DH3	25 (times / 5 sec) *1.6=40 times	1.73	69.2	400
DH5	17 (times / 5 sec) *1.6=27.2 times	2.976	80.947	400

NOTE:

1. Test plots of the transmitting time slot are shown on next page.
2. Minimum number of hopping channels for AFH is 20 channels.



A D T

DH1

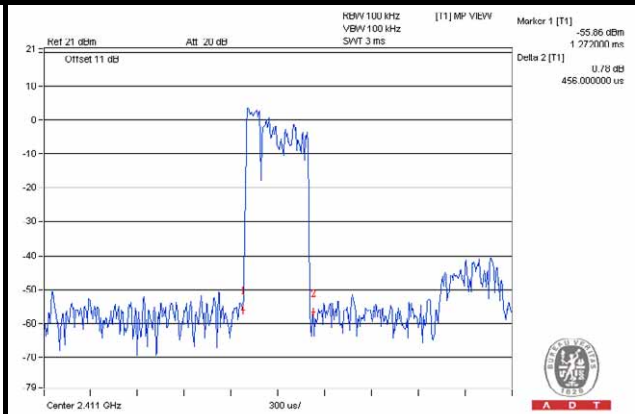
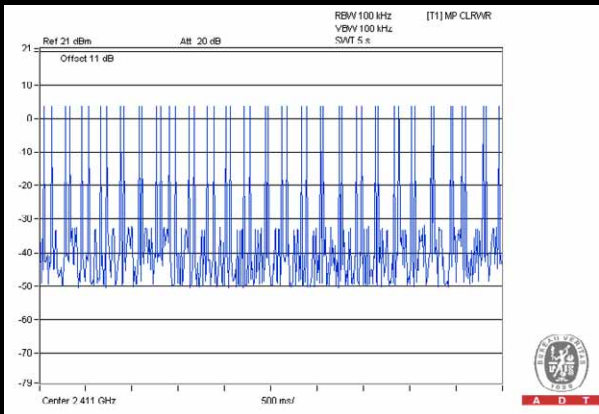

DH3

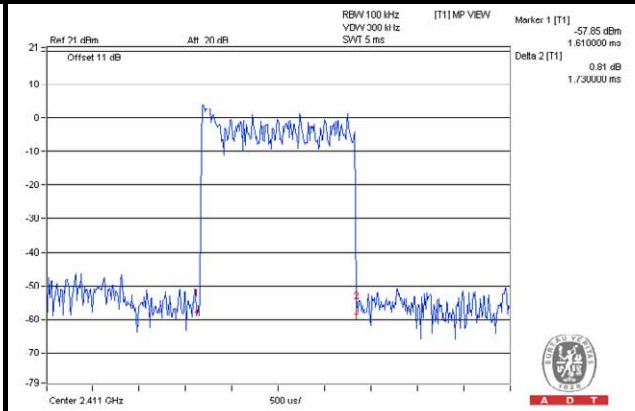
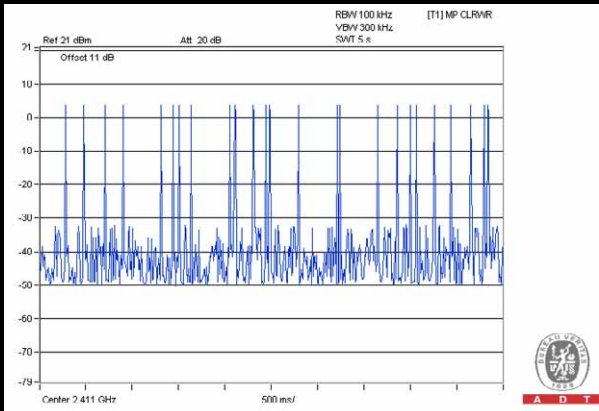

DH5

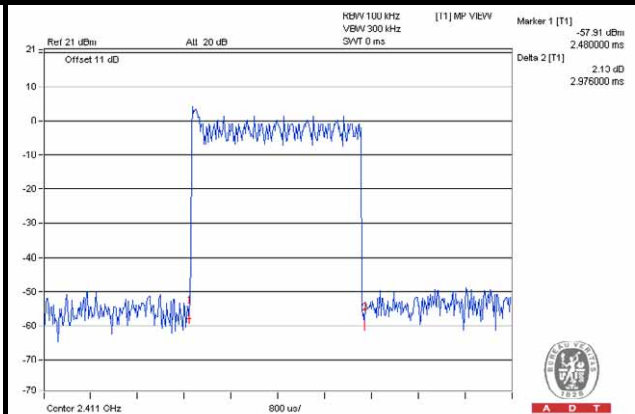
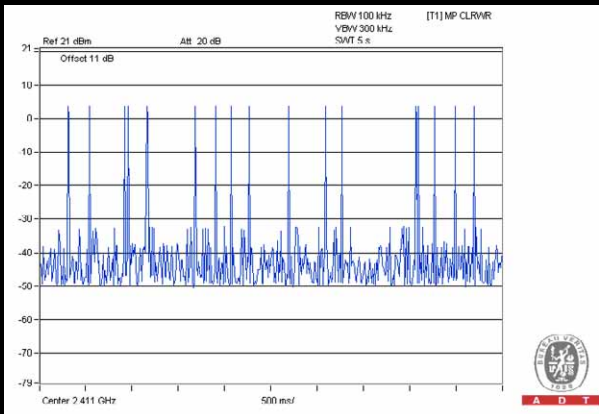

4.8 CONDUCTED OUT-BAND EMISSION MEASUREMENT

4.8.1 LIMITS OF CONDUCTED OUT-BAND EMISSION MEASUREMENT

Below -20dB of the highest emission level of operating band (in 100kHz RBW).

4.8.2 TEST INSTRUMENTS

DESCRIPTION & MANUFACTURER	MODEL NO.	SERIAL NO.	CALIBRATED DATE	CALIBRATED UNTIL
SPECTRUM ANALYZER R&S	FSV 40	100060	May 08, 2014	May 07, 2015

Note:

1. The calibration interval of the above test instruments is 12 months and the calibrations are traceable to NML/ROC and NIST/USA.
2. Tested date : Oct. 15, 2014

4.8.3 TEST PROCEDURE

The transmitter output was connected to the spectrum analyzer via a low lose cable. Set RBW a of spectrum analyzer to 100 kHz and VBW of spectrum analyzer to 300 kHz with suitable frequency span including 100 MHz bandwidth from band edge. The band edges was measured and recorded.

4.8.4 DEVIATION FROM TEST STANDARD

No deviation

4.8.1 TEST SETUP

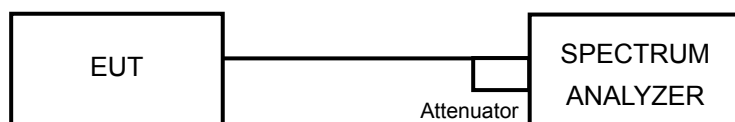

4.8.5 EUT OPERATING CONDITION

The software provided by client enabled the EUT to transmit and receive data at lowest, middle and highest channel frequencies individually.

4.8.6 TEST RESULTS

The spectrum plots are attached on the following images. D1 line indicates the highest level, and D2 line indicates the 20dB offset below D1. It shows compliance with the requirement.



A D T

For GFSK

Hopping disabled_Low Channel

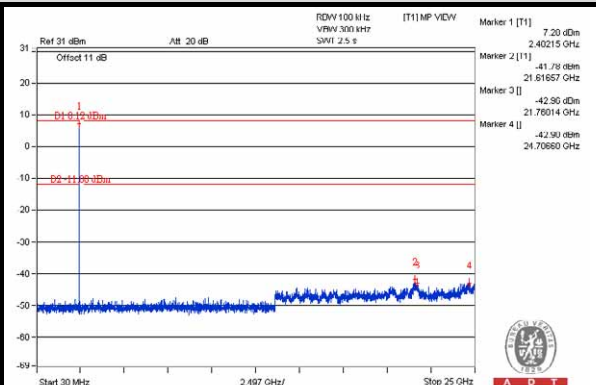
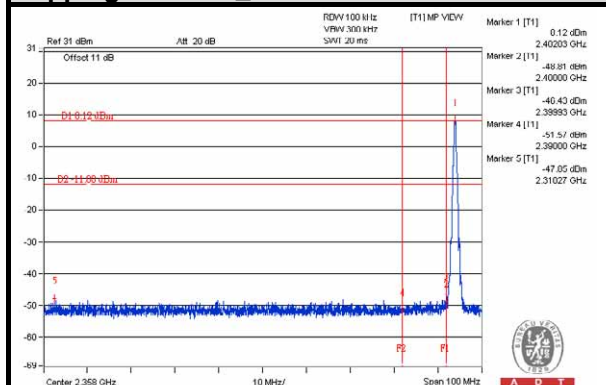

Hopping disabled_High Channel

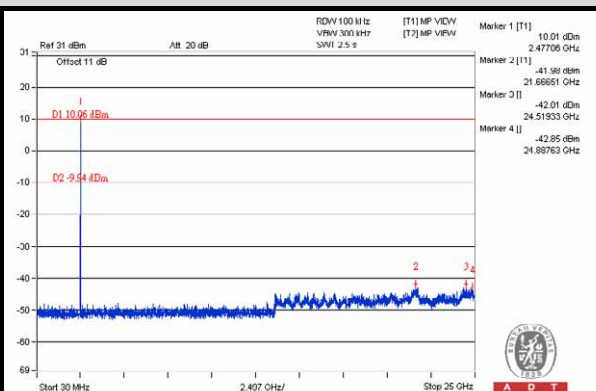
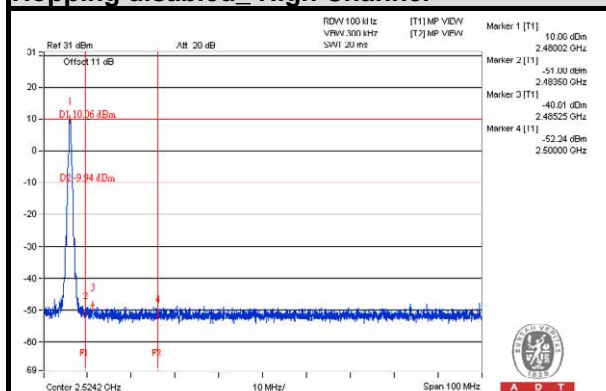

Hopping enabled_Low Channel

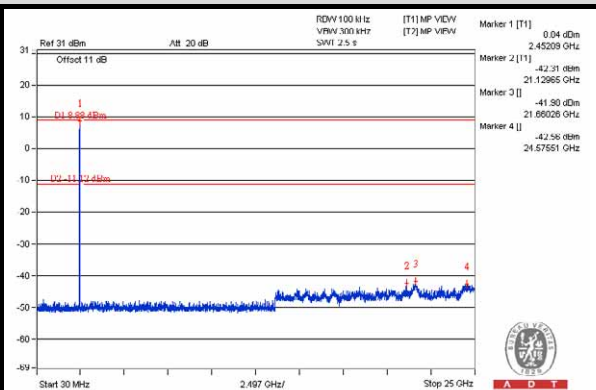
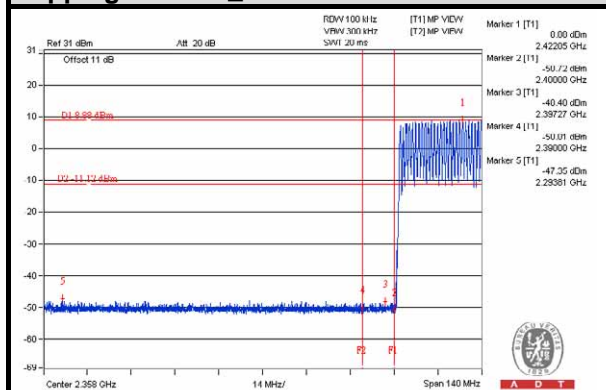

Hopping enabled_High Channel

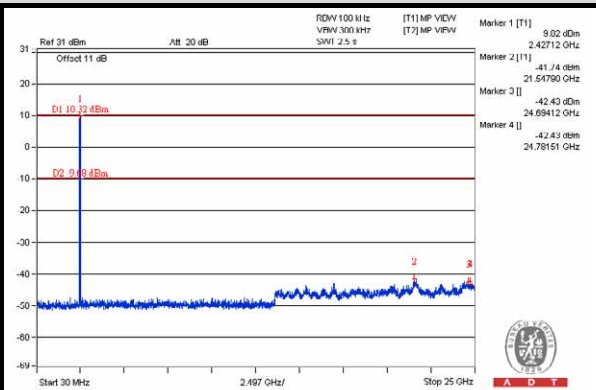
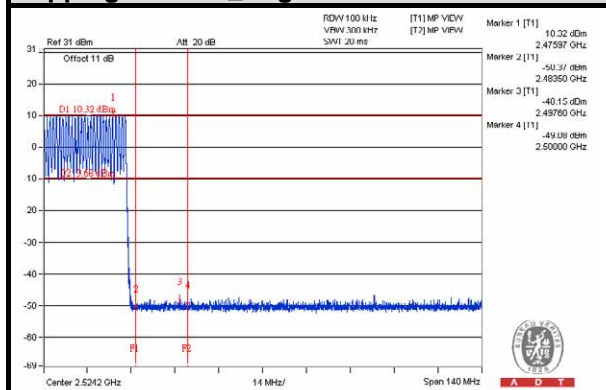



A D T

For 8DPSK

Hopping disabled_Low Channel

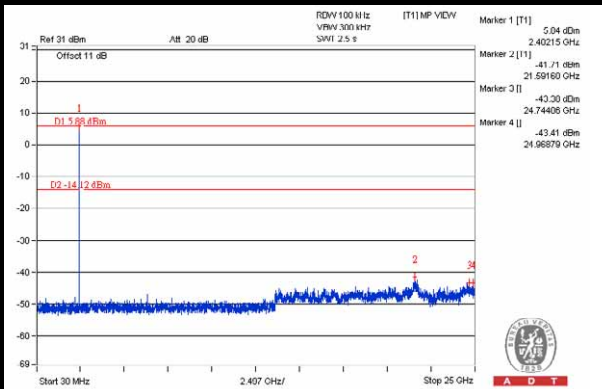
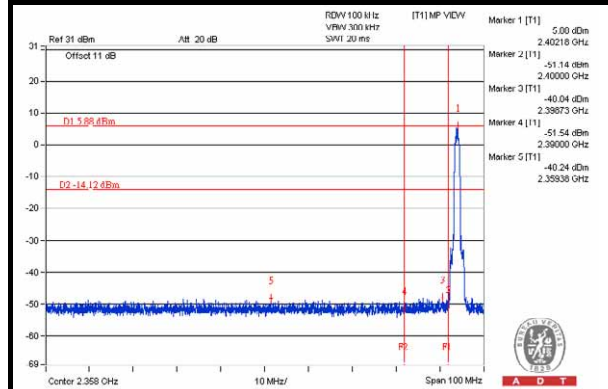

Hopping disabled_High Channel

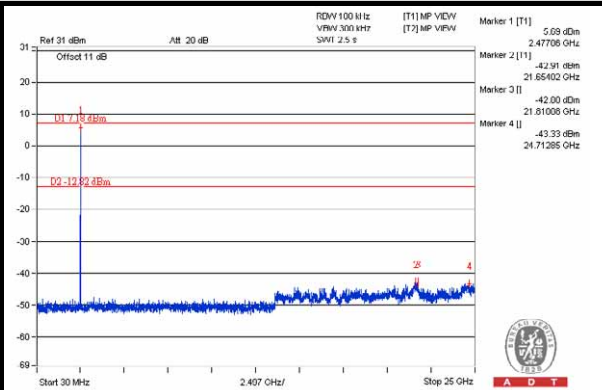
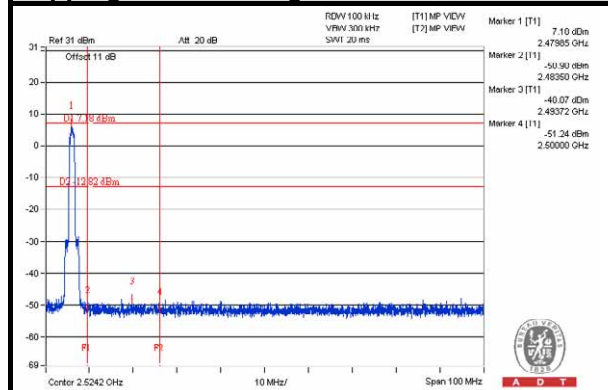

Hopping enabled_Low Channel

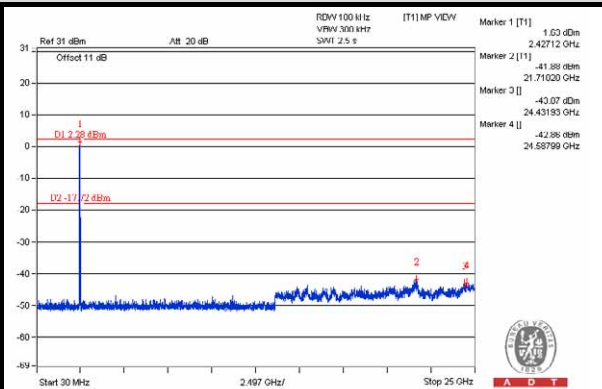
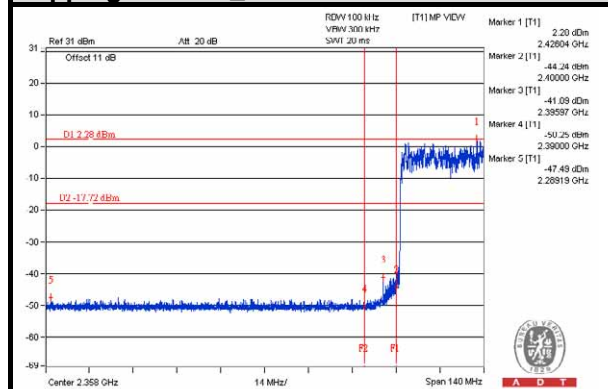

Hopping enabled_High Channel

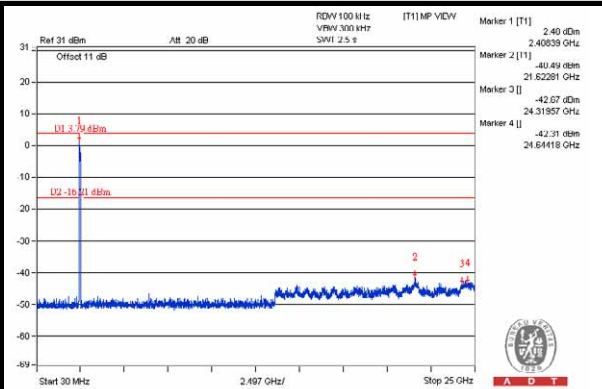
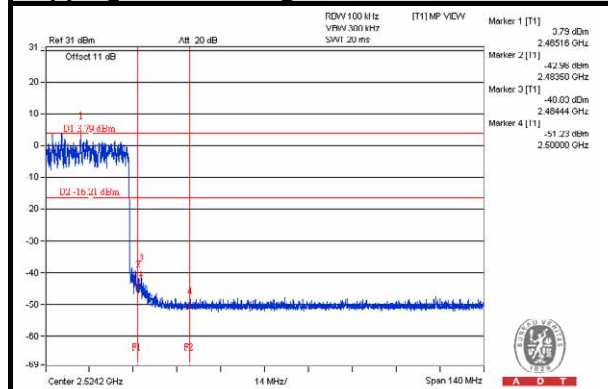

4.9 RADIATED EMISSION MEASUREMENT

4.9.1 LIMITS OF RADIATED EMISSION MEASUREMENT

Radiated emissions which fall in the restricted bands must comply with the radiated emission limits specified as below table. Other emissions shall be at least 20dB below the highest level of the desired power:

FREQUENCIES (MHz)	FIELD STRENGTH (microvolts/meter)	MEASUREMENT DISTANCE (meters)
0.009 ~ 0.490	2400/F(kHz)	300
0.490 ~ 1.705	24000/F(kHz)	30
1.705 ~ 30.0	30	30
30 ~ 88	100	3
88 ~ 216	150	3
216 ~ 960	200	3
Above 960	500	3

NOTE:

1. The lower limit shall apply at the transition frequencies.
2. Emission level (dBuV/m) = 20 log Emission level (uV/m).
3. As shown in 15.35(b), for frequencies above 1000MHz, the field strength limits are based on average detector, however, the peak field strength of any emission shall not exceed the maximum permitted average limits, specified above by more than 20dB under any condition of modulation.



A D T

4.9.2 TEST INSTRUMENTS

For below 1GHz test:

DESCRIPTION & MANUFACTURER	MODEL NO.	SERIAL NO.	CALIBRATED DATE	CALIBRATED UNTIL
MXE EMI Receiver Agilent	N9038A	MY51210105	July 21, 2014	July 20, 2015
Pre-Amplifier Mini-Circuits	ZFL-1000VH2 B	AMP-ZFL-03	Nov. 13, 2013	Nov. 12, 2014
Trilog Broadband Antenna SCHWARZBECK	VULB 9168	9168-360	Feb. 26, 2014	Feb. 25, 2015
RF Cable	NA	CHGCAB_001	Oct. 05, 2013	Oct. 04, 2014
Horn_Antenna AISI	AIH.8018	0000320091110	Aug. 27, 2014	Aug. 26, 2015
Pre-Amplifier Agilent	8449B	3008A02578	June 24, 2014	June 23, 2015
RF Cable	NA	131205 131214 SNMY23684/4	Jan. 17, 2014	Jan. 16, 2015
Spectrum Analyzer R&S	FSV40	100964	July 05, 2014	July 04, 2015
Pre-Amplifier SPACEK LABS	SLKka-48-6	9K16	Nov. 13, 2013	Nov. 12, 2014
Horn_Antenna SCHWARZBECK	BBHA 9170	9170-424	Aug. 26, 2014	Aug. 25, 2015
RF Cable	NA	RF104-121 RF104-204	Dec. 12, 2013	Dec. 11, 2014
Antenna Tower & Turn Table CT	NA	NA	NA	NA

Note:

1. The calibration interval of the above test instruments is 12 months and the calibrations are traceable to NML/ROC and NIST/USA.
2. The horn antenna, preamplifier (model: 8449B) are used only for the measurement of emission frequency above 1GHz if tested.
3. The test was performed in 966 Chamber No. G.
4. The FCC Site Registration No. is 966073.
5. The VCCI Site Registration No. is G-137.
6. The CANADA Site Registration No. is IC 7450H-2.
7. Tested Date: Aug. 27, 2014



A D T

For above 1GHz test:

DESCRIPTION & MANUFACTURER	MODEL NO.	SERIAL NO.	CALIBRATED DATE	CALIBRATED UNTIL
MXE EMI Receiver Agilent	N9038A	MY51210105	July 21, 2014	July 20,2015
Pre-Amplifier Mini-Circuits	ZFL-1000VH2 B	AMP-ZFL-03	Nov. 13, 2013	Nov. 12, 2014
Trilog Broadband Antenna SCHWARZBECK	VULB 9168	9168-360	Feb. 26, 2014	Feb. 25, 2015
RF Cable	NA	CHGCAB_001	Oct. 04, 2014	Oct. 03, 2015
Horn_Antenna AISI	AIH.8018	0000320091110	Aug. 27, 2014	Aug. 26, 2015
Pre-Amplifier Agilent	8449B	3008A02578	June 24, 2014	June 23, 2015
RF Cable	NA	131205 131214 SNMY23684/4	Jan. 17, 2014	Jan. 16, 2015
Spectrum Analyzer R&S	FSV40	100964	July 05, 2014	July 04, 2015
Pre-Amplifier SPACEK LABS	SLKKa-48-6	9K16	Nov. 13, 2013	Nov. 12, 2014
Horn_Antenna SCHWARZBECK	BBHA 9170	9170-424	Aug. 26, 2014	Aug. 25, 2015
RF Cable	NA	RF104-121 RF104-204	Dec. 12, 2013	Dec. 11, 2014
Antenna Tower & Turn Table CT	NA	NA	NA	NA

Note:

1. The calibration interval of the above test instruments is 12 months and the calibrations are traceable to NML/ROC and NIST/USA.
2. The horn antenna, preamplifier (model: 8449B) are used only for the measurement of emission frequency above 1GHz if tested.
3. The test was performed in 966 Chamber No. G.
4. The FCC Site Registration No. is 966073.
5. The VCCI Site Registration No. is G-137.
6. The CANADA Site Registration No. is IC 7450H-2.
7. Tested Date: Oct. 16, 2014

4.9.3 TEST PROCEDURES

- a. The EUT was placed on the top of a rotating table 0.8 meters above the ground at a 3 meter chamber room. The table was rotated 360 degrees to determine the position of the highest radiation.
- b. The EUT was set 3 meters away from the interference-receiving antenna, which was mounted on the top of a variable-height antenna tower.
- c. The height of antenna is varied from one meter to four meters above the ground to determine the maximum value of the field strength. Both horizontal and vertical polarizations of the antenna are set to make the measurement.
- d. For each suspected emission, the EUT was arranged to its worst case and then the antenna was tuned to heights from 1 meter to 4 meters and the rotatable table was turned from 0 degrees to 360 degrees to find the maximum reading.
- e. The test-receiver system was set to quasi-peak detect function and specified bandwidth with maximum hold mode when the test frequency is below 1 GHz.
- f. The test-receiver system was set to peak and average detect function and specified bandwidth with maximum hold mode when the test frequency is above 1 GHz. If the peak reading value also meets average limit, measurement with the average detector is unnecessary.

Note:

1. The resolution bandwidth and video bandwidth of test receiver/spectrum analyzer is 120kHz for Quasi-peak detection (QP) at frequency below 1GHz.
2. The resolution bandwidth of test receiver/spectrum analyzer is 1MHz and video bandwidth is 1MHz for Peak detection at frequency above 1GHz.
3. The resolution bandwidth of test receiver/spectrum analyzer is 1 MHz and the video bandwidth is 10 Hz for Average detection (AV) at frequency above 1GHz.
4. All modes of operation were investigated and the worst-case emissions are reported.

4.9.4 DEVIATION FROM TEST STANDARD

No deviation

4.9.5 TEST SETUP

<Frequency Range below 1GHz>

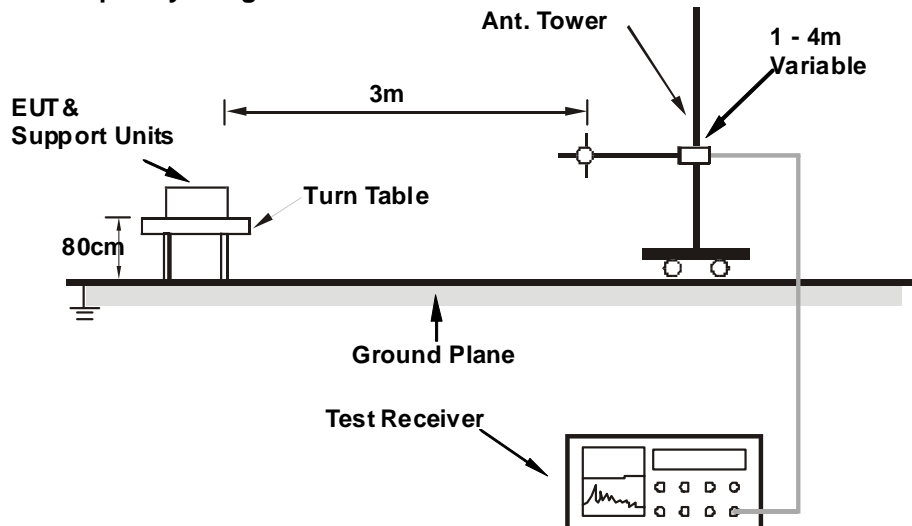

<Frequency Range above 1GHz>

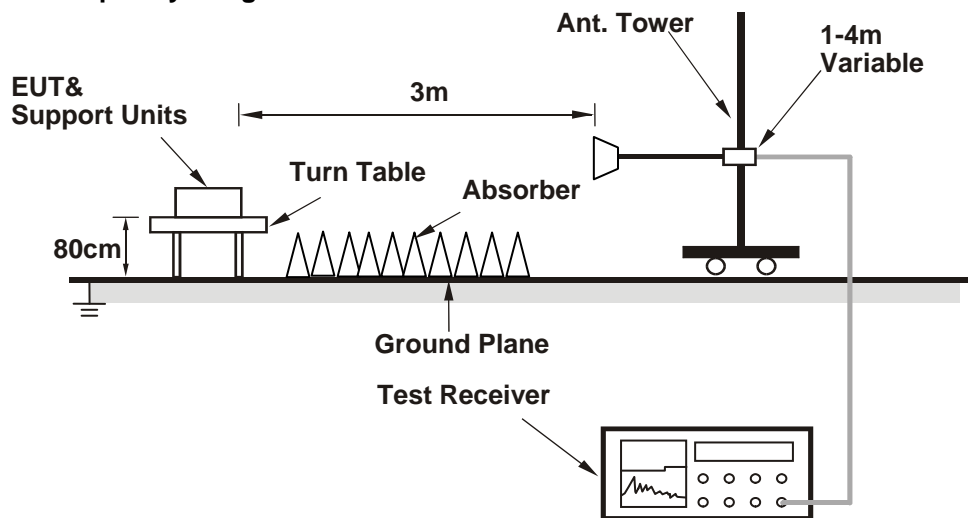

For the actual test configuration, please refer to the related item – Photographs of the Test Configuration.

4.9.6 EUT OPERATING CONDITIONS

1. Connect the EUT with the support unit 1 (Notebook Computer) which is placed on a testing table.
2. The communication partner run test program “QCRT Version3.0 29.0” to enable EUT under transmission/receiving condition continuously at specific channel frequency.

4.9.7 TEST RESULTS(MODE 1)

BELOW 1GHz WORST-CASE DATA

BT_GFSK

CHANNEL	TX Channel 78	DETECTOR FUNCTION	Quasi-Peak (QP)
FREQUENCY RANGE	30MHz ~ 1GHz		

ANTENNA POLARITY & TEST DISTANCE: HORIZONTAL AT 3 M

NO.	FREQ. (MHz)	EMISSION LEVEL (dBuV/m)	LIMIT (dBuV/m)	MARGIN (dB)	ANTENNA HEIGHT (m)	TABLE ANGLE (Degree)	RAW VALUE (dBuV)	CORRECTION FACTOR (dB/m)
1	87.62	34.9 QP	40.0	-5.1	2.00 H	113	53.93	-19.05
2	123.65	30.8 QP	43.5	-12.7	2.00 H	176	45.76	-14.96
3	166.04	30.0 QP	43.5	-13.5	1.50 H	64	43.48	-13.49
4	330.26	35.3 QP	46.0	-10.7	1.00 H	360	46.77	-11.47
5	663.85	32.9 QP	46.0	-13.1	1.00 H	111	36.92	-4.03
6	940.54	32.3 QP	46.0	-13.8	2.00 H	360	31.40	0.85

ANTENNA POLARITY & TEST DISTANCE: VERTICAL AT 3 M

NO.	FREQ. (MHz)	EMISSION LEVEL (dBuV/m)	LIMIT (dBuV/m)	MARGIN (dB)	ANTENNA HEIGHT (m)	TABLE ANGLE (Degree)	RAW VALUE (dBuV)	CORRECTION FACTOR (dB/m)
1	32.96	33.7 QP	40.0	-6.3	1.00 V	360	48.10	-14.41
2	85.73	32.6 QP	40.0	-7.4	1.00 V	45	51.57	-19.00
3	166.04	32.1 QP	43.5	-11.4	1.00 V	265	45.56	-13.49
4	335.70	34.7 QP	46.0	-11.4	1.50 V	132	46.00	-11.35
5	666.47	34.8 QP	46.0	-11.2	1.00 V	284	38.79	-3.99
6	940.68	30.8 QP	46.0	-15.2	1.50 V	360	29.97	0.86

REMARKS:

1. Emission Level(dBuV/m) = Raw Value(dBuV) + Correction Factor(dB/m)
2. Correction Factor(dB/m) = Antenna Factor(dB/m) + Cable Factor(dB) – Pre-Amplifier Factor(dB)
3. The other emission levels were very low against the limit.
4. Margin value = Emission Level – Limit value



A D T

ABOVE 1GHz DATA

BT_GFSK

CHANNEL	TX Channel 0	DETECTOR FUNCTION	Peak (PK)
FREQUENCY RANGE	1GHz ~ 25GHz		

ANTENNA POLARITY & TEST DISTANCE: HORIZONTAL AT 3 M

NO.	FREQ. (MHz)	EMISSION LEVEL (dBuV/m)	LIMIT (dBuV/m)	MARGIN (dB)	ANTENNA HEIGHT (m)	TABLE ANGLE (Degree)	RAW VALUE (dBuV)	CORRECTION FACTOR (dB/m)
1	2390.00	47.1 PK	74.0	-26.9	1.06 H	315	49.57	-2.47
2	2390.00	35.1 AV	54.0	-18.9	1.06 H	315	37.57	-2.47
3	*2402.00	99.8 PK			1.06 H	315	102.21	-2.41
4	*2402.00	98.4 AV			1.06 H	315	100.81	-2.41
5	4804.00	46.1 PK	74.0	-27.9	1.02 H	76	40.48	5.62
6	4804.00	33.9 AV	54.0	-20.1	1.02 H	76	28.28	5.62

ANTENNA POLARITY & TEST DISTANCE: VERTICAL AT 3 M

NO.	FREQ. (MHz)	EMISSION LEVEL (dBuV/m)	LIMIT (dBuV/m)	MARGIN (dB)	ANTENNA HEIGHT (m)	TABLE ANGLE (Degree)	RAW VALUE (dBuV)	CORRECTION FACTOR (dB/m)
1	2390.00	51.6 PK	74.0	-22.4	1.16 V	91	54.07	-2.47
2	2390.00	35.5 AV	54.0	-18.5	1.16 V	91	37.97	-2.47
3	*2402.00	102.8 PK			1.16 V	91	105.21	-2.41
4	*2402.00	101.4 AV			1.16 V	91	103.81	-2.41
5	4804.00	46.5 PK	74.0	-27.5	1.04 V	189	40.88	5.62
6	4804.00	34.2 AV	54.0	-19.8	1.04 V	189	28.58	5.62

REMARKS:

1. Emission Level(dBuV/m) = Raw Value(dBuV) + Correction Factor(dB/m)
2. Correction Factor(dB/m) = Antenna Factor(dB/m) + Cable Factor(dB) – Pre-Amplifier Factor(dB)
3. The other emission levels were very low against the limit.
4. Margin value = Emission Level – Limit value
5. " * ": Fundamental frequency.



A D T

CHANNEL	TX Channel 39	DETECTOR FUNCTION	Peak (PK)
FREQUENCY RANGE	1GHz ~ 25GHz		

ANTENNA POLARITY & TEST DISTANCE: HORIZONTAL AT 3 M

NO.	FREQ. (MHz)	EMISSION LEVEL (dBuV/m)	LIMIT (dBuV/m)	MARGIN (dB)	ANTENNA HEIGHT (m)	TABLE ANGLE (Degree)	RAW VALUE (dBuV)	CORRECTION FACTOR (dB/m)
1	*2441.00	100.3 PK			1.17 H	305	102.54	-2.24
2	*2441.00	99.4 AV			1.17 H	305	101.64	-2.24
3	4882.00	46.2 PK	74.0	-27.8	1.03 H	103	40.26	5.94
4	4882.00	34.1 AV	54.0	-19.9	1.03 H	103	28.16	5.94
5	7323.00	53.6 PK	74.0	-20.4	1.05 H	306	40.42	13.18
6	7323.00	42.1 AV	54.0	-11.9	1.05 H	306	28.92	13.18

ANTENNA POLARITY & TEST DISTANCE: VERTICAL AT 3 M

NO.	FREQ. (MHz)	EMISSION LEVEL (dBuV/m)	LIMIT (dBuV/m)	MARGIN (dB)	ANTENNA HEIGHT (m)	TABLE ANGLE (Degree)	RAW VALUE (dBuV)	CORRECTION FACTOR (dB/m)
1	*2441.00	103.0 PK			1.08 V	306	105.24	-2.24
2	*2441.00	101.9 AV			1.08 V	306	104.14	-2.24
3	4882.00	47.6 PK	74.0	-26.4	1.01 V	175	41.66	5.94
4	4882.00	35.4 AV	54.0	-18.6	1.01 V	175	29.46	5.94
5	7323.00	53.7 PK	74.0	-20.3	1.02 V	19	40.52	13.18
6	7323.00	41.4 AV	54.0	-12.6	1.02 V	19	28.22	13.18

REMARKS:

1. Emission Level(dBuV/m) = Raw Value(dBuV) + Correction Factor(dB/m)
2. Correction Factor(dB/m) = Antenna Factor(dB/m) + Cable Factor(dB) – Pre-Amplifier Factor(dB)
3. The other emission levels were very low against the limit.
4. Margin value = Emission Level – Limit value
5. " * ": Fundamental frequency.



A D T

CHANNEL	TX Channel 78	DETECTOR FUNCTION	Peak (PK)
FREQUENCY RANGE	1GHz ~ 25GHz		

ANTENNA POLARITY & TEST DISTANCE: HORIZONTAL AT 3 M

NO.	FREQ. (MHz)	EMISSION LEVEL (dBuV/m)	LIMIT (dBuV/m)	MARGIN (dB)	ANTENNA HEIGHT (m)	TABLE ANGLE (Degree)	RAW VALUE (dBuV)	CORRECTION FACTOR (dB/m)
1	*2480.00	100.3 PK			1.01 H	315	102.36	-2.06
2	*2480.00	98.4 AV			1.01 H	315	100.46	-2.06
3	2483.50	49.7 PK	74.0	-24.3	1.01 H	315	51.73	-2.03
4	2483.50	33.4 AV	54.0	-20.6	1.01 H	315	35.43	-2.03
5	4960.00	46.4 PK	74.0	-27.6	1.00 H	100	40.14	6.26
6	4960.00	34.1 AV	54.0	-19.9	1.00 H	100	27.84	6.26
7	7440.00	54.4 PK	74.0	-19.6	1.00 H	305	41.27	13.13
8	7440.00	41.8 AV	54.0	-12.2	1.00 H	305	28.67	13.13

ANTENNA POLARITY & TEST DISTANCE: VERTICAL AT 3 M

NO.	FREQ. (MHz)	EMISSION LEVEL (dBuV/m)	LIMIT (dBuV/m)	MARGIN (dB)	ANTENNA HEIGHT (m)	TABLE ANGLE (Degree)	RAW VALUE (dBuV)	CORRECTION FACTOR (dB/m)
1	*2480.00	103.1 PK			1.06 V	107	105.16	-2.06
2	*2480.00	102.4 AV			1.06 V	107	104.46	-2.06
3	2483.50	53.2 PK	74.0	-20.8	1.06 V	107	55.23	-2.03
4	2483.50	34.2 AV	54.0	-19.8	1.06 V	107	36.23	-2.03
5	4960.00	47.8 PK	74.0	-26.2	1.01 V	186	41.54	6.26
6	4960.00	35.7 AV	54.0	-18.3	1.01 V	186	29.44	6.26
7	7440.00	54.2 PK	74.0	-19.8	1.09 V	14	41.07	13.13
8	7440.00	41.8 AV	54.0	-12.2	1.09 V	14	28.67	13.13

REMARKS:

1. Emission Level(dBuV/m) = Raw Value(dBuV) + Correction Factor(dB/m)
2. Correction Factor(dB/m) = Antenna Factor(dB/m) + Cable Factor(dB) – Pre-Amplifier Factor(dB)
3. The other emission levels were very low against the limit.
4. Margin value = Emission Level – Limit value
5. " * ": Fundamental frequency.



A D T

BT_8DPSK

CHANNEL	TX Channel 0	DETECTOR FUNCTION	Peak (PK)
FREQUENCY RANGE	1GHz ~ 25GHz		

ANTENNA POLARITY & TEST DISTANCE: HORIZONTAL AT 3 M

NO.	FREQ. (MHz)	EMISSION LEVEL (dBuV/m)	LIMIT (dBuV/m)	MARGIN (dB)	ANTENNA HEIGHT (m)	TABLE ANGLE (Degree)	RAW VALUE (dBuV)	CORRECTION FACTOR (dB/m)
1	2390.00	45.7 PK	74.0	-28.3	1.01 H	314	48.17	-2.47
2	2390.00	32.5 AV	54.0	-21.5	1.01 H	314	34.97	-2.47
3	*2402.00	95.7 PK			1.01 H	314	98.11	-2.41
4	*2402.00	94.3 AV			1.01 H	314	96.71	-2.41
5	4804.00	45.0 PK	74.0	-29.0	1.01 H	77	39.38	5.62
6	4804.00	32.6 AV	54.0	-21.4	1.01 H	77	26.98	5.62

ANTENNA POLARITY & TEST DISTANCE: VERTICAL AT 3 M

NO.	FREQ. (MHz)	EMISSION LEVEL (dBuV/m)	LIMIT (dBuV/m)	MARGIN (dB)	ANTENNA HEIGHT (m)	TABLE ANGLE (Degree)	RAW VALUE (dBuV)	CORRECTION FACTOR (dB/m)
1	2390.00	45.8 PK	74.0	-28.2	1.16 V	320	48.27	-2.47
2	2390.00	32.7 AV	54.0	-21.3	1.16 V	320	35.17	-2.47
3	*2402.00	100.5 PK			1.16 V	320	102.91	-2.41
4	*2402.00	99.4 AV			1.16 V	320	101.81	-2.41
5	4804.00	47.3 PK	74.0	-26.7	1.01 V	156	41.68	5.62
6	4804.00	35.2 AV	54.0	-18.8	1.01 V	156	29.58	5.62

REMARKS:

1. Emission Level(dBuV/m) = Raw Value(dBuV) + Correction Factor(dB/m)
2. Correction Factor(dB/m) = Antenna Factor(dB/m) + Cable Factor(dB) – Pre-Amplifier Factor(dB)
3. The other emission levels were very low against the limit.
4. Margin value = Emission Level – Limit value
5. " * " : Fundamental frequency.



A D T

CHANNEL	TX Channel 39	DETECTOR FUNCTION	Peak (PK)
FREQUENCY RANGE	1GHz ~ 25GHz		

ANTENNA POLARITY & TEST DISTANCE: HORIZONTAL AT 3 M								
NO.	FREQ. (MHz)	EMISSION LEVEL (dBuV/m)	LIMIT (dBuV/m)	MARGIN (dB)	ANTENNA HEIGHT (m)	TABLE ANGLE (Degree)	RAW VALUE (dBuV)	CORRECTION FACTOR (dB/m)
1	*2441.00	96.9 PK			1.03 H	314	99.14	-2.24
2	*2441.00	95.4 AV			1.03 H	314	97.64	-2.24
3	4882.00	45.9 PK	74.0	-28.1	1.05 H	72	39.96	5.94
4	4882.00	33.6 AV	54.0	-20.4	1.05 H	72	27.66	5.94
5	7323.00	53.3 PK	74.0	-20.7	1.07 H	287	40.12	13.18
6	7323.00	40.9 AV	54.0	-13.1	1.07 H	287	27.72	13.18
ANTENNA POLARITY & TEST DISTANCE: VERTICAL AT 3 M								
NO.	FREQ. (MHz)	EMISSION LEVEL (dBuV/m)	LIMIT (dBuV/m)	MARGIN (dB)	ANTENNA HEIGHT (m)	TABLE ANGLE (Degree)	RAW VALUE (dBuV)	CORRECTION FACTOR (dB/m)
1	*2441.00	101.4 PK			1.13 V	91	103.64	-2.24
2	*2441.00	100.3 AV			1.13 V	91	102.54	-2.24
3	4882.00	48.0 PK	74.0	-26.0	1.03 V	161	42.06	5.94
4	4882.00	35.9 AV	54.0	-18.1	1.03 V	161	29.96	5.94
5	7323.00	52.8 PK	74.0	-21.2	1.07 V	21	39.62	13.18
6	7323.00	40.5 AV	54.0	-13.5	1.07 V	21	27.32	13.18

REMARKS:

1. Emission Level(dBuV/m) = Raw Value(dBuV) + Correction Factor(dB/m)
2. Correction Factor(dB/m) = Antenna Factor(dB/m) + Cable Factor(dB) – Pre-Amplifier Factor(dB)
3. The other emission levels were very low against the limit.
4. Margin value = Emission Level – Limit value
5. " * ": Fundamental frequency.



A D T

CHANNEL	TX Channel 78	DETECTOR FUNCTION	Peak (PK)
FREQUENCY RANGE	1GHz ~ 25GHz		

ANTENNA POLARITY & TEST DISTANCE: HORIZONTAL AT 3 M

NO.	FREQ. (MHz)	EMISSION LEVEL (dBuV/m)	LIMIT (dBuV/m)	MARGIN (dB)	ANTENNA HEIGHT (m)	TABLE ANGLE (Degree)	RAW VALUE (dBuV)	CORRECTION FACTOR (dB/m)
1	*2480.00	97.7 PK			1.02 H	316	99.76	-2.06
2	*2480.00	96.3 AV			1.02 H	316	98.36	-2.06
3	2483.50	45.0 PK	74.0	-29.0	1.02 H	316	47.03	-2.03
4	2483.50	32.4 AV	54.0	-21.6	1.02 H	316	34.43	-2.03
5	4960.00	46.1 PK	74.0	-27.9	1.04 H	97	39.84	6.26
6	4960.00	33.7 AV	54.0	-20.3	1.04 H	97	27.44	6.26
7	7440.00	54.0 PK	74.0	-20.0	1.06 H	298	40.87	13.13
8	7440.00	41.4 AV	54.0	-12.6	1.06 H	298	28.27	13.13

ANTENNA POLARITY & TEST DISTANCE: VERTICAL AT 3 M

NO.	FREQ. (MHz)	EMISSION LEVEL (dBuV/m)	LIMIT (dBuV/m)	MARGIN (dB)	ANTENNA HEIGHT (m)	TABLE ANGLE (Degree)	RAW VALUE (dBuV)	CORRECTION FACTOR (dB/m)
1	*2480.00	102.0 PK			1.13 V	319	104.06	-2.06
2	*2480.00	101.4 AV			1.13 V	319	103.46	-2.06
3	2483.50	45.4 PK	74.0	-28.6	1.13 V	319	47.43	-2.03
4	2483.50	32.5 AV	54.0	-21.5	1.13 V	319	34.53	-2.03
5	4960.00	48.0 PK	74.0	-26.0	1.03 V	176	41.74	6.26
6	4960.00	35.5 AV	54.0	-18.5	1.03 V	176	29.24	6.26
7	7440.00	52.8 PK	74.0	-21.2	1.12 V	19	39.67	13.13
8	7440.00	40.3 AV	54.0	-13.7	1.12 V	19	27.17	13.13

REMARKS:

1. Emission Level(dBuV/m) = Raw Value(dBuV) + Correction Factor(dB/m)
2. Correction Factor(dB/m) = Antenna Factor(dB/m) + Cable Factor(dB) – Pre-Amplifier Factor(dB)
3. The other emission levels were very low against the limit.
4. Margin value = Emission Level – Limit value
5. " * ": Fundamental frequency.

4.9.8 TEST RESULTS(MODE 2)

BELOW 1GHz WORST-CASE DATA

BT_GFSK

CHANNEL	TX Channel 78	DETECTOR FUNCTION	Quasi-Peak (QP)
FREQUENCY RANGE	30MHz ~ 1GHz		

ANTENNA POLARITY & TEST DISTANCE: HORIZONTAL AT 3 M

NO.	FREQ. (MHz)	EMISSION LEVEL (dBuV/m)	LIMIT (dBuV/m)	MARGIN (dB)	ANTENNA HEIGHT (m)	TABLE ANGLE (Degree)	RAW VALUE (dBuV)	CORRECTION FACTOR (dB/m)
1	89.41	33.3 QP	43.5	-10.2	1.50 H	236	52.41	-19.12
2	166.00	30.7 QP	43.5	-12.8	1.50 H	215	44.17	-13.49
3	255.09	37.9 QP	46.0	-8.1	1.00 H	126	51.99	-14.12
4	328.43	37.4 QP	46.0	-8.6	1.00 H	139	48.89	-11.49
5	666.51	36.1 QP	46.0	-9.9	1.00 H	196	40.09	-3.99
6	945.82	35.7 QP	46.0	-10.3	1.50 H	256	34.71	0.96

ANTENNA POLARITY & TEST DISTANCE: VERTICAL AT 3 M

NO.	FREQ. (MHz)	EMISSION LEVEL (dBuV/m)	LIMIT (dBuV/m)	MARGIN (dB)	ANTENNA HEIGHT (m)	TABLE ANGLE (Degree)	RAW VALUE (dBuV)	CORRECTION FACTOR (dB/m)
1	32.96	33.7 QP	40.0	-6.3	1.00 V	360	48.10	-14.41
2	85.73	32.6 QP	40.0	-7.4	1.00 V	45	51.57	-19.00
3	166.04	32.1 QP	43.5	-11.4	1.00 V	265	45.56	-13.49
4	335.70	34.7 QP	46.0	-11.4	1.50 V	132	46.00	-11.35
5	666.47	34.8 QP	46.0	-11.2	1.00 V	284	38.79	-3.99
6	940.68	30.8 QP	46.0	-15.2	1.50 V	360	29.97	0.86

REMARKS:

1. Emission Level(dBuV/m) = Raw Value(dBuV) + Correction Factor(dB/m)
2. Correction Factor(dB/m) = Antenna Factor(dB/m) + Cable Factor(dB) – Pre-Amplifier Factor(dB)
3. The other emission levels were very low against the limit.
4. Margin value = Emission Level – Limit value



A D T

ABOVE 1GHz DATA

BT_GFSK

CHANNEL	TX Channel 0	DETECTOR FUNCTION	Peak (PK)
FREQUENCY RANGE	1GHz ~ 25GHz		

ANTENNA POLARITY & TEST DISTANCE: HORIZONTAL AT 3 M

NO.	FREQ. (MHz)	EMISSION LEVEL (dBuV/m)	LIMIT (dBuV/m)	MARGIN (dB)	ANTENNA HEIGHT (m)	TABLE ANGLE (Degree)	RAW VALUE (dBuV)	CORRECTION FACTOR (dB/m)
1	2390.00	46.5 PK	74.0	-27.5	1.05 H	84	48.97	-2.47
2	2390.00	33.2 AV	54.0	-20.8	1.05 H	84	35.67	-2.47
3	*2402.00	104.0 PK			1.05 H	84	106.41	-2.41
4	*2402.00	73.9 AV			1.05 H	84	76.31	-2.41
5	4804.00	48.8 PK	74.0	-25.2	1.40 H	284	43.18	5.62
6	4804.00	36.6 AV	54.0	-17.4	1.40 H	284	30.98	5.62

ANTENNA POLARITY & TEST DISTANCE: VERTICAL AT 3 M

NO.	FREQ. (MHz)	EMISSION LEVEL (dBuV/m)	LIMIT (dBuV/m)	MARGIN (dB)	ANTENNA HEIGHT (m)	TABLE ANGLE (Degree)	RAW VALUE (dBuV)	CORRECTION FACTOR (dB/m)
1	2390.00	46.7 PK	74.0	-27.3	1.53 V	267	49.17	-2.47
2	2390.00	34.7 AV	54.0	-19.3	1.53 V	267	37.17	-2.47
3	*2402.00	109.3 PK			1.53 V	267	111.71	-2.41
4	*2402.00	108.3 AV			1.53 V	267	110.71	-2.41
5	4804.00	49.6 PK	74.0	-24.4	1.09 V	24	43.98	5.62
6	4804.00	37.4 AV	54.0	-16.6	1.09 V	24	31.78	5.62

REMARKS:

1. Emission Level(dBuV/m) = Raw Value(dBuV) + Correction Factor(dB/m)
2. Correction Factor(dB/m) = Antenna Factor(dB/m) + Cable Factor(dB) – Pre-Amplifier Factor(dB)
3. The other emission levels were very low against the limit.
4. Margin value = Emission Level – Limit value
5. " * ": Fundamental frequency.



A D T

CHANNEL	TX Channel 39	DETECTOR FUNCTION	Peak (PK)
FREQUENCY RANGE	1GHz ~ 25GHz		

ANTENNA POLARITY & TEST DISTANCE: HORIZONTAL AT 3 M

NO.	FREQ. (MHz)	EMISSION LEVEL (dBuV/m)	LIMIT (dBuV/m)	MARGIN (dB)	ANTENNA HEIGHT (m)	TABLE ANGLE (Degree)	RAW VALUE (dBuV)	CORRECTION FACTOR (dB/m)
1	*2441.00	103.5 PK			1.02 H	115	105.74	-2.24
2	*2441.00	101.4 AV			1.02 H	115	103.64	-2.24
3	4882.00	49.2 PK	74.0	-24.8	1.43 H	292	43.26	5.94
4	4882.00	36.6 AV	54.0	-17.4	1.43 H	292	30.66	5.94
5	7323.00	54.4 PK	74.0	-19.6	1.06 H	161	41.22	13.18
6	7323.00	38.6 AV	54.0	-15.4	1.06 H	161	25.42	13.18

ANTENNA POLARITY & TEST DISTANCE: VERTICAL AT 3 M

NO.	FREQ. (MHz)	EMISSION LEVEL (dBuV/m)	LIMIT (dBuV/m)	MARGIN (dB)	ANTENNA HEIGHT (m)	TABLE ANGLE (Degree)	RAW VALUE (dBuV)	CORRECTION FACTOR (dB/m)
1	*2441.00	110.4 PK			1.01 V	265	112.64	-2.24
2	*2441.00	109.1 AV			1.01 V	265	111.34	-2.24
3	4882.00	49.5 PK	74.0	-24.5	1.04 V	12	43.56	5.94
4	4882.00	37.3 AV	54.0	-16.7	1.04 V	12	31.36	5.94
5	7323.00	55.2 PK	74.0	-18.8	1.05 V	243	42.02	13.18
6	7323.00	39.2 AV	54.0	-14.8	1.05 V	243	26.02	13.18

REMARKS:

1. Emission Level(dBuV/m) = Raw Value(dBuV) + Correction Factor(dB/m)
2. Correction Factor(dB/m) = Antenna Factor(dB/m) + Cable Factor(dB) – Pre-Amplifier Factor(dB)
3. The other emission levels were very low against the limit.
4. Margin value = Emission Level – Limit value
5. " * ": Fundamental frequency.



A D T

CHANNEL	TX Channel 78	DETECTOR FUNCTION	Peak (PK)
FREQUENCY RANGE	1GHz ~ 25GHz		

ANTENNA POLARITY & TEST DISTANCE: HORIZONTAL AT 3 M

NO.	FREQ. (MHz)	EMISSION LEVEL (dBuV/m)	LIMIT (dBuV/m)	MARGIN (dB)	ANTENNA HEIGHT (m)	TABLE ANGLE (Degree)	RAW VALUE (dBuV)	CORRECTION FACTOR (dB/m)
1	*2480.00	107.3 PK			1.29 H	117	109.36	-2.06
2	*2480.00	105.7 AV			1.29 H	117	107.76	-2.06
3	2483.50	53.9 PK	74.0	-20.1	1.29 H	117	55.93	-2.03
4	2483.50	36.9 AV	54.0	-17.1	1.29 H	117	38.93	-2.03
5	4960.00	48.8 PK	74.0	-25.2	1.39 H	294	42.54	6.26
6	4960.00	36.2 AV	54.0	-17.8	1.39 H	294	29.94	6.26
7	7440.00	54.4 PK	74.0	-19.6	1.00 H	149	41.27	13.13
8	7440.00	41.6 AV	54.0	-12.4	1.00 H	149	28.47	13.13

ANTENNA POLARITY & TEST DISTANCE: VERTICAL AT 3 M

NO.	FREQ. (MHz)	EMISSION LEVEL (dBuV/m)	LIMIT (dBuV/m)	MARGIN (dB)	ANTENNA HEIGHT (m)	TABLE ANGLE (Degree)	RAW VALUE (dBuV)	CORRECTION FACTOR (dB/m)
1	*2480.00	111.0 PK			1.49 V	260	113.06	-2.06
2	*2480.00	110.2 AV			1.49 V	260	112.26	-2.06
3	2483.50	63.7 PK	74.0	-10.3	1.47 V	265	65.73	-2.03
4	2483.50	46.1 AV	54.0	-7.9	1.47 V	265	48.13	-2.03
5	4960.00	49.8 PK	74.0	-24.2	1.00 V	7	43.54	6.26
6	4960.00	37.8 AV	54.0	-16.2	1.00 V	7	31.54	6.26
7	7440.00	55.3 PK	74.0	-18.7	1.06 V	228	42.17	13.13
8	7440.00	43.4 AV	54.0	-10.6	1.06 V	228	30.27	13.13

REMARKS:

1. Emission Level(dBuV/m) = Raw Value(dBuV) + Correction Factor(dB/m)
2. Correction Factor(dB/m) = Antenna Factor(dB/m) + Cable Factor(dB) – Pre-Amplifier Factor(dB)
3. The other emission levels were very low against the limit.
4. Margin value = Emission Level – Limit value
5. " * ": Fundamental frequency.



A D T

BT_8DPSK

CHANNEL	TX Channel 0	DETECTOR FUNCTION	Peak (PK)
FREQUENCY RANGE	1GHz ~ 25GHz		

ANTENNA POLARITY & TEST DISTANCE: HORIZONTAL AT 3 M

NO.	FREQ. (MHz)	EMISSION LEVEL (dBuV/m)	LIMIT (dBuV/m)	MARGIN (dB)	ANTENNA HEIGHT (m)	TABLE ANGLE (Degree)	RAW VALUE (dBuV)	CORRECTION FACTOR (dB/m)
1	2390.00	48.7 PK	74.0	-25.3	1.35 H	114	51.17	-2.47
2	2390.00	33.4 AV	54.0	-20.6	1.35 H	114	35.87	-2.47
3	*2402.00	103.2 PK			1.35 H	114	105.61	-2.41
4	*2402.00	101.7 AV			1.35 H	114	104.11	-2.41
5	4804.00	46.9 PK	74.0	-27.1	1.54 H	277	41.28	5.62
6	4804.00	34.6 AV	54.0	-19.4	1.54 H	277	28.98	5.62

ANTENNA POLARITY & TEST DISTANCE: VERTICAL AT 3 M

NO.	FREQ. (MHz)	EMISSION LEVEL (dBuV/m)	LIMIT (dBuV/m)	MARGIN (dB)	ANTENNA HEIGHT (m)	TABLE ANGLE (Degree)	RAW VALUE (dBuV)	CORRECTION FACTOR (dB/m)
1	2390.00	53.3 PK	74.0	-20.7	1.53 V	262	55.77	-2.47
2	2390.00	34.4 AV	54.0	-19.6	1.53 V	262	36.87	-2.47
3	*2402.00	107.1 PK			1.53 V	262	109.51	-2.41
4	*2402.00	106.4 AV			1.53 V	262	108.81	-2.41
5	4804.00	48.4 PK	74.0	-25.6	1.01 V	348	42.78	5.62
6	4804.00	36.1 AV	54.0	-17.9	1.01 V	348	30.48	5.62

REMARKS:

1. Emission Level(dBuV/m) = Raw Value(dBuV) + Correction Factor(dB/m)
2. Correction Factor(dB/m) = Antenna Factor(dB/m) + Cable Factor(dB) – Pre-Amplifier Factor(dB)
3. The other emission levels were very low against the limit.
4. Margin value = Emission Level – Limit value
5. " * " : Fundamental frequency.



A D T

CHANNEL	TX Channel 39	DETECTOR FUNCTION	Peak (PK)
FREQUENCY RANGE	1GHz ~ 25GHz		

ANTENNA POLARITY & TEST DISTANCE: HORIZONTAL AT 3 M

NO.	FREQ. (MHz)	EMISSION LEVEL (dBuV/m)	LIMIT (dBuV/m)	MARGIN (dB)	ANTENNA HEIGHT (m)	TABLE ANGLE (Degree)	RAW VALUE (dBuV)	CORRECTION FACTOR (dB/m)
1	*2441.00	103.8 PK			1.33 H	115	106.04	-2.24
2	*2441.00	102.4 AV			1.33 H	115	104.64	-2.24
3	4882.00	47.2 PK	74.0	-26.8	1.49 H	272	41.26	5.94
4	4882.00	34.9 AV	54.0	-19.1	1.49 H	272	28.96	5.94
5	7323.00	54.3 PK	74.0	-19.7	1.01 H	273	41.12	13.18
6	7323.00	42.7 AV	54.0	-11.3	1.01 H	273	29.52	13.18

ANTENNA POLARITY & TEST DISTANCE: VERTICAL AT 3 M

NO.	FREQ. (MHz)	EMISSION LEVEL (dBuV/m)	LIMIT (dBuV/m)	MARGIN (dB)	ANTENNA HEIGHT (m)	TABLE ANGLE (Degree)	RAW VALUE (dBuV)	CORRECTION FACTOR (dB/m)
1	*2441.00	107.8 PK			1.24 V	260	110.04	-2.24
2	*2441.00	106.1 AV			1.24 V	260	108.34	-2.24
3	4882.00	48.1 PK	74.0	-25.9	1.03 V	343	42.16	5.94
4	4882.00	36.1 AV	54.0	-17.9	1.03 V	343	30.16	5.94
5	7323.00	53.4 PK	74.0	-20.6	1.01 V	350	40.22	13.18
6	7323.00	41.8 AV	54.0	-12.2	1.01 V	350	28.62	13.18

REMARKS:

1. Emission Level(dBuV/m) = Raw Value(dBuV) + Correction Factor(dB/m)
2. Correction Factor(dB/m) = Antenna Factor(dB/m) + Cable Factor(dB) – Pre-Amplifier Factor(dB)
3. The other emission levels were very low against the limit.
4. Margin value = Emission Level – Limit value
5. " * ": Fundamental frequency.



A D T

CHANNEL	TX Channel 78	DETECTOR FUNCTION	Peak (PK)
FREQUENCY RANGE	1GHz ~ 25GHz		

ANTENNA POLARITY & TEST DISTANCE: HORIZONTAL AT 3 M

NO.	FREQ. (MHz)	EMISSION LEVEL (dBuV/m)	LIMIT (dBuV/m)	MARGIN (dB)	ANTENNA HEIGHT (m)	TABLE ANGLE (Degree)	RAW VALUE (dBuV)	CORRECTION FACTOR (dB/m)
1	*2480.00	104.6 PK			1.28 H	118	106.66	-2.06
2	*2480.00	103.2 AV			1.28 H	118	105.26	-2.06
3	2483.50	53.9 PK	74.0	-20.1	1.28 H	118	55.93	-2.03
4	2483.50	36.0 AV	54.0	-18.0	1.28 H	118	38.03	-2.03
5	4960.00	47.0 PK	74.0	-27.0	1.45 H	286	40.74	6.26
6	4960.00	35.0 AV	54.0	-19.0	1.45 H	286	28.74	6.26
7	7440.00	54.7 PK	74.0	-19.3	1.03 H	272	41.57	13.13
8	7440.00	42.1 AV	54.0	-11.9	1.03 H	272	28.97	13.13

ANTENNA POLARITY & TEST DISTANCE: VERTICAL AT 3 M

NO.	FREQ. (MHz)	EMISSION LEVEL (dBuV/m)	LIMIT (dBuV/m)	MARGIN (dB)	ANTENNA HEIGHT (m)	TABLE ANGLE (Degree)	RAW VALUE (dBuV)	CORRECTION FACTOR (dB/m)
1	*2480.00	106.8 PK			1.49 V	260	108.86	-2.06
2	*2480.00	105.4 AV			1.49 V	260	107.46	-2.06
3	2483.50	58.2 PK	74.0	-15.8	1.49 V	260	60.23	-2.03
4	2483.50	40.9 AV	54.0	-13.1	1.49 V	260	42.93	-2.03
5	4960.00	48.3 PK	74.0	-25.7	1.02 V	351	42.04	6.26
6	4960.00	36.3 AV	54.0	-17.7	1.02 V	351	30.04	6.26
7	7440.00	53.9 PK	74.0	-20.1	1.00 V	339	40.77	13.13
8	7440.00	41.6 AV	54.0	-12.4	1.00 V	339	28.47	13.13

REMARKS:

1. Emission Level(dBuV/m) = Raw Value(dBuV) + Correction Factor(dB/m)
2. Correction Factor(dB/m) = Antenna Factor(dB/m) + Cable Factor(dB) – Pre-Amplifier Factor(dB)
3. The other emission levels were very low against the limit.
4. Margin value = Emission Level – Limit value
5. " * " : Fundamental frequency.

4.10 CONDUCTED EMISSION MEASUREMENT

4.10.1 LIMITS OF CONDUCTED EMISSION MEASUREMENT

FREQUENCY OF EMISSION (MHz)	CONDUCTED LIMIT (dB μ V)	
	Quasi-peak	Average
0.15-0.5	66 to 56	56 to 46
0.5-5	56	46
5-30	60	50

NOTE:

1. The lower limit shall apply at the transition frequencies.
2. All emanations from a class B digital device or system, including any network of conductors and apparatus connected thereto, shall not exceed the level of field strengths specified above.

4.10.2 TEST INSTRUMENTS

DESCRIPTION & MANUFACTURER	MODEL NO.	SERIAL NO.	CALIBRATED DATE	CALIBRATED UNTIL
Test Receiver ROHDE & SCHWARZ	ESCS 30	100375	Apr. 29, 2014	Apr. 28, 2015
Line-Impedance Stabilization Network (for EUT) SCHWARZBECK	NSLK-8127	8127-522	Sep. 15, 2014	Sep. 14, 2015
Line-Impedance Stabilization Network (for Peripheral) ROHDE & SCHWARZ	ENV216	100071	Nov. 13, 2013	Nov. 12, 2014
RF Cable (JYEBAO)	5DFB	COCCAB-001	Mar. 10, 2014	Mar. 09, 2015
50 ohms Terminator	N/A	EMC-03	Sep. 22, 2014	Sep. 21, 2015
50 ohms Terminator	N/A	EMC-02	Oct. 01, 2013	Sep. 30, 2014
Software ADT	BV ADT_Cond_V7.3.7. 3	NA	NA	NA

Note:

1. The calibration interval of the above test instruments is 12 months and the calibrations are traceable to NML/ROC and NIST/USA.
2. The test was performed in Shielded Room No. C.
3. The VCCI Con C Registration No. is C-3611.
4. Tested Date: Sep. 24, 2014

4.10.3 TEST PROCEDURES

- a. The EUT was placed 0.4 meters from the conducting wall of the shielded room with EUT being connected to the power mains through a line impedance stabilization network (LISN). Other support units were connected to the power mains through another LISN. The two LISNs provide 50 ohm/ 50uH of coupling impedance for the measuring instrument.
- b. Both lines of the power mains connected to the EUT were checked for maximum conducted interference.
- c. The frequency range from 150kHz to 30MHz was searched. Emission levels under (Limit – 20dB) were not recorded.

NOTE: The resolution bandwidth of test receiver is 9kHz for Quasi-peak detection (QP) & Average detection (AV).

4.10.4 DEVIATION FROM TEST STANDARD

No deviation

4.10.5 TEST SETUP

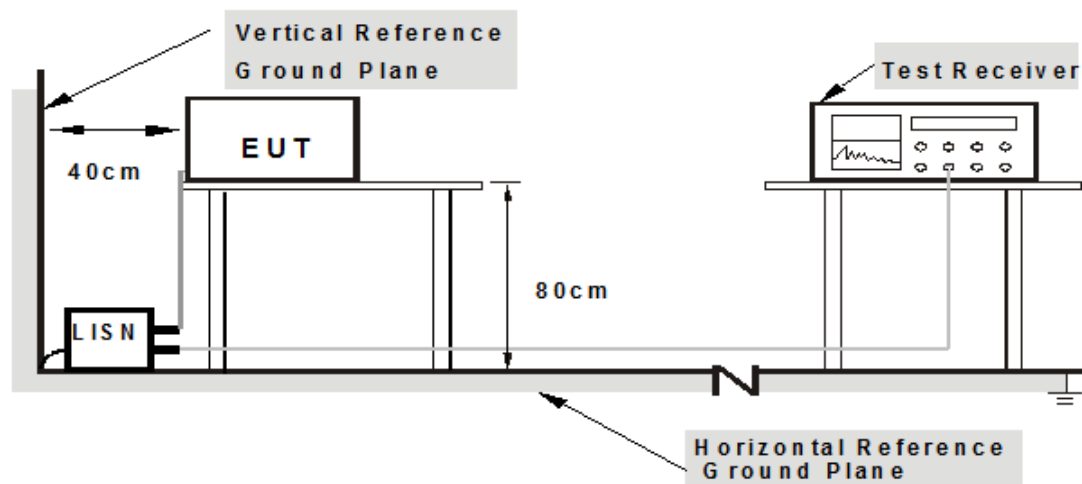

Note: 1. Support units were connected to second LISN.

For the actual test configuration, please refer to the related item – Photographs of the Test Configuration.

4.10.6 EUT OPERATING CONDITIONS

Same as Item 4.8.6

4.10.7 TEST RESULTS

PHASE	Line (L)	DETECTOR FUNCTION	Quasi-Peak (QP) / Average (AV)
-------	----------	-------------------	--------------------------------

No	Freq. [MHz]	Corr. Factor (dB)	Reading Value [dB (uV)]		Emission Level [dB (uV)]		Limit [dB (uV)]		Margin (dB)	
			Q.P.	AV.	Q.P.	AV.	Q.P.	AV.	Q.P.	AV.
1	0.17344	0.07	40.30	27.65	40.37	27.72	64.79	54.79	-24.43	-27.08
2	0.19687	0.07	34.88	10.76	34.95	10.83	63.74	53.74	-28.79	-42.91
3	0.72813	0.11	31.40	22.86	31.51	22.97	56.00	46.00	-24.49	-23.03
4	2.61328	0.20	27.06	19.86	27.26	20.06	56.00	46.00	-28.74	-25.94
5	7.02344	0.36	26.52	18.62	26.88	18.98	60.00	50.00	-33.12	-31.02
6	18.19531	0.67	23.16	16.86	23.83	17.53	60.00	50.00	-36.17	-32.47

REMARKS:

1. Q.P. and AV. are abbreviations of quasi-peak and average individually.
2. The emission levels of other frequencies were very low against the limit.
3. Margin value = Emission Level – Limit value
4. Correction Factor = Insertion loss + Cable loss
5. Emission Level = Correction Factor + Reading Value

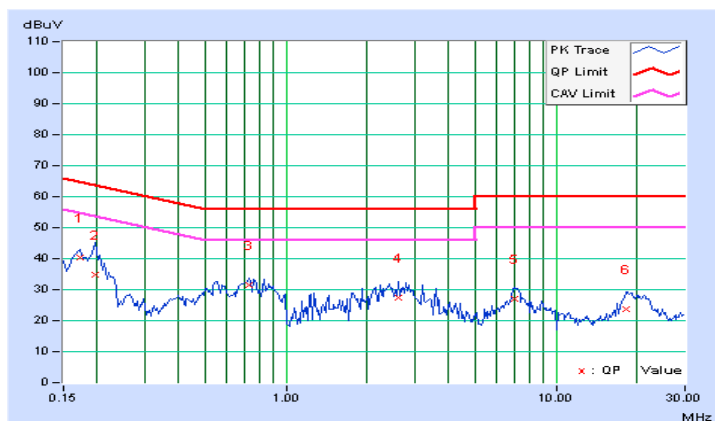



A D T

PHASE	Neutral (N)	DETECTOR FUNCTION	Quasi-Peak (QP) / Average (AV)
--------------	-------------	--------------------------	--------------------------------

No	Freq.	Corr.	Reading Value		Emission Level		Limit		Margin	
	[MHz]	Factor	[dB (uV)]		[dB (uV)]		[dB (uV)]		(dB)	
		(dB)	Q.P.	AV.	Q.P.	AV.	Q.P.	AV.	Q.P.	AV.
1	0.15781	0.07	43.08	18.93	43.15	19.00	65.58	55.58	-22.42	-36.57
2	0.72422	0.11	32.24	19.41	32.35	19.52	56.00	46.00	-23.65	-26.48
3	3.07422	0.22	29.15	20.17	29.37	20.39	56.00	46.00	-26.63	-25.61
4	6.87109	0.35	26.96	17.78	27.31	18.13	60.00	50.00	-32.69	-31.87
5	8.77344	0.41	24.97	16.30	25.38	16.71	60.00	50.00	-34.62	-33.29
6	17.97266	0.65	25.40	17.88	26.05	18.53	60.00	50.00	-33.95	-31.47

REMARKS:

1. Q.P. and AV. are abbreviations of quasi-peak and average individually.
2. The emission levels of other frequencies were very low against the limit.
3. Margin value = Emission Level – Limit value
4. Correction Factor = Insertion loss + Cable loss
5. Emission Level = Correction Factor + Reading Value

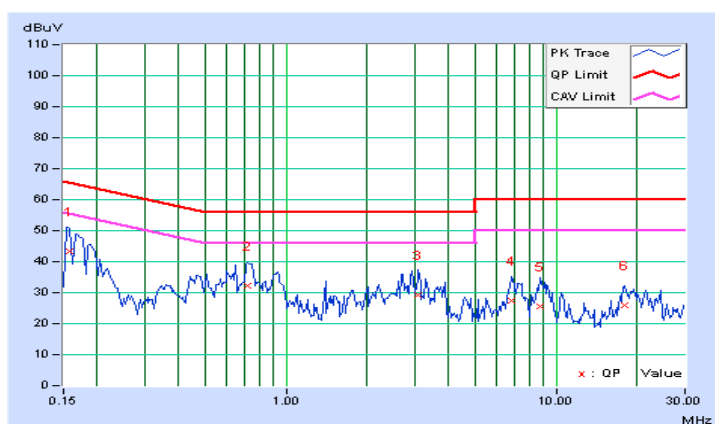

5 TEST TYPES AND RESULTS (DTS)

5.1 CONDUCTED OUTPUT POWER MEASUREMENT

5.1.1 LIMITS OF MAXIMUM OUTPUT POWER MEASUREMENT

For systems using digital modulation in the 2400–2483.5 MHz band: 1 Watt (30dBm)

5.1.2 INSTRUMENTS

DESCRIPTION & MANUFACTURER	MODEL NO.	SERIAL NO.	CALIBRATED DATE	CALIBRATED UNTIL
Power meter Anritsu	ML2495A	1014008	Apr. 30, 2014	Apr. 29, 2015
Power sensor Anritsu	MA2411B	0917122	Apr. 30, 2014	Apr. 29, 2015

Note:

1. The calibration interval of the above test instruments is 12 months and the calibrations are traceable to NML/ROC and NIST/USA.
2. Tested date : Oct. 15, 2014

5.1.3 TEST PROCEDURES

The peak / average power sensor was used on the output port of the EUT. A power meter was used to read the response of the peak / average power sensor. Record the peak power level.

5.1.4 DEVIATION FROM TEST STANDARD

No deviation

5.1.5 TEST SETUP

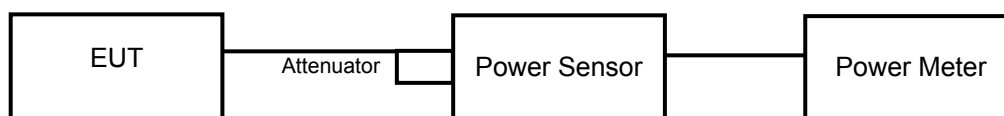

5.1.6 EUT OPERATING CONDITIONS

The software (QCRT Version3.0 29.0) provided by client to enable the EUT under transmission condition continuously at lowest, middle and highest channel frequencies individually.

5.1.7 TEST RESULTS

FOR PEAK POWER

BT_LE-GFSK

CHANNEL	FREQUENCY (MHz)	PEAK POWER (mW)	PEAK POWER (dBm)	LIMIT (dBm)	PASS/FAIL
0	2402	1.871	2.72	30	PASS
19	2440	1.972	2.95	30	PASS
39	2480	1.959	2.92	30	PASS

FOR AVERAGE POWER

BT_LE-GFSK

CHANNEL	FREQUENCY (MHz)	AVERAGE POWER (mW)	AVERAGE POWER (dBm)
0	2402	1.807	2.57
19	2440	1.910	2.81
39	2480	1.892	2.77

5.2 POWER SPECTRAL DENSITY MEASUREMENT

5.2.1 LIMITS OF POWER SPECTRAL DENSITY MEASUREMENT

The Maximum of Power Spectral Density Measurement is 8dBm.

5.2.2 TEST INSTRUMENTS

DESCRIPTION & MANUFACTURER	MODEL NO.	SERIAL NO.	CALIBRATED DATE	CALIBRATED UNTIL
SPECTRUM ANALYZER R&S	FSV 40	100964	July 05, 2014	July 04, 2015

Note:

1. The calibration interval of the above test instruments is 12 months and the calibrations are traceable to NML/ROC and NIST/USA.
2. Tested date : Oct. 15, 2014

5.2.3 TEST PROCEDURE

1. Set the RBW = 3 kHz, VBW =10 kHz, Detector = peak.
2. Sweep time = auto couple, Trace mode = max hold, allow trace to fully stabilize.
3. Use the peak marker function to determine the maximum amplitude level.

5.2.4 DEVIATION FROM TEST STANDARD

No deviation

5.2.5 TEST SETUP

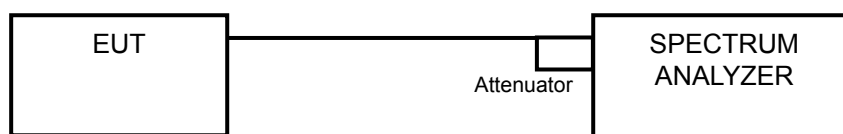

5.2.6 EUT OPERATING CONDITION

Same as Item 5.1.6



A D T

5.2.7 TEST RESULTS

BT_LE-GFSK

Channel	FREQUENCY (MHz)	PSD (dBm)	Limit (dBm)	PASS /FAIL
0	2402	-14.82	8	PASS
19	2440	-13.85	8	PASS
39	2480	-12.91	8	PASS

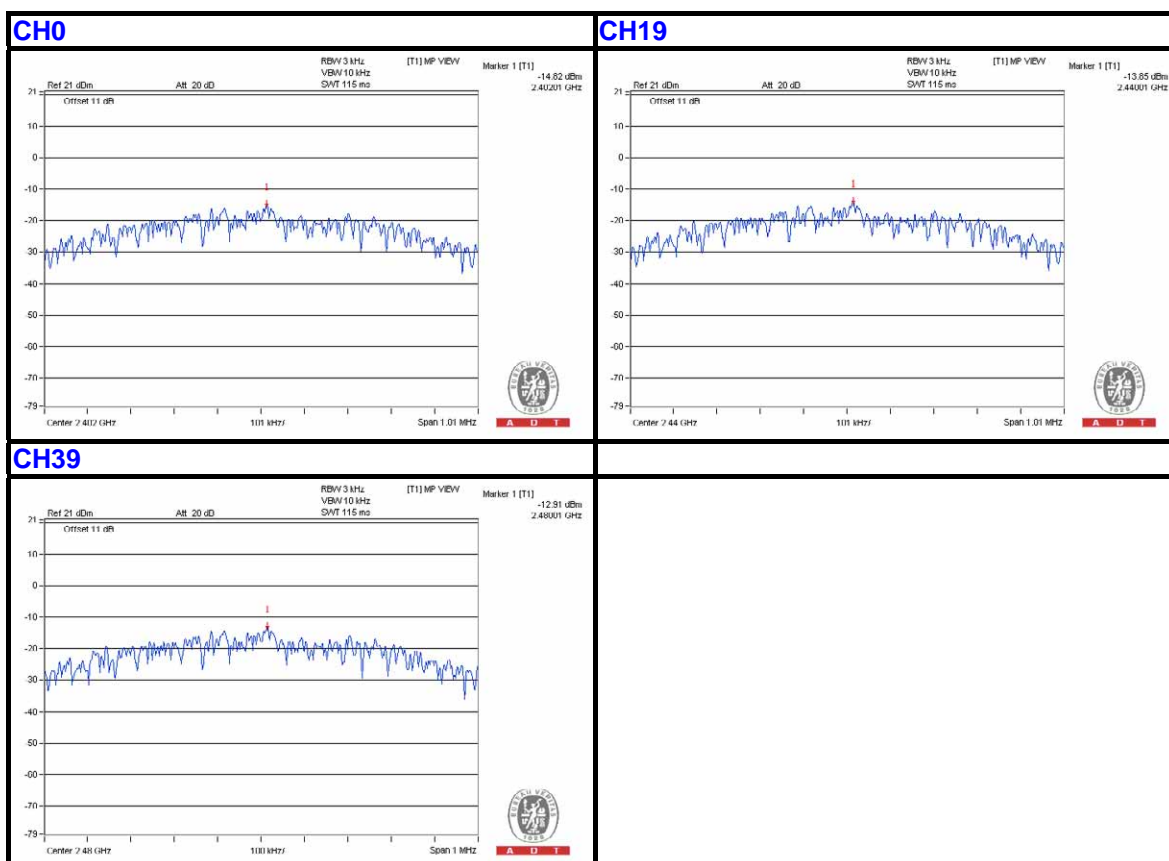

5.3 6dB BANDWIDTH MEASUREMENT

5.3.1 LIMITS OF 6dB BANDWIDTH MEASUREMENT

The minimum of 6dB Bandwidth Measurement is 0.5 MHz.

5.3.2 TEST INSTRUMENTS

DESCRIPTION & MANUFACTURER	MODEL NO.	SERIAL NO.	CALIBRATED DATE	CALIBRATED UNTIL
SPECTRUM ANALYZER R&S	FSV 40	100060	May 08, 2014	May 07, 2015

Note:

1. The calibration interval of the above test instruments is 12 months and the calibrations are traceable to NML/ROC and NIST/USA.
2. Tested date : Oct. 15, 2014

5.3.3 TEST PROCEDURE

1. Set resolution bandwidth (RBW) = 100kHz
2. Set the video bandwidth (VBW) $\geq 3 \times$ RBW, Detector = Peak.
3. Trace mode = max hold.
4. Sweep = auto couple.
5. Measure the maximum width of the emission that is constrained by the frequencies associated with the two amplitude points (upper and lower) that are attenuated by 6 dB relative to the maximum level measured in the fundamental emission

5.3.4 DEVIATION FROM TEST STANDARD

No deviation

5.3.5 TEST SETUP

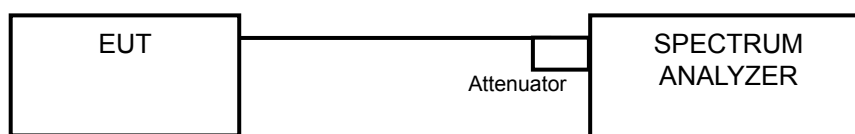

5.3.6 EUT OPERATING CONDITIONS

Same as Item 5.1.6



A D T

5.3.7 TEST RESULTS

BT_LE-GFSK

CHANNEL	CHANNEL FREQUENCY (MHz)	6dB BANDWIDTH (MHz)
0	2402	0.68
19	2440	0.68
39	2480	0.67

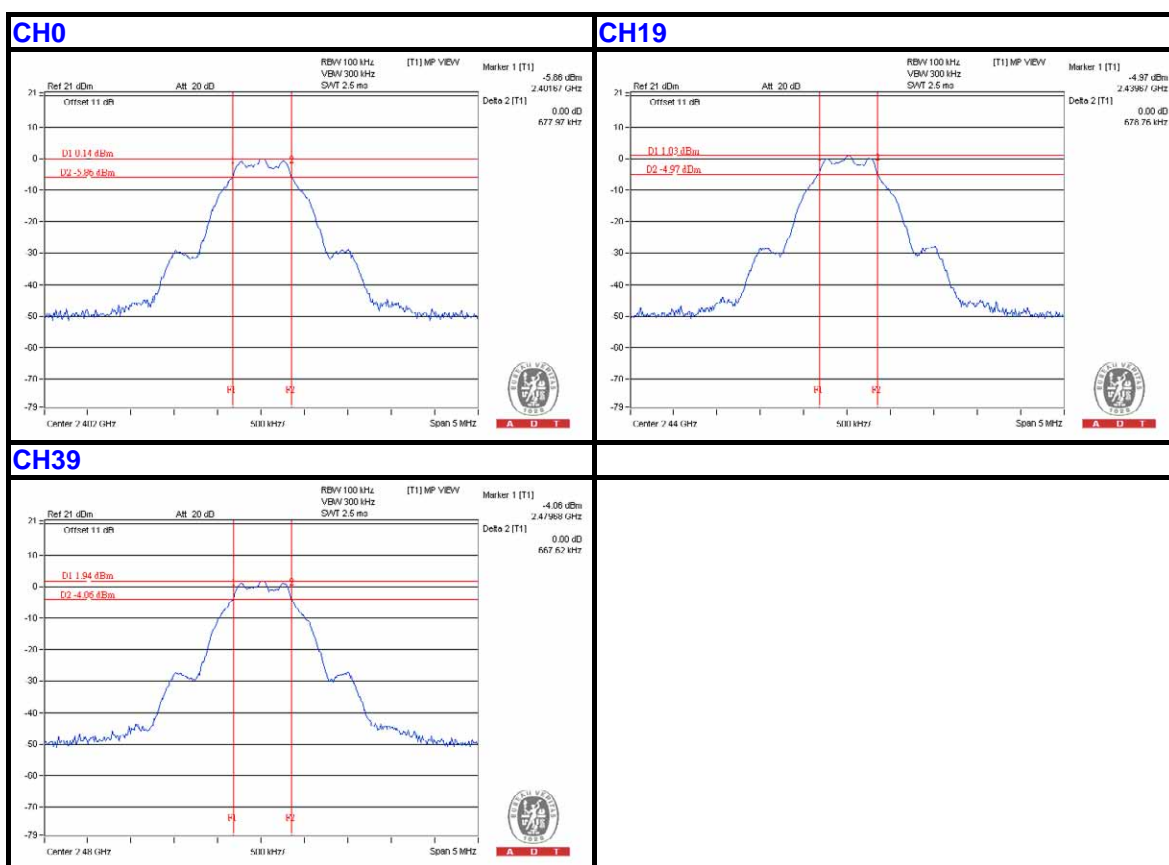

5.4 OCCUPIED BANDWIDTH MEASUREMENT

5.4.1 TEST INSTRUMENTS

DESCRIPTION & MANUFACTURER	MODEL NO.	SERIAL NO.	CALIBRATED DATE	CALIBRATED UNTIL
SPECTRUM ANALYZER R&S	FSV 40	100060	May 08, 2014	May 07, 2015

Note:

1. The calibration interval of the above test instruments is 12 months and the calibrations are traceable to NML/ROC and NIST/USA.
2. Tested date : Oct. 15, 2014

5.4.2 TEST PROCEDURE

1. Set RBW \geq 1% of the emission bandwidth.
2. Set the VBW $>$ 3 \times RBW.
3. Detector = Peak.
4. Trace mode = max hold.
5. Record the 99% emission bandwidth.

5.4.3 TEST SETUP



5.4.4 EUT OPERATING CONDITIONS

Same as Item 4.1.6

5.4.5 TEST RESULTS

BT LE-GFSK

CHANNEL	CHANNEL FREQUENCY (MHz)	OCCUPIED BANDWIDTH (MHz)
0	2402	1.10
19	2440	1.10
39	2480	1.10

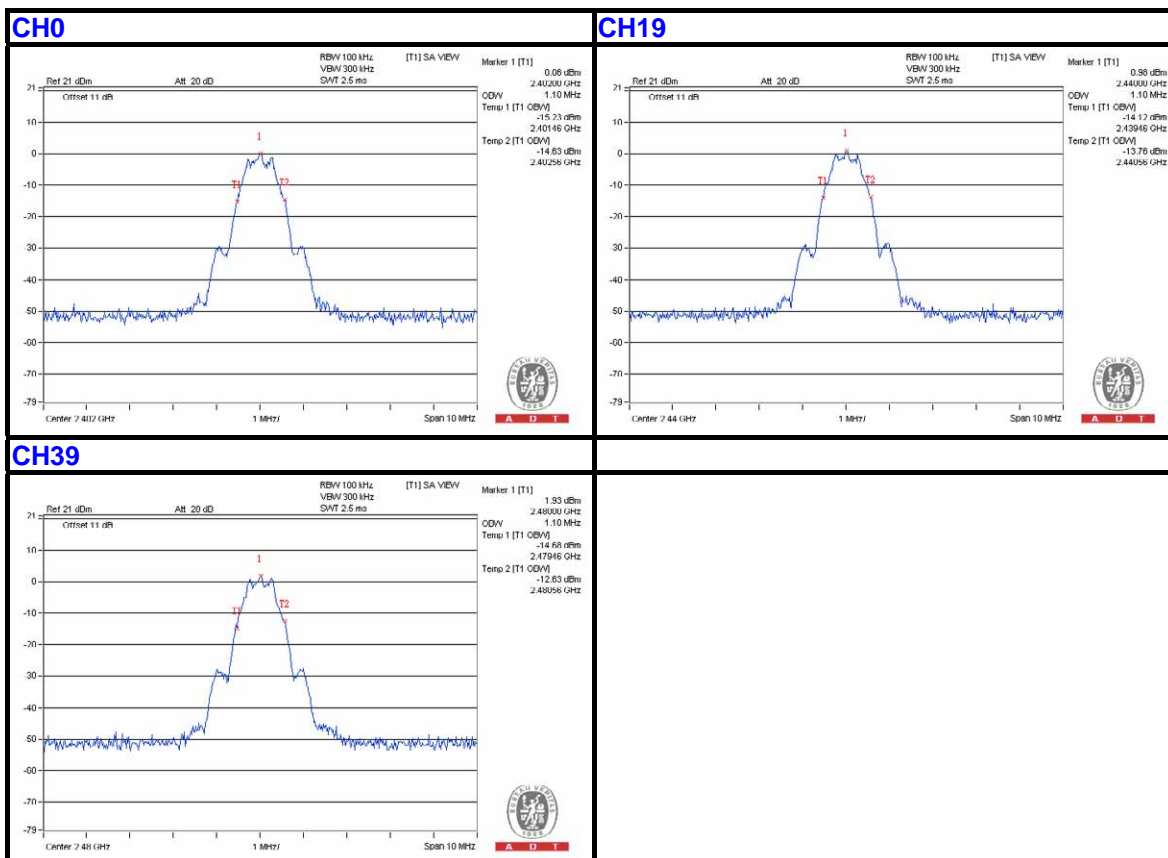

5.5 CONDUCTED OUT-BAND EMISSION MEASUREMENT

5.5.1 LIMITS OF CONDUCTED OUT-BAND EMISSION MEASUREMENT

Below -20dB of the highest emission level of operating band (in 100kHz Resolution Bandwidth).

5.5.2 TEST INSTRUMENTS

DESCRIPTION & MANUFACTURER	MODEL NO.	SERIAL NO.	CALIBRATED DATE	CALIBRATED UNTIL
SPECTRUM ANALYZER R&S	FSV 40	100060	May 08, 2014	May 07, 2015

Note:

1. The calibration interval of the above test instruments is 12 months and the calibrations are traceable to NML/ROC and NIST/USA.
2. Tested date : Oct. 15, 2014

5.5.3 TEST PROCEDURE

Measurement Procedure - Reference Level

1. Set the RBW = 100 kHz.
2. Set the VBW \geq 300 kHz.
3. Detector = peak.
4. Sweep time = auto couple.
5. Trace mode = max hold.
6. Allow trace to fully stabilize.
7. Use the peak marker function to determine the maximum power level in any 100 kHz band segment within the fundamental EBW.

Measurement Procedure –Unwanted Emission Level

1. Set RBW = 100 kHz.
2. Set VBW \geq 300 kHz.
3. Set span to encompass the spectrum to be examined
4. Detector = peak.
5. Trace Mode = max hold.
6. Sweep = auto couple.

5.5.4 DEVIATION FROM TEST STANDARD

No deviation

5.5.5 EUT OPERATING CONDITION

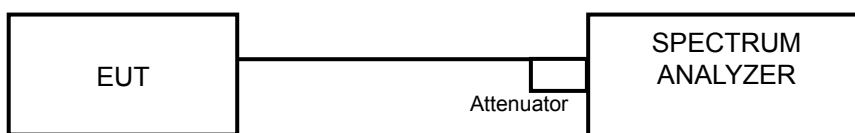

5.5.6 TEST RESULTS

The spectrum plots are attached on the following pages. D1 line indicates the highest level, and D2 line indicates the 20dB offset below D1. It shows compliance with the requirement.



A D T

BT_LE-GFSK

CH 0

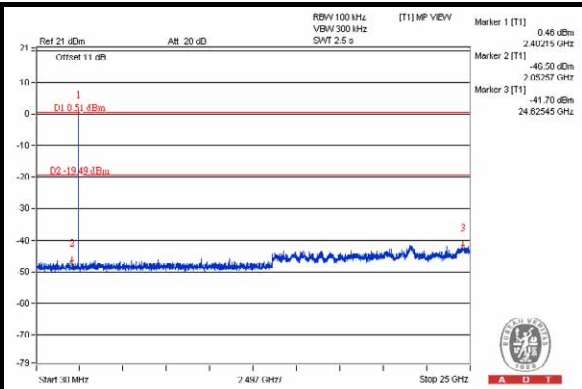
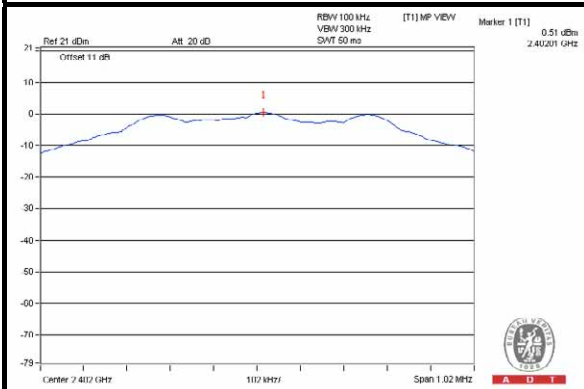

CH 19

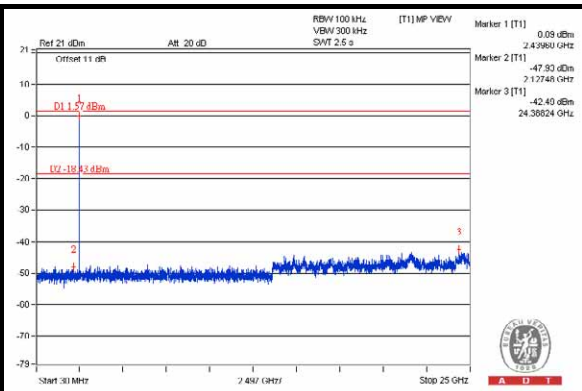
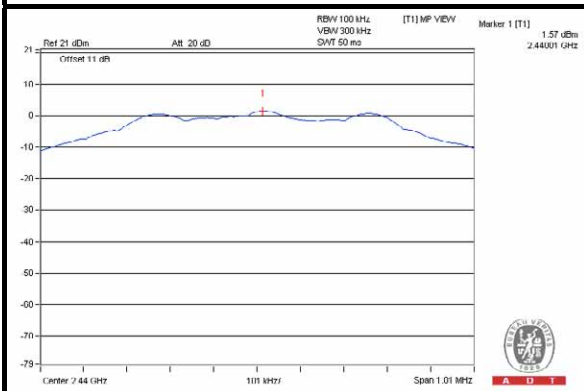

CH 39

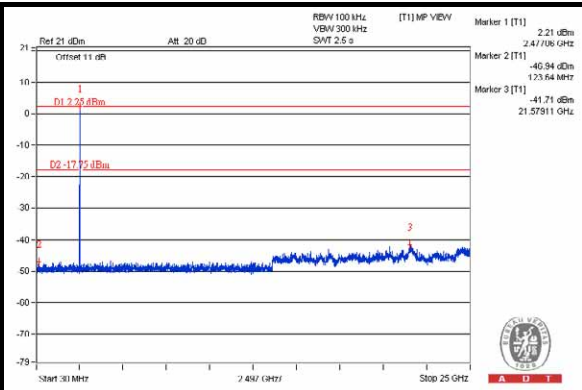
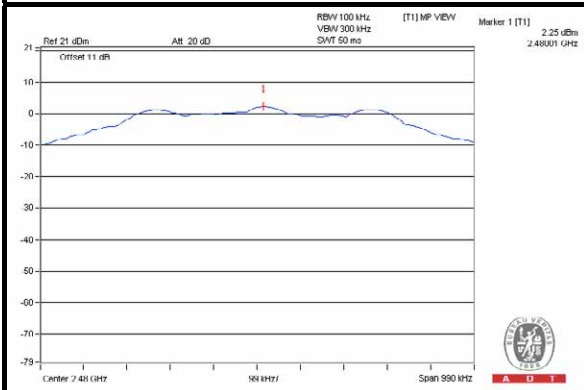

CH 0 Band edge

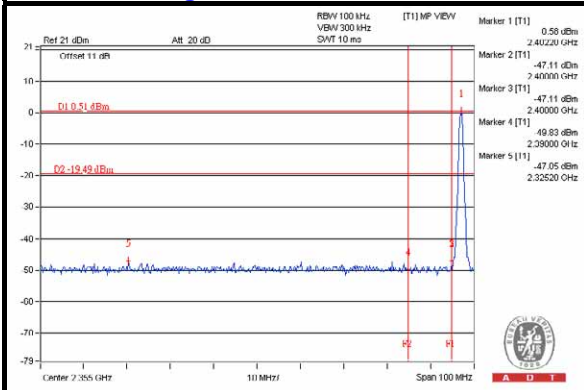

CH 39 Band edge

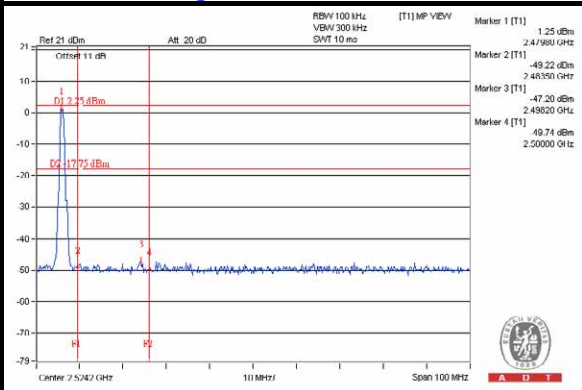

5.6 UNWANTED EMISSION MEASUREMENT(RADIATED VERSUS CONDUCTED)

5.6.1 LIMITS OF UNWANTED EMISSION MEASUREMENT

Radiated emissions which fall in the restricted bands must comply with the radiated emission limits specified as below table. Other emissions shall be at least 20dB below the highest level of the desired power:

Frequencies (MHz)	Field strength (microvolts/meter)	Measurement distance (meters)
0.009-0.490	2400/F(kHz)	300
0.490-1.705	24000/F(kHz)	30
1.705-30.0	30	30
30-88	100	3
88-216	150	3
216-960	200	3
Above 960	500	3

NOTE:

1. The lower limit shall apply at the transition frequencies.
2. Emission level (dBuV/m) = 20 log Emission level (uV/m).
3. For frequencies above 1000MHz, the field strength limits are based on average detector, however, the peak field strength of any emission shall not exceed the maximum permitted average limits, specified above by more than 20dB under any condition of modulation.



A D T

5.6.2 TEST INSTRUMENTS

For below 1GHz test:

DESCRIPTION & MANUFACTURER	MODEL NO.	SERIAL NO.	CALIBRATED DATE	CALIBRATED UNTIL
MXE EMI Receiver Agilent	N9038A	MY51210105	July 21, 2014	July 20, 2015
Pre-Amplifier Mini-Circuits	ZFL-1000VH2 B	AMP-ZFL-03	Nov. 13, 2013	Nov. 12, 2014
Trilog Broadband Antenna SCHWARZBECK	VULB 9168	9168-360	Feb. 26, 2014	Feb. 25, 2015
RF Cable	NA	CHGCAB_001	Oct. 05, 2013	Oct. 04, 2014
Horn_Antenna AISL	AIH.8018	0000320091110	Aug. 27, 2014	Aug. 26, 2015
Pre-Amplifier Agilent	8449B	3008A02578	June 24, 2014	June 23, 2015
RF Cable	NA	131205 131214 SNMY23684/4	Jan. 17, 2014	Jan. 16, 2015
Spectrum Analyzer R&S	FSV40	100964	July 05, 2014	July 04, 2015
Pre-Amplifier SPACEK LABS	SLKKa-48-6	9K16	Nov. 13, 2013	Nov. 12, 2014
Horn_Antenna SCHWARZBECK	BBHA 9170	9170-424	Aug. 26, 2014	Aug. 25, 2015
RF Cable	NA	RF104-121 RF104-204	Dec. 12, 2013	Dec. 11, 2014
Antenna Tower & Turn Table CT	NA	NA	NA	NA

Note:

1. The calibration interval of the above test instruments is 12 months and the calibrations are traceable to NML/ROC and NIST/USA.
2. The horn antenna, preamplifier (model: 8449B) are used only for the measurement of emission frequency above 1GHz if tested.
3. The test was performed in 966 Chamber No. G.
4. The FCC Site Registration No. is 966073.
5. The VCCI Site Registration No. is G-137.
6. The CANADA Site Registration No. is IC 7450H-2.
7. Tested Date: Aug. 27, 2014



A D T

For above 1GHz test:

DESCRIPTION & MANUFACTURER	MODEL NO.	SERIAL NO.	CALIBRATED DATE	CALIBRATED UNTIL
MXE EMI Receiver Agilent	N9038A	MY51210105	July 21, 2014	July 20,2015
Pre-Amplifier Mini-Circuits	ZFL-1000VH2 B	AMP-ZFL-03	Nov. 13, 2013	Nov. 12, 2014
Trilog Broadband Antenna SCHWARZBECK	VULB 9168	9168-360	Feb. 26, 2014	Feb. 25, 2015
RF Cable	NA	CHGCAB_001	Oct. 04, 2014	Oct. 03, 2015
Horn_Antenna AISI	AIH.8018	0000320091110	Aug. 27, 2014	Aug. 26, 2015
Pre-Amplifier Agilent	8449B	3008A02578	June 24, 2014	June 23, 2015
RF Cable	NA	131205 131214 SNMY23684/4	Jan. 17, 2014	Jan. 16, 2015
Spectrum Analyzer R&S	FSV40	100964	July 05, 2014	July 04, 2015
Pre-Amplifier SPACEK LABS	SLKKa-48-6	9K16	Nov. 13, 2013	Nov. 12, 2014
Horn_Antenna SCHWARZBECK	BBHA 9170	9170-424	Aug. 26, 2014	Aug. 25, 2015
RF Cable	NA	RF104-121 RF104-204	Dec. 12, 2013	Dec. 11, 2014
Antenna Tower & Turn Table CT	NA	NA	NA	NA

Note:

1. The calibration interval of the above test instruments is 12 months and the calibrations are traceable to NML/ROC and NIST/USA.
2. The horn antenna, preamplifier (model: 8449B) are used only for the measurement of emission frequency above 1GHz if tested.
3. The test was performed in 966 Chamber No. G.
4. The FCC Site Registration No. is 966073.
5. The VCCI Site Registration No. is G-137.
6. The CANADA Site Registration No. is IC 7450H-2.
7. Tested Date: Oct. 16, 2014

5.6.3 TEST PROCEDURES

- a. The EUT was placed on the top of a rotating table 0.8 meters above the ground at 3 meter chamber room for test. The table was rotated 360 degrees to determine the position of the highest radiation.
- b. The EUT was set 3 meters away from the interference-receiving antenna, which was mounted on the top of a variable-height antenna tower.
- c. The height of antenna is varied from one meter to four meters above the ground to determine the maximum value of the field strength. Both horizontal and vertical polarizations of the antenna are set to make the measurement.
- d. For each suspected emission, the EUT was arranged to its worst case and then the antenna was tuned to heights from 1 meter to 4 meters and the rotatable table was turned from 0 degrees to 360 degrees to find the maximum reading.
- e. The test-receiver system was set to quasi-peak detect function and specified bandwidth with maximum hold mode when the test frequency is below 1 GHz.
- f. The test-receiver system was set to peak and average detect function and specified bandwidth with maximum hold mode when the test frequency is above 1 GHz. If the peak reading value also meets average limit, measurement with the average detector is unnecessary.

Note:

1. The resolution bandwidth and video bandwidth of test receiver/spectrum analyzer is 120kHz for Quasi-peak detection (QP) at frequency below 1GHz.
2. The resolution bandwidth of test receiver/spectrum analyzer is 1 MHz and the video bandwidth is 3 MHz for Peak detection (PK) at frequency above 1GHz.
3. The resolution bandwidth of test receiver/spectrum analyzer is 1MHz and the video bandwidth is $\geq 1/T$ (Duty cycle $< 98\%$) or 10Hz (Duty cycle $\geq 98\%$) for Average detection (AV) at frequency above 1GHz.
4. All modes of operation were investigated and the worst-case emissions are reported.

5.6.4 DEVIATION FROM TEST STANDARD

No deviation

5.6.5 TEST SETUP

<Frequency Range below 1GHz>

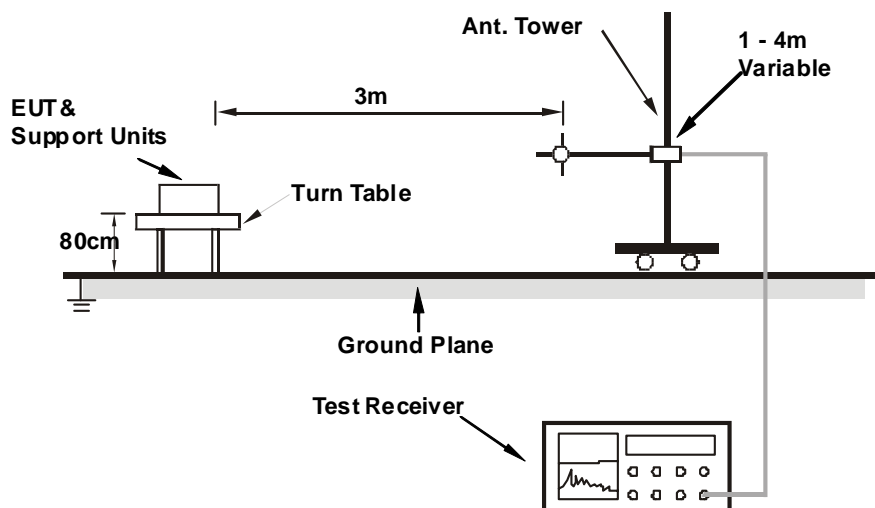

<Frequency Range above 1GHz>

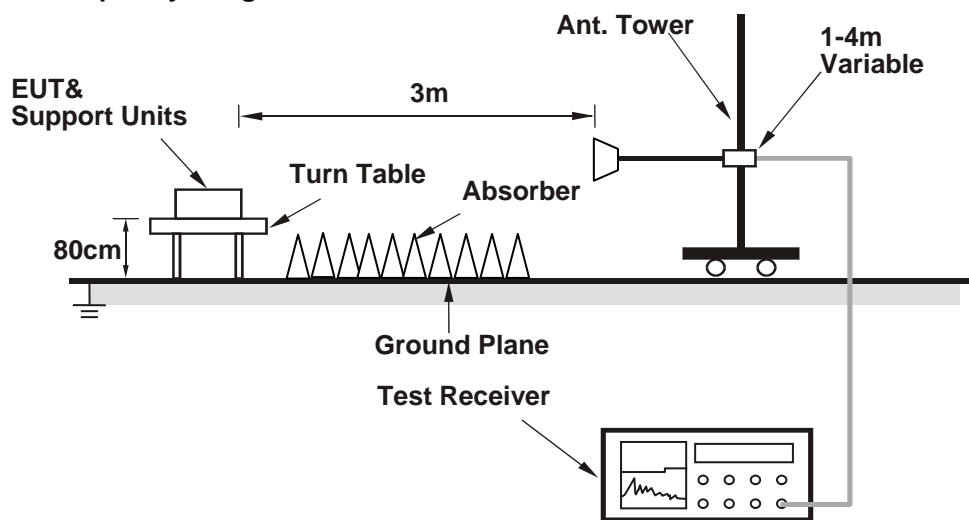

For the actual test configuration, please refer to the related item – Photographs of the Test Configuration.

5.6.6 EUT OPERATING CONDITIONS

1. Connect the EUT with the support unit A (Notebook Computer) which is placed on a testing table.
2. The communication partner run test program “QCRT Version3.0 29.0” to enable EUT under transmission/receiving condition continuously at specific channel frequency.

5.6.7 TEST RESULTS(MODE 1)

BELOW 1GHz WORST-CASE DATA

BT_LE-GFSK

CHANNEL	TX Channel 19	DETECTOR FUNCTION	Quasi-Peak (QP)
FREQUENCY RANGE	30MHz ~ 1GHz		

ANTENNA POLARITY & TEST DISTANCE: HORIZONTAL AT 3 M

NO.	FREQ. (MHz)	EMISSION LEVEL (dBuV/m)	LIMIT (dBuV/m)	MARGIN (dB)	ANTENNA HEIGHT (m)	TABLE ANGLE (Degree)	RAW VALUE (dBuV)	CORRECTION FACTOR (dB/m)
1	89.41	33.4 QP	43.5	-10.2	2.00 H	100	52.47	-19.12
2	165.99	29.7 QP	43.5	-13.8	1.50 H	38	43.19	-13.49
3	255.09	37.9 QP	46.0	-8.1	1.50 H	98	52.05	-14.12
4	328.42	35.4 QP	46.0	-10.6	1.00 H	360	46.92	-11.49
5	666.51	34.0 QP	46.0	-12.0	1.00 H	123	37.95	-3.99
6	945.83	33.7 QP	46.0	-12.3	1.50 H	310	32.71	0.96

ANTENNA POLARITY & TEST DISTANCE: VERTICAL AT 3 M

NO.	FREQ. (MHz)	EMISSION LEVEL (dBuV/m)	LIMIT (dBuV/m)	MARGIN (dB)	ANTENNA HEIGHT (m)	TABLE ANGLE (Degree)	RAW VALUE (dBuV)	CORRECTION FACTOR (dB/m)
1	31.50	32.7 QP	40.0	-7.3	1.50 V	360	47.26	-14.52
2	87.04	32.7 QP	40.0	-7.3	1.00 V	51	51.74	-19.05
3	166.04	32.0 QP	43.5	-11.5	1.00 V	270	45.45	-13.49
4	331.38	33.9 QP	46.0	-12.1	1.50 V	157	45.31	-11.45
5	666.51	34.0 QP	46.0	-12.0	2.00 V	267	37.97	-3.99
6	940.59	31.2 QP	46.0	-14.8	1.00 V	76	30.37	0.85

REMARKS:

1. Emission Level(dBuV/m) = Raw Value(dBuV) + Correction Factor(dB/m)
2. Correction Factor(dB/m) = Antenna Factor(dB/m) + Cable Factor(dB) – Pre-Amplifier Factor(dB)
3. The other emission levels were very low against the limit.
4. Margin value = Emission Level – Limit value



ABOVE 1GHz DATA

BT_LE-GFSK

CHANNEL	TX Channel 0	DETECTOR FUNCTION	Peak (PK)
FREQUENCY RANGE	1GHz ~ 25GHz		

ANTENNA POLARITY & TEST DISTANCE: HORIZONTAL AT 3 M								
NO.	FREQ. (MHz)	EMISSION LEVEL (dBuV/m)	LIMIT (dBuV/m)	MARGIN (dB)	ANTENNA HEIGHT (m)	TABLE ANGLE (Degree)	RAW VALUE (dBuV)	CORRECTION FACTOR (dB/m)
1	2390.00	45.4 PK	74.0	-28.6	1.56 H	325	47.87	-2.47
2	2390.00	34.6 AV	54.0	-19.4	1.56 H	325	37.07	-2.47
3	*2402.00	92.5 PK			1.56 H	325	94.91	-2.41
4	*2402.00	87.4 AV			1.56 H	325	89.81	-2.41
5	4804.00	44.2 PK	74.0	-29.8	1.00 H	104	38.58	5.62
6	4804.00	14.8 AV	54.0	-39.2	1.00 H	104	9.18	5.62
ANTENNA POLARITY & TEST DISTANCE: VERTICAL AT 3 M								
NO.	FREQ. (MHz)	EMISSION LEVEL (dBuV/m)	LIMIT (dBuV/m)	MARGIN (dB)	ANTENNA HEIGHT (m)	TABLE ANGLE (Degree)	RAW VALUE (dBuV)	CORRECTION FACTOR (dB/m)
1	2390.00	45.6 PK	74.0	-28.4	1.77 V	15	48.07	-2.47
2	2390.00	34.8 AV	54.0	-19.2	1.77 V	15	37.27	-2.47
3	*2402.00	95.1 PK			1.77 V	15	97.51	-2.41
4	*2402.00	90.6 AV			1.77 V	15	93.01	-2.41
5	4804.00	47.0 PK	74.0	-27.0	1.01 V	186	41.38	5.62
6	4804.00	17.9 AV	54.0	-36.1	1.01 V	186	12.28	5.62

REMARKS:

1. Emission Level(dBuV/m) = Raw Value(dBuV) + Correction Factor(dB/m)
2. Correction Factor(dB/m) = Antenna Factor(dB/m) + Cable Factor(dB) – Pre-Amplifier Factor(dB)
3. The other emission levels were very low against the limit.
4. Margin value = Emission Level – Limit value
5. " * ": Fundamental frequency.



A D T

CHANNEL	TX Channel 19	DETECTOR FUNCTION	Peak (PK)
FREQUENCY RANGE	1GHz ~ 25GHz		

ANTENNA POLARITY & TEST DISTANCE: HORIZONTAL AT 3 M

NO.	FREQ. (MHz)	EMISSION LEVEL (dBuV/m)	LIMIT (dBuV/m)	MARGIN (dB)	ANTENNA HEIGHT (m)	TABLE ANGLE (Degree)	RAW VALUE (dBuV)	CORRECTION FACTOR (dB/m)
1	*2440.00	93.2 PK			1.54 H	307	95.44	-2.24
2	*2440.00	87.1 AV			1.54 H	307	89.34	-2.24
3	4880.00	44.8 PK	74.0	-29.2	1.04 H	88	38.86	5.94
4	4880.00	14.8 AV	54.0	-39.2	1.04 H	88	8.86	5.94
5	7320.00	54.0 PK	74.0	-20.0	1.00 H	283	40.81	13.19
6	7320.00	24.4 AV	54.0	-29.6	1.00 H	283	11.21	13.19

ANTENNA POLARITY & TEST DISTANCE: VERTICAL AT 3 M

NO.	FREQ. (MHz)	EMISSION LEVEL (dBuV/m)	LIMIT (dBuV/m)	MARGIN (dB)	ANTENNA HEIGHT (m)	TABLE ANGLE (Degree)	RAW VALUE (dBuV)	CORRECTION FACTOR (dB/m)
1	*2440.00	95.6 PK			1.14 V	327	97.84	-2.24
2	*2440.00	91.0 AV			1.14 V	327	93.24	-2.24
3	4880.00	47.7 PK	74.0	-26.3	1.04 V	187	41.76	5.94
4	4880.00	18.1 AV	54.0	-35.9	1.04 V	187	12.16	5.94
5	7320.00	53.7 PK	74.0	-20.3	1.14 V	21	40.51	13.19
6	7320.00	23.1 AV	54.0	-30.9	1.14 V	21	9.91	13.19

REMARKS:

1. Emission Level(dBuV/m) = Raw Value(dBuV) + Correction Factor(dB/m)
2. Correction Factor(dB/m) = Antenna Factor(dB/m) + Cable Factor(dB) – Pre-Amplifier Factor(dB)
3. The other emission levels were very low against the limit.
4. Margin value = Emission Level – Limit value
5. " * ": Fundamental frequency.



A D T

CHANNEL	TX Channel 39	DETECTOR FUNCTION	Peak (PK)
FREQUENCY RANGE	1GHz ~ 25GHz		

ANTENNA POLARITY & TEST DISTANCE: HORIZONTAL AT 3 M

NO.	FREQ. (MHz)	EMISSION LEVEL (dBuV/m)	LIMIT (dBuV/m)	MARGIN (dB)	ANTENNA HEIGHT (m)	TABLE ANGLE (Degree)	RAW VALUE (dBuV)	CORRECTION FACTOR (dB/m)
1	*2480.00	93.3 PK			1.19 H	306	95.36	-2.06
2	*2480.00	87.7 AV			1.19 H	306	89.76	-2.06
3	2483.50	45.2 PK	74.0	-28.8	1.19 H	306	47.23	-2.03
4	2483.50	34.0 AV	54.0	-20.0	1.19 H	306	36.03	-2.03
5	4960.00	45.7 PK	74.0	-28.3	1.06 H	103	39.44	6.26
6	4960.00	15.8 AV	54.0	-38.2	1.06 H	103	9.54	6.26
7	7440.00	53.9 PK	74.0	-20.1	1.03 H	297	40.77	13.13
8	7440.00	24.1 AV	54.0	-29.9	1.03 H	297	10.97	13.13

ANTENNA POLARITY & TEST DISTANCE: VERTICAL AT 3 M

NO.	FREQ. (MHz)	EMISSION LEVEL (dBuV/m)	LIMIT (dBuV/m)	MARGIN (dB)	ANTENNA HEIGHT (m)	TABLE ANGLE (Degree)	RAW VALUE (dBuV)	CORRECTION FACTOR (dB/m)
1	*2480.00	95.9 PK			1.67 V	90	97.96	-2.06
2	*2480.00	92.1 AV			1.67 V	90	94.16	-2.06
3	2483.50	45.8 PK	74.0	-28.2	1.67 V	90	47.83	-2.03
4	2483.50	34.5 AV	54.0	-19.5	1.67 V	90	36.53	-2.03
5	4960.00	48.2 PK	74.0	-25.8	1.03 V	185	41.94	6.26
6	4960.00	18.3 AV	54.0	-35.7	1.03 V	185	12.04	6.26
7	7440.00	53.5 PK	74.0	-20.5	1.15 V	12	40.37	13.13
8	7440.00	23.1 AV	54.0	-30.9	1.15 V	12	9.97	13.13

REMARKS:

1. Emission Level(dBuV/m) = Raw Value(dBuV) + Correction Factor(dB/m)
2. Correction Factor(dB/m) = Antenna Factor(dB/m) + Cable Factor(dB) – Pre-Amplifier Factor(dB)
3. The other emission levels were very low against the limit.
4. Margin value = Emission Level – Limit value
5. " * " : Fundamental frequency.



A D T

5.6.8 TEST RESULTS(MODE 2)

BELOW 1GHz WORST-CASE DATA

BT_LE-GFSK

CHANNEL	TX Channel 19	DETECTOR FUNCTION	Quasi-Peak (QP)
FREQUENCY RANGE	30MHz ~ 1GHz		

ANTENNA POLARITY & TEST DISTANCE: HORIZONTAL AT 3 M								
NO.	FREQ. (MHz)	EMISSION LEVEL (dBuV/m)	LIMIT (dBuV/m)	MARGIN (dB)	ANTENNA HEIGHT (m)	TABLE ANGLE (Degree)	RAW VALUE (dBuV)	CORRECTION FACTOR (dB/m)
1	89.41	33.4 QP	43.5	-10.1	2.00 H	100	52.52	-19.12
2	165.99	29.7 QP	43.5	-13.8	1.50 H	38	43.21	-13.49
3	255.09	37.9 QP	46.0	-8.1	1.50 H	98	52.02	-14.12
4	328.42	35.5 QP	46.0	-10.6	1.00 H	360	46.94	-11.49
5	666.50	33.9 QP	46.0	-12.1	1.00 H	123	37.89	-3.99
6	945.83	33.7 QP	46.0	-12.3	1.50 H	310	32.76	0.96

ANTENNA POLARITY & TEST DISTANCE: VERTICAL AT 3 M								
NO.	FREQ. (MHz)	EMISSION LEVEL (dBuV/m)	LIMIT (dBuV/m)	MARGIN (dB)	ANTENNA HEIGHT (m)	TABLE ANGLE (Degree)	RAW VALUE (dBuV)	CORRECTION FACTOR (dB/m)
1	31.50	32.7 QP	40.0	-7.3	1.50 V	360	47.22	-14.52
2	87.04	32.7 QP	40.0	-7.3	1.00 V	51	51.74	-19.05
3	166.01	31.9 QP	43.5	-11.6	1.00 V	270	45.39	-13.49
4	331.38	33.9 QP	46.0	-12.1	1.50 V	157	45.37	-11.45
5	666.51	33.9 QP	46.0	-12.1	2.00 V	267	37.89	-3.99
6	940.59	31.3 QP	46.0	-14.7	1.00 V	76	30.47	0.85

REMARKS:

1. Emission Level(dBuV/m) = Raw Value(dBuV) + Correction Factor(dB/m)
2. Correction Factor(dB/m) = Antenna Factor(dB/m) + Cable Factor(dB) – Pre-Amplifier Factor(dB)
3. The other emission levels were very low against the limit.
4. Margin value = Emission Level – Limit value



A D T

ABOVE 1GHz DATA

BT_LE-GFSK

CHANNEL	TX Channel 0	DETECTOR FUNCTION	Peak (PK)
FREQUENCY RANGE	1GHz ~ 25GHz		

ANTENNA POLARITY & TEST DISTANCE: HORIZONTAL AT 3 M

NO.	FREQ. (MHz)	EMISSION LEVEL (dBuV/m)	LIMIT (dBuV/m)	MARGIN (dB)	ANTENNA HEIGHT (m)	TABLE ANGLE (Degree)	RAW VALUE (dBuV)	CORRECTION FACTOR (dB/m)
1	2390.00	45.8 PK	74.0	-28.2	1.34 H	115	48.27	-2.47
2	2390.00	34.2 AV	54.0	-19.8	1.34 H	115	36.67	-2.47
3	*2402.00	97.8 PK			1.34 H	115	100.21	-2.41
4	*2402.00	94.4 AV			1.34 H	115	96.81	-2.41
5	4804.00	46.4 PK	74.0	-27.6	1.02 H	214	40.78	5.62
6	4804.00	36.3 AV	54.0	-17.7	1.02 H	214	30.68	5.62

ANTENNA POLARITY & TEST DISTANCE: VERTICAL AT 3 M

NO.	FREQ. (MHz)	EMISSION LEVEL (dBuV/m)	LIMIT (dBuV/m)	MARGIN (dB)	ANTENNA HEIGHT (m)	TABLE ANGLE (Degree)	RAW VALUE (dBuV)	CORRECTION FACTOR (dB/m)
1	2390.00	46.2 PK	74.0	-27.8	1.55 V	259	48.67	-2.47
2	2390.00	35.0 AV	54.0	-19.0	1.55 V	259	37.47	-2.47
3	*2402.00	100.9 PK			1.55 V	259	103.31	-2.41
4	*2402.00	98.2 AV			1.55 V	259	100.61	-2.41
5	4804.00	47.1 PK	74.0	-26.9	1.48 V	94	41.48	5.62
6	4804.00	36.7 AV	54.0	-17.3	1.48 V	94	31.08	5.62

REMARKS:

1. Emission Level(dBuV/m) = Raw Value(dBuV) + Correction Factor(dB/m)
2. Correction Factor(dB/m) = Antenna Factor(dB/m) + Cable Factor(dB) – Pre-Amplifier Factor(dB)
3. The other emission levels were very low against the limit.
4. Margin value = Emission Level – Limit value
5. " * ": Fundamental frequency.



A D T

CHANNEL	TX Channel 19	DETECTOR FUNCTION	Peak (PK)
FREQUENCY RANGE	1GHz ~ 25GHz		

ANTENNA POLARITY & TEST DISTANCE: HORIZONTAL AT 3 M

NO.	FREQ. (MHz)	EMISSION LEVEL (dBuV/m)	LIMIT (dBuV/m)	MARGIN (dB)	ANTENNA HEIGHT (m)	TABLE ANGLE (Degree)	RAW VALUE (dBuV)	CORRECTION FACTOR (dB/m)
1	*2440.00	98.5 PK			1.34 H	115	100.74	-2.24
2	*2440.00	95.2 AV			1.34 H	115	97.44	-2.24
3	4880.00	46.7 PK	74.0	-27.3	1.03 H	210	40.76	5.94
4	4880.00	36.6 AV	54.0	-17.4	1.03 H	210	30.66	5.94
5	7320.00	55.0 PK	74.0	-19.0	1.02 H	138	41.81	13.19
6	7320.00	43.1 AV	54.0	-10.9	1.02 H	138	29.91	13.19

ANTENNA POLARITY & TEST DISTANCE: VERTICAL AT 3 M

NO.	FREQ. (MHz)	EMISSION LEVEL (dBuV/m)	LIMIT (dBuV/m)	MARGIN (dB)	ANTENNA HEIGHT (m)	TABLE ANGLE (Degree)	RAW VALUE (dBuV)	CORRECTION FACTOR (dB/m)
1	*2440.00	102.3 PK			1.00 V	265	104.54	-2.24
2	*2440.00	100.1 AV			1.00 V	265	102.34	-2.24
3	4880.00	46.8 PK	74.0	-27.2	1.53 V	86	40.86	5.94
4	4880.00	36.3 AV	54.0	-17.7	1.53 V	86	30.36	5.94
5	7320.00	54.7 PK	74.0	-19.3	1.05 V	234	41.51	13.19
6	7320.00	43.2 AV	54.0	-10.8	1.05 V	234	30.01	13.19

REMARKS:

1. Emission Level(dBuV/m) = Raw Value(dBuV) + Correction Factor(dB/m)
2. Correction Factor(dB/m) = Antenna Factor(dB/m) + Cable Factor(dB) – Pre-Amplifier Factor(dB)
3. The other emission levels were very low against the limit.
4. Margin value = Emission Level – Limit value
5. " * ": Fundamental frequency.



A D T

CHANNEL	TX Channel 39	DETECTOR FUNCTION	Peak (PK)
FREQUENCY RANGE	1GHz ~ 25GHz		

ANTENNA POLARITY & TEST DISTANCE: HORIZONTAL AT 3 M

NO.	FREQ. (MHz)	EMISSION LEVEL (dBuV/m)	LIMIT (dBuV/m)	MARGIN (dB)	ANTENNA HEIGHT (m)	TABLE ANGLE (Degree)	RAW VALUE (dBuV)	CORRECTION FACTOR (dB/m)
1	*2480.00	99.2 PK			1.29 H	115	101.26	-2.06
2	*2480.00	96.0 AV			1.29 H	115	98.06	-2.06
3	2483.50	48.1 PK	74.0	-25.9	1.29 H	115	50.13	-2.03
4	2483.50	35.0 AV	54.0	-19.0	1.29 H	115	37.03	-2.03
5	4960.00	46.4 PK	74.0	-27.6	1.00 H	221	40.14	6.26
6	4960.00	36.3 AV	54.0	-17.7	1.00 H	221	30.04	6.26
7	7440.00	54.4 PK	74.0	-19.6	1.00 H	149	41.27	13.13
8	7440.00	42.6 AV	54.0	-11.4	1.00 H	149	29.47	13.13

ANTENNA POLARITY & TEST DISTANCE: VERTICAL AT 3 M

NO.	FREQ. (MHz)	EMISSION LEVEL (dBuV/m)	LIMIT (dBuV/m)	MARGIN (dB)	ANTENNA HEIGHT (m)	TABLE ANGLE (Degree)	RAW VALUE (dBuV)	CORRECTION FACTOR (dB/m)
1	*2480.00	102.2 PK			1.49 V	260	104.26	-2.06
2	*2480.00	99.9 AV			1.49 V	260	101.96	-2.06
3	2483.50	51.7 PK	74.0	-22.3	1.49 V	260	53.73	-2.03
4	2483.50	36.0 AV	54.0	-18.0	1.49 V	260	38.03	-2.03
5	4960.00	46.9 PK	74.0	-27.1	1.55 V	73	40.64	6.26
6	4960.00	36.5 AV	54.0	-17.5	1.55 V	73	30.24	6.26
7	7440.00	54.5 PK	74.0	-19.5	1.00 V	223	41.37	13.13
8	7440.00	42.8 AV	54.0	-11.2	1.00 V	223	29.67	13.13

REMARKS:

1. Emission Level(dBuV/m) = Raw Value(dBuV) + Correction Factor(dB/m)
2. Correction Factor(dB/m) = Antenna Factor(dB/m) + Cable Factor(dB) – Pre-Amplifier Factor(dB)
3. The other emission levels were very low against the limit.
4. Margin value = Emission Level – Limit value
5. " * " : Fundamental frequency.



A D T

5.7 AC POWER LINE CONDUCTED EMISSION MEASUREMENT

5.7.1 LIMITS OF AC POWER LINE CONDUCTED EMISSION MEASUREMENT

FREQUENCY OF EMISSION (MHz)	CONDUCTED LIMIT (dB μ V)	
	Quasi-peak	Average
0.15-0.5	66 to 56	56 to 46
0.5-5	56	46
5-30	60	50

- NOTE:**
1. The lower limit shall apply at the transition frequencies.
 2. The limit decreases in line with the logarithm of the frequency in the range of 0.15 to 0.50 MHz.

5.7.2 TEST INSTRUMENTS

DESCRIPTION & MANUFACTURER	MODEL NO.	SERIAL NO.	CALIBRATED DATE	CALIBRATED UNTIL
Test Receiver ROHDE & SCHWARZ	ESCS 30	100375	Apr. 29, 2014	Apr. 28, 2015
Line-Impedance Stabilization Network (for EUT) SCHWARZBECK	NSLK-8127	8127-522	Sep. 15, 2014	Sep. 14, 2015
Line-Impedance Stabilization Network (for Peripheral) ROHDE & SCHWARZ	ENV216	100071	Nov. 13, 2013	Nov. 12, 2014
RF Cable (JYEBAO)	5DFB	COCCAB-001	Mar. 10, 2014	Mar. 09, 2015
50 ohms Terminator	N/A	EMC-03	Sep. 22, 2014	Sep. 21, 2015
50 ohms Terminator	N/A	EMC-02	Oct. 01, 2013	Sep. 30, 2014
Software ADT	BV ADT_Cond_V7.3.7. 3	NA	NA	NA

Note:

1. The calibration interval of the above test instruments is 12 months and the calibrations are traceable to NML/ROC and NIST/USA.
2. The test was performed in Shielded Room No. C.
3. The VCCI Con C Registration No. is C-3611.
4. Tested Date: Sep. 24, 2014

5.7.3 TEST PROCEDURES

- a. The EUT was placed 0.4 meters from the conducting wall of the shielded room with EUT being connected to the power mains through a line impedance stabilization network (LISN). Other support units were connected to the power mains through another LISN. The two LISNs provide 50 ohm/ 50uH of coupling impedance for the measuring instrument.
- b. Both lines of the power mains connected to the EUT were checked for maximum conducted interference.
- c. The frequency range from 150kHz to 30MHz was searched. Emission levels under (Limit - 20dB) were not recorded.

NOTE: The resolution bandwidth of test receiver is 9kHz for Quasi-peak detection (QP) & Average detection (AV).

5.7.4 DEVIATION FROM TEST STANDARD

No deviation

5.7.5 TEST SETUP

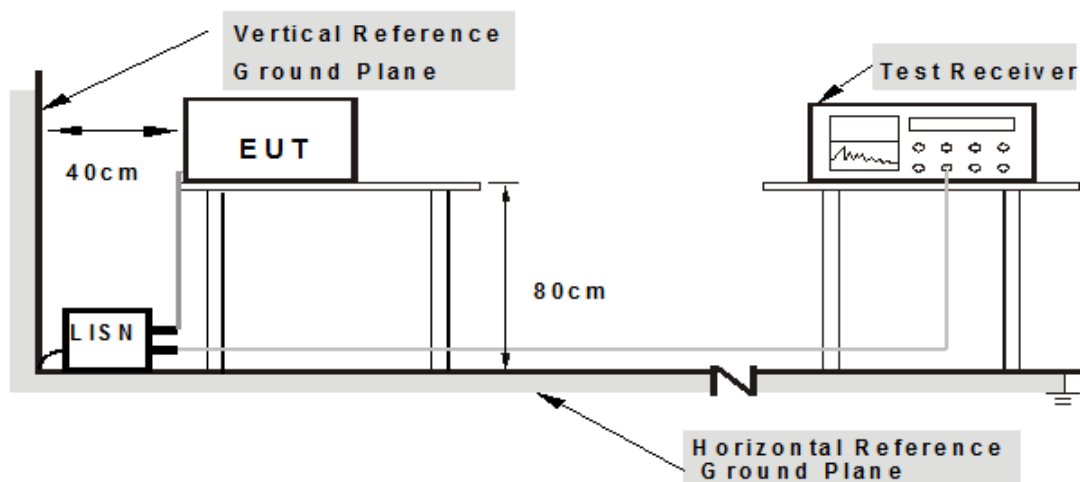

Note: 1. Support units were connected to second LISN.

For the actual test configuration, please refer to the related item – Photographs of the Test Configuration.

5.7.6 EUT OPERATING CONDITIONS

Same as Item 5.5.6

5.7.7 TEST RESULTS

PHASE	Line (L)	DETECTOR FUNCTION	Quasi-Peak (QP) / Average (AV)
-------	----------	-------------------	--------------------------------

No	Freq.	Corr.	Reading Value		Emission Level		Limit		Margin	
	[MHz]	Factor	[dB (uV)]		[dB (uV)]		[dB (uV)]		(dB)	
		(dB)	Q.P.	AV.	Q.P.	AV.	Q.P.	AV.	Q.P.	AV.
1	0.16953	0.07	41.19	28.11	41.26	28.18	64.98	54.98	-23.73	-26.81
2	0.20469	0.07	45.14	27.38	45.21	27.45	63.42	53.42	-18.21	-25.97
3	0.72603	0.11	30.39	20.98	30.50	21.09	56.00	46.00	-25.50	-24.91
4	2.82031	0.21	27.34	20.13	27.55	20.34	56.00	46.00	-28.45	-25.66
5	7.08203	0.36	26.18	18.50	26.54	18.86	60.00	50.00	-33.46	-31.14
6	21.12891	0.74	21.76	13.90	22.50	14.64	60.00	50.00	-37.50	-35.36

REMARKS:

1. Q.P. and AV. are abbreviations of quasi-peak and average individually.
2. The emission levels of other frequencies were very low against the limit.
3. Margin value = Emission Level – Limit value
4. Correction Factor = Insertion loss + Cable loss
5. Emission Level = Correction Factor + Reading Value

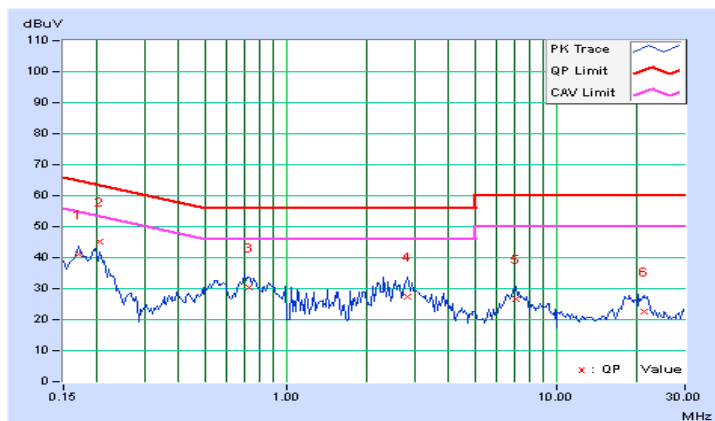



A D T

PHASE	Neutral (N)	DETECTOR FUNCTION	Quasi-Peak (QP) / Average (AV)
-------	-------------	-------------------	--------------------------------

No	Freq.	Corr.	Reading Value		Emission Level		Limit		Margin	
	[MHz]	Factor (dB)	[dB (uV)]		[dB (uV)]		[dB (uV)]		(dB)	
			Q.P.	AV.	Q.P.	AV.	Q.P.	AV.	Q.P.	AV.
1	0.15000	0.08	47.33	26.80	47.41	26.88	66.00	56.00	-18.59	-29.12
2	0.20078	0.07	47.60	21.07	47.67	21.14	63.58	53.58	-15.91	-32.44
3	0.68906	0.11	31.96	18.94	32.07	19.05	56.00	46.00	-23.93	-26.95
4	2.94141	0.22	29.60	20.56	29.82	20.78	56.00	46.00	-26.18	-25.22
5	6.95703	0.35	27.59	18.87	27.94	19.22	60.00	50.00	-32.06	-30.78
6	17.95313	0.65	24.96	17.57	25.61	18.22	60.00	50.00	-34.39	-31.78

REMARKS:

1. Q.P. and AV. are abbreviations of quasi-peak and average individually.
2. The emission levels of other frequencies were very low against the limit.
3. Margin value = Emission Level – Limit value
4. Correction Factor = Insertion loss + Cable loss
5. Emission Level = Correction Factor + Reading Value

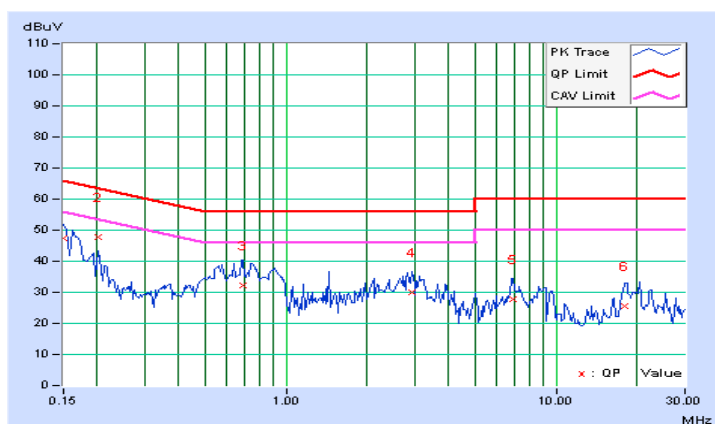



A D T

6 PHOTOGRAPHS OF THE TEST CONFIGURATION

Please refer to the attached file (Test Setup Photo).



7 INFORMATION ON THE TESTING LABORATORIES

We, Bureau Veritas Consumer Products Services (H.K.) Ltd., Taoyuan Branch, were founded in 1988 to provide our best service in EMC, Radio, Telecom and Safety consultation. Our laboratories are accredited and approved according to ISO/IEC 17025.

If you have any comments, please feel free to contact us at the following:

Linko EMC/RF Lab:

Tel: 886-2-26052180

Fax: 886-2-26052943

Hsin Chu EMC/RF Lab:

Tel: 886-3-5935343

Fax: 886-3-5935342

Hwa Ya EMC/RF/Safety/Telecom Lab:

Tel: 886-3-3183232

Fax: 886-3-3270892

Email: service.adt@tw.bureauveritas.com

Web Site: www.bureauveritas-adt.com

The address and road map of all our labs can be found in our web site also.

8 APPENDIX A - MODIFICATIONS RECORDERS FOR ENGINEERING CHANGES TO THE EUT BY THE LAB

No modifications were made to the EUT by the lab during the test.

--- END ---