

FCC ID: RFD-BLK2FLY
IC: 3177A-BLK2FLY
HVIN: 938405

880870_Slave_Radar-Board_BOTTOM

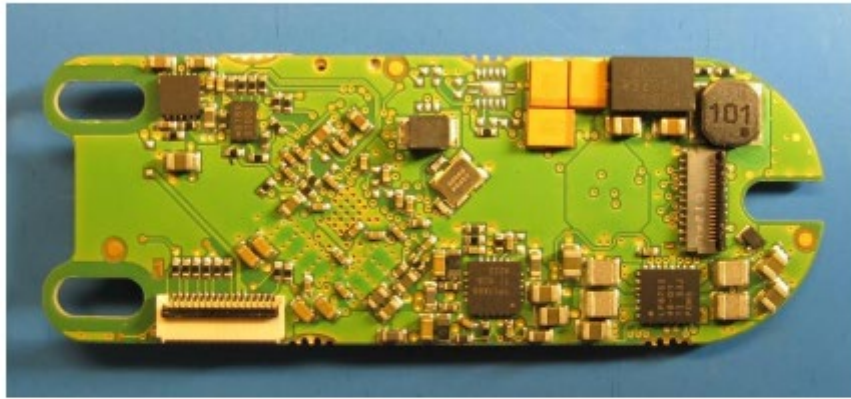

880870_Slave_Radar-Board_TOP

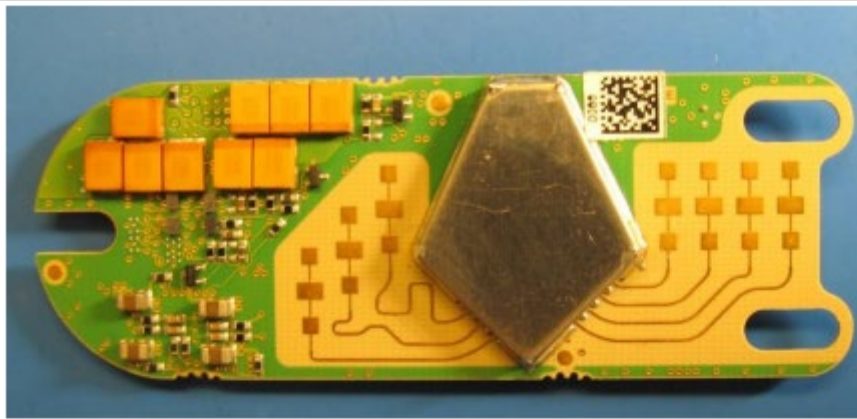

880870_Slave_Radar-Board_TOP without shielding plate

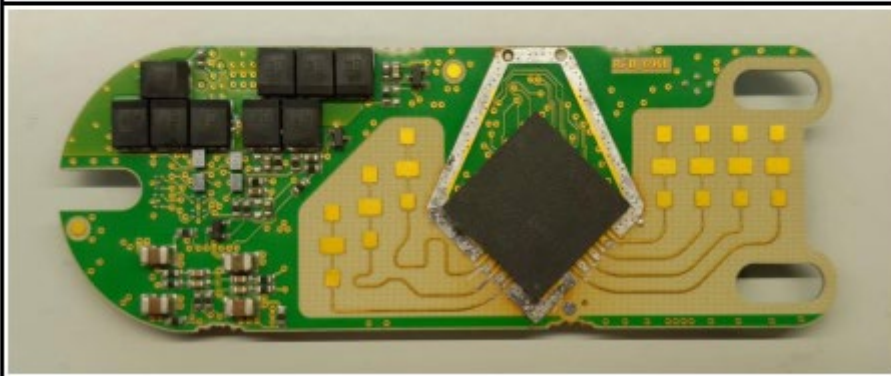

FCC ID: RFD-BLK2FLY
IC: 3177A-BLK2FLY
HVIN: 938405

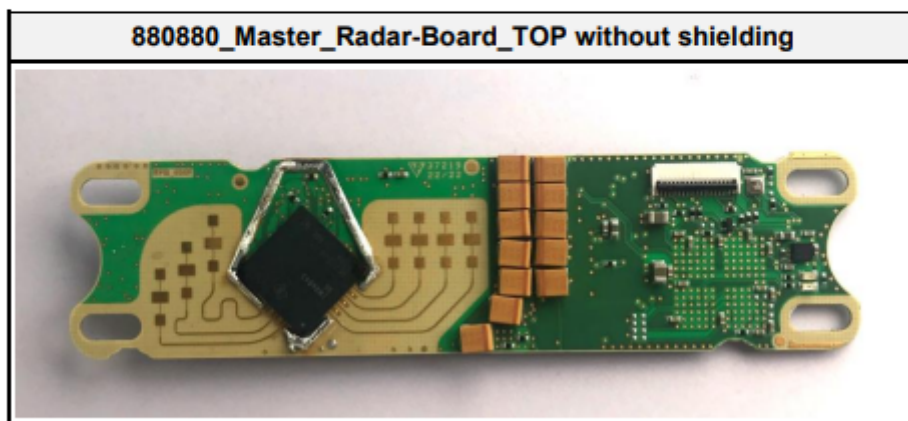
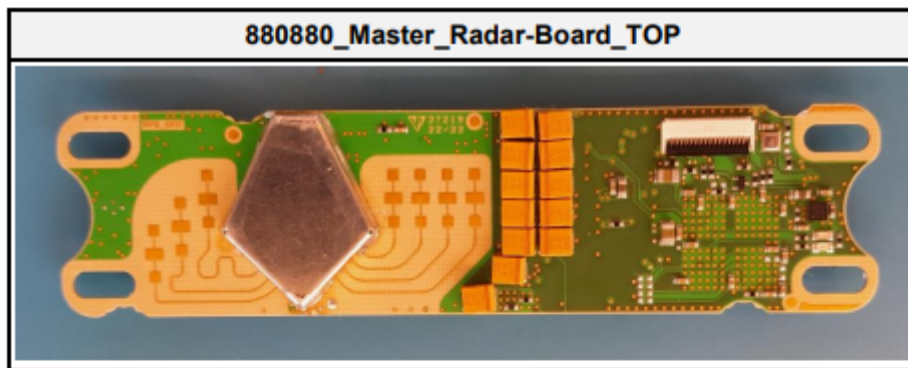
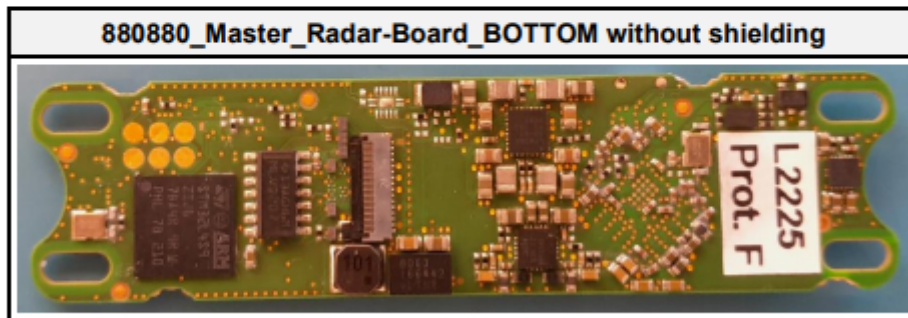
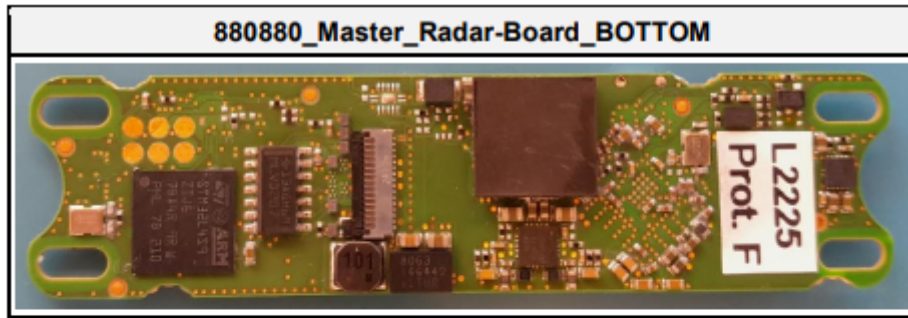

FCC ID: RFD-BLK2FLY
IC: 3177A-BLK2FLY
HVIN: 938405

881218_Supercap-Board-TOP

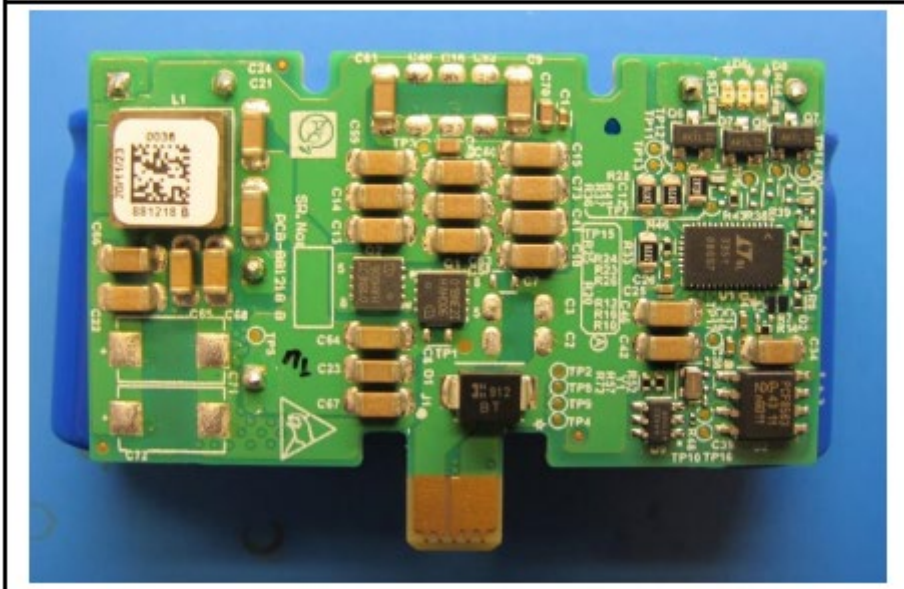

881218_Supercap-Board-BOTTOM

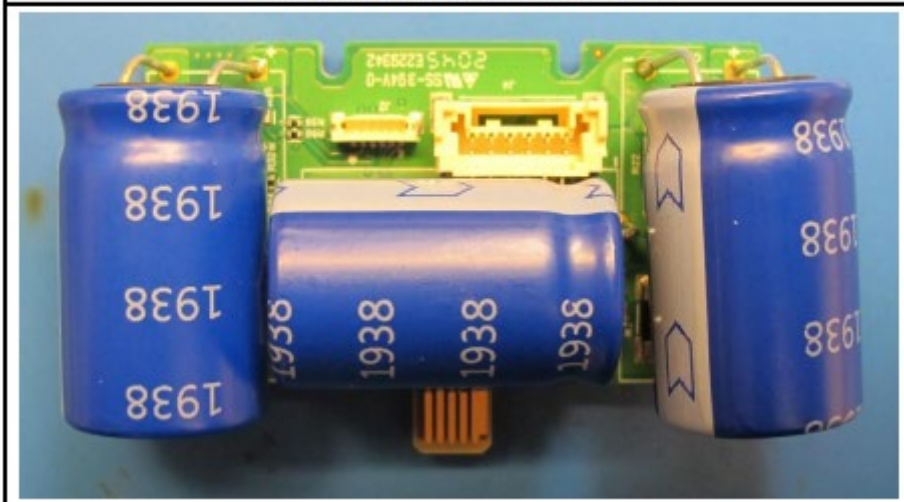

FCC ID: RFD-BLK2FLY
IC: 3177A-BLK2FLY
HVIN: 938405

891019_ESC-Board_BOTTOM

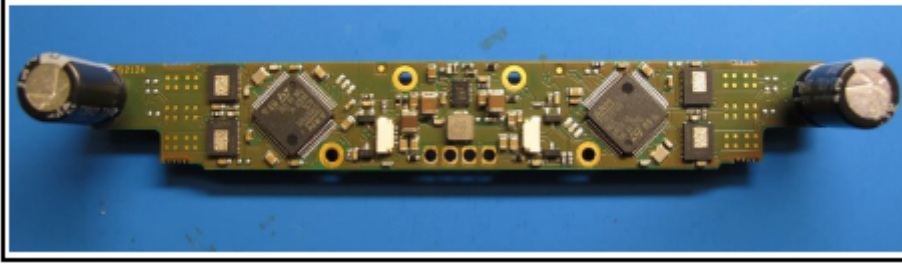

891019_ESC-Board_TOP



892583_mainboard_bottom

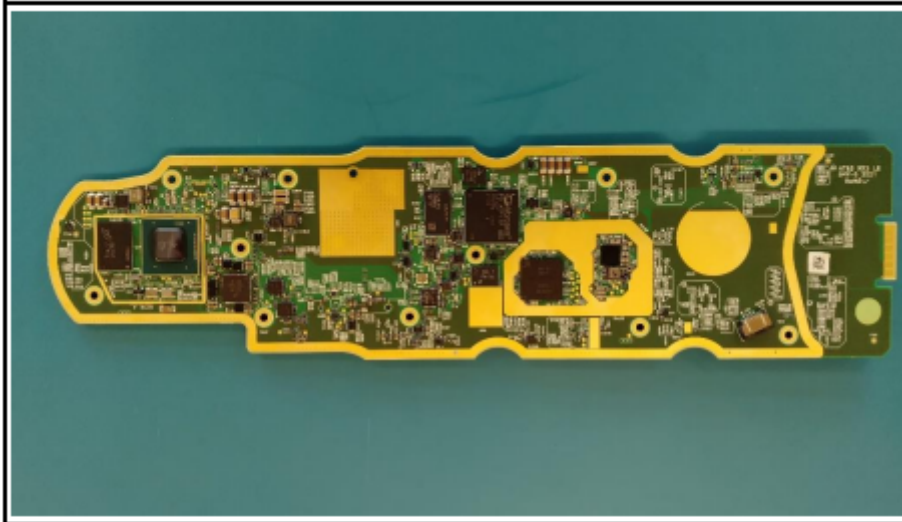

892583_mainboard_top

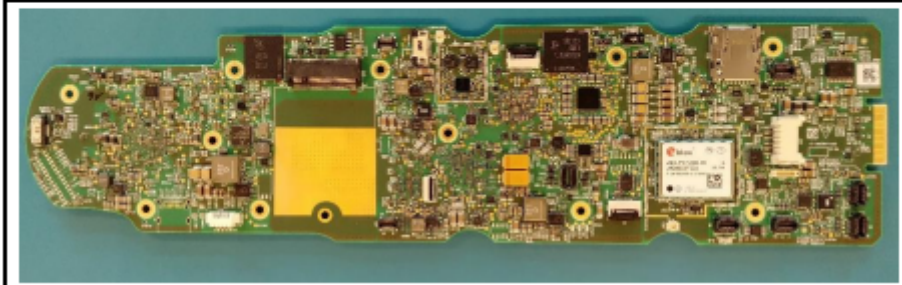

FCC ID: RFD-BLK2FLY
IC: 3177A-BLK2FLY
HVIN: 938405

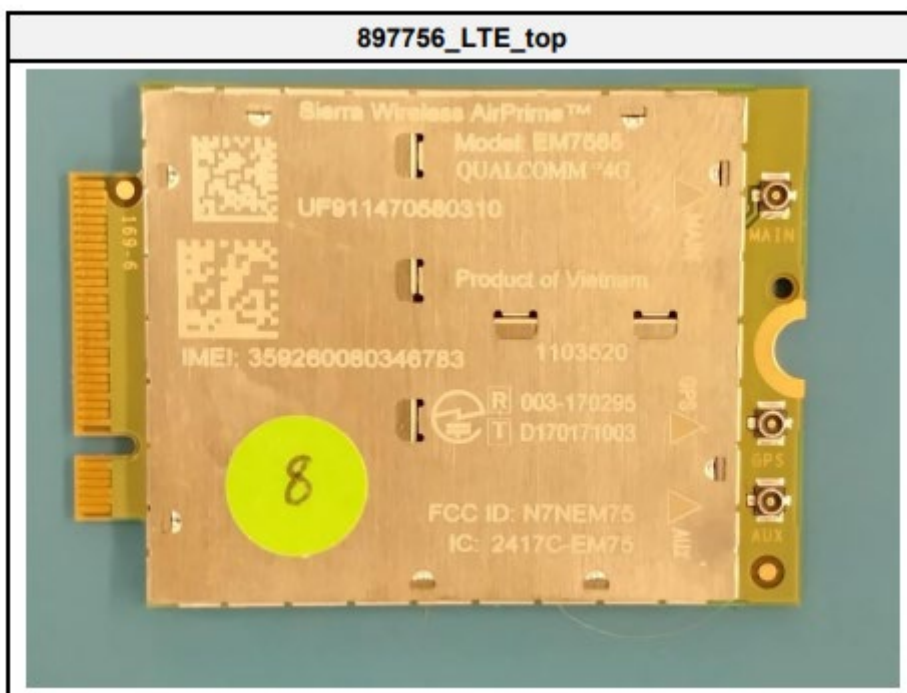
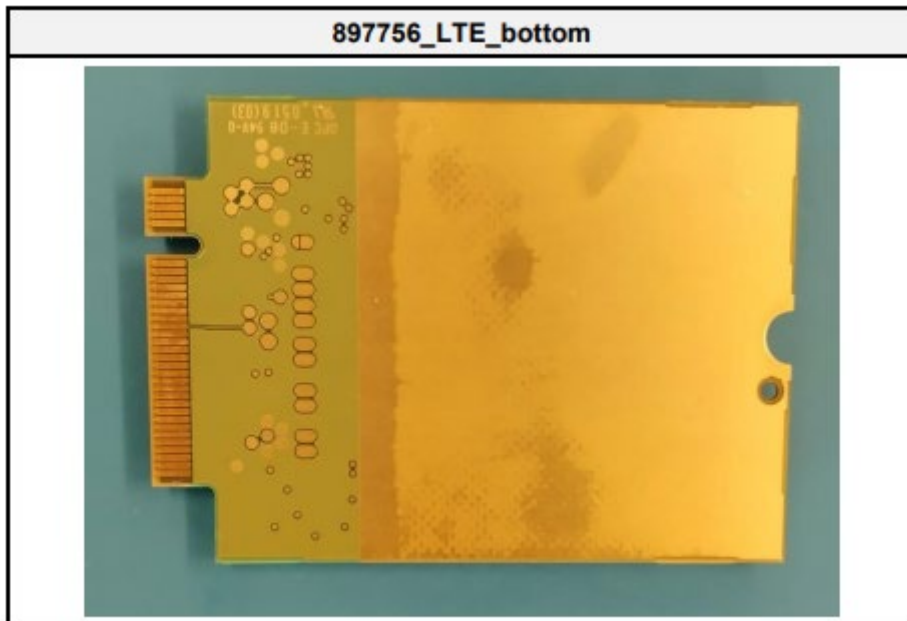

FCC ID: RFD-BLK2FLY
IC: 3177A-BLK2FLY
HVIN: 938405

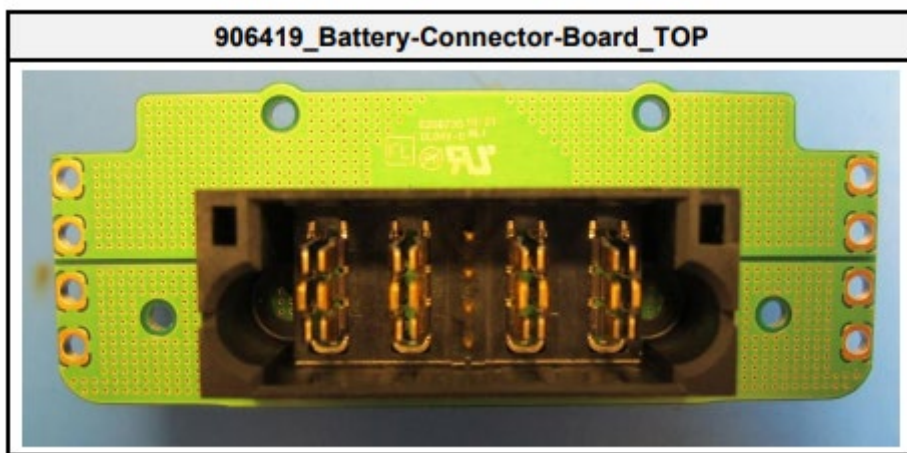
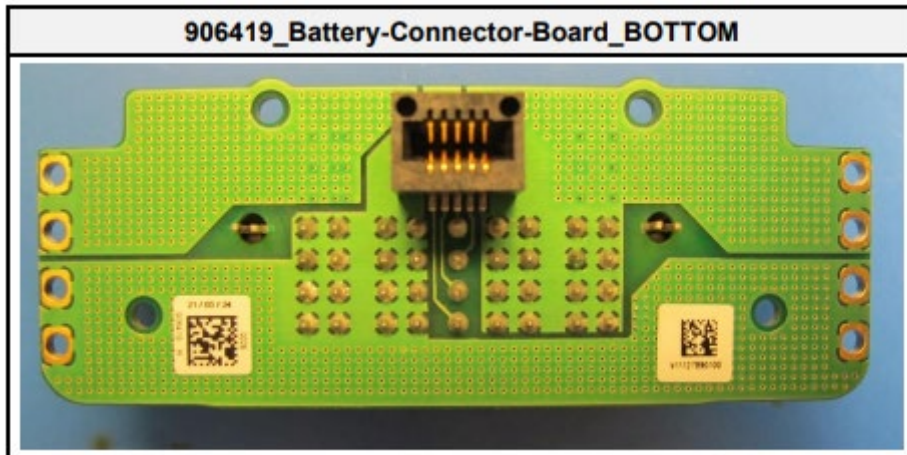

FCC ID: RFD-BLK2FLY
IC: 3177A-BLK2FLY
HVIN: 938405

922381_Camera-Board_Portrait_BOTTOM



922381_Camera-Board_Portrait_TOP

