



# FCC/IC RF Test Report

APPLICANT : Sierra Wireless Inc.  
EQUIPMENT : Radio Module  
BRAND NAME : AirPrime  
MODEL NAME : EM7565-9  
FCC ID : N7NEM75L  
IC : 2417C-EM75L  
STANDARD : 47 CFR Part 2, 24(E), 27  
IC RSS-130 issue 1  
IC RSS-133 issue 6  
IC RSS-199 issue 3  
CLASSIFICATION : PCS Licensed Transmitter (PCB)

This is a partial report, which the effective radiated power and equivalent isotropic radiated power testing are not included. The product was received on Sep. 19, 2017 and completely tested on Oct. 06, 2017. We, SPORTON INTERNATIONAL INC., would like to declare that the tested sample has been evaluated in accordance with the test procedures given in ANSI / TIA / EIA-603-E and the testing has shown the tested sample to be in compliance with the applicable technical standards.

The test results in this report apply exclusively to the tested model / sample. Without written approval of SPORTON INTERNATIONAL INC., the test report shall not be reproduced except in full.

Reviewed by: Joseph Lin / Supervisor

Approved by: Jones Tsai / Manager



## SPORTON INTERNATIONAL INC.

No. 52, Hwa Ya 1<sup>st</sup> Rd., Hwa Ya Technology Park, Kwei-Shan District, Tao Yuan City, Taiwan, R.O.C.



TABLE OF CONTENTS

REVISION HISTORY.....3
SUMMARY OF TEST RESULT .....4
1 GENERAL DESCRIPTION .....6
1.1 Applicant .....6
1.2 Manufacturer.....6
1.3 Product Feature of Equipment Under Test.....6
1.4 Modification of EUT .....6
1.5 Testing Location .....6
1.6 Applicable Standards.....7
2 TEST CONFIGURATION OF EQUIPMENT UNDER TEST .....8
2.1 Test Mode .....8
2.2 Connection Diagram of Test System.....12
2.3 Support Unit used in test configuration and system .....12
2.4 Measurement Results Explanation Example.....13
2.5 Frequency List of Low/Middle/High Channels .....14
3 CONDUCTED TEST ITEMS .....20
3.1 Measuring Instruments .....20
3.2 Test Setup .....20
3.3 Test Result of Conducted Test .....20
3.4 Conducted Output Power .....21
3.5 Peak-to-Average Ratio .....22
3.6 Occupied Bandwidth.....23
3.7 Conducted Band Edge .....24
3.8 Conducted Spurious Emission .....27
3.9 Frequency Stability .....28
4 RADIATED TEST ITEMS .....29
4.1 Measuring Instruments .....29
4.2 Test Setup .....29
4.3 Test Result of Radiated Test .....29
4.4 Radiated Spurious Emission .....30
5 LIST OF MEASURING EQUIPMENT .....32
6 UNCERTAINTY OF EVALUATION .....33
APPENDIX A. TEST RESULTS OF CONDUCTED TEST
APPENDIX B. TEST RESULTS OF RADIATED TEST





SUMMARY OF TEST RESULT

Report Section	FCC Rule	IC Rule	Description	Limit	Result	Remark
3.4	§2.1046	RSS-Gen(6.12) RSS-130(4.4) RSS-133 (6.4) RSS-199 (4.4)	Conducted Output Power	Reporting Only	PASS	-
3.5	§24.232(d)	RSS-130(4.4) RSS-133 (6.4)	Peak-to-Average Ratio	<13 dB	PASS	-
3.6	§2.1049	RSS-GEN(6.6) RSS-133 (3.1) RSS-130 (3.1) RSS-199 (4.2)	Occupied Bandwidth	Reporting Only	PASS	-
3.7	§2.1051 §24.238(a) §27.53(c)(2)(4) §27.53(g)	RSS-133 (6.5.1) RSS-130(4.6)	Conducted Band Edge Measurement (Band 2) (Band 12) (Band 13) (Band 26) (Band 66)	< 43+10log10(P[Watts])	PASS	-
	§27.53(m)(4)	RSS-199 (4.5)	Conducted Band Edge Measurement (Band 7) (Band 41)	§27.53(m)(4) RSS-199 (4.5)		



Report Section	FCC Rule	IC Rule	Description	Limit	Result	Remark
3.8	§2.1051 §24.238(a) §27.53(c)(2) §27.53(g)	RSS-133 (6.5.1) RSS-130(4.6)	Conducted Spurious Emission (Band 2) (Band 12) (Band 13) (Band 26) (Band 66)	$< 43+10\log_{10}(P[\text{Watts}])$	PASS	-
	§2.1051 §27.53(m)(4)	RSS-199 (4.5)	Conducted Spurious Emission (Band 7) (Band 41)	$< 55+10\log_{10}(P[\text{Watts}])$		
3.9	§2.1055 §24.235 §27.54	RSS-GEN(6.11) RSS-133(6.3) RSS-130(4.3) RSS-199 (4.3)	Frequency Stability Temperature & Voltage	Within Authorized Band	PASS	-
4.4	§2.1053 §24.238(a) §27.53(c)(2) §27.53(f) §27.53(g)	RSS-133 (6.5.1) RSS-130(4.6)	Radiated Spurious Emission (Band 2) (Band 12) (Band 13) (Band 26) (Band 66)	$< 43+10\log_{10}(P[\text{Watts}])$	PASS	Under limit 3.10 dB at 7662.000 MHz
	§2.1053 §27.53(m)(4)	RSS-199 (4.5)	Radiated Spurious Emission (Band 7)(Band 41)	$< 55+10\log_{10}(P[\text{Watts}])$		



# 1 General Description

## 1.1 Applicant

Sierra Wireless Inc.  
13811 Wireless Way Richmond, BC Canada V6V 3A4

## 1.2 Manufacturer

Sierra Wireless Inc.  
13811 Wireless Way Richmond, BC Canada V6V 3A4

## 1.3 Product Feature of Equipment Under Test

WCDMA/LTE

## 1.4 Modification of EUT

No modifications are made to the EUT during all test items.

## 1.5 Testing Location

Sporton Lab is accredited to ISO 17025 by Taiwan Accreditation Foundation (TAF code : 1190) and the FCC designation No. TW1190 under the FCC 2.948(e) by Mutual Recognition Agreement (MRA) in FCC Test.

<b>Test Site</b>	SPORTON INTERNATIONAL INC.		
<b>Test Site Location</b>	No. 52, Hwa Ya 1 <sup>st</sup> Rd., Hwa Ya Technology Park, Kwei-Shan District, Tao Yuan City, Taiwan, R.O.C. TEL: +886-3-327-3456 FAX: +886-3-328-4978		
<b>Test Site No.</b>	<b>Sporton Site No.</b>		<b>IC Registration No.</b>
	TH05-HY	03CH07-HY	4086B-5



## 1.6 Applicable Standards

According to the specifications of the manufacturer, the EUT must comply with the requirements of the following standards:

- ♦ 47 CFR Part 2, 24(E), 27
- ♦ ANSI / TIA / EIA-603-E
- ♦ FCC KDB 971168 D01 Power Meas. License Digital Systems v02r02
- ♦ ANSI C63.26-2015
- ♦ IC RSS-130 Issue 1
- ♦ IC RSS-133 Issue 6
- ♦ IC RSS-199 Issue 3
- ♦ IC RSS-Gen Issue 4

**Remark:** All test items were verified and recorded according to the standards and without any deviation during the test.



## 2 Test Configuration of Equipment Under Test

### 2.1 Test Mode

Antenna port conducted and radiated test items listed below are performed according to KDB 971168 D01 Power Meas. License Digital Systems v02r02 with maximum output power.

Test Items	Band	Bandwidth (MHz)						Modulation			RB #			Test Channel		
		1.4	3	5	10	15	20	QPSK	16QAM	64QAM	1	Half	Full	L	M	H
Max. Output Power	2	Y	Y	Y	Y	Y	Y	Y	Y	Y	Y	Y	Y	Y	Y	Y
	7	-	-	Y	Y	Y	Y	Y	Y	Y	Y	Y	Y	Y	Y	Y
	12	Y	Y	Y	Y	-	-	Y	Y	Y	Y	Y	Y	Y	Y	Y
	13	-	-	Y	Y	-	-	Y	Y	Y	Y	Y	Y	Y	Y	Y
	26	Y	Y	Y	Y	Y	-	Y	Y	Y	Y	Y	Y	Y	Y	Y
	41	-	-	Y	Y	Y	Y	Y	Y	Y	Y	Y	Y	Y	Y	Y
	66	Y	Y	Y	Y	Y	Y	Y	Y	Y	Y	Y	Y	Y	Y	Y
Peak-to-Average Ratio	2						Y	Y	Y	Y	Y		Y	Y	Y	Y
	7	-	-				Y	Y	Y	Y	Y		Y	Y	Y	Y
	12				Y	-	-	Y	Y	Y	Y		Y	Y	Y	Y
	13	-	-		Y	-	-	Y	Y	Y	Y		Y	Y	Y	Y
	26					Y	-	Y	Y	Y	Y		Y	Y	Y	Y
	41	-	-				Y	Y	Y	Y	Y		Y	Y	Y	Y
	66						Y	Y	Y	Y	Y		Y	Y	Y	Y
26dB and 99% Bandwidth	2	Y	Y	Y	Y	Y	Y	Y	Y	Y			Y	Y	Y	Y
	7	-	-	Y	Y	Y	Y	Y	Y	Y			Y	Y	Y	Y
	12	Y	Y	Y	Y	-	-	Y	Y	Y			Y	Y	Y	Y
	13	-	-	Y	Y	-	-	Y	Y	Y			Y	Y	Y	Y
	26	Y	Y	Y	Y	Y	-	Y	Y	Y			Y	Y	Y	Y
	41	-	-	Y	Y	Y	Y	Y	Y	Y			Y	Y	Y	Y
	66	Y	Y	Y	Y	Y	Y	Y	Y	Y			Y	Y	Y	Y





Test Items	Band	Bandwidth (MHz)						Modulation			RB #			Test Channel		
		1.4	3	5	10	15	20	QPSK	16QAM	64QAM	1	Half	Full	L	M	H
Conducted Band Edge	2	✓	✓	✓	✓	✓	✓	✓	✓	✓	✓		✓	✓		✓
	7	-	-	✓	✓	✓	✓	✓	✓	✓	✓		✓	✓		✓
	12	✓	✓	✓	✓	-	-	✓	✓	✓	✓		✓	✓		✓
	13	-	-	✓	✓	-	-	✓	✓	✓	✓		✓	✓		✓
	26	✓	✓	✓	✓	✓	-	✓	✓	✓	✓		✓	✓		✓
	41	-	-	✓	✓	✓	✓	✓	✓	✓	✓		✓	✓		✓
	66	✓	✓	✓	✓	✓	✓	✓	✓	✓	✓		✓	✓		✓
Conducted Spurious Emission	2	✓	✓	✓	✓	✓	✓	✓	✓	✓	✓			✓	✓	✓
	7	-	-	✓	✓	✓	✓	✓	✓	✓	✓			✓	✓	✓
	12	✓	✓	✓	✓	-	-	✓	✓	✓	✓			✓	✓	✓
	13	-	-	✓	✓	-	-	✓	✓	✓	✓			✓	✓	✓
	26	✓	✓	✓	✓	✓	-	✓	✓	✓	✓			✓	✓	✓
	41	-	-	✓	✓	✓	✓	✓	✓	✓	✓			✓	✓	✓
	66	✓	✓	✓	✓	✓	✓	✓	✓	✓	✓			✓	✓	✓
Frequency Stability	2				✓			✓					✓		✓	
	7	-	-	✓	✓			✓					✓		✓	
	12			✓	✓	-	-	✓					✓		✓	
	13	-	-	✓	✓	-	-	✓					✓		✓	
	26				✓		-	✓					✓		✓	
	41	-	-	✓	✓			✓					✓		✓	
	66				✓			✓					✓		✓	



Test Items	Band	Bandwidth (MHz)						Modulation			RB #			Test Channel		
		1.4	3	5	10	15	20	QPSK	16QAM	64QAM	1	Half	Full	L	M	H
Radiated Spurious Emission	2	√	√	√	√	√	√	√			√			√	√	√
	7	-	-	√	√	√	√	√			√			√	√	√
	12	√	√	√	√	-	-	√			√			√	√	√
	13	-	-	√	√	-	-	√			√			√	√	√
	26	√	√	√	√	√	-	√			√			√	√	√
	41	-	-	√	√	√	√	√			√			√	√	√
	66	√	√	√	√	√	√	√			√			√	√	√
Note	<ol style="list-style-type: none"> <li>The mark "√" means that this configuration is chosen for testing</li> <li>The mark "-" means that this bandwidth is not supported.</li> <li>The device is investigated from 30MHz to 10 times of fundamental signal for radiated spurious emission test under different RB size/offset and modulations in exploratory test. Subsequently, only the worst case emissions are reported.</li> </ol>															



Test Items	Band	Bandwidth (MHz)								Modulation			RB #			Test Channel		
		10+20	20+10	15+15	15+20	20+15	20+20	5+20	20+5	QPSK	16QAM	64QAM	1	Half	Full	L	M	H
Max. Output Power	7_CA	✓	✓	✓	✓	✓	✓	-	-	✓	✓	✓	✓	✓	✓	✓	✓	✓
	41_CA	✓	✓	✓	✓	✓	✓	✓	✓	✓	✓	✓	✓	✓	✓	✓	✓	✓
26dB and 99% Bandwidth	7_CA	✓	✓	✓	✓	✓	✓	-	-	✓	✓	✓			✓	✓	✓	✓
	41_CA	✓	✓	✓	✓	✓	✓	✓	✓	✓	✓	✓			✓	✓	✓	✓
Conducted Band Edge	7_CA	✓	✓	✓	✓	✓	✓	-	-	✓	✓	✓	✓		✓	✓		✓
	41_CA	✓	✓	✓	✓	✓	✓	✓	✓	✓	✓	✓	✓		✓	✓		✓
Conducted Spurious Emission	7_CA	✓	✓	✓	✓	✓	✓	-	-	✓	✓	✓	✓			✓	✓	✓
	41_CA	✓	✓	✓	✓	✓	✓	✓	✓	✓	✓	✓	✓			✓	✓	✓
Radiated Spurious Emission	7_CA	✓	✓	✓	✓	✓	✓	-	-	✓			✓			✓	✓	✓
	41_CA	✓	✓	✓	✓	✓	✓	✓	✓	✓			✓			✓	✓	✓
Note	<ol style="list-style-type: none"> <li>The mark "✓" means that this configuration is chosen for testing</li> <li>The mark "-" means that this bandwidth is not supported.</li> <li>The device is investigated from 30MHz to 10 times of fundamental signal for radiated spurious emission test under different RB size/offset and modulations in exploratory test. Subsequently, only the worst case emissions are reported.</li> </ol>																	

## 2.2 Connection Diagram of Test System

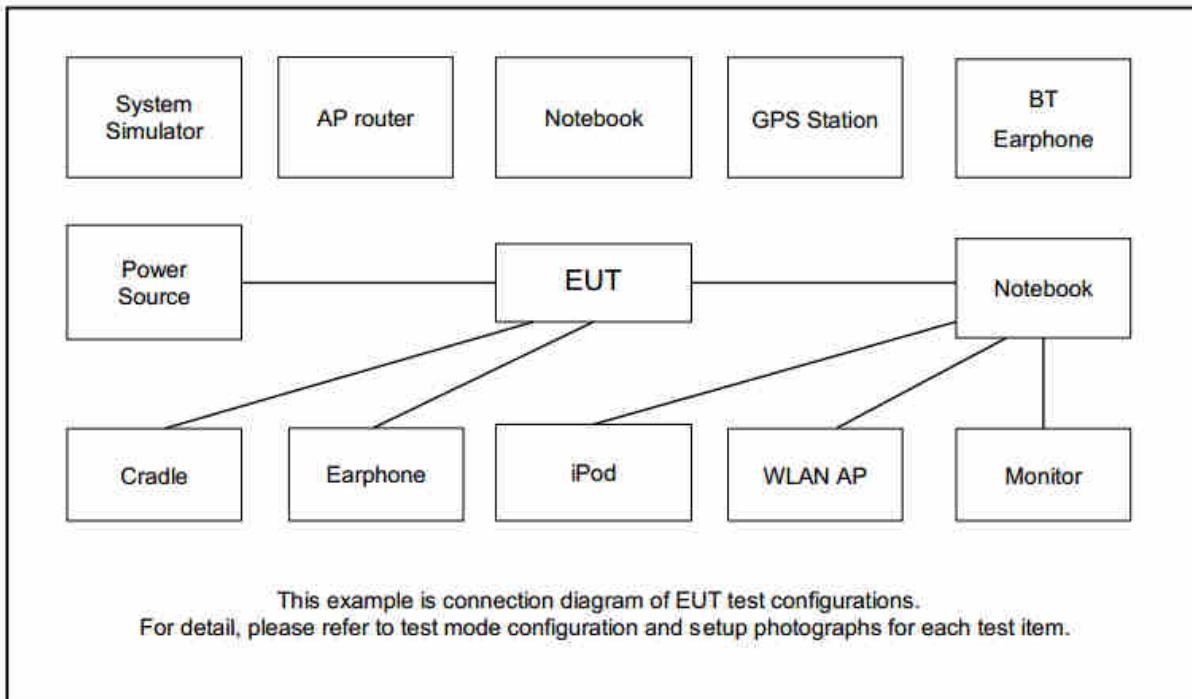

## 2.3 Support Unit used in test configuration and system

Item	Equipment	Trade Name	Model No.	FCC ID	Data Cable	Power Cord
1.	System Simulator	R&S	CMU 200	N/A	N/A	Unshielded, 1.8 m
2.	System Simulator	Anritsu	MT8820C	N/A	N/A	Unshielded, 1.8 m



## 2.4 Measurement Results Explanation Example

For all conducted test items:

The offset level is set in the spectrum analyzer to compensate the RF cable loss and attenuator factor between EUT conducted output port and spectrum analyzer. With the offset compensation, the spectrum analyzer reading level is exactly the EUT RF output level.

The spectrum analyzer offset is derived from RF cable loss and attenuator factor.

*Offset = RF cable loss + attenuator factor.*

Following shows an offset computation example with cable loss 4.2 dB and 10dB attenuator.

Example :

$$\begin{aligned} \text{Offset(dB)} &= \text{RF cable loss(dB)} + \text{attenuator factor(dB)}. \\ &= 4.2 + 10 = 14.2 \text{ (dB)} \end{aligned}$$



### 2.5 Frequency List of Low/Middle/High Channels

LTE Band 2 Channel and Frequency List				
BW [MHz]	Channel/Frequency(MHz)	Lowest	Middle	Highest
20	Channel	18700	18900	19100
	Frequency	1860	1880	1900
15	Channel	18675	18900	19125
	Frequency	1857.5	1880	1902.5
10	Channel	18650	18900	19150
	Frequency	1855	1880	1905
5	Channel	18625	18900	19175
	Frequency	1852.5	1880	1907.5
3	Channel	18615	18900	19185
	Frequency	1851.5	1880	1908.5
1.4	Channel	18607	18900	19193
	Frequency	1850.7	1880	1909.3

LTE Band 7 Channel and Frequency List				
BW [MHz]	Channel/Frequency(MHz)	Lowest	Middle	Highest
20	Channel	20850	21100	21350
	Frequency	2510	2535	2560
15	Channel	20825	21100	21375
	Frequency	2507.5	2535	2562.5
10	Channel	20800	21100	21400
	Frequency	2505	2535	2565
5	Channel	20775	21100	21425
	Frequency	2502.5	2535	2567.5



LTE Band 12 Channel and Frequency List				
BW [MHz]	Channel/Frequency(MHz)	Lowest	Middle	Highest
10	Channel	23060	23095	23130
	Frequency	704	707.5	711
5	Channel	23035	23095	23155
	Frequency	701.5	707.5	713.5
3	Channel	23025	23095	23165
	Frequency	700.5	707.5	714.5
1.4	Channel	23017	23095	23173
	Frequency	699.7	707.5	715.3

LTE Band 13 Channel and Frequency List				
BW [MHz]	Channel/Frequency(MHz)	Lowest	Middle	Highest
10	Channel	-	23230	-
	Frequency	-	782	-
5	Channel	23205	23230	23255
	Frequency	779.5	782	784.5

LTE Band 26 Channel and Frequency List				
BW [MHz]	Channel/Frequency(MHz)	Lowest	Middle	Highest
15	Channel	26865	26915	26965
	Frequency	831.5	836.5	841.5
10	Channel	26840	26915	26990
	Frequency	829	836.5	844
5	Channel	26815	26915	27015
	Frequency	826.5	836.5	846.5
3	Channel	26805	26915	27025
	Frequency	825.5	836.5	847.5
1.4	Channel	26797	26915	27033
	Frequency	824.7	836.5	848.3



LTE Band 41 Channel and Frequency List				
BW [MHz]	Channel/Frequency(MHz)	Lowest	Middle	Highest
20	Channel	39750	40620	41490
	Frequency	2506	2593	2680
15	Channel	39725	40620	41515
	Frequency	2503.5	2593	2682.5
10	Channel	39700	40620	41540
	Frequency	2501	2593	2685
5	Channel	39675	40620	41565
	Frequency	2498.5	2593	2687.5

LTE Band 41 Channel and Frequency List for IC				
BW [MHz]	Channel/Frequency(MHz)	Lowest	Middle	Highest
20	Channel	39790	40620	41490
	Frequency	2510	2593	2680
15	Channel	39765	40620	41515
	Frequency	2507.5	2593	2682.5
10	Channel	39740	40620	41540
	Frequency	2505	2593	2685
5	Channel	39715	40620	41565
	Frequency	2502.5	2593	2687.5





LTE Band 66 Channel and Frequency List				
BW [MHz]	Channel/Frequency(MHz)	Lowest	Middle	Highest
20	Channel	132072	132322	132572
	Frequency	1720	1745	1770
15	Channel	132047	132322	132597
	Frequency	1717.5	1745	1772.5
10	Channel	132022	132322	132622
	Frequency	1715	1745	1775
5	Channel	131997	132322	132647
	Frequency	1712.5	1745	1777.5
3	Channel	131987	132322	132657
	Frequency	1711.5	1745	1778.5
1.4	Channel	131979	132322	132665
	Frequency	1710.7	1745	1779.3



LTE Band 7 Channel and Frequency List					
BW [MHz]	Channel/Frequency(MHz)		Lowest	Middle	Highest
20 + 20	PCC	Channel	20850	21001	21152
		Frequency	2510.0	2525.1	2540.2
	SCC	Channel	21048	21199	21350
		Frequency	2529.8	2544.9	2560.0
20 + 15	PCC	Channel	20850	21026	21201
		Frequency	2510.0	2527.6	2545.1
	SCC	Channel	21021	21197	21372
		Frequency	2527.1	2544.7	2562.2
15 + 20	PCC	Channel	20828	21003	21179
		Frequency	2507.8	2525.3	2542.9
	SCC	Channel	20999	21174	21350
		Frequency	2524.9	2542.4	2560.0
20 + 10	PCC	Channel	20850	21051	21251
		Frequency	2510.0	2530.1	2550.1
	SCC	Channel	20994	21195	21395
		Frequency	2524.4	2544.5	2564.5
10 + 20	PCC	Channel	20805	21006	21206
		Frequency	2505.5	2525.6	2545.6
	SCC	Channel	20949	21150	21350
		Frequency	2519.9	2540.0	2560.0
15 + 15	PCC	Channel	20825	21025	21225
		Frequency	2507.5	2527.5	2547.5
	SCC	Channel	20975	21175	21375
		Frequency	2522.5	2542.5	2562.5



LTE Band 41 Channel and Frequency List					
BW [MHz]	Channel/Frequency(MHz)		Lowest	Middle	Highest
20 + 20	PCC	Channel	39750	40521	41292
		Frequency	2506	2583.1	2660.2
	SCC	Channel	39948	40719	41490
		Frequency	2525.8	2602.9	2680
20 + 15	PCC	Channel	39750	40546	41341
		Frequency	2506	2585.6	2665.1
	SCC	Channel	39921	40717	41512
		Frequency	2523.1	2602.7	2682.2
15 + 20	PCC	Channel	39728	40523	41319
		Frequency	2503.8	2583.3	2662.9
	SCC	Channel	39899	40694	41490
		Frequency	2520.9	2600.4	2680
20 + 10	PCC	Channel	39750	40571	41391
		Frequency	2506	2588.1	2670.1
	SCC	Channel	39894	40715	41535
		Frequency	2520.4	2602.5	2684.5
10 + 20	PCC	Channel	39705	40526	41346
		Frequency	2501.5	2583.6	2665.6
	SCC	Channel	39849	40670	41490
		Frequency	2515.9	2598	2680
15+ 15	PCC	Channel	39725	40545	41365
		Frequency	2503.5	2585.5	2667.5
	SCC	Channel	39875	40695	41515
		Frequency	2518.5	2600.5	2682.5
5 + 20	PCC	Channel	39683	40528	41373
		Frequency	2499.3	2583.8	2668.3
	SCC	Channel	39800	40645	41490
		Frequency	2511	2595.5	2680
20 + 5	PCC	Channel	39750	40595	41440
		Frequency	2506	2590.5	2675
	SCC	Channel	39867	40712	41557
		Frequency	2517.7	2602.2	2686.7

### 3 Conducted Test Items

#### 3.1 Measuring Instruments

See list of measuring instruments of this test report.

#### 3.2 Test Setup

##### 3.2.1 Conducted Output Power



##### 3.2.2 Peak-to-Average Ratio, Occupied Bandwidth ,Conducted Band-Edge and Conducted Spurious Emission

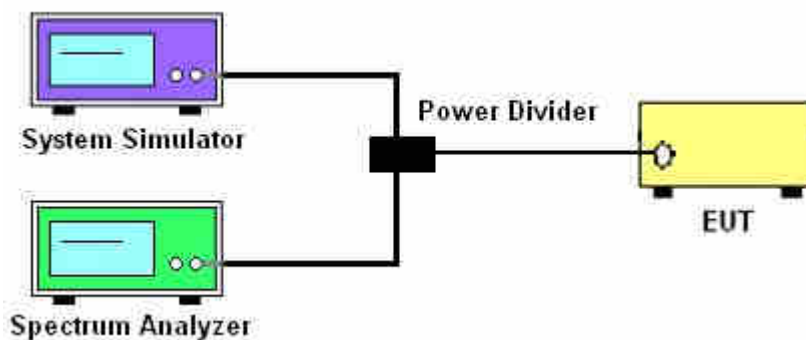

##### 3.2.3 Frequency Stability

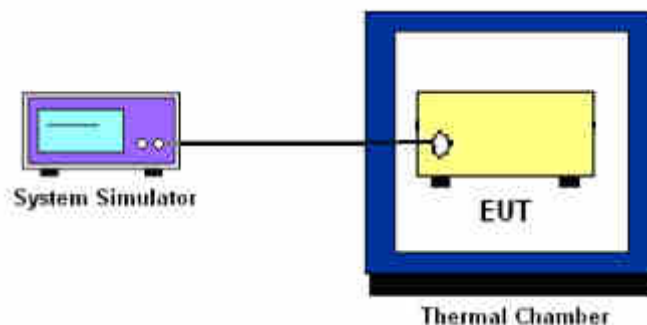

### 3.3 Test Result of Conducted Test

Please refer to Appendix A.



## **3.4 Conducted Output Power**

### **3.4.1 Description of the Conducted Output Power Measurement**

A system simulator was used to establish communication with the EUT. Its parameters were set to force the EUT transmitting at maximum output power. The measured power in the radio frequency on the transmitter output terminals shall be reported.

### **3.4.2 Test Procedures**

1. The transmitter output port was connected to the system simulator.
2. Set EUT at maximum power through the system simulator.
3. Select lowest, middle, and highest channels for each band and different modulation.
4. Measure and record the power level from the system simulator.



## **3.5 Peak-to-Average Ratio**

### **3.5.1 Description of the PAR Measurement**

Power Complementary Cumulative Distribution Function (CCDF) curves provide a means for characterizing the power peaks of a digitally modulated signal on a statistical basis. A CCDF curve depicts the probability of the peak signal amplitude exceeding the average power level. Most contemporary measurement instrumentation include the capability to produce CCDF curves for an input signal provided that the instrument's resolution bandwidth can be set wide enough to accommodate the entire input signal bandwidth. In measuring transmissions in this band using an average power technique, the peak-to-average ratio (PAR) of the transmission may not exceed 13 dB.

### **3.5.2 Test Procedures**

1. The testing follows FCC KDB 971168 v02r02 Section 5.7.1 and ANSI C63.26 Section 5.2.3.4.
2. The EUT was connected to spectrum and system simulator via a power divider.
3. Set the CCDF (Complementary Cumulative Distribution Function) option in spectrum analyzer.
4. The highest RF powers were measured and recorded the maximum PAPR level associated with a probability of 0.1 %.
5. Record the deviation as Peak to Average Ratio.



## 3.6 Occupied Bandwidth

### 3.6.1 Description of Occupied Bandwidth Measurement

The occupied bandwidth is the width of a frequency band such that, below the lower and above the upper frequency limits, the mean powers emitted are each equal to a specified percentage 0.5% of the total mean transmitted power.

The 26 dB emission bandwidth is defined as the frequency range between two points, one above and one below the carrier frequency, at which the spectral density of the emission is attenuated 26 dB below the maximum in-band spectral density of the modulated signal. Spectral density (power per unit bandwidth) is to be measured with a detector of resolution bandwidth equal to approximately 1.0% of the emission bandwidth.

### 3.6.2 Test Procedures

1. The testing follows FCC KDB 971168 v02r02 Section 4.2 and ANSI C63.26 Section 5.4.
2. The EUT was connected to spectrum analyzer and system simulator via a power divider.
3. The spectrum analyzer center frequency is set to the nominal EUT channel center frequency. The span range for the spectrum analyzer shall be between two and five times the anticipated OBW.
4. The nominal resolution bandwidth (RBW) shall be in the range of 1 to 5 % of the anticipated OBW, and the VBW shall be at least 3 times the RBW.
5. Set the detection mode to peak, and the trace mode to max hold.
6. Determine the reference value: Set the EUT to transmit a modulated signal. Allow the trace to stabilize. Set the spectrum analyzer marker to the highest level of the displayed trace.  
(this is the reference value)
7. Determine the “-26 dB down amplitude” as equal to (Reference Value – X).
8. Place two markers, one at the lowest and the other at the highest frequency of the envelope of the spectral display such that each marker is at or slightly below the “-X dB down amplitude” determined in step 6. If a marker is below this “-X dB down amplitude” value it shall be placed as close as possible to this value. The OBW is the positive frequency difference between the two markers.
9. Use the 99 % power bandwidth function of the spectrum analyzer and report the measured bandwidth.



### 3.7 Conducted Band Edge

#### 3.7.1 Description of Conducted Band Edge Measurement

24.238 (a) and RSS-133

For operations in the 1850-1910 and 1930-1990 MHz band, the FCC limit is  $43 + 10\log_{10}(P[\text{Watts}])$  dB below the transmitter power  $P(\text{Watts})$  in a 1MHz bandwidth. However, in the 1 MHz bands immediately outside and adjacent to the frequency block a resolution bandwidth of at least one percent of the emission bandwidth of the fundamental emission of the transmitter may be employed.

27.53 (c) and RSS-130

For operations in the 776-788 MHz band, the FCC limit is  $43 + 10\log_{10}(P[\text{Watts}])$  dB below the transmitter power  $P(\text{Watts})$  in a 100 kHz bandwidth. However, in the 100 kHz bands immediately outside and adjacent to the frequency block, a resolution bandwidth of at least 30 kHz may be employed. In addition, the power of any unwanted emissions in any 6.25 kHz bandwidth for all frequencies between 763-775 MHz and 793-806 MHz shall be attenuated below the transmitter power,  $P$  (dBW), by at least  $65 + 10 \log_{10} p(\text{watts})$ , dB, for mobile and portable equipment.

27.53 (g ) and RSS-130

For operations in the 698 -746 MHz band, the FCC limit is  $43 + 10\log_{10}(P[\text{Watts}])$  dB below the transmitter power  $P(\text{Watts})$  in a 100 kHz bandwidth. However, in the 100 kilohertz bands immediately outside and adjacent to a licensee's frequency block, a resolution bandwidth of at least 30 kHz may be employed.





27.53(m)(4)

For mobile digital stations, the attenuation factor shall be not less than  $40 + 10 \log (P)$  dB on all frequencies between the channel edge and 5 megahertz from the channel edge,  $43 + 10 \log (P)$  dB on all frequencies between 5 megahertz and X megahertz from the channel edge, and  $55 + 10 \log (P)$  dB on all frequencies more than X megahertz from the channel edge, where X is the greater of 6 megahertz or the actual emission bandwidth as defined in paragraph (m)(6) of this section. In addition, the attenuation factor shall not be less that  $43 + 10 \log (P)$  dB on all frequencies between 2490.5 MHz and 2496 MHz and  $55 + 10 \log (P)$  dB at or below 2490.5 MHz. Mobile Satellite Service licensees operating on frequencies below 2495 MHz may also submit a documented interference complaint against BRS licensees operating on channel BRS Channel 1 on the same terms and conditions as adjacent channel BRS or EBS licensees.

RSS-199 4.5(b):

For mobile subscriber equipment, the power of any unwanted emissions measured as above shall be attenuated (in dB) below the transmitter power, P (dBW), by at least:

- i)  $40 + 10 \log_{10} p$  from the channel edges to 5 MHz away,
- ii)  $43 + 10 \log_{10} p$  between 5 MHz and X MHz from the channel edges, and
- iii)  $55 + 10 \log_{10} p$  at X MHz and beyond from the channel edges.
- iv) in addition, the attenuation shall be not be less than  $43 + 10 \log_{10} p$  on all frequencies between 2490.5 MHz and 2496 MHz and  $55 + 10 \log_{10} p$  at or below 2490.5 MHz.

where p in (a) and (b) is the transmitter power measured in watts and X is 6 MHz or the equipment occupied bandwidth, whichever is greater.



### 3.7.2 Test Procedures

1. The testing follows FCC KDB 971168 v02r02 Section 6.0 and ANSI C63.26 Section 5.7.
2. The EUT was connected to spectrum analyzer and system simulator via a power divider.
3. The band edges of low and high channels for the highest RF powers were measured.
4. Set RBW  $\geq$  1% EBW in the 1MHz band immediately outside and adjacent to the band edge.
5. Beyond the 1 MHz band from the band edge, RBW=1MHz was used.
6. Set spectrum analyzer with RMS detector.
7. The RF fundamental frequency should be excluded against the limit line in the operating frequency band.
8. Checked that all the results comply with the emission limit line.

Example:

The limit line is derived from  $43 + 10\log(P)$ dB below the transmitter power P(Watts)

$$= P(W) - [43 + 10\log(P)] \text{ (dB)}$$

$$= [30 + 10\log(P)] \text{ (dBm)} - [43 + 10\log(P)] \text{ (dB)} = -13\text{dBm.}$$

9. For LTE Band 7, 41, the other 40 dB, and 55 dB have additionally applied same calculation above.



## 3.8 Conducted Spurious Emission

### 3.8.1 Description of Conducted Spurious Emission Measurement

The power of any emission outside of the authorized operating frequency ranges must be lower than the transmitter power (P) by a factor of at least  $43 + 10 \log (P)$  dB.

For Band 7, 41:

The power of any emission outside of the authorized operating frequency ranges must be lower than the transmitter power (P) by a factor of at least  $55 + 10 \log (P)$  dB.

It is measured by means of a calibrated spectrum analyzer and scanned from 30 MHz up to a frequency including its 10<sup>th</sup> harmonic.

### 3.8.2 Test Procedures

1. The testing follows FCC KDB 971168 v02r02 Section 6.0 and ANSI C63.26 Section 5.7.
2. The EUT was connected to spectrum analyzer and system simulator via a power divider.
3. The RF output of EUT was connected to the spectrum analyzer by RF cable and attenuator.  
The path loss was compensated to the results for each measurement.
4. The middle channel for the highest RF power within the transmitting frequency was measured.
5. The conducted spurious emission for the whole frequency range was taken.
6. Make the measurement with the spectrum analyzer's RBW = 1MHz, VBW = 3MHz.
7. Set spectrum analyzer with RMS detector.
8. Taking the record of maximum spurious emission.
9. The RF fundamental frequency should be excluded against the limit line in the operating frequency band.
10. The limit line is derived from  $43 + 10\log(P)$ dB below the transmitter power P(Watts)  
 $= P(W) - [43 + 10\log(P)]$  (dB)  
 $= [30 + 10\log(P)]$  (dBm) -  $[43 + 10\log(P)]$  (dB)  
 $= -13$ dBm.
11. For Band 7, 41  
The limit line is derived from  $55 + 10\log(P)$ dB below the transmitter power P(Watts)  
 $= P(W) - [55 + 10\log(P)]$  (dB)  
 $= [30 + 10\log(P)]$  (dBm) -  $[55 + 10\log(P)]$  (dB)  
 $= -25$ dBm.



### 3.9 Frequency Stability

#### 3.9.1 Description of Frequency Stability Measurement

The frequency stability shall be measured by variation of ambient temperature and variation of primary supply voltage to ensure that the fundamental emission stays within the authorized frequency block. The frequency stability of the transmitter shall be maintained within  $\pm 0.00025\%$  ( $\pm 2.5\text{ppm}$ ) of the center frequency.

#### 3.9.2 Test Procedures for Temperature Variation

1. The testing follows FCC KDB 971168 v02r02 Section 9.0 and ANSI C63.26 Section 5.6.
2. The EUT was set up in the thermal chamber and connected with the system simulator.
3. With power OFF, the temperature was decreased to  $-30^{\circ}\text{C}$  and the EUT was stabilized before testing. Power was applied and the maximum change in frequency was recorded within one minute.
4. With power OFF, the temperature was raised in  $10^{\circ}\text{C}$  step up to  $50^{\circ}\text{C}$ . The EUT was stabilized at each step for at least half an hour. Power was applied and the maximum frequency change was recorded within one minute.

#### 3.9.3 Test Procedures for Voltage Variation

1. The testing follows FCC KDB 971168 v02r02 Section 9.0 and ANSI C63.26 Section 5.6..
2. The EUT was placed in a temperature chamber at  $25\pm 5^{\circ}\text{C}$  and connected with the system simulator.
3. The power supply voltage to the EUT was varied from 85% to 115% of the nominal value measured at the input to the EUT.
4. The variation in frequency was measured for the worst case.

#### 3.9.4 Test Procedures for Frequency Stability

1. The testing follows the Section 6.11 of RSS-GEN.
2. The EUT was connected to spectrum analyzer and system simulator via a power divider.
3. The EUT was operated at the lowest and highest channel.
4. For RSS-133 the frequency range shall be within the frequency range.
5. For RSS 130,197,199, the frequency at these points shall be recorded as fL and fH respectively. The frequency stability by showing that fL minus the frequency offset and fH plus the frequency offset shall be within the frequency range that the equipment is designed to operate.

## 4 Radiated Test Items

### 4.1 Measuring Instruments

See list of measuring instruments of this test report.

### 4.2 Test Setup

#### 4.2.1 For radiated test from 30MHz to 1GHz

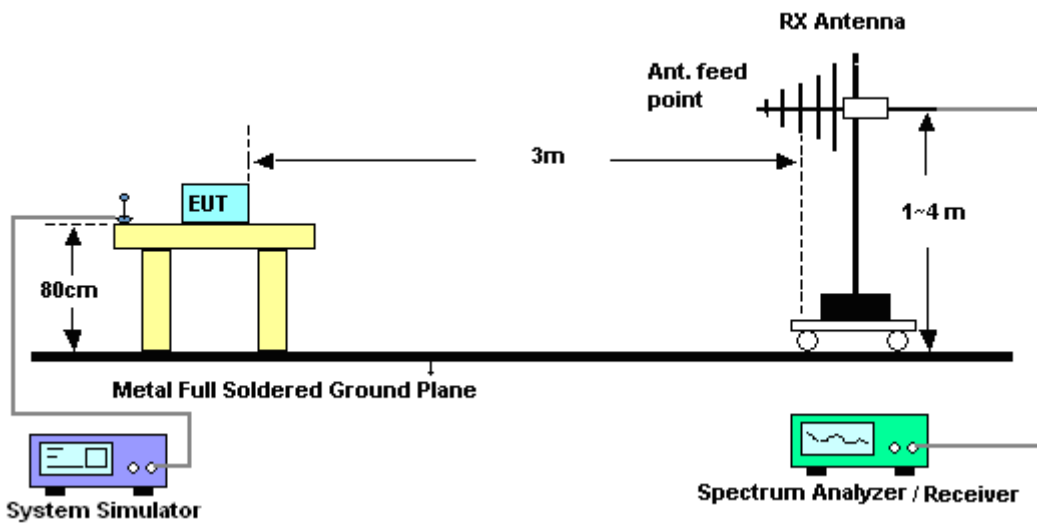

#### 4.2.2 For radiated test above 1GHz

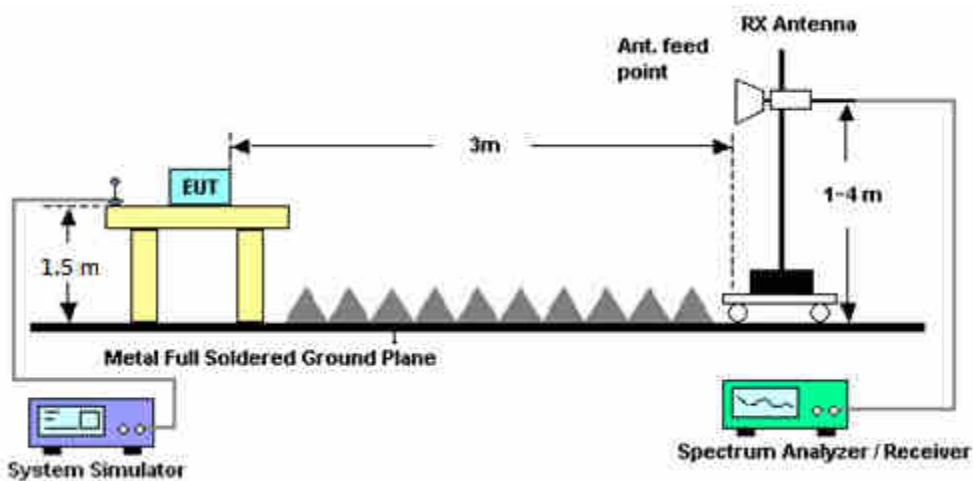

### 4.3 Test Result of Radiated Test

Please refer to Appendix B.



## 4.4 Radiated Spurious Emission

### 4.4.1 Description of Radiated Spurious Emission

The radiated spurious emission was measured by substitution method according to ANSI / TIA / EIA-603-E and ANSI C63.26. The power of any emission outside of the authorized operating frequency ranges must be attenuated below the transmitter power (P) by a factor of at least  $43 + 10 \log (P)$  dB.

For Band 7, 41

The power of any emission outside of the authorized operating frequency ranges must be attenuated below the transmitter power (P) by a factor of at least  $55 + 10 \log (P)$  dB.

For LTE Band 12,13

For operations in the 746-758 MHz, 775-788 MHz, and 805-806 MHz bands, emissions in the band 1559-1610 MHz shall be limited to  $-70$  dBW/MHz equivalent isotropically radiated power (EIRP) for wideband signals, and  $-80$  dBW EIRP for discrete emissions of less than 700 Hz bandwidth.

The spectrum is scanned from 30 MHz up to a frequency including its 10th harmonic.



#### 4.4.2 Test Procedures

1. The testing follows FCC KDB 971168 v02r02 Section 5.8 and ANSI / TIA-603-E Section 2.2.12 and ANSI C63.26 Section 5.5.3.
2. The EUT was placed on a turntable with 0.8 meter height for frequency below 1GHz and 1.5 meter height for frequency above 1GHz respectively above ground.
3. The EUT was set 3 meters from the receiving antenna mounted on the antenna tower.
4. The table was rotated 360 degrees to determine the position of the highest spurious emission.
5. The height of the receiving antenna is varied between 1m to 4m to search the maximum spurious emission for both horizontal and vertical polarizations.
6. During the measurement, the system simulator parameters were set to force the EUT transmitting at maximum output power.
7. Make the measurement with the spectrum analyzer's RBW = 1MHz, VBW = 3MHz, taking the record of maximum spurious emission.
8. A horn antenna was substituted in place of the EUT and was driven by a signal generator.
9. Tune the output power of signal generator to the same emission level with EUT maximum spurious emission.
10.  $EIRP \text{ (dBm)} = S.G. \text{ Power} - Tx \text{ Cable Loss} + Tx \text{ Antenna Gain}$
11.  $ERP \text{ (dBm)} = EIRP - 2.15$
12. The RF fundamental frequency should be excluded against the limit line in the operating frequency band.  
The limit line is derived from  $43 + 10\log(P)\text{dB}$  below the transmitter power  $P(\text{Watts})$   
 $= P(\text{W}) - [43 + 10\log(P)] \text{ (dB)}$   
 $= [30 + 10\log(P)] \text{ (dBm)} - [43 + 10\log(P)] \text{ (dB)}$   
 $= -13\text{dBm}.$
13. For Band 7, 41:  
The limit line is derived from  $55 + 10\log(P)\text{dB}$  below the transmitter power  $P(\text{Watts})$   
 $EIRP \text{ (dBm)} = S.G. \text{ Power} - Tx \text{ Cable Loss} + Tx \text{ Antenna Gain}$   
 $ERP \text{ (dBm)} = EIRP - 2.15$



## 5 List of Measuring Equipment

Instrument	Manufacturer	Model No.	Serial No.	Characteristics	Calibration Date	Test Date	Due Date	Remark
LTE Base Station	Anritsu	MT8820C	6201432821	GSM/GPRS /WCDMA/LTE	Oct. 11, 2016	Sep. 19, 2017 ~ Oct. 04, 2017	Oct. 10, 2017	Conducted (TH05-HY)
Spectrum Analyzer	Rohde & Schwarz	FSV40	101397	10Hz~40GHz	Nov. 04, 2016	Sep. 19, 2017 ~ Oct. 04, 2017	Nov. 03, 2017	Conducted (TH05-HY)
Temperature Chamber	ESPEC	SH-641	92013720	-30℃~70℃	Aug. 28, 2017	Sep. 19, 2017 ~ Oct. 04, 2017	Aug. 27, 2018	Conducted (TH05-HY)
Programmable Power Supply	GW Instek	PSS-2005	EL890089	1V~20V 0.5A~5A	Jan. 12, 2017	Sep. 19, 2017 ~ Oct. 04, 2017	Jan. 11, 2018	Conducted (TH05-HY)
Coupler	Warison	1-18GHz 20dB 25WSMA Directional Coupler	#B	1G~18GHz	Feb. 20, 2017	Sep. 19, 2017 ~ Oct. 04, 2017	Feb. 19, 2018	Conducted (TH05-HY)
Bilog Antenna	Schaffner	CBL6111C	2726	30MHz ~ 1GHz	N/A	Sep. 23, 2017 ~ Oct. 06, 2017	N/A	Radiation (03CH07-HY)
Double Ridge Horn Antenna	ESCO	3117	00075962	1GHz ~ 18GHz	Aug. 23, 2017	Sep. 23, 2017 ~ Oct. 06, 2017	Aug. 22, 2018	Radiation (03CH07-HY)
Preamplifier	MITEQ	AMF-7D-0010 1800-30-10P	1590075	1GHz ~ 18GHz	Apr. 25, 2017	Sep. 23, 2017 ~ Oct. 06, 2017	Apr. 24, 2018	Radiation (03CH07-HY)
Preamplifier	COM-POWER	PA-103A	161241	10MHz-1GHz	Mar. 14, 2017	Sep. 23, 2017 ~ Oct. 06, 2017	Mar. 13, 2018	Radiation (03CH07-HY)
EMI Test Receiver	Agilent	N9038A (MXE)	MY53290053	20Hz to 26.5GHz	Jan. 12, 2017	Sep. 23, 2017 ~ Oct. 06, 2017	Jan. 11, 2018	Radiation (03CH07-HY)
Horn Antenna	ESCO	3117	00066584	1GHz~18GHz	Sep. 06, 2017	Sep. 23, 2017 ~ Oct. 06, 2017	Sep. 05, 2018	Radiation (03CH07-HY)
Antenna Mast	Max-Full	MFA520BS	N/A	1m~4m	N/A	Sep. 23, 2017 ~ Oct. 06, 2017	N/A	Radiation (03CH07-HY)
Turn Table	ChainTek	Chaintek 3000	N/A	0~360 Degree	N/A	Sep. 23, 2017 ~ Oct. 06, 2017	N/A	Radiation (03CH07-HY)
SHF-EHF Horn Antenna	SCHWARZBECK	BBHA 9170	BBHA9170584	18GHz- 40GHz	Nov. 08, 2016	Sep. 23, 2017 ~ Oct. 06, 2017	Nov. 07, 2017	Radiation (03CH07-HY)
Amplifier	MITEQ	TTA1840-35-HG	1871923	18GHz~40GHz, VSWR : 2.5:1 max	Jul. 18, 2017	Sep. 23, 2017 ~ Oct. 06, 2017	Jul. 17, 2018	Radiation (03CH07-HY)
Signal Generator	Rohde & Schwarz	SMF100A	101107	100kHz~40GHz	May 22, 2017	Sep. 23, 2017 ~ Oct. 06, 2017	May 21, 2018	Radiation (03CH07-HY)





## 6 Uncertainty of Evaluation

### Uncertainty of Radiated Emission Measurement (30 MHz ~ 1000 MHz)

Measuring Uncertainty for a Level of Confidence of 95% ( $U = 2Uc(y)$ )	3.05
-------------------------------------------------------------------------	------

### Uncertainty of Radiated Emission Measurement (1 GHz ~ 18 GHz)

Measuring Uncertainty for a Level of Confidence of 95% ( $U = 2Uc(y)$ )	3.44
-------------------------------------------------------------------------	------

### Uncertainty of Radiated Emission Measurement (18 GHz ~ 40 GHz)

Measuring Uncertainty for a Level of Confidence of 95% ( $U = 2Uc(y)$ )	3.95
-------------------------------------------------------------------------	------



## Appendix A. Test Results of Conducted Test

### Conducted Output Power(Average power)

LTE Band 2 Maximum Average Power [dBm]						
BW [MHz]	RB Size	RB Offset	Mod	Lowest	Middle	Highest
20	1	0	QPSK	<b>22.55</b>	22.24	22.26
20	1	49		22.07	21.90	22.09
20	1	99		22.08	21.91	22.06
20	50	0		21.36	21.08	21.27
20	50	24		21.18	21.00	21.23
20	50	50		21.12	20.86	21.17
20	100	0		21.19	21.03	21.23
20	1	0	16-QAM	21.89	21.64	21.57
20	1	49		21.44	21.23	21.42
20	1	99		21.48	21.24	21.38
20	50	0		20.39	20.11	20.29
20	50	24		20.18	20.03	20.21
20	50	50		20.11	19.91	20.19
20	100	0		20.19	20.02	20.23
20	1	0	64-QAM	20.71	20.39	20.44
20	1	49		20.26	20.09	20.28
20	1	99		20.27	20.09	20.29
20	50	0		19.38	19.09	19.29
20	50	24		19.20	19.03	19.24
20	50	50		19.13	18.89	19.16
20	100	0		19.23	19.02	19.26
15	1	0	QPSK	22.35	22.08	22.26
15	1	37		22.09	21.91	22.12
15	1	74		22.06	21.81	22.09
15	36	0		21.31	21.03	21.25
15	36	20		21.17	21.01	21.22
15	36	39		21.12	20.85	21.19
15	75	0		21.18	21.00	21.20
15	1	0	16-QAM	21.67	21.41	21.56
15	1	37		21.43	21.25	21.43
15	1	74		21.38	21.12	21.44
15	36	0		20.32	20.08	20.26
15	36	20		20.19	20.03	20.21
15	36	39		20.10	19.88	20.18
15	75	0		20.17	19.98	20.20
15	1	0	64-QAM	20.57	20.27	20.44
15	1	37		20.29	20.08	20.28
15	1	74		20.27	20.01	20.27
15	36	0		19.35	19.08	19.28
15	36	20		19.20	19.04	19.24
15	36	39		19.14	18.90	19.18
15	75	0		19.16	19.01	19.19



LTE Band 2 Maximum Average Power [dBm]						
BW [MHz]	RB Size	RB Offset	Mod	Lowest	Middle	Highest
10	1	0	QPSK	22.42	22.21	22.21
10	1	25		22.11	21.91	22.12
10	1	49		22.18	21.99	22.10
10	25	0		21.21	21.02	21.23
10	25	12		21.17	21.01	21.20
10	25	25		21.03	20.88	21.18
10	50	0		21.19	21.02	21.21
10	1	0	16-QAM	21.72	21.58	21.51
10	1	25		21.45	21.28	21.48
10	1	49		21.50	21.36	21.38
10	25	0		20.22	20.03	20.22
10	25	12		20.18	20.03	20.22
10	25	25		20.05	19.90	20.19
10	50	0		20.19	20.02	20.24
10	1	0	64-QAM	20.59	20.42	20.39
10	1	25		20.31	20.11	20.32
10	1	49		20.33	20.16	20.27
10	25	0		19.23	19.05	19.24
10	25	12		19.19	19.04	19.24
10	25	25		19.03	18.91	19.18
10	50	0		19.19	19.00	19.21
5	1	0	QPSK	22.15	21.96	22.18
5	1	12		22.08	21.89	22.08
5	1	24		22.09	21.79	22.10
5	12	0		21.14	21.00	21.20
5	12	7		21.15	21.00	21.22
5	12	13		21.09	20.94	21.15
5	25	0		21.13	20.98	21.17
5	1	0	16-QAM	21.52	21.31	21.51
5	1	12		21.43	21.26	21.49
5	1	24		21.44	21.16	21.40
5	12	0		20.19	20.02	20.23
5	12	7		20.16	20.01	20.24
5	12	13		20.14	20.00	20.19
5	25	0		20.15	20.01	20.21
5	1	0	64-QAM	20.36	20.19	20.27
5	1	12		20.29	20.15	20.30
5	1	24		20.25	19.97	20.29
5	12	0		19.21	19.05	19.25
5	12	7		19.21	19.06	19.27
5	12	13		19.18	19.02	19.25
5	25	0		19.14	19.02	19.18



LTE Band 2 Maximum Average Power [dBm]						
BW [MHz]	RB Size	RB Offset	Mod	Lowest	Middle	Highest
3	1	0	QPSK	22.07	21.89	22.08
3	1	8		22.07	21.88	22.07
3	1	14		22.04	21.85	22.07
3	8	0		21.14	20.97	21.14
3	8	4		21.11	20.95	21.19
3	8	7		21.09	20.93	21.13
3	15	0		21.13	20.95	21.15
3	1	0	16-QAM	21.40	21.28	21.49
3	1	8		21.42	21.25	21.44
3	1	14		21.37	21.27	21.38
3	8	0		20.19	20.02	20.23
3	8	4		20.20	20.04	20.25
3	8	7		20.17	19.98	20.20
3	15	0		20.12	19.98	20.20
3	1	0	64-QAM	20.27	20.15	20.24
3	1	8		20.25	20.08	20.25
3	1	14		20.25	20.05	20.23
3	8	0		19.16	18.98	19.21
3	8	4		19.18	19.02	19.22
3	8	7		19.14	18.99	19.19
3	15	0		19.12	18.96	19.18
1.4	1	0	QPSK	22.03	21.87	22.03
1.4	1	3		22.11	21.92	22.11
1.4	1	5		22.01	21.84	22.01
1.4	3	0		22.06	21.89	22.08
1.4	3	1		22.11	21.93	22.12
1.4	3	3		22.06	21.88	22.09
1.4	6	0		21.06	20.89	21.10
1.4	1	0	16-QAM	21.35	21.15	21.38
1.4	1	3		21.43	21.25	21.43
1.4	1	5		21.33	21.16	21.32
1.4	3	0		21.11	20.95	21.12
1.4	3	1		21.13	20.95	21.14
1.4	3	3		21.09	20.90	21.07
1.4	6	0		20.12	19.97	20.18
1.4	1	0	64-QAM	20.18	19.98	20.18
1.4	1	3		20.23	20.06	20.27
1.4	1	5		20.14	19.99	20.20
1.4	3	0		20.20	20.02	20.24
1.4	3	1		20.25	20.06	20.29
1.4	3	3		20.20	20.02	20.22
1.4	6	0		19.06	18.92	19.13



LTE Band 7 Maximum Average Power [dBm]						
BW [MHz]	RB Size	RB Offset	Mod	Lowest	Middle	Highest
20	1	0	QPSK	21.65	21.78	21.82
20	1	49		21.59	21.65	21.74
20	1	99		21.58	21.65	21.81
20	50	0		20.60	20.81	20.79
20	50	24		20.69	20.72	20.83
20	50	50		20.66	20.72	20.82
20	100	0		20.70	20.74	20.80
20	1	0	16-QAM	20.96	21.09	21.10
20	1	49		20.91	20.95	21.05
20	1	99		20.90	20.93	21.12
20	50	0		19.66	19.85	19.81
20	50	24		19.72	19.76	19.84
20	50	50		19.69	19.73	19.84
20	100	0		19.70	19.73	19.82
20	1	0	64-QAM	19.90	20.01	20.02
20	1	49		19.86	19.87	19.98
20	1	99		19.84	19.84	20.06
20	50	0		18.66	18.86	18.81
20	50	24		18.73	18.76	18.85
20	50	50		18.70	18.76	18.87
20	100	0		18.73	18.74	18.86
15	1	0	QPSK	21.78	21.80	21.79
15	1	37		21.67	21.67	21.80
15	1	74		21.77	21.63	21.84
15	36	0		20.77	20.81	20.83
15	36	20		20.73	20.75	20.88
15	36	39		20.79	20.74	20.85
15	75	0		20.75	20.71	20.88
15	1	0	16-QAM	21.07	21.09	21.10
15	1	37		20.95	20.98	21.12
15	1	74		21.06	20.93	21.14
15	36	0		19.79	19.84	19.88
15	36	20		19.77	19.79	19.91
15	36	39		19.84	19.75	19.88
15	75	0		19.78	19.74	19.85
15	1	0	64-QAM	20.05	20.04	20.02
15	1	37		19.89	19.90	20.01
15	1	74		19.98	19.86	20.07
15	36	0		18.80	18.85	18.88
15	36	20		18.79	18.79	18.94
15	36	39		18.86	18.77	18.93
15	75	0		18.76	18.77	18.88



LTE Band 7 Maximum Average Power [dBm]						
BW [MHz]	RB Size	RB Offset	Mod	Lowest	Middle	Highest
10	1	0	QPSK	21.75	21.82	21.83
10	1	25		21.73	21.68	21.86
10	1	49		21.78	21.69	21.83
10	25	0		20.75	20.71	20.87
10	25	12		20.75	20.75	20.92
10	25	25		20.70	20.71	20.86
10	50	0		20.74	20.73	20.85
10	1	0	16-QAM	21.07	21.10	21.13
10	1	25		21.03	21.02	21.15
10	1	49		21.08	21.04	21.15
10	25	0		19.78	19.74	19.90
10	25	12		19.79	19.77	19.91
10	25	25		19.74	19.74	19.89
10	50	0		19.77	19.77	19.91
10	1	0	64-QAM	19.96	20.02	20.04
10	1	25		19.91	19.94	20.06
10	1	49		19.96	19.92	20.06
10	25	0		18.80	18.77	18.92
10	25	12		18.80	18.80	18.96
10	25	25		18.76	18.77	18.92
10	50	0		18.79	18.78	18.94
5	1	0	QPSK	21.64	21.71	21.96
5	1	12		21.65	21.71	21.97
5	1	24		21.58	21.72	21.96
5	12	0		20.70	20.77	21.01
5	12	7		20.73	20.81	21.06
5	12	13		20.63	20.73	21.05
5	25	0		20.66	20.76	21.02
5	1	0	16-QAM	20.97	21.02	21.24
5	1	12		20.98	21.03	21.28
5	1	24		20.90	21.02	21.26
5	12	0		19.71	19.78	20.06
5	12	7		19.75	19.81	20.08
5	12	13		19.67	19.77	20.04
5	25	0		19.68	19.78	20.02
5	1	0	64-QAM	19.88	19.91	20.16
5	1	12		19.85	19.95	20.18
5	1	24		19.81	19.91	20.15
5	12	0		18.75	18.80	19.06
5	12	7		18.78	18.83	19.10
5	12	13		18.72	18.82	19.06
5	25	0		18.69	18.76	19.02



LTE Band 12 Maximum Average Power [dBm]						
BW [MHz]	RB Size	RB Offset	Mod	Lowest	Middle	Highest
10	1	0	QPSK	22.75	22.70	22.76
10	1	25		22.69	22.70	22.67
10	1	49		22.67	22.73	22.70
10	25	0		21.67	21.78	21.70
10	25	12		21.80	21.78	21.78
10	25	25		21.80	21.82	21.76
10	50	0		21.78	21.72	21.81
10	1	0	16-QAM	21.90	21.98	21.99
10	1	25		22.04	22.01	22.04
10	1	49		22.01	21.99	21.98
10	25	0		20.74	20.76	20.69
10	25	12		20.84	20.77	20.83
10	25	25		20.74	20.84	20.79
10	50	0		20.82	20.75	20.82
10	1	0	64-QAM	20.93	20.94	20.89
10	1	25		20.94	20.94	20.98
10	1	49		20.90	20.98	20.88
10	25	0		19.71	19.76	19.69
10	25	12		19.83	19.78	19.85
10	25	25		19.74	19.83	19.79
10	50	0		19.84	19.76	19.81
5	1	0	QPSK	22.72	22.71	22.75
5	1	12		22.62	22.65	22.72
5	1	24		22.72	22.75	22.71
5	12	0		21.71	21.73	21.76
5	12	7		21.73	21.71	21.79
5	12	13		21.79	21.69	21.74
5	25	0		21.68	21.74	21.73
5	1	0	16-QAM	21.93	22.01	21.97
5	1	12		21.92	21.99	21.95
5	1	24		22.02	22.06	21.96
5	12	0		20.76	20.74	20.83
5	12	7		20.77	20.75	20.84
5	12	13		20.81	20.71	20.74
5	25	0		20.71	20.74	20.77
5	1	0	64-QAM	20.85	20.89	20.80
5	1	12		20.86	20.89	20.89
5	1	24		20.82	20.93	20.79
5	12	0		19.63	19.71	19.60
5	12	7		19.75	19.73	19.76
5	12	13		19.66	19.78	19.70
5	25	0		19.76	19.71	19.72



LTE Band 12 Maximum Average Power [dBm]						
BW [MHz]	RB Size	RB Offset	Mod	Lowest	Middle	Highest
3	1	0	QPSK	22.66	22.67	22.69
3	1	8		22.67	22.65	22.68
3	1	14		22.61	22.63	22.67
3	8	0		21.68	21.71	21.82
3	8	4		21.68	21.74	21.87
3	8	7		21.66	21.70	21.85
3	15	0		21.67	21.70	21.81
3	1	0	16-QAM	21.88	21.97	22.02
3	1	8		21.90	21.96	22.05
3	1	14		21.88	21.94	22.07
3	8	0		20.78	20.75	20.88
3	8	4		20.79	20.78	20.91
3	8	7		20.73	20.74	20.89
3	15	0		20.74	20.75	20.85
3	1	0	64-QAM	20.86	20.88	21.01
3	1	8		20.89	20.86	20.99
3	1	14		20.86	20.87	20.97
3	8	0		19.75	19.75	19.87
3	8	4		19.74	19.77	19.90
3	8	7		19.71	19.73	19.87
3	15	0		19.69	19.74	19.85
1.4	1	0	QPSK	22.40	22.41	22.50
1.4	1	3		22.47	22.47	22.60
1.4	1	5		22.40	22.39	22.49
1.4	3	0		22.49	22.45	22.56
1.4	3	1		22.54	22.50	22.59
1.4	3	3		22.49	22.44	22.55
1.4	6	0		21.44	21.45	21.56
1.4	1	0	16-QAM	21.67	21.72	21.80
1.4	1	3		21.72	21.77	21.88
1.4	1	5		21.63	21.69	21.81
1.4	3	0		21.46	21.49	21.61
1.4	3	1		21.51	21.53	21.65
1.4	3	3		21.45	21.48	21.60
1.4	6	0		20.49	20.53	20.65
1.4	1	0	64-QAM	20.66	20.62	20.75
1.4	1	3		20.71	20.65	20.79
1.4	1	5		20.65	20.62	20.71
1.4	3	0		20.60	20.63	20.72
1.4	3	1		20.64	20.66	20.75
1.4	3	3		20.58	20.59	20.71
1.4	6	0		19.47	19.44	19.56





LTE Band 13 Maximum Average Power [dBm]						
BW [MHz]	RB Size	RB Offset	Mod	Lowest	Middle	Highest
10	1	0	QPSK		22.85	
10	1	25			22.79	
10	1	49			22.77	
10	25	0			21.77	
10	25	12			21.90	
10	25	25			21.89	
10	50	0			21.90	
10	1	0	16-QAM		22.05	
10	1	25			22.17	
10	1	49			22.09	
10	25	0			20.79	
10	25	12			20.92	
10	25	25			20.86	
10	50	0			20.92	
10	1	0	64-QAM		21.00	
10	1	25			21.02	
10	1	49			21.00	
10	25	0			19.82	
10	25	12			19.96	
10	25	25			19.88	
10	50	0			19.94	
5	1	0	QPSK	22.77	22.75	22.84
5	1	12		22.74	22.80	22.78
5	1	24		22.82	22.80	22.77
5	12	0		21.79	21.76	21.82
5	12	7		21.81	21.89	21.86
5	12	13		21.77	21.84	21.84
5	25	0		21.76	21.85	21.87
5	1	0	16-QAM	22.04	22.05	22.15
5	1	12		22.08	22.13	22.12
5	1	24		22.14	22.08	22.09
5	12	0		20.81	20.81	20.85
5	12	7		20.87	20.90	20.86
5	12	13		20.80	20.83	20.86
5	25	0		20.78	20.88	20.85
5	1	0	64-QAM	20.83	20.84	20.78
5	1	12		20.83	20.83	20.86
5	1	24		20.79	20.85	20.79
5	12	0		19.62	19.65	19.57
5	12	7		19.72	19.69	19.73
5	12	13		19.65	19.71	19.67
5	25	0		19.72	19.69	19.69



LTE Band 26 Maximum Average Power [dBm]						
BW [MHz]	RB Size	RB Offset	Mod	Lowest	Middle	Highest
15	1	0	QPSK	22.79	22.81	22.84
15	1	37		22.65	22.65	22.64
15	1	74		22.58	22.61	22.59
15	36	0		21.73	21.73	21.73
15	36	20		21.69	21.72	21.74
15	36	39		21.69	21.68	21.73
15	75	0		21.76	21.68	21.71
15	1	0	16-QAM	21.97	22.04	22.05
15	1	37		21.95	21.97	21.95
15	1	74		21.88	21.92	21.92
15	36	0		20.74	20.73	20.78
15	36	20		20.71	20.71	20.72
15	36	39		20.68	20.74	20.72
15	75	0		20.74	20.66	20.70
15	1	0	64-QAM	20.97	20.97	20.98
15	1	37		20.90	20.86	20.91
15	1	74		20.81	20.83	20.84
15	36	0		19.72	19.76	19.78
15	36	20		19.74	19.74	19.76
15	36	39		19.71	19.73	19.75
15	75	0		19.75	19.66	19.69
10	1	0	QPSK	22.77	22.66	22.74
10	1	25		22.68	22.61	22.78
10	1	49		22.67	22.58	22.67
10	25	0		21.86	21.66	21.76
10	25	12		21.74	21.63	21.85
10	25	25		21.67	21.57	21.80
10	50	0		21.72	21.59	21.82
10	1	0	16-QAM	22.05	21.95	22.06
10	1	25		22.03	21.90	22.07
10	1	49		22.06	21.93	22.00
10	25	0		20.86	20.65	20.75
10	25	12		20.74	20.63	20.86
10	25	25		20.69	20.58	20.79
10	50	0		20.74	20.64	20.84
10	1	0	64-QAM	20.95	20.82	20.96
10	1	25		20.96	20.76	21.01
10	1	49		20.94	20.80	20.89
10	25	0		19.88	19.67	19.78
10	25	12		19.79	19.66	19.88
10	25	25		19.70	19.57	19.81
10	50	0		19.75	19.64	19.87



LTE Band 26 Maximum Average Power [dBm]						
BW [MHz]	RB Size	RB Offset	Mod	Lowest	Middle	Highest
5	1	0	QPSK	22.63	22.58	22.68
5	1	12		22.67	22.55	22.60
5	1	24		22.54	22.51	22.59
5	12	0		21.68	21.61	21.71
5	12	7		21.74	21.62	21.71
5	12	13		21.73	21.57	21.64
5	25	0		21.73	21.63	21.69
5	1	0	16-QAM	21.95	21.92	21.94
5	1	12		22.02	21.86	21.92
5	1	24		21.87	21.85	21.88
5	12	0		20.67	20.63	20.72
5	12	7		20.78	20.64	20.71
5	12	13		20.72	20.59	20.66
5	25	0		20.73	20.61	20.67
5	1	0	64-QAM	20.87	20.76	20.89
5	1	12		20.88	20.70	20.94
5	1	24		20.86	20.74	20.82
5	12	0		19.80	19.61	19.71
5	12	7		19.71	19.60	19.81
5	12	13		19.62	19.51	19.74
5	25	0		19.67	19.58	19.80
3	1	0	QPSK	22.60	22.58	22.72
3	1	8		22.58	22.54	22.70
3	1	14		22.65	22.52	22.69
3	8	0		21.66	21.60	21.80
3	8	4		21.68	21.61	21.81
3	8	7		21.72	21.55	21.78
3	15	0		21.64	21.59	21.78
3	1	0	16-QAM	21.92	21.89	22.03
3	1	8		21.93	21.91	22.05
3	1	14		22.00	21.83	21.98
3	8	0		20.70	20.64	20.83
3	8	4		20.72	20.65	20.86
3	8	7		20.78	20.62	20.83
3	15	0		20.65	20.59	20.81
3	1	0	64-QAM	20.85	20.71	20.95
3	1	8		20.76	20.76	20.92
3	1	14		20.86	20.68	20.92
3	8	0		19.68	19.64	19.79
3	8	4		19.70	19.64	19.82
3	8	7		19.75	19.61	19.78
3	15	0		19.66	19.63	19.81



LTE Band 26 Maximum Average Power [dBm]						
BW [MHz]	RB Size	RB Offset	Mod	Lowest	Middle	Highest
1.4	1	0	QPSK	22.54	22.51	22.65
1.4	1	3		22.63	22.57	22.72
1.4	1	5		22.54	22.49	22.65
1.4	3	0		22.60	22.54	22.70
1.4	3	1		22.65	22.60	22.75
1.4	3	3		22.61	22.56	22.71
1.4	6	0		21.58	21.54	21.69
1.4	1	0	16-QAM	21.88	21.81	21.93
1.4	1	3		21.96	21.88	22.02
1.4	1	5		21.88	21.79	21.95
1.4	3	0		21.63	21.60	21.76
1.4	3	1		21.68	21.63	21.79
1.4	3	3		21.64	21.55	21.72
1.4	6	0		20.68	20.62	20.80
1.4	1	0	64-QAM	20.74	20.69	20.88
1.4	1	3		20.79	20.72	20.93
1.4	1	5		20.70	20.69	20.85
1.4	3	0		20.75	20.70	20.87
1.4	3	1		20.81	20.75	20.91
1.4	3	3		20.78	20.70	20.86
1.4	6	0		19.62	19.56	19.71



LTE Band 41 Maximum Average Power [dBm]						
BW [MHz]	RB Size	RB Offset	Mod	Lowest	Middle	Highest
20	1	0	QPSK	21.93	21.89	21.99
20	1	49		21.86	21.80	21.82
20	1	99		21.73	21.70	21.83
20	50	0		20.94	20.91	20.96
20	50	24		20.91	20.91	20.87
20	50	50		20.87	20.72	20.84
20	100	0		20.92	20.88	20.85
20	1	0	16-QAM	21.03	21.05	21.10
20	1	49		20.93	20.95	20.88
20	1	99		20.93	20.80	20.90
20	50	0		20.06	19.94	19.96
20	50	24		19.97	19.92	19.88
20	50	50		20.05	19.78	19.85
20	100	0		20.05	19.91	19.86
20	1	0	64-QAM	19.81	19.65	19.76
20	1	49		19.69	19.56	19.52
20	1	99		19.63	19.45	19.56
20	50	0		19.05	18.91	18.94
20	50	24		19.04	18.91	18.85
20	50	50		19.02	18.75	18.86
20	100	0		19.05	18.90	18.89
15	1	0	QPSK	21.98	21.88	21.95
15	1	37		21.95	21.83	21.82
15	1	74		21.95	21.70	21.81
15	36	0		20.98	20.85	20.84
15	36	20		20.98	20.85	20.88
15	36	39		20.96	20.81	20.86
15	75	0		20.98	20.84	20.86
15	1	0	16-QAM	21.14	21.02	21.06
15	1	37		21.06	21.00	20.92
15	1	74		21.02	20.71	20.93
15	36	0		19.98	19.85	19.83
15	36	20		19.96	19.86	19.84
15	36	39		19.94	19.79	19.79
15	75	0		20.00	19.87	19.87
15	1	0	64-QAM	19.75	19.66	19.74
15	1	37		19.68	19.57	19.58
15	1	74		19.75	19.48	19.61
15	36	0		18.98	18.88	18.84
15	36	20		18.97	18.87	18.88
15	36	39		18.93	18.83	18.84
15	75	0		18.99	18.89	18.88



LTE Band 41 Maximum Average Power [dBm]						
BW [MHz]	RB Size	RB Offset	Mod	Lowest	Middle	Highest
10	1	0	QPSK	21.99	21.84	21.85
10	1	25		21.99	21.83	21.84
10	1	49		21.94	21.72	21.85
10	25	0		20.99	20.86	20.90
10	25	12		21.01	20.90	20.91
10	25	25		20.98	20.86	20.88
10	50	0		20.98	20.86	20.88
10	1	0	16-QAM	21.08	20.98	20.95
10	1	25		21.08	20.99	20.96
10	1	49		21.05	20.78	20.90
10	25	0		20.03	19.91	19.90
10	25	12		20.03	19.92	19.93
10	25	25		19.97	19.86	19.85
10	50	0		20.04	19.94	19.90
10	1	0	64-QAM	19.76	19.53	19.72
10	1	25		19.64	19.48	19.33
10	1	49		19.62	19.28	19.40
10	25	0		19.02	18.80	18.78
10	25	12		19.04	18.82	18.78
10	25	25		19.02	18.75	18.75
10	50	0		18.85	18.89	18.89
5	1	0	QPSK	21.87	21.84	21.88
5	1	12		21.86	21.83	21.88
5	1	24		21.80	21.82	21.82
5	12	0		20.88	20.89	20.90
5	12	7		20.90	20.91	20.94
5	12	13		20.89	20.85	20.90
5	25	0		20.88	20.89	20.91
5	1	0	16-QAM	20.97	20.91	20.92
5	1	12		20.97	20.85	20.96
5	1	24		20.98	20.94	20.98
5	12	0		19.91	19.91	19.89
5	12	7		19.90	19.89	19.93
5	12	13		19.89	19.89	19.88
5	25	0		19.93	19.89	19.94
5	1	0	64-QAM	19.68	19.45	19.71
5	1	12		19.58	19.47	19.52
5	1	24		19.48	19.36	19.49
5	12	0		19.00	18.75	18.84
5	12	7		18.84	18.83	18.66
5	12	13		19.00	18.61	18.68
5	25	0		18.88	18.83	18.80



LTE Band 66 Maximum Average Power [dBm]						
BW [MHz]	RB Size	RB Offset	Mod	Lowest	Middle	Highest
20	1	0	QPSK	22.73	22.99	22.96
20	1	49		22.55	22.71	22.60
20	1	99		22.55	22.66	22.51
20	50	0		21.68	21.84	21.86
20	50	24		21.62	21.77	21.72
20	50	50		21.60	21.70	21.61
20	100	0		21.64	21.76	21.71
20	1	0	16-QAM	22.10	22.28	22.27
20	1	49		21.90	22.05	21.93
20	1	99		21.90	21.95	21.86
20	50	0		20.67	20.85	20.90
20	50	24		20.63	20.77	20.68
20	50	50		20.60	20.70	20.61
20	100	0		20.62	20.76	20.67
20	1	0	64-QAM	20.94	21.19	21.14
20	1	49		20.75	20.90	20.80
20	1	99		20.75	20.84	20.72
20	50	0		19.71	19.86	19.89
20	50	24		19.65	19.77	19.69
20	50	50		19.61	19.74	19.64
20	100	0		19.63	19.76	19.72
15	1	0	QPSK	22.81	22.88	22.93
15	1	37		22.65	22.71	22.63
15	1	74		22.69	22.70	22.57
15	36	0		21.77	21.80	21.74
15	36	20		21.72	21.76	21.70
15	36	39		21.70	21.72	21.61
15	75	0		21.75	21.78	21.66
15	1	0	16-QAM	22.18	22.22	22.27
15	1	37		22.04	22.09	21.94
15	1	74		21.96	22.03	21.89
15	36	0		20.79	20.82	20.76
15	36	20		20.78	20.76	20.67
15	36	39		20.69	20.72	20.60
15	75	0		20.76	20.78	20.68
15	1	0	64-QAM	21.01	21.10	21.14
15	1	37		20.86	20.91	20.78
15	1	74		20.89	20.90	20.79
15	36	0		19.81	19.84	19.77
15	36	20		19.76	19.79	19.69
15	36	39		19.73	19.72	19.63
15	75	0		19.73	19.76	19.67



LTE Band 66 Maximum Average Power [dBm]						
BW [MHz]	RB Size	RB Offset	Mod	Lowest	Middle	Highest
10	1	0	QPSK	22.76	22.84	22.72
10	1	25		22.66	22.73	22.62
10	1	49		22.64	22.65	22.56
10	25	0		21.72	21.78	21.69
10	25	12		21.72	21.76	21.65
10	25	25		21.69	21.71	21.63
10	50	0		21.72	21.73	21.66
10	1	0	16-QAM	22.06	22.15	22.07
10	1	25		22.03	22.08	21.97
10	1	49		21.97	21.99	21.87
10	25	0		20.74	20.76	20.70
10	25	12		20.74	20.77	20.68
10	25	25		20.71	20.70	20.61
10	50	0		20.75	20.74	20.68
10	1	0	64-QAM	20.91	20.99	20.91
10	1	25		20.85	20.96	20.81
10	1	49		20.78	20.88	20.78
10	25	0		19.75	19.81	19.73
10	25	12		19.76	19.77	19.69
10	25	25		19.71	19.73	19.63
10	50	0		19.75	19.76	19.69
5	1	0	QPSK	22.58	22.74	22.68
5	1	12		22.55	22.72	22.60
5	1	24		22.54	22.68	22.57
5	12	0		21.58	21.74	21.65
5	12	7		21.60	21.75	21.68
5	12	13		21.53	21.71	21.61
5	25	0		21.56	21.75	21.64
5	1	0	16-QAM	21.93	22.14	22.02
5	1	12		21.88	22.03	21.95
5	1	24		21.87	22.04	21.91
5	12	0		20.61	20.76	20.68
5	12	7		20.61	20.77	20.66
5	12	13		20.54	20.74	20.62
5	25	0		20.55	20.74	20.65
5	1	0	64-QAM	20.78	20.95	20.88
5	1	12		20.70	20.91	20.82
5	1	24		20.70	20.95	20.79
5	12	0		19.60	19.79	19.70
5	12	7		19.62	19.78	19.71
5	12	13		19.59	19.77	19.67
5	25	0		19.56	19.74	19.65





LTE Band 66 Maximum Average Power [dBm]						
BW [MHz]	RB Size	RB Offset	Mod	Lowest	Middle	Highest
3	1	0	QPSK	22.56	22.69	22.61
3	1	8		22.52	22.67	22.62
3	1	14		22.52	22.64	22.58
3	8	0		21.53	21.70	21.63
3	8	4		21.56	21.73	21.65
3	8	7		21.54	21.67	21.64
3	15	0		21.54	21.70	21.64
3	1	0	16-QAM	21.88	22.08	21.92
3	1	8		21.87	22.03	21.93
3	1	14		21.84	22.04	21.89
3	8	0		20.60	20.77	20.68
3	8	4		20.62	20.81	20.71
3	8	7		20.58	20.74	20.67
3	15	0		20.57	20.72	20.65
3	1	0	64-QAM	20.75	20.88	20.80
3	1	8		20.68	20.89	20.78
3	1	14		20.70	20.84	20.75
3	8	0		19.57	19.75	19.68
3	8	4		19.60	19.77	19.70
3	8	7		19.56	19.71	19.63
3	15	0		19.54	19.71	19.64
1.4	1	0	QPSK	22.47	22.66	22.55
1.4	1	3		22.55	22.73	22.65
1.4	1	5		22.47	22.65	22.55
1.4	3	0		22.51	22.69	22.59
1.4	3	1		22.55	22.73	22.64
1.4	3	3		22.49	22.69	22.58
1.4	6	0		21.47	21.66	21.56
1.4	1	0	16-QAM	21.79	21.97	21.85
1.4	1	3		21.87	22.04	21.92
1.4	1	5		21.80	21.98	21.85
1.4	3	0		21.56	21.73	21.63
1.4	3	1		21.59	21.76	21.68
1.4	3	3		21.54	21.73	21.63
1.4	6	0		20.55	20.73	20.67
1.4	1	0	64-QAM	20.62	20.86	20.76
1.4	1	3		20.68	20.90	20.79
1.4	1	5		20.56	20.83	20.74
1.4	3	0		20.65	20.85	20.76
1.4	3	1		20.72	20.90	20.79
1.4	3	3		20.68	20.84	20.72
1.4	6	0		19.49	19.66	19.59



LTE Band 7_CA Maximum Average Power [dBm]								
BW [MHz]	PCC		SCC		Mod	Lowest	Middle	Highest
	RB Size	RB Offset	RB Size	RB Offset				
20+20	0	0	1	99	QPSK	24.37	24.37	24.47
20+20	1	0	0	0		24.96	24.90	<b>24.99</b>
20+20	100	0	0	0		23.85	23.75	23.87
20+20	100	0	100	0		22.79	23.21	24.15
20+20	1	0	1	99		19.41	19.58	19.44
20+20	1	0	1	0		19.96	20.00	19.94
20+20	1	99	1	0		24.23	24.41	24.18
20+20	100	0	1	99		20.95	20.98	20.88
20+20	0	0	1	99		23.85	23.80	23.85
20+20	1	0	0	0	16-QAM	24.36	24.42	24.29
20+20	100	0	0	0		22.83	22.92	22.90
20+20	100	0	100	0		22.34	22.40	23.65
20+20	1	0	1	99		19.61	19.58	19.42
20+20	1	0	1	0		19.99	19.97	19.89
20+20	1	99	1	0		23.94	23.76	23.68
20+20	100	0	1	99		20.77	20.85	20.70
20+20	0	0	1	99		22.79	22.70	22.77
20+20	1	0	0	0		23.27	23.22	23.28
20+20	100	0	0	0	64-QAM	21.91	21.88	21.94
20+20	100	0	100	0		21.20	21.37	20.30
20+20	1	0	1	99		18.16	18.27	18.34
20+20	1	0	1	0		18.68	18.69	18.59
20+20	1	99	1	0		20.21	20.52	20.32
20+20	100	0	1	99		20.90	20.97	20.97



LTE Band 7_CA Maximum Average Power [dBm]								
BW [MHz]	PCC		SCC		Mod	Lowest	Middle	Highest
	RB Size	RB Offset	RB Size	RB Offset				
20+15	100	0	75	0	QPSK	22.75	22.66	22.67
20+15	1	0	1	74		19.45	19.35	19.44
20+15	1	99	1	0		24.30	24.26	24.28
20+15	100	0	75	0	16-QAM	22.30	22.22	22.23
20+15	1	0	1	74		19.60	19.55	19.56
20+15	1	99	1	0		23.90	23.88	23.80
20+15	100	0	75	0	64-QAM	21.20	21.15	21.15
20+15	1	0	1	74		18.26	18.25	18.16
20+15	1	99	1	0		20.21	20.50	20.31
15+20	75	0	100	0	QPSK	22.72	22.59	22.58
15+20	1	0	1	99		19.41	19.28	19.36
15+20	1	74	1	0		24.27	24.20	24.19
15+20	75	0	100	0	16-QAM	22.25	22.13	22.23
15+20	1	0	1	99		19.54	19.46	19.50
15+20	1	74	1	0		23.80	23.80	23.71
15+20	75	0	100	0	64-QAM	21.20	21.15	21.09
15+20	1	0	1	99		18.19	18.24	18.09
15+20	1	74	1	0		20.22	20.45	20.36
20+10	100	0	50	0	QPSK	22.69	22.65	22.61
20+10	1	0	1	49		19.41	19.35	19.35
20+10	1	99	1	0		24.29	24.21	24.28
20+10	100	0	50	0	16-QAM	22.29	22.19	22.16
20+10	1	0	1	49		19.54	19.46	19.47
20+10	1	99	1	0		23.87	23.87	23.70
20+10	100	0	50	0	64-QAM	21.14	21.14	21.08
20+10	1	0	1	49		18.26	18.21	18.12
20+10	1	99	1	0		20.19	20.43	20.33



LTE Band 7_CA Maximum Average Power [dBm]								
BW [MHz]	PCC		SCC		Mod	Lowest	Middle	Highest
	RB Size	RB Offset	RB Size	RB Offset				
10+20	50	0	100	0	QPSK	22.65	22.58	22.64
10+20	1	0	1	99		19.45	19.29	19.44
10+20	1	49	1	0		24.24	24.18	24.24
10+20	50	0	100	0	16-QAM	22.28	22.22	22.13
10+20	1	0	1	99		19.55	19.52	19.54
10+20	1	49	1	0		23.86	23.79	23.72
10+20	50	0	100	0	64-QAM	21.14	21.07	21.13
10+20	1	0	1	99		18.23	18.23	18.16
10+20	1	49	1	0		20.22	20.49	20.29
15+15	75	0	75	0	QPSK	22.66	22.62	22.62
15+15	1	0	1	74		19.41	19.29	19.44
15+15	1	74	1	0		24.28	24.23	24.23
15+15	75	0	75	0	16-QAM	22.27	22.16	22.14
15+15	1	0	1	74		19.58	19.53	19.51
15+15	1	74	1	0		23.90	23.83	23.74
15+15	75	0	75	0	64-QAM	21.15	21.11	21.10
15+15	1	0	1	74		18.17	18.15	18.12
15+15	1	74	1	0		20.23	20.31	20.36
15+10	75	0	50	0	QPSK	22.69	22.60	22.63
15+10	1	0	1	49		19.37	19.27	19.42
15+10	1	74	1	0		24.23	24.19	24.20
15+10	75	0	50	0	16-QAM	22.24	22.22	22.20
15+10	1	0	1	49		19.57	19.55	19.55
15+10	1	74	1	0		23.88	23.84	23.77
15+10	75	0	50	0	64-QAM	21.10	21.14	21.11
15+10	1	0	1	49		18.21	18.15	18.15
15+10	1	74	1	0		20.36	20.33	20.26



LTE Band 41_CA Maximum Average Power [dBm]								
BW [MHz]	PCC		SCC		Mod	Lowest	Middle	Highest
	RB Size	RB Offset	RB Size	RB Offset				
20+20	0	0	1	99	QPSK	25.48	25.54	25.38
20+20	1	0	0	0		25.70	25.70	25.75
20+20	100	0	0	0		24.84	24.78	24.92
20+20	100	0	100	0		23.83	23.80	23.81
20+20	1	0	1	99		20.98	20.81	20.70
20+20	1	0	1	0		21.22	21.32	21.12
20+20	1	99	1	0		25.50	25.40	25.39
20+20	100	0	1	99		21.86	21.82	21.81
20+20	0	0	1	99		25.03	25.06	25.04
20+20	1	0	0	0	16-QAM	25.48	25.53	25.45
20+20	100	0	0	0		23.84	23.78	23.82
20+20	100	0	100	0		23.28	23.21	23.05
20+20	1	0	1	99		20.99	20.85	20.80
20+20	1	0	1	0		21.27	21.37	21.24
20+20	1	99	1	0		25.49	25.50	25.46
20+20	100	0	1	99		22.04	22.12	22.02
20+20	0	0	1	99		23.78	23.68	23.83
20+20	1	0	0	0		24.28	24.27	24.33
20+20	100	0	0	0	64-QAM	22.84	22.94	22.94
20+20	100	0	100	0		22.44	22.31	22.22
20+20	1	0	1	99		19.63	19.41	19.38
20+20	1	0	1	0		19.90	19.81	19.85
20+20	1	99	1	0		21.00	21.00	21.01
20+20	100	0	1	99		21.98	22.04	21.92



LTE Band 41_CA Maximum Average Power [dBm]								
BW [MHz]	PCC		SCC		Mod	Lowest	Middle	Highest
	RB Size	RB Offset	RB Size	RB Offset				
20+15	100	0	75	0	QPSK	23.83	23.79	23.73
20+15	1	0	1	74		21.02	20.97	20.99
20+15	1	99	1	0		25.43	25.33	25.33
20+15	100	0	75	0	16QAM	23.21	23.21	23.16
20+15	1	0	1	74		20.98	20.96	20.92
20+15	1	99	1	0		25.41	25.34	25.40
20+15	100	0	75	0	64QAM	22.41	22.31	22.33
20+15	1	0	1	74		19.61	19.51	19.55
20+15	1	99	1	0		21.00	21.02	21.06
15+20	75	0	100	0	QPSK	23.73	23.72	23.65
15+20	1	0	1	99		20.94	20.93	20.98
15+20	1	74	1	0		25.33	25.23	25.30
15+20	75	0	100	0	16QAM	23.12	23.18	23.16
15+20	1	0	1	99		20.89	20.90	20.92
15+20	1	74	1	0		25.32	25.34	25.36
15+20	75	0	100	0	64QAM	22.38	22.22	22.26
15+20	1	0	1	99		19.58	19.50	19.47
15+20	1	74	1	0		21.06	21.03	21.01
20+10	100	0	50	0	QPSK	23.78	23.70	23.64
20+10	1	0	1	49		20.97	20.95	20.94
20+10	1	99	1	0		25.34	25.23	25.24
20+10	100	0	50	0	16QAM	23.18	23.17	23.10
20+10	1	0	1	49		20.88	20.90	20.89
20+10	1	99	1	0		25.34	25.34	25.34
20+10	100	0	50	0	64QAM	22.39	22.28	22.31
20+10	1	0	1	49		19.59	19.42	19.46
20+10	1	99	1	0		21.03	21.05	21.08
10+20	50	0	100	0	QPSK	23.81	23.72	23.72
10+20	1	0	1	99		20.99	20.89	20.93
10+20	1	49	1	0		25.33	25.29	25.27
10+20	50	0	100	0	16QAM	23.18	23.11	23.11
10+20	1	0	1	99		20.88	20.96	20.92
10+20	1	49	1	0		25.32	25.33	25.35
10+20	50	0	100	0	64QAM	22.33	22.25	22.27
10+20	1	0	1	99		19.54	19.41	19.50
10+20	1	49	1	0		21.09	21.06	21.04



LTE Band 41_CA Maximum Average Power [dBm]								
BW [MHz]	PCC		SCC		Mod	Lowest	Middle	Highest
	RB Size	RB Offset	RB Size	RB Offset				
20+5	100	0	25	0	QPSK	23.83	23.77	23.66
20+5	1	0	1	24		21.02	20.93	20.93
20+5	1	99	1	0		25.41	25.24	25.30
20+5	100	0	25	0	16QAM	23.14	23.15	23.13
20+5	1	0	1	24		20.98	20.88	20.88
20+5	1	99	1	0		25.40	25.29	25.40
20+5	100	0	25	0	64QAM	22.41	22.25	22.25
20+5	1	0	1	24		19.53	19.46	19.49
20+5	1	99	1	0		21.05	21.06	21.04
5+20	25	0	100	0	QPSK	23.77	23.77	23.65
5+20	1	0	1	99		20.97	20.94	20.94
5+20	1	24	1	0		25.36	25.24	25.26
5+20	25	0	100	0	16QAM	23.17	23.21	23.10
5+20	1	0	1	99		20.95	20.87	20.84
5+20	1	24	1	0		25.38	25.30	25.31
5+20	25	0	100	0	64QAM	22.35	22.21	22.29
5+20	1	0	1	99		19.61	19.47	19.53
5+20	1	24	1	0		21.09	21.08	21.07
15+15	75	0	75	0	QPSK	23.73	23.79	23.64
15+15	1	0	1	74		20.93	20.87	20.91
15+15	1	74	1	0		25.39	25.25	25.25
15+15	75	0	75	0	16QAM	23.16	23.21	23.11
15+15	1	0	1	74		20.93	20.87	20.82
15+15	1	74	1	0		25.37	25.30	25.35
15+15	75	0	75	0	64QAM	22.35	22.22	22.27
15+15	1	0	1	74		19.60	19.43	19.52
15+15	1	74	1	0		21.05	21.06	21.07



## LTE Band 2

### Peak-to-Average Ratio

Mode	LTE Band 2 / 20MHz				
Mod.	QPSK		16QAM		Limit: 13dB
RB Size	1RB	Full RB	1RB	Full RB	Result
Lowest CH	4.43	5.07	5.01	6.14	<b>PASS</b>
Middle CH	4.9	5.25	5.83	6.23	
Highest CH	4.64	5.16	5.65	6.2	
Mode	LTE Band 2 / 20MHz				
Mod.	64QAM				Limit: 13dB
RB Size	1RB	Full RB			Result
Lowest CH	6.64	6.52			<b>PASS</b>
Middle CH	6.78	6.64			
Highest CH	6.32	6.58			





LTE Band 2 / 20MHz / QPSK

Lowest Channel / 1RB

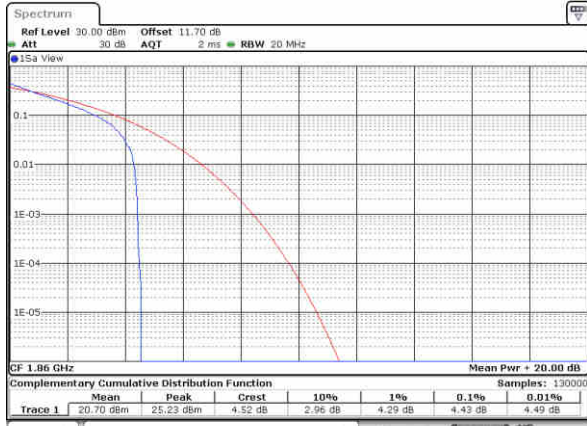

Date: 30 SEP 2017 18:10:29

Lowest Channel / Full RB

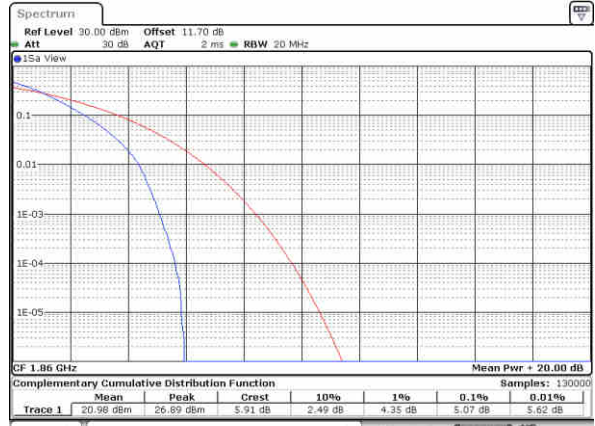

Date: 30 SEP 2017 18:10:44

Middle Channel / 1RB

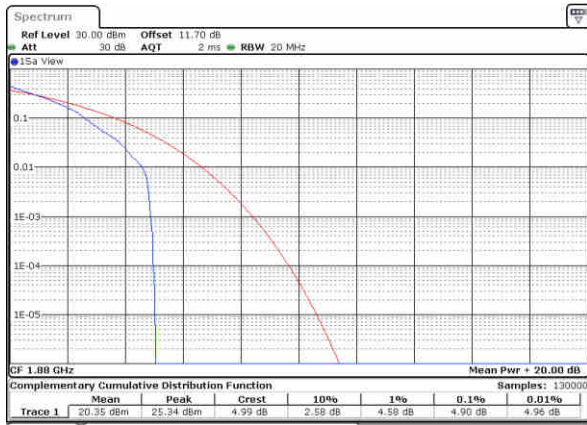

Date: 30 SEP 2017 18:10:53

Middle Channel / Full RB

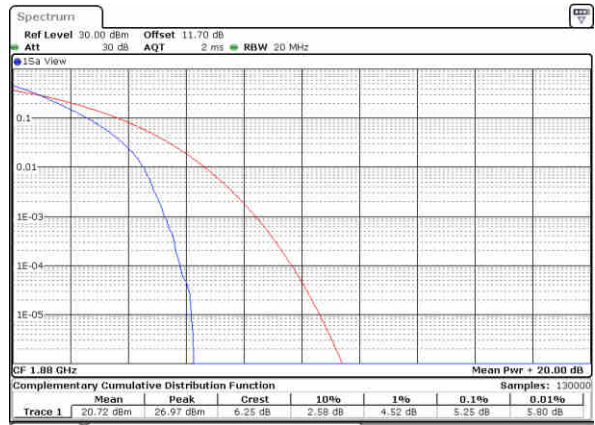

Date: 30 SEP 2017 18:11:02

Highest Channel / 1RB

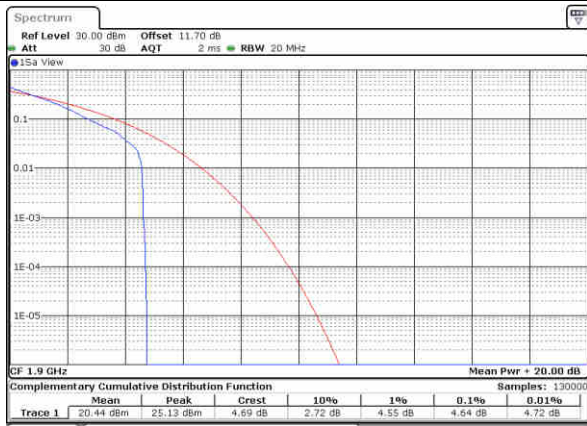

Date: 30 SEP 2017 18:11:26

Highest Channel / Full RB

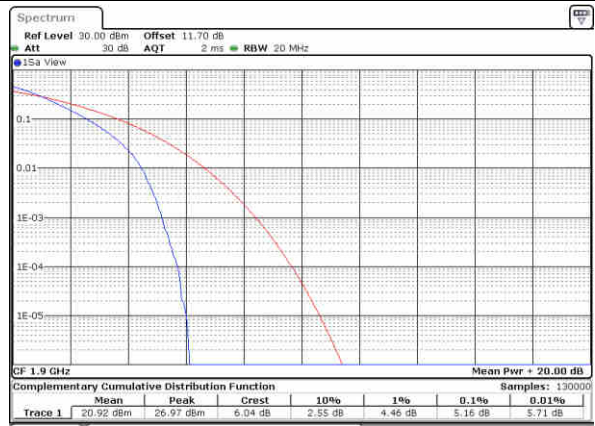

Date: 30 SEP 2017 18:11:38



LTE Band 2 / 20MHz / 16QAM

Lowest Channel / 1RB



Date: 30 SEP 2017 18:09:10

Lowest Channel / Full RB

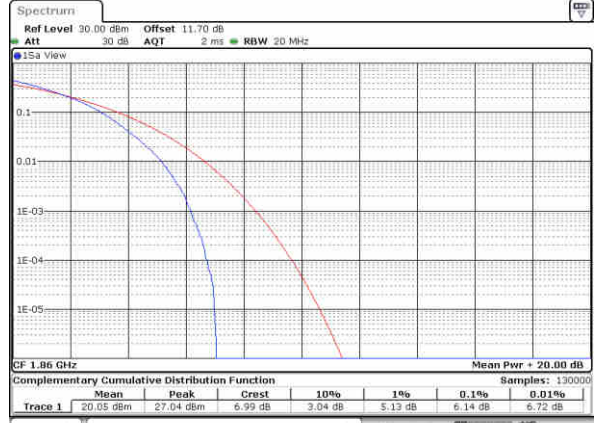

Date: 30 SEP 2017 18:09:27

Middle Channel / 1RB

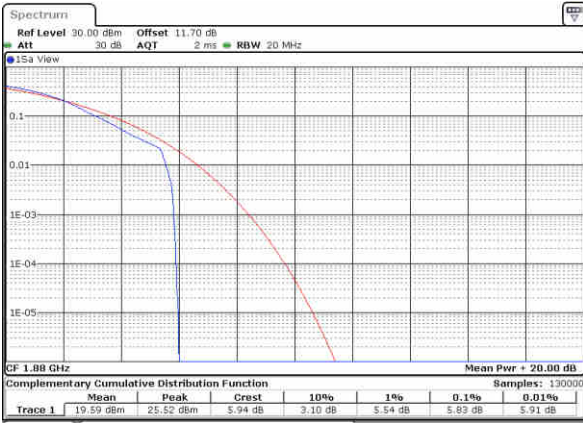

Date: 30 SEP 2017 18:09:41

Middle Channel / Full RB

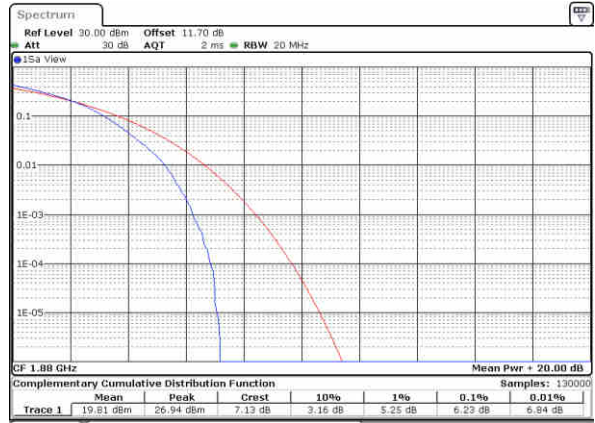

Date: 30 SEP 2017 18:09:50

Highest Channel / 1RB



Date: 30 SEP 2017 18:09:59

Highest Channel / Full RB

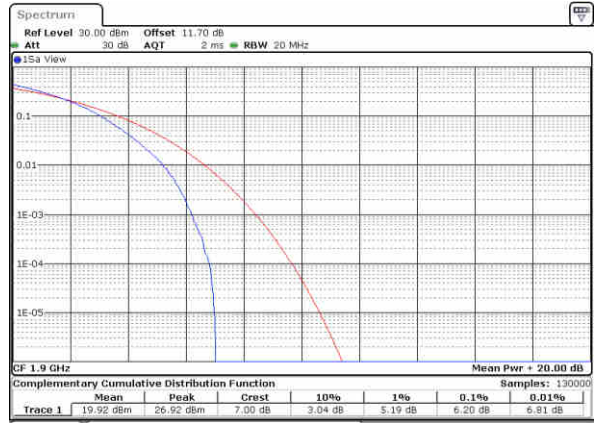

Date: 30 SEP 2017 18:10:14



LTE Band 2 / 20MHz / 64QAM

Lowest Channel / 1RB

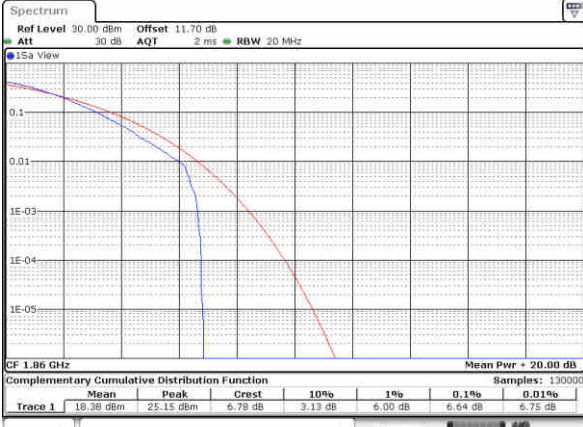

Date: 30 SEP 2017 18:11:47

Lowest Channel / Full RB

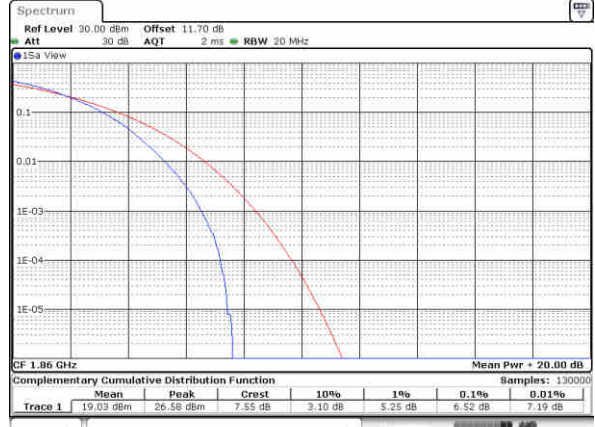

Date: 30 SEP 2017 18:11:56

Middle Channel / 1RB



Date: 30 SEP 2017 18:12:05

Middle Channel / Full RB

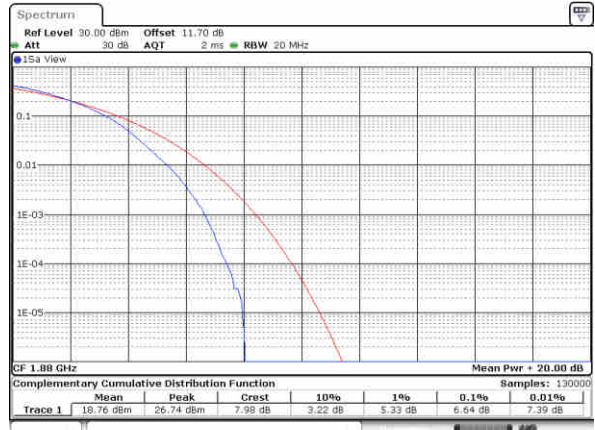

Date: 30 SEP 2017 18:12:22

Highest Channel / 1RB

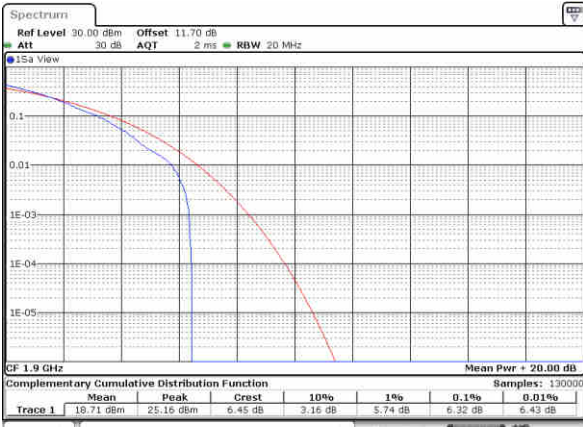

Date: 30 SEP 2017 18:12:51

Highest Channel / Full RB

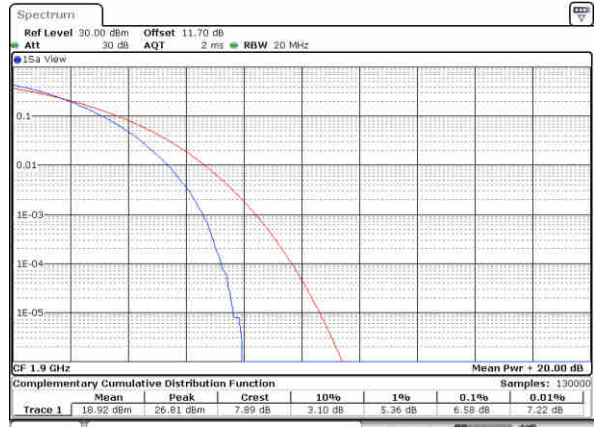

Date: 30 SEP 2017 18:13:26



**26dB Bandwidth**

Mode	LTE Band 2 : 26dB BW(MHz)											
BW	1.4MHz		3MHz		5MHz		10MHz		15MHz		20MHz	
Mod.	QPSK	16QAM	QPSK	16QAM	QPSK	16QAM	QPSK	16QAM	QPSK	16QAM	QPSK	16QAM
Lowest CH	1.25	1.23	3.02	3.03	4.97	4.99	9.79	9.65	14.12	14.21	20.14	20.22
Middle CH	1.23	1.23	3.05	3.02	4.87	4.92	9.69	9.89	14.45	14.36	20.10	20.22
Highest CH	1.23	1.23	3.06	3.06	4.94	4.87	9.65	9.83	14.66	14.36	20.18	20.14
Mode	LTE Band 2 : 26dB BW(MHz)											
BW	1.4MHz		3MHz		5MHz		10MHz		15MHz		20MHz	
Mod.	64QAM		64QAM		64QAM		64QAM		64QAM		64QAM	
Lowest CH	1.23	-	3.03	-	4.91	-	9.81	-	14.54	-	20.18	-
Middle CH	1.23	-	3	-	4.91	-	9.83	-	14.54	-	20.22	-
Highest CH	1.23	-	3.01	-	4.86	-	9.89	-	14.21	-	20.06	-



LTE Band 2

Lowest Channel / 1.4MHz / QPSK

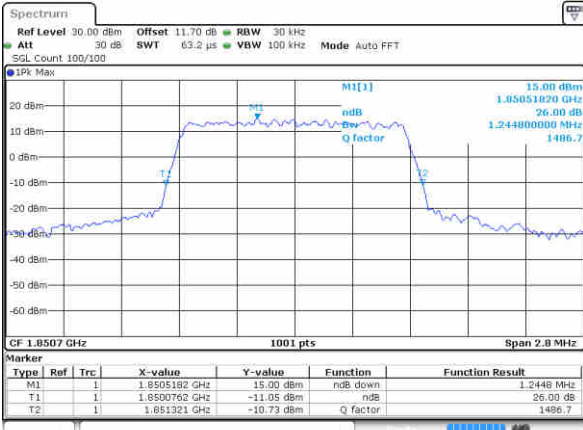

Date: 30 SEP 2017 17:52:37

Lowest Channel / 1.4MHz / 16QAM

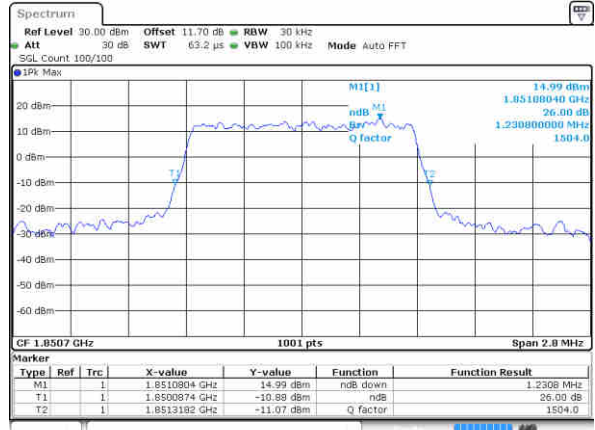

Date: 30 SEP 2017 17:52:47

Middle Channel / 1.4MHz / QPSK

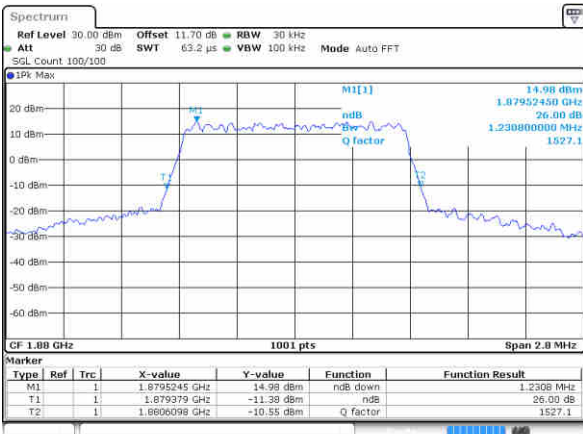

Date: 30 SEP 2017 17:59:40

Middle Channel / 1.4MHz / 16QAM

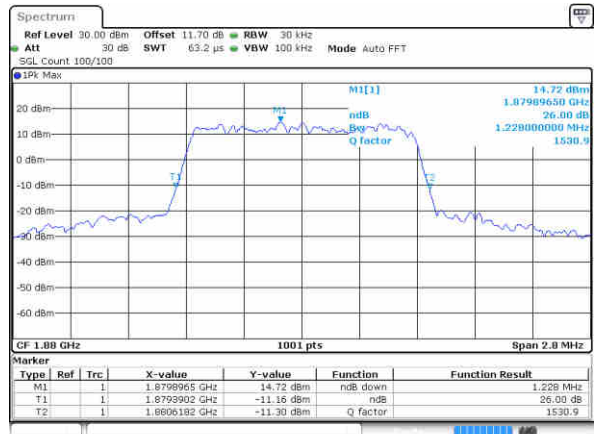

Date: 30 SEP 2017 17:59:50

Highest Channel / 1.4MHz / QPSK

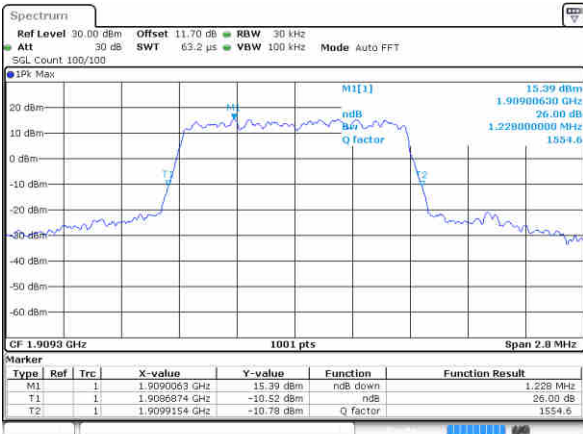

Date: 30 SEP 2017 18:02:08

Highest Channel / 1.4MHz / 16QAM



Date: 30 SEP 2017 18:02:18





LTE Band 2

Lowest Channel / 3MHz / QPSK

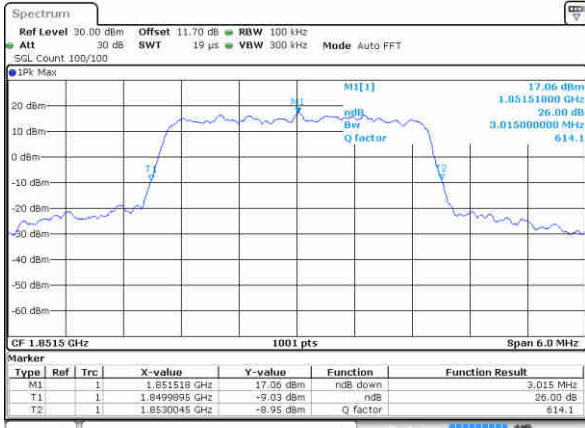

Date: 30 SEP 2017 15:40:39

Lowest Channel / 3MHz / 16QAM

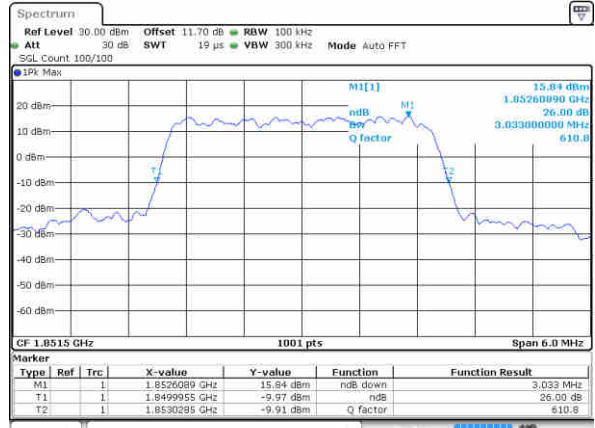

Date: 30 SEP 2017 15:40:49

Middle Channel / 3MHz / QPSK

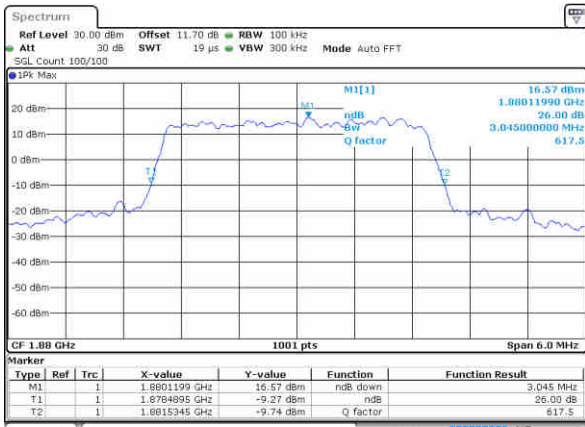

Date: 30 SEP 2017 15:47:42

Middle Channel / 3MHz / 16QAM

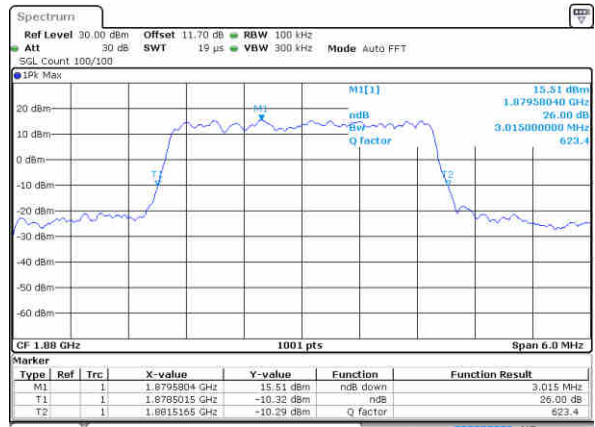

Date: 30 SEP 2017 15:47:52

Highest Channel / 3MHz / QPSK

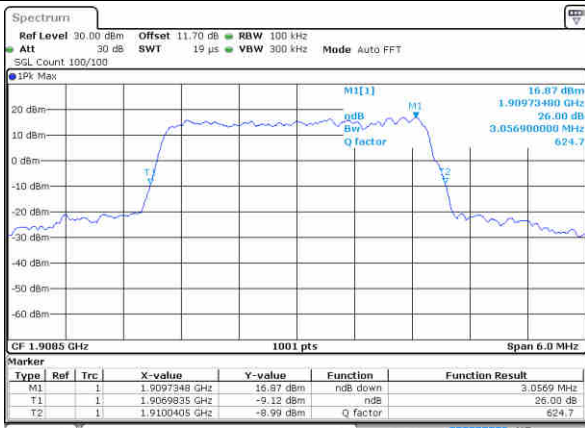

Date: 30 SEP 2017 15:50:10

Highest Channel / 3MHz / 16QAM

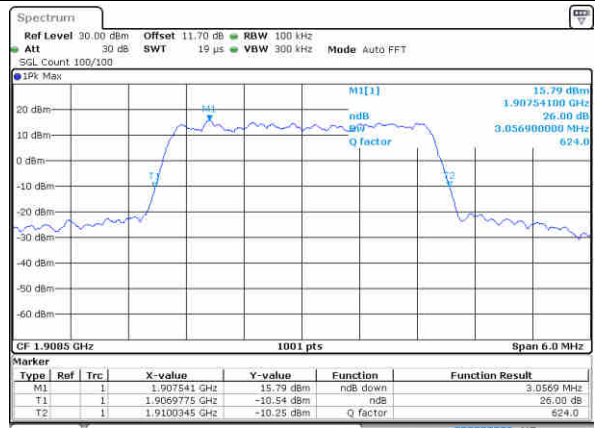

Date: 30 SEP 2017 15:50:20



LTE Band 2

Lowest Channel / 5MHz / QPSK

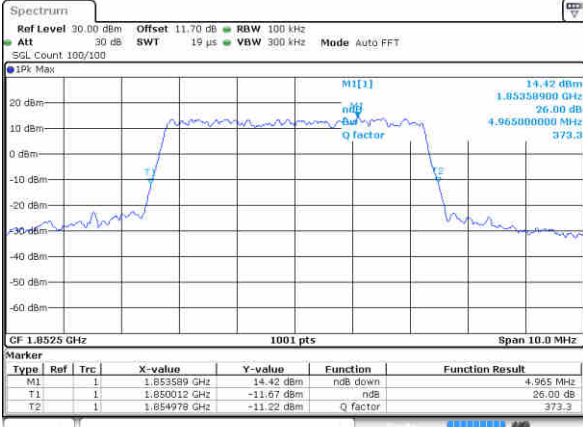

Date: 30 SEP 2017 15:57:13

Lowest Channel / 5MHz / 16QAM

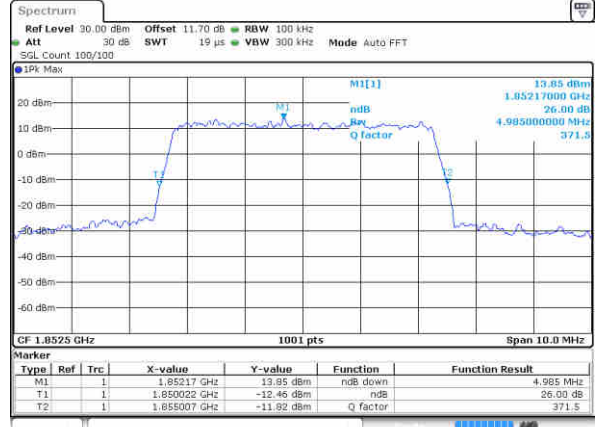

Date: 30 SEP 2017 15:57:23

Middle Channel / 5MHz / QPSK

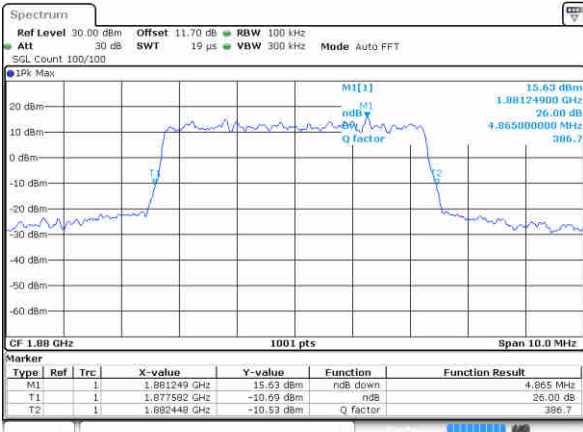

Date: 30 SEP 2017 16:04:16

Middle Channel / 5MHz / 16QAM

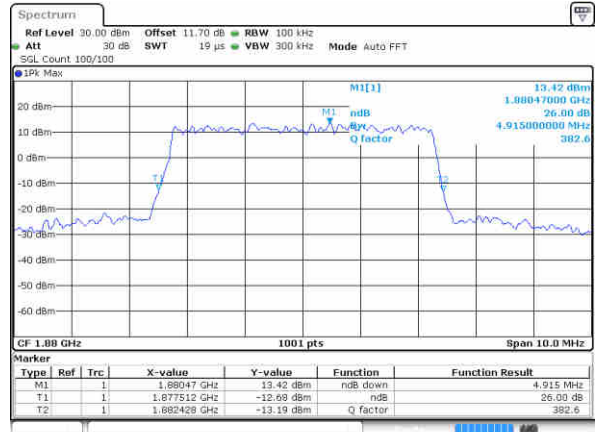

Date: 30 SEP 2017 16:04:26

Highest Channel / 5MHz / QPSK

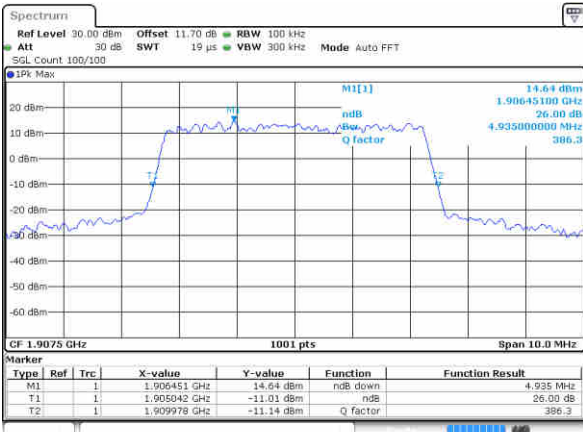

Date: 30 SEP 2017 16:06:44

Highest Channel / 5MHz / 16QAM

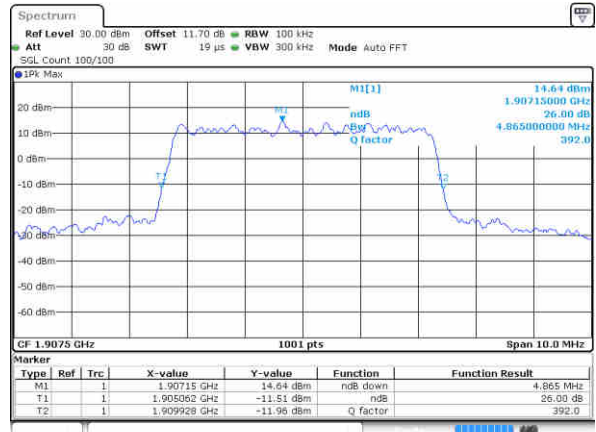

Date: 30 SEP 2017 16:06:54



LTE Band 2

Lowest Channel / 10MHz / QPSK

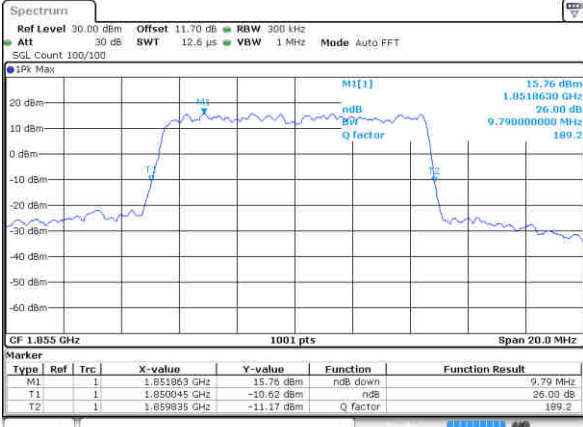

Date: 30 SEP 2017 16:13:47

Lowest Channel / 10MHz / 16QAM

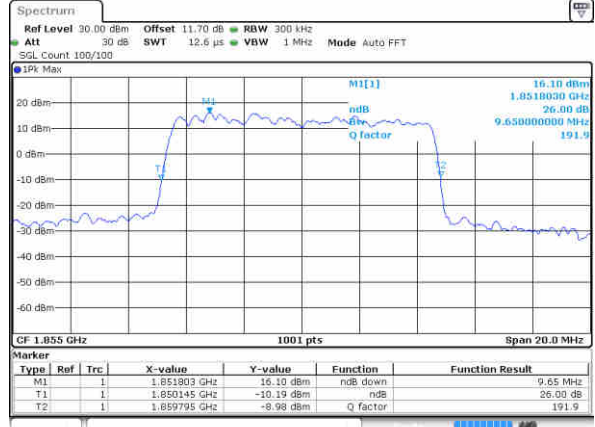

Date: 30 SEP 2017 16:13:57

Middle Channel / 10MHz / QPSK



Date: 30 SEP 2017 16:20:50

Middle Channel / 10MHz / 16QAM

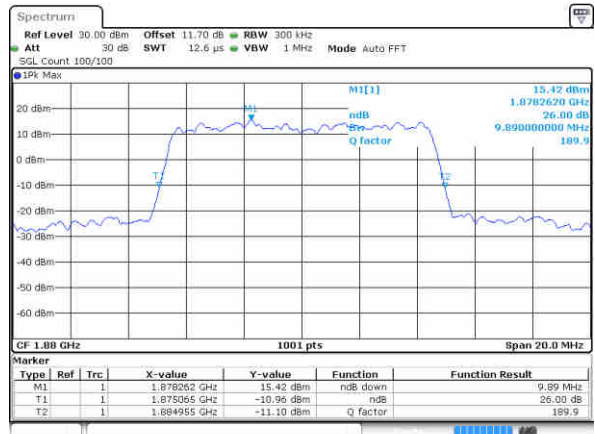

Date: 30 SEP 2017 16:21:00

Highest Channel / 10MHz / QPSK

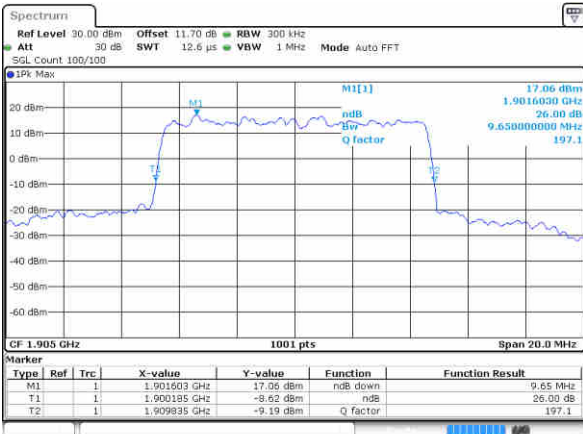

Date: 30 SEP 2017 16:23:18

Highest Channel / 10MHz / 16QAM

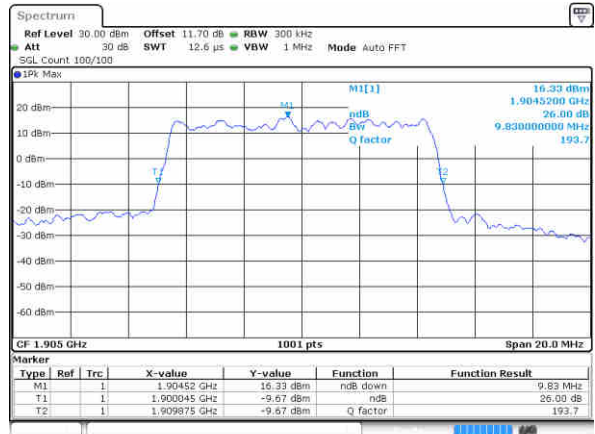

Date: 30 SEP 2017 16:23:28





LTE Band 2

Lowest Channel / 15MHz / QPSK

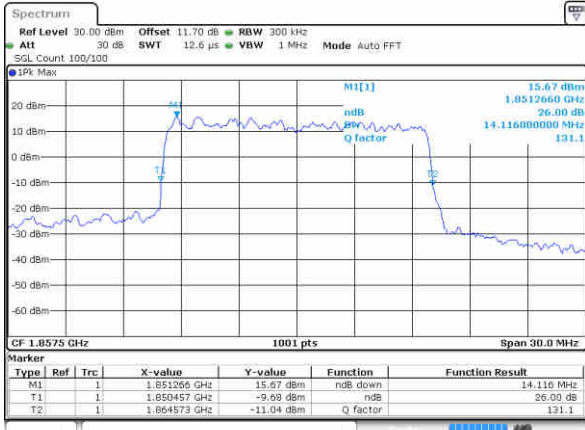

Date: 30 SEP 2017 16:30:21

Lowest Channel / 15MHz / 16QAM

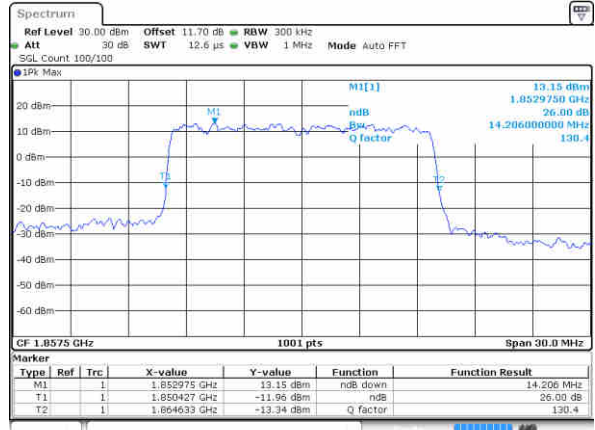

Date: 30 SEP 2017 16:30:31

Middle Channel / 15MHz / QPSK

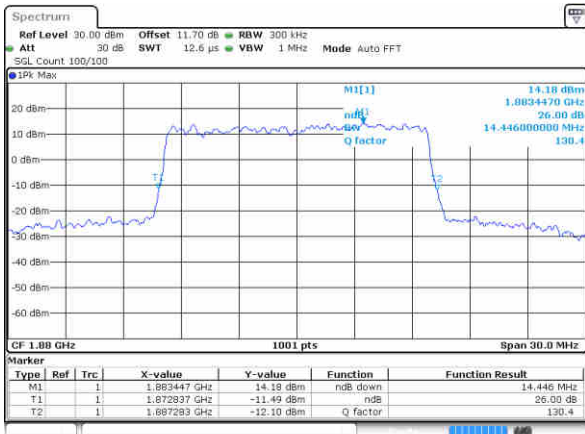

Date: 30 SEP 2017 16:37:23

Middle Channel / 15MHz / 16QAM

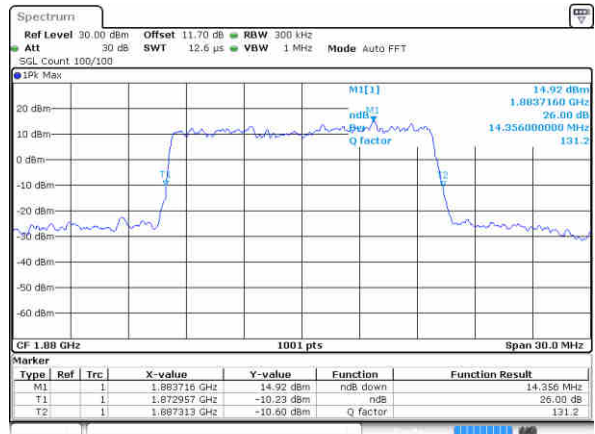

Date: 30 SEP 2017 16:37:33

Highest Channel / 15MHz / QPSK

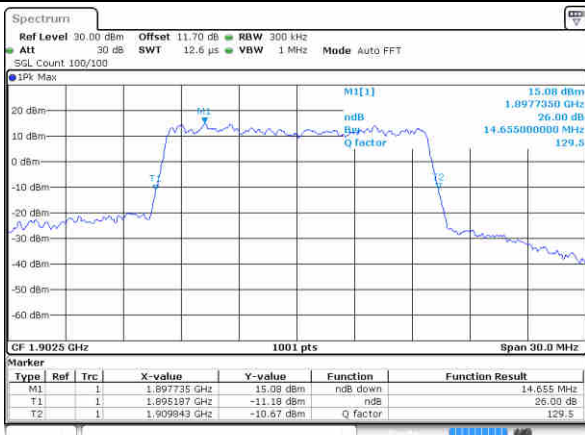

Date: 30 SEP 2017 16:39:51

Highest Channel / 15MHz / 16QAM



Date: 30 SEP 2017 16:40:01



LTE Band 2

Lowest Channel / 20MHz / QPSK

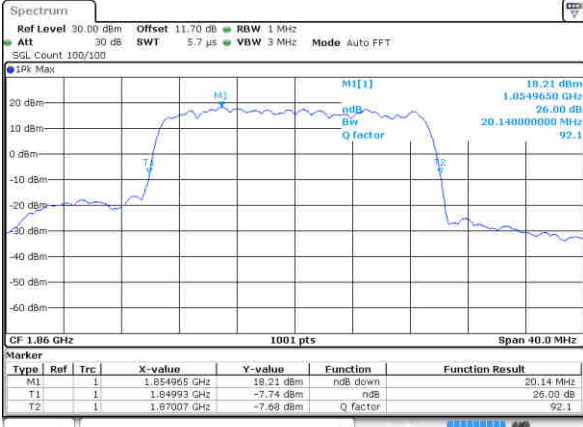

Date: 30 SEP 2017 16:46:54

Lowest Channel / 20MHz / 16QAM

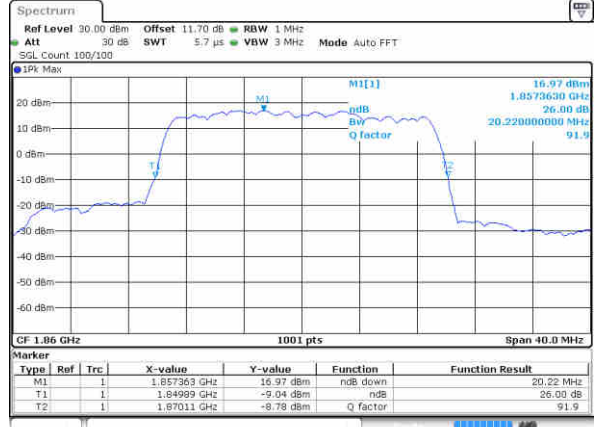

Date: 30 SEP 2017 16:47:04

Middle Channel / 20MHz / QPSK

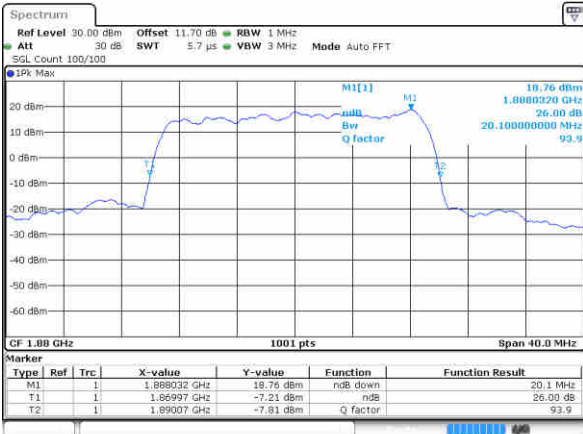

Date: 30 SEP 2017 16:53:57

Middle Channel / 20MHz / 16QAM

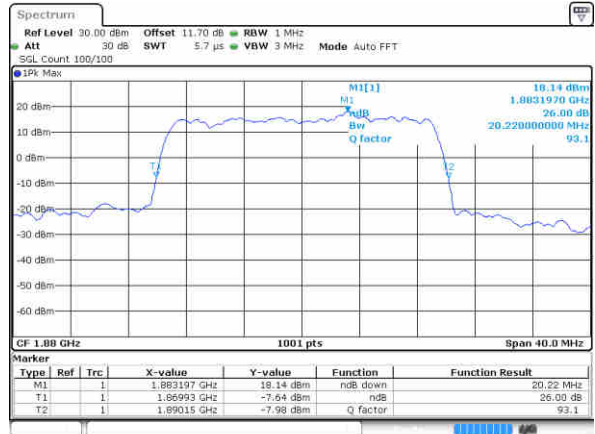

Date: 30 SEP 2017 16:54:07

Highest Channel / 20MHz / QPSK

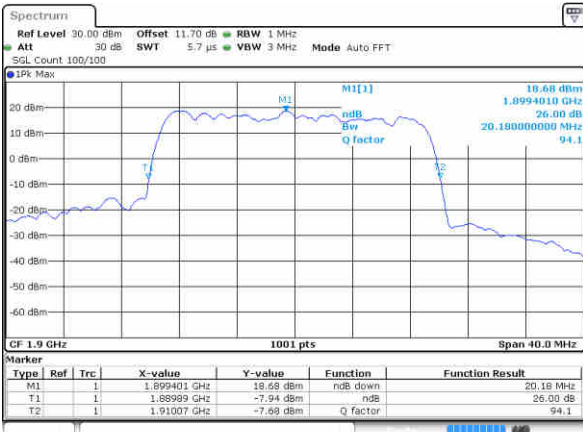

Date: 30 SEP 2017 16:56:25

Highest Channel / 20MHz / 16QAM

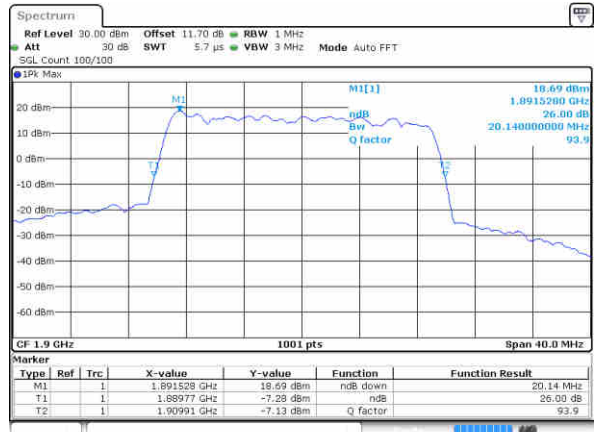

Date: 30 SEP 2017 16:56:35



LTE Band 2

Lowest Channel / 1.4MHz / 64QAM

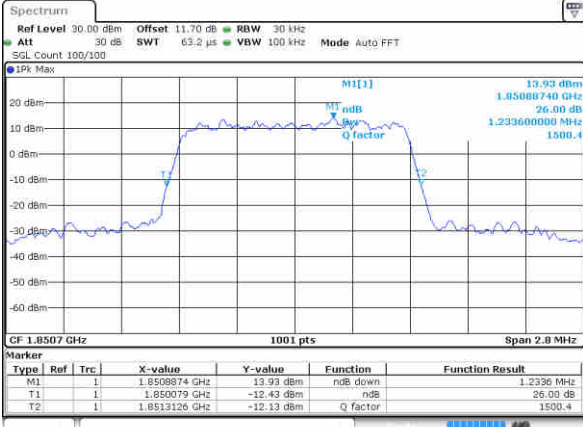

Date: 30 SEP 2017 17:44:11

Lowest Channel / 3MHz / 64QAM

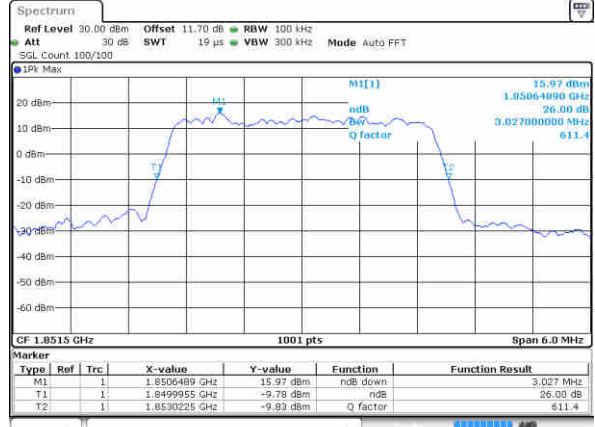

Date: 30 SEP 2017 17:03:17

Middle Channel / 1.4MHz / 64QAM

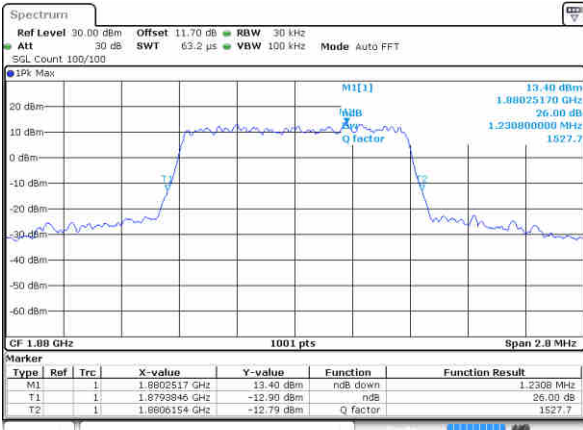

Date: 30 SEP 2017 17:47:42

Middle Channel / 3MHz / 64QAM

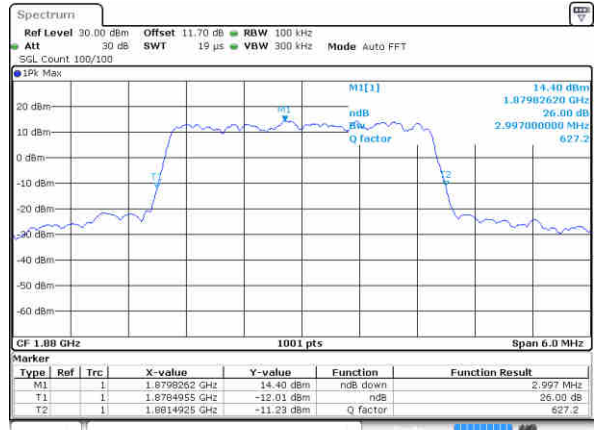

Date: 30 SEP 2017 17:08:49

Highest Channel / 1.4MHz / 64QAM

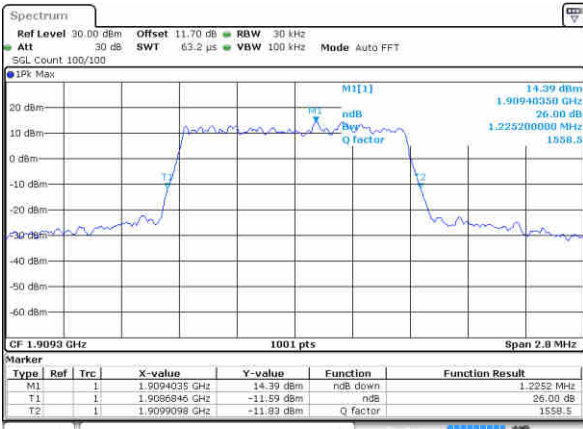

Date: 30 SEP 2017 17:48:56

Highest Channel / 3MHz / 64QAM

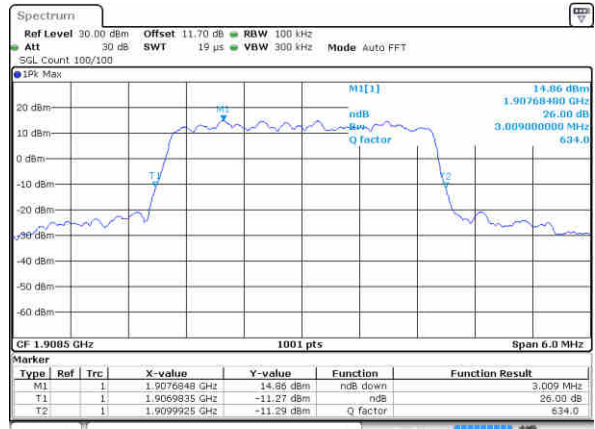

Date: 30 SEP 2017 17:08:03



LTE Band 2

Lowest Channel / 5MHz / 64QAM

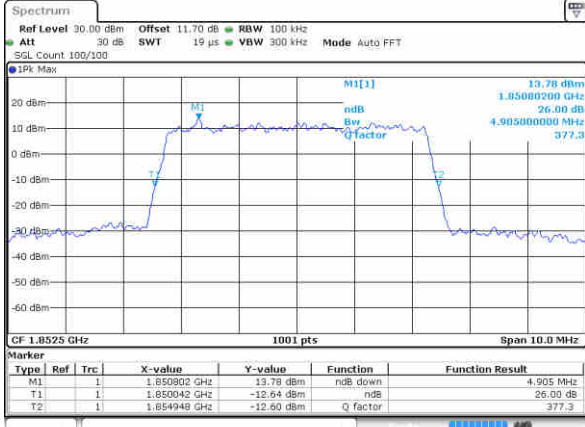

Date: 30 SEP 2017 17:11:34

Lowest Channel / 10MHz / 64QAM

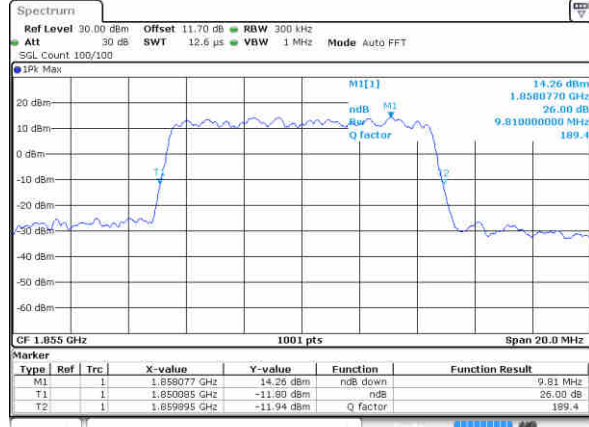

Date: 30 SEP 2017 17:19:51

Middle Channel / 5MHz / 64QAM

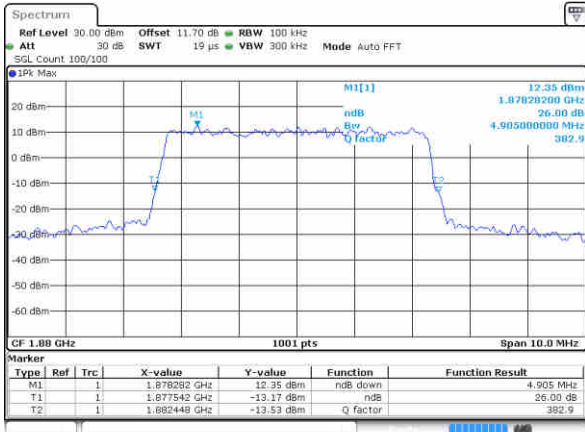

Date: 30 SEP 2017 17:15:06

Middle Channel / 10MHz / 64QAM

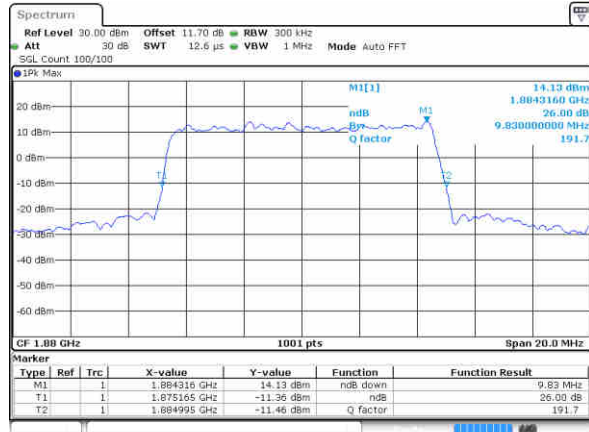

Date: 30 SEP 2017 17:23:23

Highest Channel / 5MHz / 64QAM

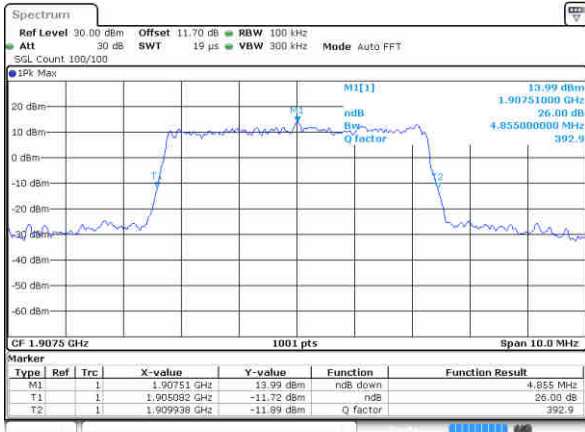

Date: 30 SEP 2017 17:16:20

Highest Channel / 10MHz / 64QAM

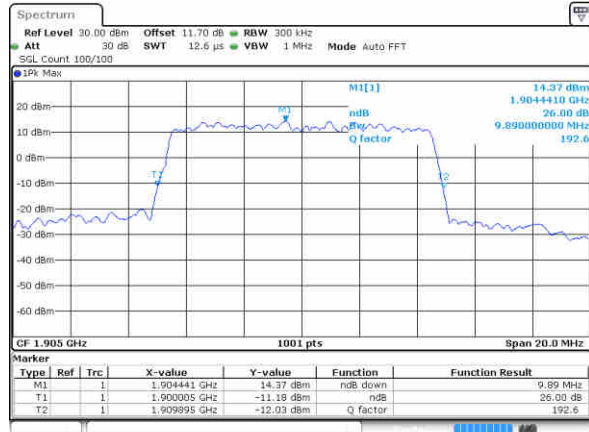

Date: 30 SEP 2017 17:24:37



LTE Band 2

Lowest Channel / 15MHz / 64QAM

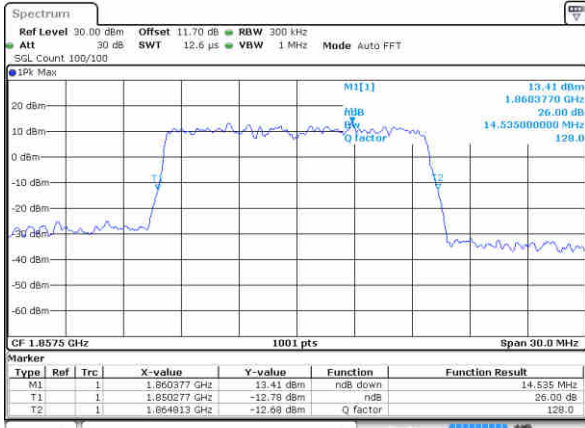

Date: 30 SEP 2017 17:28:08

Lowest Channel / 20MHz / 64QAM

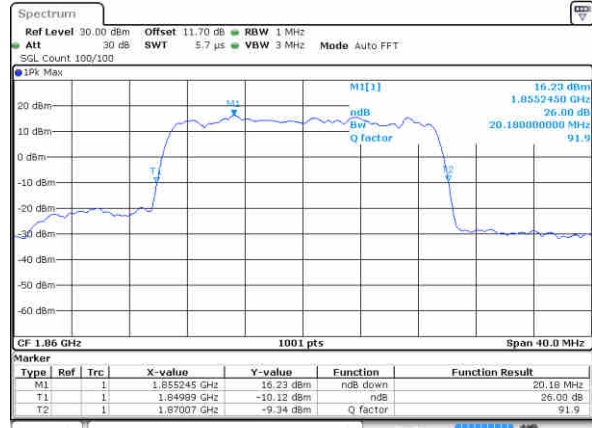

Date: 30 SEP 2017 17:38:25

Middle Channel / 15MHz / 64QAM

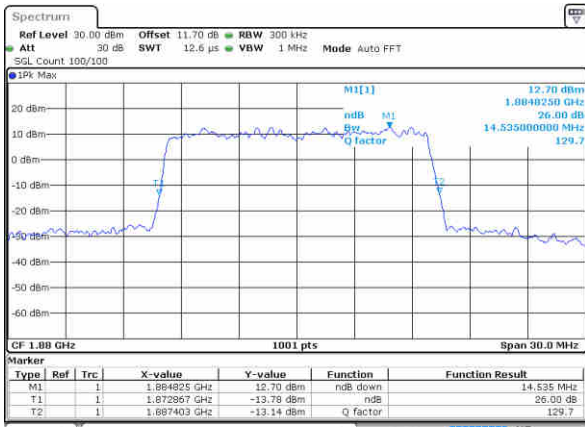

Date: 30 SEP 2017 17:31:40

Middle Channel / 20MHz / 64QAM

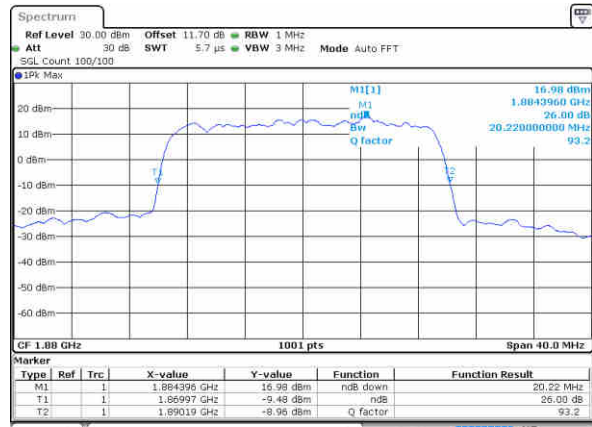

Date: 30 SEP 2017 17:39:56

Highest Channel / 15MHz / 64QAM

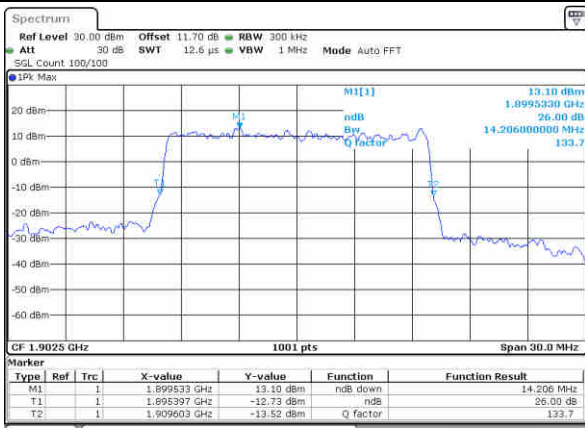

Date: 30 SEP 2017 17:32:54

Highest Channel / 20MHz / 64QAM

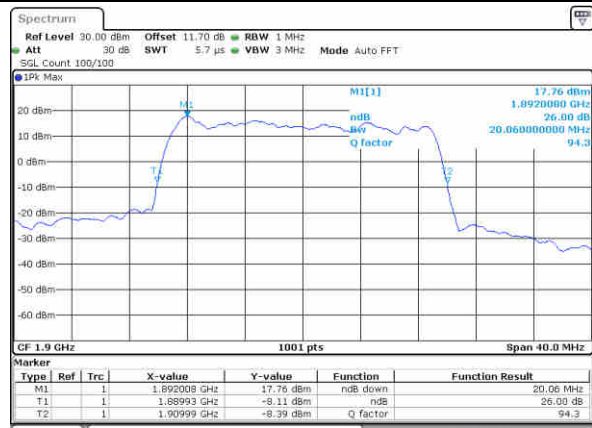

Date: 30 SEP 2017 18:13:52



**Occupied Bandwidth**

Mode	LTE Band 2 : 99%OBW(MHz)											
BW	1.4MHz		3MHz		5MHz		10MHz		15MHz		20MHz	
Mod.	QPSK	16QAM	QPSK	16QAM	QPSK	16QAM	QPSK	16QAM	QPSK	16QAM	QPSK	16QAM
Lowest CH	1.09	1.1	2.72	2.72	4.5	4.5	9.03	9.03	13.4	13.46	18.3	18.38
Middle CH	1.09	1.1	2.73	2.72	4.49	4.52	9.01	9.01	13.4	13.46	18.5	18.26
Highest CH	1.09	1.09	2.73	2.7	4.51	4.49	9.03	9.03	13.46	13.43	18.3	18.46
Mode	LTE Band 2 : 99%OBW(MHz)											
BW	1.4MHz		3MHz		5MHz		10MHz		15MHz		20MHz	
Mod.	64QAM		64QAM		64QAM		64QAM		64QAM		64QAM	
Lowest CH	1.1	-	2.72	-	4.49	-	9.01	-	13.4	-	18.26	-
Middle CH	1.09	-	2.72	-	4.51	-	9.09	-	13.43	-	18.34	-
Highest CH	1.09	-	2.72	-	4.5	-	9.05	-	13.49	-	18.34	-





LTE Band 2

Lowest Channel / 1.4MHz / QPSK

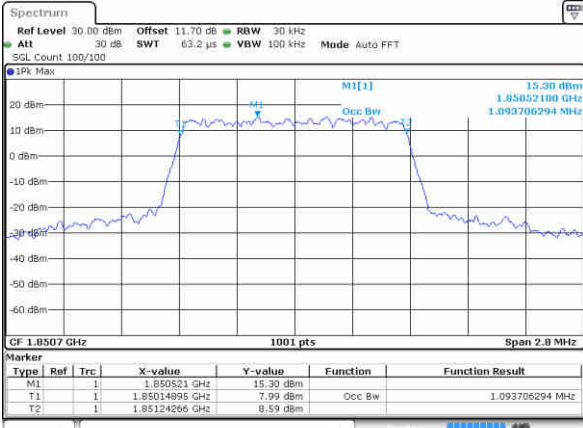

Date: 30 SEP 2017 17:52:17

Lowest Channel / 1.4MHz / 16QAM

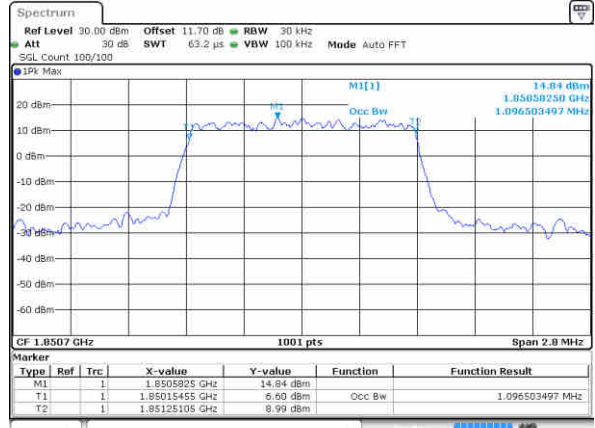

Date: 30 SEP 2017 17:52:27

Middle Channel / 1.4MHz / QPSK

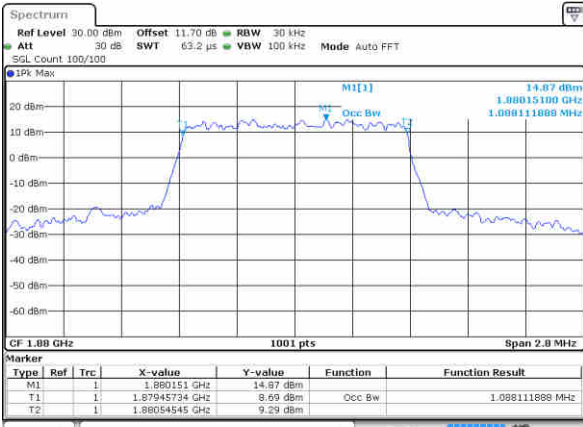

Date: 30 SEP 2017 17:59:20

Middle Channel / 1.4MHz / 16QAM

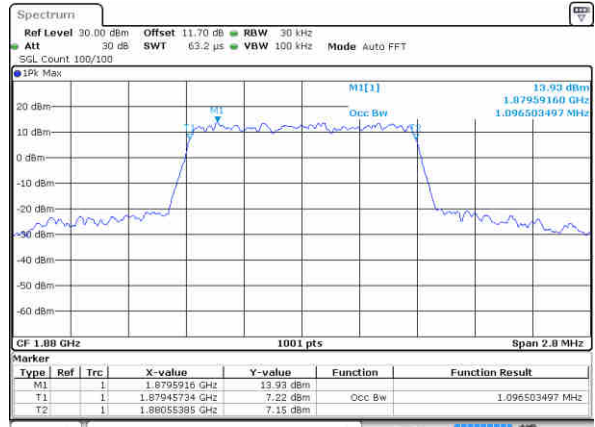

Date: 30 SEP 2017 17:59:30

Highest Channel / 1.4MHz / QPSK

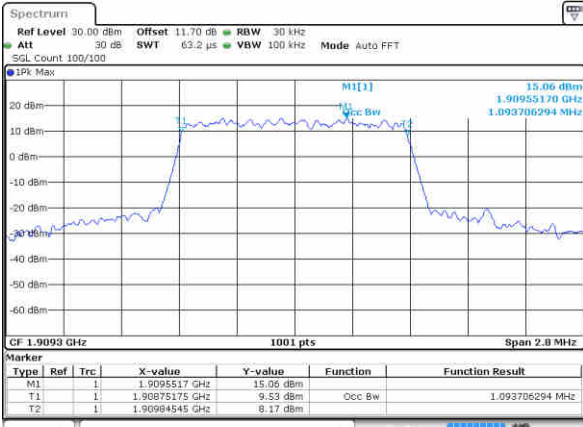

Date: 30 SEP 2017 18:01:45

Highest Channel / 1.4MHz / 16QAM

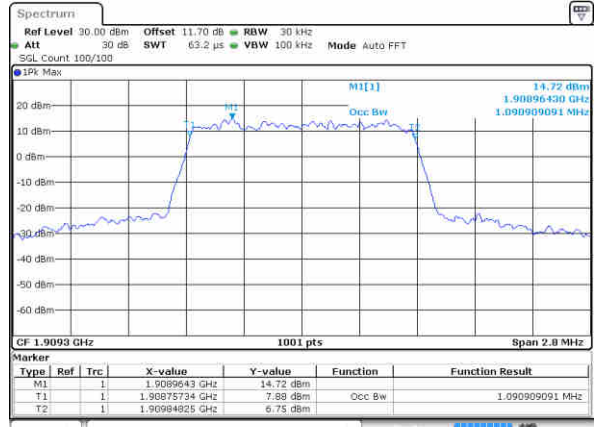

Date: 30 SEP 2017 18:01:56



LTE Band 2

Lowest Channel / 3MHz / QPSK

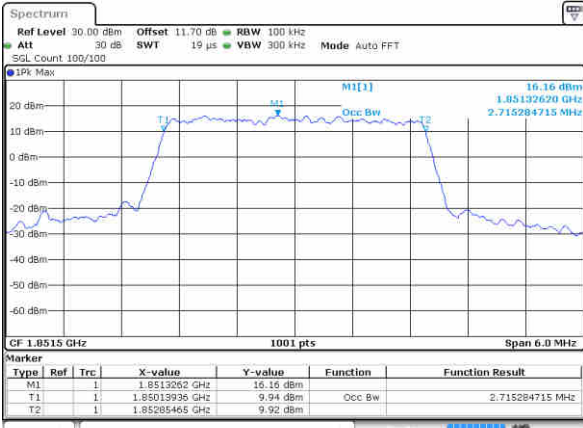

Date: 30 SEP 2017 15:40:19

Lowest Channel / 3MHz / 16QAM

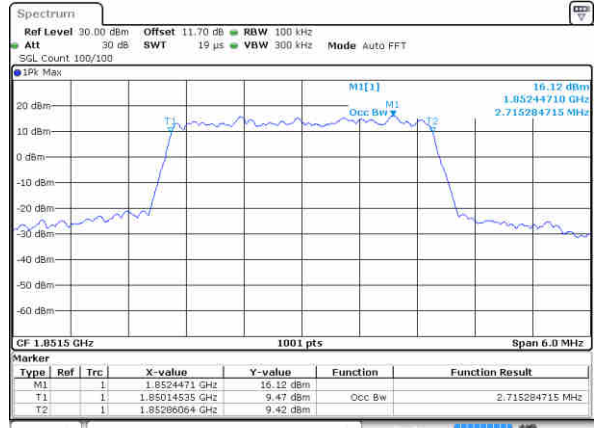

Date: 30 SEP 2017 15:40:29

Middle Channel / 3MHz / QPSK

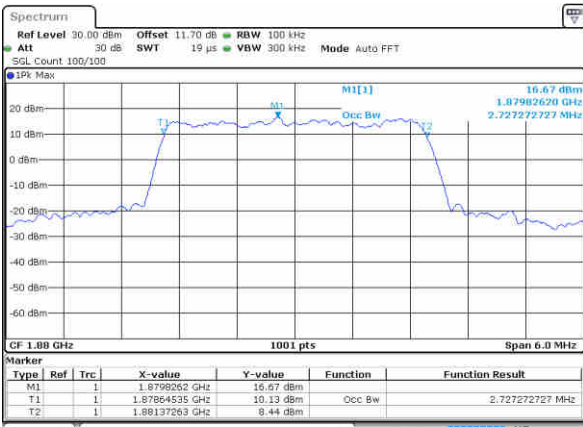

Date: 30 SEP 2017 15:47:22

Middle Channel / 3MHz / 16QAM

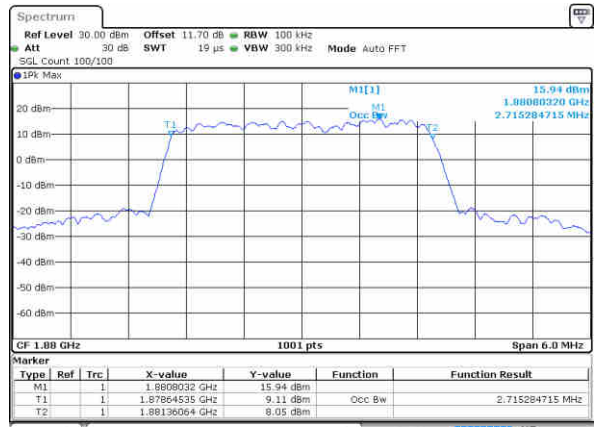

Date: 30 SEP 2017 15:47:32

Highest Channel / 3MHz / QPSK

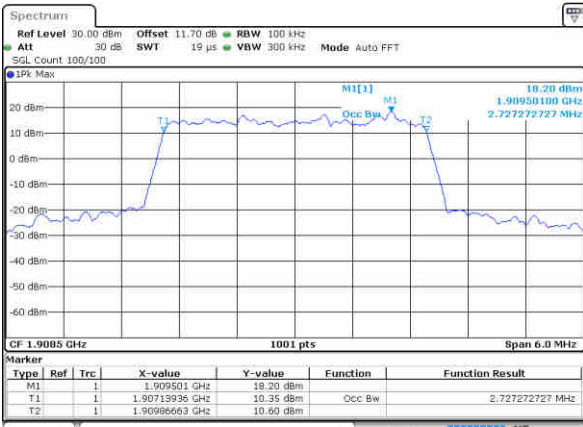

Date: 30 SEP 2017 15:49:50

Highest Channel / 3MHz / 16QAM

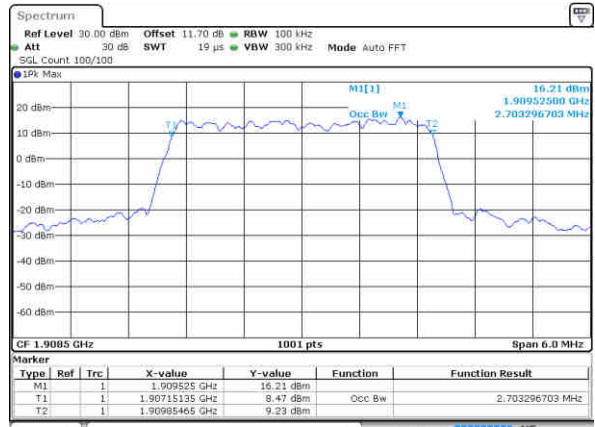

Date: 30 SEP 2017 15:50:00





LTE Band 2

Lowest Channel / 5MHz / QPSK

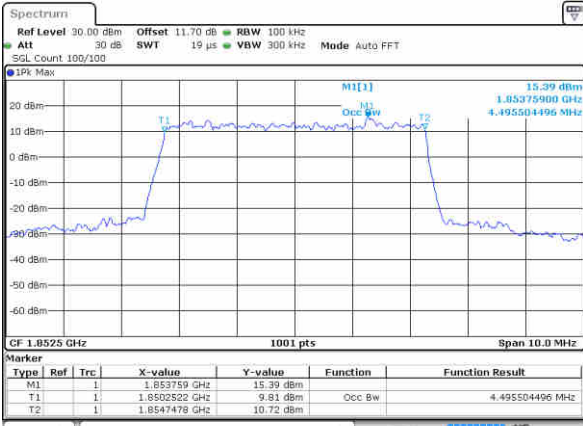

Date: 30 SEP 2017 15:56:53

Lowest Channel / 5MHz / 16QAM

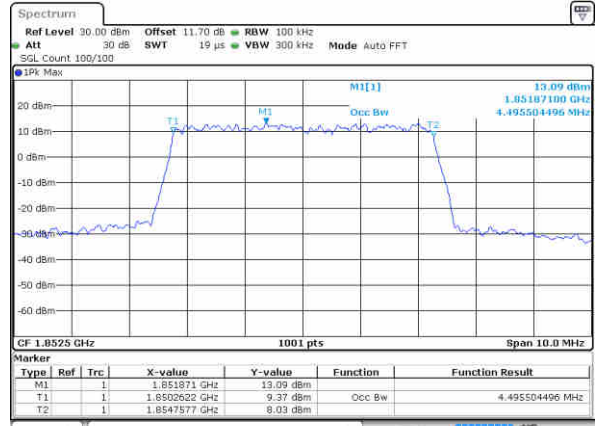

Date: 30 SEP 2017 15:57:03

Middle Channel / 5MHz / QPSK

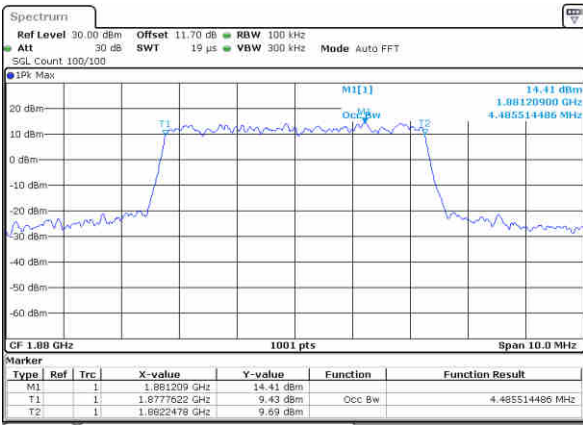

Date: 30 SEP 2017 16:03:56

Middle Channel / 5MHz / 16QAM

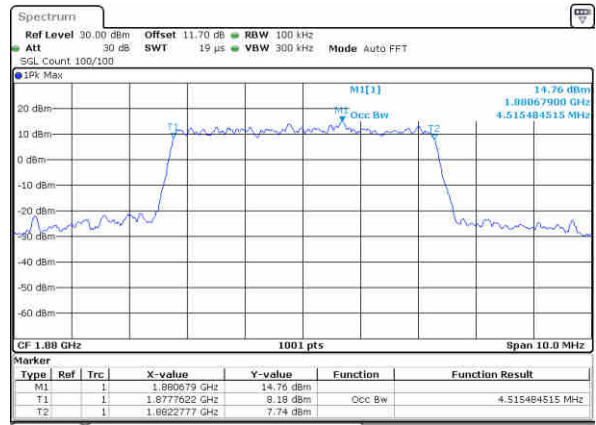

Date: 30 SEP 2017 16:04:06

Highest Channel / 5MHz / QPSK

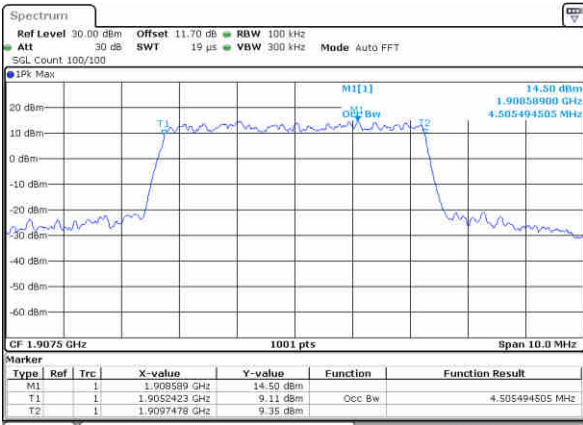

Date: 30 SEP 2017 16:06:24

Highest Channel / 5MHz / 16QAM

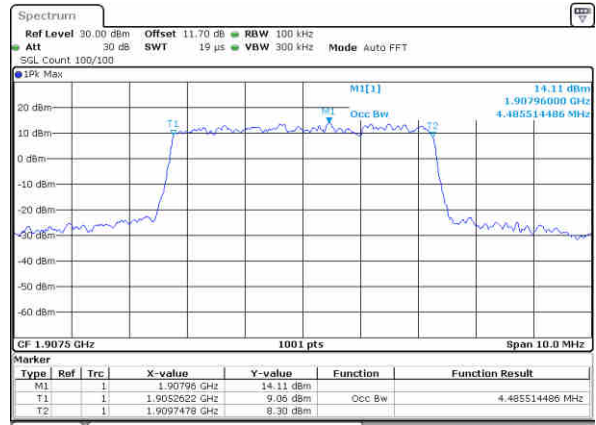

Date: 30 SEP 2017 16:06:34



LTE Band 2

Lowest Channel / 10MHz / QPSK

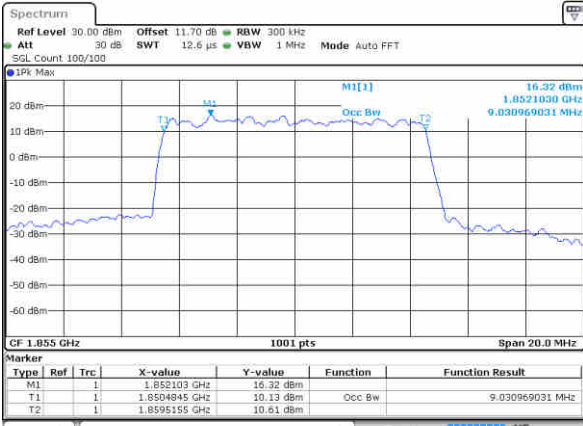

Date: 30 SEP 2017 16:13:27

Lowest Channel / 10MHz / 16QAM

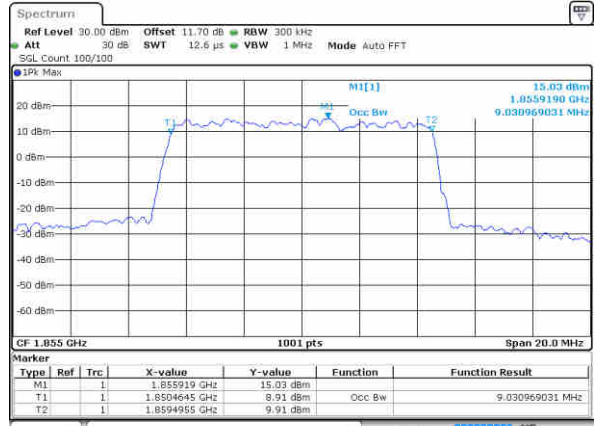

Date: 30 SEP 2017 16:13:37

Middle Channel / 10MHz / QPSK

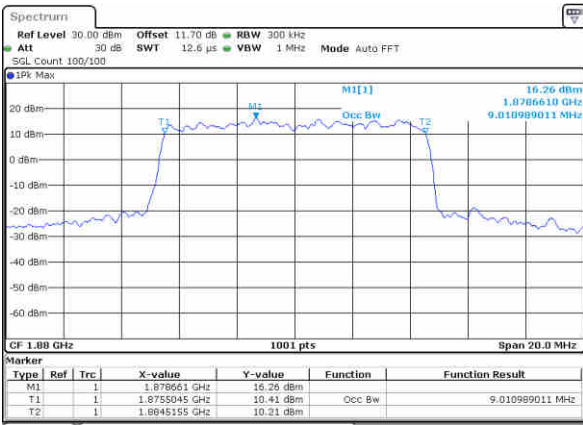

Date: 30 SEP 2017 16:20:30

Middle Channel / 10MHz / 16QAM

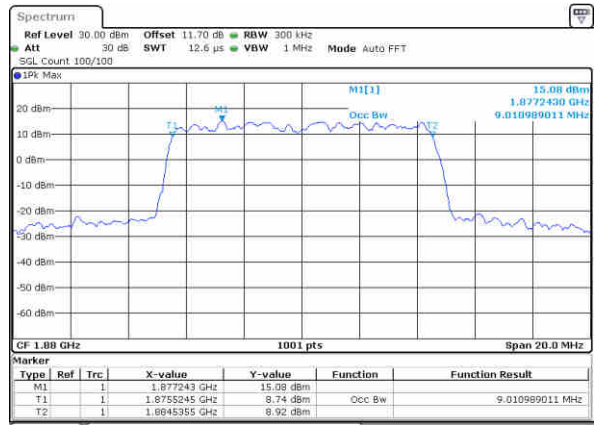

Date: 30 SEP 2017 16:20:40

Highest Channel / 10MHz / QPSK

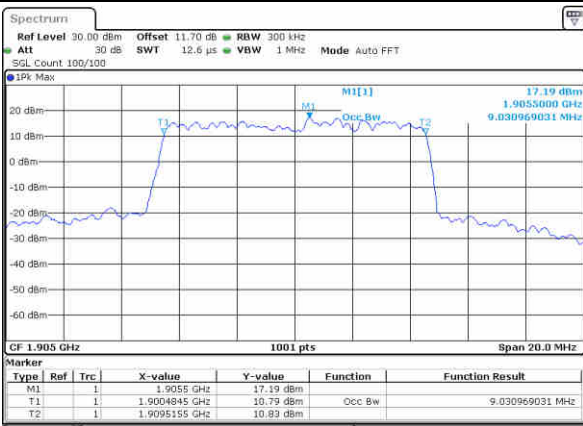

Date: 30 SEP 2017 16:22:56

Highest Channel / 10MHz / 16QAM

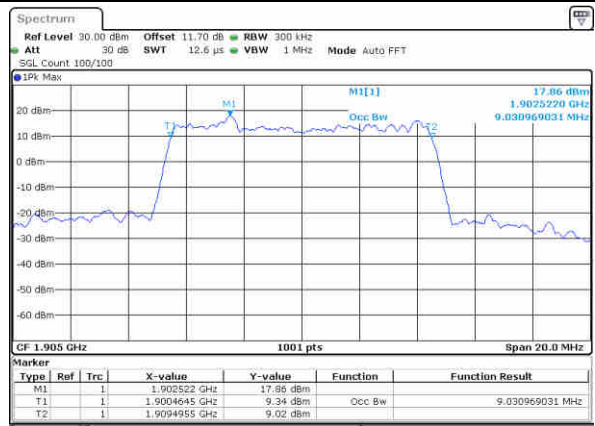

Date: 30 SEP 2017 16:23:06



LTE Band 2

Lowest Channel / 15MHz / QPSK

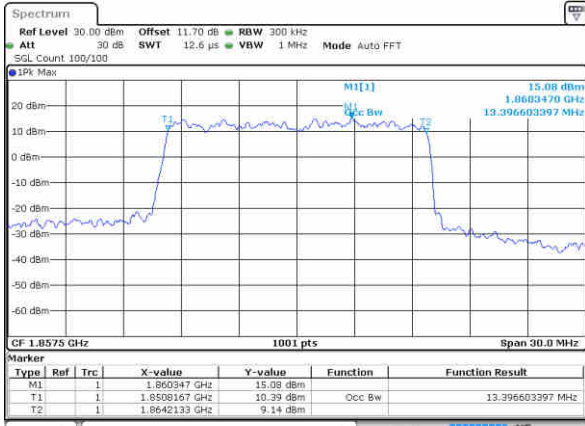

Date: 30 SEP 2017 16:30:01

Lowest Channel / 15MHz / 16QAM

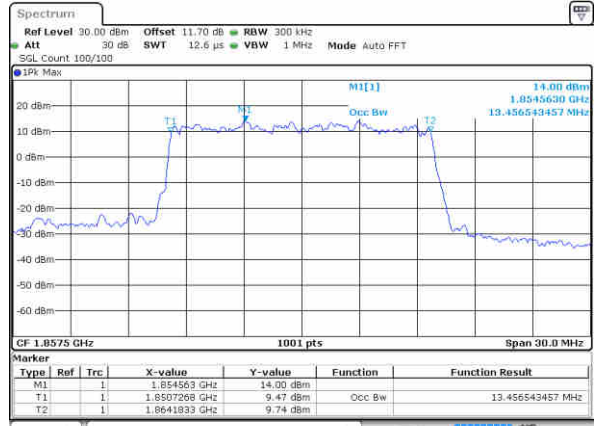

Date: 30 SEP 2017 16:30:11

Middle Channel / 15MHz / QPSK

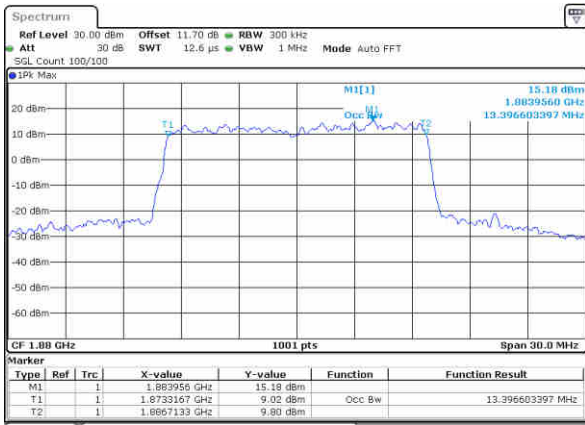

Date: 30 SEP 2017 16:37:03

Middle Channel / 15MHz / 16QAM

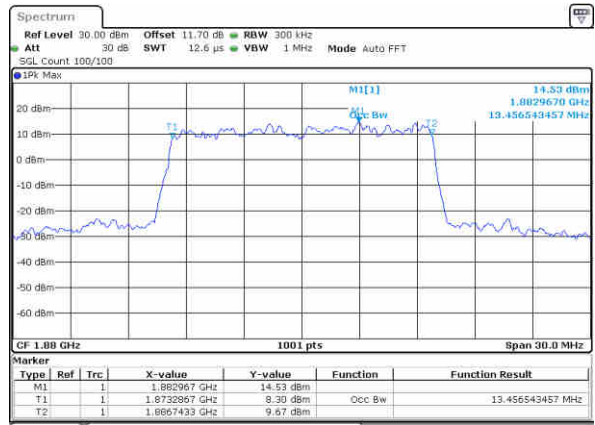

Date: 30 SEP 2017 16:37:13

Highest Channel / 15MHz / QPSK

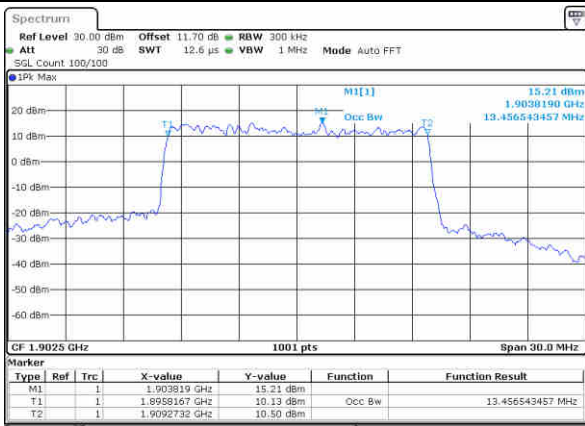

Date: 30 SEP 2017 16:39:31

Highest Channel / 15MHz / 16QAM

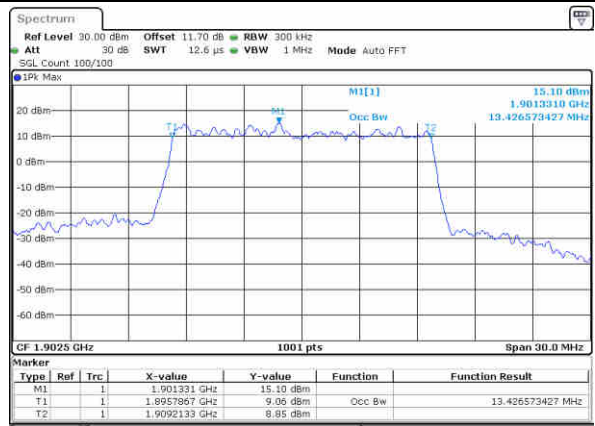

Date: 30 SEP 2017 16:39:41



LTE Band 2

Lowest Channel / 20MHz / QPSK

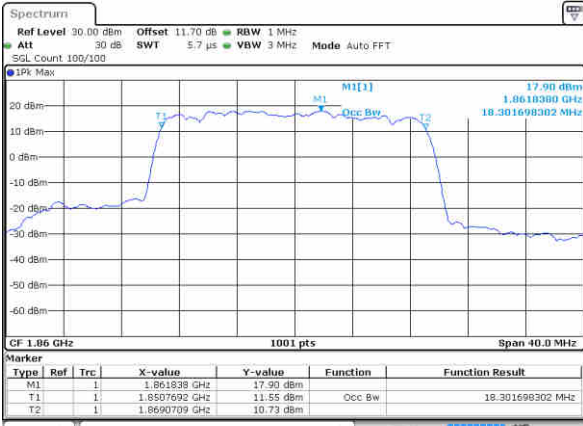

Date: 30 SEP 2017 16:46:34

Lowest Channel / 20MHz / 16QAM

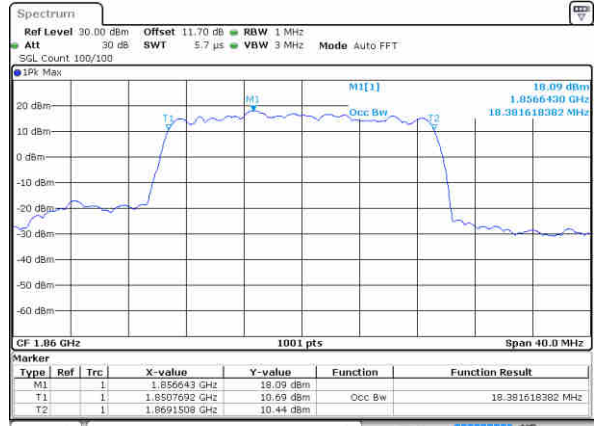

Date: 30 SEP 2017 16:46:44

Middle Channel / 20MHz / QPSK

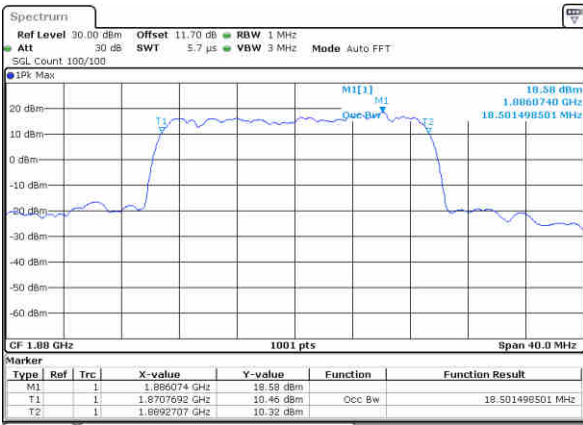

Date: 30 SEP 2017 16:53:37

Middle Channel / 20MHz / 16QAM

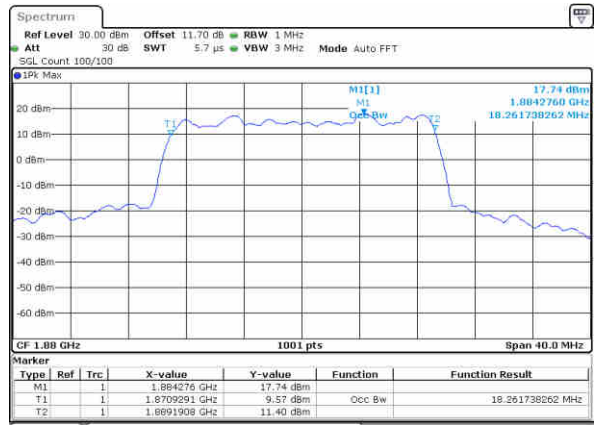

Date: 30 SEP 2017 16:53:47

Highest Channel / 20MHz / QPSK



Date: 30 SEP 2017 16:56:05

Highest Channel / 20MHz / 16QAM

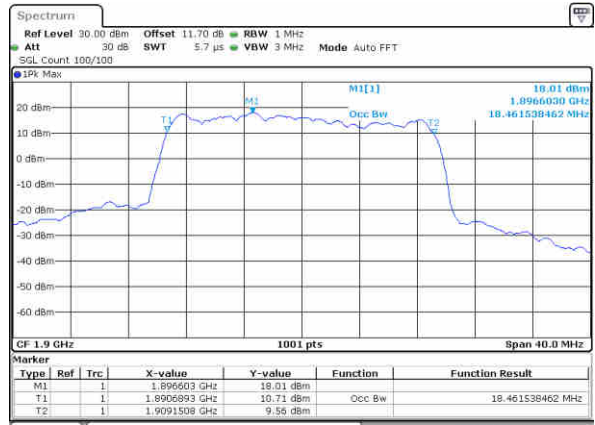

Date: 30 SEP 2017 16:56:15



LTE Band 2

Lowest Channel / 1.4MHz / 64QAM

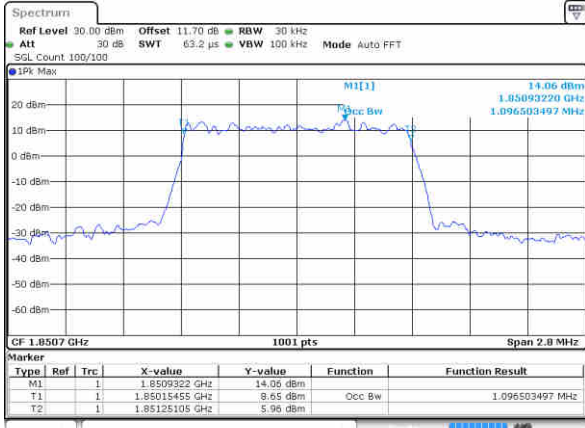

Date: 30 SEP 2017 17:44:00

Lowest Channel / 3MHz / 64QAM

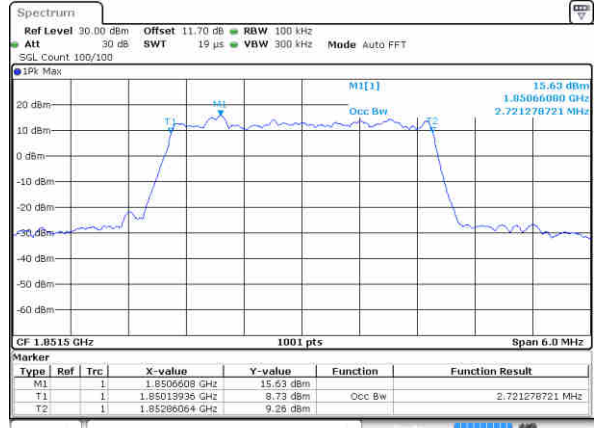

Date: 30 SEP 2017 17:03:07

Middle Channel / 1.4MHz / 64QAM

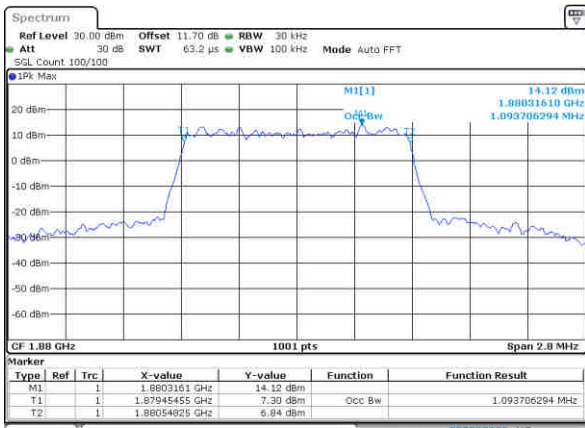

Date: 30 SEP 2017 17:47:32

Middle Channel / 3MHz / 64QAM

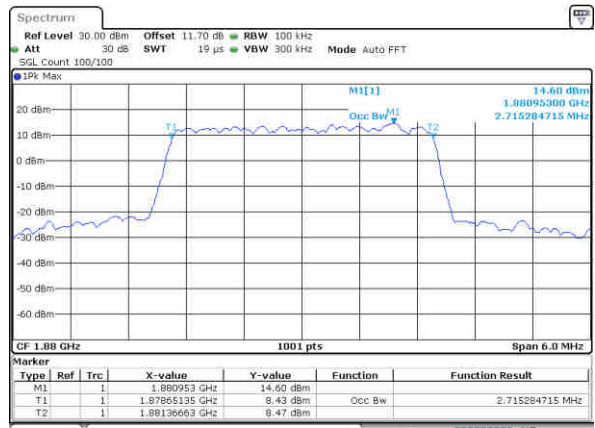

Date: 30 SEP 2017 17:06:39

Highest Channel / 1.4MHz / 64QAM

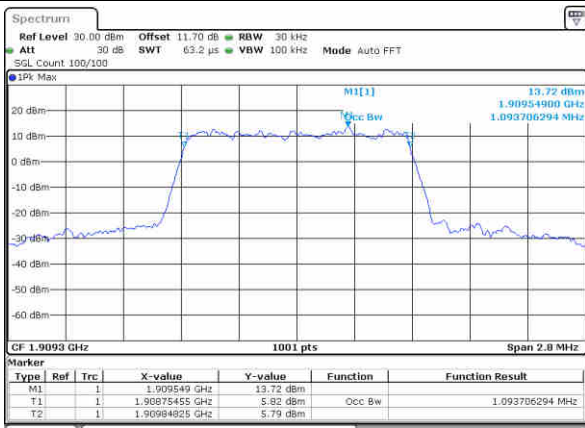

Date: 30 SEP 2017 17:48:46

Highest Channel / 3MHz / 64QAM

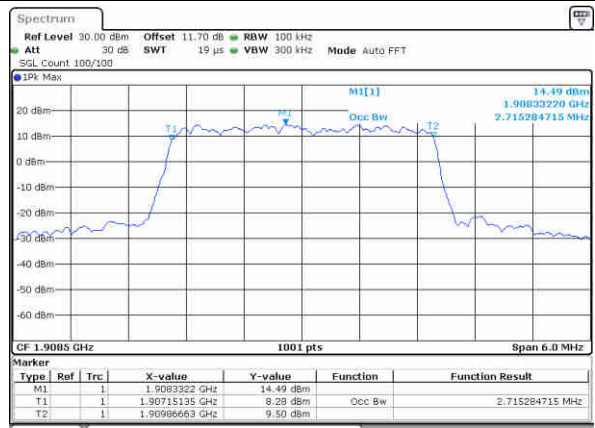

Date: 30 SEP 2017 17:07:53



LTE Band 2

Lowest Channel / 5MHz / 64QAM

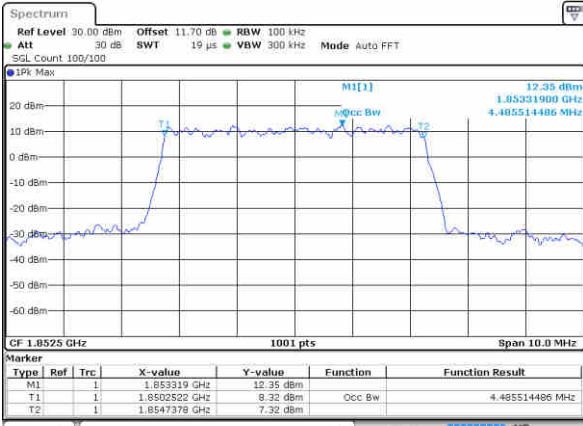

Date: 30 SEP 2017 17:11:24

Lowest Channel / 10MHz / 64QAM

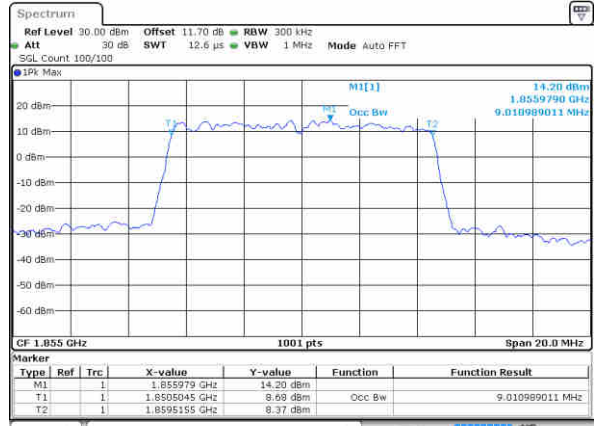

Date: 30 SEP 2017 17:19:41

Middle Channel / 5MHz / 64QAM

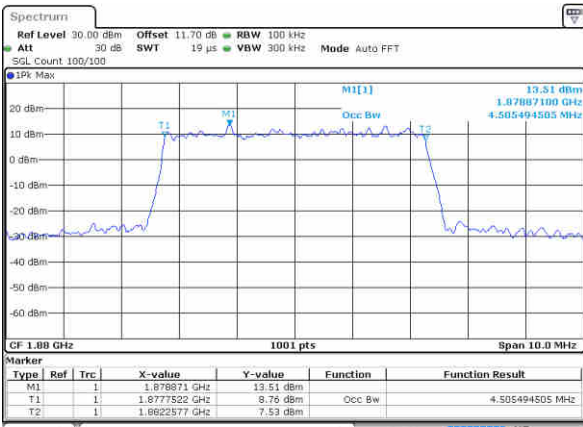

Date: 30 SEP 2017 17:14:56

Middle Channel / 10MHz / 64QAM

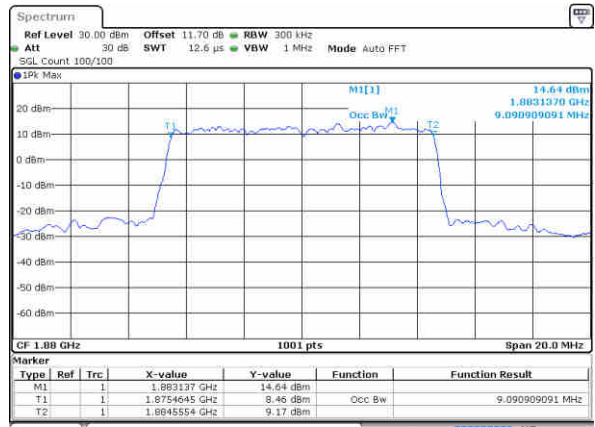

Date: 30 SEP 2017 17:23:13

Highest Channel / 5MHz / 64QAM

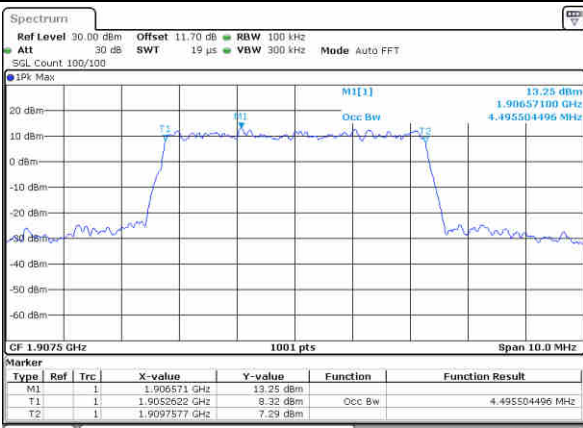

Date: 30 SEP 2017 17:16:10

Highest Channel / 10MHz / 64QAM

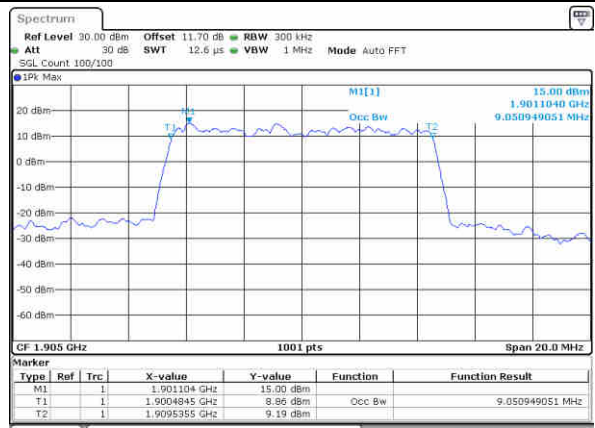

Date: 30 SEP 2017 17:24:27





LTE Band 2

Lowest Channel / 15MHz / 64QAM

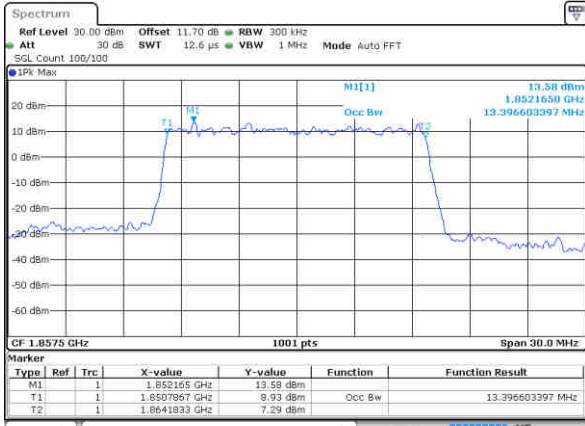

Date: 30 SEP 2017 17:27:58

Lowest Channel / 20MHz / 64QAM

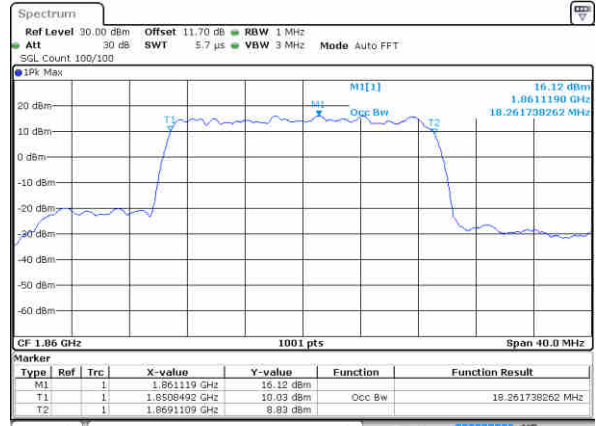

Date: 30 SEP 2017 17:36:15

Middle Channel / 15MHz / 64QAM

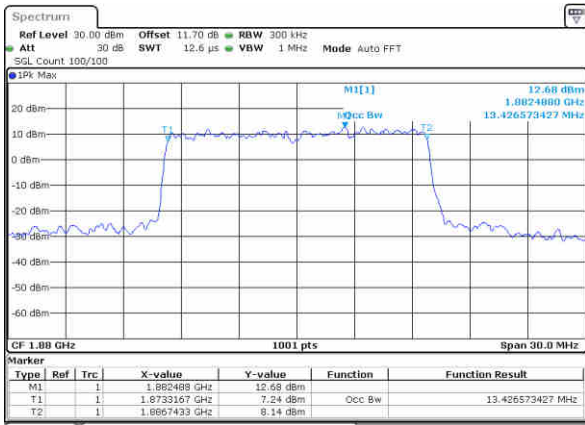

Date: 30 SEP 2017 17:31:30

Middle Channel / 20MHz / 64QAM

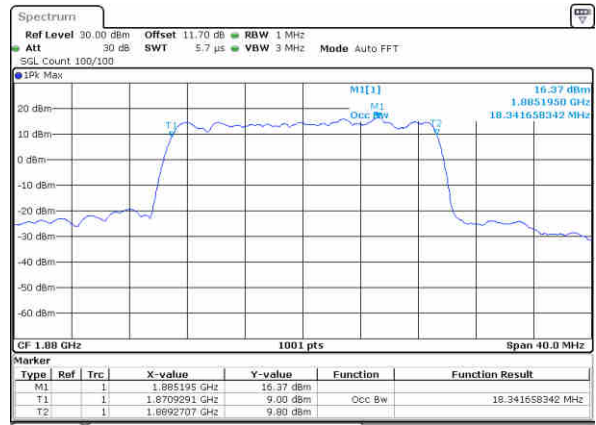

Date: 30 SEP 2017 17:39:46

Highest Channel / 15MHz / 64QAM

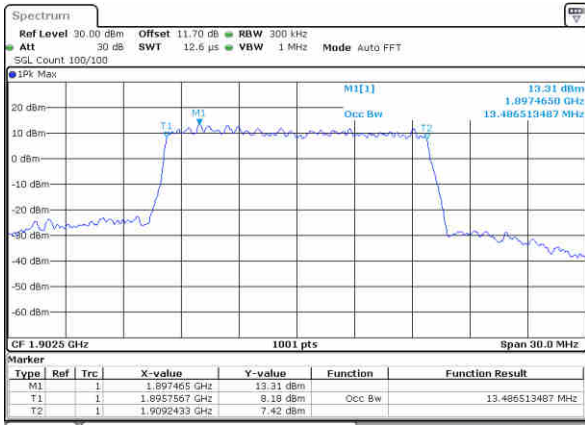

Date: 30 SEP 2017 17:32:44

Highest Channel / 20MHz / 64QAM

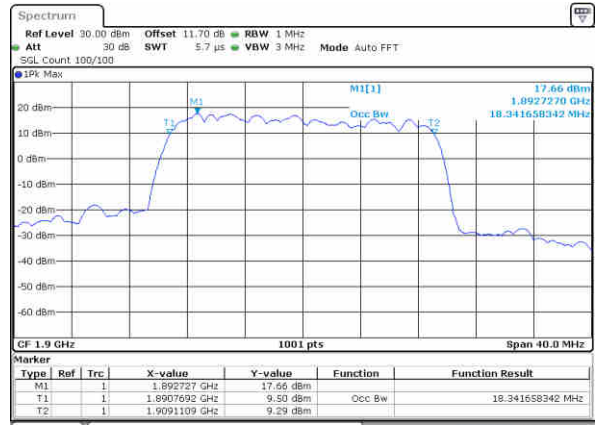

Date: 30 SEP 2017 17:41:00



# Conducted Band Edge

