



# FCC/IC RF Test Report

**APPLICANT** : Sierra Wireless Inc.  
**EQUIPMENT** : Radio Module  
**BRAND NAME** : AirPrime  
**MODEL NAME** : EM7565-9  
**FCC ID** : N7NEM75L  
**IC** : 2417C-EM75L  
**STANDARD** : FCC 47 CFR Part 2, 22(H), 24(E), 27(L)  
IC RSS-132 issue 3  
IC RSS-133 issue 6  
IC RSS-139 issue 3  
**CLASSIFICATION** : PCS Licensed Transmitter (PCB)

This is a partial report, which the effective radiated power and equivalent isotropic radiated power testing are not included. The product was received on Sep. 19, 2017 and testing was completed on Oct. 03, 2017. We, SPORTON INTERNATIONAL INC., would like to declare that the tested sample has been evaluated in accordance with the test procedures given in ANSI / TIA / EIA-603-E and has been in compliance with the applicable technical standards.

The test results in this report apply exclusively to the tested model / sample. Without written approval of SPORTON INTERNATIONAL INC., the test report shall not be reproduced except in full.

Reviewed by: Joseph Lin / Supervisor

Approved by: Jones Tsai / Manager



## SPORTON INTERNATIONAL INC.

No. 52, Hwa Ya 1<sup>st</sup> Rd., Hwa Ya Technology Park, Kwei-Shan District, Tao Yuan City, Taiwan, R.O.C.



# TABLE OF CONTENTS

**REVISION HISTORY..... 3**

**SUMMARY OF TEST RESULT ..... 4**

**1 GENERAL DESCRIPTION ..... 5**

    1.1 Applicant..... 5

    1.2 Manufacturer ..... 5

    1.3 Product Feature of Equipment Under Test ..... 5

    1.4 Modification of EUT ..... 5

    1.5 Testing Location ..... 6

    1.6 Applicable Standards ..... 7

**2 TEST CONFIGURATION OF EQUIPMENT UNDER TEST ..... 8**

    2.1 Test Mode..... 8

    2.2 Connection Diagram of Test System ..... 8

    2.3 Support Unit used in test configuration ..... 9

    2.4 Measurement Results Explanation Example ..... 9

    2.5 Frequency List of Low/Middle/High Channels..... 9

**3 CONDUCTED TEST RESULT ..... 10**

    3.1 Measuring Instruments..... 10

    3.2 Test Setup ..... 10

    3.3 Test Result of Conducted Test..... 10

    3.4 Conducted Output Power ..... 11

    3.5 Peak-to-Average Ratio ..... 12

    3.6 99% Occupied Bandwidth and 26dB Bandwidth Measurement..... 13

    3.7 Conducted Band Edge ..... 14

    3.8 Conducted Spurious Emission ..... 15

    3.9 Frequency Stability..... 16

**4 RADIATED TEST ITEMS ..... 17**

    4.1 Measuring Instruments..... 17

    4.2 Test Setup ..... 17

    4.3 Test Result of Radiated Test..... 17

    4.4 Field Strength of Spurious Radiation Measurement ..... 18

**5 LIST OF MEASURING EQUIPMENT ..... 19**

**6 UNCERTAINTY OF EVALUATION ..... 20**

**APPENDIX A. TEST RESULTS OF CONDUCTED TEST**

**APPENDIX B. TEST RESULTS OF RADIATED TEST**



### REVISION HISTORY

REPORT NO.	VERSION	DESCRIPTION	ISSUED DATE
FG791919A	Rev. 01	Initial issue of report	Oct. 12, 2017



## SUMMARY OF TEST RESULT

Report Section	FCC Rule	IC Rule	Description	Limit	Result	Remark
3.4	§2.1046	RSS-132 (5.4) RSS-133 (6.4) RSS-139 (6.5)	Conducted Output Power	Reporting Only	PASS	-
3.5	§24.232(d)	RSS-132 (5.4) RSS-133 (6.4) RSS-139 (6.5)	Peak-to-Average Ratio	< 13 dB	PASS	-
3.6	§2.1049 §22.917(b) §24.238(b) §27.53(g)	RSS-GEN(6.6) RSS-132(3.1) RSS-133(3.1) RSS-139 (3.1)	Occupied Bandwidth	Reporting Only	PASS	-
3.7	§2.1051 §22.917(a) §24.238(a) §27.53(h)	RSS-132 (5.5) RSS-133 (6.5) RSS-139 (6.6)	Band Edge Measurement	< 43+10log <sub>10</sub> (P[Watts])	PASS	-
3.8	§2.1051 §22.917(a) §24.238(a) §27.53(h)	RSS-132 (5.5) RSS-133 (6.5) RSS-139 (6.6)	Conducted Emission	< 43+10log <sub>10</sub> (P[Watts])	PASS	-
3.9	§2.1055 §22.355	RSS-GEN(6.11) RSS-132 (5.3)	Frequency Stability for Temperature & Voltage	< 2.5 ppm for Part 22	PASS	-
	§2.1055 §24.235 §27.54	RSS-GEN(6.11) RSS-133 (6.3) RSS-139 (6.4)		Within Authorized Band		
4.4	§2.1053 §22.917(a) §24.238(a) §27.53(h)	RSS-132 (5.5) RSS-133 (6.5) RSS-139 (6.6)	Field Strength of Spurious Radiation	< 43+10log <sub>10</sub> (P[Watts])	PASS	Under limit 28.25 dB at 3504.000 MHz



# **1 General Description**

## **1.1 Applicant**

**Sierra Wireless Inc.**

13811 Wireless Way Richmond, BC Canada V6V 3A4

## **1.2 Manufacturer**

**Sierra Wireless Inc.**

13811 Wireless Way Richmond, BC Canada V6V 3A4

## **1.3 Product Feature of Equipment Under Test**

WCDMA/LTE

## **1.4 Modification of EUT**

No modifications are made to the EUT during all test items.



### 1.5 Testing Location

Sporton Lab is accredited to ISO 17025 by Taiwan Accreditation Foundation (TAF code : 1190) and the FCC designation No. TW 0007 under the FCC 2.948(e) by Mutual Recognition Agreement (MRA) in FCC Test.

<b>Test Site</b>	SPORTON INTERNATIONAL INC.	
<b>Test Site Location</b>	No. 52, Hwa Ya 1 <sup>st</sup> Rd., Hwa Ya Technology Park, Kwei-Shan District, Tao Yuan City, Taiwan, R.O.C. TEL: +886-3-327-3456 FAX: +886-3-328-4978	
<b>Test Site No.</b>	<b>Sporton Site No.</b>	
	TH03-HY	

<b>Test Site</b>	SPORTON INTERNATIONAL INC.	
<b>Test Site Location</b>	No.58, Aly. 75, Ln. 564, Wenhua 3rd Rd. Guishan Dist, Taoyuan City, Taiwan (R.O.C.) TEL: +886-3-327-0868 FAX: +886-3-327-0855	
<b>Test Site No.</b>	<b>Sporton Site No.</b>	<b>IC Registration No.</b>
	03CH11-HY	4086H-2



## 1.6 Applicable Standards

According to the specifications of the manufacturer, the EUT must comply with the requirements of the following standards:

- ♦ 47 CFR Part 2, 22(H), 24(E), 27(L)
- ♦ ANSI / TIA / EIA-603-E
- ♦ FCC KDB 971168 D01 Power Meas. License Digital Systems v02r02
- ♦ ANSI C63.26-2015
- ♦ IC RSS-132 Issue 3
- ♦ IC RSS-133 Issue 6
- ♦ IC RSS-139 Issue 3
- ♦ IC RSS-Gen Issue 4

**Remark:** All test items were verified and recorded according to the standards and without any deviation during the test.

## 2 Test Configuration of Equipment Under Test

### 2.1 Test Mode

Antenna port conducted and radiated test items were performed according to KDB 971168 D01 Power Meas. License Digital Systems v02r02 with maximum output power.

Radiated measurements were performed with rotating EUT in different three orthogonal test planes to find the maximum emission.

Radiated emissions were investigated as following frequency range:

1. 30 MHz to 9000 MHz for WCDMA Band V.
2. 30 MHz to 18000 MHz for WCDMA Band IV.
3. 30 MHz to 19100 MHz for WCDMA Band II.

All modes and data rates and positions were investigated.

Test modes are chosen to be reported as the worst case configuration below:

Test Modes		
Band	Radiated TCs	Conducted TCs
WCDMA Band V	■ RMC 12.2Kbps Link	■ RMC 12.2Kbps Link
WCDMA Band II	■ RMC 12.2Kbps Link	■ RMC 12.2Kbps Link
WCDMA Band IV	■ RMC 12.2Kbps Link	■ RMC 12.2Kbps Link

### 2.2 Connection Diagram of Test System

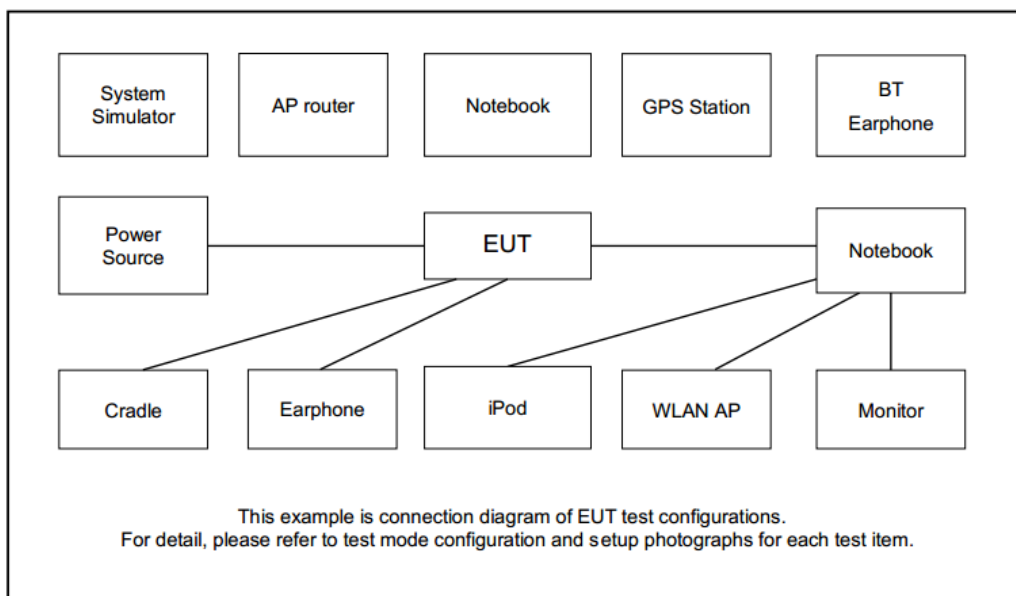





### 2.3 Support Unit used in test configuration

Item	Equipment	Trade Name	Model No.	FCC ID	Data Cable	Power Cord
1.	Base Station	R&S	CMU 200	N/A	N/A	Unshielded, 1.8 m

### 2.4 Measurement Results Explanation Example

For all conducted test items:

The offset level is set in the spectrum analyzer to compensate the RF cable loss and attenuator factor between RF conducted output port and spectrum analyzer. With the offset compensation, the spectrum analyzer reading level will be exactly the RF output level.

The spectrum analyzer offset is derived from RF cable loss and attenuator factor.

$$\text{Offset} = \text{RF cable loss} + \text{attenuator factor}.$$

The following shows an offset computation example with RF cable loss 4.2 dB and a 10dB attenuator.

Example :

$$\begin{aligned} \text{Offset(dB)} &= \text{RF cable loss(dB)} + \text{attenuator factor(dB)}. \\ &= 4.2 + 10 = 14.2 \text{ (dB)} \end{aligned}$$

### 2.5 Frequency List of Low/Middle/High Channels

Frequency List				
Band	Channel/Frequency(MHz)	Lowest	Middle	Highest
WCDMA Band V	Channel	4132	4182	4233
	Frequency	826.4	836.4	846.6
WCDMA Band II	Channel	9262	9400	9538
	Frequency	1852.4	1880.0	1907.6
WCDMA Band IV	Channel	1312	1413	1513
	Frequency	1712.4	1732.6	1752.6

### 3 Conducted Test Result

#### 3.1 Measuring Instruments

See list of measuring instruments of this test report.

#### 3.2 Test Setup

##### 3.2.1 Conducted Output Power

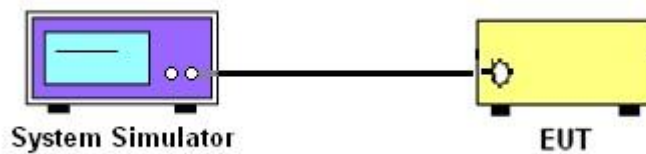

##### 3.2.2 Peak-to-Average Ratio, Occupied Bandwidth, Conducted Band-Edge and Conducted Spurious Emission

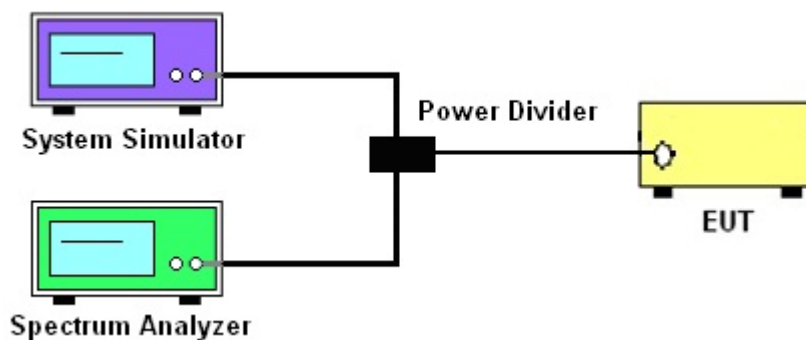

##### 3.2.3 Frequency Stability

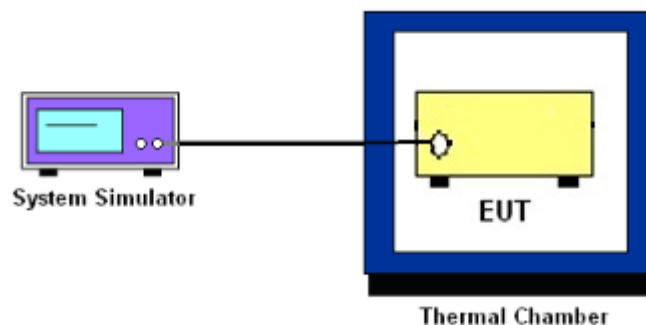

### 3.3 Test Result of Conducted Test

Please refer to Appendix A.



## **3.4 Conducted Output Power**

### **3.4.1 Description of the Conducted Output Power**

A system simulator was used to establish communication with the EUT. Its parameters were set to enforce EUT transmitting at the maximum power. The measured power in the radio frequency on the transmitter output terminals shall be reported.

### **3.4.2 Test Procedures**

1. The transmitter output port was connected to the system simulator.
2. Set EUT at maximum power through system simulator.
3. Select lowest, middle, and highest channels for each band and different modulation.
4. Measure the maximum burst average power for GSM and maximum average power for other modulation signal.



## **3.5 Peak-to-Average Ratio**

### **3.5.1 Description of the PAR Measurement**

The peak-to-average ratio (PAR) of the transmission may not exceed 13 dB.

### **3.5.2 Test Procedures**

1. The testing follows FCC KDB 971168 D01 v02r02 Section 5.7.1 and ANSI C63.26 Section 5.2.3.4.
2. The EUT was connected to spectrum analyzer and system simulator via a power divider.
3. Set EUT to transmit at maximum output power.
4. When the duty cycle is less than 98%, then signal gating will be implemented on the spectrum analyzer by triggering from the system simulator.
5. Set the CCDF (Complementary Cumulative Distribution Function) option of the spectrum analyzer.
6. Record the maximum PAPR level associated with a probability of 0.1%.



### 3.6 99% Occupied Bandwidth and 26dB Bandwidth Measurement

#### 3.6.1 Description of 99% Occupied Bandwidth and 26dB Bandwidth Measurement

The occupied bandwidth is the width of a frequency band such that, below the lower and above the upper frequency limits, the mean powers emitted are each equal to a specified percentage 0.5% of the total mean transmitted power.

The 26 dB emission bandwidth is defined as the frequency range between two points, one above and one below the carrier frequency, at which the spectral density of the emission is attenuated 26 dB below the maximum in-band spectral density of the modulated signal. Spectral density (power per unit bandwidth) is to be measured with a detector of resolution bandwidth equal to approximately 1.0% of the emission bandwidth.

#### 3.6.2 Test Procedures

1. The testing follows FCC KDB 971168 v02r02 Section 4.2 and ANSI C63.26 Section 5.4
2. The EUT was connected to spectrum analyzer and system simulator via a power divider.
3. The spectrum analyzer center frequency is set to the nominal EUT channel center frequency. The span range for the spectrum analyzer shall be between two and five times the anticipated OBW.
4. The nominal resolution bandwidth (RBW) shall be in the range of 1 to 5 % of the anticipated OBW, and the VBW shall be at least 3 times the RBW.
5. Set the detection mode to peak, and the trace mode to max hold.
6. Determine the reference value: Set the EUT to transmit a modulated signal. Allow the trace to stabilize. Set the spectrum analyzer marker to the highest level of the displayed trace.  
(this is the reference value)
7. Determine the “-26 dB down amplitude” as equal to (Reference Value – X).
8. Place two markers, one at the lowest and the other at the highest frequency of the envelope of the spectral display such that each marker is at or slightly below the “-X dB down amplitude” determined in step 6. If a marker is below this “-X dB down amplitude” value it shall be placed as close as possible to this value. The OBW is the positive frequency difference between the two markers.
9. Use the 99 % power bandwidth function of the spectrum analyzer and report the measured bandwidth.



### 3.7 Conducted Band Edge

#### 3.7.1 Description of Conducted Band Edge Measurement

The power of any emission outside of the authorized operating frequency ranges must be lower than the transmitter power (P) by a factor of at least  $43 + 10 \log (P)$  dB.

#### 3.7.2 Test Procedures

1. The testing follows FCC KDB 971168 D01 v02r02 Section 6.0 and ANSI C63.26 Section 5.7.
2. The EUT was connected to the spectrum analyzer and system simulator via a power divider.
3. The RF output of EUT was connected to the spectrum analyzer by an RF cable and attenuator. The path loss was compensated to the results for each measurement.
4. The band edges of low and high channels for the highest RF powers were measured.
5. The RF fundamental frequency should be excluded against the limit line in the operating frequency band.
6. The limit line is derived from  $43 + 10\log(P)$  dB below the transmitter power P(Watts)  
 $= P(W) - [43 + 10\log(P)]$  (dB)  
 $= [30 + 10\log(P)]$  (dBm) -  $[43 + 10\log(P)]$  (dB)  
 $= -13\text{dBm}$ .



### 3.8 Conducted Spurious Emission

#### 3.8.1 Description of Conducted Spurious Emission Measurement

The power of any emission outside of the authorized operating frequency ranges must be lower than the transmitter power (P) by a factor of at least  $43 + 10 \log (P)$  dB.

It is measured by means of a calibrated spectrum analyzer and scanned from 30 MHz up to a frequency including its 10<sup>th</sup> harmonic.

#### 3.8.2 Test Procedures

1. The testing follows FCC KDB 971168 D01 v02r02 Section 6.0 and ANSI C63.26 Section 5.7.
2. The EUT was connected to the spectrum analyzer and system simulator via a power divider.
3. The RF output of EUT was connected to the spectrum analyzer by an RF cable and attenuator. The path loss was compensated to the results for each measurement.
4. The middle channel for the highest RF power within the transmitting frequency was measured.
5. The conducted spurious emission for the whole frequency range was taken.
6. The RF fundamental frequency should be excluded against the limit line in the operating frequency band.
7. The limit line is derived from  $43 + 10\log(P)$  dB below the transmitter power P(Watts)  
=  $P(W) - [43 + 10\log(P)]$  (dB)  
=  $[30 + 10\log(P)]$  (dBm) -  $[43 + 10\log(P)]$  (dB)  
= -13dBm.



### 3.9 Frequency Stability

#### 3.9.1 Description of Frequency Stability Measurement

The frequency stability shall be measured by variation of ambient temperature and variation of primary supply voltage to ensure that the fundamental emission stays within the authorized frequency block. The frequency stability of the transmitter shall be maintained within  $\pm 0.00025\%$  ( $\pm 2.5\text{ppm}$ ) of the center frequency.

#### 3.9.2 Test Procedures for Temperature Variation

1. The testing follows FCC KDB 971168 D01 v02r02 Section 9.0 and ANSI C63.26 Section 5.6.
2. The EUT was set up in the thermal chamber and connected with the system simulator.
3. With power OFF, the temperature was decreased to  $-30^{\circ}\text{C}$  and the EUT was stabilized before testing. Power was applied and the maximum change in frequency was recorded within one minute.
4. With power OFF, the temperature was raised in  $10^{\circ}\text{C}$  steps up to  $50^{\circ}\text{C}$ . The EUT was stabilized at each step for at least half an hour. Power was applied and the maximum frequency change was recorded within one minute.

#### 3.9.3 Test Procedures for Voltage Variation

1. The testing follows FCC KDB 971168 D01 v02r02 Section 9.0 and ANSI C63.26 Section 5.6.
2. The EUT was placed in a temperature chamber at  $20\pm 5^{\circ}\text{C}$  and connected with the system simulator.
3. The power supply voltage to the EUT was varied from 85% to 115% of the nominal value measured at the input to the EUT.
4. The variation in frequency was measured for the worst case.

#### 3.9.4 Test Procedures for Frequency Stability

1. The testing follows the section 6.11 of RSS-GEN.
2. The EUT was connected to spectrum analyzer and system simulator via a power divider.
3. The EUT was operated at lowest and highest channel.
4. For RSS-132, 133, 139, the result shall be within the frequency range.



## 4 Radiated Test Items

### 4.1 Measuring Instruments

See list of measuring instruments of this test report.

### 4.2 Test Setup

#### 4.2.1 For radiated test from 30MHz to 1GHz

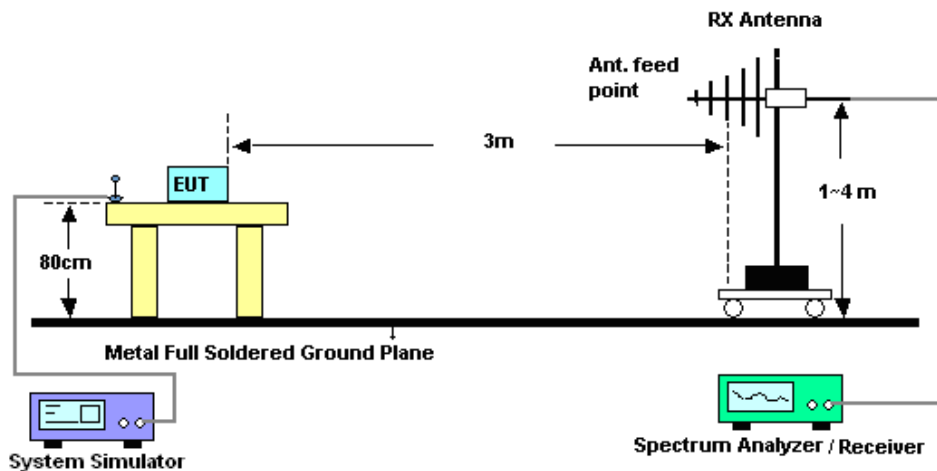

#### 4.2.2 For radiated test above 1GHz

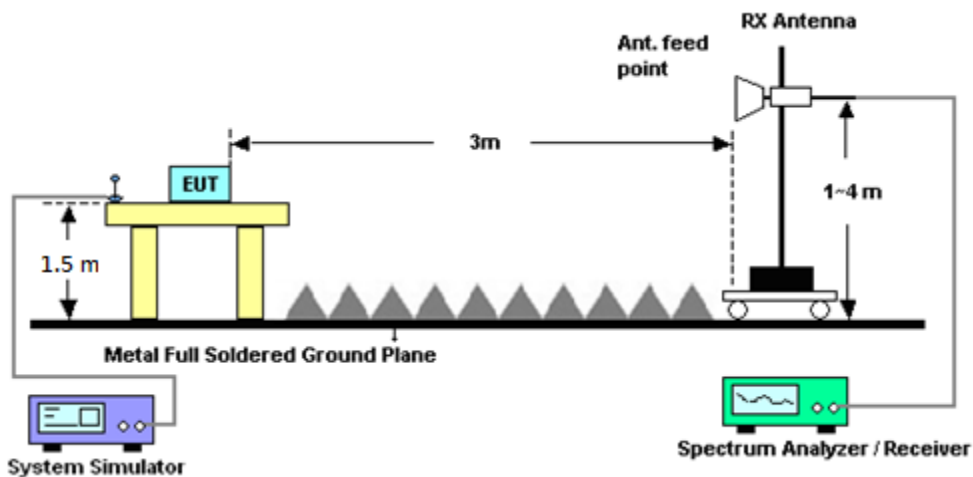

### 4.3 Test Result of Radiated Test

Please refer to Appendix B.



## 4.4 Field Strength of Spurious Radiation Measurement

### 4.4.1 Description of Field Strength of Spurious Radiated Measurement

The power of any emission outside of the authorized operating frequency ranges must be attenuated below the transmitter power (P) by a factor of at least  $43 + 10 \log (P)$  dB. The spectrum is scanned from 30 MHz up to a frequency including its 10th harmonic.

### 4.4.2 Test Procedures

1. The testing follows FCC KDB 971168 D01 v02r02 Section 5.8, ANSI / TIA-603-E Section 2.2.12 and ANSI C63.26 Section 5.5.3 Measurement of spurious emissions using substitution method.
2. The EUT was placed on a rotatable wooden table 0.8 meters for frequency below 1GHz and 1.5 meter for frequency above 1GHz above the ground.
3. The EUT was set 3 meters from the receiving antenna, which was mounted on the antenna tower.
4. The table was rotated 360 degrees to determine the position of the highest spurious emission.
5. The height of the receiving antenna is varied between one meter and four meters to search for the maximum spurious emission for both horizontal and vertical polarizations.
6. Make the measurement with the spectrum analyzer's RBW = 1MHz, VBW = 3MHz, taking record of maximum spurious emission.
7. A horn antenna was substituted in place of the EUT and was driven by a signal generator.
8. Tune the output power of signal generator to the same emission level with EUT maximum spurious emission.
9. Taking the record of output power at antenna port.
10. Repeat step 7 to step 8 for another polarization.
11.  $EIRP \text{ (dBm)} = S.G. \text{ Power} - Tx \text{ Cable Loss} + Tx \text{ Antenna Gain}$
12.  $ERP \text{ (dBm)} = EIRP - 2.15$
13. The RF fundamental frequency should be excluded against the limit line in the operating frequency band.
14. The limit line is derived from  $43 + 10\log(P)$  dB below the transmitter power P(Watts)  
 $= P(W) - [43 + 10\log(P)] \text{ (dB)}$   
 $= [30 + 10\log(P)] \text{ (dBm)} - [43 + 10\log(P)] \text{ (dB)}$   
 $= -13\text{dBm}.$



## 5 List of Measuring Equipment

Instrument	Manufacturer	Model No.	Serial No.	Characteristics	Calibration Date	Test Date	Due Date	Remark
Spectrum Analyzer	Rohde & Schwarz	FSP30	101329	9kHz~30GHz	Jun. 29, 2017	Sep. 27, 2017 ~ Oct. 03, 2017	Jun. 28, 2018	Conducted (TH03-HY)
Temperature Chamber	ESPEC	SU-641	92013721	-30℃ ~70℃	Nov. 16, 2016	Sep. 27, 2017 ~ Oct. 03, 2017	Nov. 15, 2017	Conducted (TH03-HY)
Programmable Power Supply	GW Instek	PSS-2005	EL883644	Voltage:0~20V; Current:0~5A	Nov. 22, 2016	Sep. 27, 2017 ~ Oct. 03, 2017	Nov. 21, 2017	Conducted (TH03-HY)
Base Station (Measure)	Rohde & Schwarz	CMU200	117995	GSM / GPRS / WCDMA / CDMA	Aug. 09, 2017	Sep. 27, 2017 ~ Oct. 03, 2017	Aug. 08, 2018	Conducted (TH03-HY)
Amplifier	MITEQ	TTA1840-35-HG	1871923	18GHz~40GHz, VSWR : 2.5:1 max	Jul. 21, 2017	Sep. 26, 2017 ~ Sep. 27, 2017	Jul. 20, 2018	Radiation (03CH11-HY)
Amplifier	SONOMA	310N	187312	9kHz~1GHz	Nov. 10, 2016	Sep. 26, 2017 ~ Sep. 27, 2017	Nov. 09, 2017	Radiation (03CH11-HY)
Bilog Antenna	TESEQ	CBL 6111D&N-6-06	35414&AT-N0602	30MHz~1GHz	Oct. 15, 2016	Sep. 26, 2017 ~ Sep. 27, 2017	Oct. 14, 2017	Radiation (03CH11-HY)
Horn Antenna	SCHWARZBECK	BBHA 9120 D	9120D-1326	1GHz ~ 18GHz	Oct. 07, 2016	Sep. 26, 2017 ~ Sep. 27, 2017	Oct. 06, 2017	Radiation (03CH11-HY)
Preamplifier	Keysight	83017A	MY53270080	1GHz~26.5GHz	Nov. 10, 2016	Sep. 26, 2017 ~ Sep. 27, 2017	Nov. 09, 2017	Radiation (03CH11-HY)
Preamplifier	MITEQ	AMF-7D-0010 1800-30-10P	1902247	1GHz~18GHz	Jun. 23, 2017	Sep. 26, 2017 ~ Sep. 27, 2017	Jun. 22, 2018	Radiation (03CH11-HY)
Spectrum Analyzer	Keysight	N9010A	MY54200486	10Hz ~ 44GHz	Oct. 12, 2016	Sep. 26, 2017 ~ Sep. 27, 2017	Oct. 11, 2017	Radiation (03CH11-HY)
Antenna Mast	EMEC	AM-BS-4500-B	N/A	1~4m	N/A	Sep. 26, 2017 ~ Sep. 27, 2017	N/A	Radiation (03CH11-HY)
Turn Table	EMEC	TT 2000	N/A	0~360 Degree	N/A	Sep. 26, 2017 ~ Sep. 27, 2017	N/A	Radiation (03CH11-HY)
EMI Test Receiver	Agilent	N9038A (MXE)	MY53290053	20Hz to 26.5GHz	Jan. 12, 2017	Sep. 26, 2017 ~ Sep. 27, 2017	Jan. 11, 2018	Radiation (03CH11-HY)
SHF-EHF Horn Antenna	SCHWARZBECK	BBHA 9170	BBHA9170584	18GHz- 40GHz	Nov. 08, 2016	Sep. 26, 2017 ~ Sep. 27, 2017	Nov. 07, 2017	Radiation (03CH11-HY)



## 6 Uncertainty of Evaluation

### Uncertainty of Radiated Emission Measurement (30 MHz ~ 1000 MHz)

Measuring Uncertainty for a Level of Confidence of 95% ( $U = 2Uc(y)$ )	3.37
---	------

### Uncertainty of Radiated Emission Measurement (1 GHz ~ 18 GHz)

Measuring Uncertainty for a Level of Confidence of 95% ( $U = 2Uc(y)$ )	3.67
---	------

### Uncertainty of Radiated Emission Measurement (18 GHz ~ 40 GHz)

Measuring Uncertainty for a Level of Confidence of 95% ( $U = 2Uc(y)$ )	4.03
---	------



## **Appendix C. Test Setup Photographs**



## Appendix A. Test Results of Conducted Test

### Conducted Output Power(Average power)

Conducted Power (*Unit: dBm)						
Band	WCDMA Band V			WCDMA Band II		
Channel	4132	4182	4233	9262	9400	9538
Frequency	826.4	836.4	846.6	1852.4	1880	1907.6
RMC 12.2K	22.81	22.80	<b>22.86</b>	<b>22.58</b>	22.43	22.56
HSDPA Subtest-1	21.82	21.83	21.87	21.60	21.43	21.59
HSDPA Subtest-2	21.81	21.82	21.85	21.58	21.42	21.59
HSDPA Subtest-3	21.31	21.31	21.34	21.07	20.96	21.09
HSDPA Subtest-4	21.30	21.32	21.34	21.05	20.94	21.08
HSUPA Subtest-1	21.77	21.78	21.83	21.54	21.38	21.53
HSUPA Subtest-2	19.79	19.82	19.84	19.56	19.41	19.52
HSUPA Subtest-3	20.76	20.79	20.82	20.57	20.41	20.51
HSUPA Subtest-4	19.77	19.78	19.85	19.53	19.38	19.51
HSUPA Subtest-5	21.78	21.75	21.82	21.54	21.39	21.52

Conducted Power (*Unit: dBm)			
Band	WCDMA Band IV		
Channel	1312	1413	1513
Frequency	1712.4	1732.6	1752.6
RMC 12.2K	22.76	<b>22.83</b>	22.77
HSDPA Subtest-1	21.77	21.86	21.81
HSDPA Subtest-2	21.75	21.85	21.79
HSDPA Subtest-3	21.26	21.34	21.28
HSDPA Subtest-4	21.24	21.34	21.27
HSUPA Subtest-1	21.69	21.80	21.74
HSUPA Subtest-2	19.65	19.84	19.73
HSUPA Subtest-3	20.65	20.82	20.71
HSUPA Subtest-4	19.64	19.83	19.71
HSUPA Subtest-5	21.71	21.81	21.74



## A2. WCDMA

### Peak-to-Average Ratio

Mode	WCDMA Band V	WCDMA Band II	WCDMA Band IV	Limit: 13dB
Mod.	RMC 12.2Kbps	RMC 12.2Kbps	RMC 12.2Kbps	Result
Lowest CH	3.32	3.36	3.36	<b>PASS</b>
Middle CH	3.28	3.40	3.36	
Highest CH	3.24	3.36	3.32	

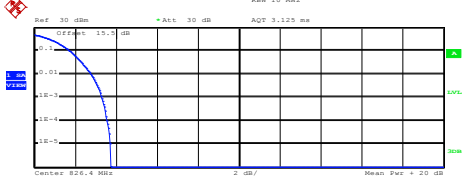
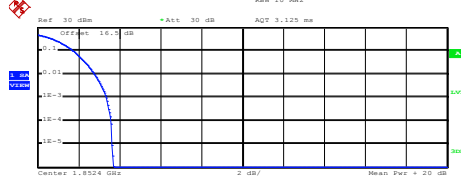
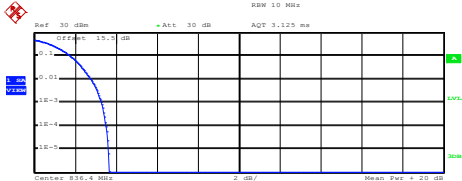
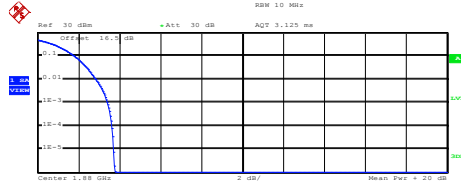
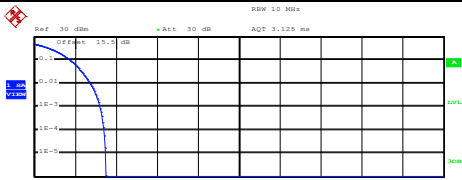
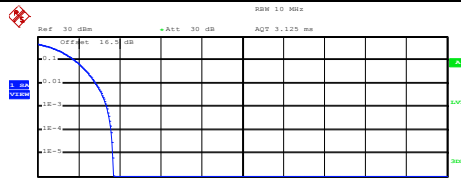

WCDMA Band V (RMC 12.2Kbps)	WCDMA Band II (RMC 12.2Kbps)																
<p style="text-align: center;"><b>Lowest Channel</b></p>  <p>Center 826.4 MHz      2 dB/      Mean Pwr + 20 dB</p> <p>Complementary Cumulative Distribution Function (100000 samples) Trace 1 Mean 22.70 dBm Peak 26.44 dBm Crest 3.74 dB</p> <table border="0"> <tr><td>10 %</td><td>1.76 dB</td></tr> <tr><td>1 %</td><td>2.76 dB</td></tr> <tr><td>.1 %</td><td>3.32 dB</td></tr> <tr><td>.01 %</td><td>3.56 dB</td></tr> </table> <p>Date: 27.SEP.2017 16:51:11</p>	10 %	1.76 dB	1 %	2.76 dB	.1 %	3.32 dB	.01 %	3.56 dB	<p style="text-align: center;"><b>Lowest Channel</b></p>  <p>Center 1.8524 GHz      2 dB/      Mean Pwr + 20 dB</p> <p>Complementary Cumulative Distribution Function (100000 samples) Trace 1 Mean 22.18 dBm Peak 25.88 dBm Crest 3.70 dB</p> <table border="0"> <tr><td>10 %</td><td>1.76 dB</td></tr> <tr><td>1 %</td><td>2.80 dB</td></tr> <tr><td>.1 %</td><td>3.36 dB</td></tr> <tr><td>.01 %</td><td>3.60 dB</td></tr> </table> <p>Date: 27.SEP.2017 16:52:11</p>	10 %	1.76 dB	1 %	2.80 dB	.1 %	3.36 dB	.01 %	3.60 dB
10 %	1.76 dB																
1 %	2.76 dB																
.1 %	3.32 dB																
.01 %	3.56 dB																
10 %	1.76 dB																
1 %	2.80 dB																
.1 %	3.36 dB																
.01 %	3.60 dB																
<p style="text-align: center;"><b>Middle Channel</b></p>  <p>Center 830.4 MHz      2 dB/      Mean Pwr + 20 dB</p> <p>Complementary Cumulative Distribution Function (100000 samples) Trace 1 Mean 22.76 dBm Peak 26.44 dBm Crest 3.68 dB</p> <table border="0"> <tr><td>10 %</td><td>1.76 dB</td></tr> <tr><td>1 %</td><td>2.76 dB</td></tr> <tr><td>.1 %</td><td>3.28 dB</td></tr> <tr><td>.01 %</td><td>3.52 dB</td></tr> </table> <p>Date: 27.SEP.2017 16:51:21</p>	10 %	1.76 dB	1 %	2.76 dB	.1 %	3.28 dB	.01 %	3.52 dB	<p style="text-align: center;"><b>Middle Channel</b></p>  <p>Center 1.88 GHz      2 dB/      Mean Pwr + 20 dB</p> <p>Complementary Cumulative Distribution Function (100000 samples) Trace 1 Mean 21.83 dBm Peak 25.60 dBm Crest 3.77 dB</p> <table border="0"> <tr><td>10 %</td><td>1.80 dB</td></tr> <tr><td>1 %</td><td>2.84 dB</td></tr> <tr><td>.1 %</td><td>3.40 dB</td></tr> <tr><td>.01 %</td><td>3.64 dB</td></tr> </table> <p>Date: 27.SEP.2017 16:52:19</p>	10 %	1.80 dB	1 %	2.84 dB	.1 %	3.40 dB	.01 %	3.64 dB
10 %	1.76 dB																
1 %	2.76 dB																
.1 %	3.28 dB																
.01 %	3.52 dB																
10 %	1.80 dB																
1 %	2.84 dB																
.1 %	3.40 dB																
.01 %	3.64 dB																
<p style="text-align: center;"><b>Highest Channel</b></p>  <p>Center 846.6 MHz      2 dB/      Mean Pwr + 20 dB</p> <p>Complementary Cumulative Distribution Function (100000 samples) Trace 1 Mean 22.88 dBm Peak 26.37 dBm Crest 3.49 dB</p> <table border="0"> <tr><td>10 %</td><td>1.76 dB</td></tr> <tr><td>1 %</td><td>2.76 dB</td></tr> <tr><td>.1 %</td><td>3.24 dB</td></tr> <tr><td>.01 %</td><td>3.40 dB</td></tr> </table> <p>Date: 27.SEP.2017 16:51:29</p>	10 %	1.76 dB	1 %	2.76 dB	.1 %	3.24 dB	.01 %	3.40 dB	<p style="text-align: center;"><b>Highest Channel</b></p>  <p>Center 1.9076 GHz      2 dB/      Mean Pwr + 20 dB</p> <p>Complementary Cumulative Distribution Function (100000 samples) Trace 1 Mean 21.95 dBm Peak 25.67 dBm Crest 3.72 dB</p> <table border="0"> <tr><td>10 %</td><td>1.80 dB</td></tr> <tr><td>1 %</td><td>2.84 dB</td></tr> <tr><td>.1 %</td><td>3.36 dB</td></tr> <tr><td>.01 %</td><td>3.60 dB</td></tr> </table> <p>Date: 27.SEP.2017 16:52:28</p>	10 %	1.80 dB	1 %	2.84 dB	.1 %	3.36 dB	.01 %	3.60 dB
10 %	1.76 dB																
1 %	2.76 dB																
.1 %	3.24 dB																
.01 %	3.40 dB																
10 %	1.80 dB																
1 %	2.84 dB																
.1 %	3.36 dB																
.01 %	3.60 dB																





WCDMA Band IV (RMC 12.2Kbps)

Lowest Channel

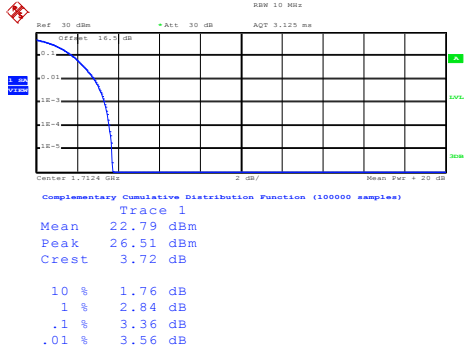

Date: 27.SEP.2017 16:36:04

Middle Channel

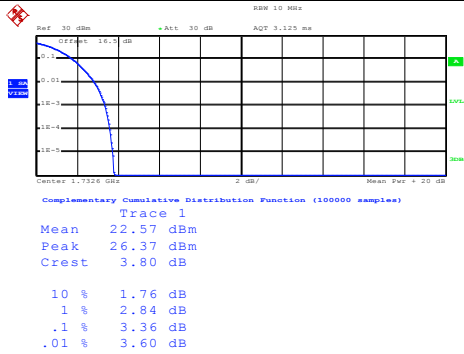

Date: 27.SEP.2017 16:36:13

Highest Channel

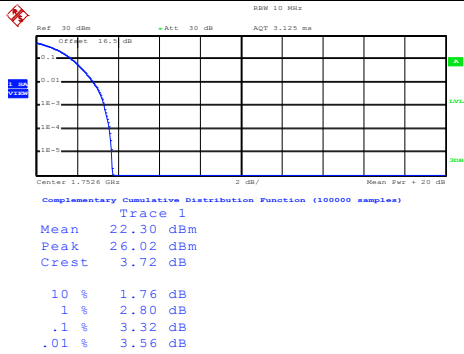

Date: 27.SEP.2017 16:36:23



**26dB Bandwidth**

Mode	WCDMA Band V	WCDMA Band II	WCDMA Band IV
Mod.	RMC 12.2Kbps	RMC 12.2Kbps	RMC 12.2Kbps
Lowest CH	4.67	4.70	4.68
Middle CH	4.71	4.69	4.69
Highest CH	4.70	4.68	4.70



WCDMA Band V (RMC 12.2Kbps)

WCDMA Band II (RMC 12.2Kbps)

Lowest Channel

Lowest Channel

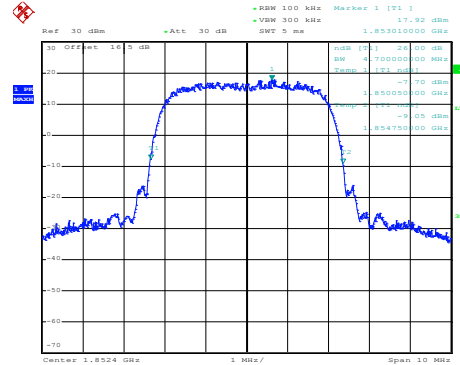
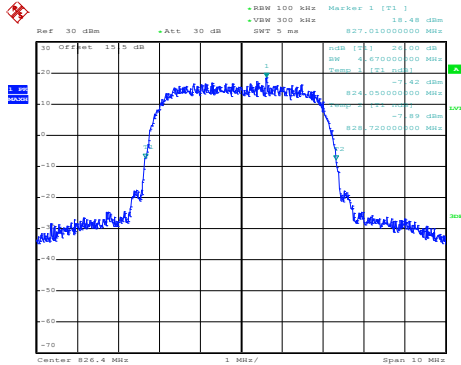

Date: 27.SEP.2017 16:40:41

Date: 27.SEP.2017 16:06:53

Middle Channel

Middle Channel

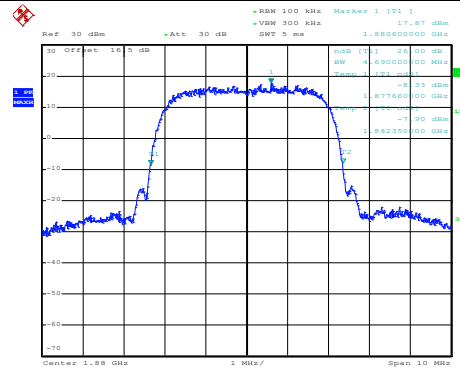
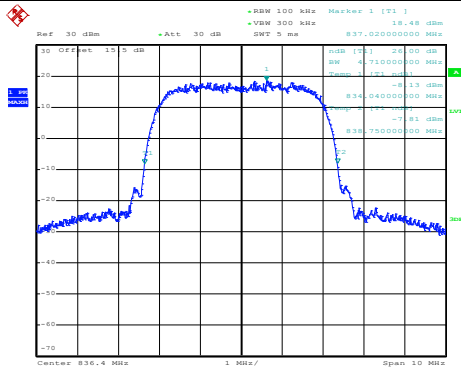

Date: 27.SEP.2017 16:41:09

Date: 27.SEP.2017 16:07:21

Highest Channel

Highest Channel

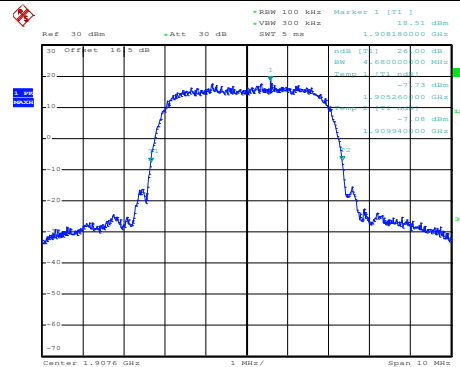
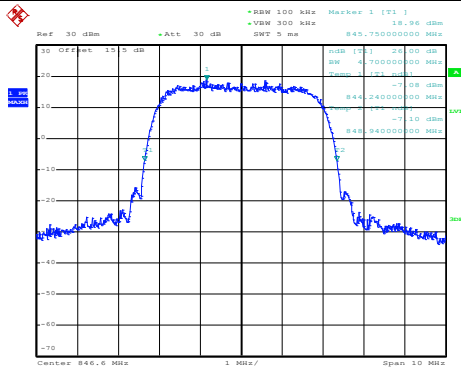

Date: 27.SEP.2017 16:41:37

Date: 27.SEP.2017 16:07:49



WCDMA Band IV (RMC 12.2Kbps)

Lowest Channel

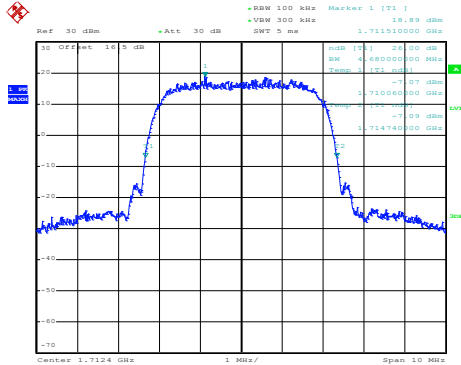

Date: 27.SEP.2017 16:20:59

Middle Channel

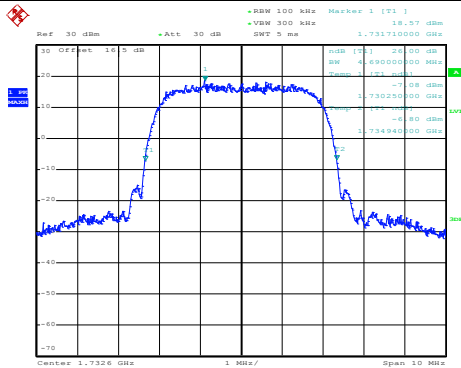

Date: 27.SEP.2017 16:21:27

Highest Channel

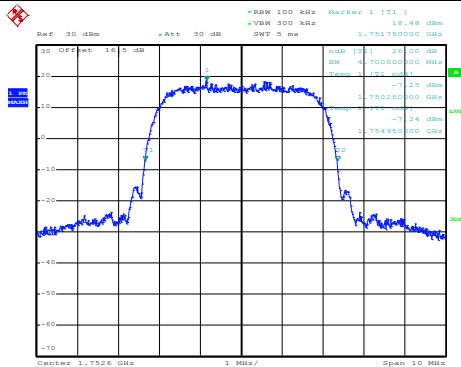

Date: 27.SEP.2017 16:22:23



**Occupied Bandwidth**

Mode	WCDMA Band V	WCDMA Band II	WCDMA Band IV
Mod.	RMC 12.2Kbps	RMC 12.2Kbps	RMC 12.2Kbps
Lowest CH	4.11	4.12	4.12
Middle CH	4.12	4.14	4.12
Highest CH	4.12	4.12	4.11



WCDMA Band V (RMC 12.2Kbps)

WCDMA Band II (RMC 12.2Kbps)

Lowest Channel

Lowest Channel

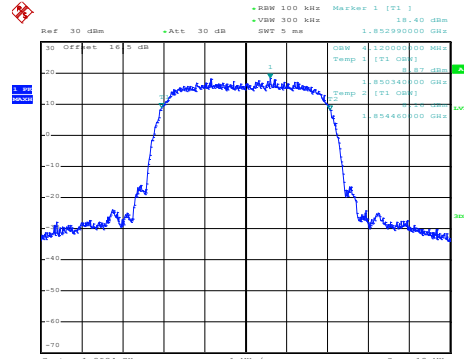
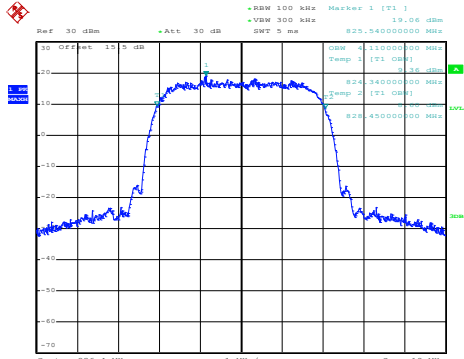

Date: 27.SEP.2017 16:42:07

Date: 27.SEP.2017 16:08:21

Middle Channel

Middle Channel

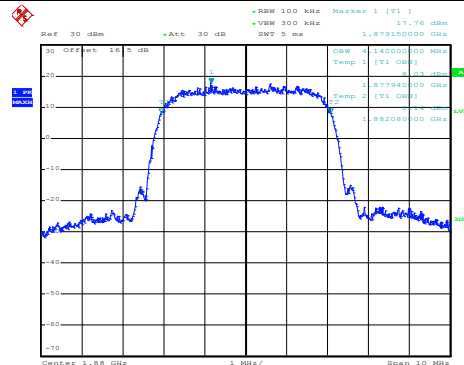
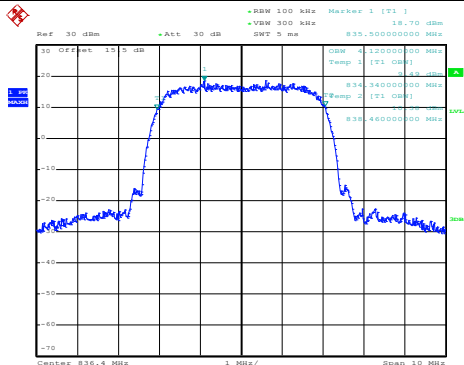

Date: 27.SEP.2017 16:42:35

Date: 27.SEP.2017 16:08:49

Highest Channel

Highest Channel

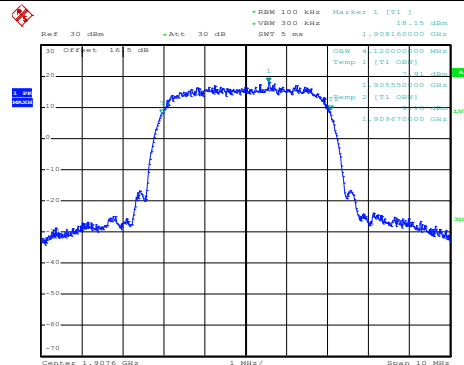
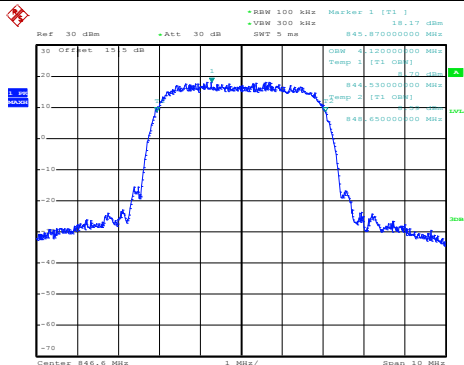

Date: 27.SEP.2017 16:43:03

Date: 27.SEP.2017 16:09:17



WCDMA Band IV (RMC 12.2Kbps)

Lowest Channel

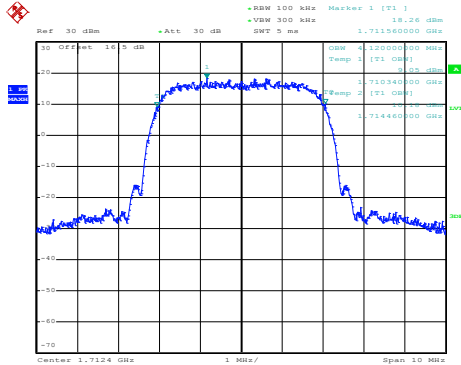

Date: 27.SEP.2017 16:26:43

Middle Channel

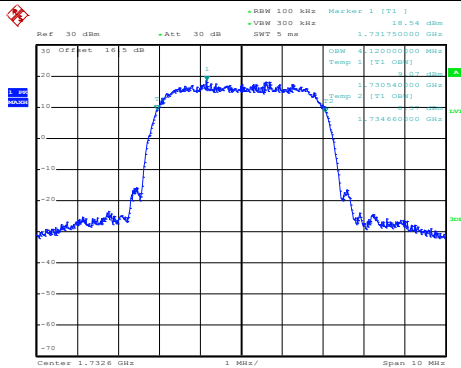

Date: 27.SEP.2017 16:27:11

Highest Channel

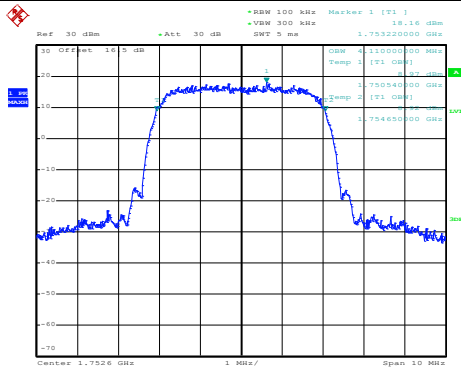

Date: 27.SEP.2017 16:27:39



# Conducted Band Edge

## WCDMA Band V (RMC 12.2Kbps)

### Lowest Band Edge

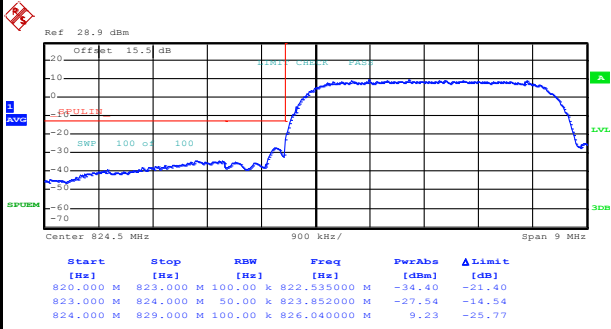

Date: 27.SEP.2017 16:45:58

### Highest Band Edge

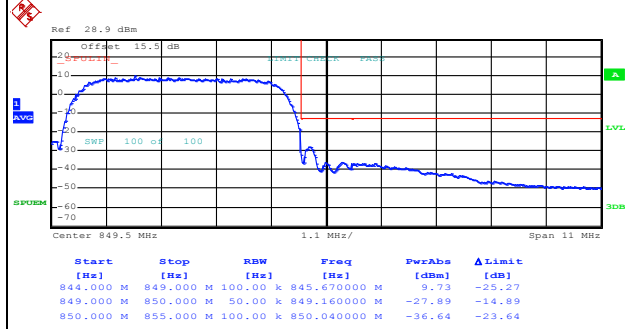

Date: 27.SEP.2017 16:48:40

## WCDMA Band II (RMC 12.2Kbps)

### Lowest Band Edge

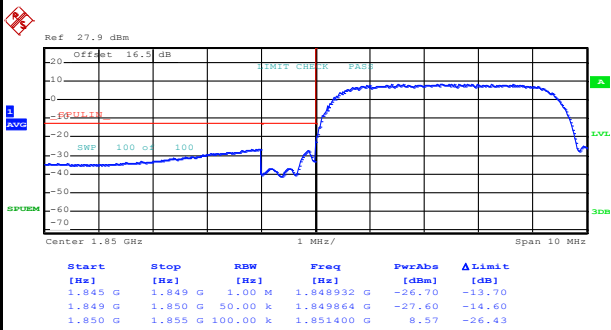

Date: 27.SEP.2017 16:12:04

### Highest Band Edge

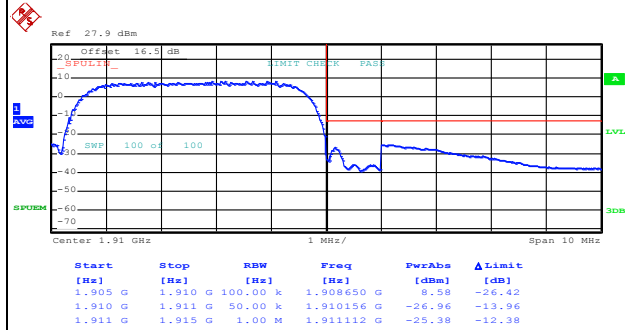

Date: 27.SEP.2017 16:14:46





WCDMA Band IV (RMC 12.2Kbps)

Lowest Band Edge

Highest Band Edge

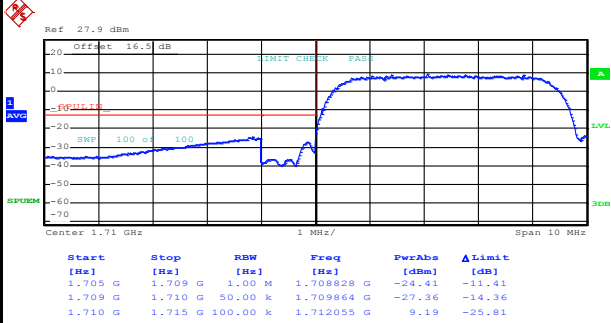

Date: 27.SEP.2017 16:30:44

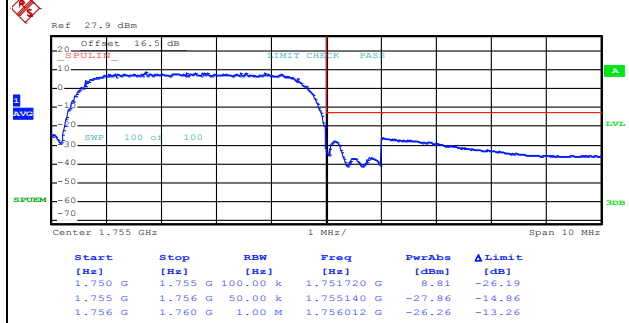

Date: 27.SEP.2017 16:33:26

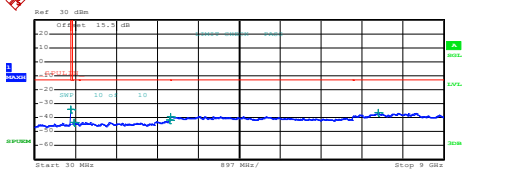
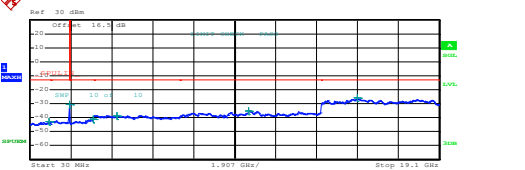
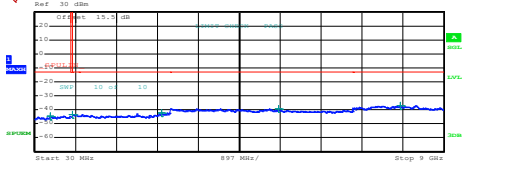
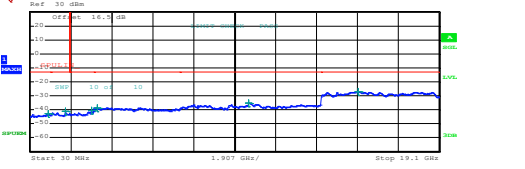
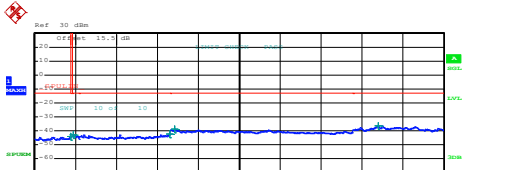
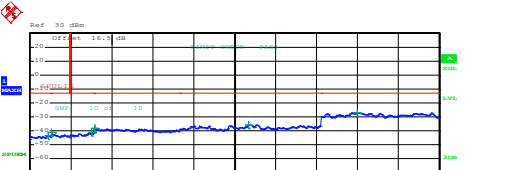

# Conducted Spurious Emission

WCDMA Band V (RMC 12.2Kbps)	WCDMA Band II (RMC 12.2Kbps)																																																																														
Lowest Channel	Lowest Channel																																																																														
 <table border="1" data-bbox="239 660 750 739"> <thead> <tr> <th>Start [Hz]</th> <th>Stop [Hz]</th> <th>RBW [Hz]</th> <th>Freq [Hz]</th> <th>PwrAve [dBm]</th> <th>ΔLimit [dB]</th> </tr> </thead> <tbody> <tr> <td>30.000 M</td> <td>820.000 M</td> <td>1.00 M</td> <td>819.210000 M</td> <td>-44.23</td> <td>-31.23</td> </tr> <tr> <td>855.000 M</td> <td>1.000 G</td> <td>1.00 M</td> <td>895.600000 M</td> <td>-43.62</td> <td>-30.62</td> </tr> <tr> <td>1.000 G</td> <td>3.000 G</td> <td>1.00 M</td> <td>2.990000 G</td> <td>-42.85</td> <td>-28.85</td> </tr> <tr> <td>3.000 G</td> <td>7.000 G</td> <td>1.00 M</td> <td>3.003000 G</td> <td>-39.20</td> <td>-26.20</td> </tr> <tr> <td>7.000 G</td> <td>9.000 G</td> <td>1.00 M</td> <td>7.567000 G</td> <td>-36.28</td> <td>-23.28</td> </tr> </tbody> </table> <p>Date: 27.SEP.2017 16:49:29</p>	Start [Hz]	Stop [Hz]	RBW [Hz]	Freq [Hz]	PwrAve [dBm]	ΔLimit [dB]	30.000 M	820.000 M	1.00 M	819.210000 M	-44.23	-31.23	855.000 M	1.000 G	1.00 M	895.600000 M	-43.62	-30.62	1.000 G	3.000 G	1.00 M	2.990000 G	-42.85	-28.85	3.000 G	7.000 G	1.00 M	3.003000 G	-39.20	-26.20	7.000 G	9.000 G	1.00 M	7.567000 G	-36.28	-23.28	 <table border="1" data-bbox="893 660 1404 739"> <thead> <tr> <th>Start [Hz]</th> <th>Stop [Hz]</th> <th>RBW [Hz]</th> <th>Freq [Hz]</th> <th>PwrAve [dBm]</th> <th>ΔLimit [dB]</th> </tr> </thead> <tbody> <tr> <td>30.000 M</td> <td>1.000 G</td> <td>1.00 M</td> <td>811.001000 M</td> <td>-42.95</td> <td>-29.95</td> </tr> <tr> <td>1.000 G</td> <td>3.845 G</td> <td>1.00 M</td> <td>3.844789 G</td> <td>-30.43</td> <td>-17.43</td> </tr> <tr> <td>3.845 G</td> <td>3.000 G</td> <td>1.00 M</td> <td>2.983322 G</td> <td>-40.82</td> <td>-27.82</td> </tr> <tr> <td>3.000 G</td> <td>7.000 G</td> <td>1.00 M</td> <td>4.072000 G</td> <td>-38.51</td> <td>-25.51</td> </tr> <tr> <td>7.000 G</td> <td>13.600 G</td> <td>1.00 M</td> <td>10.230075 G</td> <td>-35.33</td> <td>-22.33</td> </tr> <tr> <td>13.600 G</td> <td>19.100 G</td> <td>1.00 M</td> <td>15.278188 G</td> <td>-26.03</td> <td>-13.03</td> </tr> </tbody> </table> <p>Date: 27.SEP.2017 16:16:54</p>	Start [Hz]	Stop [Hz]	RBW [Hz]	Freq [Hz]	PwrAve [dBm]	ΔLimit [dB]	30.000 M	1.000 G	1.00 M	811.001000 M	-42.95	-29.95	1.000 G	3.845 G	1.00 M	3.844789 G	-30.43	-17.43	3.845 G	3.000 G	1.00 M	2.983322 G	-40.82	-27.82	3.000 G	7.000 G	1.00 M	4.072000 G	-38.51	-25.51	7.000 G	13.600 G	1.00 M	10.230075 G	-35.33	-22.33	13.600 G	19.100 G	1.00 M	15.278188 G	-26.03	-13.03
Start [Hz]	Stop [Hz]	RBW [Hz]	Freq [Hz]	PwrAve [dBm]	ΔLimit [dB]																																																																										
30.000 M	820.000 M	1.00 M	819.210000 M	-44.23	-31.23																																																																										
855.000 M	1.000 G	1.00 M	895.600000 M	-43.62	-30.62																																																																										
1.000 G	3.000 G	1.00 M	2.990000 G	-42.85	-28.85																																																																										
3.000 G	7.000 G	1.00 M	3.003000 G	-39.20	-26.20																																																																										
7.000 G	9.000 G	1.00 M	7.567000 G	-36.28	-23.28																																																																										
Start [Hz]	Stop [Hz]	RBW [Hz]	Freq [Hz]	PwrAve [dBm]	ΔLimit [dB]																																																																										
30.000 M	1.000 G	1.00 M	811.001000 M	-42.95	-29.95																																																																										
1.000 G	3.845 G	1.00 M	3.844789 G	-30.43	-17.43																																																																										
3.845 G	3.000 G	1.00 M	2.983322 G	-40.82	-27.82																																																																										
3.000 G	7.000 G	1.00 M	4.072000 G	-38.51	-25.51																																																																										
7.000 G	13.600 G	1.00 M	10.230075 G	-35.33	-22.33																																																																										
13.600 G	19.100 G	1.00 M	15.278188 G	-26.03	-13.03																																																																										
Middle Channel	Middle Channel																																																																														
 <table border="1" data-bbox="239 1173 750 1252"> <thead> <tr> <th>Start [Hz]</th> <th>Stop [Hz]</th> <th>RBW [Hz]</th> <th>Freq [Hz]</th> <th>PwrAve [dBm]</th> <th>ΔLimit [dB]</th> </tr> </thead> <tbody> <tr> <td>30.000 M</td> <td>820.000 M</td> <td>1.00 M</td> <td>364.960000 M</td> <td>-44.39</td> <td>-31.39</td> </tr> <tr> <td>855.000 M</td> <td>1.000 G</td> <td>1.00 M</td> <td>829.232000 M</td> <td>-43.19</td> <td>-30.19</td> </tr> <tr> <td>1.000 G</td> <td>3.000 G</td> <td>1.00 M</td> <td>2.817000 G</td> <td>-42.32</td> <td>-29.32</td> </tr> <tr> <td>3.000 G</td> <td>7.000 G</td> <td>1.00 M</td> <td>3.168000 G</td> <td>-39.48</td> <td>-26.48</td> </tr> <tr> <td>7.000 G</td> <td>9.000 G</td> <td>1.00 M</td> <td>8.000000 G</td> <td>-37.03</td> <td>-24.03</td> </tr> </tbody> </table> <p>Date: 27.SEP.2017 16:50:15</p>	Start [Hz]	Stop [Hz]	RBW [Hz]	Freq [Hz]	PwrAve [dBm]	ΔLimit [dB]	30.000 M	820.000 M	1.00 M	364.960000 M	-44.39	-31.39	855.000 M	1.000 G	1.00 M	829.232000 M	-43.19	-30.19	1.000 G	3.000 G	1.00 M	2.817000 G	-42.32	-29.32	3.000 G	7.000 G	1.00 M	3.168000 G	-39.48	-26.48	7.000 G	9.000 G	1.00 M	8.000000 G	-37.03	-24.03	 <table border="1" data-bbox="893 1173 1404 1252"> <thead> <tr> <th>Start [Hz]</th> <th>Stop [Hz]</th> <th>RBW [Hz]</th> <th>Freq [Hz]</th> <th>PwrAve [dBm]</th> <th>ΔLimit [dB]</th> </tr> </thead> <tbody> <tr> <td>30.000 M</td> <td>1.000 G</td> <td>1.00 M</td> <td>881.660000 M</td> <td>-43.09</td> <td>-30.09</td> </tr> <tr> <td>1.000 G</td> <td>3.845 G</td> <td>1.00 M</td> <td>3.686209 G</td> <td>-40.98</td> <td>-27.98</td> </tr> <tr> <td>3.845 G</td> <td>3.000 G</td> <td>1.00 M</td> <td>2.894684 G</td> <td>-40.35</td> <td>-27.35</td> </tr> <tr> <td>3.000 G</td> <td>7.000 G</td> <td>1.00 M</td> <td>3.144000 G</td> <td>-38.57</td> <td>-25.57</td> </tr> <tr> <td>7.000 G</td> <td>13.600 G</td> <td>1.00 M</td> <td>10.231625 G</td> <td>-35.11</td> <td>-22.11</td> </tr> <tr> <td>13.600 G</td> <td>19.100 G</td> <td>1.00 M</td> <td>15.321500 G</td> <td>-26.75</td> <td>-13.75</td> </tr> </tbody> </table> <p>Date: 27.SEP.2017 16:17:39</p>	Start [Hz]	Stop [Hz]	RBW [Hz]	Freq [Hz]	PwrAve [dBm]	ΔLimit [dB]	30.000 M	1.000 G	1.00 M	881.660000 M	-43.09	-30.09	1.000 G	3.845 G	1.00 M	3.686209 G	-40.98	-27.98	3.845 G	3.000 G	1.00 M	2.894684 G	-40.35	-27.35	3.000 G	7.000 G	1.00 M	3.144000 G	-38.57	-25.57	7.000 G	13.600 G	1.00 M	10.231625 G	-35.11	-22.11	13.600 G	19.100 G	1.00 M	15.321500 G	-26.75	-13.75
Start [Hz]	Stop [Hz]	RBW [Hz]	Freq [Hz]	PwrAve [dBm]	ΔLimit [dB]																																																																										
30.000 M	820.000 M	1.00 M	364.960000 M	-44.39	-31.39																																																																										
855.000 M	1.000 G	1.00 M	829.232000 M	-43.19	-30.19																																																																										
1.000 G	3.000 G	1.00 M	2.817000 G	-42.32	-29.32																																																																										
3.000 G	7.000 G	1.00 M	3.168000 G	-39.48	-26.48																																																																										
7.000 G	9.000 G	1.00 M	8.000000 G	-37.03	-24.03																																																																										
Start [Hz]	Stop [Hz]	RBW [Hz]	Freq [Hz]	PwrAve [dBm]	ΔLimit [dB]																																																																										
30.000 M	1.000 G	1.00 M	881.660000 M	-43.09	-30.09																																																																										
1.000 G	3.845 G	1.00 M	3.686209 G	-40.98	-27.98																																																																										
3.845 G	3.000 G	1.00 M	2.894684 G	-40.35	-27.35																																																																										
3.000 G	7.000 G	1.00 M	3.144000 G	-38.57	-25.57																																																																										
7.000 G	13.600 G	1.00 M	10.231625 G	-35.11	-22.11																																																																										
13.600 G	19.100 G	1.00 M	15.321500 G	-26.75	-13.75																																																																										
Highest Channel	Highest Channel																																																																														
 <table border="1" data-bbox="239 1686 750 1765"> <thead> <tr> <th>Start [Hz]</th> <th>Stop [Hz]</th> <th>RBW [Hz]</th> <th>Freq [Hz]</th> <th>PwrAve [dBm]</th> <th>ΔLimit [dB]</th> </tr> </thead> <tbody> <tr> <td>30.000 M</td> <td>820.000 M</td> <td>1.00 M</td> <td>819.210000 M</td> <td>-44.23</td> <td>-31.23</td> </tr> <tr> <td>855.000 M</td> <td>1.000 G</td> <td>1.00 M</td> <td>881.530000 M</td> <td>-43.00</td> <td>-30.00</td> </tr> <tr> <td>1.000 G</td> <td>3.000 G</td> <td>1.00 M</td> <td>2.990000 G</td> <td>-42.49</td> <td>-29.49</td> </tr> <tr> <td>3.000 G</td> <td>7.000 G</td> <td>1.00 M</td> <td>3.106000 G</td> <td>-38.90</td> <td>-25.90</td> </tr> <tr> <td>7.000 G</td> <td>9.000 G</td> <td>1.00 M</td> <td>7.556000 G</td> <td>-36.14</td> <td>-23.14</td> </tr> </tbody> </table> <p>Date: 27.SEP.2017 16:51:00</p>	Start [Hz]	Stop [Hz]	RBW [Hz]	Freq [Hz]	PwrAve [dBm]	ΔLimit [dB]	30.000 M	820.000 M	1.00 M	819.210000 M	-44.23	-31.23	855.000 M	1.000 G	1.00 M	881.530000 M	-43.00	-30.00	1.000 G	3.000 G	1.00 M	2.990000 G	-42.49	-29.49	3.000 G	7.000 G	1.00 M	3.106000 G	-38.90	-25.90	7.000 G	9.000 G	1.00 M	7.556000 G	-36.14	-23.14	 <table border="1" data-bbox="893 1686 1404 1765"> <thead> <tr> <th>Start [Hz]</th> <th>Stop [Hz]</th> <th>RBW [Hz]</th> <th>Freq [Hz]</th> <th>PwrAve [dBm]</th> <th>ΔLimit [dB]</th> </tr> </thead> <tbody> <tr> <td>30.000 M</td> <td>1.000 G</td> <td>1.00 M</td> <td>866.020000 M</td> <td>-43.19</td> <td>-30.19</td> </tr> <tr> <td>1.000 G</td> <td>3.845 G</td> <td>1.00 M</td> <td>3.031265 G</td> <td>-41.33</td> <td>-28.33</td> </tr> <tr> <td>3.845 G</td> <td>3.000 G</td> <td>1.00 M</td> <td>2.903265 G</td> <td>-41.21</td> <td>-28.21</td> </tr> <tr> <td>3.000 G</td> <td>7.000 G</td> <td>1.00 M</td> <td>3.025000 G</td> <td>-38.23</td> <td>-25.23</td> </tr> <tr> <td>7.000 G</td> <td>13.600 G</td> <td>1.00 M</td> <td>10.234675 G</td> <td>-35.76</td> <td>-22.76</td> </tr> <tr> <td>13.600 G</td> <td>19.100 G</td> <td>1.00 M</td> <td>15.280000 G</td> <td>-26.82</td> <td>-13.82</td> </tr> </tbody> </table> <p>Date: 27.SEP.2017 16:18:26</p>	Start [Hz]	Stop [Hz]	RBW [Hz]	Freq [Hz]	PwrAve [dBm]	ΔLimit [dB]	30.000 M	1.000 G	1.00 M	866.020000 M	-43.19	-30.19	1.000 G	3.845 G	1.00 M	3.031265 G	-41.33	-28.33	3.845 G	3.000 G	1.00 M	2.903265 G	-41.21	-28.21	3.000 G	7.000 G	1.00 M	3.025000 G	-38.23	-25.23	7.000 G	13.600 G	1.00 M	10.234675 G	-35.76	-22.76	13.600 G	19.100 G	1.00 M	15.280000 G	-26.82	-13.82
Start [Hz]	Stop [Hz]	RBW [Hz]	Freq [Hz]	PwrAve [dBm]	ΔLimit [dB]																																																																										
30.000 M	820.000 M	1.00 M	819.210000 M	-44.23	-31.23																																																																										
855.000 M	1.000 G	1.00 M	881.530000 M	-43.00	-30.00																																																																										
1.000 G	3.000 G	1.00 M	2.990000 G	-42.49	-29.49																																																																										
3.000 G	7.000 G	1.00 M	3.106000 G	-38.90	-25.90																																																																										
7.000 G	9.000 G	1.00 M	7.556000 G	-36.14	-23.14																																																																										
Start [Hz]	Stop [Hz]	RBW [Hz]	Freq [Hz]	PwrAve [dBm]	ΔLimit [dB]																																																																										
30.000 M	1.000 G	1.00 M	866.020000 M	-43.19	-30.19																																																																										
1.000 G	3.845 G	1.00 M	3.031265 G	-41.33	-28.33																																																																										
3.845 G	3.000 G	1.00 M	2.903265 G	-41.21	-28.21																																																																										
3.000 G	7.000 G	1.00 M	3.025000 G	-38.23	-25.23																																																																										
7.000 G	13.600 G	1.00 M	10.234675 G	-35.76	-22.76																																																																										
13.600 G	19.100 G	1.00 M	15.280000 G	-26.82	-13.82																																																																										



WCDMA Band IV (RMC 12.2Kbps)

Lowest Channel

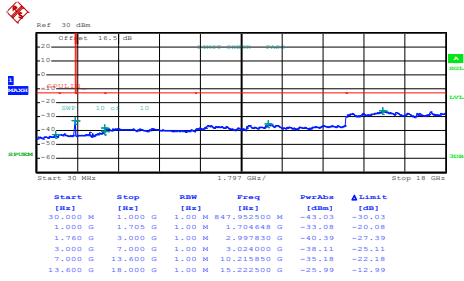

Date: 27.SEP.2017 16:34:14

Middle Channel

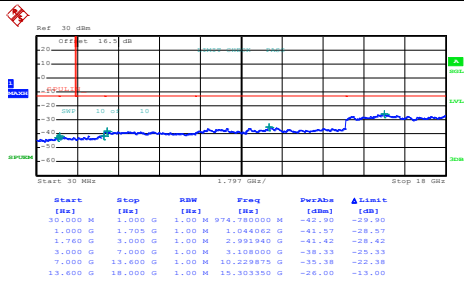

Date: 27.SEP.2017 16:34:59

Highest Channel

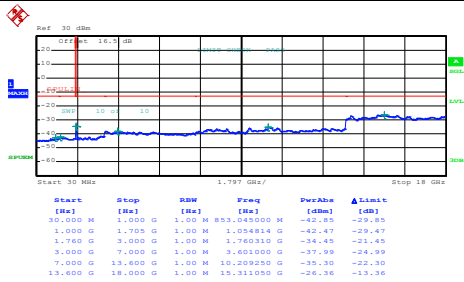

Date: 27.SEP.2017 16:35:45



**Frequency Stability**

Test Conditions	Middle Channel	WCDMA Band V (RMC 12.2Kbps)	Limit 2.5ppm
Temperature (°C)	Voltage (Volt)	Deviation (ppm)	Result
50	Normal Voltage	0.0167	PASS
40	Normal Voltage	0.0155	
30	Normal Voltage	0.0143	
20(Ref.)	Normal Voltage	0.0000	
10	Normal Voltage	0.0012	
0	Normal Voltage	0.0024	
-10	Normal Voltage	0.0012	
-20	Normal Voltage	0.0000	
-30	Normal Voltage	0.0024	
20	Maximum Voltage	0.0012	
20	Normal Voltage	0.0000	
20	Battery End Point	0.0024	



Test Conditions	Middle Channel	WCDMA Band II (RMC 12.2Kbps)	Limit Note 2.
Temperature (°C)	Voltage (Volt)	Deviation (ppm)	Result
50	Normal Voltage	0.0032	PASS
40	Normal Voltage	0.0043	
30	Normal Voltage	0.0011	
20(Ref.)	Normal Voltage	0.0000	
10	Normal Voltage	0.0011	
0	Normal Voltage	0.0005	
-10	Normal Voltage	0.0027	
-20	Normal Voltage	0.0011	
-30	Normal Voltage	0.0000	
20	Maximum Voltage	0.0005	
20	Normal Voltage	0.0000	
20	Battery End Point	0.0011	



Test Conditions	Middle Channel	WCDMA Band IV (RMC 12.2Kbps)	Limit Note 2.
Temperature (°C)	Voltage (Volt)	Deviation (ppm)	Result
50	Normal Voltage	0.0254	PASS
40	Normal Voltage	0.0231	
30	Normal Voltage	0.0173	
20(Ref.)	Normal Voltage	0.0000	
10	Normal Voltage	0.0006	
0	Normal Voltage	0.0035	
-10	Normal Voltage	0.0063	
-20	Normal Voltage	0.0046	
-30	Normal Voltage	0.0017	
20	Maximum Voltage	0.0040	
20	Normal Voltage	0.0000	
20	Battery End Point	0.0046	

**Note:**

- 1. Normal Voltage =3.3V. ; Battery End Point (BEP) =3.135V. ; Maximum Voltage =4.4V.
- 2. The frequency fundamental emissions stay within the authorized frequency block.



### Appendix B. Test Results of Radiated Test

#### Radiated Spurious Emission

#### WCDMA 850

WCDMA 850									
Channel	Frequency ( MHz )	ERP ( dBm )	Limit ( dBm )	Over Limit ( dB )	SPA Reading (dBm)	S.G. Power ( dBm )	TX Cable loss ( dB )	TX Antenna Gain (dBi)	Polarization (H/V)
Lowest	1652	-62.41	-13	-49.41	-72.36	-69.37	0.53	9.63	H
	2479	-60.12	-13	-47.12	-73.56	-68.1	0.65	10.78	H
	3306	-57.80	-13	-44.80	-73.93	-66.91	0.76	12.02	H
									H
									H
									H
									H
	1652	-63.20	-13	-50.20	-72.86	-70.16	0.53	9.63	V
	2479	-59.65	-13	-46.65	-73.58	-67.63	0.65	10.78	V
	3306	-58.21	-13	-45.21	-74.31	-67.32	0.76	12.02	V
									V
									V
									V
									V



WCDMA 850									
Channel	Frequency ( MHz )	ERP ( dBm )	Limit ( dBm )	Over Limit ( dB )	SPA Reading (dBm)	S.G. Power ( dBm )	TX Cable loss ( dB )	TX Antenna Gain (dBi)	Polarization (H/V)
Middle	1672	-63.24	-13	-50.24	-73.33	-70.24	0.53	9.68	H
	2512	-60.24	-13	-47.24	-73.66	-68.24	0.66	10.81	H
	3344	-58.21	-13	-45.21	-74.41	-67.43	0.76	12.13	H
									H
									H
									H
									H
	1672	-63.36	-13	-50.36	-73.05	-70.36	0.53	9.68	V
	2512	-59.90	-13	-46.90	-73.73	-67.9	0.66	10.81	V
	3344	-58.68	-13	-45.68	-74.69	-67.9	0.76	12.13	V
Highest	1696	-62.69	-13	-49.69	-73.07	-69.74	0.53	9.73	H
	2536	-59.60	-13	-46.60	-73.05	-67.61	0.66	10.82	H
	3384	-58.36	-13	-45.36	-74.66	-67.69	0.77	12.25	H
									H
									H
									H
									H
	1696	-63.50	-13	-50.50	-73.26	-70.55	0.53	9.73	V
	2536	-60.01	-13	-47.01	-73.84	-68.02	0.66	10.82	V
	3384	-58.81	-13	-45.81	-74.7	-68.14	0.77	12.25	V
									V
									V
									V
								V	

Remark: Spurious emissions within 30-1000MHz were found more than 20dB below limit line.





**WCDMA 1700**

WCDMA 1700									
Channel	Frequency ( MHz )	EIRP ( dBm )	Limit ( dBm )	Over Limit ( dB )	SPA Reading (dBm)	S.G. Power ( dBm )	TX Cable loss ( dB )	TX Antenna Gain (dBi)	Polarization (H/V)
Lowest	3426	-47.62	-13	-34.62	-64.78	-59.22	0.77	12.38	H
	5139	-55.15	-13	-42.15	-75.85	-66.65	0.97	12.48	H
	6852	-52.86	-13	-39.86	-76.59	-63.65	0.83	11.63	H
									H
									H
									H
									H
	3426	-43.26	-13	-30.26	-60.26	-54.86	0.77	12.38	V
	5139	-54.25	-13	-41.25	-75.12	-65.75	0.97	12.48	V
	6852	-52.45	-13	-39.45	-76.63	-63.24	0.83	11.63	V
									V
									V
									V
									V
Middle	3468	-46.49	-13	-33.49	-63.69	-58.22	0.78	12.50	H
	5202	-55.13	-13	-42.13	-75.95	-66.74	0.99	12.60	H
	6936	-51.73	-13	-38.73	-75.6	-62.15	1.02	11.44	H
									H
									H
									H
									H
	3468	-42.34	-13	-29.34	-59.93	-54.07	0.78	12.50	V
	5202	-55.02	-13	-42.02	-76	-66.63	0.99	12.60	V
	6936	-51.87	-13	-38.87	-76.12	-62.29	1.02	11.44	V
									V
									V
									V
									V



WCDMA 1700									
Channel	Frequency ( MHz )	EIRP ( dBm )	Limit ( dBm )	Over Limit ( dB )	SPA Reading (dBm)	S.G. Power ( dBm )	TX Cable loss ( dB )	TX Antenna Gain (dBi)	Polarization (H/V)
Highest	3504	-44.84	-13	-31.84	-62.09	-56.66	0.78	12.60	H
	5256	-55.54	-13	-42.54	-76.51	-67.24	1.01	12.71	H
	7008	-51.41	-13	-38.41	-75.44	-61.53	1.17	11.29	H
									H
									H
									H
									H
	3504	-41.25	-13	-28.25	-59.47	-53.07	0.78	12.60	V
	5256	-55.27	-13	-42.27	-76.38	-66.97	1.01	12.71	V
	7008	-51.11	-13	-38.11	-75.44	-61.23	1.17	11.29	V
									V
									V
									V
									V

Remark: Spurious emissions within 30-1000MHz were found more than 20dB below limit line.



**WCDMA 1900**

WCDMA 1900									
Channel	Frequency ( MHz )	EIRP ( dBm )	Limit ( dBm )	Over Limit ( dB )	SPA Reading (dBm)	S.G. Power ( dBm )	TX Cable loss ( dB )	TX Antenna Gain (dBi)	Polarization (H/V)
Lowest	3705	-57.37	-13	-44.37	-74.41	-69.16	0.72	12.52	H
	5557	-54.10	-13	-41.10	-75.91	-66.27	1.00	13.17	H
	7410	-51.44	-13	-38.44	-76.52	-60.82	1.18	10.56	H
									H
									H
									H
									H
	3705	-55.28	-13	-42.28	-73.49	-67.07	0.72	12.52	V
	5557	-54.32	-13	-41.32	-76.25	-66.49	1.00	13.17	V
	7410	-51.23	-13	-38.23	-76.16	-60.61	1.18	10.56	V
									V
									V
									V
									V
Middle	3760	-56.85	-13	-43.85	-74	-68.66	0.69	12.50	H
	5640	-54.18	-13	-41.18	-75.9	-66.31	0.98	13.12	H
	7520	-51.31	-13	-38.31	-76.23	-60.59	1.18	10.46	H
									H
									H
									H
									H
	3760	-53.53	-13	-40.53	-71.89	-65.34	0.69	12.50	V
	5640	-53.97	-13	-40.97	-75.86	-66.1	0.98	13.12	V
	7520	-51.45	-13	-38.45	-76.42	-60.73	1.18	10.46	V
									V
									V
									V
									V



WCDMA 1900									
Channel	Frequency ( MHz )	EIRP ( dBm )	Limit ( dBm )	Over Limit ( dB )	SPA Reading (dBm)	S.G. Power ( dBm )	TX Cable loss ( dB )	TX Antenna Gain (dBi)	Polarization (H/V)
Highest	3816	-56.48	-13	-43.48	-73.75	-68.27	0.69	12.47	H
	5724	-54.32	-13	-41.32	-76.07	-66.39	0.99	13.07	H
	7632	-50.79	-13	-37.79	-75.97	-60.38	1.18	10.77	H
									H
									H
									H
									H
	3816	-53.01	-13	-40.01	-71.5	-64.8	0.69	12.47	V
	5724	-54.06	-13	-41.06	-76.02	-66.13	0.99	13.07	V
	7632	-50.54	-13	-37.54	-75.47	-60.13	1.18	10.77	V
									V
									V
									V
									V

Remark: Spurious emissions within 30-1000MHz were found more than 20dB below limit line.