





RADIO TEST REPORT

Test Report No.: 15128810H-A-R1

Customer	Keyence Corporation
Description of EUT	Level sensor
Model Number of EUT	FR-LMH20
FCC ID	RF41754F
Test Regulation	FCC Part 15 Subpart C
Test Result	Complied
Issue Date	February 16, 2024
Remarks	-

Representative test engineer	Approved by
	
Yuichiro Yamazaki Engineer	Ryota Yamanaka Engineer
 	
CERTIFICATE 5107.02	
<input type="checkbox"/> The testing in which "Non-accreditation" is displayed is outside the accreditation scopes in UL Japan, Inc.	
<input checked="" type="checkbox"/> There is no testing item of "Non-accreditation".	

Report Cover Page - Form-ULID-003532 (DCS:13-EM-F0429) Issue# 23.0

ANNOUNCEMENT

- This test report shall not be reproduced in full or partial, without the written approval of UL Japan, Inc.
- The results in this report apply only to the sample tested. (Laboratory was not involved in sampling.)
- This sample tested is in compliance with the limits of the above regulation.
- The test results in this test report are traceable to the national or international standards.
- This test report must not be used by the customer to claim product certification, approval, or endorsement by the A2LA accreditation body.
- This test report covers Radio technical requirements.
It does not cover administrative issues such as Manual or non-Radio test related Requirements. (if applicable)
- The all test items in this test report are conducted by UL Japan, Inc. Ise EMC Lab.
- The opinions and the interpretations to the result of the description in this report are outside scopes where UL Japan, Inc. has been accredited.
- The information provided by the customer for this report is identified in SECTION 1.
- The laboratory is not responsible for information provided by the customer which can impact the validity of the results.
- For test report(s) referred in this report, the latest version (including any revisions) is always referred.

REVISION HISTORY

Original Test Report No.: 15128810H-A

This report is a revised version of 15128810H-A. 15128810H-A is replaced with this report.

Revision	Test Report No.	Date	Page Revised Contents
- (Original)	15128810H-A	February 13, 2024	-
1	15128810H-A-R1	February 16, 2024	Correction of the Upper frequency value of 99 % Occupied Bandwidth data.
1	15128810H-A-R1	February 16, 2024	Correction of unconformity between calculations and figures (P.24 and 25) of EIRP data.

Reference: Abbreviations (Including words undescribed in this report)

A2LA	The American Association for Laboratory Accreditation	ICES	Interference-Causing Equipment Standard
AC	Alternating Current	IEC	International Electrotechnical Commission
AFH	Adaptive Frequency Hopping	IEEE	Institute of Electrical and Electronics Engineers
AM	Amplitude Modulation	IF	Intermediate Frequency
Amp, AMP	Amplifier	ILAC	International Laboratory Accreditation Conference
ANSI	American National Standards Institute	ISED	Innovation, Science and Economic Development Canada
Ant, ANT	Antenna	ISO	International Organization for Standardization
AP	Access Point	JAB	Japan Accreditation Board
ASK	Amplitude Shift Keying	LAN	Local Area Network
Atten., ATT	Attenuator	LIMS	Laboratory Information Management System
AV	Average	MCS	Modulation and Coding Scheme
BPSK	Binary Phase-Shift Keying	MRA	Mutual Recognition Arrangement
BR	Bluetooth Basic Rate	N/A	Not Applicable
BT	Bluetooth	NIST	National Institute of Standards and Technology
BT LE	Bluetooth Low Energy	NS	No signal detect.
BW	BandWidth	NSA	Normalized Site Attenuation
Cal Int	Calibration Interval	NVLAP	National Voluntary Laboratory Accreditation Program
CCK	Complementary Code Keying	OBW	Occupied Band Width
Ch., CH	Channel	OFDM	Orthogonal Frequency Division Multiplexing
CISPR	Comite International Special des Perturbations Radioelectriques	P/M	Power meter
CW	Continuous Wave	PCB	Printed Circuit Board
DBPSK	Differential BPSK	PER	Packet Error Rate
DC	Direct Current	PHY	Physical Layer
D-factor	Distance factor	PK	Peak
DFS	Dynamic Frequency Selection	PN	Pseudo random Noise
DQPSK	Differential QPSK	PRBS	Pseudo-Random Bit Sequence
DSSS	Direct Sequence Spread Spectrum	PSD	Power Spectral Density
EDR	Enhanced Data Rate	QAM	Quadrature Amplitude Modulation
EIRP, e.i.r.p.	Equivalent Isotropically Radiated Power	QP	Quasi-Peak
EMC	ElectroMagnetic Compatibility	QPSK	Quadri-Phase Shift Keying
EMI	ElectroMagnetic Interference	RBW	Resolution Band Width
EN	European Norm	RDS	Radio Data System
ERP, e.r.p.	Effective Radiated Power	RE	Radio Equipment
EU	European Union	RF	Radio Frequency
EUT	Equipment Under Test	RMS	Root Mean Square
Fac.	Factor	RSS	Radio Standards Specifications
FCC	Federal Communications Commission	Rx	Receiving
FHSS	Frequency Hopping Spread Spectrum	SA, S/A	Spectrum Analyzer
FM	Frequency Modulation	SG	Signal Generator
Freq.	Frequency	SVSWR	Site-Voltage Standing Wave Ratio
FSK	Frequency Shift Keying	TR	Test Receiver
GFSK	Gaussian Frequency-Shift Keying	Tx	Transmitting
GNSS	Global Navigation Satellite System	VBW	Video BandWidth
GPS	Global Positioning System	Vert.	Vertical
Hori.	Horizontal	WLAN	Wireless LAN

CONTENTS	PAGE
SECTION 1: Customer Information.....	5
SECTION 2: Equipment Under Test (EUT)	5
SECTION 3: Test specification, procedures & results	6
SECTION 4: Operation of EUT during testing.....	9
SECTION 5: Conducted Emission	13
SECTION 6: Radiated Emissions	14
SECTION 7: Frequency Stability	19
APPENDIX 1: Test data	20
Conducted Emission	20
Duty Cycle, Off Time Requirement	21
99 % Occupied Bandwidth.....	22
EIRP	24
Spurious Emissions	26
Frequency Stability	28
Group Instillation.....	43
APPENDIX 2: Test instruments.....	44
APPENDIX 3: Photographs of test setup	46
Conducted Emission	46
EIRP	47
Spurious Emissions	48
Worst Case Position	51
Frequency Stability	52

SECTION 1: Customer Information

Company Name	Keyence Corporation
Address	1-3-14, Higashinakajima Higashiyodogwa-ku, Osaka, 533-8555 Japan
Telephone Number	+81-6-6379-1111
Contact Person	Takashi Suzuki

The information provided by the customer is as follows;

- Customer, Description of EUT, Model Number of EUT, FCC ID on the cover and other relevant pages
- Operating/Test Mode(s) (Mode(s)) on all the relevant pages
- SECTION 1: Customer Information
- SECTION 2: Equipment Under Test (EUT) other than the Receipt Date and Test Date
- SECTION 4: Operation of EUT during testing

SECTION 2: Equipment Under Test (EUT)

2.1 Identification of EUT

Description	Level sensor
Model Number	FR-LMH20
Serial Number	Refer to SECTION 4.2
Condition	Production prototype (Not for Sale: This sample is equivalent to mass-produced items.)
Modification	No Modification by the test lab
Receipt Date	December 28, 2023
Test Date	January 9 to 17, 2024

2.2 Product Description

General Specification

Rating	DC 24 V
Operating temperature	-20 deg. C to 60 deg. C

Radio Specification

Equipment Type	Transceiver
Frequency of Operation	60.5 GHz (Center) (58 GHz to 63 GHz)
Bandwidth	5 GHz
Type of Modulation	Frequency modulation (FMCW)
Usage location	Fixed Field disturbance sensor

SECTION 3: Test specification, procedures & results

3.1 Test Specification

Test Specification	FCC Part 15 Subpart C The latest version on the first day of the testing period
Title	FCC 47CFR Part15 Radio Frequency Device Subpart C Intentional Radiators Section 15.207 Conducted limits. Section 15.255 Operation within the band 57-71 GHz.

3.2 Procedures and results

Item	Test Procedure	Specification	Worst margin	Results	Remarks
Conducted Emission	FCC: ANSI C63.10 2020, 6. Standard test methods	FCC: Section 15.207	31.14 dB, 0.68345 MHz, AV Phase N	Complied	-
Duty cycle, Off Time Requirement	FCC: -	FCC: Section FCC 15.255 (c)(2)(iii)(B)	N/A	Complied	Radiated
6dB Bandwidth	FCC: Section 15.255(e) (2) ANSI C63.10 2020, 9. Procedures for testing millimeter-wave systems	FCC: Section 15.255(e) (1)	See data.	N/A	*1)
99 % Occupied Bandwidth	FCC: ANSI C 63.10:2020, 9. Procedures for testing millimeter-wave systems	FCC: -	See data.	Complied	Radiated *2)
EIRP	FCC: ANSI C63.10 2020, 9. Procedures for testing millimeter-wave systems	FCC: Section 15.255 (c)(2)(iii)(B)	See data.	Complied	Radiated
Spurious Emissions	FCC: ANSI C63.10 2020, 6. Standard test methods 9. Procedures for testing millimeter-wave systems	FCC: Section 15.255(d) Section 15.209	7.2 dB 504.0 MHz, Vertical QP	Complied	Radiated
Frequency Stability	FCC: ANSI C63.10 2020, 9. Procedures for testing millimeter-wave systems	FCC: Section 15.255(f)	See data.	Complied	Radiated
Group Installation	FCC: -	FCC: Section 15.255(h)	See data.	N/A	*3)

Note: UL Japan, Inc.'s EMI Work Procedures: Work Instructions-ULID-003591 and Work Instructions-ULID-003593.
*1) The test is not applicable since the application of Section 15.255(e) is unnecessary due to the application of Section 15.255(c)(2)(iii)(B).
*2) The test was performed according to the General Measurement Guidance of TCB Workshop Part 15.255 Rules Amendment October 25, 2023.
*3) The test is not applicable since there are no external phase-locking inputs in this EUT.

FCC Part 15.31 (e)

This EUT provides the stable voltage constantly to RF Module regardless of input voltage. Therefore, this EUT complies with the requirement.

FCC Part 15.203 Antenna requirement

The antenna is not removable from the EUT. Therefore, the equipment complies with the antenna requirement of Section 15.203.

3.3 Addition to standard

No addition, exclusion nor deviation has been made from the standard.

3.4 Uncertainty

Measurement uncertainty is not taken into account when stating conformity with a specified requirement.
Note: When margins obtained from test results are less than the measurement uncertainty, the test results may exceed the limit.

The following uncertainties have been calculated to provide a confidence level of 95 % using a coverage factor $k = 2$.

Conducted emission

Using Item	Frequency range	Uncertainty (+/-)
AMN (LISN)	0.009 MHz to 0.15 MHz	3.7 dB
	0.15 MHz to 30 MHz	3.3 dB

Radiated emission

Measurement distance	Frequency range		Uncertainty (+/-)
3 m	9 kHz to 30 MHz		3.3 dB
10 m			3.1 dB
3 m	30 MHz to 200 MHz	Horizontal	4.8 dB
		Vertical	5.0 dB
	200 MHz to 1000 MHz	Horizontal	5.1 dB
		Vertical	6.2 dB
10 m	30 MHz to 200 MHz	Horizontal	4.8 dB
		Vertical	4.8 dB
	200 MHz to 1000 MHz	Horizontal	4.9 dB
		Vertical	5.0 dB
3 m	1 GHz to 6 GHz	Test Receiver	5.0 dB
		Spectrum analyzer	4.9 dB
	6 GHz to 18 GHz	Test Receiver	5.3 dB
		Spectrum analyzer	5.2 dB
1 m	10 GHz to 26.5 GHz	Spectrum analyzer	5.5 dB
	26.5 GHz to 40 GHz	Spectrum analyzer	5.4 dB
0.5 m	26.5 GHz to 40 GHz	Spectrum analyzer	5.4 dB
10 m	1 GHz to 18 GHz	Test Receiver	5.3 dB
>= 0.5 m	40 GHz to 50 GHz		4.2 dB
>= 0.5 m	50 GHz to 75 GHz		5.9 dB
>= 0.5 m	75 GHz to 110 GHz		5.5 dB
>= 3.8 cm	110 GHz to 170 GHz		5.8 dB
>= 2.5 cm	170 GHz to 260 GHz		5.0 dB

3.5 Test Location

UL Japan, Inc. Ise EMC Lab.
4383-326 Asama-cho, Ise-shi, Mie-ken 516-0021 Japan
Telephone: +81-596-24-8999
A2LA Certificate Number: 5107.02 / FCC Test Firm Registration Number: 884919
ISED Lab Company Number: 2973C / CAB identifier: JP0002

Test site	Width x Depth x Height (m)	Size of reference ground plane (m) / horizontal conducting plane	Other rooms	Maximum measurement distance
No.1 semi-anechoic chamber	19.2 x 11.2 x 7.7	7.0 x 6.0	No.1 Power source room	10 m
No.2 semi-anechoic chamber	7.5 x 5.8 x 5.2	4.0 x 4.0	-	3 m
No.3 semi-anechoic chamber	12.0 x 8.5 x 5.9	6.8 x 5.75	No.3 Preparation room	3 m
No.3 shielded room	4.0 x 6.0 x 2.7	N/A	-	-
No.4 semi-anechoic chamber	12.0 x 8.5 x 5.9	6.8 x 5.75	No.4 Preparation room	3 m
No.4 shielded room	4.0 x 6.0 x 2.7	N/A	-	-
No.5 semi-anechoic chamber	6.0 x 6.0 x 3.9	6.0 x 6.0	-	-
No.5 measurement room	6.4 x 6.4 x 3.0	6.4 x 6.4	-	-
No.6 shielded room	4.0 x 4.5 x 2.7	4.0 x 4.5	-	-
No.6 measurement room	4.75 x 5.4 x 3.0	4.75 x 4.15	-	-
No.7 shielded room	4.7 x 7.5 x 2.7	4.7 x 7.5	-	-
No.8 measurement room	3.1 x 5.0 x 2.7	3.1 x 5.0	-	-
No.9 measurement room	8.8 x 4.6 x 2.8	2.4 x 2.4	-	-
No.10 shielded room	3.8 x 2.8 x 2.8	3.8 x 2.8	-	-
No.11 measurement room	4.0 x 3.4 x 2.5	N/A	-	-
No.12 measurement room	2.6 x 3.4 x 2.5	N/A	-	-
Large Chamber	16.9 x 22.1 x 10.17	16.9 x 22.1	-	10 m
Small Chamber	5.3 x 6.69 x 3.59	5.3 x 6.69	-	-

* Size of vertical conducting plane (for Conducted Emission test): 2.0 m x 3.0 m for No.1, No.2, No.3, and No.4 semi-anechoic chambers and No.3 and No.4 shielded rooms.

3.6 Test data, RF Exposure, Test instruments, and Test set up

Refer to APPENDIX.

SECTION 4: Operation of EUT during testing

4.1 Operating Mode(s)

Mode	Test Item
Test mode (Tx) - Symbol Pattern A - Symbol Pattern B - Symbol Pattern C - Symbol Pattern D - Symbol Pattern E	Conducted Emission ^{*1)} Duty cycle, Off Time Requirement ^{*2)} 99 % Occupied Bandwidth EIRP Spurious Emissions ^{*1)} Frequency Stability
*Power of the EUT was set by the software as follows; Power Setting: 31 Software: Ver226 (Date: 2024.01.09, Storage location: EUT memory)	
*This setting of software is the worst case. Any conditions under the normal use do not exceed the condition of setting. In addition, end users cannot change the settings of the output power of the product.	

*1) The test was performed with the Symbol Pattern A as representative.
Since the Symbol Pattern A which has the widest OBW and the highest power was taken as the worst.

*2) The test data of Symbol Pattern A was shown as representative since all symbol patterns was the same logic.

4.2 Configuration and peripherals

Conducted Emission test

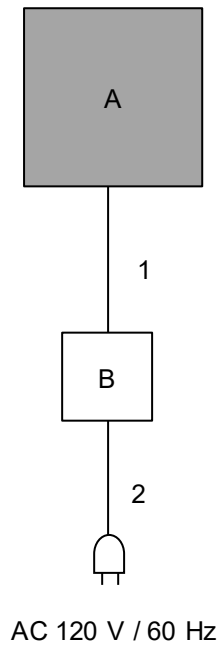

* Cabling and setup(s) were taken into consideration and test data was taken under worse case conditions.

Description of EUT and Support equipment

No.	Item	Model number	Serial number	Manufacturer	Remarks
A	Level sensor	FR-LMH20	LHM39	Keyence Corporation	EUT
B	DC power supply	RPE-4323	824B168G2	RS COMPONENTS LTD	-

List of cables used

No.	Name	Length (m)	Shield		Remarks
			Cable	Connector	
1	DC & Signal Cable	10.3	Unshielded	Unshielded	-
2	AC Cable	1.0	Unshielded	Unshielded	-

Spurious Emissions test

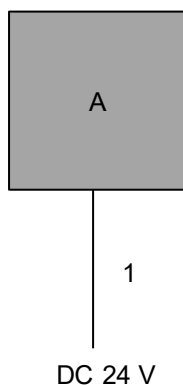

* Cabling and setup(s) were taken into consideration and test data was taken under worse case conditions.

Description of EUT

No.	Item	Model number	Serial number	Manufacturer	Remarks
A	Level sensor	FR-LMH20	LHM39	Keyence Corporation	EUT

List of cables used

No.	Name	Length (m)	Shield		Remarks
			Cable	Connector	
1	DC & Signal Cable	30.2	Unshielded	Unshielded	-

Radiated Emission tests except for Spurious Emissions

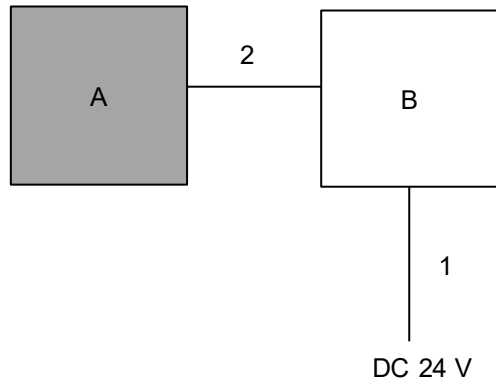

* Cabling and setup(s) were taken into consideration and test data was taken under worse case conditions.

Description of EUT and Support equipment

No.	Item	Model number	Serial number	Manufacturer	Remarks
A	Level sensor	FR-LMH20	LHM39	Keyence Corporation	EUT
B	Jig	Power cable	1	Keyence Corporation	-

List of cables used

No.	Name	Length (m)	Shield		Remarks
			Cable	Connector	
1	DC & Signal Cable	2.4	Unshielded	Unshielded	-
2	DC & Signal Cable	0.6	Unshielded	Unshielded	-

SECTION 5: Conducted Emission

Test Procedure and Conditions

EUT was placed on a urethane platform of nominal size, 1.0 m by 1.5 m, raised 0.8 m above the conducting ground plane.

The rear of tabletop was located 40 cm to the vertical conducting plane. The rear of EUT, including peripherals aligned and flushed with rear of tabletop. All other surfaces of tabletop were at least 80 cm from any other grounded conducting surface. EUT was located 80 cm from a Line Impedance Stabilization Network (LISN) / Artificial mains Network (AMN) and excess AC cable was bundled in center.

For the tests on EUT with other peripherals (as a whole system)

I/O cables that were connected to the peripherals were bundled in center. They were folded back and forth forming a bundle 30 cm to 40 cm long and were hanged at a 40 cm height to the ground plane. All unused 50 ohm connectors of the LISN (AMN) were resistivity terminated in 50 ohm when not connected to the measuring equipment.

The AC Mains Terminal Continuous disturbance Voltage has been measured with the EUT in a Semi Anechoic Chamber.

The EUT was connected to a LISN (AMN).

An overview sweep with peak detection has been performed.

The test results and limit are rounded off to one decimal place, so some differences might be observed.

Detector : QP and CISPR AV
Measurement Range : 0.15 MHz to 30 MHz
Test Data : APPENDIX
Test Result : Pass

Figure 1: Test Setup

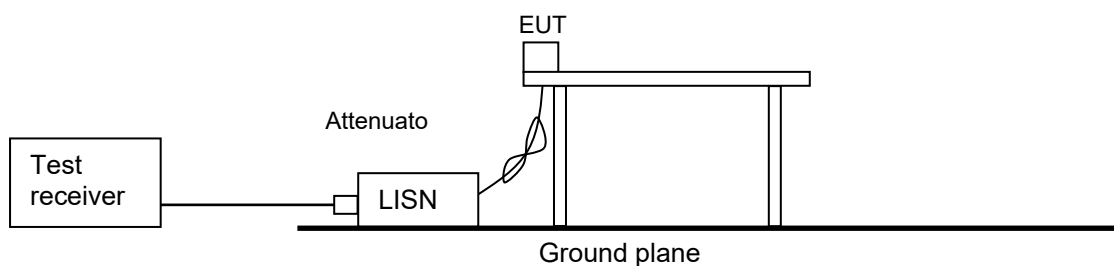

SECTION 6: Radiated Emissions

Test Procedure

[For below 30 MHz]

The EUT was placed on a urethane platform of nominal size, 1.0 m by 1.5 m, raised 0.8 m above the conducting ground plane.

The Radiated Electric Field Strength has been measured in a Semi Anechoic Chamber with absorbent materials lined on a ground plane.

The loop antenna was fixed height at 1.0 m.

The EUT was rotated a full revolution in order to obtain the maximum value of the electric field intensity.

The measurements were performed for vertical polarization (antenna angle: 0 deg., 45 deg., 90 deg., 135 deg., and 180 deg.) and horizontal polarization.

*Refer to Figure 1 about Direction of the Loop Antenna.

[For above 30 MHz, up to 1 GHz]

The EUT was placed on a urethane platform of nominal size, 1.0 m by 1.5 m, raised 0.8 m above the conducting ground plane. The Radiated Electric Field Strength has been measured in a Semi Anechoic Chamber with a ground plane.

The height of the measuring antenna varied between 1 m and 4 m and EUT was rotated a full revolution in order to obtain the maximum value of the electric field strength.

[For above 1 GHz, up to 40 GHz]

The EUT was placed on a urethane platform of nominal size, 0.5 m by 0.5 m, raised 1.5 m above the conducting ground plane.

The Radiated Electric Field Strength has been measured in a Semi Anechoic Chamber with absorbent materials lined on a ground plane.

The height of the measuring antenna varied between 1 m and 4 m and EUT was rotated a full revolution in order to obtain the maximum value of the electric field strength.

Test antenna was aimed at the EUT for receiving the maximum signal and always kept within the illumination area of the 3 dB beamwidth of the antenna.

The measurements were performed for both vertical and horizontal antenna polarization with the Test Receiver, or the Spectrum Analyzer.

The measurements were made with the following detector function of the test receiver and the Spectrum analyzer.

The test was made with the detector (RBW/VBW) in the following table.

Test Antennas are used as below;

Frequency	Below 30 MHz	30 MHz to 200 MHz	200 MHz to 1 GHz	Above 1 GHz
Antenna Type	Loop	Biconical	Logperiodic	Horn

Frequency	From 9 kHz to 90 kHz and From 110 kHz to 150 kHz	From 90 kHz to 110 kHz	From 150 kHz to 490 kHz	From 490 kHz to 30 MHz	From 30 MHz to 1 GHz	From 1 GHz to 40 GHz	
Instrument used	Test Receiver					Spectrum Analyzer	
Detector	PK / AV	QP	PK / AV	QP	QP	PK *a)	AV
IF Bandwidth	200 Hz	200 Hz	9 kHz	9 kHz	120 kHz	RBW: 1 MHz VBW: 3 MHz	RBW: 1 MHz VBW: 1 / T

*a) The Spectrum Analyzer was used in 3 dB resolution bandwidth.

[Test setup]
 Below 1 GHz

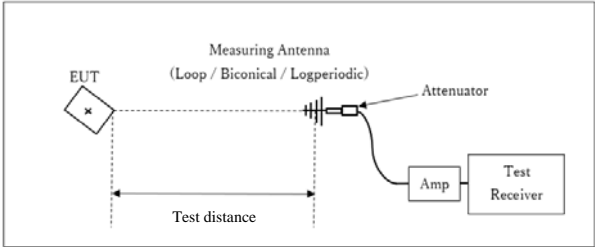

Test Distance: 3 m

× : Center of turn table

1 GHz to 10 GHz

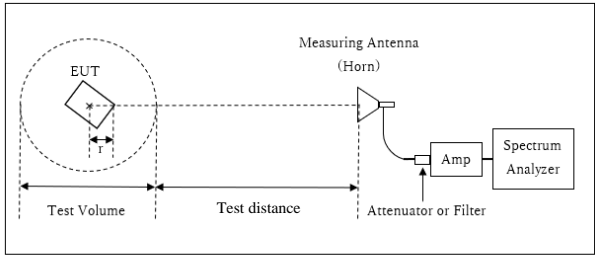

Distance Factor: $20 \times \log(4.0 \text{ m} / 3.0 \text{ m}) = 2.50 \text{ dB}$
 * Test Distance: $(3 + \text{SVSWR Volume} / 2) - r = 4.0 \text{ m}$

SVSWR Volume : 2.0 m
 (SVSWR Volume has been calibrated based on CISPR 16-1-4.)
 $r = 0.0 \text{ m}$

*The test was performed with $r = 0.0 \text{ m}$ since EUT is small and it was the rather conservative condition.

r : Radius of an outer periphery of EUT
 × : Center of turn table

10 GHz to 40 GHz

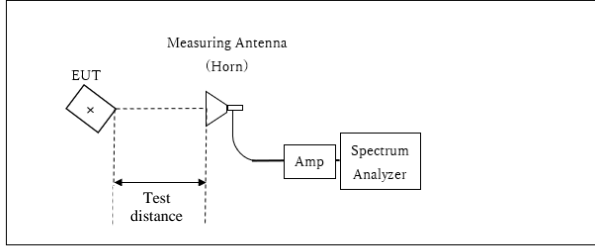

Distance Factor: $20 \times \log(1.0 \text{ m}^* / 3.0 \text{ m}) = -9.5 \text{ dB}$
 *Test Distance: 1 m

× : Center of turn table

Figure 1: Direction of the Loop Antenna

Side View (Vertical)

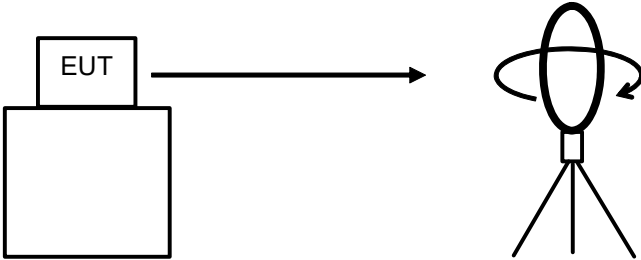

Top View (Horizontal)

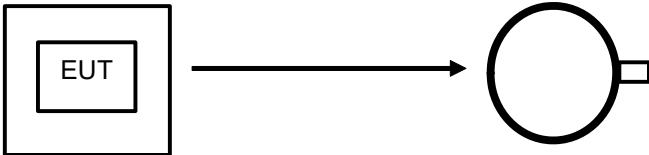

Antenna was not rotated.

Top View (Vertical)

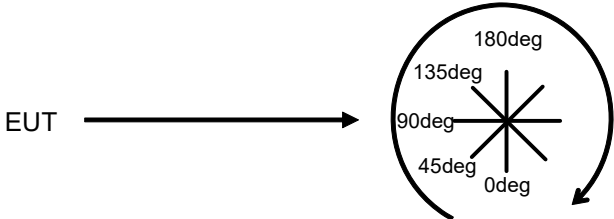

Front side: 0 deg.
Forward direction: clockwise

[Above 40 GHz]

The test was performed based on “Procedures for testing millimeter-wave systems” of ANSI C63.10-2020.

The EUT was placed on a urethane platform, raised 1.5 m above the conducting ground plane. The measurements were performed on handheld method.

Set spectrum analyzer RBW, VBW, span, etc., to the proper values. Note these values. Enable two traces—one set to “clear write,” and the other set to “max hold.” Begin hand-held measurements with the test antenna (horn) at a distance of 1 m from the EUT in a horizontally polarized position. Slowly adjust its position, entirely covering the plane 1 m from the EUT. Observation of the two active traces on the spectrum analyzer will allow refined horn positioning at the point(s) of maximum field intensity. Repeat with the horn in a vertically polarized position. If the emission cannot be detected at 1 m, reduce the RBW to increase system sensitivity. Note the value. If the emission still cannot be detected, move the horn closer to the EUT, noting the distance at which a measurement is made.

Note the maximum level indicated on the spectrum analyzer. Adjust this level, if necessary, by the antenna gain, filter loss, conversion loss of the external mixer and gain of LNA used, at the frequency under investigation. Calculate the field strength of the emission at the measurement distance from the Friis’ transmission equation.

Frequency	40 GHz to 50 GHz	50 GHz to 75 GHz	75 GHz to 110 GHz	110 GHz to 200 GHz
Final measurement distance with 1 MHz Peak detector	1.00 m	0.75 m	0.50 m	0.01 m

[Test setup]
 40 GHz to 200 GHz

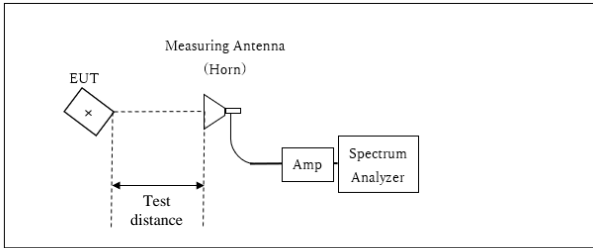

x : Center of turn table

*Test Distance: Refer to the above table.

[About fundamental measurement]

Test Procedure

The test was performed based on “Procedures for testing millimeter-wave systems” of ANSI C63.10-2020.

The carrier levels were measured in the far field. The distance of the far field was calculated from follow equation.

$$r = \frac{2D^2}{\lambda}$$

where

r is the distance from the radiating element of the EUT to the edge of the far field, in m
D is the largest dimension of both the radiating element and the test antenna (horn), in m
Lambda is the wavelength of the emission under investigation [300/f (MHz)], in m

Frequency [GHz]	Wavelength <i>Lambda</i> λ [mm]	Maximum Dimention			Far Field Boundary <i>r</i> [m]	Tested Distance [m]
		EUT [m]	Test Antenna [m]	Maximum <i>D</i> [m]		
64	4.7	0.03710	0.03759	0.03759	0.603	0.75

The Peak Power results was applied to the desensitization correction factor.
 The derivation of the FMCW Desensitization Factor is given in Keysight Application Note 5952 1039 Appendix B.

Desensitization factor was calculated from follow equation;

$$\alpha = \frac{1}{\sqrt[4]{1 + \left(\frac{2\ln(2)}{\pi}\right)^2 \left(\frac{F_s}{T_s B^2}\right)^2}}$$

and

FMCW Desensitization factor = 20 Log (α)

Where

- F_s* is FMCW Sweep Width or Chirp Width, is used the actual measurement value.
- T_s* is FMCW Sweep Time, is referred to the values in the specifications.
- B* is -3dB Bandwidth of Gaussian RBW Filter, is used the actual measurement value.

Symbol Pattern	<i>F_s</i> [MHz]	<i>T_s</i> [us]	<i>B</i> [MHz]	α	FMCW Desensitization factor [dB]
A	4994.3	1024.0	8.0	0.9997	-0.0025
B	4005.6	1024.0	8.0	0.9998	-0.0016
C	3993.9	1024.0	8.0	0.9998	-0.0016
D	3017.0	1024.0	8.0	0.9999	-0.0009
E	3005.2	1024.0	8.0	0.9999	-0.0009

The test results and limit are rounded off to one decimal place, so some differences might be observed.

Measurement range : 9 kHz to 200 GHz
Test data : APPENDIX
Test result : Pass

SECTION 7: Frequency Stability

Test Procedure

The external mixer was placed in side of the temperature chamber's drain hole.

The power supply was set to nominal operating voltage (100 %), and the spectrum mask was measured at 20 deg. C. After that, EUT power supply was varied between 85 % and 115 % of nominal voltage and the frequency excursion of the EUT emission mask was recorded.

The EUT operating temperature was raised to 50 deg. C., and the frequency excursion of the EUT emission mask was recorded. Measurements were repeated at each 10 deg. C. decrement down to -20 deg. C.

Both lower and upper frequencies of the 99 % OBW were recorded.

Test data : **APPENDIX**
Test result : **Pass**

APPENDIX 1: Test data

Conducted Emission

Test place	Ise EMC Lab.
Semi Anechoic Chamber	No. 3
Date	January 15, 2024
Temperature / Humidity	23 deg. C / 30 % RH
Engineer	Yuichiro Yamazaki
Mode	Tx Symbol Pattern A

Limit : FCC_Part 15 Subpart C(15.207)

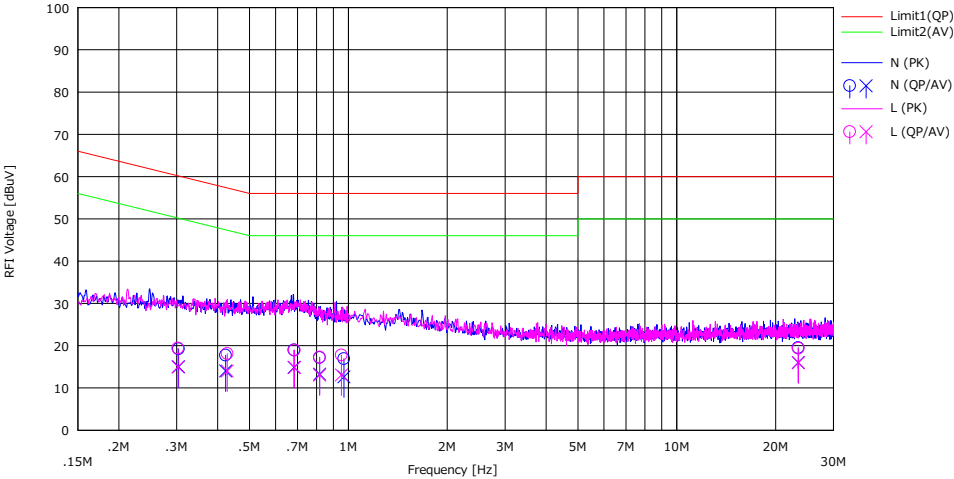

No.	Freq. [MHz]	Reading		LISN [dB]	LOSS [dB]	Results		Limit		Margin		Phase	Comment
		(QP) [dBuV]	(AV) [dBuV]			(QP) [dBuV]	(AV) [dBuV]	(QP) [dB]	(AV) [dB]				
1	0.30392	6.00	1.80	0.06	13.15	19.21	15.01	60.14	50.14	40.93	35.13	N	
2	0.42275	4.50	0.80	0.06	13.16	17.72	14.02	57.39	47.39	39.67	33.37	N	
3	0.68345	5.70	1.60	0.07	13.19	18.96	14.86	56.00	46.00	37.04	31.14	N	
4	0.81747	3.90	0.00	0.07	13.20	17.17	13.27	56.00	46.00	38.83	32.73	N	
5	0.96913	3.60	-0.70	0.08	13.22	16.90	12.60	56.00	46.00	39.10	33.40	N	
6	23.43610	5.10	1.60	0.51	13.89	19.50	16.00	60.00	50.00	40.50	34.00	N	
7	0.30295	6.20	1.80	0.04	13.15	19.39	14.99	60.16	50.16	40.77	35.17	L	
8	0.42784	4.90	0.80	0.04	13.16	18.10	14.00	57.29	47.29	39.19	33.29	L	
9	0.68535	5.70	1.60	0.04	13.19	18.93	14.83	56.00	46.00	37.07	31.17	L	
10	0.81703	4.00	-0.20	0.05	13.20	17.25	13.05	56.00	46.00	38.75	32.95	L	
11	0.95243	4.50	-0.20	0.05	13.22	17.77	13.07	56.00	46.00	38.23	32.93	L	
12	23.46181	5.00	1.60	0.48	13.89	19.37	15.97	60.00	50.00	40.63	34.03	L	

CHART: WITH FACTOR Peak hold data. CALCULATION : RESULT = READING + C.F (LISN + CABLE + ATT)
Except for the above table: adequate margin data below the limits.

*The test result is rounded off to one or two decimal places, so some differences might be observed.

Duty Cycle, Off Time Requirement

Test place	Ise EMC Lab.
Semi Anechoic Chamber	No. 3
Date	January 10, 2024
Temperature / Humidity	20 deg. C / 38 % RH
Engineer	Junki Nagatomi
Mode	Tx Symbol Pattern A

Measured/ Declared	Tx ON +Tx OFF Time [ms]	Tx ON Time [ms]	Tx OFF Time [ms]	Duty Result [%]	Duty Factor [dB]	The ratio of Tx OFF Time Result [%]	Regulation Time [ms]	Tx OFF Time within Regulation Time Limit [ms]	The ratio of Tx OFF Time Limit [%]	Result
Measured	139.999	2.059	137.940	1.47	-18.33	98.53	33.00	16.50	≥ 50	Pass
Declared *	139.998	2.048	137.950	1.46	-18.35	98.54	-	-	-	-

Calculating formula:

$Tx\ OFF\ Time = Tx\ ON + Tx\ OFF\ Time - Tx\ ON\ Time$
 $Duty = (Tx\ ON\ Time / Tx\ ON + Tx\ OFF\ Time) * 100$
 $Duty\ factor = 10 * \log (Tx\ ON + Tx\ OFF\ Time / Tx\ ON\ Time)$
 $The\ ratio\ of\ Tx\ OFF\ Time = (Tx\ OFF\ Time / Tx\ ON + Tx\ OFF\ Time) * 100$

* See the application document.

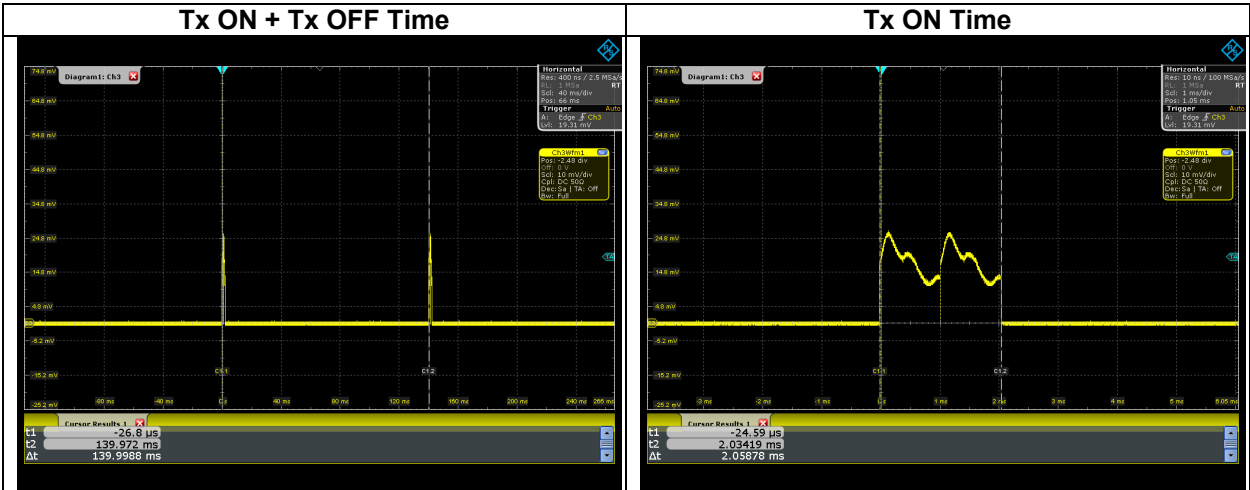

99 % Occupied Bandwidth

Test place	Ise EMC Lab.
Semi Anechoic Chamber	No. 2
Date	January 9, 2024
Temperature / Humidity	16 deg. C / 49 % RH
Engineer	Junki Nagatomi
Mode	Tx

Symbol Pattern	Center Frequency [GHz]	Frequency error [MHz]	99% OBW [GHz]	99 % OBW		Lower Limit [GHz]	Upper Limit [GHz]	Result
				The Lower frequency [GHz]	The Upper frequency [GHz]			
A	60.5	-21.950	4.9943	57.9809	62.9752	57	64	Pass
B	60.0	-17.290	4.0056	57.9799	61.9855			Pass
C	61.0	-11.980	3.9939	58.9911	62.9850			Pass
D	59.5	-16.291	3.0170	57.9752	60.9922			Pass
E	60.5	-9.001	3.0052	58.9884	61.9936			Pass

Calculation:

The Lower frequency = Center frequency + Frequency error - 99 % OBW / 2

The Upper frequency = Center frequency + Frequency error + 99 % OBW / 2

99 % Occupied Bandwidth

[Data]

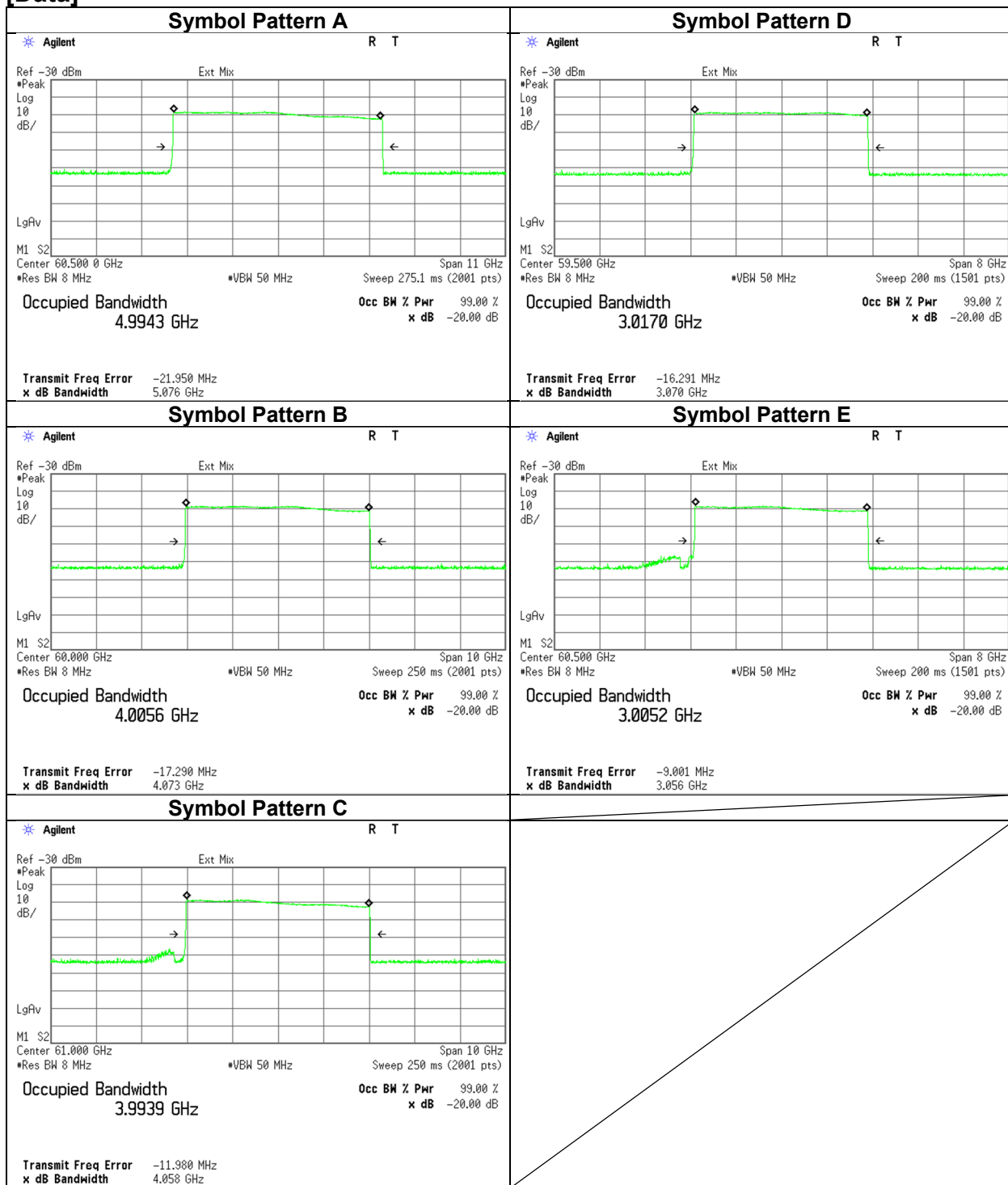

The measurement was performed with Peak detector and Max Hold since the duty cycle was not 100 %.

EIRP

Test place	Ise EMC Lab.
Semi Anechoic Chamber	No. 3
Date	January 11, 2024
Temperature / Humidity	21 deg. C / 38 % RH
Engineer	Nachi Konegawa
Mode	Tx

Symbol Pattern	Frequency [GHz]	Reading (Peak) [dBm]	Rx Ant. Gain [dBi]	LNA Gain [dB]	Mixer Conv. Loss [dB]	Tested Distance [m]	FSL [dB]	FMCW Desensitization Factor [dB]	EIRP		Limit [dBm]	Margin [dB]
									[dBm]	[mW]		
A	57.986	-43.57	23.57	26.01	45.95	0.75	65.21	-0.0025	18.01	63.24	20	1.99
B	58.215	-43.73	23.60	25.90	45.99	0.75	65.24	-0.0016	18.01	63.24	20	1.99
C	58.990	-44.22	23.73	25.53	46.08	0.75	65.36	-0.0016	17.96	62.52	20	2.04
D	58.170	-43.78	23.60	25.92	45.98	0.75	65.24	-0.0009	17.92	61.94	20	2.08
E	58.992	-44.31	23.73	25.53	46.08	0.75	65.36	-0.0009	17.87	61.24	20	2.13

Calculating formula:

$$FSL \text{ (Free Space path Loss)} = 10 * \log_{10}((4 * \pi * \text{Tested Distance} / \text{Lambda})^2)$$

$$EIRP = \text{Reading} - \text{Rx Ant. Gain} - \text{LNA Gain} + \text{Mixer Conv. Loss} + \text{FSL} - \text{FMCW Desensitization Factor}$$

EIRP

[Data]

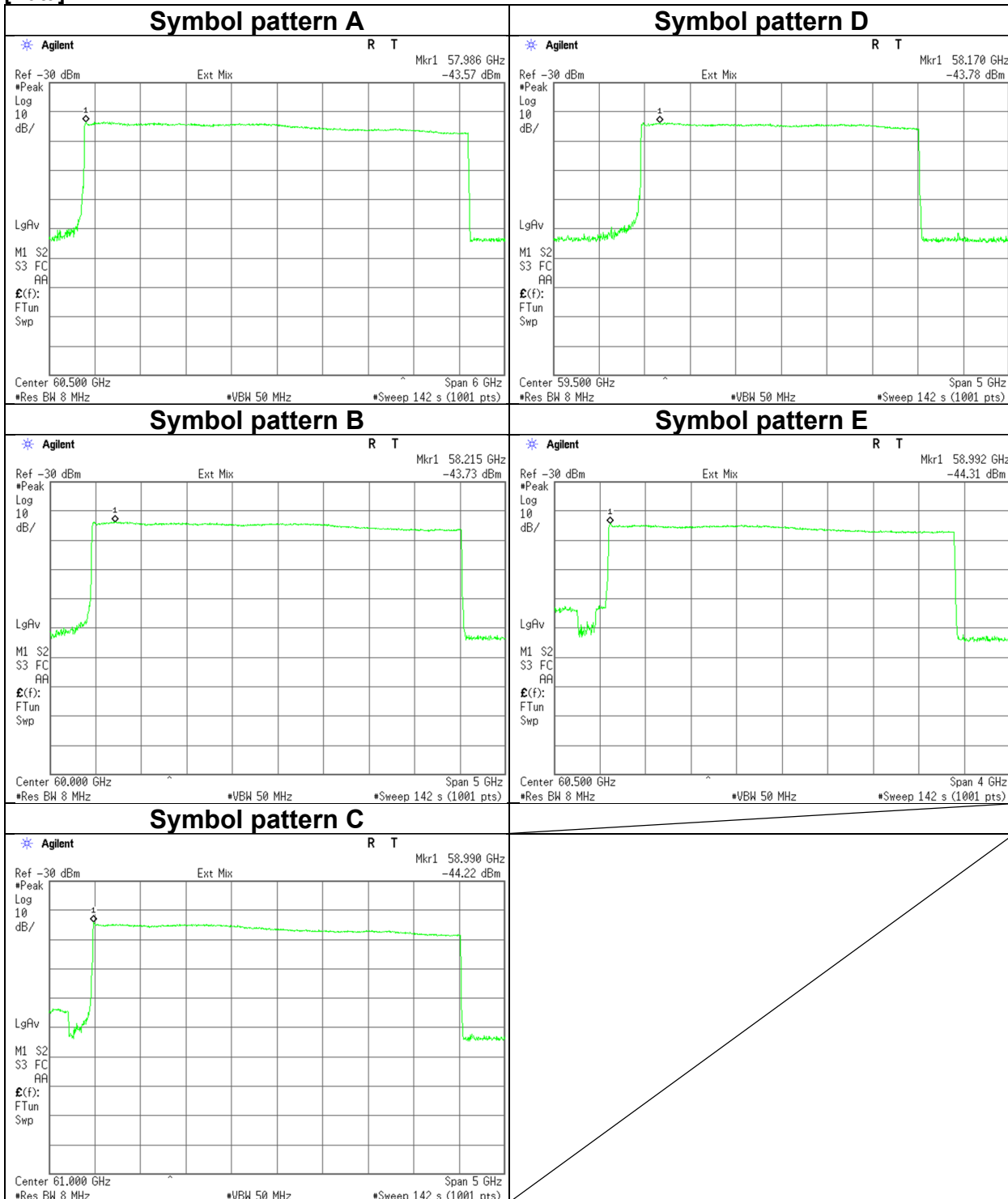

Spurious Emissions (Below 40 GHz)

Test place	Ise EMC Lab.			
Semi Anechoic Chamber	No. 3	No. 3	No. 3	No. 3
Date	January 12, 2024	January 14, 2024	January 14, 2024	January 15, 2024
Temperature / Humidity	22 deg. C / 34 % RH	21 deg. C / 38 % RH	21 deg. C / 33 % RH	23 deg. C / 30 % RH
Engineer	Nachi Konegawa	Junki Nagatomi	Yuichiro Yamazaki	Yuichiro Yamazaki
Mode	(18 GHz to 40 GHz)	(1 GHz to 18 GHz)	(30 MHz to 1 GHz)	(Below 30 MHz)
	Tx Symbol Pattern A			

Polarity	Frequency	Reading (QP / PK)	Reading (AV)	Ant. Factor	Loss	Gain	Result (QP / PK)	Result (AV)	Limit (QP / PK)	Limit (AV)	Margin (QP / PK)	Margin (AV)	Remark
[Hori/Vert]	[MHz]	[dBuV]	[dBuV]	[dB/m]	[dB]	[dB]	[dBuV/m]	[dBuV/m]	[dBuV/m]	[dBuV/m]	[dB]	[dB]	
Hori.	408.0	30.2	-	16.0	10.4	32.0	24.6	-	46.0	-	21.4	-	
Hori.	504.0	30.9	-	17.8	10.9	32.0	27.7	-	46.0	-	18.3	-	
Hori.	552.0	26.2	-	17.8	11.2	32.0	23.2	-	46.0	-	22.8	-	
Hori.	600.0	33.3	-	19.4	11.5	32.0	32.2	-	46.0	-	13.8	-	
Hori.	720.0	34.9	-	20.1	12.1	31.8	35.3	-	46.0	-	10.7	-	
Hori.	936.0	25.0	-	22.0	13.1	30.7	29.4	-	46.0	-	16.6	-	
Vert.	408.0	39.3	-	16.0	10.4	32.0	33.7	-	46.0	-	12.3	-	
Vert.	504.0	42.0	-	17.8	10.9	32.0	38.8	-	46.0	-	7.2	-	
Vert.	552.0	34.2	-	17.8	11.2	32.0	31.2	-	46.0	-	14.8	-	
Vert.	600.0	39.3	-	19.4	11.5	32.0	38.2	-	46.0	-	7.8	-	
Vert.	720.0	34.3	-	20.1	12.1	31.8	34.7	-	46.0	-	11.3	-	
Vert.	936.0	26.9	-	22.0	13.1	30.7	31.3	-	46.0	-	14.7	-	

Result = Reading + Ant Factor + Loss (Cable+Attenuator+Filter+Distance factor(above 1 GHz)) - Gain(Amplifier)

*Other frequency noises omitted in this report were not seen or had enough margin (more than 20 dB).

*QP detector was used up to 1GHz.

Distance factor: 1 GHz - 10 GHz 20log (4.0 m / 3.0 m) = 2.5 dB
 10 GHz - 40 GHz 20log (1.0 m / 3.0 m) = -9.5 dB

[Plot data, Worst case]

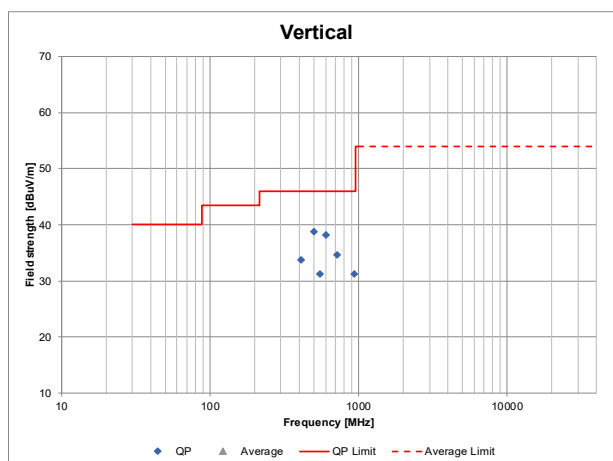
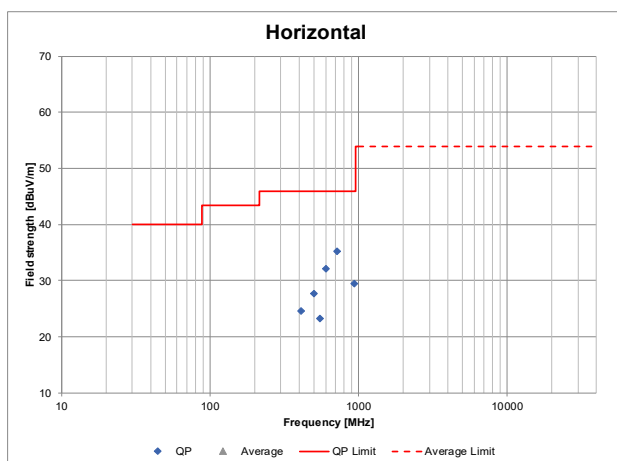

Spurious Emissions (Above 40 GHz)

Test place	Ise EMC Lab.		
Semi Anechoic Chamber	No. 3	No. 3	No. 3
Date	January 11, 2024	January 12, 2024	January 12, 2024
Temperature / Humidity	21 deg. C / 38 % RH	21 deg. C / 36 % RH	22 deg. C / 34 % RH
Engineer	Nachi Konegawa	Junki Nagatomi	Nachi Konegawa
	(50 GHz to 75 GHz)	(75 GHz to 170 GHz)	(170 GHz to 200 GHz, 40 GHz to 50 GHz)
Mode	Tx Symbol Pattern A		

Freq.	Reading (Peak)	Rx Ant. Gain	Filter Loss	LNA Gain	Mixer Conv. Loss	IF Amp. Gain	IF Cable Loss	Test Distance D	FSL	EIRP		Power density Result at 3 m (Peak)	Limit Average	Margin Average	Remarks
[GHz]	[dBm]	[dBi]	[dB]	[dB]	[dB]	[dB]	[dB]	[m]	[dB]	[dBm]	[mW]	[pW/cm ²]	[pW/cm ²]	[dB]	
44.794	-51.63	21.72	0.00	32.09	0.00	0.00	7.99	1.00	65.47	-31.99	0.000633	0.56	90	22.06	NS
49.470	-49.68	22.39	0.00	32.03	0.00	0.00	8.43	1.00	66.33	-29.34	0.001165	1.03	90	19.42	NS
50.734	-67.60	22.82	0.00	26.36	46.53	32.09	0.07	0.75	64.05	-38.22	0.000151	0.13	90	28.29	NS
72.742	-68.22	24.41	0.00	21.43	50.18	32.09	0.07	0.75	67.18	-28.72	0.001344	1.19	90	18.79	NS
78.140	-57.74	23.16	0.58	37.03	39.88	31.97	0.10	0.50	64.28	-45.06	0.000031	0.03	90	35.14	NS
88.550	-57.69	23.88	0.43	33.28	41.99	31.97	0.10	0.50	65.36	-38.94	0.000128	0.11	90	29.02	NS
95.717	-57.24	24.22	0.39	34.74	42.91	31.97	0.10	0.50	66.04	-38.73	0.000134	0.12	90	28.81	NS
101.160	-56.41	24.53	0.52	33.73	43.72	31.97	0.10	0.50	66.52	-35.78	0.000264	0.23	90	25.85	NS
108.444	-57.06	24.79	0.99	22.70	43.91	31.97	0.10	0.50	67.13	-24.39	0.003639	3.22	90	14.47	NS
117.765	-85.76	22.56	0.00	18.43	54.15	0.00	0.00	0.01	33.86	-38.74	0.000134	0.12	90	28.82	NS
119.861	-86.33	22.64	0.00	18.48	50.65	0.00	0.00	0.01	34.02	-42.79	0.000053	0.05	90	32.86	NS
121.646	-86.42	22.69	0.00	20.46	48.66	0.00	0.00	0.01	34.14	-46.77	0.000021	0.02	90	36.85	NS
130.229	-87.13	22.95	0.00	20.13	51.39	0.00	0.00	0.01	34.74	-44.08	0.000039	0.03	90	34.16	NS
135.769	-87.23	23.10	0.00	19.43	51.91	0.00	0.00	0.01	35.10	-42.76	0.000053	0.05	90	32.83	NS
143.376	-87.67	23.24	0.00	18.77	53.93	0.00	0.00	0.01	35.57	-40.18	0.000096	0.08	90	30.26	NS
153.429	-88.39	23.36	0.00	17.12	56.24	0.00	0.00	0.01	36.16	-36.47	0.000226	0.20	90	26.54	NS
156.136	-88.91	23.37	0.00	17.12	56.50	0.00	0.00	0.01	36.31	-36.59	0.000219	0.19	90	26.67	NS
167.549	-89.34	23.41	0.00	13.79	60.99	0.00	0.00	0.01	36.92	-28.62	0.001373	1.21	90	18.70	NS
174.335	-86.24	22.50	0.00	0.00	57.53	0.00	0.00	0.01	37.27	-13.94	0.040406	35.73	90	4.01	NS
182.886	-87.02	22.69	0.00	0.00	59.04	0.00	0.00	0.01	37.69	-12.99	0.050250	44.43	90	3.07	NS
193.067	-86.65	22.90	0.00	0.00	56.66	0.00	0.00	0.01	38.16	-14.73	0.033635	29.74	90	4.81	NS
195.084	-87.20	22.94	0.00	0.00	58.57	0.00	0.00	0.01	38.25	-13.32	0.046518	41.13	90	3.40	NS

Calculation:

FSL (Free Space path Loss) = $10 * \log ((4 * \text{Pi} * D / \lambda)^2)$

EIRP = Reading - Rx Ant. gain + Filter loss - LNA gain + Mixer conversion loss - IF Amp. gain + IF Cable loss + FSL

Power density Result at 3 m = $\text{EIRP} / (4 * \text{Pi} * 300^2)$

These calculation results are same as results which were calculated with formulas described in the Section 9 of ANSI C63.10-2020.

- The equipment were not used for factor 0 dB of the data sheets.
- The IF Cable loss is included in Mixer loss, so the factor of data sheet were 0 dB.

NS: No signal detected.

[Plot data, Worst case]

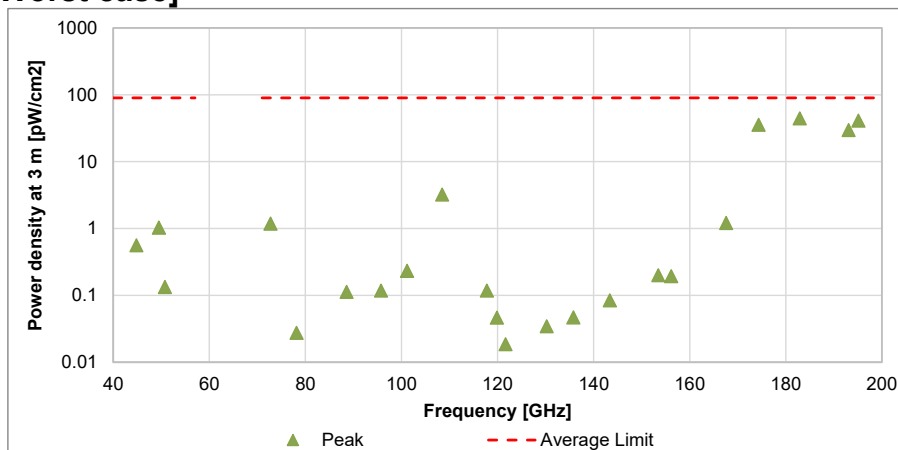

*The peak result is less than the average limit.

Frequency Stability

Test place	Ise EMC Lab. No. 6 Measurement Room
Date	January 17, 2024
Temperature / Humidity	24 deg. C / 32 % RH
Engineer	Yuichiro Yamazaki
Mode	Tx Symbol Pattern A

Test Condition		Center frequency [GHz]	Frequency error [MHz]	99% OBW [GHz]	99 % OBW		Remarks
Temperature [deg. C]	Power Supply [V]				The Lower frequency [GHz]	The Upper frequency [GHz]	
50	24.0	60.5	-26.454	4.9914	57.9778	62.9692	
40	24.0	60.5	-25.097	4.9933	57.9783	62.9716	
30	24.0	60.5	-25.289	4.9935	57.9780	62.9715	
20	24.0	60.5	-20.967	4.9893	57.9844	62.9737	
20	20.4	60.5	-21.829	4.9964	57.9800	62.9764	85 % of the rated voltage, DC 24 V* 0.85
20	27.6	60.5	-22.925	4.9952	57.9795	62.9747	115 % of the rated voltage, DC 24 V* 1.15
10	24.0	60.5	-17.960	4.9968	57.9836	62.9804	
0	24.0	60.5	-18.731	4.9928	57.9849	62.9777	
-10	24.0	60.5	-20.342	5.0000	57.9797	62.9797	
-20	24.0	60.5	-18.026	4.9984	57.9828	62.9812	

Calculation:

The Lower frequency = Center frequency + Frequency error - 99 % OBW / 2

The Upper frequency = Center frequency + Frequency error + 99 % OBW / 2

Fundamental emissions were contained within the frequency band 57 GHz to 64 GHz during all conditions of operation.

Frequency Stability

[Data]

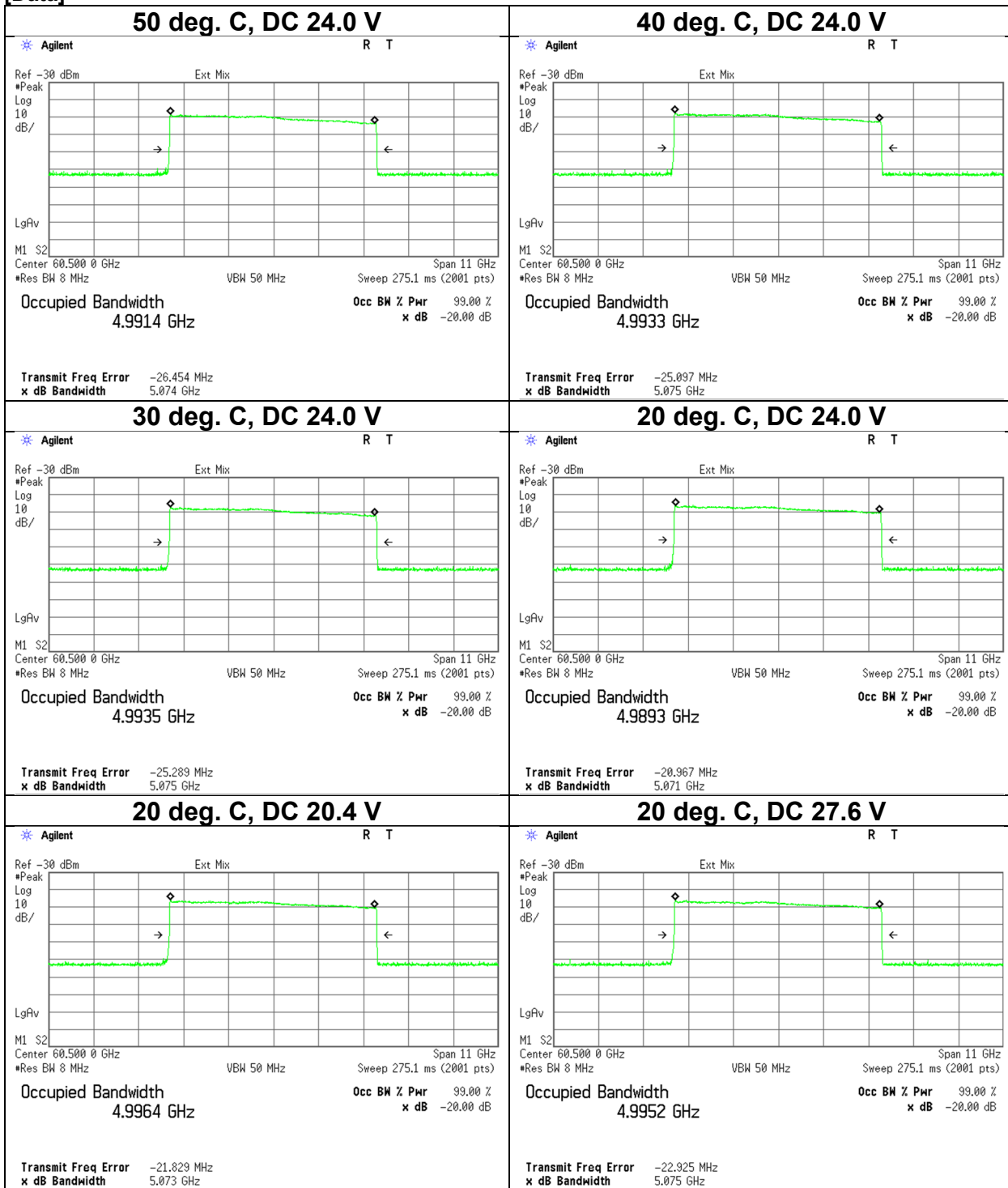

Frequency Stability

[Data]

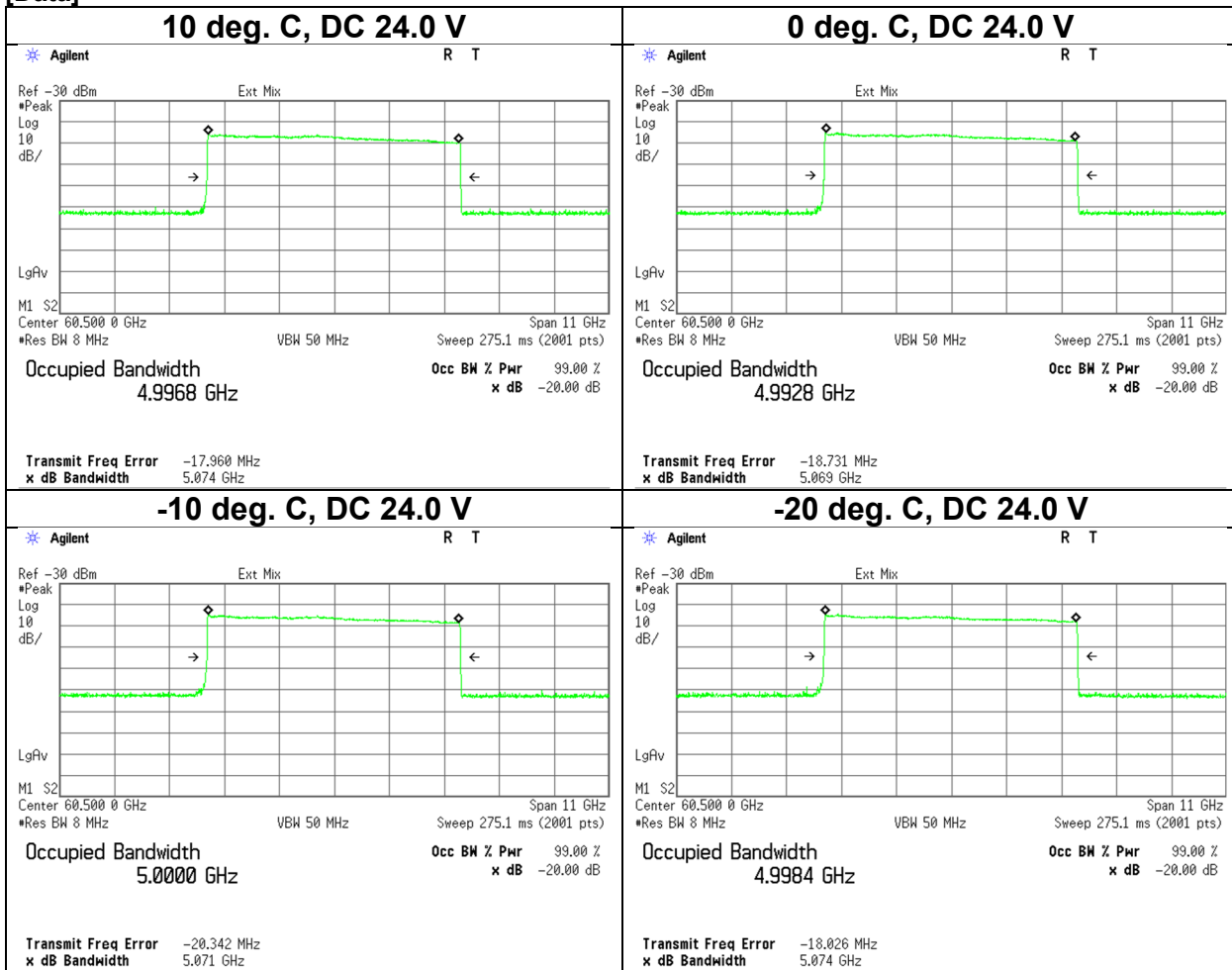

Frequency Stability

Test place	Ise EMC Lab. No. 6 Measurement Room
Date	January 17, 2024
Temperature / Humidity	24 deg. C / 32 % RH
Engineer	Yuichiro Yamazaki
Mode	Tx Symbol Pattern B

Test Condition		Center frequency [GHz]	Frequency error [MHz]	99% OBW [GHz]	99 % OBW		Remarks
Temperature [deg. C]	Power Supply [V]				The Lower frequency [GHz]	The Upper frequency [GHz]	
50	24.0	60.0	-21.852	4.0063	57.9750	61.9813	
40	24.0	60.0	-18.352	4.0100	57.9766	61.9866	
30	24.0	60.0	-18.020	4.0078	57.9781	61.9859	
20	24.0	60.0	-17.182	4.0109	57.9774	61.9883	
20	20.4	60.0	-17.681	4.0077	57.9785	61.9862	85 % of the rated voltage, DC 24 V* 0.85
20	27.6	60.0	-18.188	4.0065	57.9786	61.9851	115 % of the rated voltage, DC 24 V* 1.15
10	24.0	60.0	-15.105	4.0088	57.9805	61.9893	
0	24.0	60.0	-15.141	4.0121	57.9788	61.9909	
-10	24.0	60.0	-14.902	4.0101	57.9800	61.9901	
-20	24.0	60.0	-13.947	4.0115	57.9803	61.9918	

Calculation:

The Lower frequency = Center frequency + Frequency error - 99 % OBW / 2

The Upper frequency = Center frequency + Frequency error + 99 % OBW / 2

Fundamental emissions were contained within the frequency band 57 GHz to 64 GHz during all conditions of operation.

Frequency Stability

[Data]

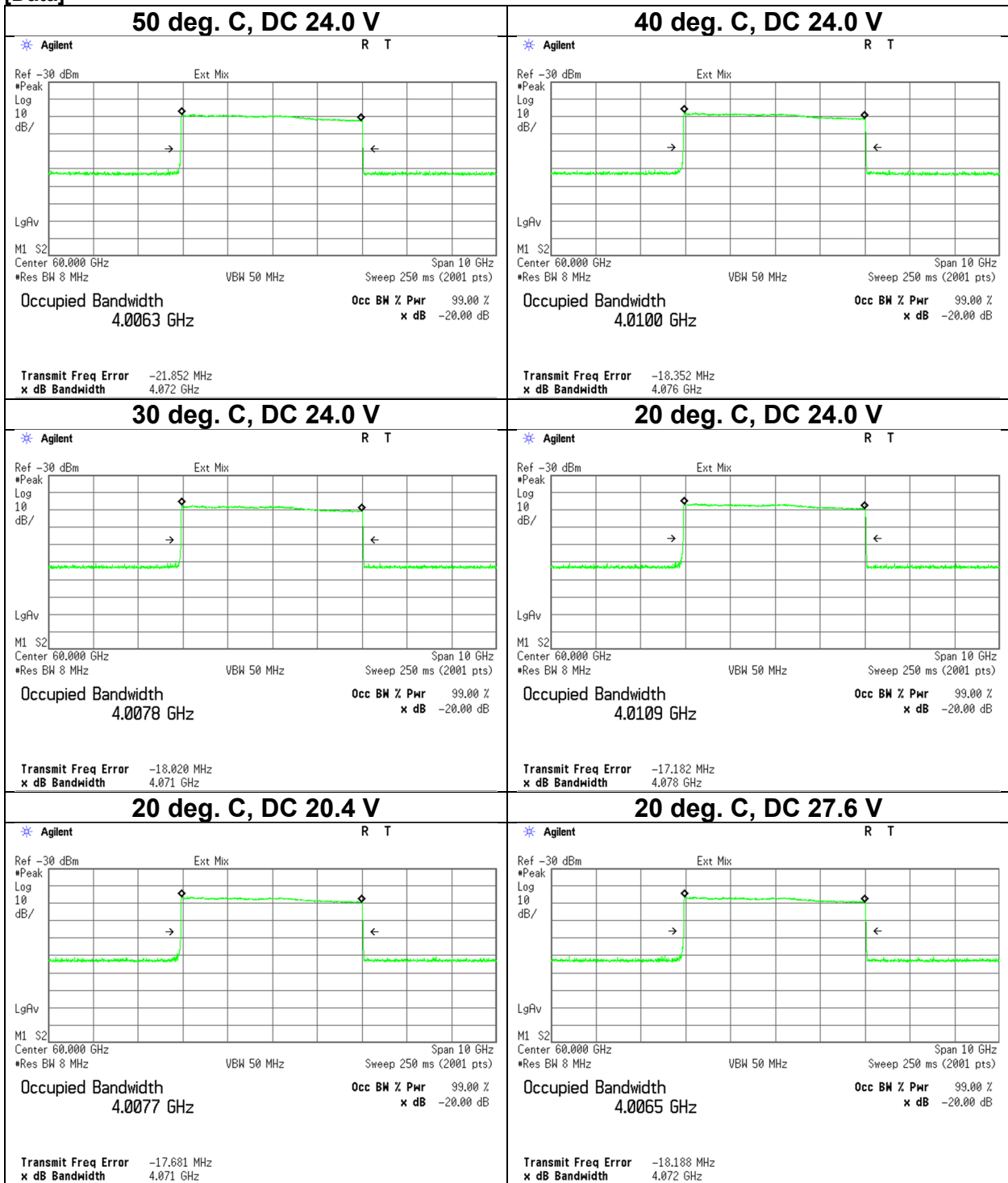

Frequency Stability

[Data]

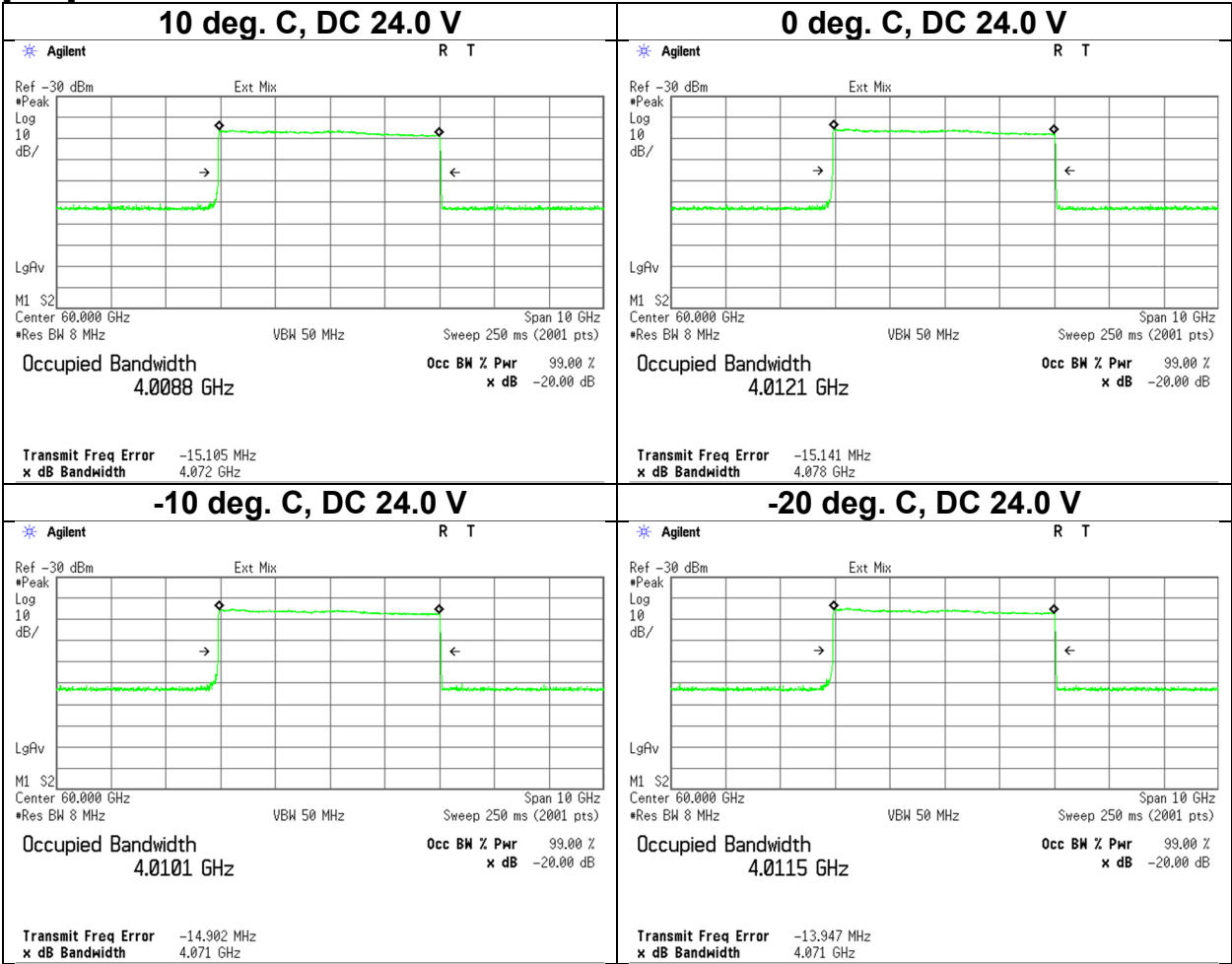

Frequency Stability

Test place	Ise EMC Lab. No. 6 Measurement Room
Date	January 17, 2024
Temperature / Humidity	24 deg. C / 32 % RH
Engineer	Yuichiro Yamazaki
Mode	Tx Symbol Pattern C

Test Condition		Center frequency [GHz]	Frequency error [MHz]	99% OBW [GHz]	99 % OBW		Remarks
Temperature [deg. C]	Power Supply [V]				The Lower frequency [GHz]	The Upper frequency [GHz]	
50	24.0	61.0	-13.749	3.9962	58.9882	62.9844	
40	24.0	61.0	-13.897	3.9886	58.9918	62.9804	
30	24.0	61.0	-14.210	3.9876	58.9920	62.9796	
20	24.0	61.0	-10.351	3.9892	58.9950	62.9842	
20	20.4	61.0	-9.790	3.9910	58.9947	62.9857	85 % of the rated voltage, DC 24 V* 0.85
20	27.6	61.0	-11.150	3.9885	58.9946	62.9831	115 % of the rated voltage, DC 24 V* 1.15
10	24.0	61.0	-10.298	3.9953	58.9921	62.9874	
0	24.0	61.0	-9.233	3.9970	58.9923	62.9893	
-10	24.0	61.0	-8.075	3.9975	58.9932	62.9907	
-20	24.0	61.0	-8.076	3.9926	58.9956	62.9882	

Calculation:

The Lower frequency = Center frequency + Frequency error - 99 % OBW / 2

The Upper frequency = Center frequency + Frequency error + 99 % OBW / 2

Fundamental emissions were contained within the frequency band 57 GHz to 64 GHz during all conditions of operation.

Frequency Stability

[Data]

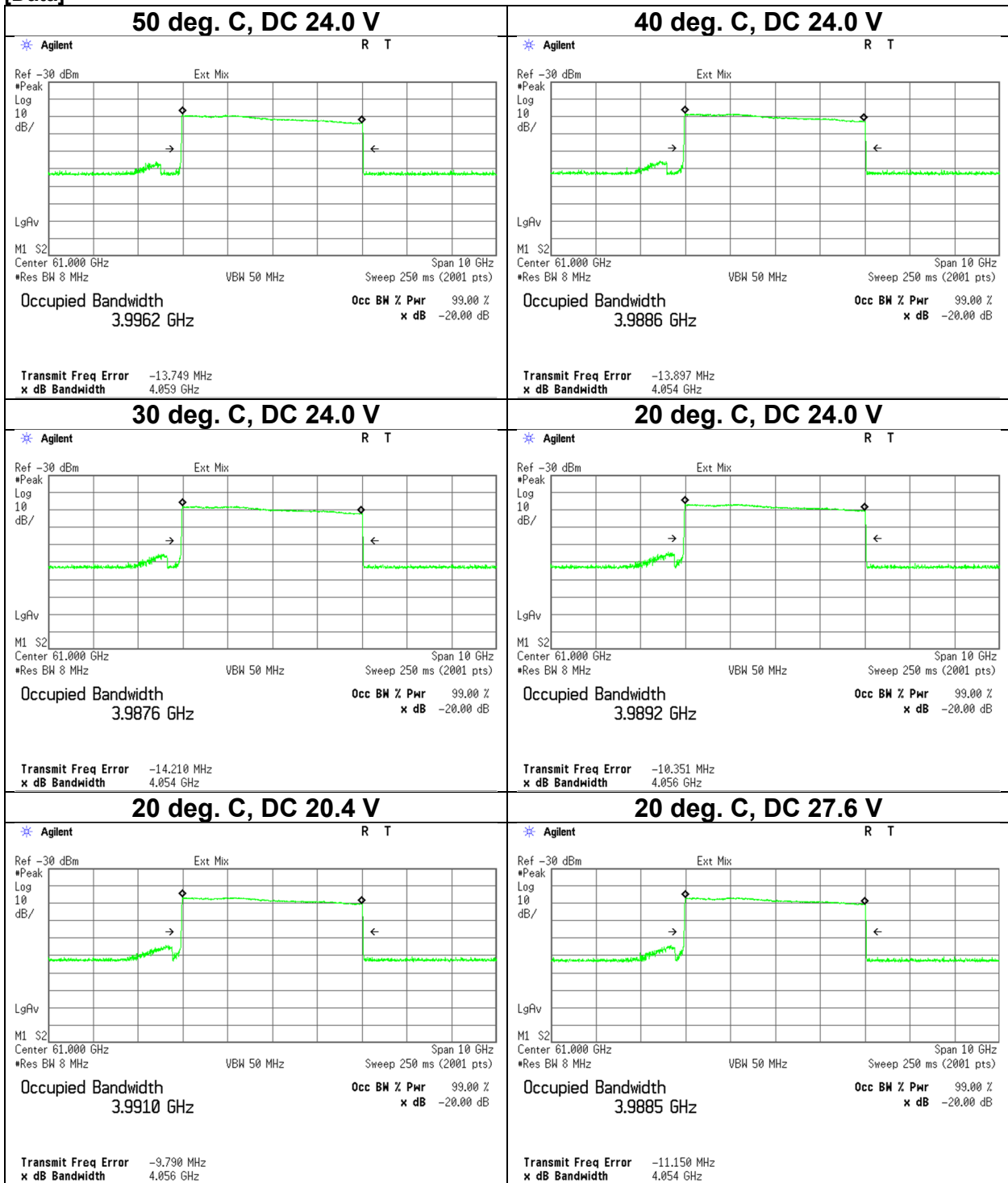

Frequency Stability

[Data]

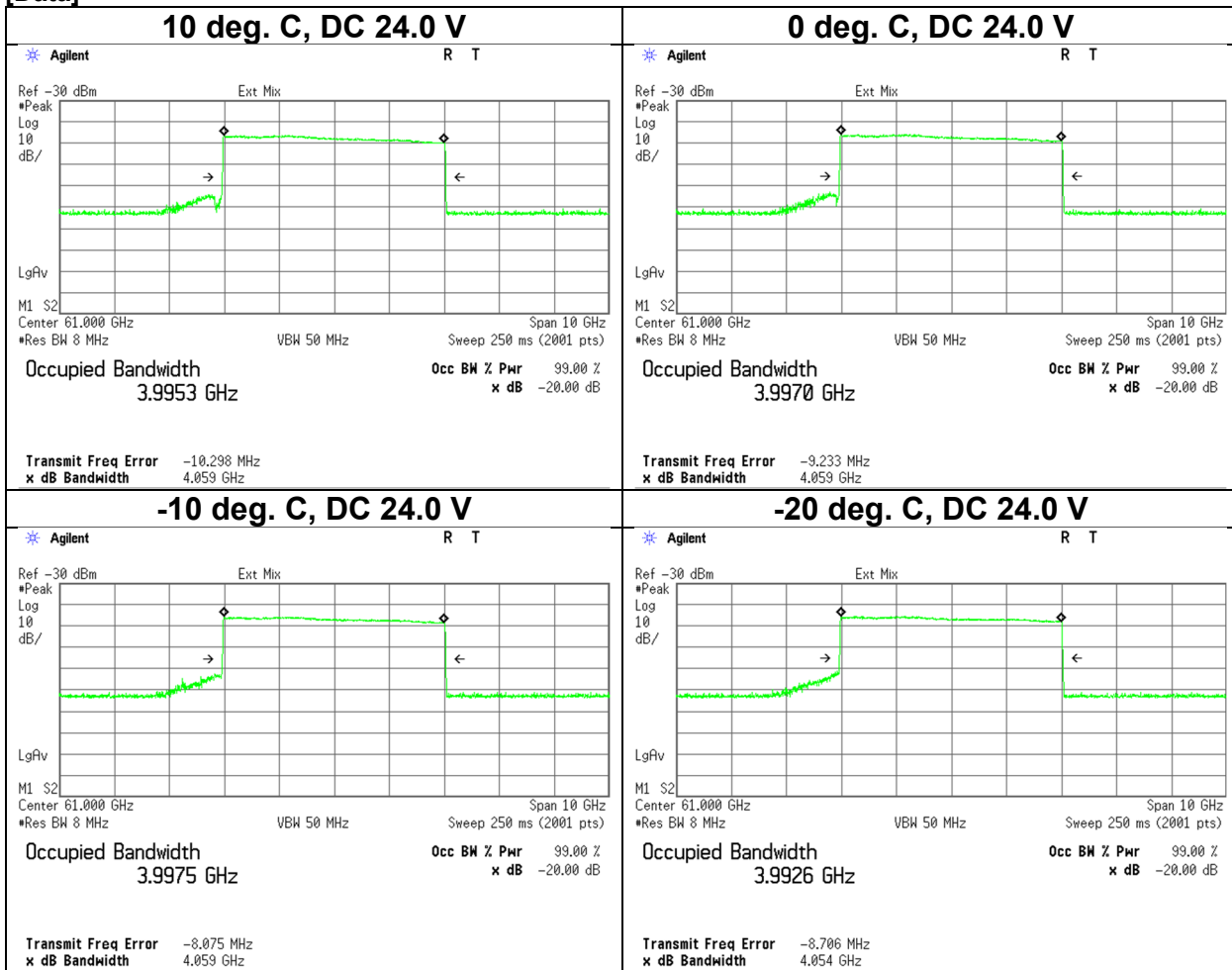

Frequency Stability

Test place	Ise EMC Lab. No. 6 Measurement Room
Date	January 17, 2024
Temperature / Humidity	24 deg. C / 32 % RH
Engineer	Yuichiro Yamazaki
Mode	Tx Symbol Pattern D

Test Condition		Center frequency [GHz]	Frequency error [MHz]	99% OBW [GHz]	99 % OBW		Remarks
Temperature [deg. C]	Power Supply [V]				The Lower frequency [GHz]	The Upper frequency [GHz]	
50	24.0	59.5	-16.077	3.0140	57.9769	60.9909	
40	24.0	59.5	-17.390	3.0195	57.9729	60.9924	
30	24.0	59.5	-16.812	3.0150	57.9757	60.9907	
20	24.0	59.5	-14.807	3.0151	57.9776	60.9927	
20	20.4	59.5	-15.570	3.0147	57.9771	60.9918	85 % of the rated voltage, DC 24 V* 0.85
20	27.6	59.5	-14.278	3.0154	57.9780	60.9934	115 % of the rated voltage, DC 24 V* 1.15
10	24.0	59.5	-14.224	3.0215	57.9750	60.9965	
0	24.0	59.5	-15.159	3.0211	57.9743	60.9954	
-10	24.0	59.5	-14.556	3.0157	57.9776	60.9933	
-20	24.0	59.5	-13.474	3.0212	57.9759	60.9971	

Calculation:

The Lower frequency = Center frequency + Frequency error - 99 % OBW / 2

The Upper frequency = Center frequency + Frequency error + 99 % OBW / 2

Fundamental emissions were contained within the frequency band 57 GHz to 64 GHz during all conditions of operation.

Frequency Stability

[Data]

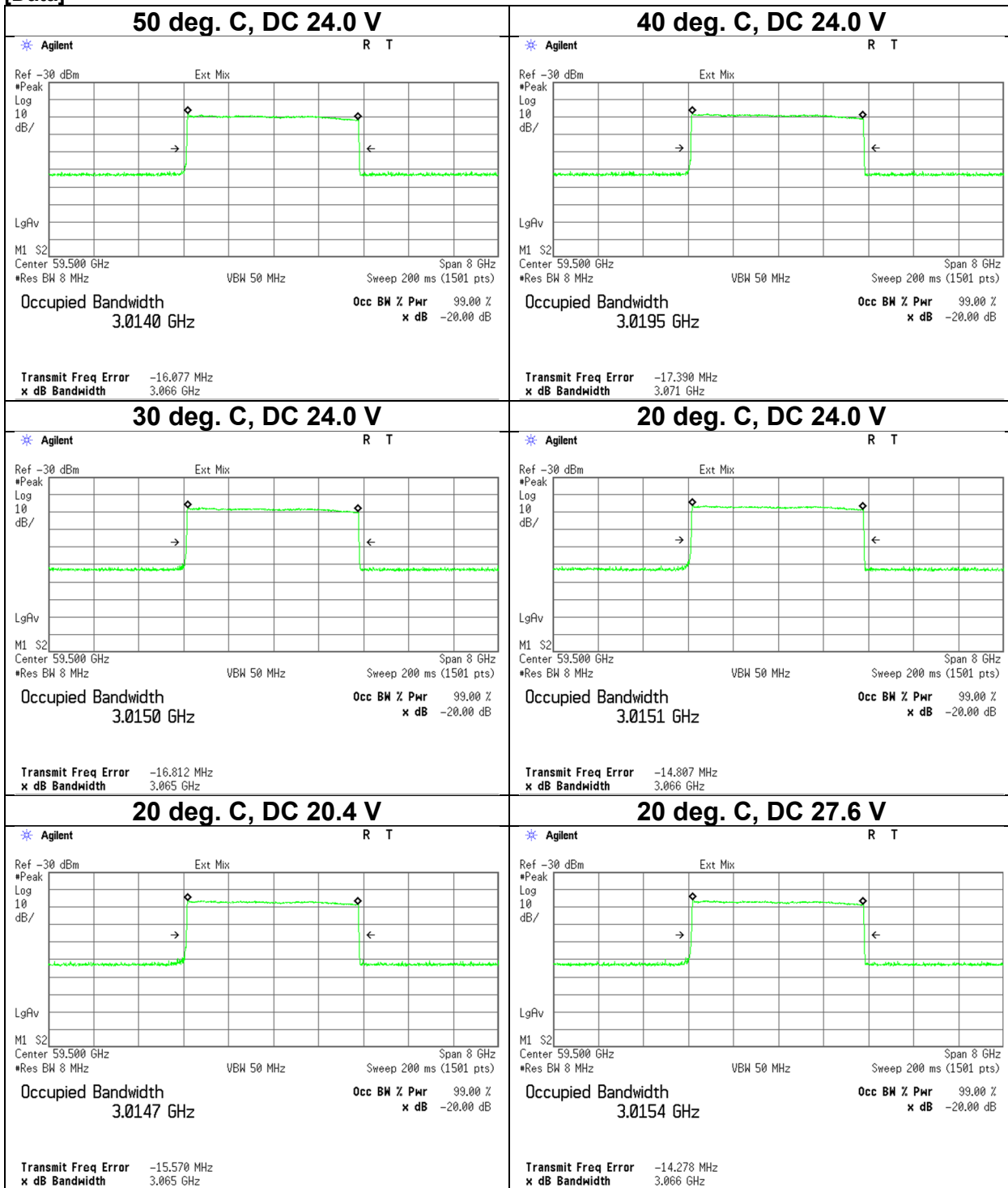

Frequency Stability

[Data]

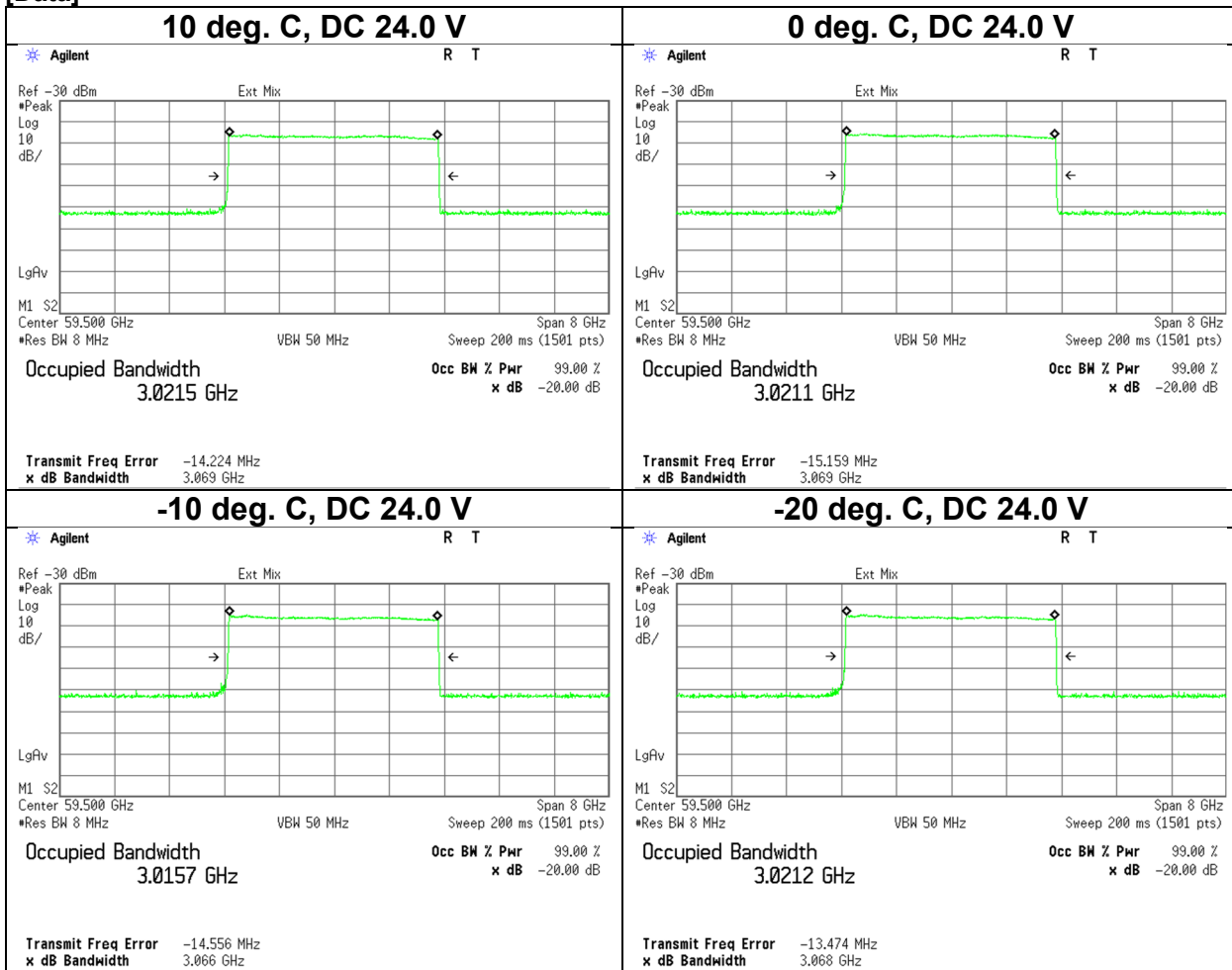

Frequency Stability

Test place	Ise EMC Lab. No. 6 Measurement Room
Date	January 17, 2024
Temperature / Humidity	24 deg. C / 32 % RH
Engineer	Yuichiro Yamazaki
Mode	Tx Symbol Pattern E

Test Condition		Center frequency [GHz]	Frequency error [MHz]	99% OBW [GHz]	99 % OBW		Remarks
Temperature [deg. C]	Power Supply [V]				The Lower frequency [GHz]	The Upper frequency [GHz]	
50	24.0	60.5	-11.724	3.0004	58.9881	61.9885	
40	24.0	60.5	-9.075	2.9989	58.9915	61.9904	
30	24.0	60.5	-9.890	2.9994	58.9904	61.9898	
20	24.0	60.5	-8.921	3.0002	58.9910	61.9912	
20	20.4	60.5	-8.047	2.9999	58.9920	61.9919	85 % of the rated voltage, DC 24 V* 0.85
20	27.6	60.5	-7.743	2.9987	58.9929	61.9916	115 % of the rated voltage, DC 24 V* 1.15
10	24.0	60.5	-7.339	3.0054	58.9900	61.9954	
0	24.0	60.5	-5.244	3.0009	58.9943	61.9952	
-10	24.0	60.5	-5.950	3.0009	58.9936	61.9945	
-20	24.0	60.5	-5.861	3.0003	58.9940	61.9943	

Calculation:

The Lower frequency = Center frequency + Frequency error - 99 % OBW / 2

The Upper frequency = Center frequency + Frequency error + 99 % OBW / 2

Fundamental emissions were contained within the frequency band 57 GHz to 64 GHz during all conditions of operation.

Frequency Stability

[Data]

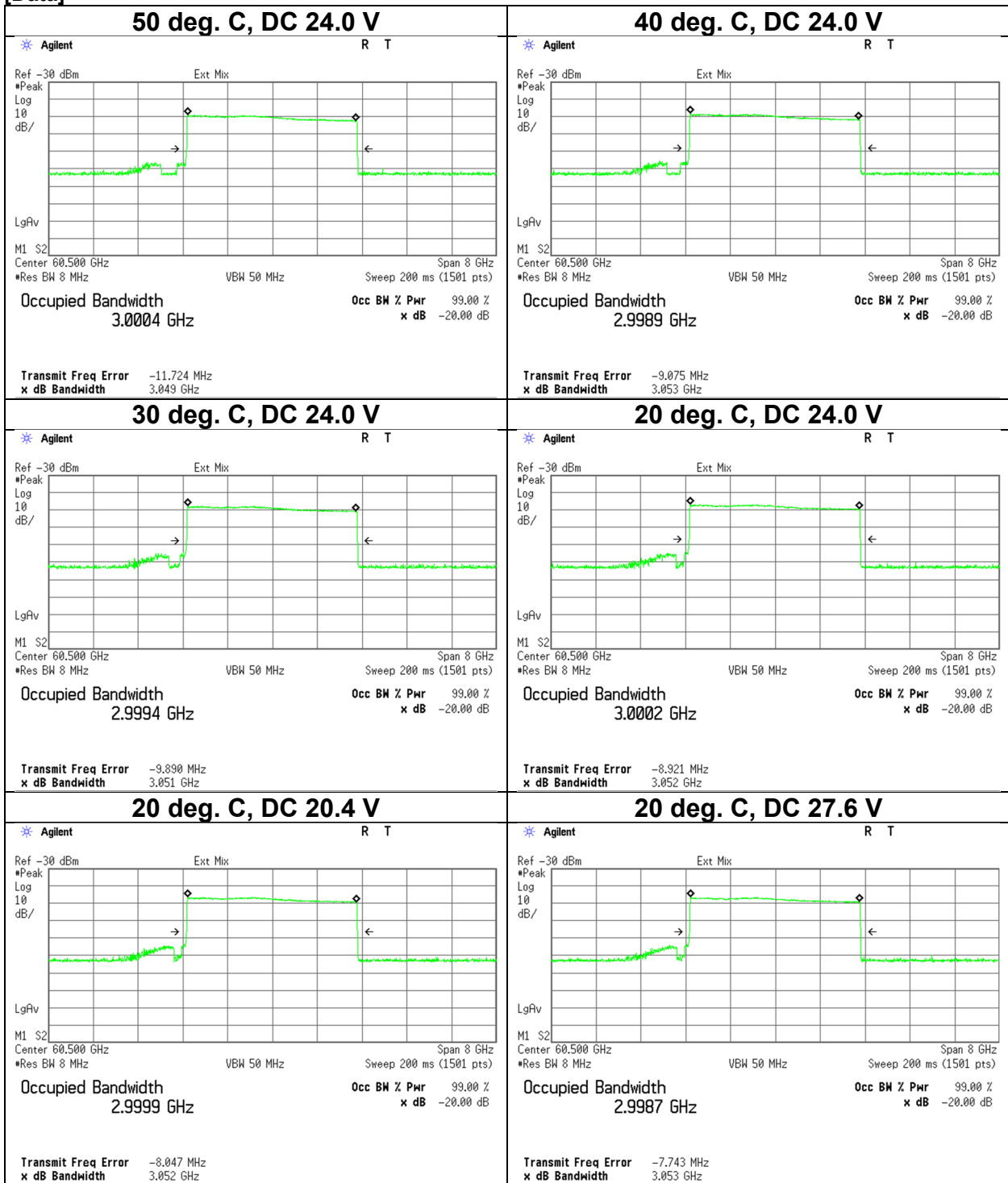

Frequency Stability

[Data]

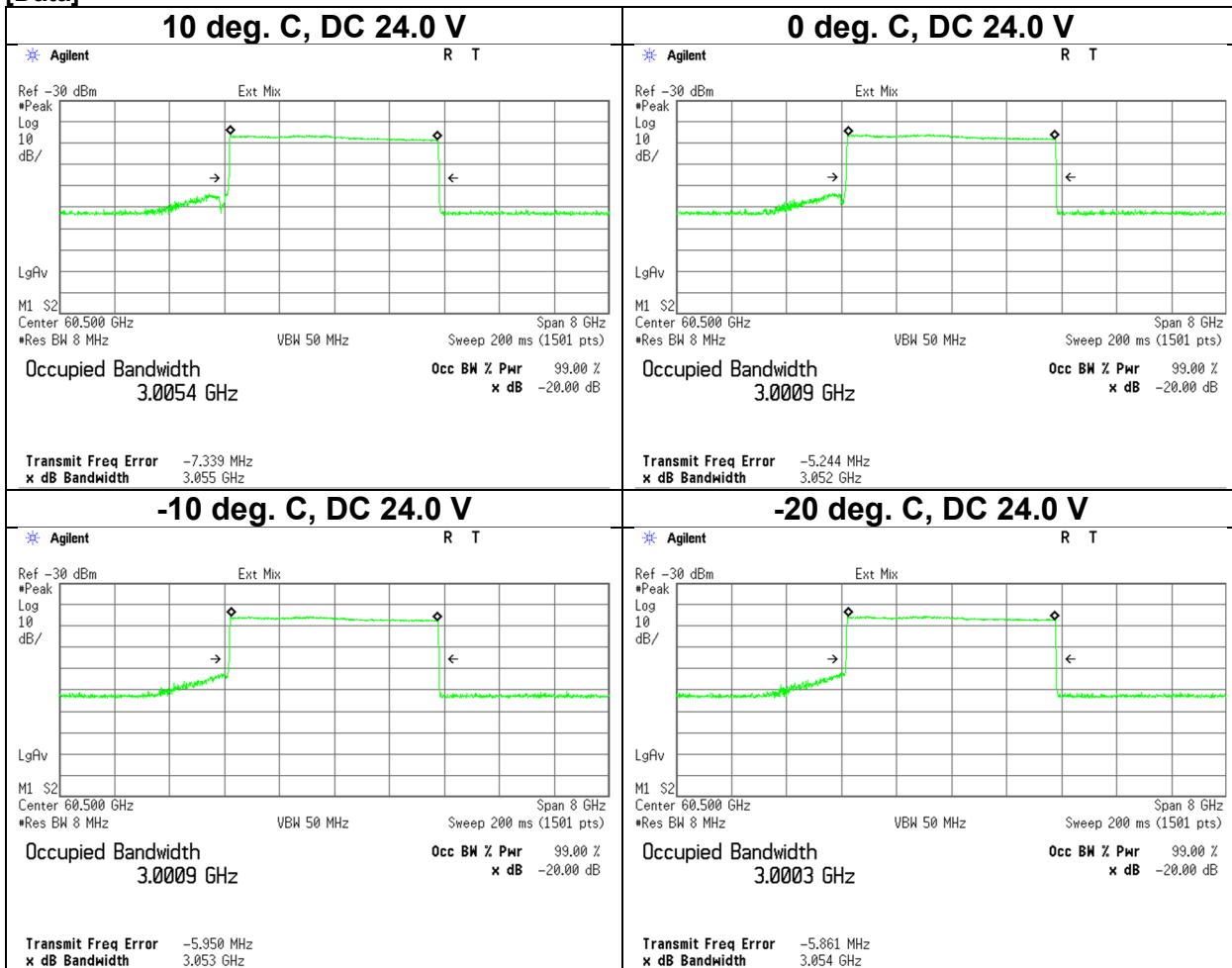

Group Instillation

There are no external phase-locking inputs in this EUT.
Therefore, the EUT comply this requirement.

APPENDIX 2: Test instruments

Test equipment (1/2)

Test Item	LIMS ID	Description	Manufacturer	Model	Serial	Last Calibration Date	Cal Int
CE	141216	Coaxial cable	Fujikura/Suhner/TSJ	5D-2W/SFM14/ sucoform141-PE/ 421-010/ RFM-E321(SW)	-/00640	07/25/2023	12
CE	141248	Attenuator	JFW Industries, Inc.	50FP-013H2 N	-	12/08/2023	12
CE	141358	LISN(AMN)	Schwarzbeck Mess- Elektronik OHG	NSLK8127	8127-730	07/13/2023	12
CE	141532	DIGITAL HITESTER	HIOKI E.E. CORPORATION	3805	51201197	01/17/2023	12
CE	141563	Thermo-Hygrometer	CUSTOM. Inc	CTH-180	1005	01/10/2024	12
CE	141949	Test Receiver	Rohde & Schwarz	ESCI	100767	05/17/2023	12
CE	142008	AC3_Semi Anechoic Chamber(NSA)	TDK	Semi Anechoic Chamber 3m	DA-10005	12/11/2023	24
CE	142183	Measure	KOMELON	KMC-36	-	10/20/2023	12
CE	178648	EMI measurement program	TSJ (Techno Science Japan)	TEPTO-DV	-	-	-
RE	141216	Coaxial cable	Fujikura/Suhner/TSJ	5D-2W/SFM14/ sucoform141-PE/ 421-010/ RFM-E321(SW)	-/00640	07/25/2023	12
RE	141226	Microwave Cable	Junkosha	MMX221- 00500DMSDMS	1502S304	03/03/2023	12
RE	141266	Logperiodic Antenna (200-1000MHz)	Schwarzbeck Mess- Elektronik OHG	VUSLP9111B	9111B-191	08/10/2023	12
RE	141323	Coaxial cable	UL Japan	-	-	09/10/2023	12
RE	141326	Microwave Cable	Suhner	SUCOFLEX101	2874(1m) / 2877(5m)	03/07/2023	12
RE	141328	Microwave Cable 1G-40GHz	Suhner	SUCOFLEX102	28636/2	04/10/2023	12
RE	141393	Microwave Cable	Junkosha	MWX221	1604S254(1 m) / 1608S088(5 m)	08/01/2023	12
RE	141429	Temperature and Humidity Chamber	Espec	PL-2KP	14015723	08/09/2023	12
RE	141508	Horn Antenna 1-18GHz	Schwarzbeck Mess- Elektronik OHG	BBHA9120D	557	05/17/2023	12
RE	141513	Horn Antenna 15-40GHz	Schwarzbeck Mess- Elektronik OHG	BBHA9170	BBHA9170306	07/19/2023	12
RE	141517	Horn Antenna 26.5-40GHz	ETS-Lindgren	3160-10	152399	11/20/2023	12
RE	141532	DIGITAL HITESTER	HIOKI E.E. CORPORATION	3805	51201197	01/17/2023	12
RE	141542	Digital Tester	Fluke Corporation	FLUKE 26-3	78030611	08/01/2023	12
RE	141547	DIGITAL HITESTER	HIOKI E.E. CORPORATION	3805	60500120	02/02/2023	12
RE	141554	Thermo-Hygrometer	CUSTOM. Inc	CTH-201	1301	-	-
RE	141563	Thermo-Hygrometer	CUSTOM. Inc	CTH-180	1005	01/10/2024	12
RE	141576	Pre Amplifier	Keysight Technologies Inc	8449B	3008A01671	02/14/2023	12
RE	141581	MicroWave System Amplifier	Keysight Technologies Inc	83017A	00650	10/05/2023	12
RE	141582	Pre Amplifier	SONOMA INSTRUMENT	310	260834	02/07/2023	12
RE	141588	Pre Amplifier	L3 Narda-MITEQ	AMF-6F-2600400-33- 8P / AMF-4F-2600400- 33-8P	1871355 / 1871328	01/24/2023	12
RE	141801	Power Meter	Keysight Technologies Inc	E4417A	GB41290639	04/11/2023	12
RE	141884	Spectrum Analyzer	Keysight Technologies Inc	E4448A	MY44020357	03/13/2023	12
RE	141885	Spectrum Analyzer	Keysight Technologies Inc	E4448A	US44300523	11/29/2023	12
RE	141949	Test Receiver	Rohde & Schwarz	ESCI	100767	05/17/2023	12
RE	141962	Digital Oscilloscope	Rohde & Schwarz	RTO1004	200355	05/16/2023	12
RE	142004	AC2_Semi Anechoic Chamber(NSA)	TDK	Semi Anechoic Chamber 3m	DA-06902	12/12/2023	24
RE	142008	AC3_Semi Anechoic Chamber(NSA)	TDK	Semi Anechoic Chamber 3m	DA-10005	12/11/2023	24

Test equipment (2/2)

Test Item	LIMS ID	Description	Manufacturer	Model	Serial	Last Calibration Date	Cal Int
RE	142013	AC3_Semi Anechoic Chamber(SVSWR)	TDK	Semi Anechoic Chamber 3m	DA-10005	10/18/2023	12
RE	142026	Diplexer	OML INC.	DPL26	-	-	-
RE	142032	Microwave Cable	Huber+Suhner	SUCOFLEX102	37511/2	-	-
RE	142033	Microwave Cable	Huber+Suhner	SUCOFLEX102	37512/2	-	-
RE	142036	Horn Antenna	Custom Microwave Inc.	HO6R	-	09/05/2023	12
RE	142039	Horn Antenna	Custom Microwave Inc.	HO4R	-	09/05/2023	12
RE	142041	Horn Antenna	Oshima Prototype Engineering Co.	A16-187	1	09/05/2023	12
RE	142047	Preselected Millimeter Mixer	Keysight Technologies Inc	11974V-E01	3001A00412	11/14/2023	12
RE	142048	Harmonic Mixer	Keysight Technologies Inc	11970W	2521 A01909	09/22/2023	12
RE	142049	Harmonic Mixer	OML INC.	M06HWD	D100709-1	12/04/2023	12
RE	142053	Harmonic Mixer	OML INC.	M04HWD	Y100709-1	05/16/2023	12
RE	142055	Power Amplifier	SAGE Millimeter, Inc.	SBP-5037532015-1515-N1	11599-01	03/22/2023	12
RE	142152	Loop Antenna	Rohde & Schwarz	HFH2-Z2	836553/009	10/17/2023	12
RE	142183	Measure	KOMELON	KMC-36	-	10/20/2023	12
RE	142228	Measure, Tape, Steel	KOMELON	KMC-36	-	-	-
RE	142238	Power sensor	Keysight Technologies Inc	V8486A	MY44420112	06/16/2023	12
RE	142314	Attenuator	Pasternack Enterprises	PE7390-6	D/C 1504	06/23/2023	12
RE	142528	Detector	Millitech	DET-15-RPFW0	34	-	-
RE	142545	Fullband Tripler	Millitech	MUT-15-LF000	19	-	-
RE	142590	Waveguide Isolator	Keysight Technologies Inc	V365A	60004	-	-
RE	142592	Waveguide Isolator	Millitech	FBI-15-RSES0	1858	-	-
RE	151897	Microwave Cable	Huber+Suhner	SF101EA/11PC24/11PC24/2.5M	SN MY1726/1EA	04/11/2023	12
RE	159670	Coaxial Cable	UL Japan	-	-	11/21/2023	12
RE	159919	Power Amplifier	SAGE Millimeter, Inc.	SBP-4035033018-2F2F-S1	12559-01	06/19/2023	12
RE	160324	Coaxial Cable	Huber+Suhner	SUCOFLEX 102A	MY009/2A	10/05/2023	12
RE	176027	D-Band Low Noise Amplifier	SAGE Millimeter, Inc.	SBL-1141741860-0606-EI	15235-01	07/11/2023	12
RE	178648	EMI measurement program	TSJ (Techno Science Japan)	TEPTO-DV	-	-	-
RE	180544	Horn Antenna	SAGE Millimeter, Inc.	SAZ-2410-10-S1	17343-01	06/21/2023	12
RE	180607	Power Amplifier	SAGE Millimeter, Inc.	SBP-7531142515-1010-E1	17343-01	09/22/2023	12
RE	180634	Horn Antenna	SAGE Millimeter, Inc.	SAZ-2410-15-S1	17343-01	06/20/2023	12
RE	192300	Thermo-Hygrometer	CUSTOM. Inc	CTH-201	0013	-	-
RE	197990	Biconical Antenna	Schwarzbeck Mess-Elektronik OHG	VHBB 9124 + BBA 9106	01365	11/29/2023	12
RE	199856	WR-10 HighPass Filter	Oshima Prototype Engineering Co.	A20-110-A01	001	04/13/2023	12
RE	234602	Microwave Cable	Huber+Suhner	SF126E/11PC35/11PC35/1000M,5000M	537063/126E / 537074/126E	03/16/2023	12

*Hyphens for Last Calibration Date and Cal Int (month) are instruments that Calibration is not required (e.g. software), or instruments checked in advance before use.

The expiration date of the calibration is the end of the expired month.

As for some calibrations performed after the tested dates, those test equipment have been controlled by means of an unbroken chains of calibrations.

All equipment is calibrated with valid calibrations. Each measurement data is traceable to the national or international standards.

Test item:

CE: Conducted Emission
RE: Radiated Emission