

TEST REPORT

CERTIFICATE OF CONFORMITY

Standard: 47 CFR FCC Part 15, Subpart E (Section 15.407)

Report No.: RFBCKS-WTW-P23030626A

FCC ID: RF41689B

Product: Industrial Wireless System

Brand: KEYENCE

Model No.: WS-B01

Received Date: 2023/3/22

Test Date: 2023/5/17 ~ 2023/12/7

Issued Date: 2024/1/22

Applicant: Keyence Corporation

Address: 1-3-14, Higashi-Nakajima, Higashi-Yodogawa-ku, Osaka, 533-8555, Japan

Issued By: Bureau Veritas Consumer Products Services (H.K.) Ltd., Taoyuan Branch
Hsin Chu Laboratory

Lab Address: E-2, No.1, Li Hsin 1st Road, Hsinchu Science Park, Hsinchu City 300, Taiwan

Test Location: E-2, No.1, Li Hsin 1st Road, Hsinchu Science Park, Hsinchu City 300, Taiwan

FCC Registration / 723255 / TW2022

Designation Number:

Approved by: _____, **Date:** 2024/1/22
May Chen / Manager

This test report consists of 202 pages in total. It may be duplicated completely for legal use with the approval of the applicant. It should not be reproduced except in full, without the written approval of our laboratory. The test results in the report only apply to the tested sample. The test results in this report are traceable to the national or international standards.



Prepared by : Phoenix Huang / Specialist

This report is governed by, and incorporates by reference, the Conditions of Testing as posted at the date of issuance of this report at <http://www.bureauveritas.com/home/about-us/our-business/cps/about-us/terms-conditions/> and is intended for your exclusive use. Any copying or replication of this report to or for any other person or entity, or use of our name or trademark, is permitted only with our prior written permission. This report sets forth our findings solely with respect to the test samples identified herein. The results set forth in this report are not indicative or representative of the quality or characteristics of the lot from which a test sample was taken or any similar or identical product unless specifically and expressly noted. Our report includes all of the tests requested by you and the results thereof based upon the information that you provided to us. Measurement uncertainty is only provided upon request for accredited tests. Statements of conformity are based on simple acceptance criteria without taking measurement uncertainty into account, unless otherwise requested in writing. You have 60 days from date of issuance of this report to notify us of any material error or omission caused by our negligence or if you require measurement uncertainty; provided, however, that such notice shall be in writing and shall specifically address the issue you wish to raise. A failure to raise such issue within the prescribed time shall constitute your unqualified acceptance of the completeness of this report, the tests conducted and the correctness of the report contents.

Table of Contents

Release Control Record	4
1 Certificate	5
2 Summary of Test Results	6
2.1 Measurement Uncertainty	6
2.2 Supplementary Information	6
3 General Information	7
3.1 General Description of EUT	7
3.2 Antenna Description of EUT	8
3.3 Channel List	9
3.4 Test Mode Applicability and Tested Channel Detail	11
3.5 Duty Cycle of Test Signal	13
3.6 Test Program Used and Operation Descriptions	17
3.7 Connection Diagram of EUT and Peripheral Devices	17
3.8 Configuration of Peripheral Devices and Cable Connections	17
4 Test Instruments	18
4.1 Maximum RF Output Power	18
4.2 Maximum Power Spectral Density	18
4.3 Emission Bandwidth	18
4.4 In-Band Emission Mask	18
4.5 Occupied Bandwidth	18
4.6 Frequency Stability	19
4.7 Contention-based Protocol	19
4.8 AC Power Conducted Emissions	20
4.9 Unwanted Emissions below 1 GHz	20
4.10 Unwanted Emissions above 1 GHz	21
5 Limits of Test Items	22
5.1 Maximum RF Output Power	22
5.2 Maximum Power Spectral Density	22
5.3 Emission Bandwidth	22
5.4 In-Band Emission Mask	22
5.5 Occupied Bandwidth	22
5.6 Frequency Stability	22
5.7 Contention-based Protocol	23
5.8 AC Power Conducted Emissions	23
5.9 Unwanted Emissions below 1 GHz	23
5.10 Unwanted Emissions above 1 GHz	24
6 Test Arrangements	25
6.1 Maximum RF Output Power	25
6.1.1 Test Setup	25
6.1.2 Test Procedure	25
6.2 Maximum Power Spectral Density	27
6.2.1 Test Setup	27
6.2.2 Test Procedure	27
6.3 Emission Bandwidth	28
6.3.1 Test Setup	28
6.3.2 Test Procedure	28
6.4 In-Band Emission Mask	28
6.4.1 Test Setup	28
6.4.2 Test Procedure	28
6.5 Occupied Bandwidth	29
6.5.1 Test Setup	29
6.5.2 Test Procedure	29
6.6 Frequency Stability	29
6.6.1 Test Setup	29



6.6.2	Test Procedure	29
6.7	Contention-based Protocol	30
6.7.1	Test Setup	30
6.7.2	Test Procedure	30
6.8	AC Power Conducted Emissions	31
6.8.1	Test Setup	31
6.8.2	Test Procedure	31
6.9	Unwanted Emissions below 1 GHz	32
6.9.1	Test Setup	32
6.9.2	Test Procedure	33
6.10	Unwanted Emissions above 1 GHz	34
6.10.1	Test Setup	34
6.10.2	Test Procedure	34
7	Test Results of Test Item	35
7.1	Maximum RF Output Power	35
7.2	Maximum Power Spectral Density	41
7.3	Emission Bandwidth	47
7.4	In-Band Emission Mask	50
7.5	Occupied Bandwidth	66
7.6	Frequency Stability	69
7.7	Contention-based Protocol	70
7.8	AC Power Conducted Emissions	83
7.9	Unwanted Emissions below 1 GHz	85
7.10	Unwanted Emissions above 1 GHz	87
8	Pictures of Test Arrangements	201
9	Information of the Testing Laboratories	202



Release Control Record

Issue No.	Description	Date Issued
RFBCKS-WTW-P23030626A	Original release.	2024/1/22

1 Certificate

Product: Industrial Wireless System

Brand: KEYENCE

Test Model: WS-B01

Sample Status: Engineering sample

Applicant: Keyence Corporation

Test Date: 2023/5/17 ~ 2023/12/7

Standard: 47 CFR FCC Part 15, Subpart E (Section 15.407)

Measurement ANSI C63.10-2013

procedure:

KDB 987594 D02 U-NII 6 GHz EMC Measurement v01v01

KDB 789033 D02 General UNII Test Procedure New Rules v02r01

KDB 662911 D01 Multiple Transmitter Output v02r01

The above equipment has been tested by **Bureau Veritas Consumer Products Services (H.K.) Ltd., Taoyuan Branch**, and found compliance with the requirement of the above standards. The test record, data evaluation & Equipment Under Test (EUT) configurations represented herein are true and accurate accounts of the measurements of the sample's RF characteristics under the conditions specified in this report.

2 Summary of Test Results

47 CFR FCC Part 15, Subpart E (Section 15.407)			
Clause	Test Item	Result	Remark
15.407(a)(6)	Maximum RF Output Power	Pass	Meet the requirement of limit.
15.407(a)(6)	Maximum Power Spectral Density	Pass	Meet the requirement of limit.
15.407(a)(10)	Emission Bandwidth	Pass	Meet the requirement of limit.
15.407(a)(10)	Occupied Bandwidth	Pass	Meet the requirement of limit.
15.407(b)(9)	AC Power Conducted Emissions	Pass	Minimum passing margin is -9.14 dB at 0.44694 MHz
15.407(b)(9)	Unwanted Emissions below 1 GHz	Pass	Minimum passing margin is -7.8 dB at 35.70 MHz
15.407(b)(6) 15.407(b)(10)	Unwanted Emissions above 1 GHz	Pass	Minimum passing margin is -0.2 dB at 7125.00 MHz
15.407(b)(7)	In-Band Emission Mask	Pass	Meet the requirement of limit.
15.407(d)(6)	Contention-based Protocol	Pass	Meet the requirement of limit.
15.407(g)	Frequency Stability	Pass	Meet the requirement of limit.
15.203	Antenna Requirement	Pass	Antenna connector is ipex(MHF) not a standard connector.

Note: Determining compliance based on the results of the compliance measurement, not taking into account measurement instrumentation uncertainty.

2.1 Measurement Uncertainty

Where relevant, the following measurement uncertainty levels have been estimated for tests performed on the EUT as specified in CISPR 16-4-2:

Parameter	Specification	Uncertainty (±)
AC Power Conducted Emissions	150 kHz ~ 30 MHz	1.9 dB
Unwanted Emissions below 1 GHz	9 kHz ~ 30 MHz	3.1 dB
	30 MHz ~ 1 GHz	5.4 dB
Unwanted Emissions above 1 GHz	1 GHz ~ 18 GHz	5.0 dB
	18 GHz ~ 40 GHz	5.3 dB

The other instruments specified are routine verified to remain within the calibrated levels, no measurement uncertainty is required to be calculated.

2.2 Supplementary Information

There is not any deviation from the test standards for the test method, and no modifications required for compliance.

3 General Information

3.1 General Description of EUT

Product	Industrial Wireless System
Brand	KEYENCE
Test Model	WS-B01
Status of EUT	Engineering sample
Power Supply Rating	24Vdc
Modulation Type	64QAM, 16QAM, QPSK, BPSK for OFDM 1024QAM for OFDMA in 11ax mode
Modulation Technology	OFDM, OFDMA
Transfer Rate	802.11a: up to 54Mbps 802.11ax: up to 2401.9Mbps
Operating Frequency	5.955 GHz ~ 6.415 GHz 6.435 GHz ~ 6.525 GHz 6.535 GHz ~ 6.865 GHz 6.875 GHz ~ 7.115 GHz
Number of Channel	802.11a, 802.11ax (HE20): 59 802.11ax (HE40): 29 802.11ax (HE80): 14 802.11ax (HE160): 7
Output Power	1Tx Mode (802.11a): 5.955 GHz ~ 6.415 GHz: EIRP: 21.727 mW (13.37 dBm) 6.435 GHz ~ 6.525 GHz: EIRP: 22.233 mW (13.47 dBm) 6.535 GHz ~ 6.865 GHz: EIRP: 22.233 mW (13.47 dBm) 6.875 GHz ~ 7.115 GHz: EIRP: 22.751 mW (13.57 dBm) CDD Mode: 5.955 GHz ~ 6.415 GHz: EIRP: 133.968 mW (21.27 dBm) 6.435 GHz ~ 6.525 GHz: EIRP: 150.314 mW (21.77 dBm) 6.535 GHz ~ 6.865 GHz: EIRP: 143.549 mW (21.57 dBm) 6.875 GHz ~ 7.115 GHz: EIRP: 137.088 mW (21.37 dBm) Beamforming Mode: 5.955 GHz ~ 6.415 GHz: EIRP: 137.088 mW (21.37 dBm) 6.435 GHz ~ 6.525 GHz: EIRP: 176.604 mW (22.47 dBm) 6.535 GHz ~ 6.865 GHz: EIRP: 70.307 mW (18.47 dBm) 6.875 GHz ~ 7.115 GHz: EIRP: 150.314 mW (21.77 dBm)
EUT Category	Low Power Indoor AP Subordinate Device

Note:

1. The above EUT information is declared by manufacturer and for more detailed features description, please refers to the manufacturer's specifications or user's manual.

3.2 Antenna Description of EUT

1. The antenna information is listed as below.

Antenna No.	RF Chain No.	Antenna Net Gain (dBi)	Frequency Range (GHz)	Antenna Type	Connector Type
SB1	Chain 0	3.63	5.955-6.415	PIFA	ipex(MHF)
		3.5	6.435-6.525		
		3.5	6.535-6.865		
		4.2	6.875-7.115		
SB2	Chain 1	4.35	5.955-6.415	PIFA	ipex(MHF)
		3.2	6.435-6.525		
		3.2	6.535-6.865		
		4.4	6.875-7.115		

* Detail antenna specification please refer to antenna datasheet and/or antenna measurement report.

2. The EUT incorporates a MIMO function:

6 GHz Band		
Modulation Mode	TX & RX Configuration	
802.11a	1TX Diversity	2RX
802.11ax (HE20)	2TX	2RX
802.11ax (HE40)	2TX	2RX
802.11ax (HE80)	2TX	2RX
802.11ax (HE160)	2TX	2RX

Note:

1. All of modulation mode support beamforming function except 802.11a modulation mode.
2. For 1TX diversity configuration, the worst case was found in Chain (1). Therefore only the test data of the mode was recorded in this report.

3.3 Channel List

U-NII-5:

24 channels are provided for 802.11a, 802.11ax (HE20):

Channel	Frequency	Channel	Frequency	Channel	Frequency	Channel	Frequency
1	5955 MHz	5	5975 MHz	9	5955 MHz	13	6015 MHz
17	6035 MHz	21	6055 MHz	25	6075 MHz	29	6095 MHz
33	6115 MHz	37	6135 MHz	41	6155 MHz	45	6175 MHz
49	6195 MHz	53	6215 MHz	57	6235 MHz	61	6255 MHz
65	6275 MHz	69	6295 MHz	73	6315 MHz	77	6335 MHz
81	6355 MHz	85	6375 MHz	89	6395 MHz	93	6415 MHz

12 channels are provided for 802.11ax (HE40):

Channel	Frequency	Channel	Frequency	Channel	Frequency	Channel	Frequency
3	5965 MHz	11	6005 MHz	19	6045 MHz	27	6085 MHz
35	6125 MHz	43	6165 MHz	51	6205 MHz	59	6245 MHz
67	6285 MHz	75	6325 MHz	83	6365 MHz	91	6405 MHz

6 channels are provided for 802.11ax (HE80):

Channel	Frequency	Channel	Frequency	Channel	Frequency	Channel	Frequency
7	5985 MHz	23	6065 MHz	39	6145 MHz	55	6225 MHz
71	6305 MHz	87	6385 MHz				

3 channels are provided for 802.11ax (HE160):

Channel	Frequency	Channel	Frequency	Channel	Frequency
15	6025 MHz	47	6185 MHz	79	6345 MHz

U-NII-6:

5 channels are provided for 802.11a, 802.11ax (HE20):

Channel	Frequency	Channel	Frequency	Channel	Frequency	Channel	Frequency
97	6435 MHz	101	6455 MHz	105	6475 MHz	109	6495 MHz
113	6515 MHz						

3 channels are provided for 802.11ax (HE40):

Channel	Frequency	Channel	Frequency	Channel	Frequency
99	6445 MHz	107	6485 MHz	*115	6525 MHz

1 channel is provided for 802.11ax (HE80):

Channel	Frequency
103	6465 MHz

1 channel is provided for 802.11ax (HE160):

Channel	Frequency
*111	6505 MHz

U-NII-7:

17 channels are provided for 802.11a, 802.11ax (HE20):

Channel	Frequency	Channel	Frequency	Channel	Frequency	Channel	Frequency
117	6535 MHz	121	6555 MHz	125	6575 MHz	129	6595 MHz
133	6615 MHz	137	6635 MHz	141	6655 MHz	145	6675 MHz
149	6695 MHz	153	6715 MHz	157	6735 MHz	161	6755 MHz
165	6775 MHz	169	6795 MHz	173	6815 MHz	177	6835 MHz
181	6855 MHz						

8 channels are provided for 802.11ax (HE40):

Channel	Frequency	Channel	Frequency	Channel	Frequency	Channel	Frequency
123	6565 MHz	131	6605 MHz	139	6645 MHz	147	6685 MHz
155	6725 MHz	163	6765 MHz	171	6805 MHz	179	6845 MHz

5 channels are provided for 802.11ax (HE80):

Channel	Frequency	Channel	Frequency	Channel	Frequency	Channel	Frequency
*119	6545 MHz	135	6625 MHz	151	6705 MHz	167	6785 MHz
*183	6865 MHz						

2 channels are provided for 802.11ax (HE160):

Channel	Frequency	Channel	Frequency
143	6665 MHz	175	*6825 MHz

U-NII-8:

13 channels are provided for 802.11a, 802.11ax (HE20):

Channel	Frequency	Channel	Frequency	Channel	Frequency	Channel	Frequency
185	6875 MHz	189	6895 MHz	193	6915 MHz	197	6935 MHz
201	6955 MHz	205	6975 MHz	209	6995 MHz	213	7015 MHz
217	7035 MHz	221	7055 MHz	225	7075 MHz	229	7095 MHz
233	7115 MHz						

6 channels are provided for 802.11ax (HE40):

Channel	Frequency	Channel	Frequency	Channel	Frequency	Channel	Frequency
187	6885 MHz	195	6925 MHz	203	6965 MHz	211	7005 MHz
219	7045 MHz	227	7085 MHz				

2 channels are provided for 802.11ax (HE80):

Channel	Frequency	Channel	Frequency
199	6945 MHz	215	7025 MHz

1 channel is provided for 802.11ax (HE160):

Channel	Frequency
207	6985 MHz

Note: * mean these are straddle channels.

3.4 Test Mode Applicability and Tested Channel Detail

Pre-Scan:	Pre-Scan has been conducted to determine the worst-case mode from all possible combinations between available modulations, data rates and antenna ports (if EUT with antenna diversity architecture).
-----------	---

Following channel(s) was (were) selected for the final test as listed below:

Test Item	Mode	Signal Mode	Tested Channel	Modulation	Data Rate Parameter
Maximum RF Output Power / Maximum Power Spectral Density	802.11a	-	1, 45, 93, 97, 105, 113, 117, 149, 181, 185, 209, 233	BPSK	6Mb/s
	802.11ax (HE20)	CDD & Beamforming	1, 45, 93, 97, 105, 113, 117, 149, 181, 185, 209, 233	BPSK	MCS0
	802.11ax (HE40)	CDD & Beamforming	3, 43, 91, 99, 107, 115, 123, 155, 179, 187, 211, 227	BPSK	MCS0
	802.11ax (HE80)	CDD & Beamforming	7, 39, 87, 103, 119, 151, 183, 199, 215	BPSK	MCS0
	802.11ax (HE160)	CDD & Beamforming	15, 47, 79, 111, 143, 175, 207	BPSK	MCS0
Emission Bandwidth	802.11a	-	1, 45, 93, 97, 105, 113, 117, 149, 181, 185, 209, 233	BPSK	6Mb/s
	802.11ax (HE20)	CDD	1, 45, 93, 97, 105, 113, 117, 149, 181, 185, 209, 233	BPSK	MCS0
	802.11ax (HE40)	CDD	3, 43, 91, 99, 107, 115, 123, 155, 179, 187, 211, 227	BPSK	MCS0
	802.11ax (HE80)	CDD	7, 39, 87, 103, 119, 151, 183, 199, 215	BPSK	MCS0
	802.11ax (HE160)	CDD	15, 47, 79, 111, 143, 175, 207	BPSK	MCS0
In-Band Emission Mask	802.11a	-	1, 45, 93, 97, 105, 113, 117, 149, 181, 185, 209, 233	BPSK	6Mb/s
	802.11ax (HE20)	CDD	1, 45, 93, 97, 105, 113, 117, 149, 181, 185, 209, 233	BPSK	MCS0
	802.11ax (HE40)	CDD	3, 43, 91, 99, 107, 115, 123, 155, 179, 187, 211, 227	BPSK	MCS0
	802.11ax (HE80)	CDD	7, 39, 87, 103, 119, 151, 183, 199, 215	BPSK	MCS0
	802.11ax (HE160)	CDD	15, 47, 79, 111, 143, 175, 207	BPSK	MCS0

Test Item	Mode	Signal Mode	Tested Channel	Modulation	Data Rate Parameter
Occupied Bandwidth	802.11a	-	1, 45, 93, 97, 105, 113, 117, 149, 181, 185, 209, 233	BPSK	6Mb/s
	802.11ax (HE20)	CDD	1, 45, 93, 97, 105, 113, 117, 149, 181, 185, 209, 233	BPSK	MCS0
	802.11ax (HE40)	CDD	3, 43, 91, 99, 107, 115, 123, 155, 179, 187, 211, 227	BPSK	MCS0
	802.11ax (HE80)	CDD	7, 39, 87, 103, 119, 151, 183, 199, 215	BPSK	MCS0
	802.11ax (HE160)	CDD	15, 47, 79, 111, 143, 175, 207	BPSK	MCS0
Frequency Stability	802.11a	-	1	unmodulated	-
Contention-based Protocol	802.11ax (HE20)	CDD	33, 97, 129, 193	BPSK	MCS0
	802.11ax (HE160)	CDD	47, 111, 143, 207	BPSK	MCS0
AC Power Conducted Emissions	802.11ax (HE160)	CDD	79	BPSK	MCS0
Unwanted Emissions below 1 GHz	802.11ax (HE160)	CDD	79	BPSK	MCS0
Unwanted Emissions above 1 GHz	802.11a	-	1, 45, 93, 97, 105, 113, 117, 149, 181, 185, 209, 233	BPSK	6Mb/s
	802.11ax (HE20)	CDD	1, 45, 93, 97, 105, 113, 117, 149, 181, 185, 209, 233	BPSK	MCS0
	802.11ax (HE40)	CDD	3, 43, 91, 99, 107, 115, 123, 155, 179, 187, 211, 227	BPSK	MCS0
	802.11ax (HE80)	CDD	7, 39, 87, 103, 119, 151, 183, 199, 215	BPSK	MCS0
	802.11ax (HE160)	CDD	15, 47, 79, 111, 143, 175, 207	BPSK	MCS0

Note:

1. Partial RU (resource unit) /MRU (resource unit) /Puncturing reduction mechanisms are not supported.
2. 802.11a mode is 1Tx Diversity.

3.5 Duty Cycle of Test Signal

802.11a: Duty cycle = 1.977 ms / 1.993 ms x 100% = 99.2%

802.11ax (HE20) CDD: Duty cycle = 5.453 ms / 5.465 ms x 100% = 99.8%

802.11ax (HE40) CDD: Duty cycle = 5.454 ms / 5.466 ms x 100% = 99.8%

802.11ax (HE80) CDD: Duty cycle = 5.454 ms / 5.466 ms x 100% = 99.8%

802.11ax (HE160) CDD: Duty cycle = 5.454 ms / 5.466 ms x 100% = 99.8%

802.11ax (HE20) Beamforming: Duty cycle = 2.048 ms / 2.259 ms x 100% = 90.7%, duty factor = $10 * \log(1/\text{Duty cycle})$ = 0.43 dB

802.11ax (HE40) Beamforming: Duty cycle = 2.236 ms / 2.394 ms x 100% = 93.4%, duty factor = $10 * \log(1/\text{Duty cycle})$ = 0.30 dB

802.11ax (HE80) Beamforming: Duty cycle = 2.068 ms / 2.216 ms x 100% = 93.3%, duty factor = $10 * \log(1/\text{Duty cycle})$ = 0.30 dB

802.11ax (HE160) Beamforming: Duty cycle = 2.018 ms / 2.153 ms x 100% = 93.7%, duty factor = $10 * \log(1/\text{Duty cycle})$ = 0.28 dB

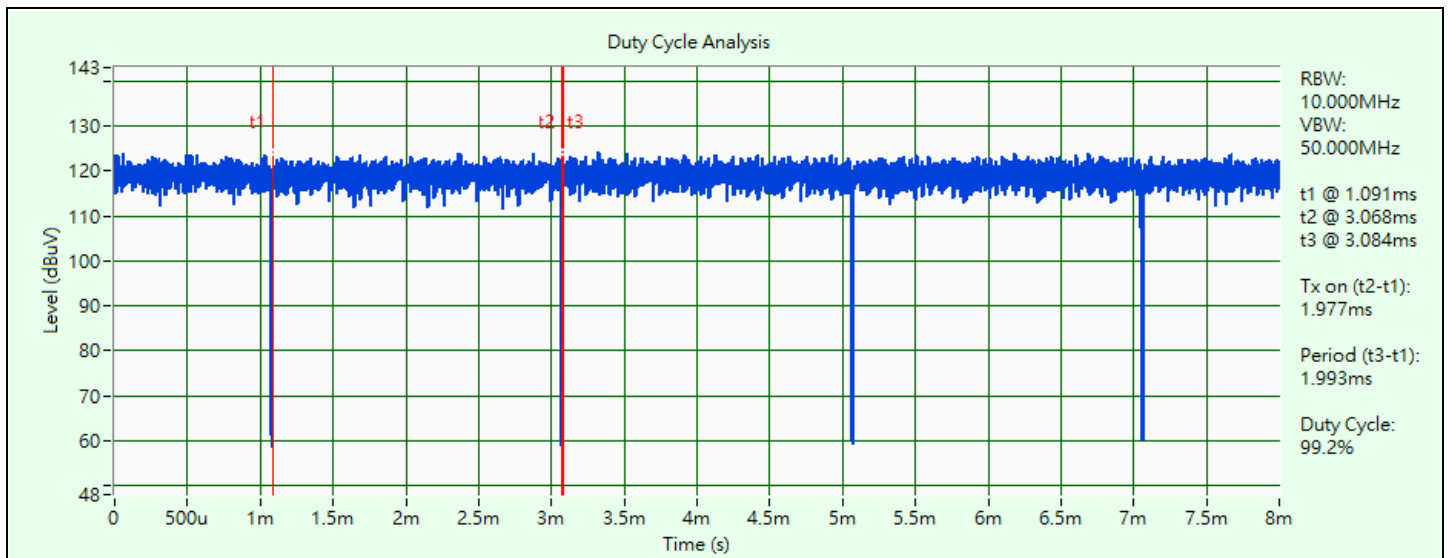

802.11a

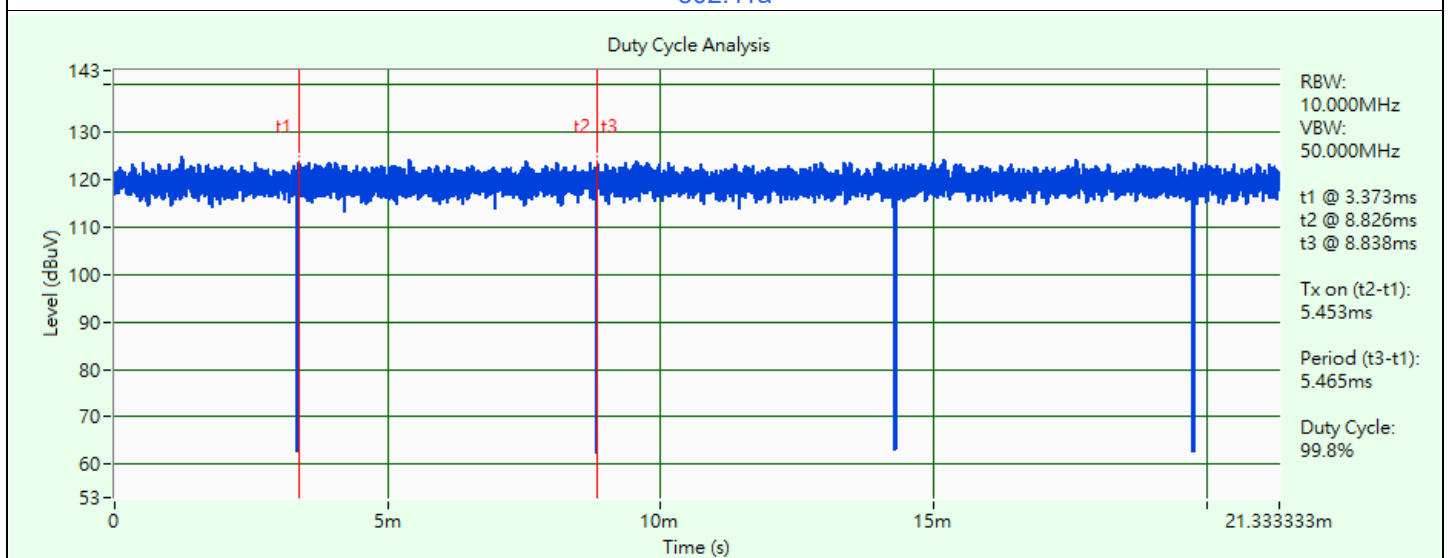

802.11ax (HE20) CDD

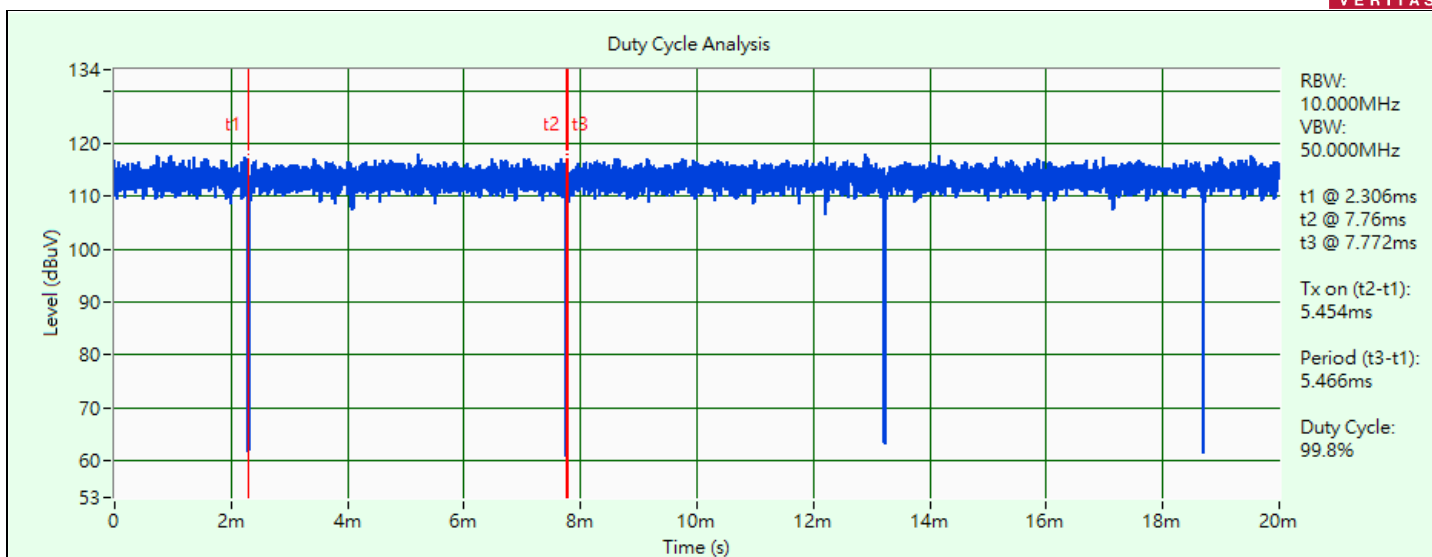

802.11ax (HE40) CDD



802.11ax (HE80) CDD

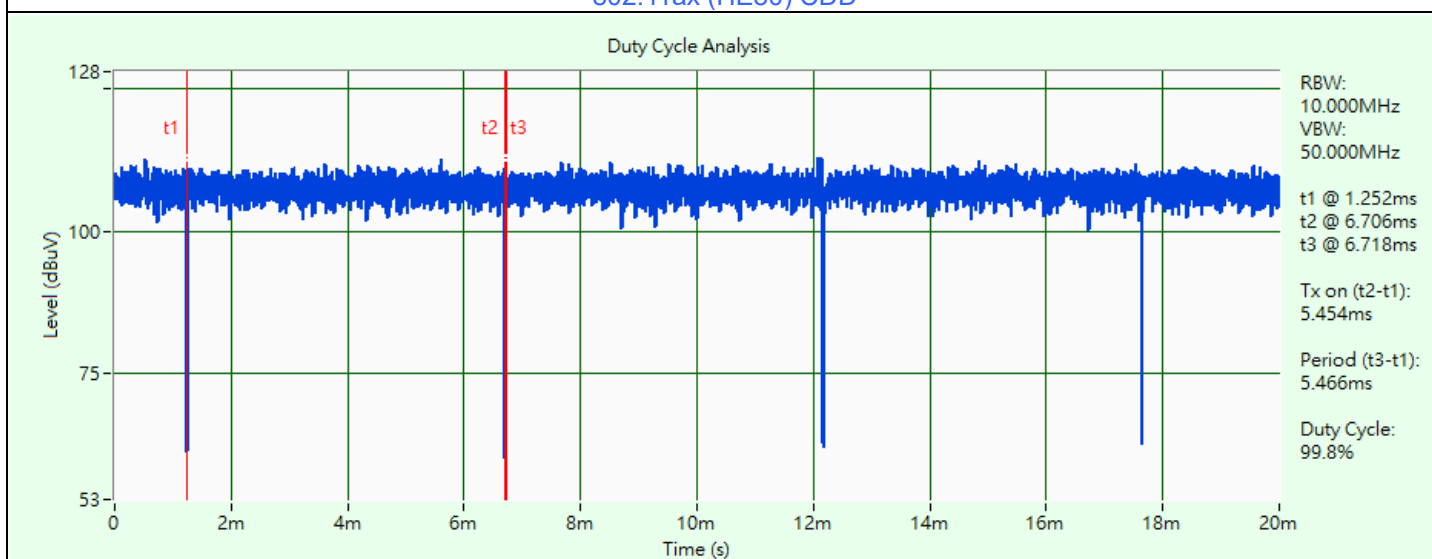

802.11ax (HE160) CDD

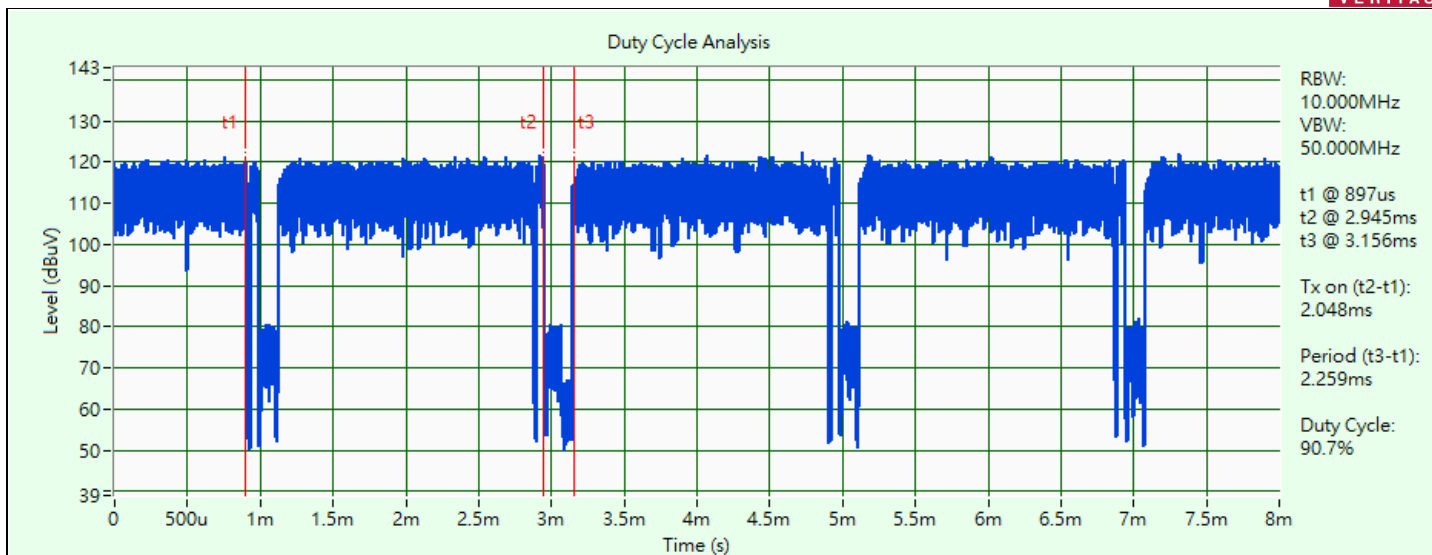

802.11ax (HE20) Beamforming

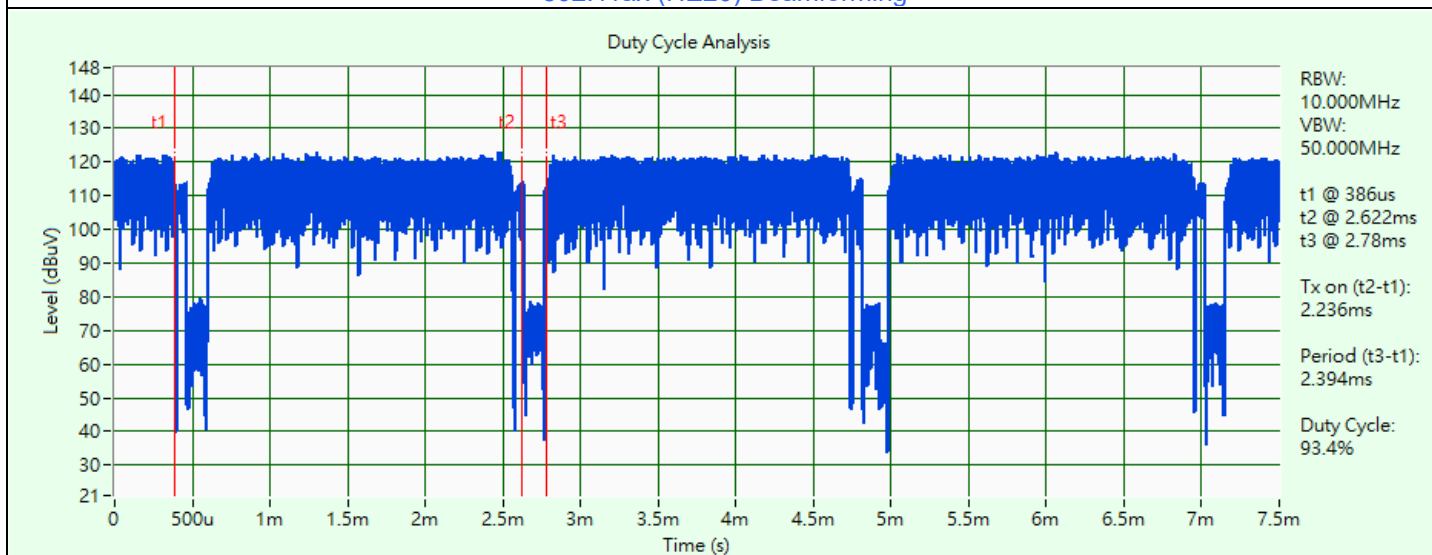

802.11ax (HE40) Beamforming

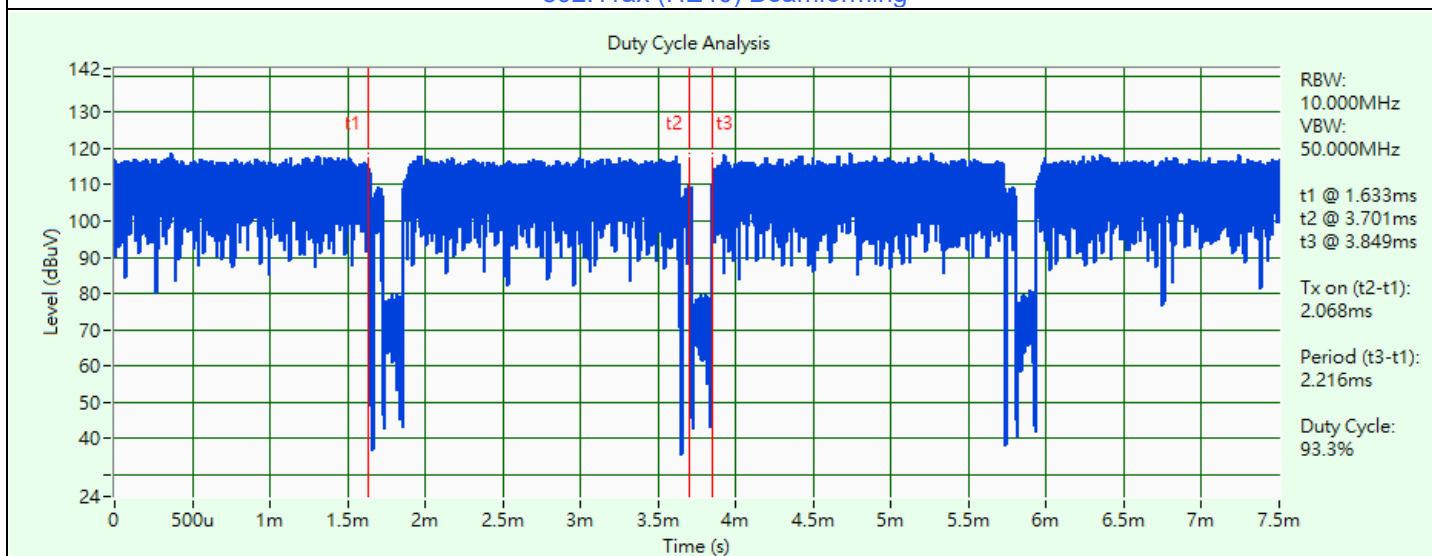

802.11ax (HE80) Beamforming

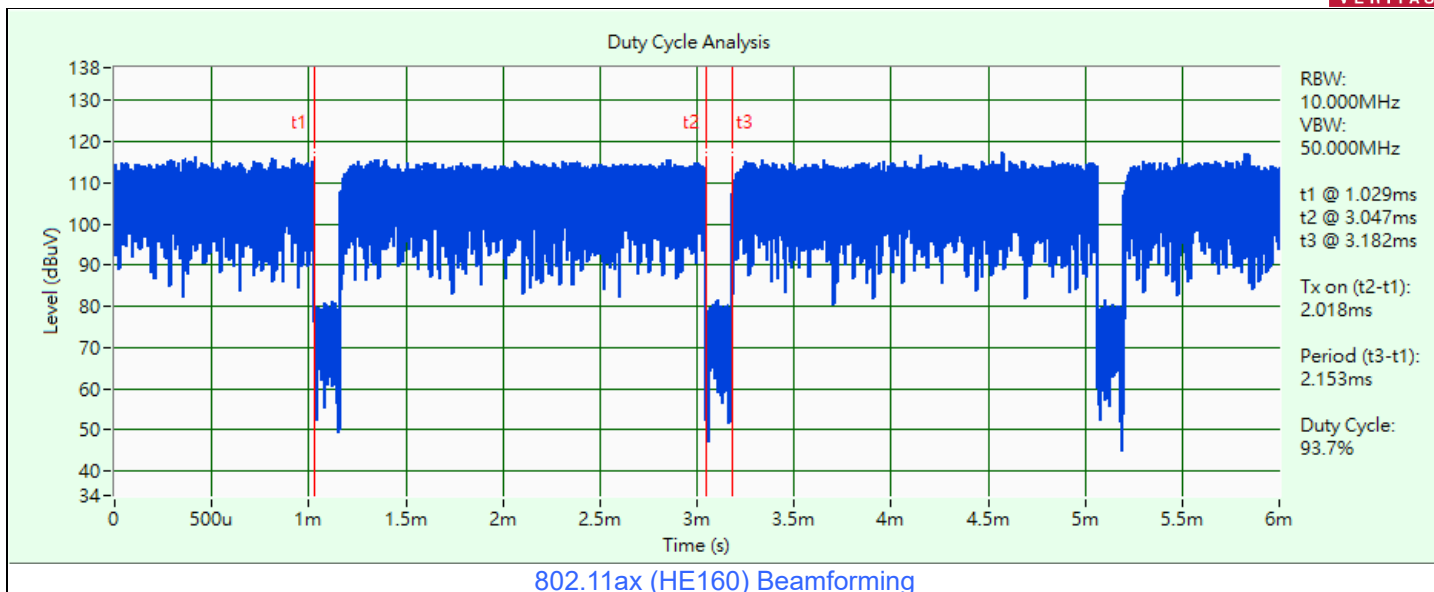

3.6 Test Program Used and Operation Descriptions

Controlling software (qdart_conn.win.1.0_installer_00094.1) has been activated to set the EUT under transmission condition continuously at specific channel frequency.

3.7 Connection Diagram of EUT and Peripheral Devices

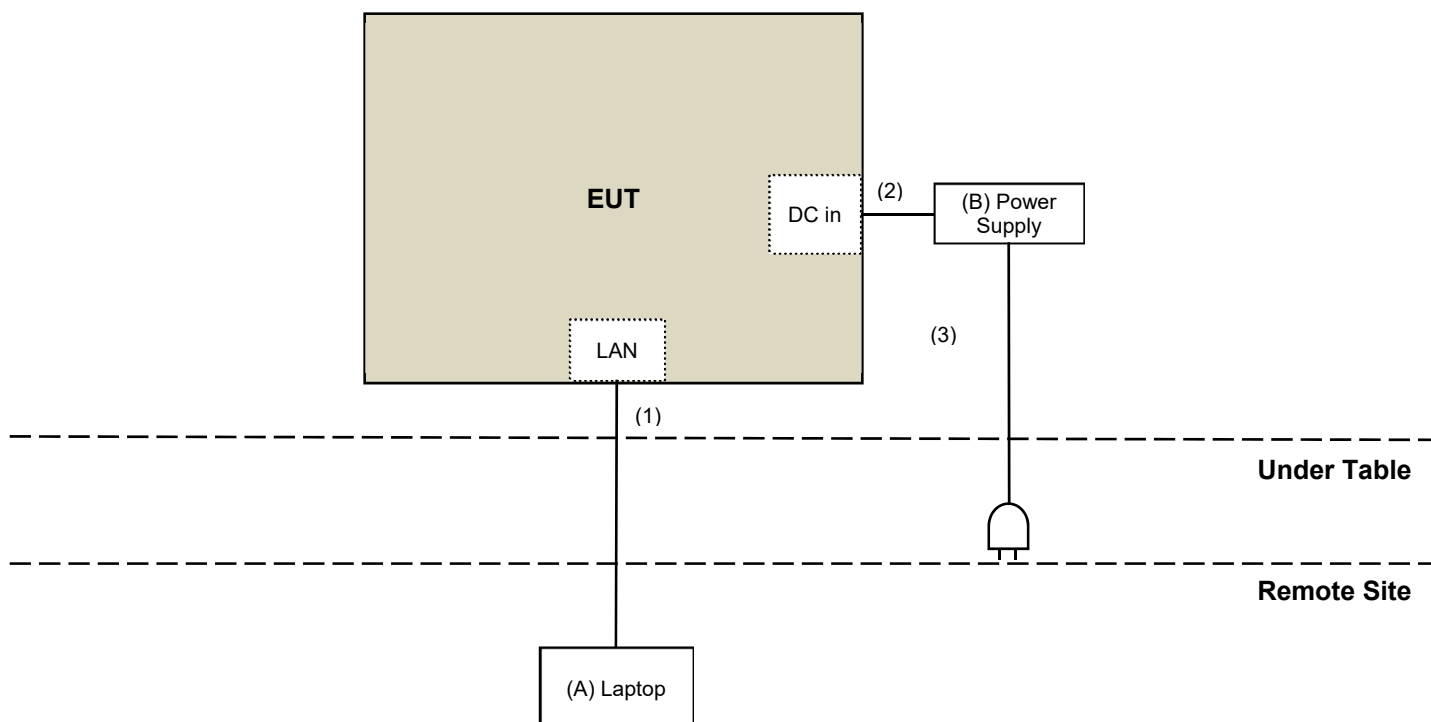

3.8 Configuration of Peripheral Devices and Cable Connections

ID	Product	Brand	Model No.	Serial No.	FCC ID	Remarks
A	Laptop	Lenovo	20U5S01X00 L14	PF-1ANPYA	N/A	Provided by Lab
B	Power Supply	KEYENCE	MS2-H50	N/A	N/A	Supplied by applicant

ID	Cable Descriptions	Qty.	Length (m)	Shielding (Yes/No)	Cores (Qty.)	Remarks
1	RJ45 Cable	1	10	No	0	Provided by Lab
2	DC Cable	1	0.7	No	0	Supplied by applicant
3	AC Cable	1	1.7	No	0	Supplied by applicant

4 Test Instruments

The calibration interval of the all test instruments are 12 months and the calibrations are traceable to NML/ROC and NIST/USA.

4.1 Maximum RF Output Power

Description Manufacturer	Model No.	Serial No.	Calibrated Date	Calibrated Until
Boresight Antenna Tower & Turn Table Max-Full	MF-7802BS	MF780208530	N/A	N/A
Horn Antenna Schwarzbeck	BBHA 9120D	9120D-2035	2022/11/13	2023/11/12
Pre_Amplifier EMCI	EMC12630SE	980385	2022/8/15	2023/8/14
RF Cable EMCI	EMC104-SM-SM-1300	210205	2023/5/8	2024/5/7
RF Coaxial Cable EMCI	EMC101G-KM-KM-10000	210708	2022/11/4	2023/11/3
Software	ADT_Radiated_V8.7.08	N/A	N/A	N/A
Spectrum Analyzer Keysight	N9020B	MY60112410	2023/3/6	2024/3/5
Test Receiver KEYSIGHT	N9038A	MY59050100	2023/6/13	2024/6/12

Notes:

1. The test was performed in 966 Chamber No. 6.
2. Tested Date: 2023/7/14

4.2 Maximum Power Spectral Density

Refer to section 4.1 to get information of the instruments.

4.3 Emission Bandwidth

Description Manufacturer	Model No.	Serial No.	Calibrated Date	Calibrated Until
Fixed Attenuator Woken	MDCS18N-10	MDCS18N-10-01	2023/3/27	2024/3/26
MXA Signal Analyzer Keysight	N9020B	MY60112409	2023/2/18	2024/2/17
Software	ADT_RF Test Software V6.6.5.4	N/A	N/A	N/A

Notes:

1. The test was performed in Oven room 2.
2. Tested Date: 2023/7/14

4.4 In-Band Emission Mask

Refer to section 4.3 to get information of the instruments.

4.5 Occupied Bandwidth

Refer to section 4.3 to get information of the instruments.

4.6 Frequency Stability

Description Manufacturer	Model No.	Serial No.	Calibrated Date	Calibrated Until
DC Power Supply Topward	6603D	795558	N/A	N/A
Fixed Attenuator Woken	MDCS18N-10	MDCS18N-10-01	2023/3/27	2024/3/26
MXA Signal Analyzer Keysight	N9020B	MY60112409	2023/2/18	2024/2/17
Software	ADT_RF Test Software V6.6.5.4	N/A	N/A	N/A
Temperature & Humidity Chamber Giant Force	GTH-150-40-SP-AR	MAA0812-008	2022/12/26	2023/12/25
True RMS Clamp Meter FLUKE	325	31130711WS	2023/6/8	2024/6/7

Notes:

1. The test was performed in Oven room 2.
2. Tested Date: 2023/7/14

4.7 Contention-based Protocol

Description Manufacturer	Model No.	Serial No.	Calibrated Date	Calibrated Until
Frequency Extender Keysight	N5182BX07	MY59360198	2023/10/6	2024/10/5
MXG Vector Signal Generator Keysight	N5182B	MY53052647	2023/10/2	2024/10/1
Power Splitter/Combiner Mini-Circuits	ZFRSC-123-S+	F698501347_01	2022/12/28	2023/12/27
		F698501347_02	2022/12/15	2023/12/14
PXA Signal Analyzer Keysight	N9030A	MY55410176	2023/6/13	2024/6/12
Signal Analyzer R&S	FSV40	101516	2023/2/10	2024/2/9

Notes:

1. The test was performed in Adaptivity room.
2. Tested Date: 2023/12/7

4.8 AC Power Conducted Emissions

Description Manufacturer	Model No.	Serial No.	Calibrated Date	Calibrated Until
50 ohm terminal resistance	N/A	EMC-01	2022/9/27	2023/9/26
EMI Test Receiver R&S	ESCS 30	847124/029	2022/10/14	2023/10/13
Fixed Attenuator STI	STI02-2200-10	005	2023/7/1	2024/6/30
LISN R&S	ESH3-Z5	848773/004	2022/10/18	2023/10/17
RF Coaxial Cable JYEBAO	5D-FB	COCCAB-001	2023/7/1	2024/6/30
Software BVADT	BVADT_Cond_V7.3.7.4	N/A	N/A	N/A

Notes:

1. The test was performed in Conduction 1
2. Tested Date: 2023/7/11

4.9 Unwanted Emissions below 1 GHz

Description Manufacturer	Model No.	Serial No.	Calibrated Date	Calibrated Until
Antenna Tower & Turn Table Max-Full	MF-7802	MF780208406	N/A	N/A
Bi_Log Antenna Schwarzbeck	VULB 9168	9168-361	2022/10/21	2023/10/20
Fix tool for Boresight antenna tower BV	FBA-01	FBA_SIP01	N/A	N/A
Fixed Attenuator Mini-Circuits	UNAT-5+	PAD-3m-3-01	2022/9/14	2023/9/13
Loop Antenna Electro-Metrics	EM-6879	264	2023/2/21	2024/2/20
MXE EMI Receiver Keysight	N9038A	MY59050100	2023/6/13	2024/6/12
Preamplifier Agilent	8447D	2944A10636	2023/3/12	2024/3/11
Preamplifier Mini-Circuits	ZFL-1000VH2	QA0838008	2022/10/4	2023/10/3
PXA Signal Analyzer Keysight	N9030B	MY57142938	2023/4/6	2024/4/5
RF Coaxial Cable JYEBAO	5D-FB	LOOPCAB-001	2022/12/19	2023/12/18
		LOOPCAB-002	2022/12/19	2023/12/18
RF Coaxial Cable PEWC	8D	966-3-2	2023/2/17	2024/2/16
		966-3-3	2023/2/17	2024/2/16
		966-4-1	2023/2/18	2024/2/17
Software	ADT_Radiated_V8.7.08	N/A	N/A	N/A

Notes:

1. The test was performed in 966 Chamber No. 3.
2. Tested Date: 2023/7/11

4.10 Unwanted Emissions above 1 GHz

Description Manufacturer	Model No.	Serial No.	Calibrated Date	Calibrated Until
Antenna Tower & Turn Table Max-Full	MF-7802	MF780208406	N/A	N/A
Fix tool for Boresight antenna tower BV	FBA-01	FBA_SIP01	N/A	N/A
Horn Antenna Schwarzbeck	BBHA 9120D	9120D-406	2022/11/13	2023/11/12
	BBHA 9170	9170-739	2022/11/13	2023/11/12
MXE EMI Receiver Keysight	N9038A	MY59050100	2022/6/20 2023/6/13	2023/6/19 2024/6/12
Preamplifier EMCI	EMC12630SE	980384	2022/12/28	2023/12/27
	EMC184045SE	980387	2022/12/28	2023/12/27
PXA Signal Analyzer Keysight	N9030B	MY57142938	2023/4/6	2024/4/5
RF Coaxial Cable EMCI	EMC-KM-KM-4000	200214	2023/2/20	2024/2/19
	EMC102-KM-KM-1200	160924	2022/12/28	2023/12/27
	EMC104-SM-SM-1500	180504	2023/3/27	2024/3/26
	EMC104-SM-SM-2000	180601	2022/6/6 2023/6/2	2023/6/5 2024/6/1
	EMC104-SM-SM-6000	210201	2023/5/8	2024/5/7
Software	ADT_Radiated_V8.7.08	N/A	N/A	N/A

Notes:

1. The test was performed in 966 Chamber No. 3.
2. Tested Date: 2023/5/17 ~ 2023/7/11

5 Limits of Test Items

5.1 Maximum RF Output Power

Operation Band	EUT Category	Limit
		Maximum Average Power
U-NII-5 U-NII-6 U-NII-7 U-NII-8	Low Power Indoor AP Subordinate Device	EIRP 30 dBm

5.2 Maximum Power Spectral Density

Operation Band	EUT Category	Limit
		Maximum Power Density
U-NII-5 U-NII-6 U-NII-7 U-NII-8	Low Power Indoor AP Subordinate Device	EIRP 5 dBm/MHz

5.3 Emission Bandwidth

The maximum transmitter channel bandwidth for U-NII devices in the 5.925-7.125 GHz band is 320 MHz.

5.4 In-Band Emission Mask

Test Item	Frequencies (MHz)	(X) dB ^{*1}
Emission Mask	At 1 MHz outside of channel edge	20
	At one channel bandwidth from the channel center ^{*2}	28
	At one- and one-half times the channel bandwidth away from channel center ^{*3}	40
	More than one- and one-half times the channel bandwidth	40

^{*1} : The power spectral density must be suppressed by "x" dB

^{*2} : At frequencies between one megahertz outside an unlicensed device's channel edge and one channel bandwidth from the center of the channel, the limits must be linearly interpolated between 20 dB and 28 dB suppression,

^{*3} : At frequencies between one and one- and one-half times an unlicensed device's channel bandwidth, the limits must be linearly interpolated between 28 dB and 40 dB suppression.

5.5 Occupied Bandwidth

The maximum transmitter channel bandwidth for U-NII devices in the 5.925-7.125 GHz band is 320 MHz.

5.6 Frequency Stability

The frequency of the carrier signal shall be maintained within band of operation.

5.7 Contention-based Protocol

Unlicensed indoor low-power devices must detect co-channel radio frequency power that is at least -62 dBm (The threshold is referenced to a 0 dBi antenna gain.) or lower. Additionally, indoor low-power devices must detect co-channel energy with 90% or greater certainty.

5.8 AC Power Conducted Emissions

Frequency (MHz)	Conducted Limit (dBuV)	
	Quasi-peak	Average
0.15 - 0.5	66 - 56	56 - 46
0.50 - 5.0	56	46
5.0 - 30.0	60	50

Notes:

1. The lower limit shall apply at the transition frequencies.
2. The limit decreases in line with the logarithm of the frequency in the range of 0.15 to 0.50 MHz.

5.9 Unwanted Emissions below 1 GHz

Radiated emissions which fall in the restricted bands must comply with the radiated emission limits specified as below table.

Frequencies (MHz)	Field Strength (microvolts/meter)	Measurement Distance (meters)
0.009 ~ 0.490	2400/F(kHz)	300
0.490 ~ 1.705	24000/F(kHz)	30
1.705 ~ 30.0	30	30
30 ~ 88	100	3
88 ~ 216	150	3
216 ~ 960	200	3
Above 960	500	3

Notes:

1. The lower limit shall apply at the transition frequencies.
2. Emission level (dBuV/m) = 20 log Emission level (uV/m).

5.10 Unwanted Emissions above 1 GHz

Radiated emissions which fall in the restricted bands must comply with the radiated emission limits specified as below table.

Frequencies (MHz)	Field Strength (microvolts/meter)	Measurement Distance (meters)
Above 960	500	3

Notes:

1. The lower limit shall apply at the transition frequencies.
2. Emission level (dBuV/m) = 20 log Emission level (uV/m).
3. For frequencies above 1000 MHz, the field strength limits are based on average detector, however, the peak field strength of any emission shall not exceed the maximum permitted average limits, specified above by more than 20 dB under any condition of modulation.

Limits of unwanted emission out of the restricted bands

Frequencies (MHz)	EIRP Limit	Equivalent Field Strength at 3 m
5925 MHz > F > 7125 MHz	Peak: -7 (dBm/MHz)	88.2 (dBuV/m)
	Average: -27 (dBm/MHz)	68.2 (dBuV/m)

Note: The following formula is used to convert the equipment isotropic radiated power (eirp) to field strength:

$$E = \frac{1000000 \sqrt{30P}}{3} \mu\text{V/m, where } P \text{ is the eirp (Watts).}$$

6 Test Arrangements

6.1 Maximum RF Output Power

6.1.1 Test Setup

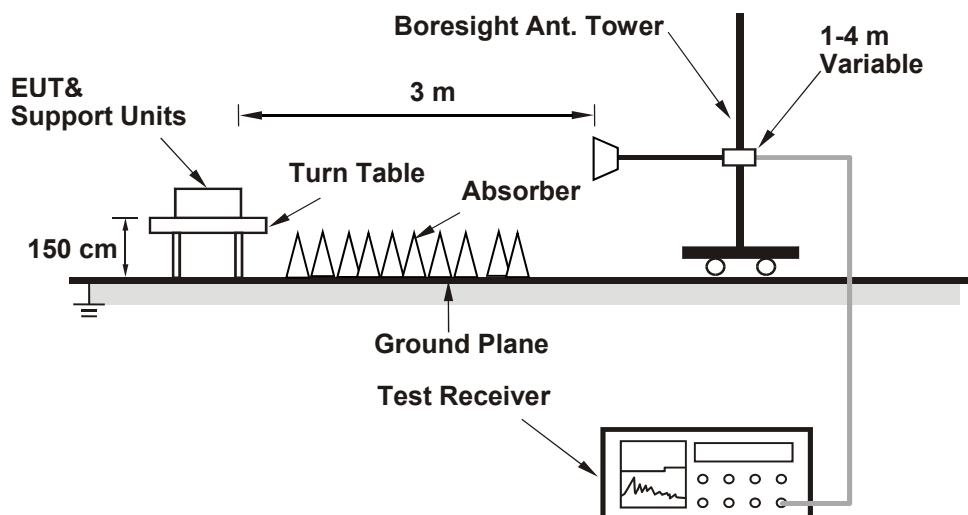

6.1.2 Test Procedure

- The EUT was placed on the top of a rotating table 1.5 meters above the ground at 3 meter chamber room for test. The table was rotated 360 degrees to determine the position of the highest radiation.
- The EUT was set 3 meters away from the interference-receiving antenna, which was mounted on the top of a variable-height antenna tower.
- The height of antenna is varied from one meter to four meters above the ground to determine the maximum value of the field strength. Both horizontal and vertical polarizations of the antenna are set to make the measurement.
- Perform a field strength measurement and record the worse read value, is the field strength value via a spectrum reading obtained corrected for antenna factor, cable loss and pre-amplifier factor and then mathematically convert the measured field strength level to EIRP level.
- Follow ANSI C63.10 section 12.7.3, $EIRP \text{ Value (dBm)} = \text{Field Strength Value (dBuV / m)} + \text{Correction Factor @ 3 m}$.
- $\text{Correction Factor (dB) @ 3 m} = 20\log(D) - 104.77 = -95.23 \text{ dB}$; where D is the measurement distance @3 m.

Spectrum analyzer setting as below:

Method SA-1

- Set span to encompass the entire emission bandwidth (EBW) of the signal.
- Set RBW = 1 MHz, Set VBW \geq 3 MHz, Detector = RMS
- Sweep points $\geq [2 \times \text{span} / \text{RBW}]$. (This gives bin-to-bin spacing $\leq \text{RBW} / 2$, so that narrowband signals are not lost between frequency bins.)
- Sweep time = auto, trigger set to "free run".
- Trace average at least 100 traces in power averaging mode.
- Record the max value

Note: When measuring power, use compute power by integrating the spectrum across the 26 dB EBW or 99% OBW of the signal using the instrument's band power measurement function, with band limits set equal to the EBW or OBW band edges. If the instrument does not have a band power function, then sum the spectrum levels (in power units) at 1 MHz intervals extending across the 26 dB EBW or 99% OBW of the spectrum.

Method SA-2

- a. Set span to encompass the entire emission bandwidth (EBW) of the signal.
- b. Set RBW = 1 MHz, Set VBW \geq 3 MHz, Detector = RMS
- c. Sweep time = auto, trigger set to "free run".
- d. Sweep points $\geq [2 \times \text{span} / \text{RBW}]$. (This gives bin-to-bin spacing $\leq \text{RBW} / 2$, so that narrowband signals are not lost between frequency bins.)
- e. Add $10 \log (1/\text{duty cycle})$ to spectrum instrument offset.
- f. Trace average at least 100 traces in power averaging mode.
- g. Use the peak search function on the instrument to find the peak of the spectrum and record its value.
- h. Record the max value.

Note: When measuring power, use compute power by integrating the spectrum across the 26 dB EBW or 99% OBW of the signal using the instrument's band power measurement function, with band limits set equal to the EBW or OBW band edges. If the instrument does not have a band power function, then sum the spectrum levels (in power units) at 1 MHz intervals extending across the 26 dB EBW or 99% OBW of the spectrum.

6.2 Maximum Power Spectral Density

6.2.1 Test Setup

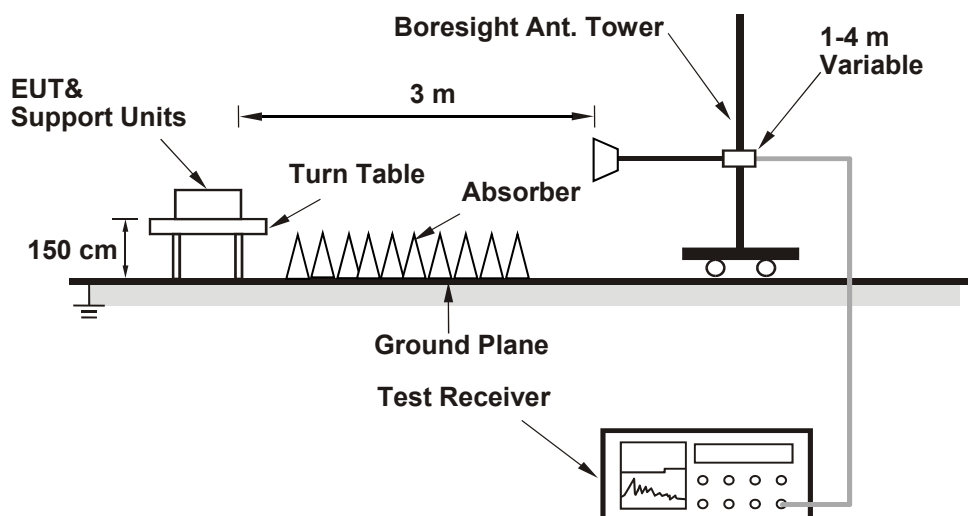

6.2.2 Test Procedure

- The EUT was placed on the top of a rotating table 1.5 meters above the ground at 3 meter chamber room for test. The table was rotated 360 degrees to determine the position of the highest radiation.
- The EUT was set 3 meters away from the interference-receiving antenna, which was mounted on the top of a variable-height antenna tower.
- The height of antenna is varied from one meter to four meters above the ground to determine the maximum value of the field strength. Both horizontal and vertical polarizations of the antenna are set to make the measurement.
- Perform a field strength measurement and record the worse read value, is the field strength value via a spectrum reading obtained corrected for antenna factor, cable loss and pre-amplifier factor and then mathematically convert the measured field strength level to EIRP level.
- Follow ANSI C63.10 section 12.7.3, $EIRP \text{ Value (dBm)} = \text{Field Strength Value (dBuV/m)} + \text{Correction Factor @ 3 m}$.
- $\text{Correction Factor (dB) @ 3 m} = 20\log(D) - 104.77$; where D is the measurement distance @3 m = -95.23 dB

Spectrum analyzer setting as below:

Method SA-1

- Set span to encompass the entire emission bandwidth (EBW) of the signal.
- Set RBW = 1 MHz, Set VBW \geq 3 MHz, Detector = RMS
- Sweep points $\geq [2 \times \text{span} / \text{RBW}]$. (This gives bin-to-bin spacing $\leq \text{RBW} / 2$, so that narrowband signals are not lost between frequency bins.)
- Sweep time = auto, trigger set to "free run".
- Trace average at least 100 traces in power averaging mode.
- Record the max value

Method SA-2

- Set span to encompass the entire emission bandwidth (EBW) of the signal.
- Set RBW = 1 MHz, Set VBW \geq 3 MHz, Detector = RMS
- Sweep points $\geq [2 \times \text{span} / \text{RBW}]$. (This gives bin-to-bin spacing $\leq \text{RBW} / 2$, so that narrowband signals are not lost between frequency bins.)
- Sweep time = auto, trigger set to "free run".
- Add $10 \log (1/\text{duty cycle})$ to spectrum instrument offset.
- Trace average at least 100 traces in power averaging mode.
- Use the peak search function on the instrument to find the peak of the spectrum and record its value.
- Record the max value.

6.3 Emission Bandwidth

6.3.1 Test Setup

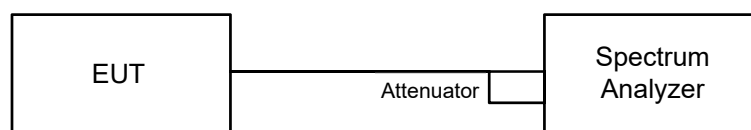

6.3.2 Test Procedure

- a. Set RBW = approximately 1% of the emission bandwidth.
- b. Set the VBW > RBW.
- c. Detector = Peak.
- d. Trace mode = max hold.
- e. Measure the maximum width of the emission that is 26 dB down from the peak of the emission. Compare this with the RBW setting of the analyzer. Readjust RBW and repeat measurement as needed until the RBW/EBW ratio is approximately 1%.

6.4 In-Band Emission Mask

6.4.1 Test Setup

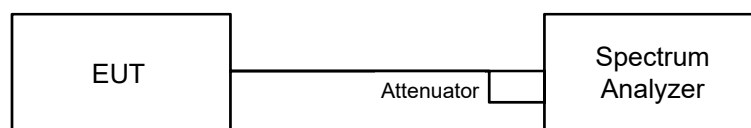

6.4.2 Test Procedure

- a. Connect output of the antenna port to a spectrum analyzer and adjust appropriate attenuation.
- b. Measure the 26 dB EBW using the test procedure 12.4.1 of ANSI C63.10-2013. (Determine the channel edge.)
- c. Measure the power spectral density (for emissions mask reference) using the following procedure:
 - a) Set the span to encompass the entire 26 dB EBW of the signal.
 - b) Set RBW = same RBW used for 26 dB EBW measurement.
 - c) Set VBW $\geq [3 \times \text{RBW}]$.
 - d) Number of points in sweep $\geq [2 \times \text{span} / \text{RBW}]$.
 - e) Sweep time = auto.
 - f) Detector = RMS (i.e., power averaging).
 - g) Trace average at least 100 traces in power averaging (rms) mode.
 - h) Use the peak search function on the instrument to find the peak of the spectrum.
- d. Using the measuring equipment limit line function, develop the emissions mask based on the following requirements. The emissions power spectral density must be reduced below the peak power spectral density (in dB) as follows:
 - a) Suppressed by 20 dB at 1 MHz outside of the channel edge. (The channel edge is defined as the 26-dB point on either side of the carrier center frequency.)
 - b) Suppressed by 28 dB at one channel bandwidth from the channel center.
 - c) Suppressed by 40 dB at one- and one-half times the channel bandwidth from the channel center.
- e. Adjust the span to encompass the entire mask as necessary and clear trace.
- f. Trace average at least 100 traces in power averaging (rms) mode.
- g. Adjust the reference level as necessary so that the crest of the channel touches the top of the emission mask

6.5 Occupied Bandwidth

6.5.1 Test Setup

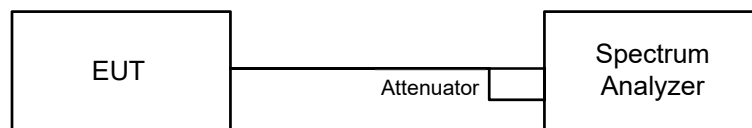

6.5.2 Test Procedure

The transmitter output was connected to the spectrum analyzer through an attenuator. The bandwidth of the fundamental frequency was measured by spectrum analyzer with resolution bandwidth in the range of 1% to 5% of the anticipated emission bandwidth, and a video bandwidth at least 3x the resolution bandwidth and set the detector to Sampling. The width of a frequency band such that, below the lower and above the upper frequency limits, the mean powers emitted are each equal to a specified percentage 0.5% of the total mean power of a given emission.

6.6 Frequency Stability

6.6.1 Test Setup

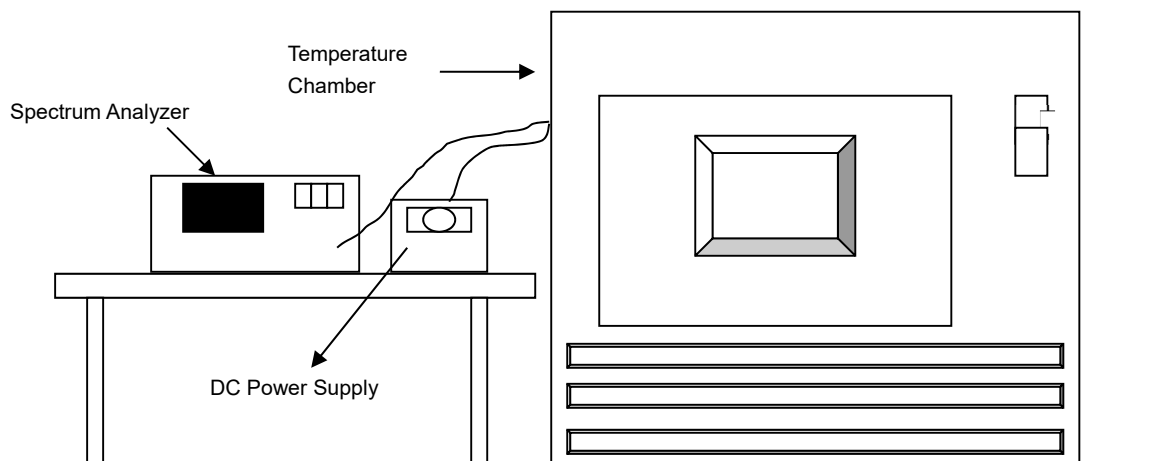

6.6.2 Test Procedure

- The EUT was placed inside the environmental test chamber and powered by nominal DC voltage.
- Turn the EUT on and couple its output to a spectrum analyzer.
- Turn the EUT off and set the chamber to the highest temperature specified.
- Allow sufficient time (approximately 30 min) for the temperature of the chamber to stabilize, turn the EUT on and measure the operating frequency after 2, 5, and 10 Minutes.
- Repeat step (d) with the temperature chamber set to the next desired temperature until measurements down to the lowest specified temperature have been completed.
- The test chamber was allowed to stabilize at +20 degree C for a minimum of 30 Minutes. The supply voltage was then adjusted on the EUT from 85% to 115% and the frequency record.

6.7 Contention-based Protocol

6.7.1 Test Setup

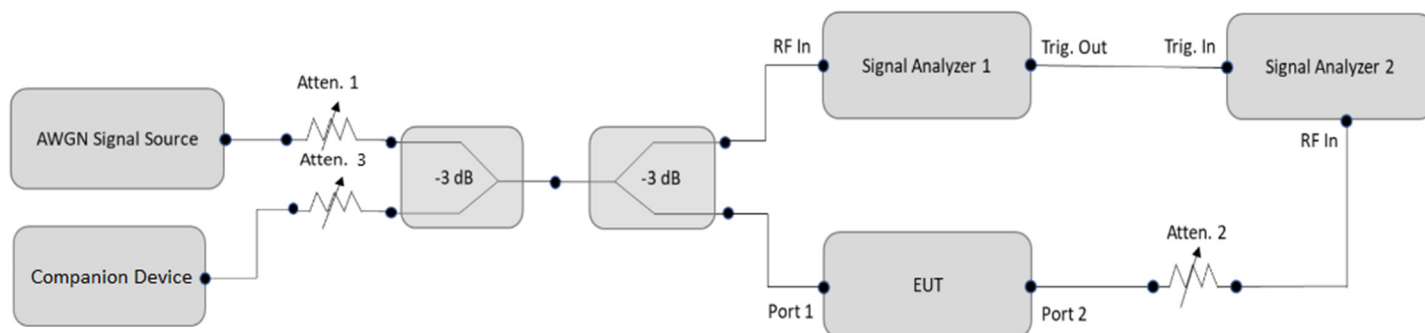

6.7.2 Test Procedure

- Set the signal analyzer center frequency to the nominal EUT channel center frequency. The span range of the signal analyzer shall be between two times and five times the OBW of the EUT. Connect the output port of the EUT to the signal analyzer 2. Ensure that the attenuator 2 provides enough attenuation to not overload the signal analyzer 2 receiver.
- Monitoring the signal analyzer 2, verify the EUT is operating and transmitting with the parameters (set as following section 4.7.5 EUT operating condition).
- Determine number of times detection threshold test as following table,

If	Number of Tests	Placement of Incumbent Transmission
$BW_{EUT} \leq BW_{Inc}$	Once	Same as EUT transmission
$BW_{Inc} < BW_{EUT} \leq 2x BW_{Inc}$	Once	Contained within BW_{EUT}
$2x BW_{Inc} < BW_{EUT} \leq 4x BW_{Inc}$	Twice. (Incumbent transmission is contained within BW_{EUT})	Closely to the lower edge and upper edge of the EUT Channel
$BW_{EUT} > 4x BW_{Inc}$	Three times	Closely to the lower edge, in the middle and upper edge of the EUT Channel

- Using an AWGN signal source, generate (but do not transmit, i.e., RF OFF) a 10 MHz-wide AWGN signal. Use step c table to determine the center frequency of the 10 MHz AWGN signal relative to the EUT's channel bandwidth and center frequency.
- Set the AWGN signal power to an extremely low level (more than 20 dB below the -62 dBm threshold). Connect the AWGN signal source, via a 3-dB splitter, to the signal analyzer 1 and the EUT.
- Transmit the AWGN signal (RF ON) and verify its characteristics on the signal analyzer 1.
- Monitor the signal analyzer 2 to verify if the AWGN signal has been detected and the EUT has ceased transmission. If the EUT continues to transmit, then incrementally increase the AWGN signal power level until the EUT stops transmitting.
- (Including all losses in the RF paths) Determine and record the AWGN signal power level (at the EUT's antenna port) at which the EUT ceased transmission. Repeat the procedure at least 10 times to verify the EUT can detect an AWGN signal with 90% (or better) level of certainty.
- Refer to step c table to determine number of times the detection threshold testing needs to be repeated. If testing is required more than once, then go back to step d, choose a different center frequency for the AWGN signal and repeat the process.

6.8 AC Power Conducted Emissions

6.8.1 Test Setup

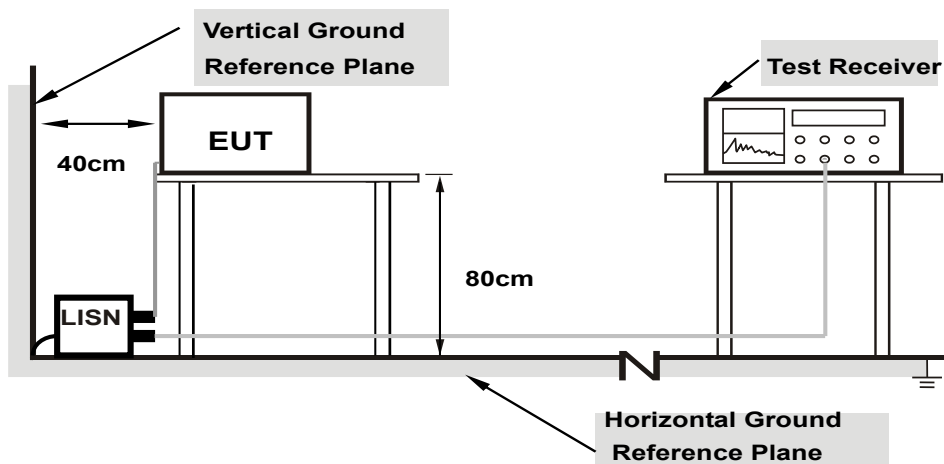

Note: 1.Support units were connected to second LISN.

For the actual test configuration, please refer to the attached file (Test Setup Photo).

6.8.2 Test Procedure

- The EUT was placed on a 0.8 meter to the top of table and placed 0.4 meters from the conducting wall of the shielded room with EUT being connected to the power mains through a line impedance stabilization network (LISN). Other support units were connected to the power mains through another LISN. The two LISNs provide 50 ohm/ 50 uH of coupling impedance for the measuring instrument.
- Both lines of the power mains connected to the EUT were checked for maximum conducted interference.
- The frequency range from 150 kHz to 30 MHz was searched. Emission levels under (Limit – 20 dB) was not recorded.

Note: The resolution bandwidth and video bandwidth of test receiver is 9 kHz for quasi-peak detection (QP) and average detection (AV) at frequency 0.15 MHz-30 MHz.

6.9 Unwanted Emissions below 1 GHz

6.9.1 Test Setup

For Radiated emission below 30 MHz

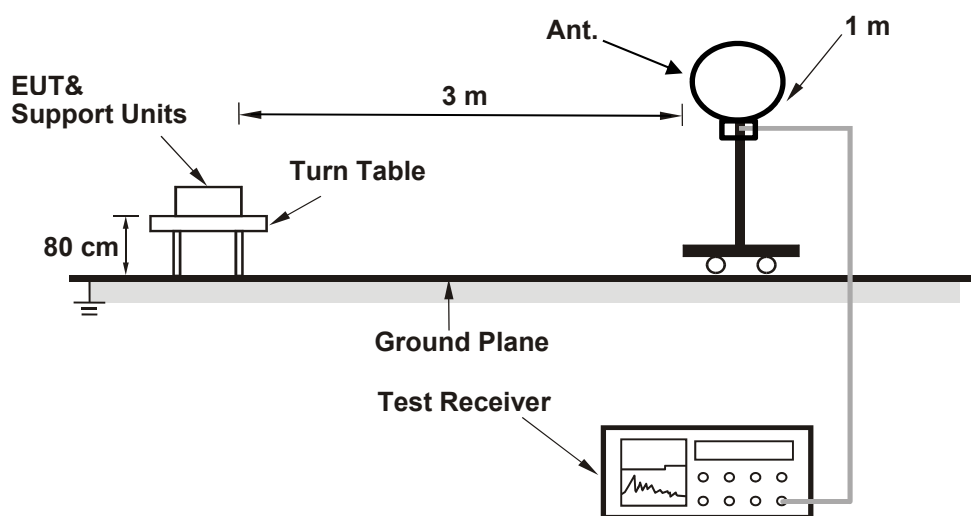

For Radiated emission above 30 MHz

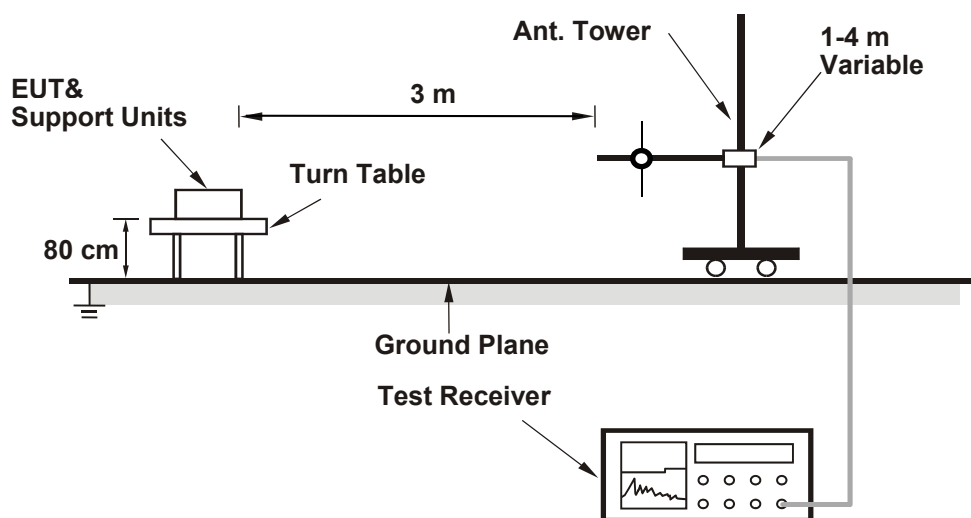

For the actual test configuration, please refer to the attached file (Test Setup Photo).

6.9.2 Test Procedure

For Radiated emission below 30 MHz

- a. The EUT was placed on the top of a rotating table 0.8 meters above the ground at 3 meter chamber room for test. The table was rotated 360 degrees to determine the position of the highest radiation.
- b. The EUT was set 3 meters away from the interference-receiving antenna, which was mounted on the top of a variable-height antenna tower.
- c. Parallel, perpendicular, and ground-parallel orientations of the antenna are set to make the measurement.
- d. For each suspected emission, the EUT was arranged to its worst case and the rotatable table was turned from 0 degrees to 360 degrees to find the maximum reading.
- e. The test-receiver system was set to Quasi-Peak Detect Function and Specified Bandwidth with Maximum Hold Mode, except for the frequency band (9 kHz to 90 kHz and 110 kHz to 490 kHz) set to average detect function and peak detect function.

Notes:

1. The resolution bandwidth and video bandwidth of test receiver/spectrum analyzer is 200 Hz at frequency below 150 kHz.
2. The resolution bandwidth and video bandwidth of test receiver/spectrum analyzer is 9 kHz or 10 kHz at frequency (150 kHz to 30 MHz).
3. All modes of operation were investigated and the worst-case emissions are reported.

For Radiated emission above 30 MHz

- a. The EUT was placed on the top of a rotating table 0.8 meters above the ground at 3 meter chamber room for test. The table was rotated 360 degrees to determine the position of the highest radiation.
- b. The EUT was set 3 meters away from the interference-receiving antenna, which was mounted on the top of a variable-height antenna tower.
- c. The height of antenna is varied from one meter to four meters above the ground to determine the maximum value of the field strength. Both horizontal and vertical polarizations of the antenna are set to make the measurement.
- d. For each suspected emission, the EUT was arranged to its worst case and then the antenna was tuned to heights from 1 meter to 4 meters and the rotatable table was turned from 0 degrees to 360 degrees to find the maximum reading.
- e. The test-receiver system was set to Quasi-peak(QP) detect function, Average(AV) detect function, Peak(PK) detect function and specified bandwidth with maximum hold mode when the test frequency is below 1 GHz.

Notes:

1. The resolution bandwidth and video bandwidth of test receiver/spectrum analyzer is 120 kHz for Quasi-peak detection (QP), Average detection (AV), Peak detection (PK) at frequency (30MHz to 1 GHz).
2. All modes of operation were investigated and the worst-case emissions are reported.

6.10 Unwanted Emissions above 1 GHz

6.10.1 Test Setup

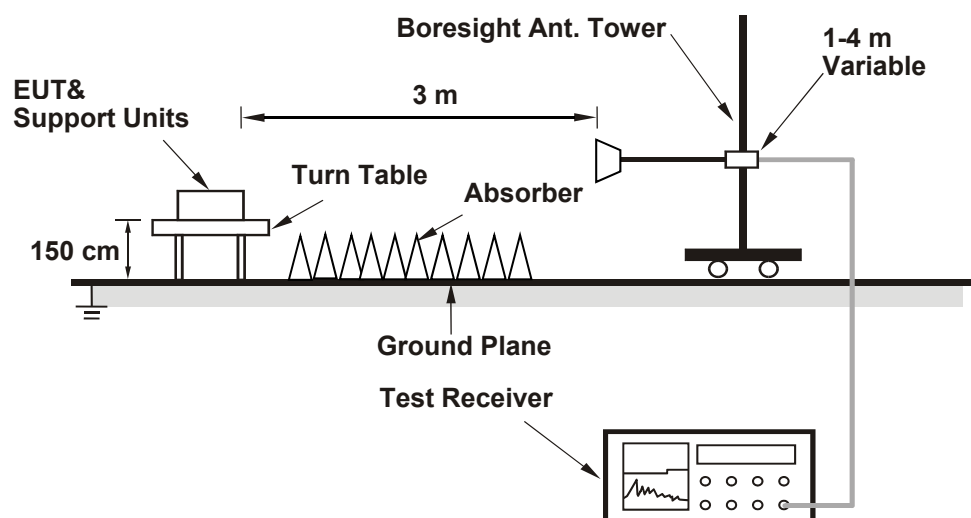

For the actual test configuration, please refer to the attached file (Test Setup Photo).

6.10.2 Test Procedure

- The EUT was placed on the top of a rotating table 1.5 meters above the ground at 3 meter chamber room for test. The table was rotated 360 degrees to determine the position of the highest radiation.
- The EUT was set 3 meters away from the interference-receiving antenna, which was mounted on the top of a variable-height antenna tower.
- The height of antenna is varied from one meter to four meters above the ground to determine the maximum value of the field strength. Both horizontal and vertical polarizations of the antenna are set to make the measurement.
- For each suspected emission, the EUT was arranged to its worst case and then the antenna was tuned to heights from 1 meter to 4 meters and the rotatable table was turned from 0 degrees to 360 degrees to find the maximum reading.
- The test-receiver system was set to peak and average detects function and specified bandwidth with maximum hold mode when the test frequency is above 1 GHz. If the peak reading value also meets average limit, measurement with the average detector is unnecessary.

Notes:

- The resolution bandwidth of test receiver/spectrum analyzer is 1 MHz and the video bandwidth is 3 MHz for Peak detection (PK) and Average detection (AV) at frequency above 1 GHz.
- For fundamental and harmonic signal measurement, the resolution bandwidth of test receiver/spectrum analyzer is 1 MHz and the video bandwidth is $\geq 1/T$ (Duty cycle $< 98\%$) or 10 Hz (Duty cycle $\geq 98\%$) for Average detection (AV) at frequency above 1 GHz.
- All modes of operation were investigated and the worst-case emissions are reported.

7 Test Results of Test Item

7.1 Maximum RF Output Power

Input Power:	24 Vdc	Environmental Conditions:	25°C, 60% RH	Tested By:	Katina Lu
--------------	--------	---------------------------	--------------	------------	-----------

802.11a

Chan.	Chan. Freq. (MHz)	Field Strength (dBuV/m)	Correction Factor (dB)	EIRP (mW)	EIRP (dBm)	EIRP Limit (dBm)	Test Result
1	5955	108.60	-95.23	21.727	13.37	30	Pass
45	6175	108.40	-95.23	20.749	13.17	30	Pass
93	6415	108.30	-95.23	20.277	13.07	30	Pass
97	6435	108.50	-95.23	21.232	13.27	30	Pass
105	6475	108.40	-95.23	20.749	13.17	30	Pass
113	6515	108.70	-95.23	22.233	13.47	30	Pass
117	6535	108.60	-95.23	21.727	13.37	30	Pass
149	6695	108.70	-95.23	22.233	13.47	30	Pass
181	6855	108.30	-95.23	20.277	13.07	30	Pass
185	6875	108.50	-95.23	21.232	13.27	30	Pass
209	6995	108.80	-95.23	22.751	13.57	30	Pass
233	7115	108.00	-95.23	18.923	12.77	30	Pass

802.11ax (HE20) CDD

Chan.	Chan. Freq. (MHz)	Field Strength (dBuV/m)	Correction Factor (dB)	EIRP (mW)	EIRP (dBm)	EIRP Limit (dBm)	Test Result
1	5955	108.90	-95.23	23.281	13.67	30	Pass
45	6175	109.20	-95.23	24.946	13.97	30	Pass
93	6415	108.40	-95.23	20.749	13.17	30	Pass
97	6435	108.70	-95.23	22.233	13.47	30	Pass
105	6475	108.80	-95.23	22.751	13.57	30	Pass
113	6515	109.10	-95.23	24.378	13.87	30	Pass
117	6535	109.30	-95.23	25.527	14.07	30	Pass
149	6695	109.10	-95.23	24.378	13.87	30	Pass
181	6855	108.80	-95.23	22.751	13.57	30	Pass
185	6875	108.60	-95.23	21.727	13.37	30	Pass
209	6995	108.70	-95.23	22.233	13.47	30	Pass
233	7115	99.97	-95.23	2.979	4.74	30	Pass

802.11ax (HE40) CDD

Chan.	Chan. Freq. (MHz)	Field Strength (dBuV/m)	Correction Factor (dB)	EIRP (mW)	EIRP (dBm)	EIRP Limit (dBm)	Test Result
3	5965	111.90	-95.23	46.452	16.67	30	Pass
43	6165	111.80	-95.23	45.394	16.57	30	Pass
91	6405	111.10	-95.23	38.637	15.87	30	Pass
99	6445	111.60	-95.23	43.351	16.37	30	Pass
107	6485	111.40	-95.23	41.4	16.17	30	Pass
115	6525	111.60	-95.23	43.351	16.37	30	Pass
123	6565	111.40	-95.23	41.4	16.17	30	Pass
155	6725	111.30	-95.23	40.458	16.07	30	Pass
179	6845	111.30	-95.23	40.458	16.07	30	Pass
187	6885	111.40	-95.23	41.4	16.17	30	Pass
211	7005	111.10	-95.23	38.637	15.87	30	Pass
227	7085	111.60	-95.23	43.351	16.37	30	Pass

802.11ax (HE80) CDD

Chan.	Chan. Freq. (MHz)	Field Strength (dBuV/m)	Correction Factor (dB)	EIRP (mW)	EIRP (dBm)	EIRP Limit (dBm)	Test Result
7	5985	113.90	-95.23	73.621	18.67	30	Pass
39	6145	114.20	-95.23	78.886	18.97	30	Pass
87	6385	113.30	-95.23	64.121	18.07	30	Pass
103	6465	114.10	-95.23	77.09	18.87	30	Pass
119	6545	114.00	-95.23	75.336	18.77	30	Pass
151	6705	114.20	-95.23	78.886	18.97	30	Pass
183	6865	114.10	-95.23	77.09	18.87	30	Pass
199	6945	113.90	-95.23	73.621	18.67	30	Pass
215	7025	113.50	-95.23	67.143	18.27	30	Pass

802.11ax (HE160) CDD

Chan.	Chan. Freq. (MHz)	Field Strength (dBuV/m)	Correction Factor (dB)	EIRP (mW)	EIRP (dBm)	EIRP Limit (dBm)	Test Result
15	6025	116.50	-95.23	133.968	21.27	30	Pass
47	6185	116.50	-95.23	133.968	21.27	30	Pass
79	6345	115.90	-95.23	116.681	20.67	30	Pass
111	6505	117.00	-95.23	150.314	21.77	30	Pass
143	6665	116.30	-95.23	127.938	21.07	30	Pass
175	6825	116.80	-95.23	143.549	21.57	30	Pass
207	6985	116.60	-95.23	137.088	21.37	30	Pass

802.11ax (HE20) Beamforming

Chan.	Chan. Freq. (MHz)	Field Strength (dBuV/m)	Correction Factor (dB)	EIRP (mW)	EIRP (dBm)	EIRP Limit (dBm)	Test Result
1	5955	106.90	-95.23	14.689	11.67	30	Pass
45	6175	108.00	-95.23	18.923	12.77	30	Pass
93	6415	109.60	-95.23	27.353	14.37	30	Pass
97	6435	108.30	-95.23	20.277	13.07	30	Pass
105	6475	108.80	-95.23	22.751	13.57	30	Pass
113	6515	108.20	-95.23	19.815	12.97	30	Pass
117	6535	109.40	-95.23	26.122	14.17	30	Pass
149	6695	108.50	-95.23	21.232	13.27	30	Pass
181	6855	109.20	-95.23	24.946	13.97	30	Pass
185	6875	108.40	-95.23	20.749	13.17	30	Pass
209	6995	108.30	-95.23	20.277	13.07	30	Pass
233	7115	101.30	-95.23	4.046	6.07	30	Pass

802.11ax (HE40) Beamforming

Chan.	Chan. Freq. (MHz)	Field Strength (dBuV/m)	Correction Factor (dB)	EIRP (mW)	EIRP (dBm)	EIRP Limit (dBm)	Test Result
3	5965	110.60	-95.23	34.435	15.37	30	Pass
43	6165	111.70	-95.23	44.361	16.47	30	Pass
91	6405	113.80	-95.23	71.945	18.57	30	Pass
99	6445	113.90	-95.23	73.621	18.67	30	Pass
107	6485	112.70	-95.23	55.847	17.47	30	Pass
115	6525	112.60	-95.23	54.576	17.37	30	Pass
123	6565	110.20	-95.23	31.405	14.97	30	Pass
155	6725	111.10	-95.23	38.637	15.87	30	Pass
179	6845	112.10	-95.23	48.641	16.87	30	Pass
187	6885	111.60	-95.23	43.351	16.37	30	Pass
211	7005	112.30	-95.23	50.933	17.07	30	Pass
227	7085	111.00	-95.23	37.757	15.77	30	Pass

802.11ax (HE80) Beamforming

Chan.	Chan. Freq. (MHz)	Field Strength (dBuV/m)	Correction Factor (dB)	EIRP (mW)	EIRP (dBm)	EIRP Limit (dBm)	Test Result
7	5985	115.20	-95.23	99.312	19.97	30	Pass
39	6145	113.20	-95.23	62.661	17.97	30	Pass
87	6385	116.30	-95.23	127.938	21.07	30	Pass
103	6465	113.50	-95.23	67.143	18.27	30	Pass
119	6545	113.70	-95.23	70.307	18.47	30	Pass
151	6705	113.30	-95.23	64.121	18.07	30	Pass
183	6865	112.50	-95.23	53.333	17.27	30	Pass
199	6945	114.80	-95.23	90.573	19.57	30	Pass
215	7025	114.70	-95.23	88.512	19.47	30	Pass



802.11ax (HE160) Beamforming

Chan.	Chan. Freq. (MHz)	Field Strength (dBuV/m)	Correction Factor (dB)	EIRP (mW)	EIRP (dBm)	EIRP Limit (dBm)	Test Result
15	6025	116.60	-95.23	137.088	21.37	30	Pass
47	6185	115.80	-95.23	114.025	20.57	30	Pass
79	6345	117.70	-95.23	176.604	22.47	30	Pass
111	6505	113.50	-95.23	67.143	18.27	30	Pass
143	6665	113.60	-95.23	68.707	18.37	30	Pass
175	6825	111.60	-95.23	43.351	16.37	30	Pass
207	6985	117.00	-95.23	150.314	21.77	30	Pass

Spectrum Plot of Maximum Value

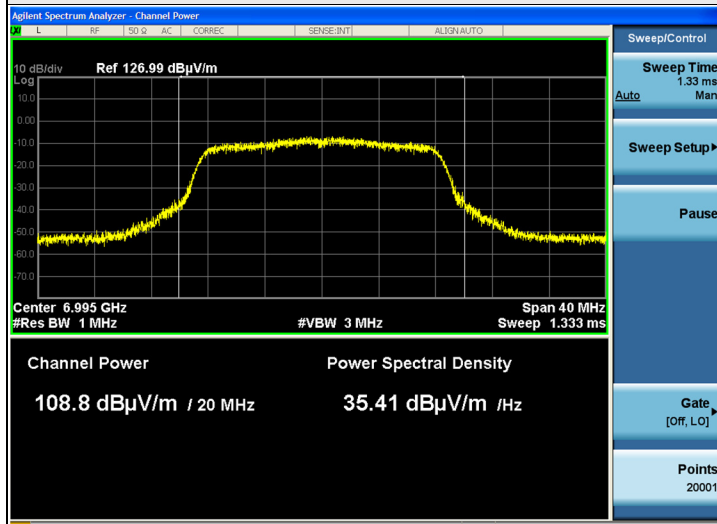

802.11a: CH 209

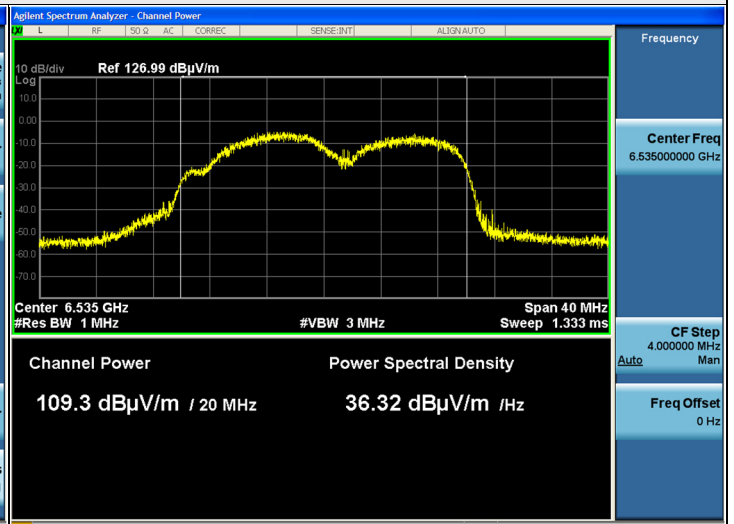

802.11ax (HE20) CDD: CH 117

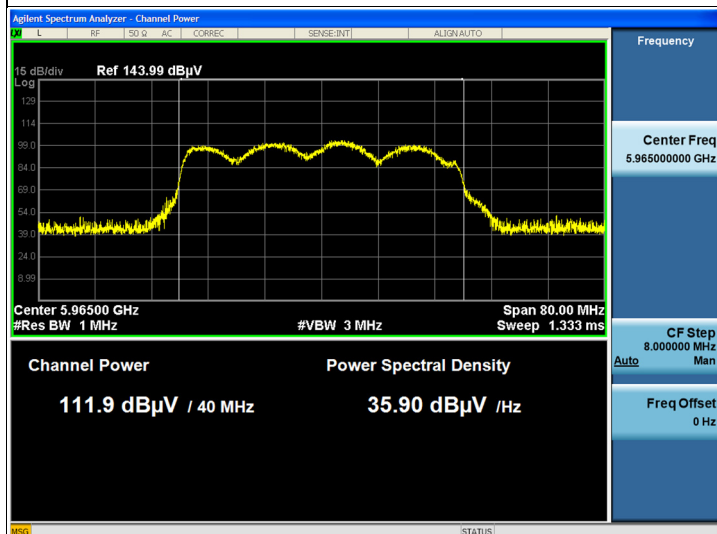

802.11ax (HE40) CDD: CH 3

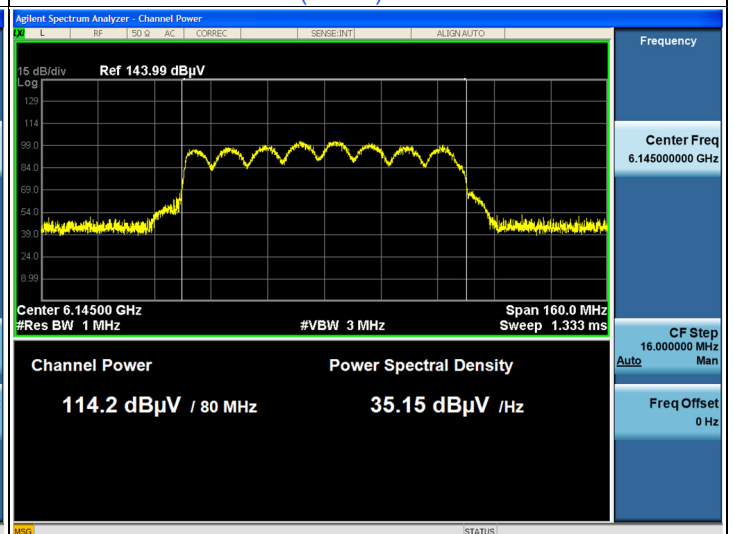

802.11ax (HE80) CDD: CH 39

Spectrum Plot of Maximum Value

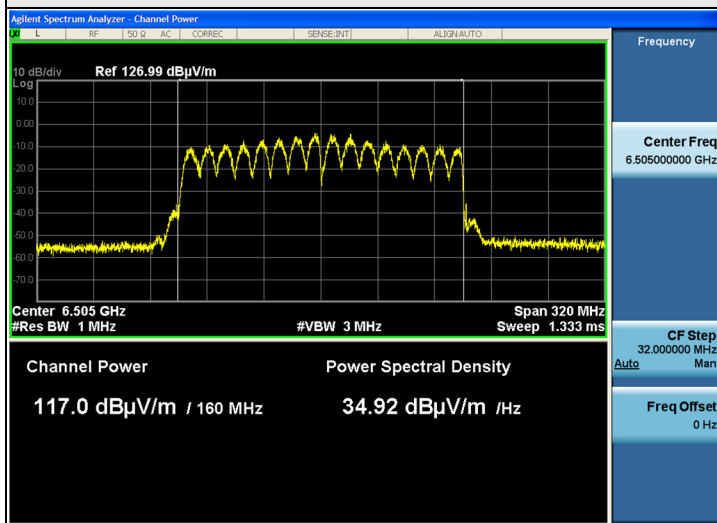

802.11ax (HE160) CDD: CH 111

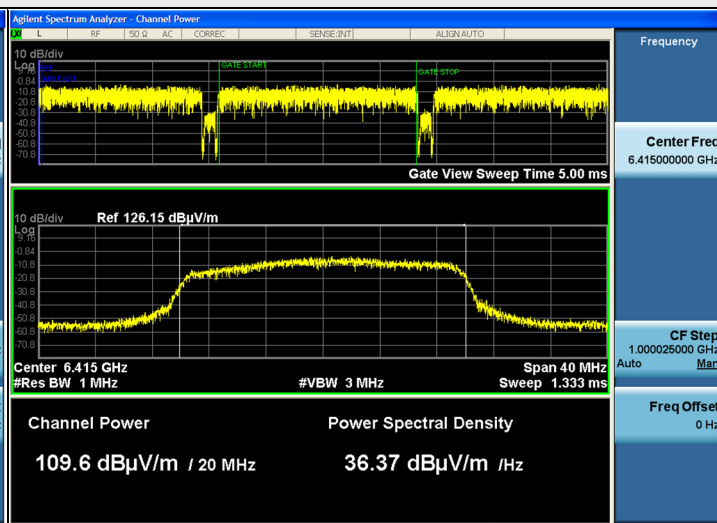

802.11ax (HE20) Beamforming: CH 93

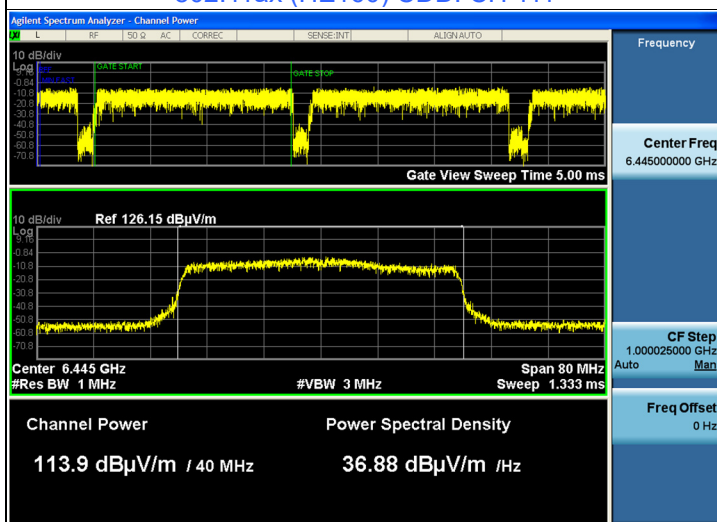

802.11ax (HE40) Beamforming: CH 99

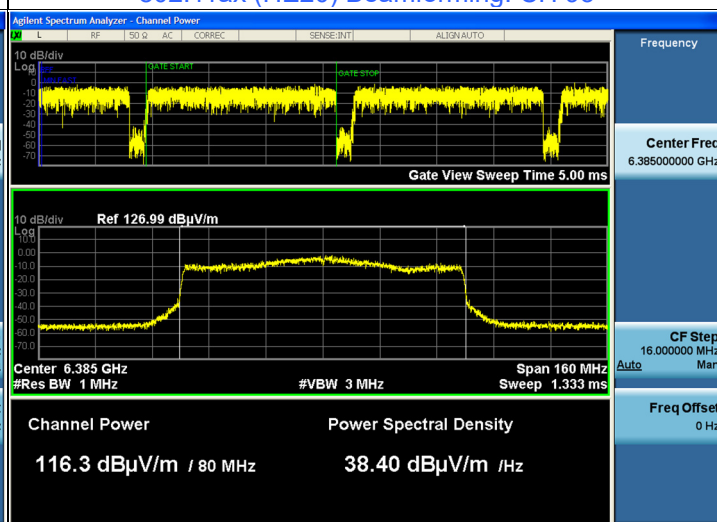

802.11ax (HE80) Beamforming: CH 87

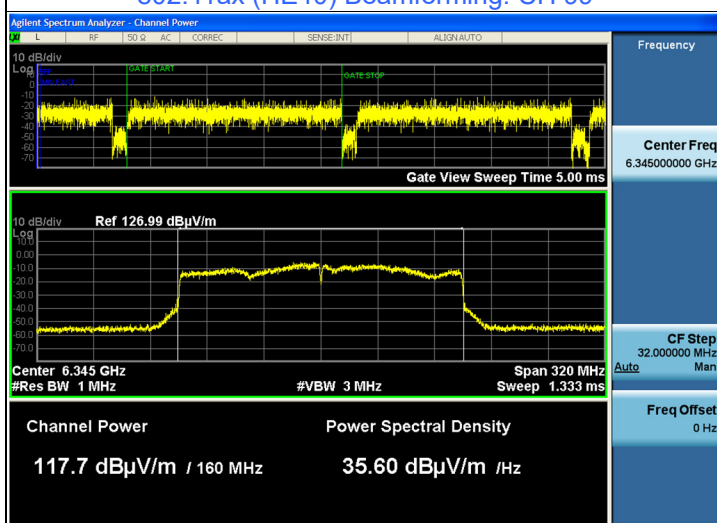

802.11ax (HE160) Beamforming: CH 79

7.2 Maximum Power Spectral Density

Input Power:	24 Vdc	Environmental Conditions:	25°C, 60% RH	Tested By:	Katina Lu
--------------	--------	---------------------------	--------------	------------	-----------

802.11a

Chan.	Chan. Freq. (MHz)	Field Strength (dBuV/m)	Correction Factor (dB)	EIRP PSD (dBm/MHz)	EIRP PSD Limit (dBm/MHz)	Test Result
1	5955	100.04	-95.23	4.81	5	Pass
45	6175	100.09	-95.23	4.86	5	Pass
93	6415	100.13	-95.23	4.90	5	Pass
97	6435	100.11	-95.23	4.88	5	Pass
105	6475	100.11	-95.23	4.88	5	Pass
113	6515	100.14	-95.23	4.91	5	Pass
117	6535	100.08	-95.23	4.85	5	Pass
149	6695	100.12	-95.23	4.89	5	Pass
181	6855	100.09	-95.23	4.86	5	Pass
185	6875	100.13	-95.23	4.90	5	Pass
209	6995	100.16	-95.23	4.93	5	Pass
233	7115	100.10	-95.23	4.87	5	Pass

802.11ax (HE20) CDD

Chan.	Chan. Freq. (MHz)	Field Strength (dBuV/m)	Correction Factor (dB)	EIRP PSD (dBm/MHz)	EIRP PSD Limit (dBm/MHz)	Test Result
1	5955	100.08	-95.23	4.85	5	Pass
45	6175	100.12	-95.23	4.89	5	Pass
93	6415	100.07	-95.23	4.83	5	Pass
97	6435	100.11	-95.23	4.88	5	Pass
105	6475	100.07	-95.23	4.84	5	Pass
113	6515	100.09	-95.23	4.86	5	Pass
117	6535	100.15	-95.23	4.92	5	Pass
149	6695	100.07	-95.23	4.84	5	Pass
181	6855	100.11	-95.23	4.88	5	Pass
185	6875	100.10	-95.23	4.87	5	Pass
209	6995	100.09	-95.23	4.86	5	Pass
233	7115	91.11	-95.23	-4.12	5	Pass

802.11ax (HE40) CDD

Chan.	Chan. Freq. (MHz)	Field Strength (dBuV/m)	Correction Factor (dB)	EIRP PSD (dBm/MHz)	EIRP PSD Limit (dBm/MHz)	Test Result
3	5965	100.09	-95.23	4.86	5	Pass
43	6165	100.21	-95.23	4.98	5	Pass
91	6405	100.01	-95.23	4.78	5	Pass
99	6445	100.11	-95.23	4.88	5	Pass
107	6485	100.08	-95.23	4.85	5	Pass
115	6525	100.12	-95.23	4.89	5	Pass
123	6565	100.11	-95.23	4.88	5	Pass
155	6725	100.13	-95.23	4.90	5	Pass
179	6845	100.09	-95.23	4.86	5	Pass
187	6885	100.14	-95.23	4.91	5	Pass
211	7005	100.11	-95.23	4.88	5	Pass
227	7085	100.12	-95.23	4.89	5	Pass

802.11ax (HE80) CDD

Chan.	Chan. Freq. (MHz)	Field Strength (dBuV/m)	Correction Factor (dB)	EIRP PSD (dBm/MHz)	EIRP PSD Limit (dBm/MHz)	Test Result
7	5985	100.19	-95.23	4.96	5	Pass
39	6145	100.08	-95.23	4.85	5	Pass
87	6385	100.21	-95.23	4.98	5	Pass
103	6465	100.09	-95.23	4.86	5	Pass
119	6545	100.14	-95.23	4.91	5	Pass
151	6705	100.11	-95.23	4.88	5	Pass
183	6865	100.07	-95.23	4.84	5	Pass
199	6945	100.13	-95.23	4.90	5	Pass
215	7025	100.12	-95.23	4.89	5	Pass

802.11ax (HE160) CDD

Chan.	Chan. Freq. (MHz)	Field Strength (dBuV/m)	Correction Factor (dB)	EIRP PSD (dBm/MHz)	EIRP PSD Limit (dBm/MHz)	Test Result
15	6025	100.04	-95.23	4.81	5	Pass
47	6185	100.10	-95.23	4.87	5	Pass
79	6345	100.08	-95.23	4.85	5	Pass
111	6505	100.07	-95.23	4.84	5	Pass
143	6665	100.07	-95.23	4.84	5	Pass
175	6825	100.09	-95.23	4.86	5	Pass
207	6985	100.09	-95.23	4.86	5	Pass

802.11ax (HE20) Beamforming

Chan.	Chan. Freq. (MHz)	Field Strength (dBuV/m)	Correction Factor (dB)	EIRP PSD (dBm/MHz)	EIRP PSD Limit (dBm/MHz)	Test Result
1	5955	97.06	-95.23	1.83	5	Pass
45	6175	98.68	-95.23	3.45	5	Pass
93	6415	99.44	-95.23	4.21	5	Pass
97	6435	97.96	-95.23	2.73	5	Pass
105	6475	98.96	-95.23	3.73	5	Pass
113	6515	99.33	-95.23	4.10	5	Pass
117	6535	99.38	-95.23	4.15	5	Pass
149	6695	97.97	-95.23	2.74	5	Pass
181	6855	99.02	-95.23	3.79	5	Pass
185	6875	98.57	-95.23	3.34	5	Pass
209	6995	98.36	-95.23	3.13	5	Pass
233	7115	92.66	-95.23	-2.57	5	Pass

802.11ax (HE40) Beamforming

Chan.	Chan. Freq. (MHz)	Field Strength (dBuV/m)	Correction Factor (dB)	EIRP PSD (dBm/MHz)	EIRP PSD Limit (dBm/MHz)	Test Result
3	5965	98.62	-95.23	3.39	5	Pass
43	6165	99.92	-95.23	4.69	5	Pass
91	6405	100.11	-95.23	4.88	5	Pass
99	6445	100.16	-95.23	4.93	5	Pass
107	6485	99.67	-95.23	4.44	5	Pass
115	6525	99.58	-95.23	4.35	5	Pass
123	6565	98.10	-95.23	2.87	5	Pass
155	6725	99.08	-95.23	3.85	5	Pass
179	6845	98.33	-95.23	3.10	5	Pass
187	6885	98.08	-95.23	2.85	5	Pass
211	7005	99.09	-95.23	3.86	5	Pass
227	7085	99.53	-95.23	4.30	5	Pass

802.11ax (HE80) Beamforming

Chan.	Chan. Freq. (MHz)	Field Strength (dBuV/m)	Correction Factor (dB)	EIRP PSD (dBm/MHz)	EIRP PSD Limit (dBm/MHz)	Test Result
7	5985	100.16	-95.23	4.93	5	Pass
39	6145	99.60	-95.23	4.37	5	Pass
87	6385	100.13	-95.23	4.90	5	Pass
103	6465	99.46	-95.23	4.23	5	Pass
119	6545	98.09	-95.23	2.86	5	Pass
151	6705	99.54	-95.23	4.31	5	Pass
183	6865	100.18	-95.23	4.95	5	Pass
199	6945	99.74	-95.23	4.51	5	Pass
215	7025	99.80	-95.23	4.57	5	Pass



802.11ax (HE160) Beamforming

Chan.	Chan. Freq. (MHz)	Field Strength (dBuV/m)	Correction Factor (dB)	EIRP PSD (dBm/MHz)	EIRP PSD Limit (dBm/MHz)	Test Result
15	6025	99.95	-95.23	4.72	5	Pass
47	6185	98.47	-95.23	3.24	5	Pass
79	6345	99.13	-95.23	3.90	5	Pass
111	6505	98.46	-95.23	3.22	5	Pass
143	6665	100.22	-95.23	4.99	5	Pass
175	6825	98.16	-95.23	2.93	5	Pass
207	6985	99.30	-95.23	4.07	5	Pass

Spectrum Plot of Maximum Value

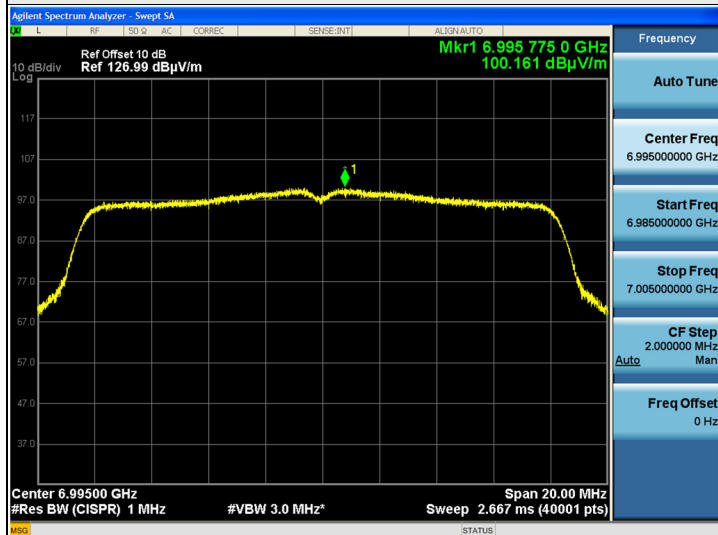

802.11a: CH 209

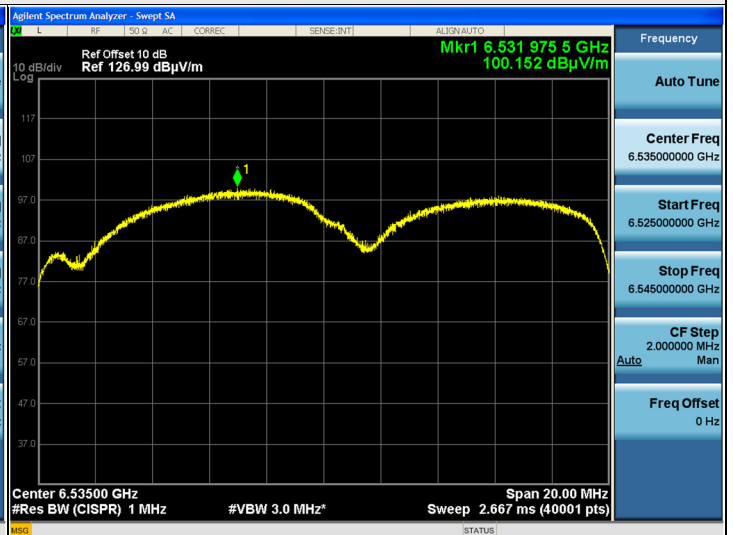

802.11ax (HE20) CDD: CH 117

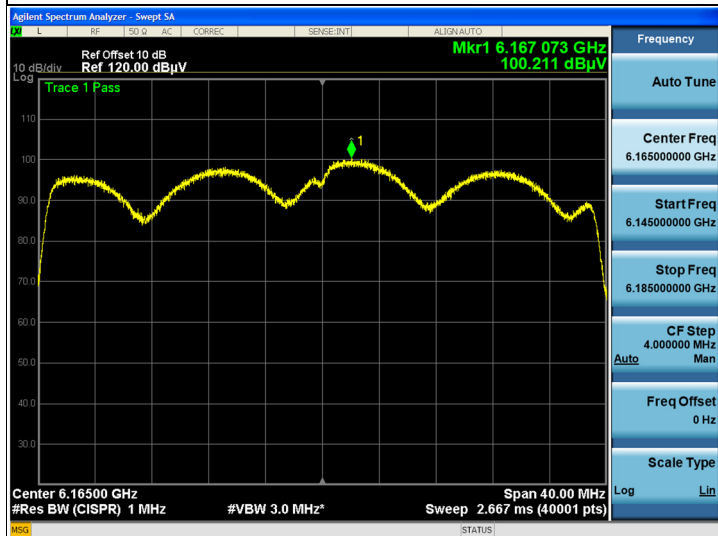

802.11ax (HE40) CDD: CH 43

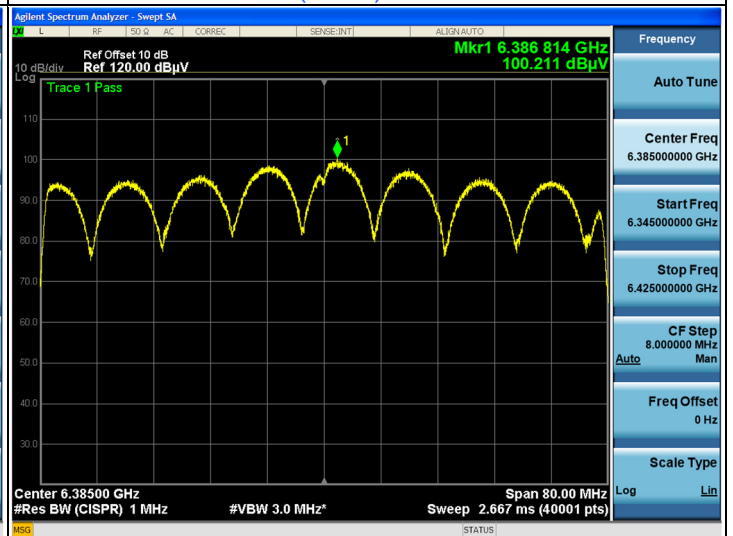

802.11ax (HE80) CDD: CH 87



Spectrum Plot of Maximum Value

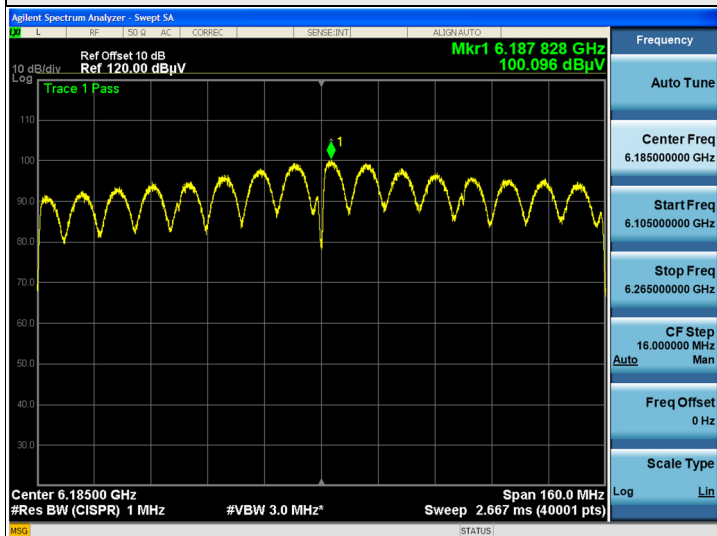

802.11ax (HE160) CDD: CH 47

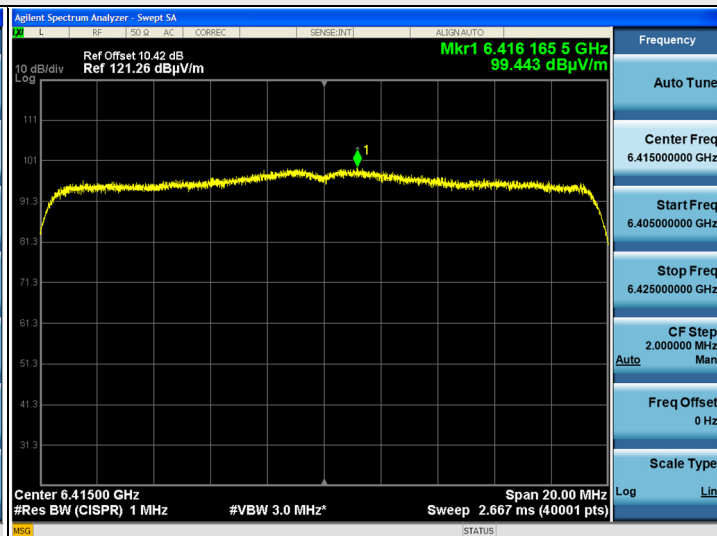

802.11ax (HE20) Beamforming: CH 93

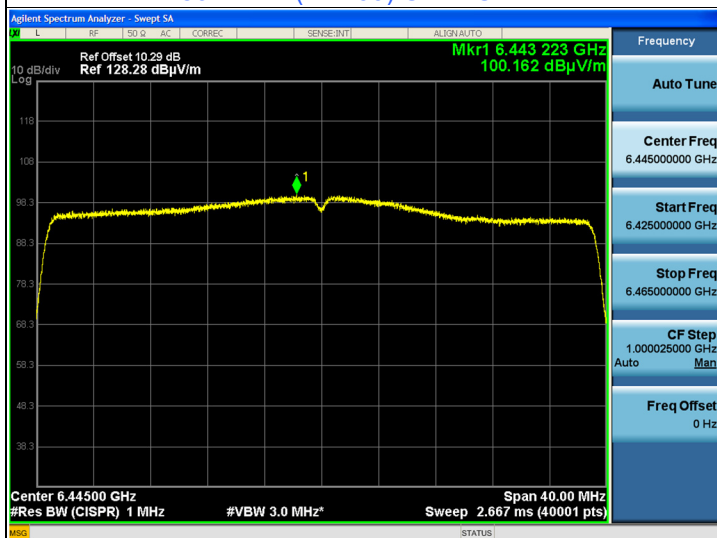

802.11ax (HE40) Beamforming: CH 99

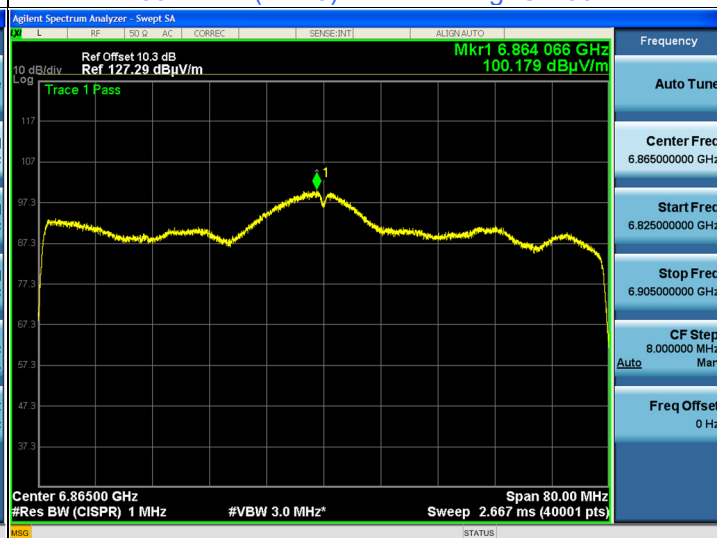

802.11ax (HE80) Beamforming: CH 183



802.11ax (HE160) Beamforming: CH 143

7.3 Emission Bandwidth

Input Power:	24 Vdc	Environmental Conditions:	25°C, 60% RH	Tested By:	Katina Lu
--------------	--------	---------------------------	--------------	------------	-----------

802.11a

Channel	Frequency (MHz)	26 dB Bandwidth (MHz)	Maximum Limit (MHz)	Test Result
1	5955	18.9	320	Pass
45	6175	18.95	320	Pass
93	6415	18.86	320	Pass
97	6435	19.82	320	Pass
105	6475	19.76	320	Pass
113	6515	19.6	320	Pass
117	6535	19.81	320	Pass
149	6695	19.76	320	Pass
181	6855	19.77	320	Pass
185	6875	19.66	320	Pass
209	6995	19.66	320	Pass
233	7115	19.62	320	Pass

802.11ax (HE20)

Channel	Frequency (MHz)	26dB Bandwidth (MHz)		Maximum Limit (MHz)	Test Result
		Chain 0	Chain 1		
1	5955	20.42	20.70	320	Pass
45	6175	20.75	20.50	320	Pass
93	6415	20.63	20.49	320	Pass
97	6435	21.04	20.88	320	Pass
105	6475	21.23	20.95	320	Pass
113	6515	21.25	21.45	320	Pass
117	6535	21.30	21.31	320	Pass
149	6695	21.34	20.84	320	Pass
181	6855	21.16	21.10	320	Pass
185	6875	21.34	21.21	320	Pass
209	6995	21.21	20.97	320	Pass
233	7115	21.15	20.97	320	Pass

802.11ax (HE40)

Channel	Frequency (MHz)	26dB Bandwidth (MHz)		Maximum Limit (MHz)	Test Result
		Chain 0	Chain 1		
3	5965	40.59	40.71	320	Pass
43	6165	40.64	40.88	320	Pass
91	6405	40.61	40.68	320	Pass
99	6445	40.54	40.90	320	Pass
107	6485	40.60	40.73	320	Pass
115	6525	40.86	40.62	320	Pass
123	6565	40.73	40.57	320	Pass
155	6725	40.61	40.85	320	Pass
179	6845	40.65	40.56	320	Pass
187	6885	40.90	40.76	320	Pass
211	7005	40.74	40.65	320	Pass
227	7085	40.82	41.02	320	Pass

802.11ax (HE80)

Channel	Frequency (MHz)	26dB Bandwidth (MHz)		Maximum Limit (MHz)	Test Result
		Chain 0	Chain 1		
7	5985	81.55	81.00	320	Pass
39	6145	81.27	81.15	320	Pass
87	6385	81.33	81.21	320	Pass
103	6465	82.55	82.80	320	Pass
119	6545	82.86	82.95	320	Pass
151	6705	82.18	82.42	320	Pass
183	6865	82.66	82.39	320	Pass
199	6945	82.56	82.47	320	Pass
215	7025	82.33	82.47	320	Pass

802.11ax (HE160)

Channel	Frequency (MHz)	26dB Bandwidth (MHz)		Maximum Limit (MHz)	Test Result
		Chain 0	Chain 1		
15	6025	166.33	165.10	320	Pass
47	6185	165.93	165.82	320	Pass
79	6345	166.89	165.63	320	Pass
111	6505	165.52	166.14	320	Pass
143	6665	165.73	165.99	320	Pass
175	6825	166.24	166.07	320	Pass
207	6985	166.18	165.73	320	Pass



Spectrum Plot of Maximum Value

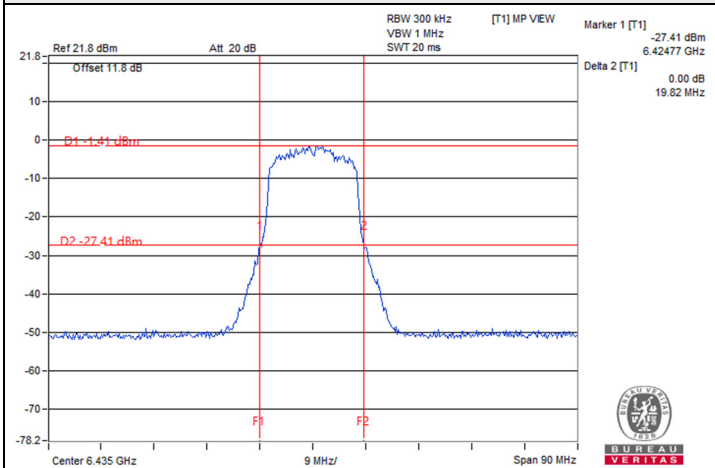

802.11a / Chain 1 : CH 97

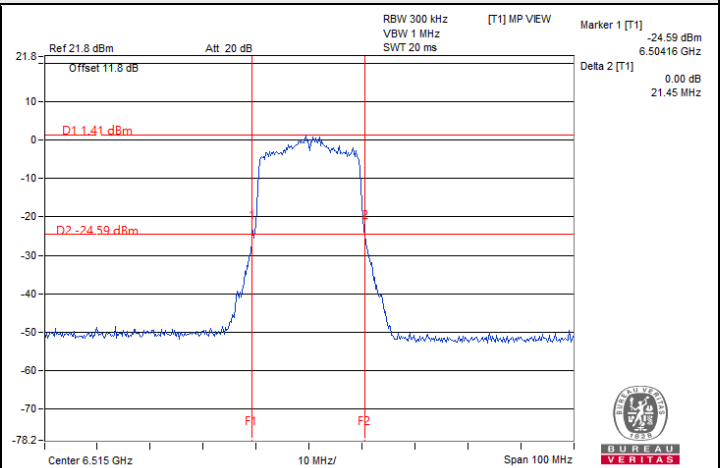

802.11ax (HE20) / Chain 1 : CH 113

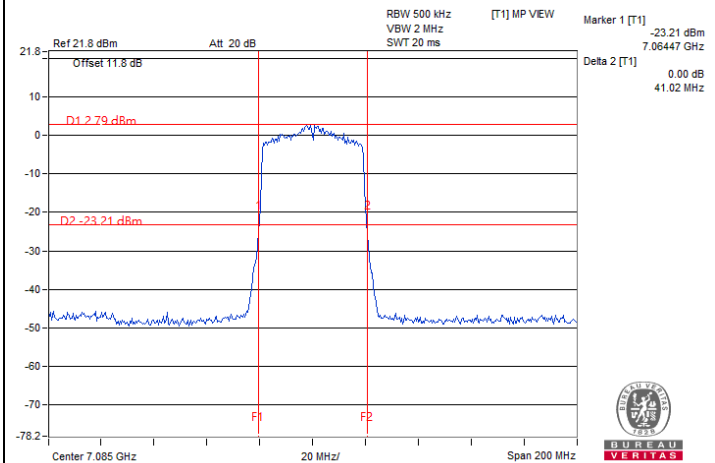

802.11ax (HE40) / Chain 1 : CH 227

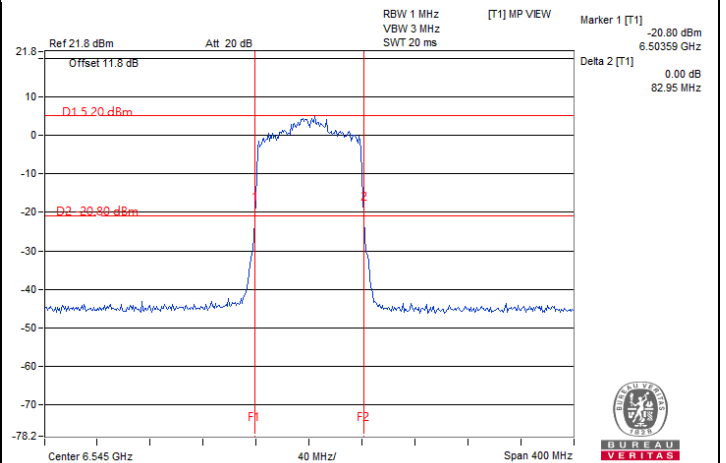

802.11ax (HE80) / Chain 1 : CH 119

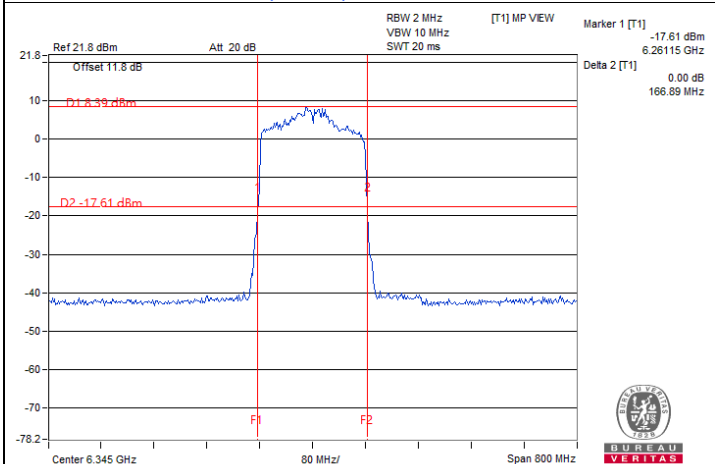

802.11ax (HE160) / Chain 0 : CH 79

7.4 In-Band Emission Mask

Input Power:	24 Vdc	Environmental Conditions:	25°C, 60% RH	Tested By:	Katina Lu
--------------	--------	---------------------------	--------------	------------	-----------

802.11a

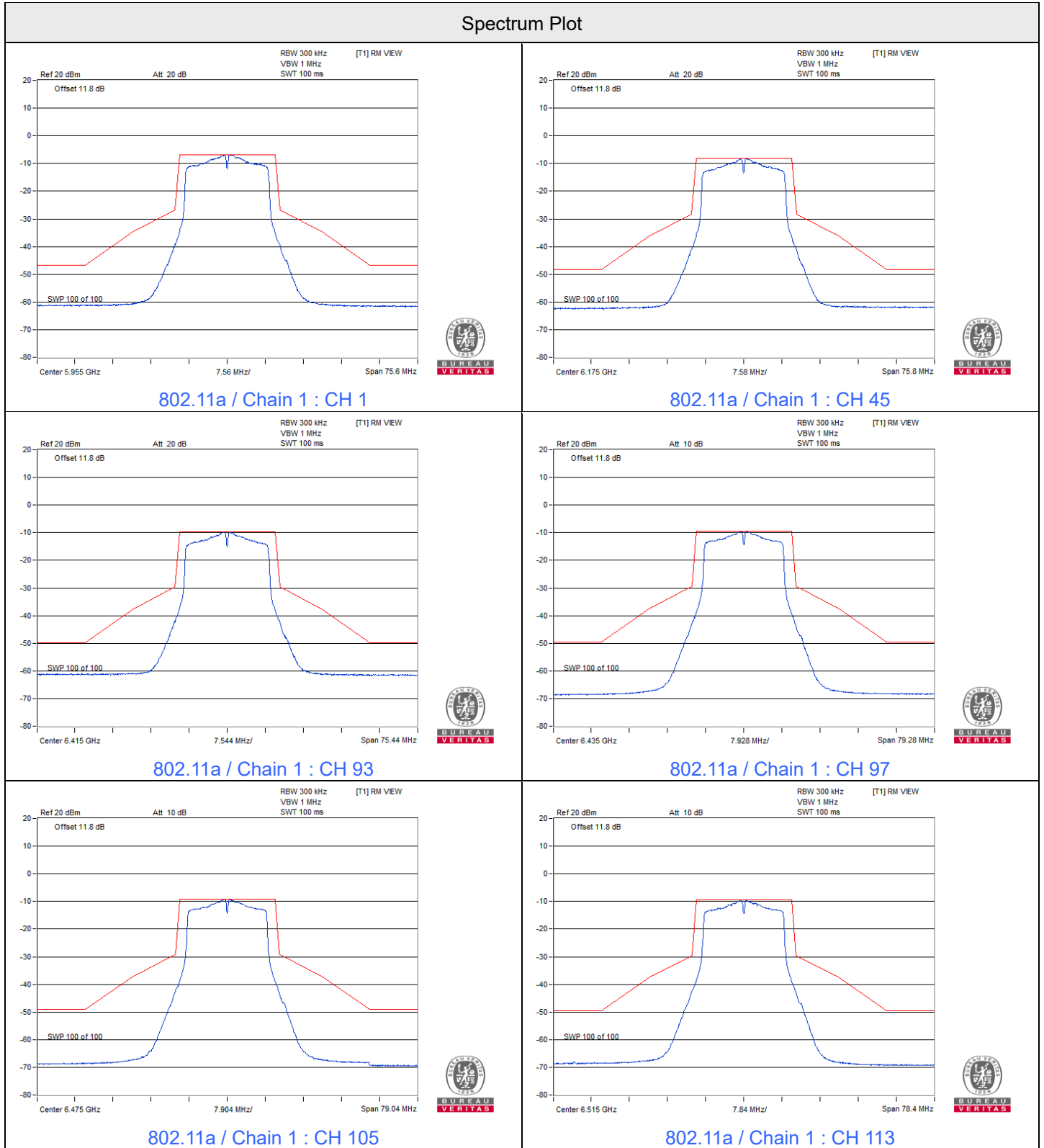

Spectrum Plot

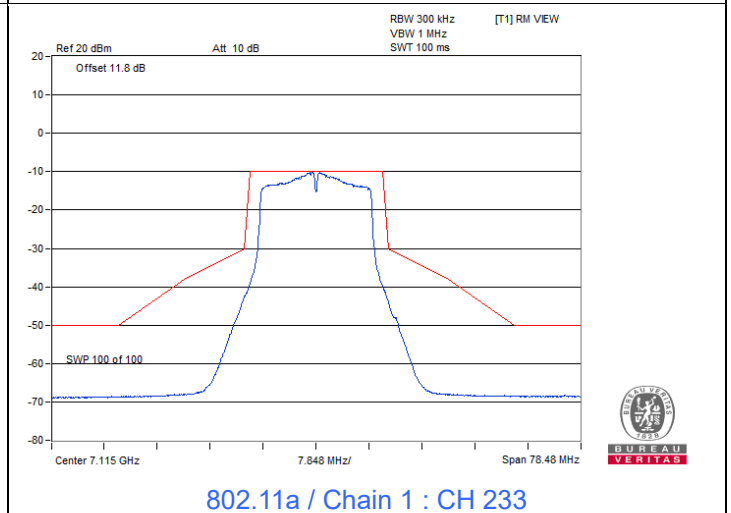
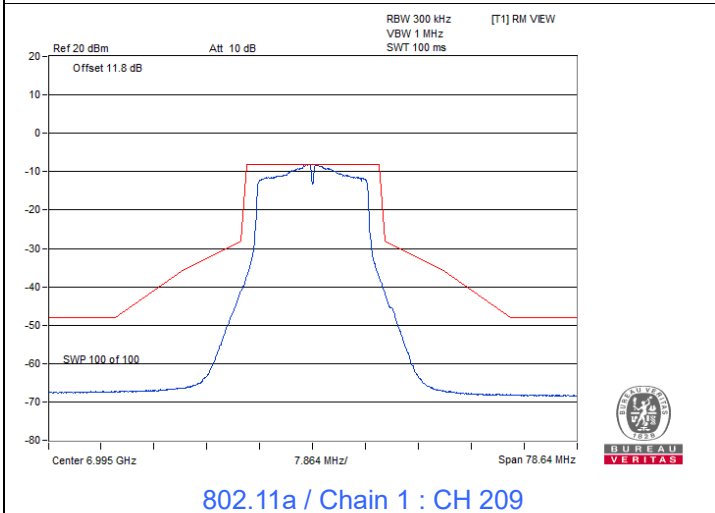
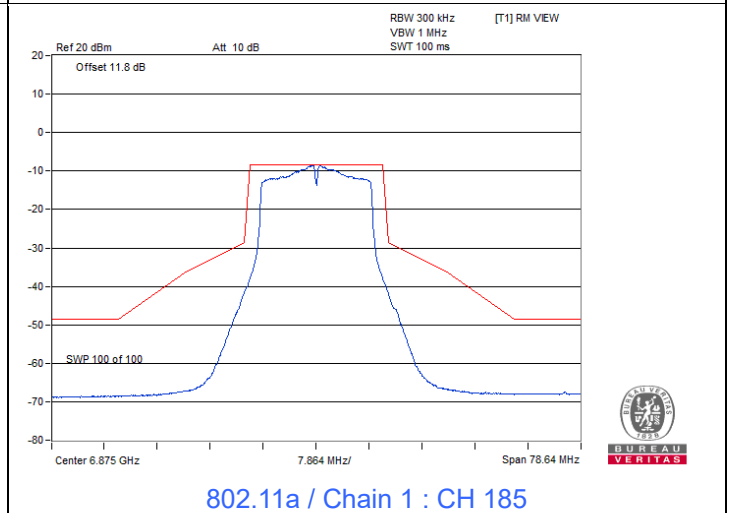
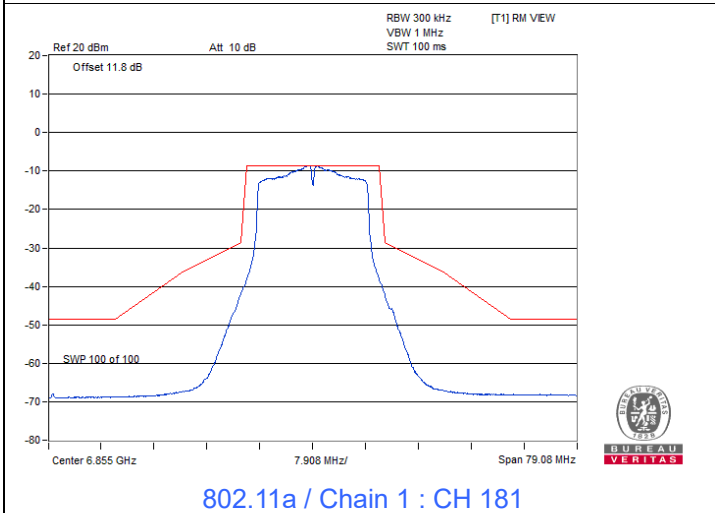
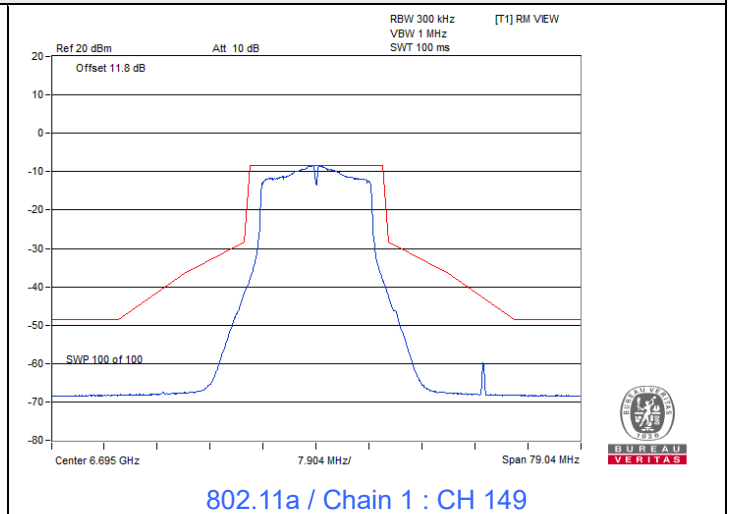
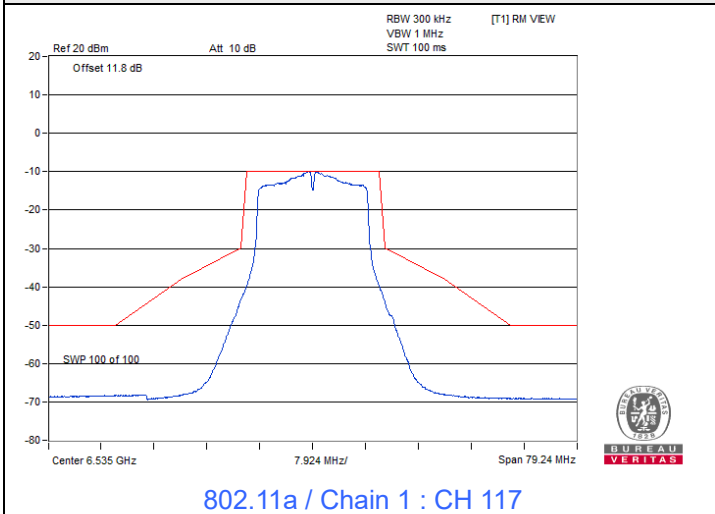

802.11ax (HE20) CDD

Spectrum Plot

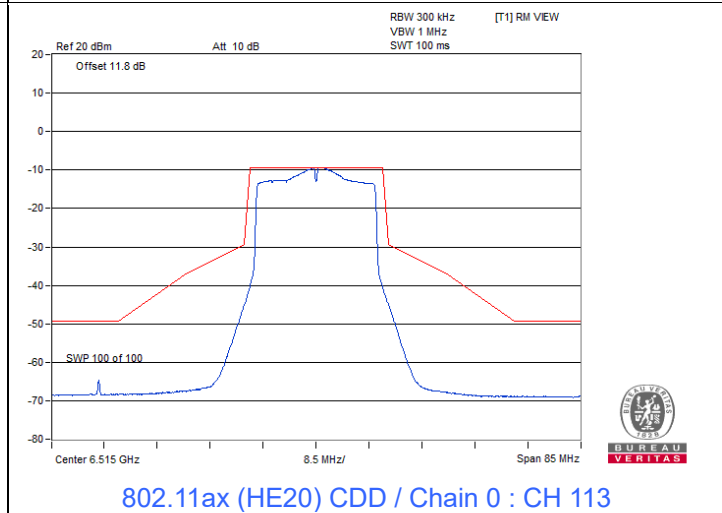
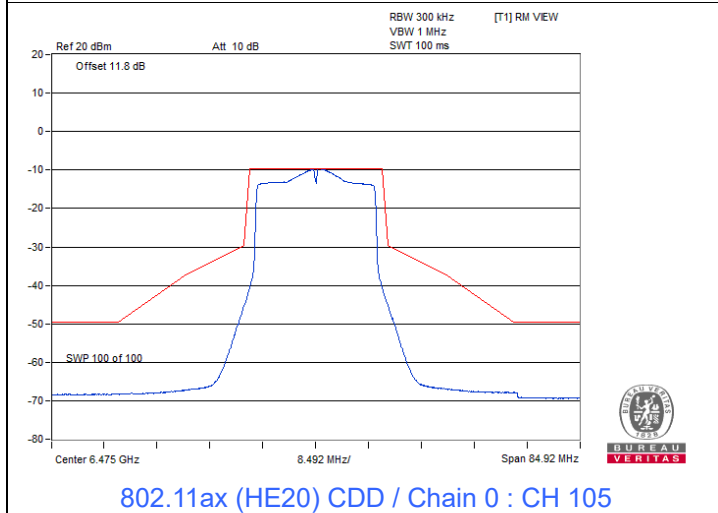
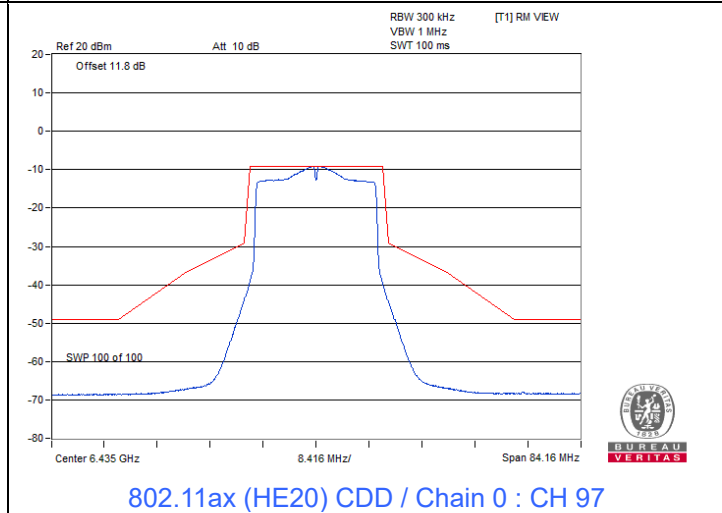
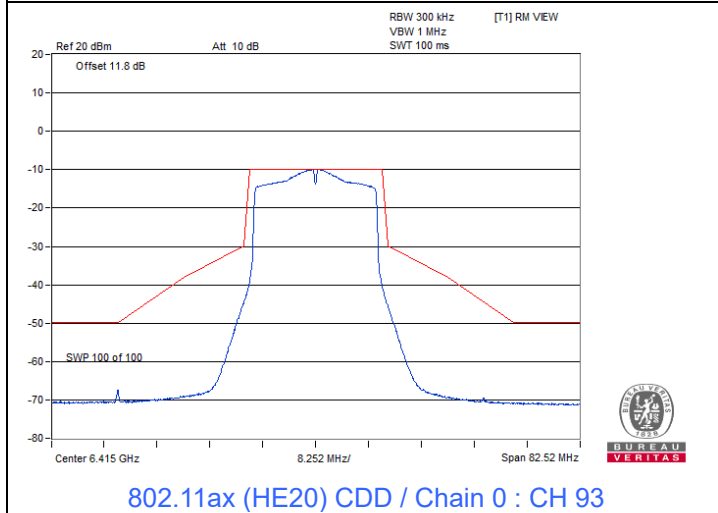
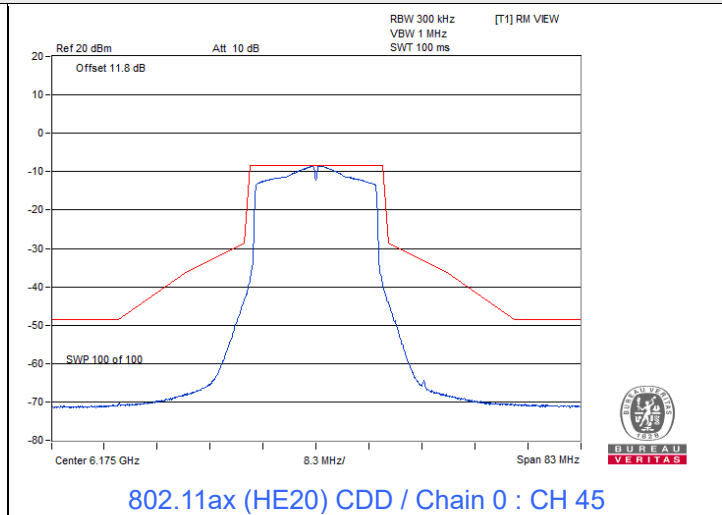
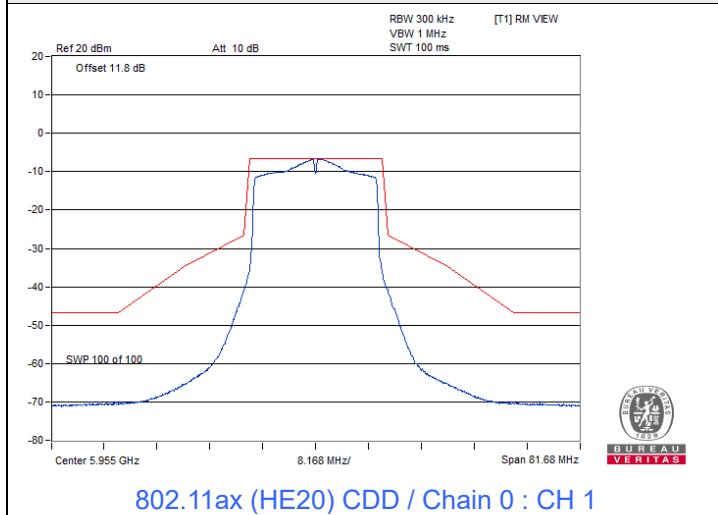

Spectrum Plot

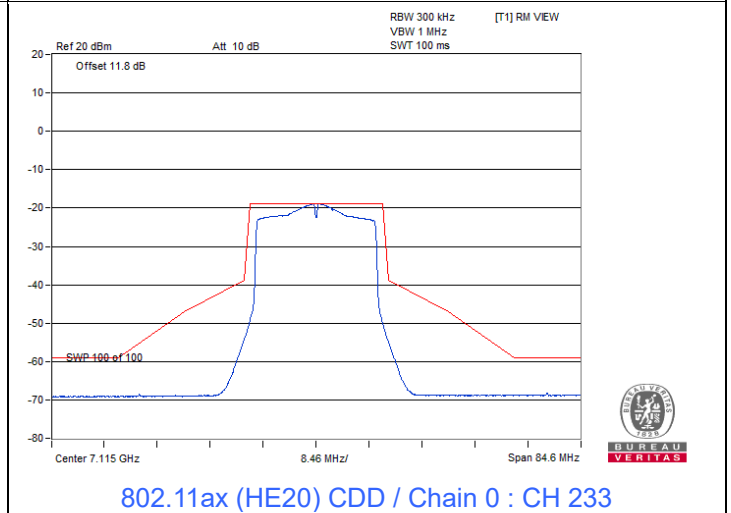
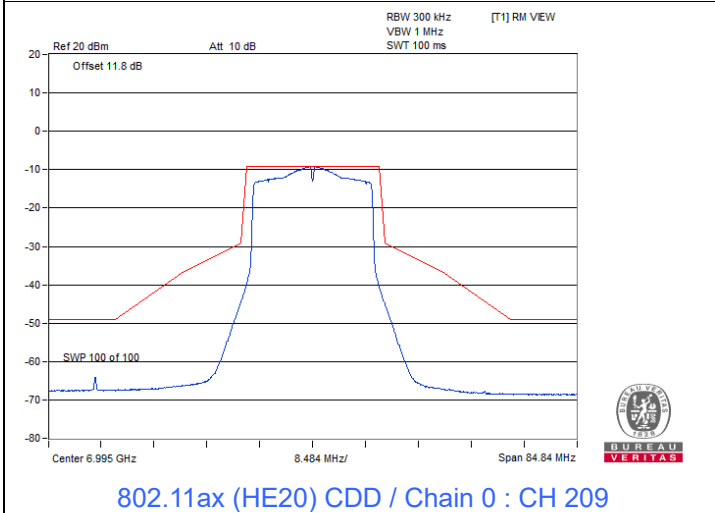
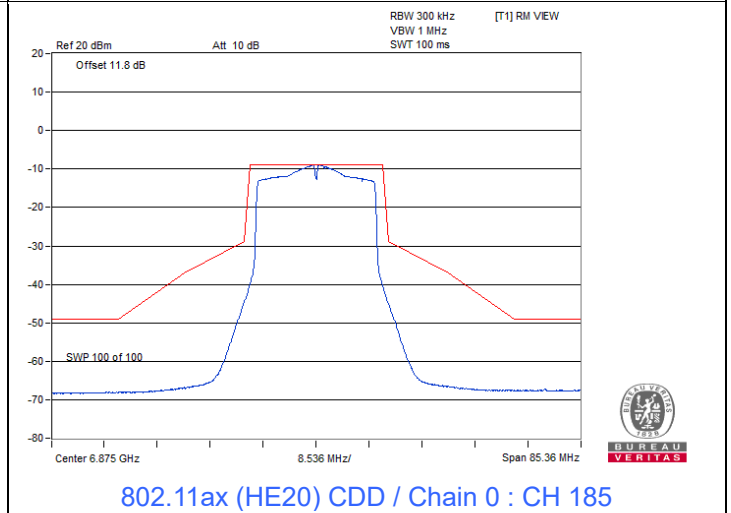
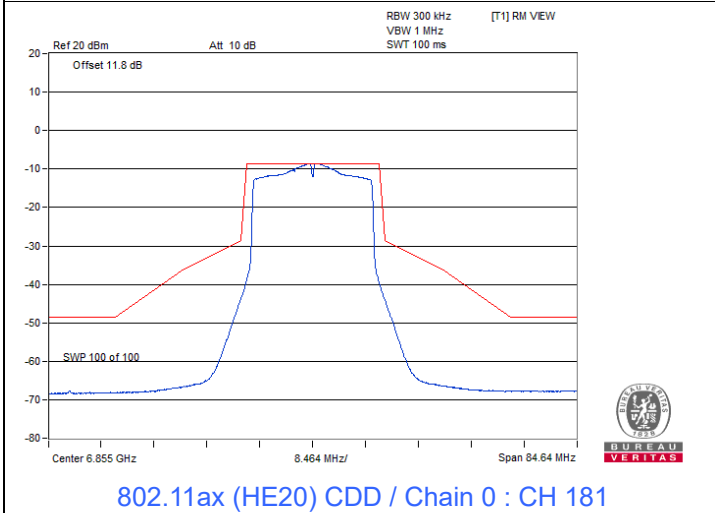
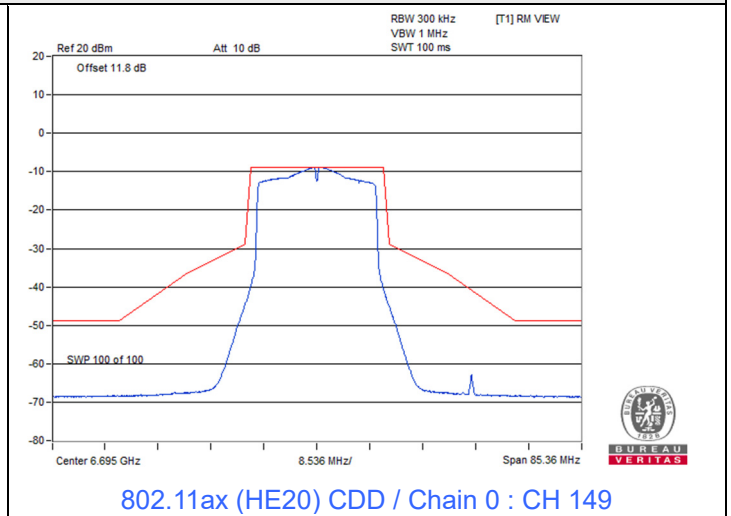
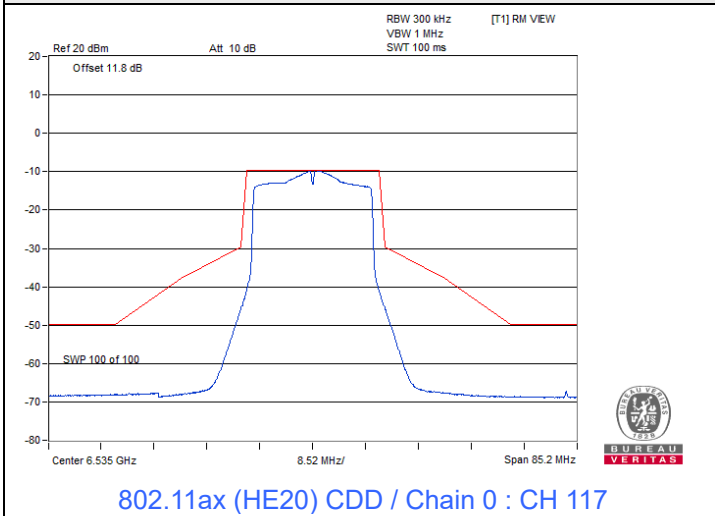

Spectrum Plot

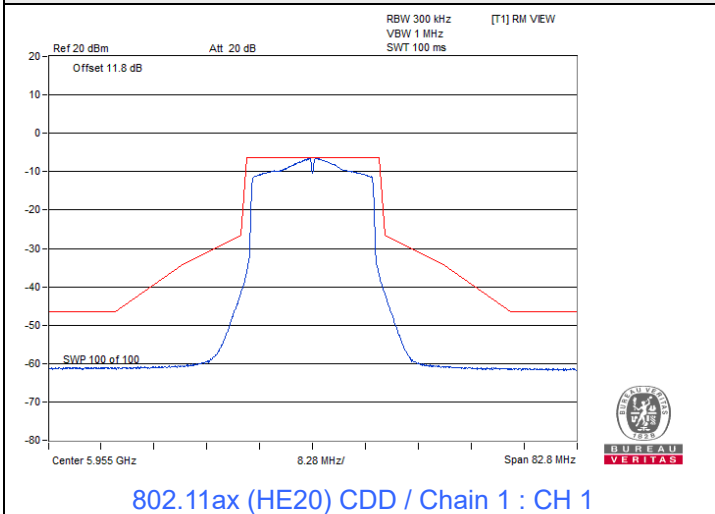

802.11ax (HE20) CDD / Chain 1 : CH 1

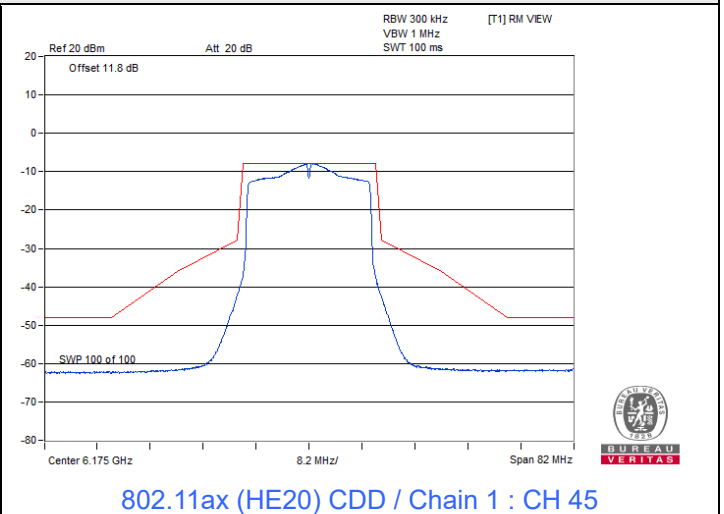

802.11ax (HE20) CDD / Chain 1 : CH 45

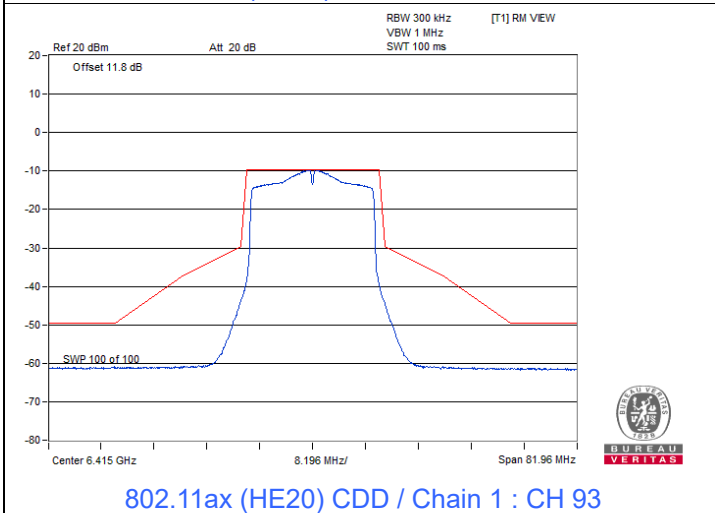

802.11ax (HE20) CDD / Chain 1 : CH 93

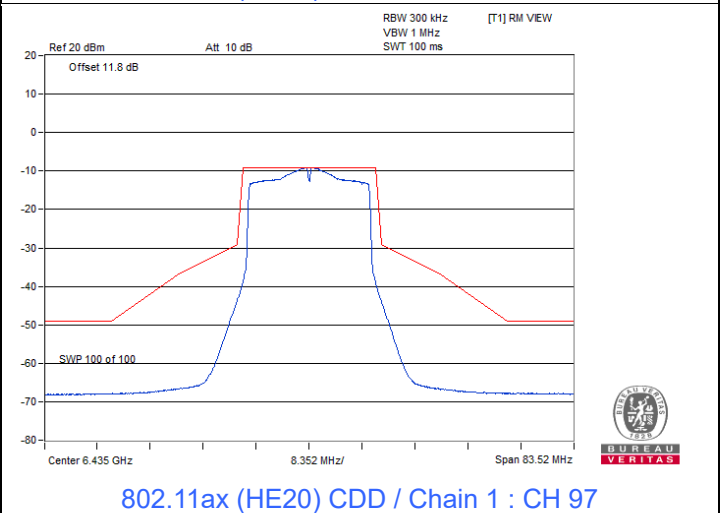

802.11ax (HE20) CDD / Chain 1 : CH 97

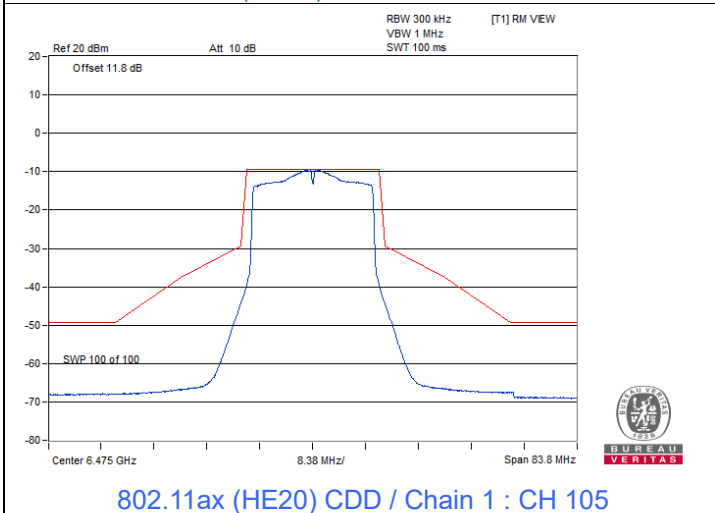

802.11ax (HE20) CDD / Chain 1 : CH 105

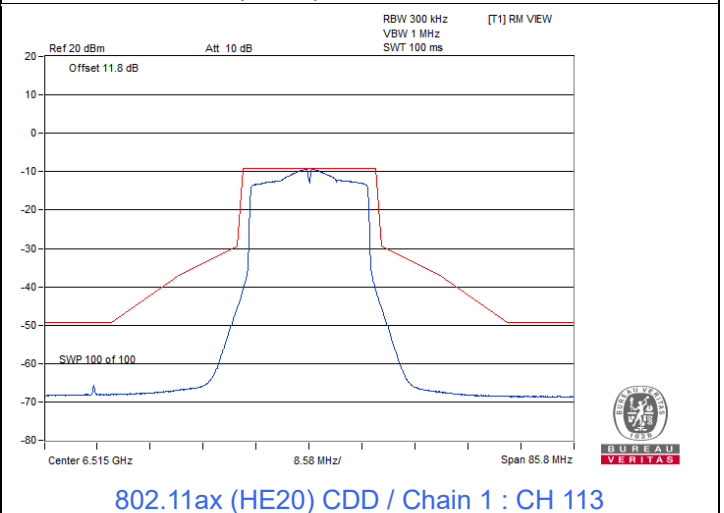

802.11ax (HE20) CDD / Chain 1 : CH 113

Spectrum Plot

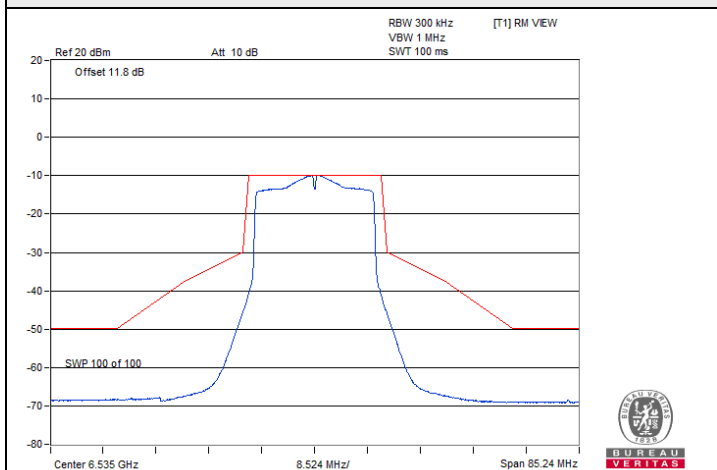

802.11ax (HE20) CDD / Chain 1 : CH 117

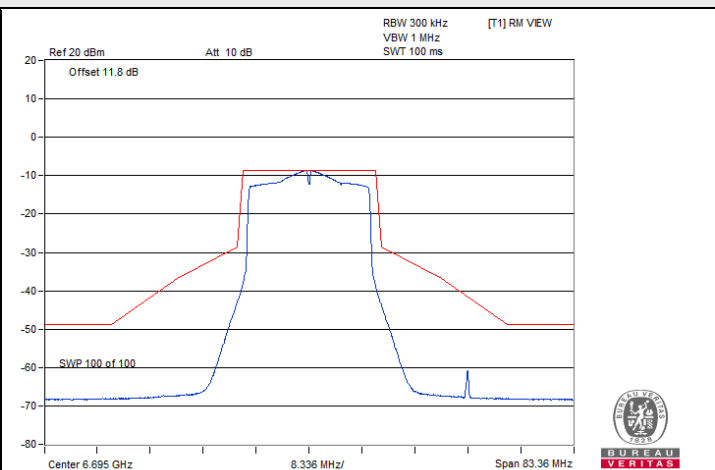

802.11ax (HE20) CDD / Chain 1 : CH 149

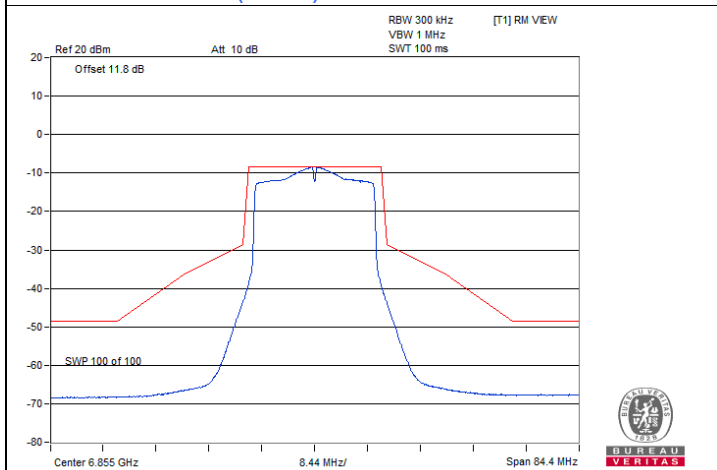

802.11ax (HE20) CDD / Chain 1 : CH 181

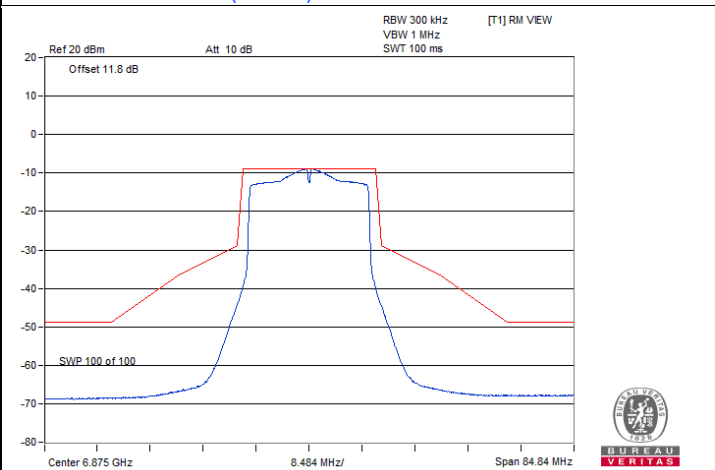

802.11ax (HE20) CDD / Chain 1 : CH 185

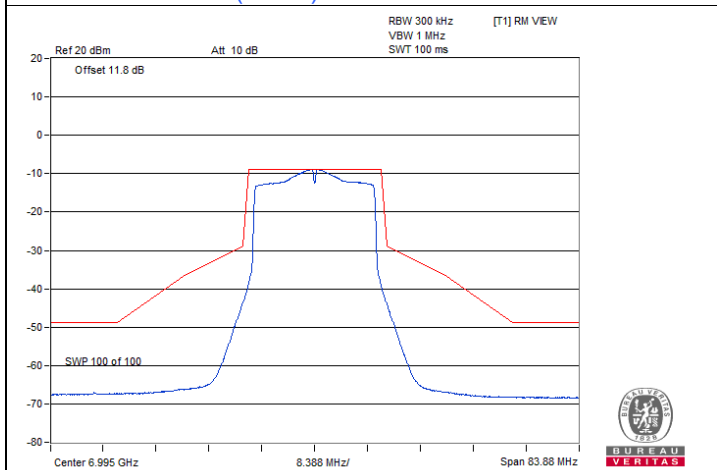

802.11ax (HE20) CDD / Chain 1 : CH 209

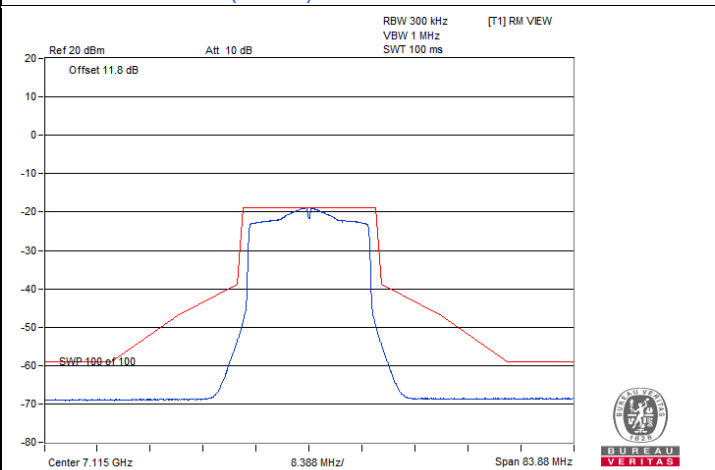

802.11ax (HE20) CDD / Chain 1 : CH 233

802.11ax (HE40) CDD

