

TEST REPORT

CERTIFICATE OF CONFORMITY

Standard: 47 CFR FCC Part 15, Subpart E (Section 15.407)
Report No.: RFBCKS-WTW-P23030625-1
FCC ID: RF41689A
Product: Industrial Wireless System
Brand: KEYENCE
Model No.: WS-A01
Received Date: 2023/3/22
Test Date: 2023/5/24 ~ 2023/6/29
Issued Date: 2023/10/31

Applicant: Keyence Corporation
Address: 1-3-14, Higashi-Nakajima, Higashi-Yodogawa-ku, Osaka, 533-8555, Japan
Issued By: Bureau Veritas Consumer Products Services (H.K.) Ltd., Taoyuan Branch
Hsin Chu Laboratory
Lab Address: E-2, No.1, Li Hsin 1st Road, Hsinchu Science Park, Hsinchu City 300, Taiwan
Test Location: E-2, No.1, Li Hsin 1st Road, Hsinchu Science Park, Hsinchu City 300, Taiwan
FCC Registration / 723255 / TW2022
Designation Number:

Approved by: _____



May Chen / Manager

, Date: _____

2023/10/31

This test report consists of 99 pages in total. It may be duplicated completely for legal use with the approval of the applicant. It should not be reproduced except in full, without the written approval of our laboratory. The test results in the report only apply to the tested sample. The test results in this report are traceable to the national or international standards.



Prepared by : Vito Lung / Specialist

This report is governed by, and incorporates by reference, the Conditions of Testing as posted at the date of issuance of this report at <http://www.bureauveritas.com/home/about-us/our-business/cps/about-us/terms-conditions/> and is intended for your exclusive use. Any copying or replication of this report to or for any other person or entity, or use of our name or trademark, is permitted only with our prior written permission. This report sets forth our findings solely with respect to the test samples identified herein. The results set forth in this report are not indicative or representative of the quality or characteristics of the lot from which a test sample was taken or any similar or identical product unless specifically and expressly noted. Our report includes all of the tests requested by you and the results thereof based upon the information that you provided to us. Measurement uncertainty is only provided upon request for accredited tests. Statements of conformity are based on simple acceptance criteria without taking measurement uncertainty into account, unless otherwise requested in writing. You have 60 days from date of issuance of this report to notify us of any material error or omission caused by our negligence or if you require measurement uncertainty; provided, however, that such notice shall be in writing and shall specifically address the issue you wish to raise. A failure to raise such issue within the prescribed time shall constitute your unqualified acceptance of the completeness of this report, the tests conducted and the correctness of the report contents.

Table of Contents

| | |
|---|-----------|
| Release Control Record | 4 |
| 1 Certificate | 5 |
| 2 Summary of Test Results | 6 |
| 2.1 Measurement Uncertainty | 6 |
| 2.2 Supplementary Information | 6 |
| 3 General Information | 7 |
| 3.1 General Description of EUT | 7 |
| 3.2 Antenna Description of EUT | 8 |
| 3.3 Channel List | 9 |
| 3.4 Test Mode Applicability and Tested Channel Detail | 10 |
| 3.5 Duty Cycle of Test Signal | 11 |
| 3.6 Test Program Used and Operation Descriptions | 13 |
| 3.7 Connection Diagram of EUT and Peripheral Devices | 13 |
| 3.8 Configuration of Peripheral Devices and Cable Connections | 14 |
| 4 Test Instruments | 15 |
| 4.1 RF Output Power | 15 |
| 4.2 Power Spectral Density | 15 |
| 4.3 6 dB Bandwidth | 15 |
| 4.4 Occupied Bandwidth | 15 |
| 4.5 Frequency Stability | 16 |
| 4.6 AC Power Conducted Emissions | 16 |
| 4.7 Unwanted Emissions below 1 GHz | 17 |
| 4.8 Unwanted Emissions above 1 GHz | 18 |
| 5 Limits of Test Items | 19 |
| 5.1 RF Output Power | 19 |
| 5.2 Power Spectral Density | 19 |
| 5.3 6 dB Bandwidth | 19 |
| 5.4 Occupied Bandwidth | 19 |
| 5.5 Frequency Stability | 19 |
| 5.6 AC Power Conducted Emissions | 20 |
| 5.7 Unwanted Emissions below 1 GHz | 20 |
| 5.8 Unwanted Emissions above 1 GHz | 21 |
| 6 Test Arrangements | 22 |
| 6.1 RF Output Power | 22 |
| 6.1.1 Test Setup | 22 |
| 6.1.2 Test Procedure | 22 |
| 6.2 Power Spectral Density | 23 |
| 6.2.1 Test Setup | 23 |
| 6.2.2 Test Procedure | 23 |
| 6.3 6 dB Bandwidth | 24 |
| 6.3.1 Test Setup | 24 |
| 6.3.2 Test Procedure | 24 |
| 6.4 Occupied Bandwidth | 24 |
| 6.4.1 Test Setup | 24 |
| 6.4.2 Test Procedure | 24 |
| 6.5 Frequency Stability | 25 |
| 6.5.1 Test Setup | 25 |
| 6.5.2 Test Procedure | 25 |
| 6.6 AC Power Conducted Emissions | 26 |
| 6.6.1 Test Setup | 26 |
| 6.6.2 Test Procedure | 26 |
| 6.7 Unwanted Emissions below 1 GHz | 27 |
| 6.7.1 Test Setup | 27 |
| 6.7.2 Test Procedure | 28 |



| | | |
|----------|--|-----------|
| 6.8 | Unwanted Emissions above 1 GHz..... | 29 |
| 6.8.1 | Test Setup | 29 |
| 6.8.2 | Test Procedure..... | 29 |
| 7 | Test Results of Test Item | 30 |
| 7.1 | RF Output Power..... | 30 |
| 7.2 | Power Spectral Density | 35 |
| 7.3 | 6 dB Bandwidth | 40 |
| 7.4 | Occupied Bandwidth..... | 42 |
| 7.5 | Frequency Stability | 47 |
| 7.6 | AC Power Conducted Emissions | 48 |
| 7.7 | Unwanted Emissions below 1 GHz | 50 |
| 7.8 | Unwanted Emissions above 1 GHz..... | 52 |
| 8 | Pictures of Test Arrangements | 98 |
| 9 | Information of the Testing Laboratories | 99 |



Release Control Record

| Issue No. | Description | Date Issued |
|------------------------|-------------------|-------------|
| RFBCKS-WTW-P23030625-1 | Original release. | 2023/10/31 |

1 Certificate

Product: Industrial Wireless System

Brand: KEYENCE

Test Model: WS-A01

Sample Status: Engineering sample

Applicant: Keyence Corporation

Test Date: 2023/5/24 ~ 2023/6/29

Standard: 47 CFR FCC Part 15, Subpart E (Section 15.407)

Measurement ANSI C63.10-2013

procedure: KDB 789033 D02 General UNII Test Procedure New Rules v02r01

KDB 662911 D01 Multiple Transmitter Output v02r01

The above equipment has been tested by **Bureau Veritas Consumer Products Services (H.K.) Ltd., Taoyuan Branch**, and found compliance with the requirement of the above standards. The test record, data evaluation & Equipment Under Test (EUT) configurations represented herein are true and accurate accounts of the measurements of the sample's RF characteristics under the conditions specified in this report.

2 Summary of Test Results

| 47 CFR FCC Part 15, Subpart E (Section 15.407) | | | |
|--|--------------------------------|--------|--|
| Clause | Test Item | Result | Remark |
| 15.407(a)(1) 15.407(a)(3) | RF Output Power | Pass | Meet the requirement of limit. |
| 15.407(a)(1) 15.407(a)(3) | Power Spectral Density | Pass | Meet the requirement of limit. |
| 15.407(e) | 6 dB Bandwidth | Pass | Meet the requirement of limit. (U-NII-3 Band only) |
| --- | Occupied Bandwidth | - | Reference only. |
| 15.407(g) | Frequency Stability | Pass | Meet the requirement of limit. |
| 15.407(b)(9) | AC Power Conducted Emissions | Pass | Minimum passing margin is -9.18 dB at 0.44688 MHz |
| 15.407(b)(9) | Unwanted Emissions below 1 GHz | Pass | Minimum passing margin is -10.4 dB at 875.06 MHz |
| 15.407(b) (1/10) 15.407(b) (4(i)/10) | Unwanted Emissions above 1 GHz | Pass | Minimum passing margin is -0.1 dB at 5150.00 MHz |
| 15.203 | Antenna Requirement | Pass | Antenna connector is ipex(MHF) not a standard connector. |

Note: Determining compliance based on the results of the compliance measurement, not taking into account measurement instrumentation uncertainty.

2.1 Measurement Uncertainty

Where relevant, the following measurement uncertainty levels have been estimated for tests performed on the EUT as specified in CISPR 16-4-2:

| Measurement | Specification | Expanded Uncertainty (k=2) (±) |
|--------------------------------|------------------|--------------------------------|
| AC Power Conducted Emissions | 150 kHz ~ 30 MHz | 1.9 dB |
| Unwanted Emissions below 1 GHz | 9 kHz ~ 30 MHz | 3.1 dB |
| | 30 MHz ~ 1 GHz | 5.1 dB |
| Unwanted Emissions above 1 GHz | 1 GHz ~ 18 GHz | 5.0 dB |
| | 18 GHz ~ 40 GHz | 5.3 dB |

The other instruments specified are routine verified to remain within the calibrated levels, no measurement uncertainty is required to be calculated.

2.2 Supplementary Information

There is not any deviation from the test standards for the test method, and no modifications required for compliance.

3 General Information

3.1 General Description of EUT

| | |
|-----------------------|--|
| Product | Industrial Wireless System |
| Brand | KEYENCE |
| Test Model | WS-A01 |
| Status of EUT | Engineering sample |
| Power Supply Rating | 24 Vdc |
| Modulation Type | 64QAM, 16QAM, QPSK, BPSK for OFDM 256QAM for OFDM in 11ac mode 1024QAM for OFDMA in 11ax mode |
| Modulation Technology | OFDM, OFDMA |
| Transfer Rate | 802.11a: up to 54 Mbps 802.11n: up to 300 Mbps 802.11ac: up to 866.7 Mbps 802.11ax: up to 1201.0 Mbps |
| Operating Frequency | 5.18 GHz ~ 5.24 GHz 5.745 GHz ~ 5.825 GHz |
| Number of Channel | 802.11a, 802.11n (HT20), 802.11ac (VHT20), 802.11ax (HE20): 9 802.11n (HT40), 802.11ac (VHT40), 802.11ax (HE40): 4 802.11ac (VHT80), 802.11ax (HE80): 2 |
| Output Power | CDD Mode: 5.18 GHz ~ 5.24 GHz: 535.839 mW (27.29 dBm) 5.745 GHz ~ 5.825 GHz: 627.779 mW (27.98 dBm) Beamforming Mode: 5.18 GHz ~ 5.24 GHz: 508.216 mW (27.06 dBm) 5.745 GHz ~ 5.825 GHz: 620.104 mW (27.92 dBm) |
| EUT Category | Indoor Access Point |

Note:

1. There are WLAN (2.4 GHz) and WLAN (5 GHz) and WLAN (6 GHz) technology used for the EUT.
2. Simultaneously transmission condition.

| Condition | Technology | | |
|-----------|----------------|--------------|--------------|
| 1 | WLAN (2.4 GHz) | WLAN (5 GHz) | WLAN (6 GHz) |

Note: The emission of the simultaneous operation has been evaluated and no non-compliance was found.

3. The above EUT information is declared by manufacturer and for more detailed features description, please refers to the manufacturer's specifications or user's manual.

3.2 Antenna Description of EUT

1. The antenna information is listed as below.

| Antenna No. | RF Chain No. | Antenna Net Gain (dBi) | Frequency Range (GHz) | Antenna Type | Connector Type |
|-------------|--------------|------------------------|-----------------------|--------------|----------------|
| DB1 | Chain 0 | 3.79 | 2.4~2.4835 | PIFA | ipex(MHF) |
| | | 5.07 | 5.15~5.25 | | |
| | | 5.07 | 5.25~5.35 | | |
| | | 5.31 | 5.47~5.725 | | |
| | | 5.46 | 5.725~5.85 | | |
| DB2 | Chain 1 | 2.84 | 2.4~2.4835 | PIFA | ipex(MHF) |
| | | 4.77 | 5.15~5.25 | | |
| | | 4.77 | 5.25~5.35 | | |
| | | 5.64 | 5.47~5.725 | | |
| | | 5.64 | 5.725~5.85 | | |
| SB1 | Chain 0 | 3.63 | 5.955-6.415 | PIFA | ipex(MHF) |
| | | 3.5 | 6.435-6.525 | | |
| | | 3.5 | 6.535-6.865 | | |
| | | 4.2 | 6.875-7.115 | | |
| SB2 | Chain 1 | 4.35 | 5.955-6.415 | PIFA | ipex(MHF) |
| | | 3.2 | 6.435-6.525 | | |
| | | 3.2 | 6.535-6.865 | | |
| | | 4.4 | 6.875-7.115 | | |

* Detail antenna specification please refer to antenna datasheet and/or antenna measurement report.

2. The EUT incorporates a MIMO function:

| 5 GHz Band | | |
|------------------|-----------------------|-----|
| Modulation Mode | TX & RX Configuration | |
| 802.11a | 2TX | 2RX |
| 802.11n (HT20) | 2TX | 2RX |
| 802.11n (HT40) | 2TX | 2RX |
| 802.11ac (VHT20) | 2TX | 2RX |
| 802.11ac (VHT40) | 2TX | 2RX |
| 802.11ac (VHT80) | 2TX | 2RX |
| 802.11ax (HE20) | 2TX | 2RX |
| 802.11ax (HE40) | 2TX | 2RX |
| 802.11ax (HE80) | 2TX | 2RX |

Note:

- All of modulation mode support beamforming function except 802.11a modulation mode.
- The EUT support Beamforming and CDD mode, therefore both mode were investigated and the worst case scenario was identified. The worst case data were presented in test report.
- The modulation and bandwidth are similar for 802.11n mode for 20 MHz (40 MHz), 802.11ac mode for 20 MHz (40 MHz, 80 MHz), 802.11ax mode for 20 MHz (40 MHz, 80 MHz) therefore the manufacturer will control the power for 802.11n/ac mode is same as the 802.11ax mode or more lower than it and investigated worst case to representative mode in test report.

3.3 Channel List

FOR 5180 ~ 5240 MHz

4 channels are provided for 802.11a, 802.11n (HT20), 802.11ac (VHT20), 802.11ax (HE20):

| Channel | Frequency | Channel | Frequency |
|---------|-----------|---------|-----------|
| 36 | 5180 MHz | 44 | 5220 MHz |
| 40 | 5200 MHz | 48 | 5240 MHz |

2 channels are provided for 802.11n (HT40), 802.11ac (VHT40), 802.11ax (HE40):

| Channel | Frequency | Channel | Frequency |
|---------|-----------|---------|-----------|
| 38 | 5190 MHz | 46 | 5230 MHz |

1 channel is provided for 802.11ac (VHT80), 802.11ax (HE80):

| Channel | Frequency |
|---------|-----------|
| 42 | 5210 MHz |

FOR 5745 ~ 5825 MHz:

5 channels are provided for 802.11a, 802.11n (HT20), 802.11ac (VHT20), 802.11ax (HE20):

| Channel | Frequency | Channel | Frequency |
|---------|-----------|---------|-----------|
| 149 | 5745 MHz | 161 | 5805 MHz |
| 153 | 5765 MHz | 165 | 5825 MHz |
| 157 | 5785 MHz | | |

2 channels are provided for 802.11n (HT40), 802.11ac (VHT40), 802.11ax (HE40):

| Channel | Frequency | Channel | Frequency |
|---------|-----------|---------|-----------|
| 151 | 5755 MHz | 159 | 5795 MHz |

1 channel is provided for 802.11ac (VHT80), 802.11ax (HE80):

| Channel | Frequency |
|---------|-----------|
| 155 | 5775 MHz |

3.4 Test Mode Applicability and Tested Channel Detail

| | |
|-----------|--|
| Pre-Scan: | 1. Pre-Scan has been conducted to determine the worst-case mode from all possible combinations between available modulations, data rates and antenna ports (if EUT with antenna diversity architecture). |
|-----------|--|

Following channel(s) was (were) selected for the final test as listed below:

| Test Item | Mode | Signal Mode | Tested Channel | Modulation | Data Rate Parameter |
|---|------------------|-------------------|---------------------------|-------------|---------------------|
| RF Output Power | 802.11a | CDD | 36, 40, 48, 149, 157, 165 | BPSK | 6Mb/s |
| | 802.11ac (VHT20) | CDD & Beamforming | 36, 40, 48, 149, 157, 165 | BPSK | MCS0 |
| | 802.11ac (VHT40) | CDD & Beamforming | 38, 46, 151, 159 | BPSK | MCS0 |
| | 802.11ac (VHT80) | CDD & Beamforming | 42, 155 | BPSK | MCS0 |
| | 802.11ax (HE20) | CDD & Beamforming | 36, 40, 48, 149, 157, 165 | BPSK | MCS0 |
| | 802.11ax (HE40) | CDD & Beamforming | 38, 46, 151, 159 | BPSK | MCS0 |
| | 802.11ax (HE80) | CDD & Beamforming | 42, 155 | BPSK | MCS0 |
| 6 dB Bandwidth | 802.11a | CDD | 149, 157, 165 | BPSK | 6Mb/s |
| | 802.11ax (HE20) | CDD | 149, 157, 165 | BPSK | MCS0 |
| | 802.11ax (HE40) | CDD | 151, 159 | BPSK | MCS0 |
| | 802.11ax (HE80) | CDD | 155 | BPSK | MCS0 |
| Power Spectral Density / Occupied Bandwidth | 802.11a | CDD | 36, 40, 48, 149, 157, 165 | BPSK | 6Mb/s |
| | 802.11ax (HE20) | CDD | 36, 40, 48, 149, 157, 165 | BPSK | MCS0 |
| | 802.11ax (HE40) | CDD | 38, 46, 151, 159 | BPSK | MCS0 |
| | 802.11ax (HE80) | CDD | 42, 155 | BPSK | MCS0 |
| Frequency Stability | 802.11a | - | 36 | unmodulated | - |
| AC Power Conducted Emissions | 802.11a | CDD | 149 | BPSK | 6Mb/s |
| Unwanted Emissions below 1 GHz | 802.11a | CDD | 149 | BPSK | 6Mb/s |
| Unwanted Emissions above 1 GHz | 802.11a | CDD | 36, 40, 48, 149, 157, 165 | BPSK | 6Mb/s |
| | 802.11ax (HE20) | CDD | 36, 40, 48, 149, 157, 165 | BPSK | MCS0 |
| | 802.11ax (HE40) | CDD | 38, 46, 151, 159 | BPSK | MCS0 |
| | 802.11ax (HE80) | CDD | 42, 155 | BPSK | MCS0 |

Note:
 Partial RU (resource unit) mechanism is not supported.



3.5 Duty Cycle of Test Signal

802.11a: Duty cycle = 1.977 ms / 1.993 ms x 100% = 99.2%

802.11ax (HE20): Duty cycle = 5.446 ms / 5.461 ms x 100% = 99.7%

802.11ax (HE40): Duty cycle = 5.446 ms / 5.461 ms x 100% = 99.7%

802.11ax (HE80): Duty cycle = 5.446 ms / 5.46 ms x 100% = 99.7%

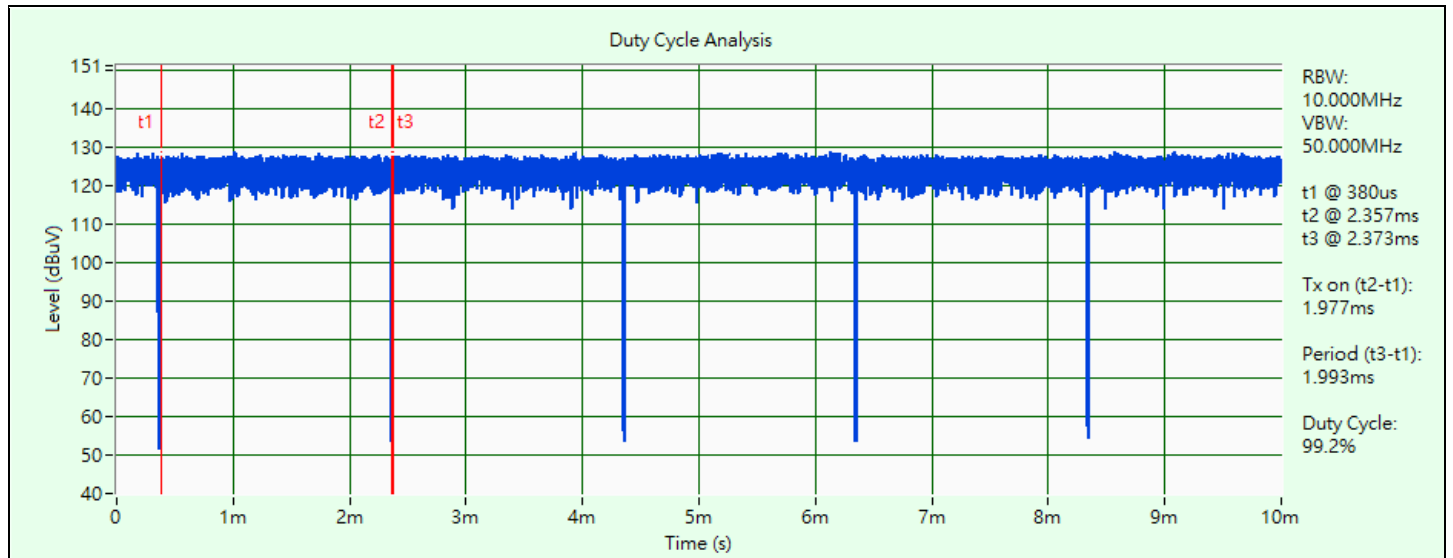

802.11a

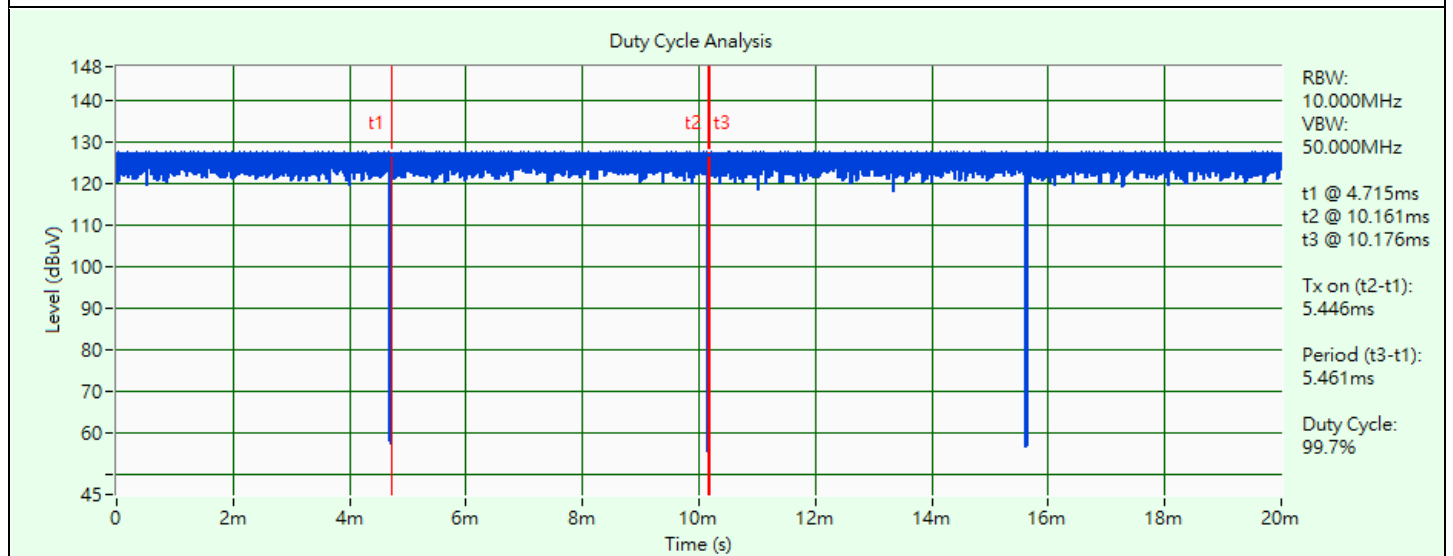

802.11ax (HE20)

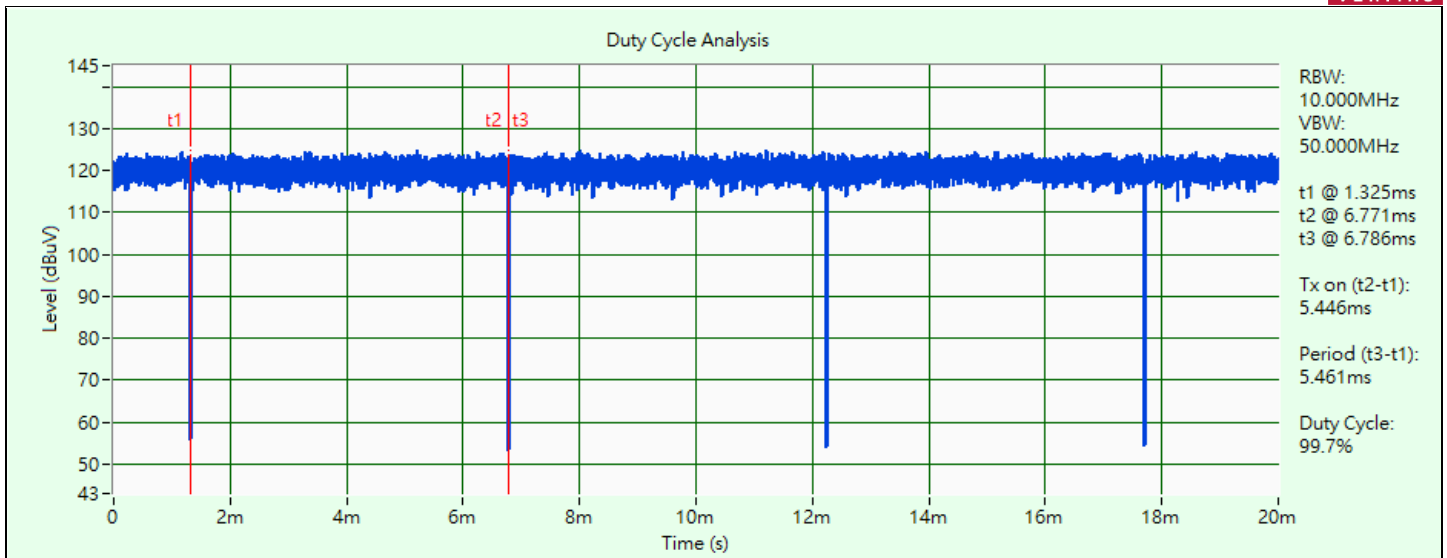

802.11ax (HE40)

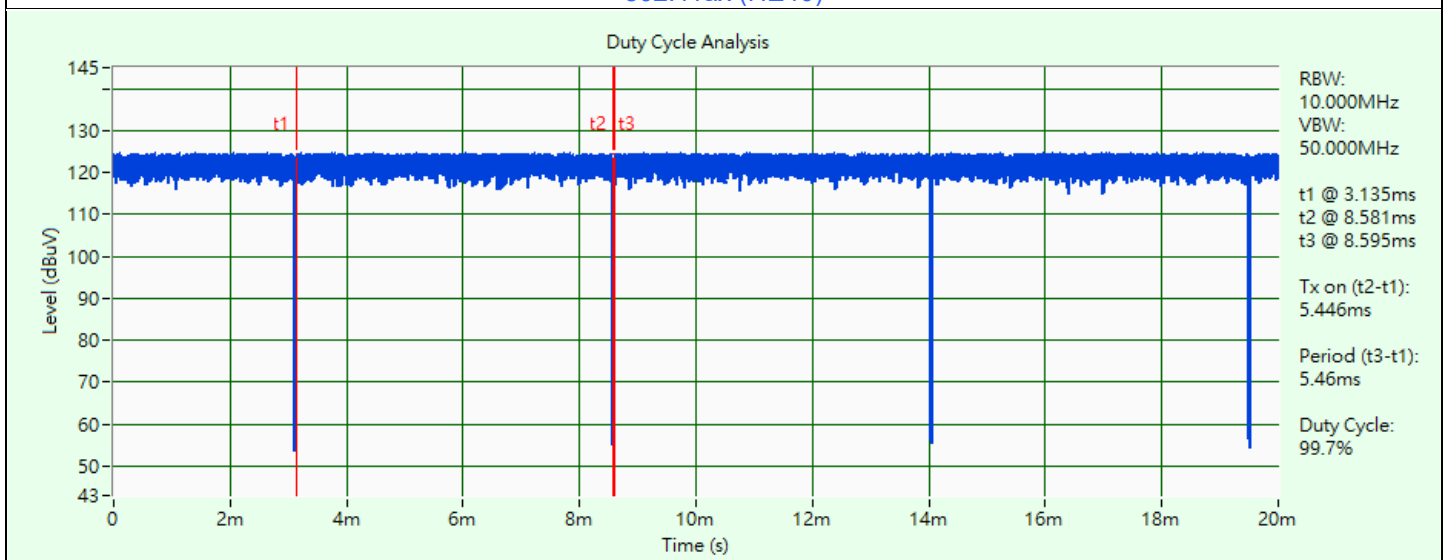

802.11ax (HE80)

3.6 Test Program Used and Operation Descriptions

Controlling software (qdart_conn.win.1.0_installer_00094.1) has been activated to set the EUT under transmission condition continuously at specific channel frequency.

3.7 Connection Diagram of EUT and Peripheral Devices

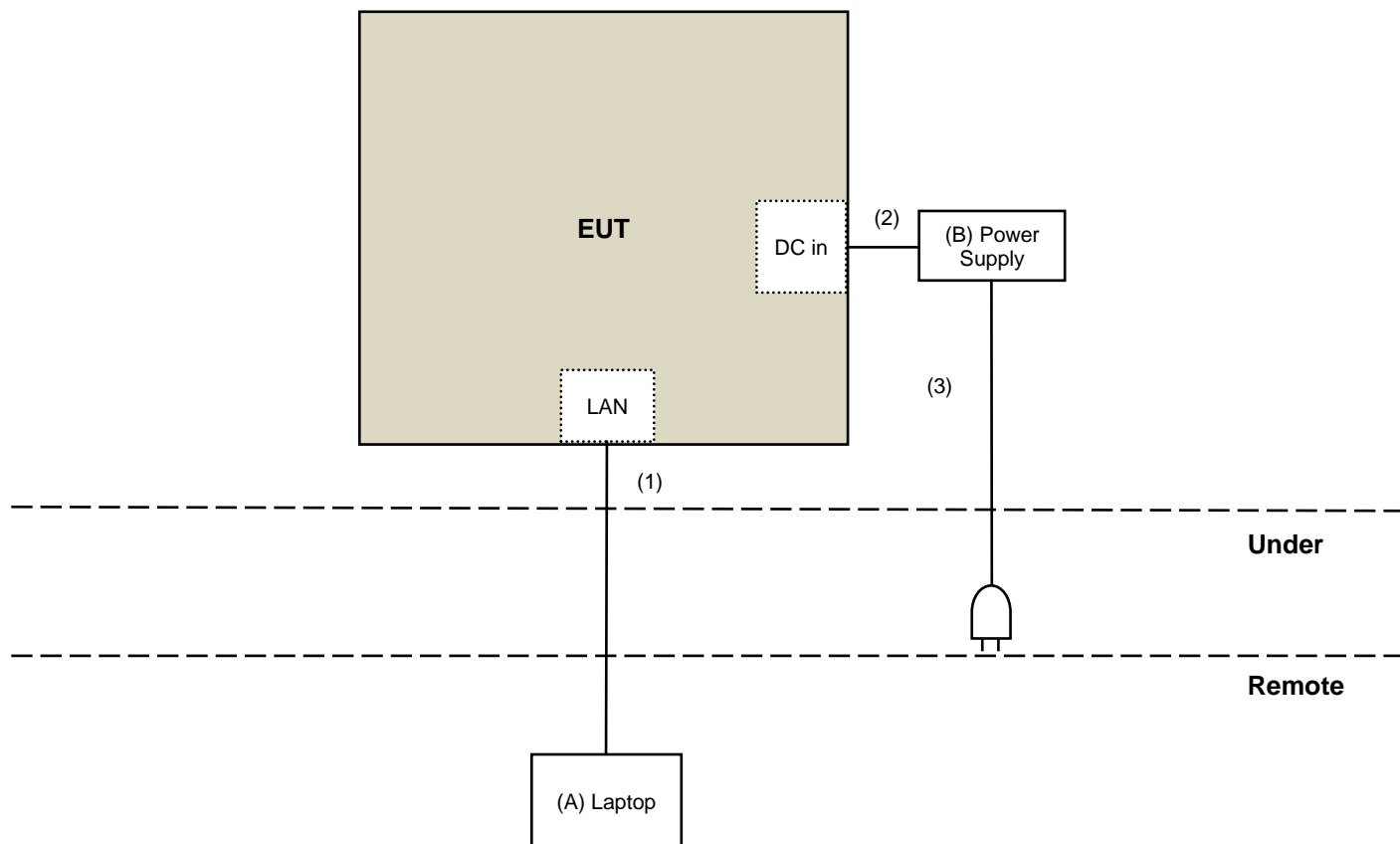

3.8 Configuration of Peripheral Devices and Cable Connections

| ID | Product | Brand | Model No. | Serial No. | FCC ID | Remarks |
|----|---------|---------|-----------|------------|------------|-----------------------|
| A | Laptop | Lenovo | 81A4 | YD02YN22 | PD93165NGU | Provided by Lab |
| B | PSU | Keyence | MS2-H50 | N/A | N/A | Supplied by applicant |

| ID | Cable Descriptions | Qty. | Length (m) | Shielding (Yes/No) | Cores (Qty.) | Remarks |
|----|--------------------|------|------------|--------------------|--------------|-----------------------|
| 1 | RJ-45 | 1 | 10 | No | 0 | Provided by Lab |
| 2 | DC Cable | 1 | 0.7 | No | 0 | Supplied by applicant |
| 3 | AC Power Cable | 1 | 1.7 | No | 0 | Supplied by applicant |

4 Test Instruments

The calibration interval of the all test instruments are 12 months and the calibrations are traceable to NML/ROC and NIST/USA.

4.1 RF Output Power

| Description Manufacturer | Model No. | Serial No. | Calibrated Date | Calibrated Until |
|-------------------------------|------------|---------------|--------------------|---------------------|
| Fixed Attenuator Woken | MDCS18N-10 | MDCS18N-10-01 | 2023/3/27 | 2024/3/26 |
| Power Meter Anritsu | ML2495A | 1529002 | 2023/6/17 | 2024/6/16 |
| Pulse Power Sensor Anritsu | MA2411B | 1726434 | 2023/6/19 | 2024/6/18 |

Notes:

1. The test was performed in Oven room 2.
2. Tested Date: 2023/6/26

4.2 Power Spectral Density

| Description Manufacturer | Model No. | Serial No. | Calibrated Date | Calibrated Until |
|---------------------------------|----------------------------------|---------------|--------------------|---------------------|
| Fixed Attenuator Woken | MDCS18N-10 | MDCS18N-10-01 | 2023/3/27 | 2024/3/26 |
| MXA Signal Analyzer Keysight | N9020B | MY60112409 | 2023/2/18 | 2024/2/17 |
| Software | ADT_RF Test Software V6.6.5.4 | N/A | N/A | N/A |

Notes:

1. The test was performed in Oven room 2.
2. Tested Date: 2023/6/26

4.3 6 dB Bandwidth

Refer to section 4.2 to get information of the instruments.

4.4 Occupied Bandwidth

Refer to section 4.2 to get information of the instruments.

4.5 Frequency Stability

| Description Manufacturer | Model No. | Serial No. | Calibrated Date | Calibrated Until |
|---|----------------------------------|---------------|--------------------|---------------------|
| DC Power Supply Topward | 6603D | 795558 | N/A | N/A |
| Fixed Attenuator Woken | MDCS18N-10 | MDCS18N-10-01 | 2023/3/27 | 2024/3/26 |
| MXA Signal Analyzer Keysight | N9020B | MY60112409 | 2023/2/18 | 2024/2/17 |
| Software | ADT_RF Test Software V6.6.5.4 | N/A | N/A | N/A |
| Temperature & Humidity Chamber Giant Force | GTH-150-40-SP-AR | MAA0812-008 | 2022/12/26 | 2023/12/25 |
| True RMS Clamp Meter FLUKE | 325 | 31130711WS | 2023/6/8 | 2024/6/7 |

Notes:

1. The test was performed in Oven room 2.
2. Tested Date: 2023/6/26

4.6 AC Power Conducted Emissions

| Description Manufacturer | Model No. | Serial No. | Calibrated Date | Calibrated Until |
|-----------------------------|---------------------|------------|--------------------|---------------------|
| 50 ohm terminal resistance | N/A | EMC-01 | 2022/9/27 | 2023/9/26 |
| EMI Test Receiver R&S | ESCS 30 | 847124/029 | 2022/10/14 | 2023/10/13 |
| Fixed Attenuator STI | STI02-2200-10 | 005 | 2022/8/24 | 2023/8/23 |
| LISN R&S | ESH3-Z5 | 848773/004 | 2022/10/18 | 2023/10/17 |
| RF Coaxial Cable JYEBAO | 5D-FB | COCCAB-001 | 2022/8/24 | 2023/8/23 |
| Software BVADT | BVADT_Cond_V7.3.7.4 | N/A | N/A | N/A |

Notes:

1. The test was performed in Conduction 1
2. Tested Date: 2023/6/5

4.7 Unwanted Emissions below 1 GHz

| Description Manufacturer | Model No. | Serial No. | Calibrated Date | Calibrated Until |
|---|----------------------|-------------|--------------------|---------------------|
| Bi_Log Antenna Schwarzbeck | VULB 9168 | 9168-0942 | 2022/10/20 | 2023/10/19 |
| Boresight Antenna Tower & Turn Table Max-Full | MF-7802BS | MF780208530 | N/A | N/A |
| Fixed Attenuator Mini-Circuits | UNAT-5+ | PAD-ATT5-01 | 2022/12/28 | 2023/12/27 |
| Loop Antenna Electro-Metrics | EM-6879 | 264 | 2023/2/21 | 2024/2/20 |
| MXA Signal Analyzer Keysight | N9020B | MY60112410 | 2023/3/6 | 2024/3/5 |
| MXE EMI Receiver Keysight | N9038A | MY59050100 | 2022/6/20 | 2023/6/19 |
| Preamplifier EMCI | EMC330N | 980852 | 2023/2/20 | 2024/2/19 |
| | EMC001340 | 980142 | 2023/5/8 | 2024/5/7 |
| RF Coaxial Cable JYEBAO | 5D-FB | LOOPCAB-001 | 2022/12/19 | 2023/12/18 |
| | | LOOPCAB-002 | 2022/12/19 | 2023/12/18 |
| RF Coaxial Cable PEWC | 8D | 966-6-1 | 2023/4/6 | 2024/4/5 |
| | | 966-6-2 | 2023/4/6 | 2024/4/5 |
| | | 966-6-3 | 2023/4/6 | 2024/4/5 |
| Software | ADT_Radiated_V8.7.08 | N/A | N/A | N/A |

Notes:

1. The test was performed in 966 Chamber No. 6.
2. Tested Date: 2023/5/30

4.8 Unwanted Emissions above 1 GHz

| Description Manufacturer | Model No. | Serial No. | Calibrated Date | Calibrated Until |
|---|----------------------|-------------|------------------------|------------------------|
| Boresight Antenna Tower & Turn Table Max-Full | MF-7802BS | MF780208530 | N/A | N/A |
| Horn Antenna Schwarzbeck | BBHA 9120D | 9120D-2035 | 2022/11/13 | 2023/11/12 |
| | BBHA 9170 | BBHA9170519 | 2022/11/13 | 2023/11/12 |
| MXA Signal Analyzer Keysight | N9020B | MY60112410 | 2023/3/6 | 2024/3/5 |
| MXE EMI Receiver Keysight | N9038A | MY59050100 | 2022/6/20 2023/6/13 | 2023/6/19 2024/6/12 |
| Preamplifier EMCI | EMC12630SE | 980385 | 2022/8/15 | 2023/8/14 |
| | EMC184045SE | 980387 | 2022/12/28 | 2023/12/27 |
| RF Coaxial Cable EMCI | EMC-KM-KM-4000 | 200214 | 2023/2/20 | 2024/2/19 |
| | EMC101G-KM-KM-10000 | 210708 | 2022/11/4 | 2023/11/3 |
| | EMC102-KM-KM-1200 | 160924 | 2022/12/28 | 2023/12/27 |
| | EMC104-SM-SM-1300 | 210205 | 2023/5/8 | 2024/5/7 |
| Software | ADT_Radiated_V8.7.08 | N/A | N/A | N/A |

Notes:

1. The test was performed in 966 Chamber No. 6.
2. Tested Date: 2023/5/24 ~ 2023/6/29

5 Limits of Test Items

5.1 RF Output Power

| Operation Band | EUT Category | Limit |
|----------------|-----------------------------------|---|
| U-NII-1 | Outdoor Access Point | 1 Watt (30 dBm) (Max. e.i.r.p \leq 125mW(21 dBm) at any elevation angle above 30 degrees as measured from the horizon) |
| | Fixed point-to-point Access Point | 1 Watt (30 dBm) |
| | Indoor Access Point | 1 Watt (30 dBm) |
| | Mobile and Portable client device | 250mW (24 dBm) |

| Operation Band | Limit |
|----------------|-----------------|
| U-NII-3 | 1 Watt (30 dBm) |

Per KDB 662911 D01 Multiple Transmitter Output Method of conducted output power measurement on IEEE 802.11 devices,

Array Gain = 0 dB (i.e., no array gain) for $N_{ANT} \leq 4$;

Array Gain = 0 dB (i.e., no array gain) for channel widths ≥ 40 MHz for any N_{ANT} ;

Array Gain = $5 \log(N_{ANT}/N_{SS})$ dB or 3 dB, whichever is less, for 20-MHz channel widths with $N_{ANT} \geq 5$.

For power measurements on all other devices: Array Gain = $10 \log(N_{ANT}/N_{SS})$ dB.

5.2 Power Spectral Density

| Operation Band | EUT Category | Limit |
|----------------|-----------------------------------|------------|
| U-NII-1 | Outdoor Access Point | 17 dBm/MHz |
| | Fixed point-to-point Access Point | |
| | Indoor Access Point | |
| | Mobile and Portable client device | 11 dBm/MHz |

| Operation Band | Limit |
|----------------|----------------|
| U-NII-3 | 30 dBm/500 kHz |

5.3 6 dB Bandwidth

Within the 5.725-5.850 GHz band, the minimum 6 dB bandwidth of U-NII devices shall be at least 500 kHz.

5.4 Occupied Bandwidth

The results are for reference only.

5.5 Frequency Stability

The frequency of the carrier signal shall be maintained within band of operation.

5.6 AC Power Conducted Emissions

| Frequency (MHz) | Conducted Limit (dBuV) | |
|-----------------|------------------------|---------|
| | Quasi-peak | Average |
| 0.15 - 0.5 | 66 - 56 | 56 - 46 |
| 0.50 - 5.0 | 56 | 46 |
| 5.0 - 30.0 | 60 | 50 |

Notes:

1. The lower limit shall apply at the transition frequencies.
2. The limit decreases in line with the logarithm of the frequency in the range of 0.15 to 0.50 MHz.

5.7 Unwanted Emissions below 1 GHz

Radiated emissions which fall in the restricted bands must comply with the radiated emission limits specified as below table.

| Frequencies (MHz) | Field Strength (microvolts/meter) | Measurement Distance (meters) |
|-------------------|-----------------------------------|-------------------------------|
| 0.009 ~ 0.490 | 2400/F(kHz) | 300 |
| 0.490 ~ 1.705 | 24000/F(kHz) | 30 |
| 1.705 ~ 30.0 | 30 | 30 |
| 30 ~ 88 | 100 | 3 |
| 88 ~ 216 | 150 | 3 |
| 216 ~ 960 | 200 | 3 |
| Above 960 | 500 | 3 |

Notes:

1. The lower limit shall apply at the transition frequencies.
2. Emission level (dBuV/m) = 20 log Emission level (uV/m).

5.8 Unwanted Emissions above 1 GHz

Radiated emissions which fall in the restricted bands must comply with the radiated emission limits specified as below table.

| Frequencies (MHz) | Field Strength (microvolts/meter) | Measurement Distance (meters) |
|-------------------|-----------------------------------|-------------------------------|
| Above 960 | 500 | 3 |

Notes:

1. The lower limit shall apply at the transition frequencies.
2. Emission level (dBuV/m) = 20 log Emission level (uV/m).
3. For frequencies above 1000 MHz, the field strength limits are based on average detector, however, the peak field strength of any emission shall not exceed the maximum permitted average limits, specified above by more than 20 dB under any condition of modulation.

Limits of unwanted emission out of the restricted bands

| Applicable To | Limit | |
|---|-----------------------|-----------------|
| 789033 D02 General UNII Test Procedure New Rules v02r01 | Field Strength at 3 m | |
| | PK: 74 (dBμV/m) | AV: 54 (dBμV/m) |

For transmitters operating in the 5.15-5.25 GHz band:

| Applicable To | EIRP Limit | Equivalent Field Strength at 3 m |
|---------------|-------------------|----------------------------------|
| 15.407(b)(1) | PK: -27 (dBm/MHz) | PK: 68.2 (dBμV/m) |

For transmitters operating in the 5.725-5.850 GHz band:

| Applicable To | EIRP Limit | Equivalent Field Strength at 3 m |
|-----------------|---|---|
| 15.407(b)(4)(i) | PK: -27 (dBm/MHz) ^{*1} PK: 10 (dBm/MHz) ^{*2} PK: 15.6 (dBm/MHz) ^{*3} PK: 27 (dBm/MHz) ^{*4} | PK: 68.2 (dBμV/m) ^{*1} PK: 105.2 (dBμV/m) ^{*2} PK: 110.8 (dBμV/m) ^{*3} PK: 122.2 (dBμV/m) ^{*4} |

^{*1} beyond 75 MHz or more above of the band edge.

^{*2} below the band edge increasing linearly to 10 dBm/MHz at 25 MHz above.

^{*3} below the band edge increasing linearly to a level of 15.6 dBm/MHz at 5 MHz above.

^{*4} from 5 MHz above or below the band edge increasing linearly to a level of 27 dBm/MHz at the band edge.

Note: The following formula is used to convert the equipment isotropic radiated power (eirp) to field strength:

$$E = \frac{1000000\sqrt{30P}}{3} \mu\text{V/m, where P is the eirp (Watts).}$$

6 Test Arrangements

6.1 RF Output Power

6.1.1 Test Setup

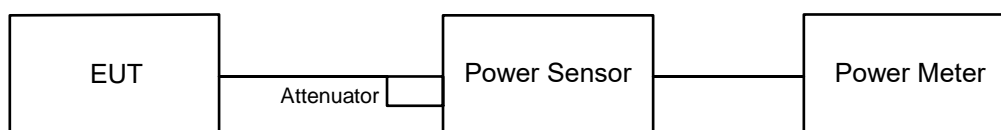

6.1.2 Test Procedure

Method PM is used to perform output power measurement, trigger and gating function of wide band power meter is enabled to measure max output power of TX on burst and set the detector to average. Duty factor is not added to measured value.

6.2 Power Spectral Density

6.2.1 Test Setup

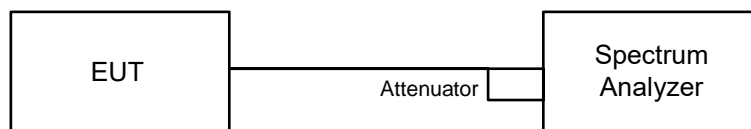

6.2.2 Test Procedure

For specified measurement bandwidth 1 MHz:

Method SA-1

- Set span to encompass the entire emission bandwidth (EBW) of the signal.
- Set RBW = 1 MHz, Set VBW \geq 3 MHz, Detector = RMS
- Sweep points \geq $[2 \times \text{span} / \text{RBW}]$. (This gives bin-to-bin spacing \leq RBW / 2, so that narrowband signals are not lost between frequency bins.)
- Sweep time = auto, trigger set to "free run".
- Trace average at least 100 traces in power averaging mode.
- Record the max value

For specified measurement bandwidth 500 kHz:

Method SA-1

- Set span to encompass the entire emission bandwidth (EBW) of the signal.
- Set RBW = 300 kHz, Set VBW \geq 1 MHz, Detector = RMS
- Scale the observed power level to an equivalent value in 500 kHz by adjusting (increasing) the measured power by a bandwidth correction factor (BWCF) where $\text{BWCF} = 10\log(500 \text{ kHz}/300 \text{ kHz})$
- Sweep points \geq $[2 \times \text{span} / \text{RBW}]$. (This gives bin-to-bin spacing \leq RBW / 2, so that narrowband signals are not lost between frequency bins.)
- Sweep time = auto, trigger set to "free run".
- Trace average at least 100 traces in power averaging mode.
- Record the max value

For specified measurement bandwidth 500 kHz:

Method SA-2

- Set span to encompass the entire emission bandwidth (EBW) of the signal.
- Set RBW = 300 kHz, Set VBW \geq 1 MHz, Detector = RMS
- Scale the observed power level to an equivalent value in 500 kHz by adjusting (increasing) the measured power by a bandwidth correction factor (BWCF) where $\text{BWCF} = 10\log(500 \text{ kHz}/300 \text{ kHz})$
- Sweep points \geq $[2 \times \text{span} / \text{RBW}]$. (This gives bin-to-bin spacing \leq RBW / 2, so that narrowband signals are not lost between frequency bins.)
- Sweep time = auto, trigger set to "free run".
- Trace average at least 100 traces in power averaging mode.
- Use the peak search function on the instrument to find the peak of the spectrum and record its value.
- Record the max value and add $10 \log(1/\text{duty cycle})$.

6.3 6 dB Bandwidth

6.3.1 Test Setup

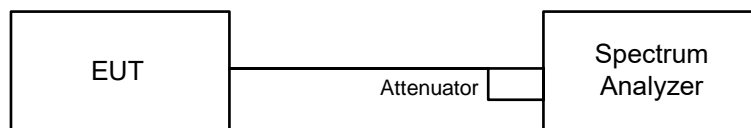

6.3.2 Test Procedure

- Set resolution bandwidth (RBW) = 100 kHz.
- Set the video bandwidth (VBW) $\geq 3 \times$ RBW, Detector = Peak.
- Trace mode = max hold.
- Sweep = auto couple.
- Measure the maximum width of the emission that is constrained by the frequencies associated with the two amplitude points (upper and lower) that are attenuated by 6 dB relative to the maximum level measured in the fundamental emission.

6.4 Occupied Bandwidth

6.4.1 Test Setup

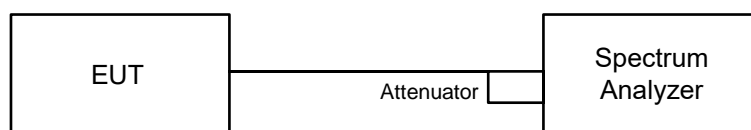

6.4.2 Test Procedure

The transmitter output was connected to the spectrum analyzer through an attenuator. The bandwidth of the fundamental frequency was measured by spectrum analyzer with resolution bandwidth in the range of 1% to 5% of the anticipated emission bandwidth, and a video bandwidth at least 3x the resolution bandwidth and set the detector to Sampling. The width of a frequency band such that, below the lower and above the upper frequency limits, the mean powers emitted are each equal to a specified percentage 0.5% of the total mean power of a given emission.

6.5 Frequency Stability

6.5.1 Test Setup

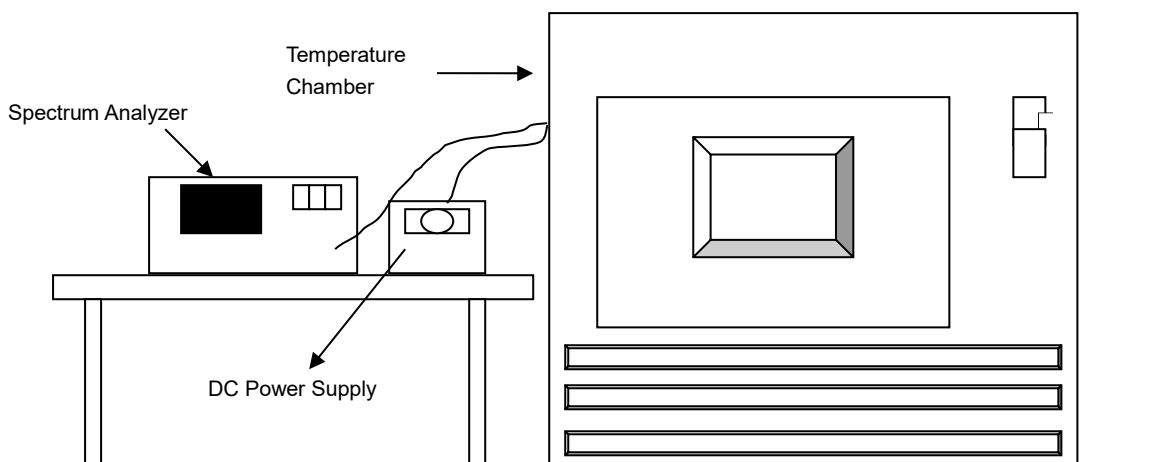

6.5.2 Test Procedure

- The EUT was placed inside the environmental test chamber and powered by nominal DC voltage.
- Turn the EUT on and couple its output to a spectrum analyzer.
- Turn the EUT off and set the chamber to the highest temperature specified.
- Allow sufficient time (approximately 30 min) for the temperature of the chamber to stabilize, turn the EUT on and measure the operating frequency after 2, 5, and 10 Minutes.
- Repeat step (d) with the temperature chamber set to the next desired temperature until measurements down to the lowest specified temperature have been completed.
- The test chamber was allowed to stabilize at +20 degree C for a minimum of 30 Minutes. The supply voltage was then adjusted on the EUT from 85% to 115% and the frequency record.

6.6 AC Power Conducted Emissions

6.6.1 Test Setup

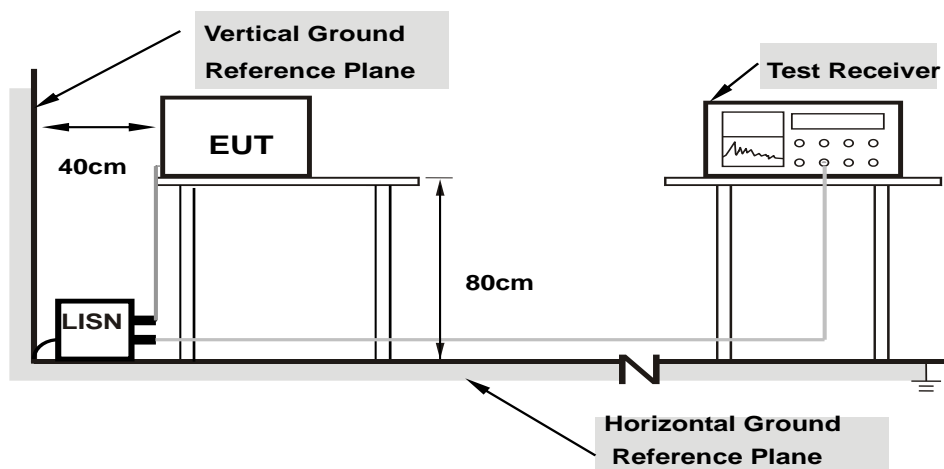

Note: 1.Support units were connected to second LISN.

For the actual test configuration, please refer to the attached file (Test Setup Photo).

6.6.2 Test Procedure

- The EUT was placed on a 0.8 meter to the top of table and placed 0.4 meters from the conducting wall of the shielded room with EUT being connected to the power mains through a line impedance stabilization network (LISN). Other support units were connected to the power mains through another LISN. The two LISNs provide 50 ohm/ 50 uH of coupling impedance for the measuring instrument.
- Both lines of the power mains connected to the EUT were checked for maximum conducted interference.
- The frequency range from 150 kHz to 30 MHz was searched. Emission levels under (Limit – 20 dB) was not recorded.

Note: The resolution bandwidth and video bandwidth of test receiver is 9 kHz for quasi-peak detection (QP) and average detection (AV) at frequency 0.15 MHz-30 MHz.

6.7 Unwanted Emissions below 1 GHz

6.7.1 Test Setup

For Radiated emission below 30 MHz

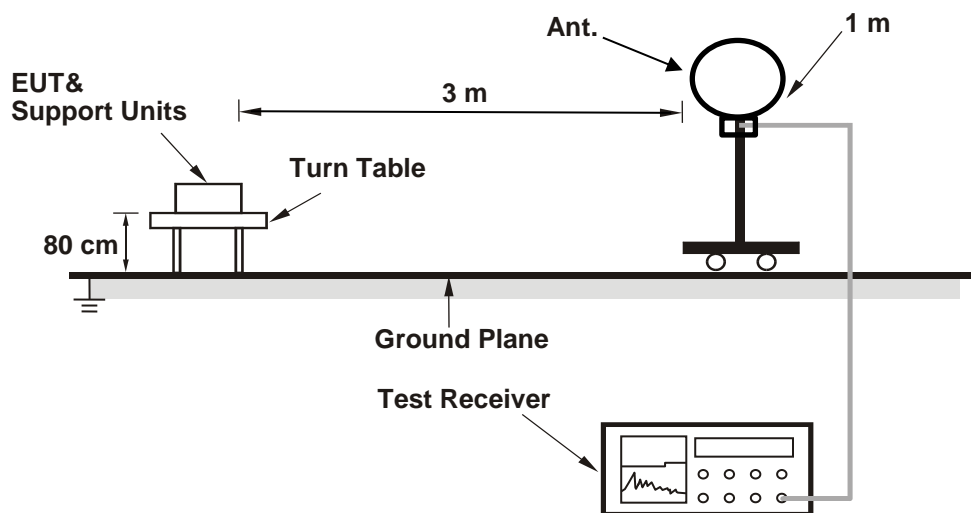

For Radiated emission above 30 MHz

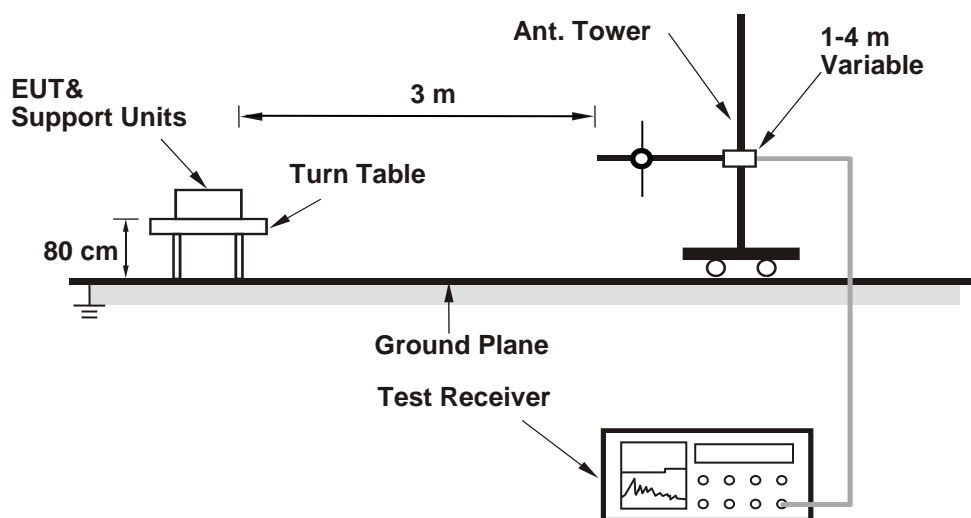

For the actual test configuration, please refer to the attached file (Test Setup Photo).

6.7.2 Test Procedure

For Radiated emission below 30 MHz

- a. The EUT was placed on the top of a rotating table 0.8 meters above the ground at 3 meter chamber room for test. The table was rotated 360 degrees to determine the position of the highest radiation.
- b. The EUT was set 3 meters away from the interference-receiving antenna, which was mounted on the top of a variable-height antenna tower.
- c. Parallel, perpendicular, and ground-parallel orientations of the antenna are set to make the measurement.
- d. For each suspected emission, the EUT was arranged to its worst case and the rotatable table was turned from 0 degrees to 360 degrees to find the maximum reading.
- e. The test-receiver system was set to Quasi-Peak Detect Function and Specified Bandwidth with Maximum Hold Mode, except for the frequency band (9 kHz to 90 kHz and 110 kHz to 490 kHz) set to average detect function and peak detect function.

Notes:

1. The resolution bandwidth and video bandwidth of test receiver/spectrum analyzer is 200 Hz at frequency below 150 kHz.
2. The resolution bandwidth and video bandwidth of test receiver/spectrum analyzer is 9 kHz or 10 kHz at frequency (150 kHz to 30 MHz).
3. All modes of operation were investigated and the worst-case emissions are reported.

For Radiated emission above 30 MHz

- a. The EUT was placed on the top of a rotating table 0.8 meters above the ground at 3 meter chamber room for test. The table was rotated 360 degrees to determine the position of the highest radiation.
- b. The EUT was set 3 meters away from the interference-receiving antenna, which was mounted on the top of a variable-height antenna tower.
- c. The height of antenna is varied from one meter to four meters above the ground to determine the maximum value of the field strength. Both horizontal and vertical polarizations of the antenna are set to make the measurement.
- d. For each suspected emission, the EUT was arranged to its worst case and then the antenna was tuned to heights from 1 meter to 4 meters and the rotatable table was turned from 0 degrees to 360 degrees to find the maximum reading.
- e. The test-receiver system was set to Quasi-peak(QP) detect function, Average(AV) detect function, Peak(PK) detect function and specified bandwidth with maximum hold mode when the test frequency is below 1 GHz.

Notes:

1. The resolution bandwidth and video bandwidth of test receiver/spectrum analyzer is 120 kHz for Quasi-peak detection (QP), Average detection (AV), Peak detection (PK) at frequency (30MHz to 1 GHz).
2. All modes of operation were investigated and the worst-case emissions are reported.

6.8 Unwanted Emissions above 1 GHz

6.8.1 Test Setup

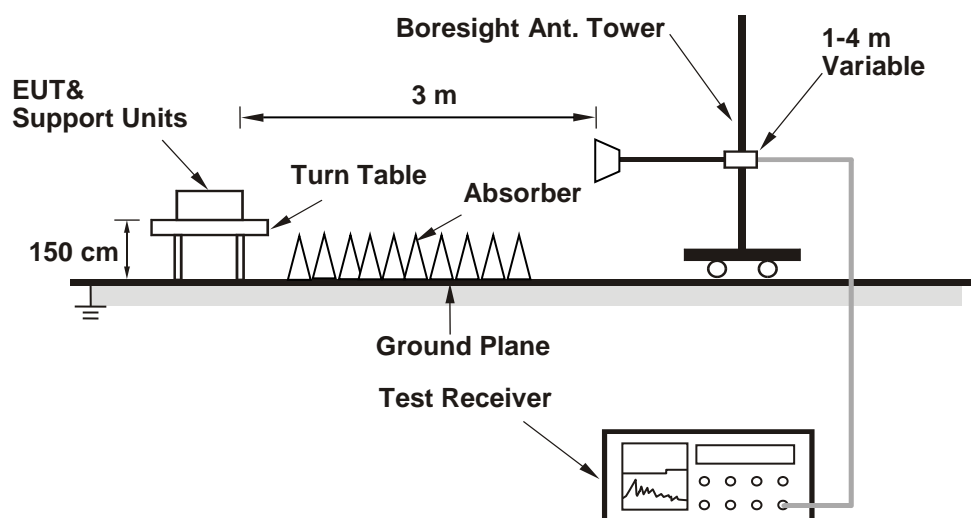

For the actual test configuration, please refer to the attached file (Test Setup Photo).

6.8.2 Test Procedure

- The EUT was placed on the top of a rotating table 1.5 meters above the ground at 3 meter chamber room for test. The table was rotated 360 degrees to determine the position of the highest radiation.
- The EUT was set 3 meters away from the interference-receiving antenna, which was mounted on the top of a variable-height antenna tower.
- The height of antenna is varied from one meter to four meters above the ground to determine the maximum value of the field strength. Both horizontal and vertical polarizations of the antenna are set to make the measurement.
- For each suspected emission, the EUT was arranged to its worst case and then the antenna was tuned to heights from 1 meter to 4 meters and the rotatable table was turned from 0 degrees to 360 degrees to find the maximum reading.
- The test-receiver system was set to peak and average detects function and specified bandwidth with maximum hold mode when the test frequency is above 1 GHz. If the peak reading value also meets average limit, measurement with the average detector is unnecessary.

Notes:

- The resolution bandwidth of test receiver/spectrum analyzer is 1 MHz and the video bandwidth is 3 MHz for Peak detection (PK) and Average detection (AV) at frequency above 1 GHz.
- For fundamental and harmonic signal measurement, the resolution bandwidth of test receiver/spectrum analyzer is 1 MHz and the video bandwidth is $\geq 1/T$ (Duty cycle $< 98\%$) or 10 Hz (Duty cycle $\geq 98\%$) for Average detection (AV) at frequency above 1 GHz.
- All modes of operation were investigated and the worst-case emissions are reported.

7 Test Results of Test Item

7.1 RF Output Power

| | | | | | |
|--------------|--------|---------------------------|--------------|------------|-----------|
| Input Power: | 24 Vdc | Environmental Conditions: | 25°C, 60% RH | Tested By: | Katina Lu |
|--------------|--------|---------------------------|--------------|------------|-----------|

802.11a CDD

| Chan. | Chan. Freq. (MHz) | Average Power (dBm) | | Total Power (mW) | Total Power (dBm) | Power Limit (dBm) | Test Result |
|-------|-------------------|---------------------|---------|------------------|-------------------|-------------------|-------------|
| | | Chain 0 | Chain 1 | | | | |
| 36 | 5180 | 21.02 | 20.85 | 248.092 | 23.95 | 30 | Pass |
| 40 | 5200 | 24.01 | 23.85 | 494.429 | 26.94 | 30 | Pass |
| 48 | 5240 | 24.30 | 24.26 | 535.839 | 27.29 | 30 | Pass |
| 149 | 5745 | 24.81 | 25.12 | 627.779 | 27.98 | 30 | Pass |
| 157 | 5785 | 24.43 | 24.12 | 535.558 | 27.29 | 30 | Pass |
| 165 | 5825 | 23.63 | 22.59 | 412.226 | 26.15 | 30 | Pass |

Notes:

1. Directional gain is the maximum gain of antennas.
2. For U-NII-1, the maximum gain is 5.07 dBi < 6 dBi, so the output power limit shall not be reduced.
3. For U-NII-3, the maximum gain is 5.64 dBi < 6 dBi, so the output power limit shall not be reduced.

802.11ac (VHT20) CDD

| Chan. | Chan. Freq. (MHz) | Average Power (dBm) | | Total Power (mW) | Total Power (dBm) | Power Limit (dBm) | Test Result |
|-------|-------------------|---------------------|---------|------------------|-------------------|-------------------|-------------|
| | | Chain 0 | Chain 1 | | | | |
| 36 | 5180 | 19.96 | 19.95 | 197.939 | 22.97 | 30 | Pass |
| 40 | 5200 | 22.90 | 20.91 | 318.295 | 25.03 | 30 | Pass |
| 48 | 5240 | 23.71 | 23.71 | 469.927 | 26.72 | 30 | Pass |
| 149 | 5745 | 24.37 | 24.94 | 585.416 | 27.67 | 30 | Pass |
| 157 | 5785 | 24.11 | 24.25 | 523.705 | 27.19 | 30 | Pass |
| 165 | 5825 | 23.46 | 22.42 | 396.402 | 25.98 | 30 | Pass |

Notes:

1. Directional gain is the maximum gain of antennas.
2. For U-NII-1, the maximum gain is 5.07 dBi < 6 dBi, so the output power limit shall not be reduced.
3. For U-NII-3, the maximum gain is 5.64 dBi < 6 dBi, so the output power limit shall not be reduced.

802.11ac (VHT40) CDD

| Chan. | Chan. Freq. (MHz) | Average Power (dBm) | | Total Power (mW) | Total Power (dBm) | Power Limit (dBm) | Test Result |
|-------|-------------------|---------------------|---------|------------------|-------------------|-------------------|-------------|
| | | Chain 0 | Chain 1 | | | | |
| 38 | 5190 | 19.37 | 19.27 | 171.025 | 22.33 | 30 | Pass |
| 46 | 5230 | 23.85 | 23.72 | 478.166 | 26.80 | 30 | Pass |
| 151 | 5755 | 24.39 | 24.63 | 565.192 | 27.52 | 30 | Pass |
| 159 | 5795 | 24.16 | 23.36 | 477.386 | 26.79 | 30 | Pass |

Notes:

1. Directional gain is the maximum gain of antennas.
2. For U-NII-1, the maximum gain is 5.07 dBi < 6 dBi, so the output power limit shall not be reduced.
3. For U-NII-3, the maximum gain is 5.64 dBi < 6 dBi, so the output power limit shall not be reduced.

802.11ac (VHT80) CDD

| Chan. | Chan. Freq. (MHz) | Average Power (dBm) | | Total Power (mW) | Total Power (dBm) | Power Limit (dBm) | Test Result |
|-------|-------------------|---------------------|---------|------------------|-------------------|-------------------|-------------|
| | | Chain 0 | Chain 1 | | | | |
| 42 | 5210 | 18.07 | 17.93 | 126.208 | 21.01 | 30 | Pass |
| 155 | 5775 | 21.54 | 22.60 | 324.531 | 25.11 | 30 | Pass |

Notes:

1. Directional gain is the maximum gain of antennas.
2. For U-NII-1, the maximum gain is 5.07 dBi < 6 dBi, so the output power limit shall not be reduced.
3. For U-NII-3, the maximum gain is 5.64 dBi < 6 dBi, so the output power limit shall not be reduced.

802.11ax (HE20) CDD

| Chan. | Chan. Freq. (MHz) | Average Power (dBm) | | Total Power (mW) | Total Power (dBm) | Power Limit (dBm) | Test Result |
|-------|-------------------|---------------------|---------|------------------|-------------------|-------------------|-------------|
| | | Chain 0 | Chain 1 | | | | |
| 36 | 5180 | 20.23 | 20.18 | 209.67 | 23.22 | 30 | Pass |
| 40 | 5200 | 23.12 | 21.17 | 336.034 | 25.26 | 30 | Pass |
| 48 | 5240 | 23.97 | 23.93 | 496.632 | 26.96 | 30 | Pass |
| 149 | 5745 | 24.62 | 25.19 | 620.104 | 27.92 | 30 | Pass |
| 157 | 5785 | 24.33 | 24.51 | 553.507 | 27.43 | 30 | Pass |
| 165 | 5825 | 23.71 | 22.64 | 418.617 | 26.22 | 30 | Pass |

Notes:

1. Directional gain is the maximum gain of antennas.
2. For U-NII-1, the maximum gain is 5.07 dBi < 6 dBi, so the output power limit shall not be reduced.
3. For U-NII-3, the maximum gain is 5.64 dBi < 6 dBi, so the output power limit shall not be reduced.

802.11ax (HE40) CDD

| Chan. | Chan. Freq. (MHz) | Average Power (dBm) | | Total Power (mW) | Total Power (dBm) | Power Limit (dBm) | Test Result |
|-------|-------------------|---------------------|---------|------------------|-------------------|-------------------|-------------|
| | | Chain 0 | Chain 1 | | | | |
| 38 | 5190 | 19.59 | 19.52 | 180.528 | 22.57 | 30 | Pass |
| 46 | 5230 | 24.09 | 24.01 | 508.216 | 27.06 | 30 | Pass |
| 151 | 5755 | 24.66 | 24.91 | 602.157 | 27.80 | 30 | Pass |
| 159 | 5795 | 24.39 | 23.63 | 505.464 | 27.04 | 30 | Pass |

Notes:

1. Directional gain is the maximum gain of antennas.
2. For U-NII-1, the maximum gain is 5.07 dBi < 6 dBi, so the output power limit shall not be reduced.
3. For U-NII-3, the maximum gain is 5.64 dBi < 6 dBi, so the output power limit shall not be reduced.

802.11ax (HE80) CDD

| Chan. | Chan. Freq. (MHz) | Average Power (dBm) | | Total Power (mW) | Total Power (dBm) | Power Limit (dBm) | Test Result |
|-------|-------------------|---------------------|---------|------------------|-------------------|-------------------|-------------|
| | | Chain 0 | Chain 1 | | | | |
| 42 | 5210 | 18.32 | 18.16 | 133.384 | 21.25 | 30 | Pass |
| 155 | 5775 | 21.77 | 22.81 | 341.3 | 25.33 | 30 | Pass |

Notes:

1. Directional gain is the maximum gain of antennas.
2. For U-NII-1, the maximum gain is 5.07 dBi < 6 dBi, so the output power limit shall not be reduced.
3. For U-NII-3, the maximum gain is 5.64 dBi < 6 dBi, so the output power limit shall not be reduced.

802.11ac (VHT20) Beamforming

| Chan. | Chan. Freq. (MHz) | Average Power (dBm) | | Total Power (mW) | Total Power (dBm) | Power Limit (dBm) | Test Result |
|-------|-------------------|---------------------|---------|------------------|-------------------|-------------------|-------------|
| | | Chain 0 | Chain 1 | | | | |
| 36 | 5180 | 19.96 | 19.95 | 197.939 | 22.97 | 28.07 | Pass |
| 40 | 5200 | 22.90 | 20.91 | 318.295 | 25.03 | 28.07 | Pass |
| 48 | 5240 | 23.71 | 23.71 | 469.927 | 26.72 | 28.07 | Pass |
| 149 | 5745 | 23.89 | 24.45 | 523.518 | 27.19 | 27.44 | Pass |
| 157 | 5785 | 24.11 | 24.25 | 523.705 | 27.19 | 27.44 | Pass |
| 165 | 5825 | 23.46 | 22.42 | 396.402 | 25.98 | 27.44 | Pass |

Notes:

1. Directional gain = $10 \log[(10^{\text{Chain0}/20} + 10^{\text{Chain1}/20})^2 / 2]$
2. For U-NII-1, the directional gain is 7.93 dBi > 6 dBi, so the output power limit shall be reduced to $30 - (7.93 - 6) = 28.07$ dBm.
3. For U-NII-3, the directional gain is 8.56 dBi > 6 dBi, so the output power limit shall be reduced to $30 - (8.56 - 6) = 27.44$ dBm.

802.11ac (VHT40) Beamforming

| Chan. | Chan. Freq. (MHz) | Average Power (dBm) | | Total Power (mW) | Total Power (dBm) | Power Limit (dBm) | Test Result |
|-------|-------------------|---------------------|---------|------------------|-------------------|-------------------|-------------|
| | | Chain 0 | Chain 1 | | | | |
| 38 | 5190 | 19.37 | 19.27 | 171.025 | 22.33 | 28.07 | Pass |
| 46 | 5230 | 23.85 | 23.72 | 478.166 | 26.80 | 28.07 | Pass |
| 151 | 5755 | 24.06 | 24.20 | 517.71 | 27.14 | 27.44 | Pass |
| 159 | 5795 | 24.16 | 23.36 | 477.386 | 26.79 | 27.44 | Pass |

Notes:

1. Directional gain = $10 \log[(10^{\text{Chain0}/20} + 10^{\text{Chain1}/20})^2 / 2]$
2. For U-NII-1, the directional gain is 7.93 dBi > 6 dBi, so the output power limit shall be reduced to $30 - (7.93 - 6) = 28.07$ dBm.
3. For U-NII-3, the directional gain is 8.56 dBi > 6 dBi, so the output power limit shall be reduced to $30 - (8.56 - 6) = 27.44$ dBm.

802.11ac (VHT80) Beamforming

| Chan. | Chan. Freq. (MHz) | Average Power (dBm) | | Total Power (mW) | Total Power (dBm) | Power Limit (dBm) | Test Result |
|-------|-------------------|---------------------|---------|------------------|-------------------|-------------------|-------------|
| | | Chain 0 | Chain 1 | | | | |
| 42 | 5210 | 18.07 | 17.93 | 126.208 | 21.01 | 28.07 | Pass |
| 155 | 5775 | 21.54 | 22.60 | 324.531 | 25.11 | 27.44 | Pass |

Notes:

1. Directional gain = $10 \log[(10^{\text{Chain0}/20} + 10^{\text{Chain1}/20})^2 / 2]$
2. For U-NII-1, the directional gain is 7.93 dBi > 6 dBi, so the output power limit shall be reduced to $30 - (7.93 - 6) = 28.07$ dBm.
3. For U-NII-3, the directional gain is 8.56 dBi > 6 dBi, so the output power limit shall be reduced to $30 - (8.56 - 6) = 27.44$ dBm.

802.11ax (HE20) Beamforming

| Chan. | Chan. Freq. (MHz) | Average Power (dBm) | | Total Power (mW) | Total Power (dBm) | Power Limit (dBm) | Test Result |
|-------|-------------------|---------------------|---------|------------------|-------------------|-------------------|-------------|
| | | Chain 0 | Chain 1 | | | | |
| 36 | 5180 | 20.23 | 20.18 | 209.67 | 23.22 | 28.07 | Pass |
| 40 | 5200 | 23.12 | 21.17 | 336.034 | 25.26 | 28.07 | Pass |
| 48 | 5240 | 23.97 | 23.93 | 496.632 | 26.96 | 28.07 | Pass |
| 149 | 5745 | 24.12 | 24.70 | 553.347 | 27.43 | 27.44 | Pass |
| 157 | 5785 | 24.33 | 24.51 | 553.507 | 27.43 | 27.44 | Pass |
| 165 | 5825 | 23.71 | 22.64 | 418.617 | 26.22 | 27.44 | Pass |

Notes:

1. Directional gain = $10 \log[(10^{\text{Chain0}/20} + 10^{\text{Chain1}/20})^2 / 2]$
2. For U-NII-1, the directional gain is 7.93 dBi > 6 dBi, so the output power limit shall be reduced to $30 - (7.93 - 6) = 28.07$ dBm.
3. For U-NII-3, the directional gain is 8.56 dBi > 6 dBi, so the output power limit shall be reduced to $30 - (8.56 - 6) = 27.44$ dBm.

802.11ax (HE40) Beamforming

| Chan. | Chan. Freq. (MHz) | Average Power (dBm) | | Total Power (mW) | Total Power (dBm) | Power Limit (dBm) | Test Result |
|-------|-------------------|---------------------|---------|------------------|-------------------|-------------------|-------------|
| | | Chain 0 | Chain 1 | | | | |
| 38 | 5190 | 19.59 | 19.52 | 180.528 | 22.57 | 28.07 | Pass |
| 46 | 5230 | 24.09 | 24.01 | 508.216 | 27.06 | 28.07 | Pass |
| 151 | 5755 | 24.26 | 24.45 | 545.298 | 27.37 | 27.44 | Pass |
| 159 | 5795 | 24.39 | 23.63 | 505.464 | 27.04 | 27.44 | Pass |

Notes:

1. Directional gain = $10 \log[(10^{\text{Chain0}/20} + 10^{\text{Chain1}/20})^2 / 2]$
2. For U-NII-1, the directional gain is 7.93 dBi > 6 dBi, so the output power limit shall be reduced to $30 - (7.93 - 6) = 28.07$ dBm.
3. For U-NII-3, the directional gain is 8.56 dBi > 6 dBi, so the output power limit shall be reduced to $30 - (8.56 - 6) = 27.44$ dBm.

802.11ax (HE80) Beamforming

| Chan. | Chan. Freq. (MHz) | Average Power (dBm) | | Total Power (mW) | Total Power (dBm) | Power Limit (dBm) | Test Result |
|-------|-------------------|---------------------|---------|------------------|-------------------|-------------------|-------------|
| | | Chain 0 | Chain 1 | | | | |
| 42 | 5210 | 18.32 | 18.16 | 133.384 | 21.25 | 28.07 | Pass |
| 155 | 5775 | 21.77 | 22.81 | 341.3 | 25.33 | 27.44 | Pass |

Notes:

1. Directional gain = $10 \log[(10^{\text{Chain0}/20} + 10^{\text{Chain1}/20})^2 / 2]$
2. For U-NII-1, the directional gain is 7.93 dBi > 6 dBi, so the output power limit shall be reduced to $30 - (7.93 - 6) = 28.07$ dBm.
3. For U-NII-3, the directional gain is 8.56 dBi > 6 dBi, so the output power limit shall be reduced to $30 - (8.56 - 6) = 27.44$ dBm.

7.2 Power Spectral Density

| | | | | | |
|--------------|--------|---------------------------|--------------|------------|-----------|
| Input Power: | 24 Vdc | Environmental Conditions: | 25°C, 60% RH | Tested By: | Katina Lu |
|--------------|--------|---------------------------|--------------|------------|-----------|

802.11a

| Chan. | Chan. Freq. (MHz) | PSD (dBm/MHz) | | Total PSD (dBm/MHz) | Max. PSD Limit (dBm/MHz) | Test Result |
|-------|-------------------|---------------|---------|---------------------|--------------------------|-------------|
| | | Chain 0 | Chain 1 | | | |
| 36 | 5180 | 8.94 | 8.97 | 11.97 | 15.07 | Pass |
| 40 | 5200 | 11.95 | 11.79 | 14.88 | 15.07 | Pass |
| 48 | 5240 | 12.03 | 11.84 | 14.95 | 15.07 | Pass |

Notes:

- Method E) 2) a) of power density measurement of KDB 662911 is using for calculating total power density. Total power density is summing entire spectra across corresponding frequency bins on the various outputs by computer.
- Directional gain = $10 \log[(10^{\text{Chain0}/20} + 10^{\text{Chain1}/20})^2 / 2]$
- For U-NII-1, the directional gain is 7.93 dBi > 6dBi, so the power density limit shall be reduced to $17 - (7.93 - 6) = 15.07$ dBm/MHz.

802.11ax (HE20)

| Chan. | Chan. Freq. (MHz) | PSD (dBm/MHz) | | Total PSD (dBm/MHz) | Max. PSD Limit (dBm/MHz) | Test Result |
|-------|-------------------|---------------|---------|---------------------|--------------------------|-------------|
| | | Chain 0 | Chain 1 | | | |
| 36 | 5180 | 7.84 | 7.58 | 10.72 | 15.07 | Pass |
| 40 | 5200 | 10.72 | 10.50 | 13.62 | 15.07 | Pass |
| 48 | 5240 | 11.27 | 11.02 | 14.16 | 15.07 | Pass |

Notes:

- Method E) 2) a) of power density measurement of KDB 662911 is using for calculating total power density. Total power density is summing entire spectra across corresponding frequency bins on the various outputs by computer.
- Directional gain = $10 \log[(10^{\text{Chain0}/20} + 10^{\text{Chain1}/20})^2 / 2]$
- For U-NII-1, the directional gain is 7.93 dBi > 6dBi, so the power density limit shall be reduced to $17 - (7.93 - 6) = 15.07$ dBm/MHz.

802.11ax (HE40)

| Chan. | Chan. Freq. (MHz) | PSD (dBm/MHz) | | Total PSD (dBm/MHz) | Max. PSD Limit (dBm/MHz) | Test Result |
|-------|-------------------|---------------|---------|---------------------|--------------------------|-------------|
| | | Chain 0 | Chain 1 | | | |
| 38 | 5190 | 4.36 | 4.06 | 7.22 | 15.07 | Pass |
| 46 | 5230 | 8.81 | 8.52 | 11.68 | 15.07 | Pass |

Notes:

- Method E) 2) a) of power density measurement of KDB 662911 is using for calculating total power density. Total power density is summing entire spectra across corresponding frequency bins on the various outputs by computer.
- Directional gain = $10 \log[(10^{\text{Chain0}/20} + 10^{\text{Chain1}/20})^2 / 2]$
- For U-NII-1, the directional gain is 7.93 dBi > 6dBi, so the power density limit shall be reduced to $17 - (7.93 - 6) = 15.07$ dBm/MHz.

802.11ax (HE80)

| Chan. | Chan. Freq. (MHz) | PSD (dBm/MHz) | | Total PSD (dBm/MHz) | Max. PSD Limit (dBm/MHz) | Test Result |
|-------|-------------------|---------------|---------|---------------------|--------------------------|-------------|
| | | Chain 0 | Chain 1 | | | |
| 42 | 5210 | 0.83 | 0.50 | 3.68 | 15.07 | Pass |

Notes:

1. Method E) 2) a) of power density measurement of KDB 662911 is using for calculating total power density. Total power density is summing entire spectra across corresponding frequency bins on the various outputs by computer.
2. Directional gain = $10 \log[(10^{\text{Chain0}/20} + 10^{\text{Chain1}/20})^2 / 2]$
3. For U-NII-1, the directional gain is 7.93 dBi > 6dBi, so the power density limit shall be reduced to $17 - (7.93 - 6) = 15.07$ dBm/MHz.

802.11a

| Chan. | Chan. Freq. (MHz) | PSD (dBm/300kHz) | | Total PSD (dBm/300kHz) | Total PSD (dBm/500kHz) | PSD Limit (dBm/500kHz) | Test Result |
|-------|-------------------|------------------|---------|------------------------|------------------------|------------------------|-------------|
| | | Chain 0 | Chain 1 | | | | |
| 149 | 5745 | 4.93 | 5.32 | 8.14 | 10.36 | 27.44 | Pass |
| 157 | 5785 | 4.87 | 4.26 | 7.59 | 9.81 | 27.44 | Pass |
| 165 | 5825 | 4.03 | 2.52 | 6.35 | 8.57 | 27.44 | Pass |

Notes:

1. Method E) 2) b) Measure and sum spectral maxima across the outputs of KDB 662911 is using for calculating total power density.
2. Directional gain = $10 \log[(10^{\text{Chain0}/20} + 10^{\text{Chain1}/20})^2 / 2]$
3. For U-NII-3, the directional gain is 8.56 dBi > 6 dBi, so the power density limit shall be reduced to $30 - (8.56 - 6) = 27.44$ dBm/500kHz.

802.11ax (HE20)

| Chan. | Chan. Freq. (MHz) | PSD (dBm/300kHz) | | Total PSD (dBm/300kHz) | Total PSD (dBm/500kHz) | PSD Limit (dBm/500kHz) | Test Result |
|-------|-------------------|------------------|---------|------------------------|------------------------|------------------------|-------------|
| | | Chain 0 | Chain 1 | | | | |
| 149 | 5745 | 3.23 | 3.66 | 6.46 | 8.68 | 27.44 | Pass |
| 157 | 5785 | 3.18 | 2.59 | 5.91 | 8.13 | 27.44 | Pass |
| 165 | 5825 | 2.22 | 1.03 | 4.68 | 6.90 | 27.44 | Pass |

Notes:

1. Method E) 2) b) Measure and sum spectral maxima across the outputs of KDB 662911 is using for calculating total power density.
2. Directional gain = $10 \log[(10^{\text{Chain0}/20} + 10^{\text{Chain1}/20})^2 / 2]$
3. For U-NII-3, the directional gain is 8.56 dBi > 6 dBi, so the power density limit shall be reduced to $30 - (8.56 - 6) = 27.44$ dBm/500kHz.

802.11ax (HE40)

| Chan. | Chan. Freq. (MHz) | PSD (dBm/300kHz) | | Total PSD (dBm/300kHz) | Total PSD (dBm/500kHz) | PSD Limit (dBm/500kHz) | Test Result |
|-------|-------------------|------------------|---------|------------------------|------------------------|------------------------|-------------|
| | | Chain 0 | Chain 1 | | | | |
| 151 | 5755 | 0.90 | 0.98 | 3.95 | 6.17 | 27.44 | Pass |
| 159 | 5795 | 0.87 | -0.19 | 3.38 | 5.60 | 27.44 | Pass |

Notes:

1. Method E) 2) b) Measure and sum spectral maxima across the outputs of KDB 662911 is using for calculating total power density.
2. Directional gain = $10 \log[(10^{\text{Chain0}/20} + 10^{\text{Chain1}/20})^2 / 2]$
3. For U-NII-3, the directional gain is 8.56 dBi > 6 dBi, so the power density limit shall be reduced to $30 - (8.56 - 6) = 27.44$ dBm/500kHz.

802.11ax (HE80)

| Chan. | Chan. Freq. (MHz) | PSD (dBm/300kHz) | | Total PSD (dBm/300kHz) | Total PSD (dBm/500kHz) | PSD Limit (dBm/500kHz) | Test Result |
|-------|-------------------|------------------|---------|------------------------|------------------------|------------------------|-------------|
| | | Chain 0 | Chain 1 | | | | |
| 155 | 5775 | -4.30 | -3.74 | -1 | 1.22 | 27.44 | Pass |

Notes:

1. Method E) 2) b) Measure and sum spectral maxima across the outputs of KDB 662911 is using for calculating total power density.
2. Directional gain = $10 \log[(10^{\text{Chain0}/20} + 10^{\text{Chain1}/20})^2 / 2]$
3. For U-NII-3, the directional gain is 8.56 dBi > 6 dBi, so the power density limit shall be reduced to $30 - (8.56 - 6) = 27.44$ dBm/500kHz.



Spectrum Plot of Maximum Value

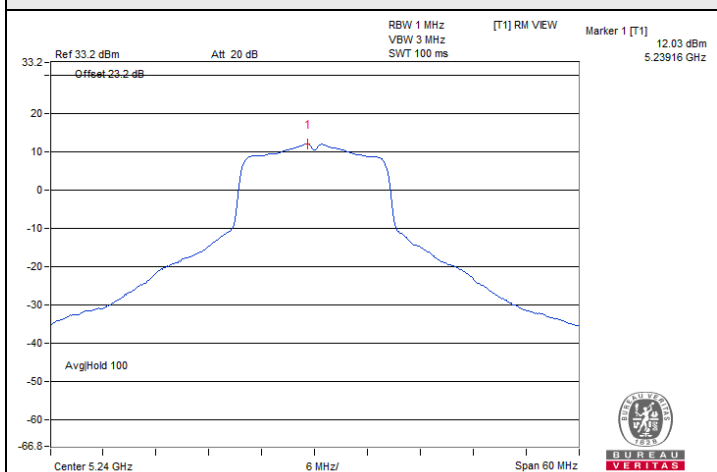

802.11a / Chain 0 : CH 48

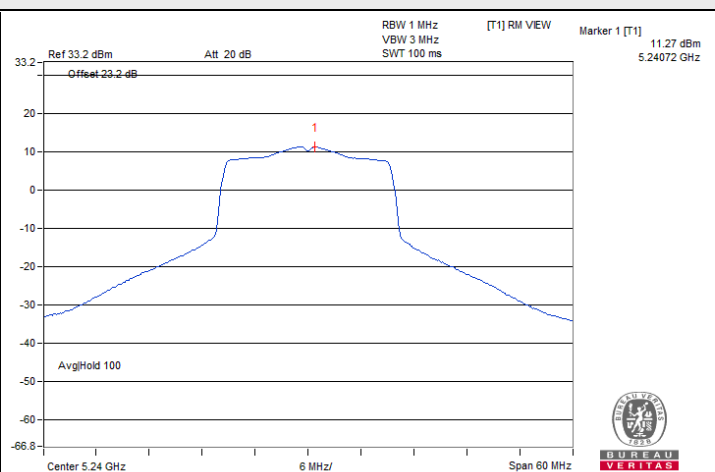

802.11ax (HE20) / Chain 0 : CH 48

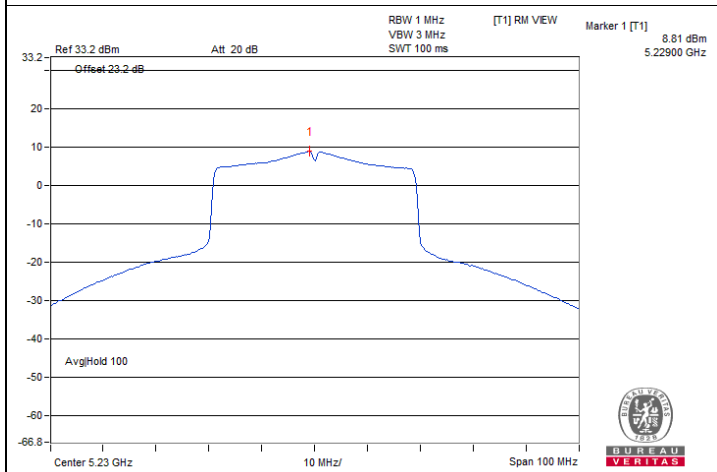

802.11ax (HE40) / Chain 0 : CH 46

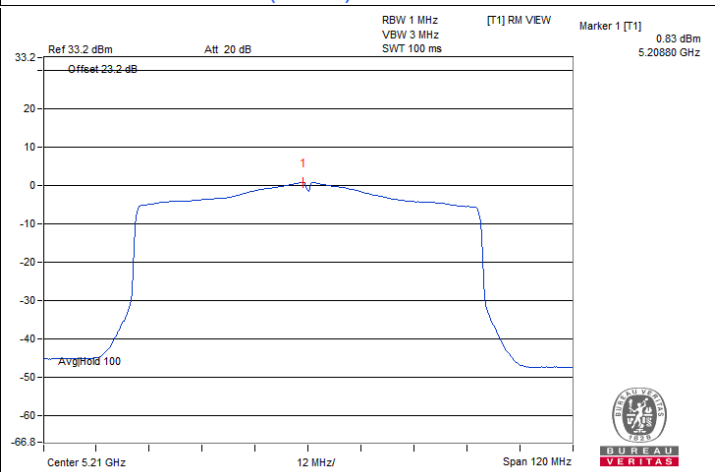

802.11ax (HE80) / Chain 0 : CH 42

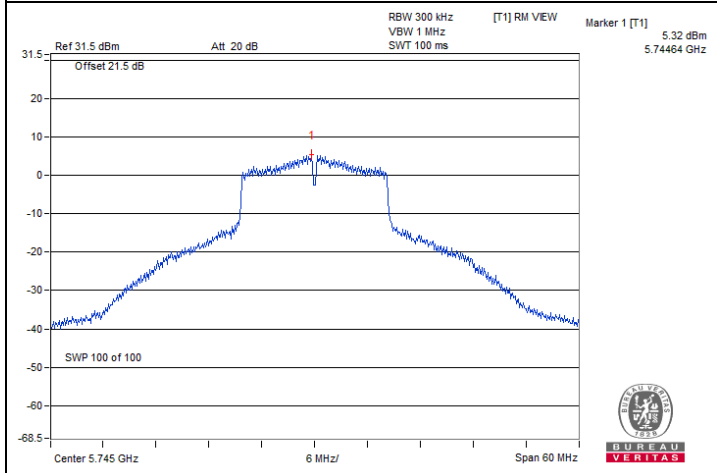

802.11a / Chain 1 : CH 149

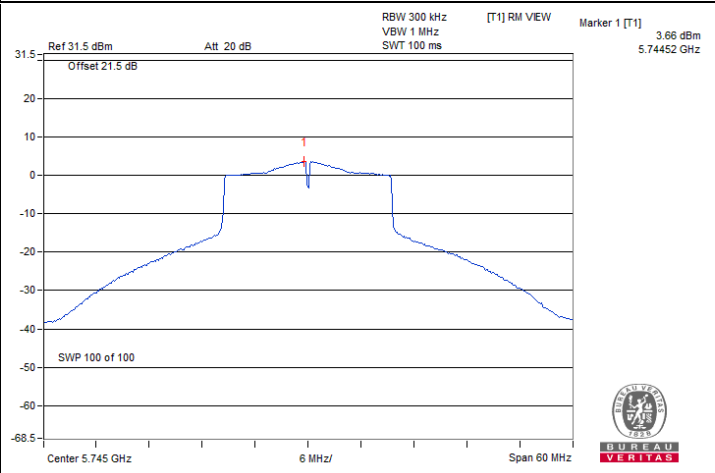

802.11ax (HE20) / Chain 1 : CH 149



Spectrum Plot of Maximum Value

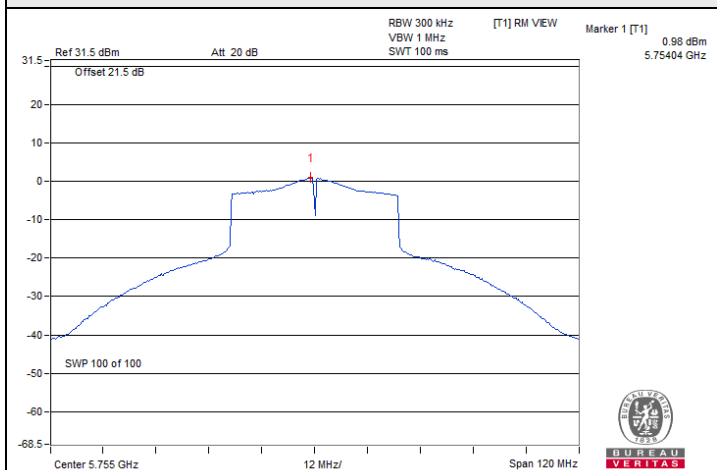

802.11ax (HE40) / Chain 1 : CH 151

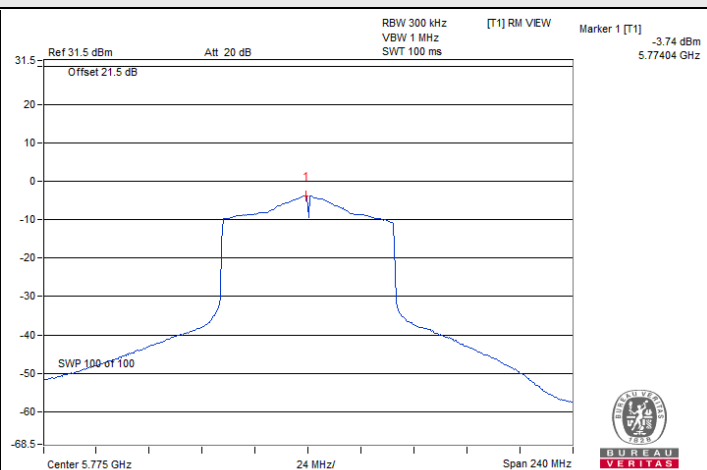

802.11ax (HE80) / Chain 1 : CH 155

7.3 6 dB Bandwidth

| | | | | | |
|--------------|--------|---------------------------|--------------|------------|-----------|
| Input Power: | 24 Vdc | Environmental Conditions: | 25°C, 60% RH | Tested By: | Katina Lu |
|--------------|--------|---------------------------|--------------|------------|-----------|

802.11a

| Channel | Frequency (MHz) | 6 dB Bandwidth (MHz) | | Minimum Limit (MHz) | Test Result |
|---------|-----------------|----------------------|---------|---------------------|-------------|
| | | Chain 0 | Chain 1 | | |
| 149 | 5745 | 15.16 | 15.18 | 0.5 | Pass |
| 157 | 5785 | 15.18 | 15.78 | 0.5 | Pass |
| 165 | 5825 | 15.79 | 15.75 | 0.5 | Pass |

802.11ax (HE20)

| Channel | Frequency (MHz) | 6 dB Bandwidth (MHz) | | Minimum Limit (MHz) | Test Result |
|---------|-----------------|----------------------|---------|---------------------|-------------|
| | | Chain 0 | Chain 1 | | |
| 149 | 5745 | 16.62 | 17.19 | 0.5 | Pass |
| 157 | 5785 | 17.02 | 18.39 | 0.5 | Pass |
| 165 | 5825 | 18.83 | 18.21 | 0.5 | Pass |

802.11ax (HE40)

| Channel | Frequency (MHz) | 6 dB Bandwidth (MHz) | | Minimum Limit (MHz) | Test Result |
|---------|-----------------|----------------------|---------|---------------------|-------------|
| | | Chain 0 | Chain 1 | | |
| 151 | 5755 | 35.94 | 35.78 | 0.5 | Pass |
| 159 | 5795 | 34.66 | 33.74 | 0.5 | Pass |

802.11ax (HE80)

| Channel | Frequency (MHz) | 6 dB Bandwidth (MHz) | | Minimum Limit (MHz) | Test Result |
|---------|-----------------|----------------------|---------|---------------------|-------------|
| | | Chain 0 | Chain 1 | | |
| 155 | 5775 | 66.44 | 60.21 | 0.5 | Pass |

Spectrum Plot of Minimum Value

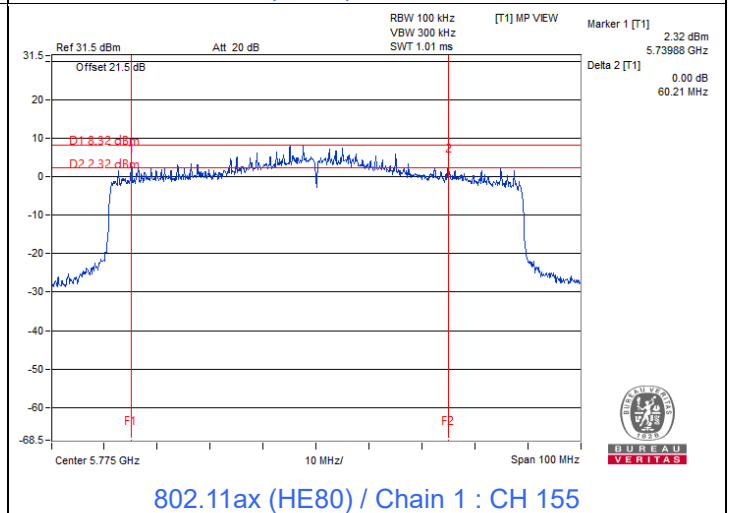
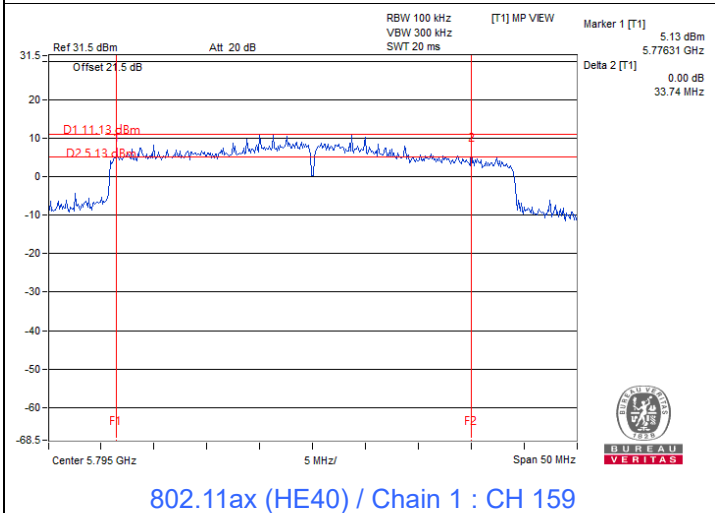
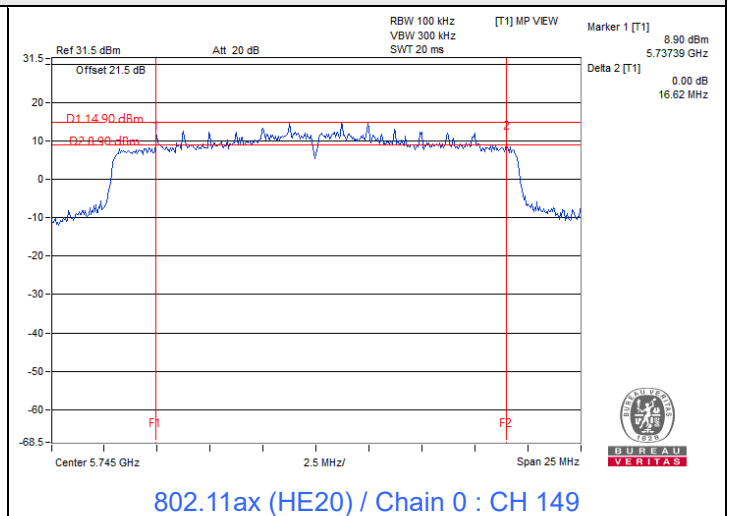
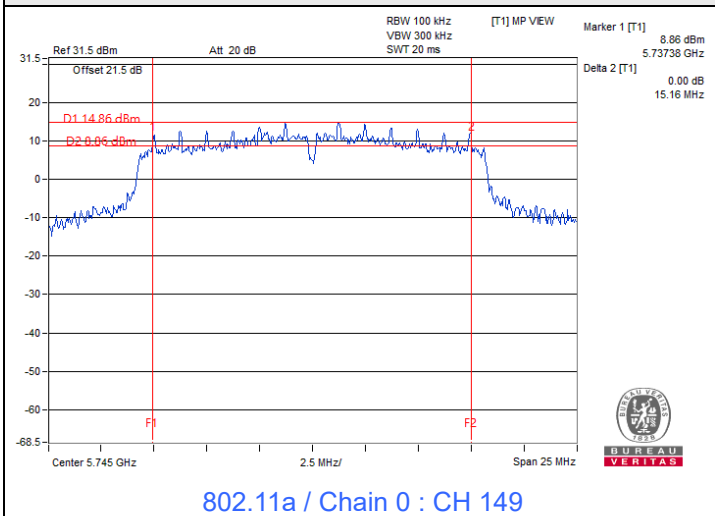

Note: For U-NII-3 straddle channel = Marker 1 + Delta 2 - 5725 MHz

7.4 Occupied Bandwidth

| | | | | | |
|--------------|--------|---------------------------|--------------|------------|-----------|
| Input Power: | 24 Vdc | Environmental Conditions: | 25°C, 60% RH | Tested By: | Katina Lu |
|--------------|--------|---------------------------|--------------|------------|-----------|

802.11a

| Channel | Frequency (MHz) | Occupied Bandwidth (MHz) | |
|---------|-----------------|--------------------------|---------|
| | | Chain 0 | Chain 1 |
| 36 | 5180 | 16.38 | 16.56 |
| 40 | 5200 | 16.92 | 17.10 |
| 48 | 5240 | 16.62 | 16.62 |
| 149 | 5745 | 18.08 | 22.96 |
| 157 | 5785 | 22.92 | 27.36 |
| 165 | 5825 | 33.00 | 26.52 |

802.11ax (HE20)

| Channel | Frequency (MHz) | Occupied Bandwidth (MHz) | |
|---------|-----------------|--------------------------|---------|
| | | Chain 0 | Chain 1 |
| 36 | 5180 | 18.78 | 18.84 |
| 40 | 5200 | 19.02 | 19.02 |
| 48 | 5240 | 19.08 | 19.02 |
| 149 | 5745 | 19.32 | 22.32 |
| 157 | 5785 | 22.32 | 27.84 |
| 165 | 5825 | 35.60 | 27.12 |

802.11ax (HE40)

| Channel | Frequency (MHz) | Occupied Bandwidth (MHz) | |
|---------|-----------------|--------------------------|---------|
| | | Chain 0 | Chain 1 |
| 38 | 5190 | 37.80 | 37.68 |
| 46 | 5230 | 38.16 | 38.16 |
| 151 | 5755 | 39.60 | 48.00 |
| 159 | 5795 | 52.32 | 53.28 |

802.11ax (HE80)

| Channel | Frequency (MHz) | Occupied Bandwidth (MHz) | |
|---------|-----------------|--------------------------|---------|
| | | Chain 0 | Chain 1 |
| 42 | 5210 | 76.56 | 76.56 |
| 155 | 5775 | 76.80 | 76.56 |



Spectrum Plot of Maximum Value

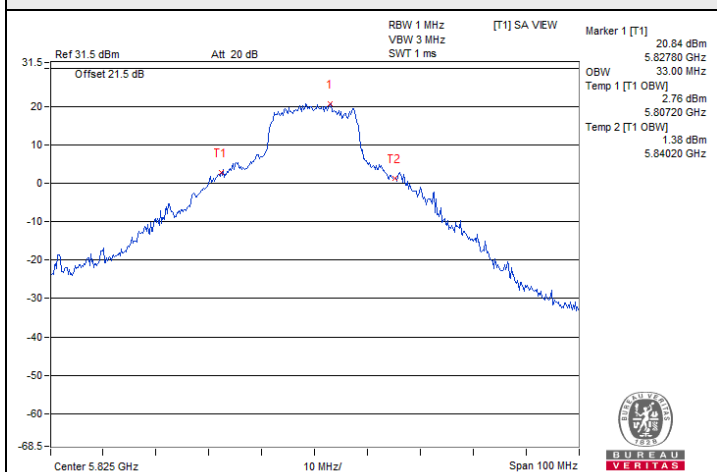

802.11a / Chain 0 : CH 165

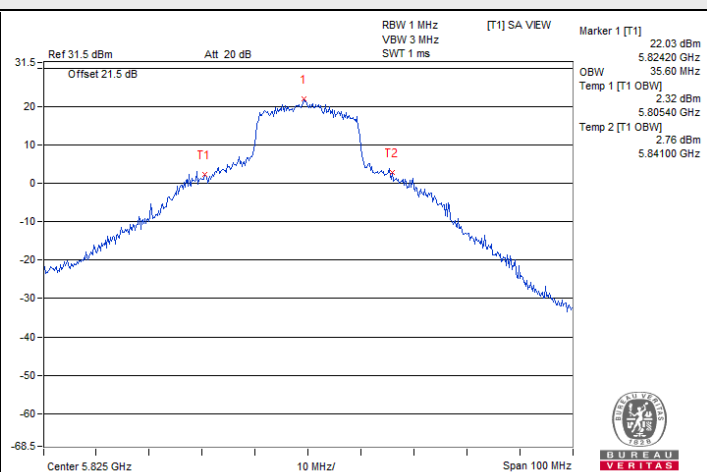

802.11ax (HE20) / Chain 0 : CH 165

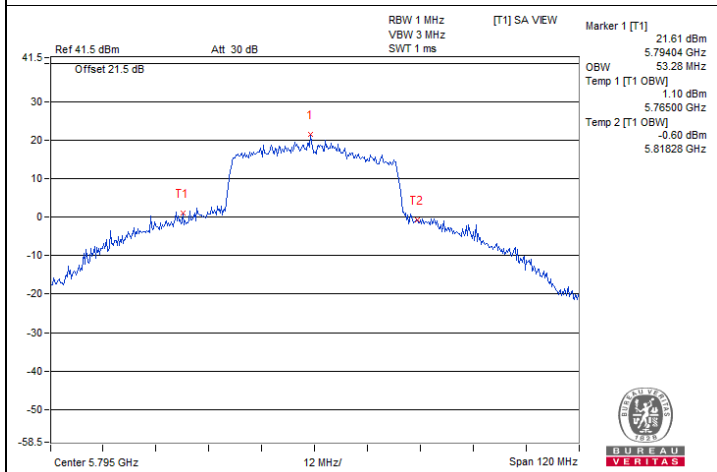

802.11ax (HE40) / Chain 1 : CH 159

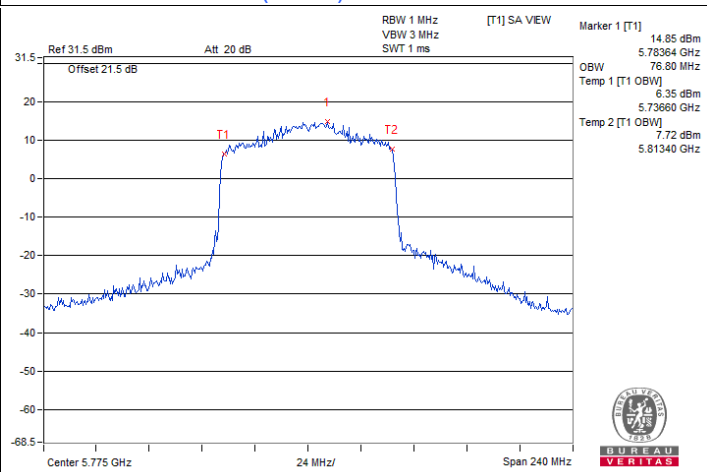

802.11ax (HE80) / Chain 0 : CH 155

Spectrum Plot for nearby DFS band (DFS is required, if 99% OCP straddle into U-NII-2A)

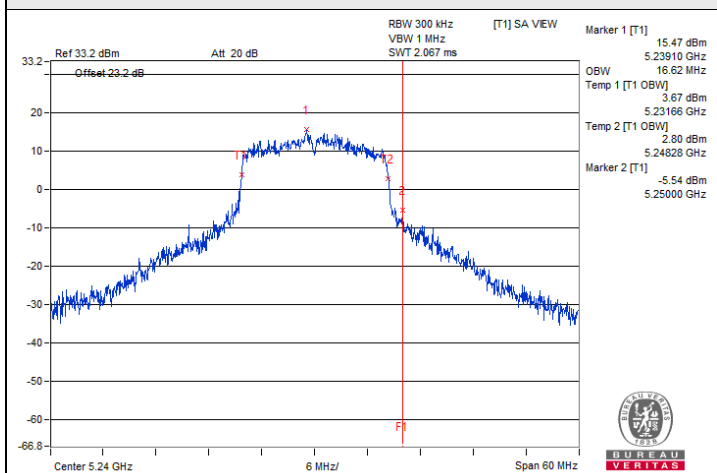

802.11a / Chain 0 : CH 48

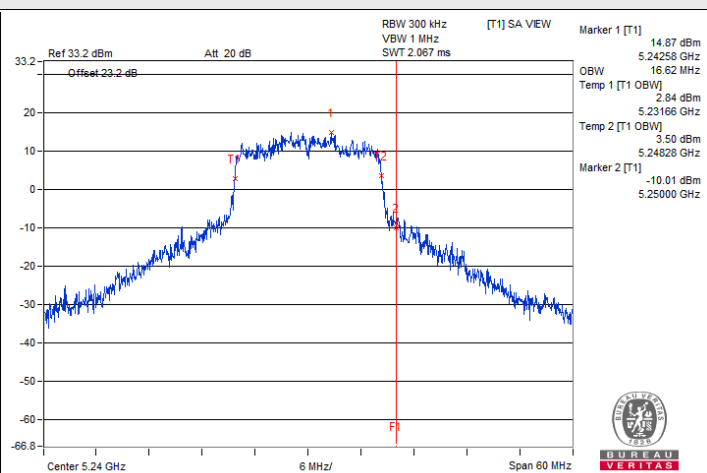

802.11a / Chain 1 : CH 48



Spectrum Plot for nearby DFS band (DFS is required, if 99% OCP straddle into U-NII-2A)

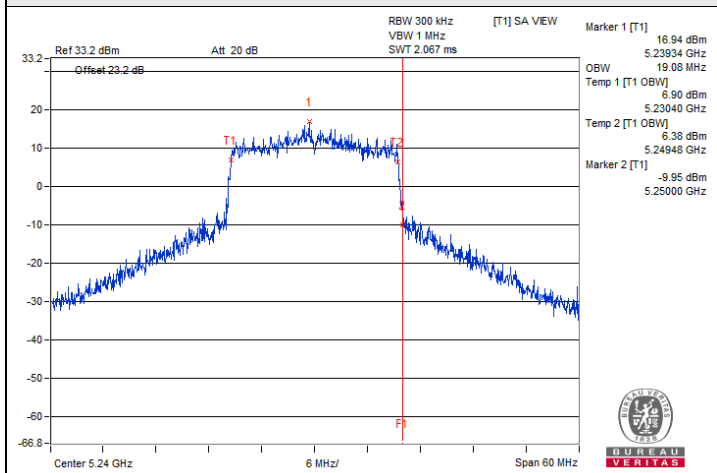

802.11ax (HE20) / Chain 0 : CH 48

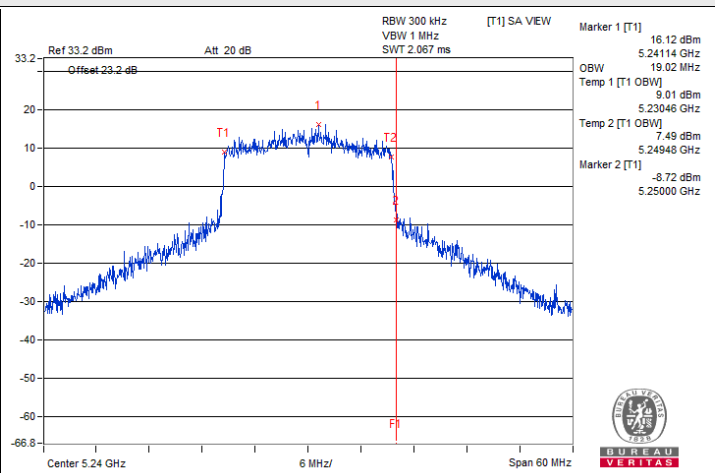

802.11ax (HE20) / Chain 1 : CH 48

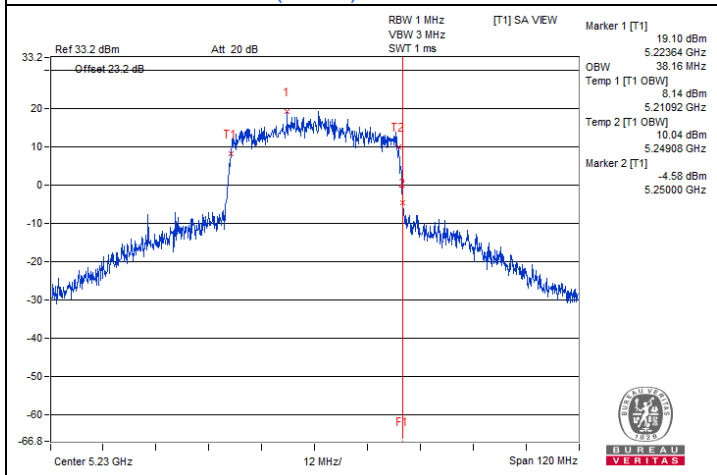

802.11ax (HE40) / Chain 0 : CH 46

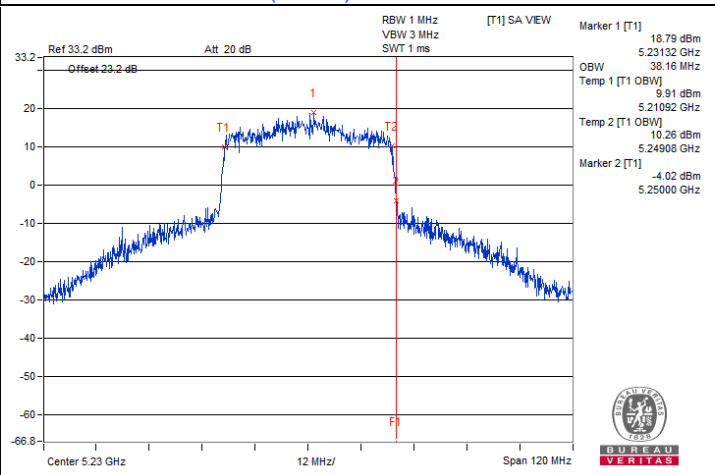

802.11ax (HE40) / Chain 1 : CH 46

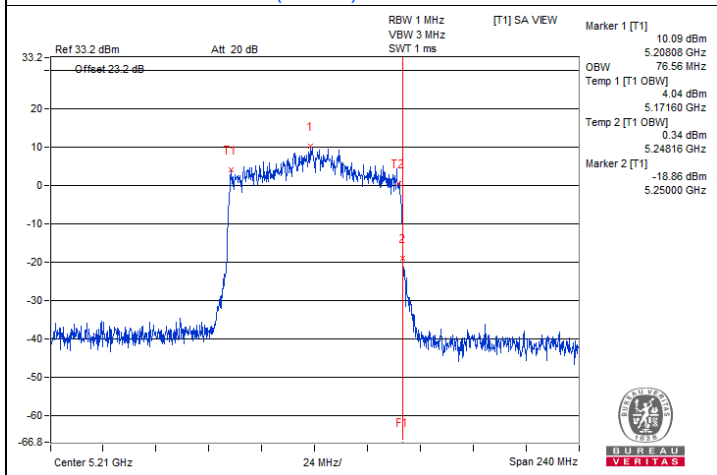

802.11ax (HE80) / Chain 0 : CH 42

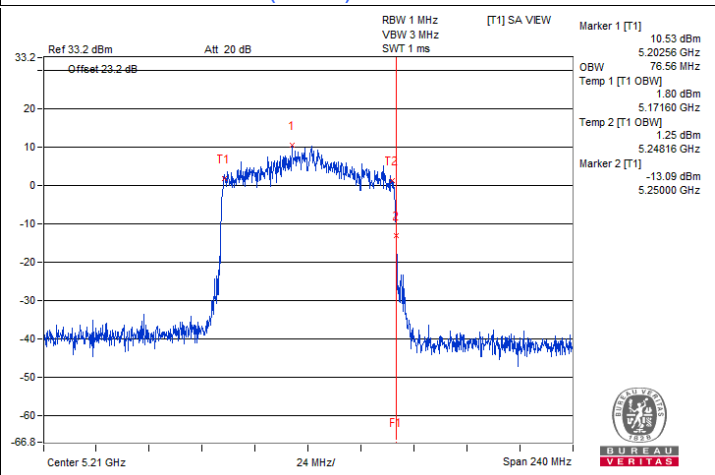

802.11ax (HE80) / Chain 1 : CH 42

Spectrum Plot for nearby DFS band (DFS is required, if 99% OCP straddle into U-NII-2C)

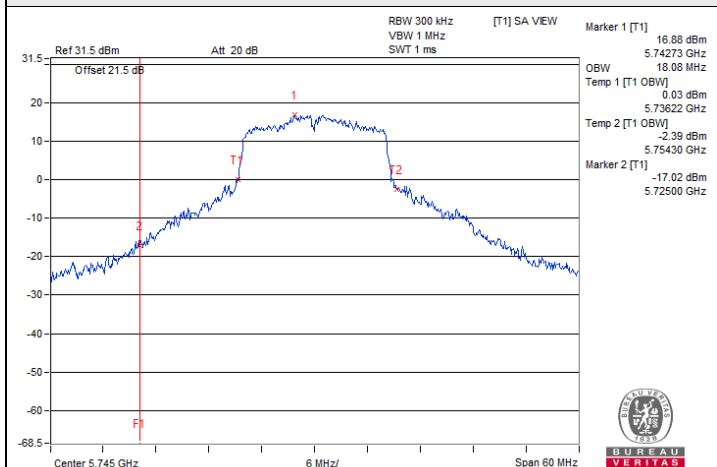

802.11a / Chain 0 : CH 149

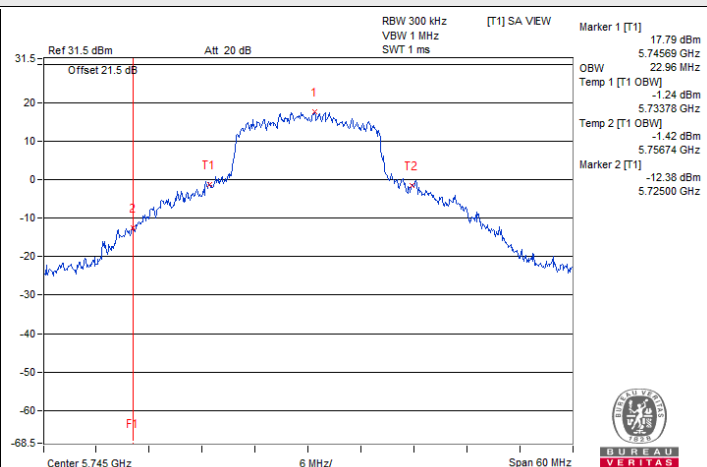

802.11a / Chain 1 : CH 149

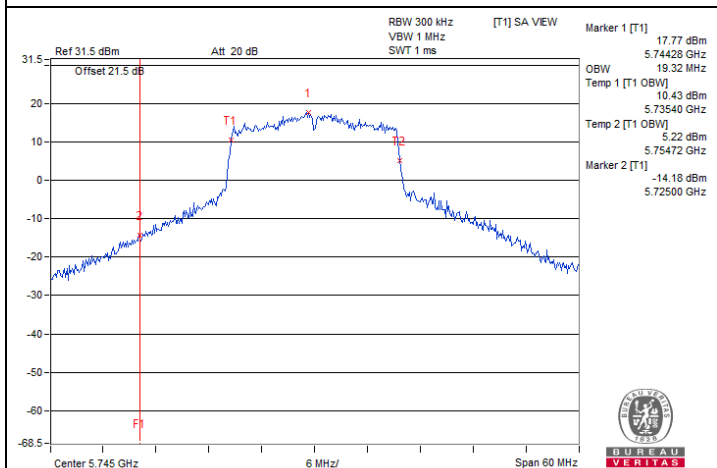

802.11ax (HE20) / Chain 0 : CH 149

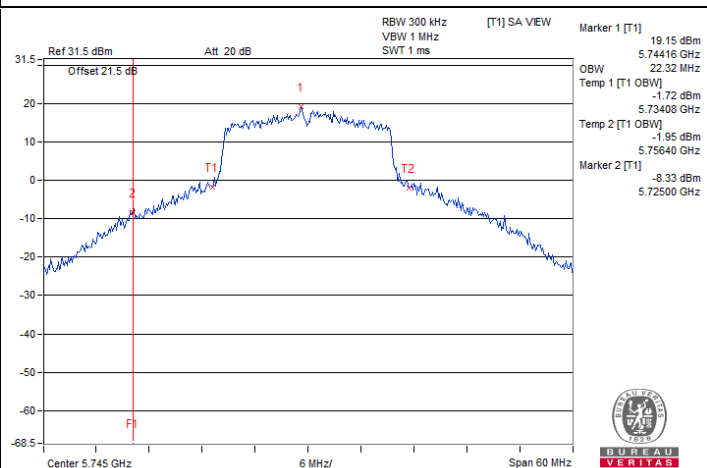

802.11ax (HE20) / Chain 1 : CH 149

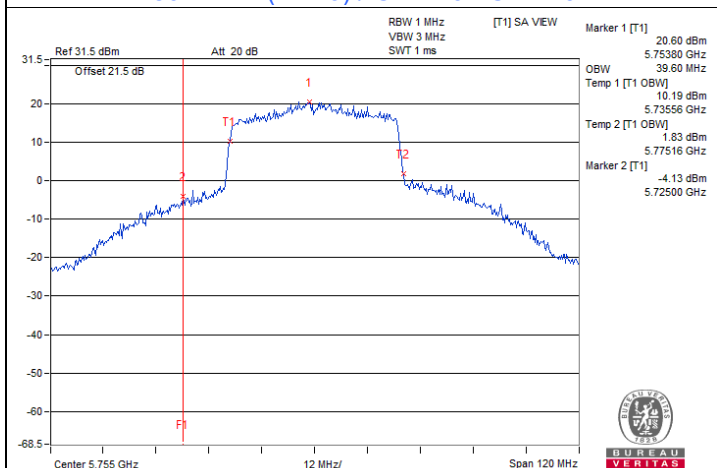

802.11ax (HE40) / Chain 0 : CH 151

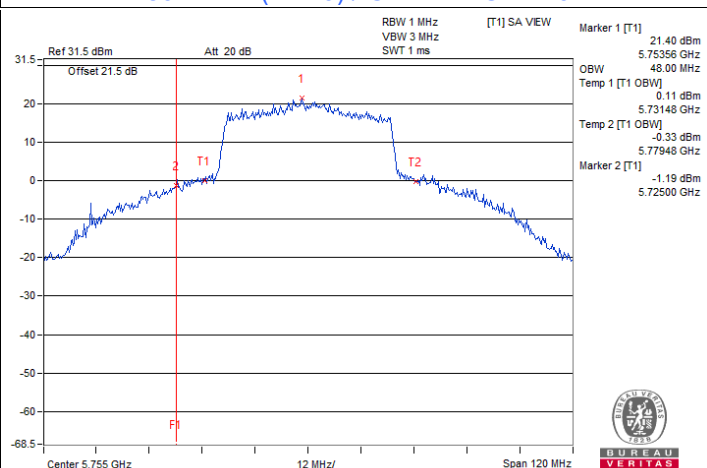

802.11ax (HE40) / Chain 1 : CH 151



Spectrum Plot for nearby DFS band (DFS is required, if 99% OCP straddle into U-NII-2C)

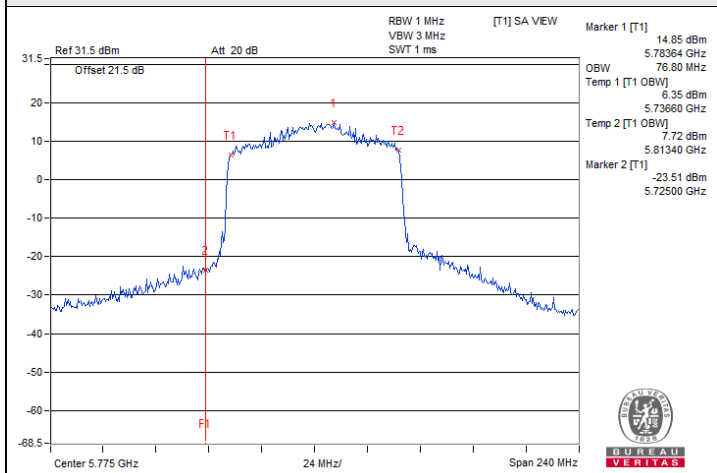

802.11ax (HE80) / Chain 0 : CH 155

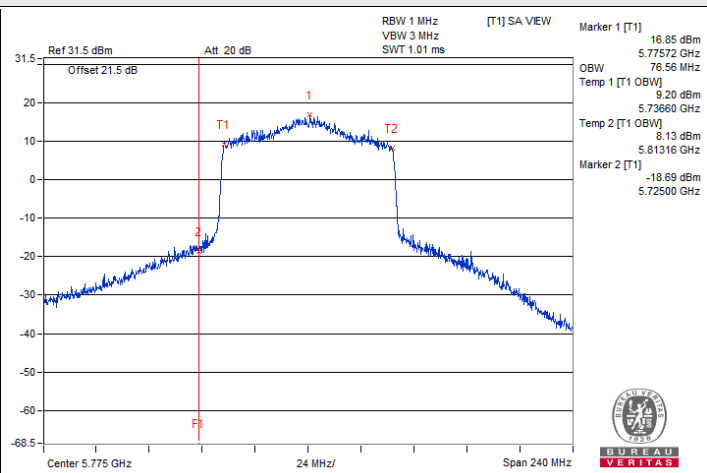

802.11ax (HE80) / Chain 1 : CH 155

7.5 Frequency Stability

| | | | | | |
|--------------|--------|---------------------------|--------------|------------|-----------|
| Input Power: | 24 Vdc | Environmental Conditions: | 25°C, 60% RH | Tested By: | Katina Lu |
|--------------|--------|---------------------------|--------------|------------|-----------|

802.11a

| Frequency Stability Versus Temperature | | | | | | | | | |
|--|--------------------|--------------------------|-------------|--------------------------|-------------|--------------------------|-------------|--------------------------|-------------|
| Operating Frequency: 5180 MHz | | | | | | | | | |
| Temp. (°C) | Power Supply (Vdc) | 0 Minute | | 2 Minutes | | 5 Minutes | | 10 Minutes | |
| | | Measured Frequency (MHz) | Test Result | Measured Frequency (MHz) | Test Result | Measured Frequency (MHz) | Test Result | Measured Frequency (MHz) | Test Result |
| 50 | 24 | 5180.008 | Pass | 5180.0069 | Pass | 5180.0089 | Pass | 5180.008 | Pass |
| 40 | 24 | 5179.9945 | Pass | 5179.9944 | Pass | 5179.9927 | Pass | 5179.9927 | Pass |
| 30 | 24 | 5179.9786 | Pass | 5179.9762 | Pass | 5179.9784 | Pass | 5179.9796 | Pass |
| 20 | 24 | 5179.9899 | Pass | 5179.9865 | Pass | 5179.9902 | Pass | 5179.9855 | Pass |
| 10 | 24 | 5180.0016 | Pass | 5180.0013 | Pass | 5180.0007 | Pass | 5180.0025 | Pass |
| 0 | 24 | 5179.9993 | Pass | 5179.9963 | Pass | 5179.9987 | Pass | 5179.9993 | Pass |

| Frequency Stability Versus Voltage | | | | | | | | | |
|------------------------------------|--------------------|--------------------------|-------------|--------------------------|-------------|--------------------------|-------------|--------------------------|-------------|
| Operating Frequency: 5180 MHz | | | | | | | | | |
| Temp. (°C) | Power Supply (Vdc) | 0 Minute | | 2 Minutes | | 5 Minutes | | 10 Minutes | |
| | | Measured Frequency (MHz) | Test Result | Measured Frequency (MHz) | Test Result | Measured Frequency (MHz) | Test Result | Measured Frequency (MHz) | Test Result |
| 20 | 27.6 | 5179.9941 | Pass | 5179.9944 | Pass | 5179.9959 | Pass | 5179.9981 | Pass |
| | 24 | 5179.9899 | Pass | 5179.9865 | Pass | 5179.9902 | Pass | 5179.9855 | Pass |
| | 20.4 | 5179.9942 | Pass | 5179.9951 | Pass | 5179.9946 | Pass | 5179.9976 | Pass |

7.6 AC Power Conducted Emissions

| | | | |
|-----------------------------|----------------|---|---------------------------------------|
| RF Mode | 802.11a | Channel | CH 149 : 5745 MHz |
| Frequency Range | 150kHz ~ 30MHz | Detector Function & Resolution Bandwidth | Quasi-Peak (QP) / Average (AV), 9 kHz |
| Input Power (System) | 120 Vac, 60 Hz | Environmental Conditions | 26°C, 68% RH |
| Tested By | Tom Yang | | |

| Phase Of Power : Line (L) | | | | | | | | | | |
|---------------------------|-----------------|------------------------|----------------------|-------|-----------------------|-------|--------------|-------|-------------|--------|
| No | Frequency (MHz) | Correction Factor (dB) | Reading Value (dBuV) | | Emission Level (dBuV) | | Limit (dBuV) | | Margin (dB) | |
| | | | Q.P. | AV. | Q.P. | AV. | Q.P. | AV. | Q.P. | AV. |
| 1 | 0.15000 | 9.97 | 43.67 | 33.40 | 53.64 | 43.37 | 66.00 | 56.00 | -12.36 | -12.63 |
| 2 | 0.22422 | 9.97 | 33.99 | 24.98 | 43.96 | 34.95 | 62.66 | 52.66 | -18.70 | -17.71 |
| 3 | 0.37266 | 9.98 | 27.66 | 24.97 | 37.64 | 34.95 | 58.44 | 48.44 | -20.80 | -13.49 |
| 4 | 0.97031 | 10.01 | 19.00 | 18.72 | 29.01 | 28.73 | 56.00 | 46.00 | -26.99 | -17.27 |
| 5 | 4.47656 | 10.20 | 20.44 | 18.74 | 30.64 | 28.94 | 56.00 | 46.00 | -25.36 | -17.06 |
| 6 | 19.86219 | 10.99 | 16.92 | 15.09 | 27.91 | 26.08 | 60.00 | 50.00 | -32.09 | -23.92 |

Remarks:

1. Q.P. and AV. are abbreviations of quasi-peak and average individually.
2. The emission levels of other frequencies were very low against the limit.
3. Margin value = Emission level – Limit value
4. Correction factor = Insertion loss + Cable loss
5. Emission Level = Correction Factor + Reading Value

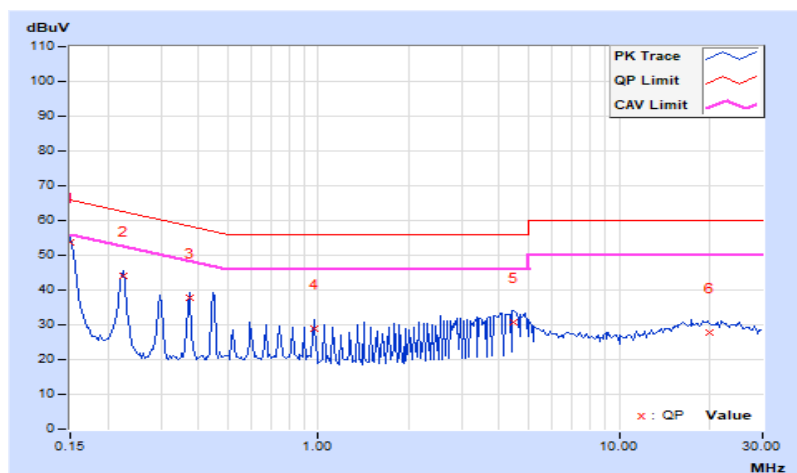

| | | | |
|----------------------|----------------|--|---------------------------------------|
| RF Mode | 802.11a | Channel | CH 149 : 5745 MHz |
| Frequency Range | 150kHz ~ 30MHz | Detector Function & Resolution Bandwidth | Quasi-Peak (QP) / Average (AV), 9 kHz |
| Input Power (System) | 120 Vac, 60 Hz | Environmental Conditions | 26°C, 68% RH |
| Tested By | Tom Yang | | |

| Phase Of Power : Neutral (N) | | | | | | | | | | |
|------------------------------|-----------------|------------------------|----------------------|--------------|-----------------------|--------------|--------------|--------------|---------------|--------------|
| No | Frequency (MHz) | Correction Factor (dB) | Reading Value (dBuV) | | Emission Level (dBuV) | | Limit (dBuV) | | Margin (dB) | |
| | | | Q.P. | AV. | Q.P. | AV. | Q.P. | AV. | Q.P. | AV. |
| 1 | 0.15000 | 10.01 | 42.82 | 33.56 | 52.83 | 43.57 | 66.00 | 56.00 | -13.17 | -12.43 |
| 2 | 0.22422 | 10.02 | 33.81 | 25.81 | 43.83 | 35.83 | 62.66 | 52.66 | -18.83 | -16.83 |
| 3 | 0.44688 | 10.03 | 28.16 | 27.72 | 38.19 | 37.75 | 56.93 | 46.93 | -18.74 | -9.18 |
| 4 | 4.25781 | 10.22 | 22.91 | 21.99 | 33.13 | 32.21 | 56.00 | 46.00 | -22.87 | -13.79 |
| 5 | 7.76953 | 10.37 | 13.80 | 11.02 | 24.17 | 21.39 | 60.00 | 50.00 | -35.83 | -28.61 |
| 6 | 22.78125 | 10.84 | 12.26 | 6.85 | 23.10 | 17.69 | 60.00 | 50.00 | -36.90 | -32.31 |

Remarks:

1. Q.P. and AV. are abbreviations of quasi-peak and average individually.
2. The emission levels of other frequencies were very low against the limit.
3. Margin value = Emission level – Limit value
4. Correction factor = Insertion loss + Cable loss
5. Emission Level = Correction Factor + Reading Value

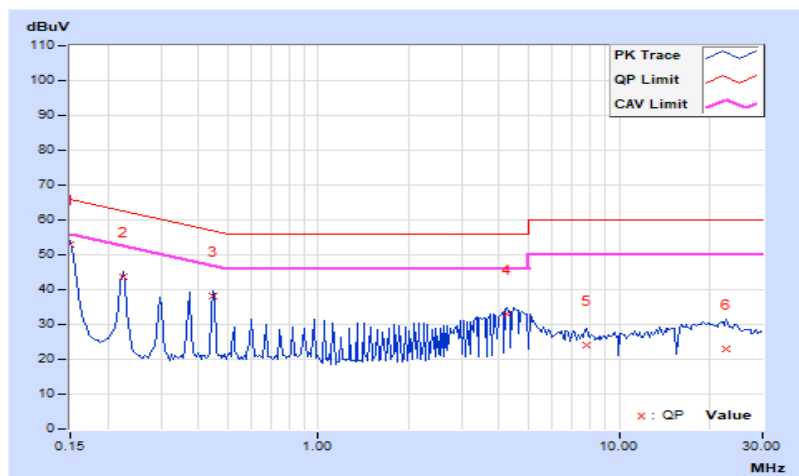

7.7 Unwanted Emissions below 1 GHz

| | | | |
|-----------------------------|----------------|--|------------------------------|
| RF Mode | 802.11a | Channel | CH 149 : 5745 MHz |
| Frequency Range | 30 MHz ~ 1 GHz | Detector Function & Bandwidth | Quasi-Peak (QP), RB = 120kHz |
| Input Power (System) | 120 Vac, 60 Hz | Environmental Conditions | 25°C, 71% RH |
| Tested By | Nick Tsou | | |

Antenna Polarity & Test Distance : Horizontal at 3 m

| No | Frequency (MHz) | Emission Level (dBuV/m) | Limit (dBuV/m) | Margin (dB) | Antenna Height (m) | Table Angle (Degree) | Raw Value (dBuV) | Correction Factor (dB/m) |
|----|-----------------|-------------------------|----------------|-------------|--------------------|----------------------|------------------|--------------------------|
| 1 | 64.53 | 23.4 QP | 40.0 | -16.6 | 2.00 H | 122 | 37.1 | -13.7 |
| 2 | 151.64 | 24.4 QP | 43.5 | -19.1 | 1.50 H | 91 | 36.9 | -12.5 |
| 3 | 190.64 | 21.0 QP | 43.5 | -22.5 | 1.50 H | 360 | 36.3 | -15.3 |
| 4 | 584.87 | 29.6 QP | 46.0 | -16.4 | 1.50 H | 205 | 35.0 | -5.4 |
| 5 | 875.06 | 34.9 QP | 46.0 | -11.1 | 1.00 H | 145 | 36.1 | -1.2 |
| 6 | 1000.00 | 37.7 QP | 54.0 | -16.3 | 1.50 H | 75 | 37.5 | 0.2 |

Remarks:

1. Emission Level(dBuV/m) = Raw Value(dBuV) + Correction Factor(dB/m)
2. Correction Factor(dB/m) = Antenna Factor(dB/m) + Cable Factor(dB) – Pre-Amplifier Factor(dB)
3. Margin value = Emission Level – Limit value
4. The other emission levels were very low against the limit of frequency range 30 MHz ~ 1 GHz.
5. The frequency range 9 kHz ~ 30 MHz: all emissions are more than 20 dB below the limit, therefore do not be recorded in this report.

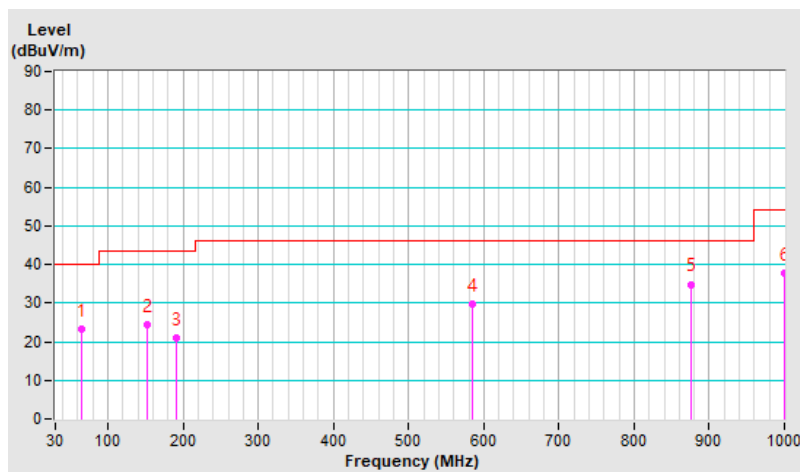

| | | | |
|-----------------------------|----------------|--|------------------------------|
| RF Mode | 802.11a | Channel | CH 149 : 5745 MHz |
| Frequency Range | 30 MHz ~ 1 GHz | Detector Function & Bandwidth | Quasi-Peak (QP), RB = 120kHz |
| Input Power (System) | 120 Vac, 60 Hz | Environmental Conditions | 25°C, 71% RH |
| Tested By | Nick Tsou | | |

| Antenna Polarity & Test Distance : Vertical at 3 m | | | | | | | | |
|--|-----------------|-------------------------|----------------|--------------|--------------------|----------------------|------------------|--------------------------|
| No | Frequency (MHz) | Emission Level (dBuV/m) | Limit (dBuV/m) | Margin (dB) | Antenna Height (m) | Table Angle (Degree) | Raw Value (dBuV) | Correction Factor (dB/m) |
| 1 | 30.00 | 23.6 QP | 40.0 | -16.4 | 1.50 V | 43 | 37.4 | -13.8 |
| 2 | 63.42 | 26.2 QP | 40.0 | -13.8 | 1.00 V | 244 | 39.5 | -13.3 |
| 3 | 150.92 | 26.0 QP | 43.5 | -17.5 | 1.00 V | 124 | 38.4 | -12.4 |
| 4 | 635.65 | 29.6 QP | 46.0 | -16.4 | 1.50 V | 122 | 34.2 | -4.6 |
| 5 | 875.06 | 35.6 QP | 46.0 | -10.4 | 1.00 V | 284 | 36.8 | -1.2 |
| 6 | 1000.00 | 38.4 QP | 54.0 | -15.6 | 2.00 V | 194 | 38.2 | 0.2 |

Remarks:

1. Emission Level(dBuV/m) = Raw Value(dBuV) + Correction Factor(dB/m)
2. Correction Factor(dB/m) = Antenna Factor(dB/m) + Cable Factor(dB) – Pre-Amplifier Factor(dB)
3. Margin value = Emission Level – Limit value
4. The other emission levels were very low against the limit of frequency range 30 MHz ~ 1 GHz.
5. The frequency range 9 kHz ~ 30 MHz: all emissions are more than 20 dB below the limit, therefore do not be recorded in this report.

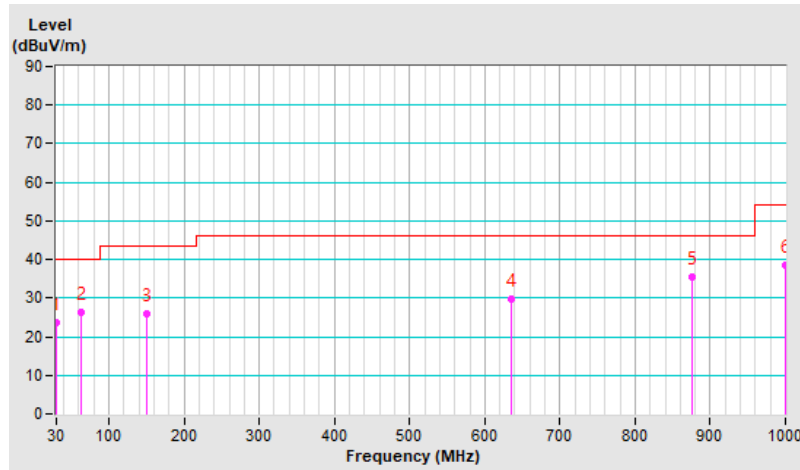

7.8 Unwanted Emissions above 1 GHz

| | | | |
|----------------------|----------------|-------------------------------|--|
| RF Mode | 802.11a | Channel | CH 36 : 5180 MHz |
| Frequency Range | 1 GHz ~ 40 GHz | Detector Function & Bandwidth | Peak (PK), RB = 1 MHz, VB = 3 MHz Peak (AV), RB = 1 MHz, VB = 10 Hz |
| Input Power (System) | 120 Vac, 60 Hz | Environmental Conditions | 25°C, 75% RH |
| Tested By | Sampson Chen | | |

| Antenna Polarity & Test Distance : Horizontal at 3 m | | | | | | | | |
|--|-----------------|-------------------------|----------------|-------------|--------------------|----------------------|------------------|--------------------------|
| No | Frequency (MHz) | Emission Level (dBuV/m) | Limit (dBuV/m) | Margin (dB) | Antenna Height (m) | Table Angle (Degree) | Raw Value (dBuV) | Correction Factor (dB/m) |
| 1 | 5150.00 | 57.5 PK | 74.0 | -16.5 | 1.41 H | 330 | 53.9 | 3.6 |
| 2 | 5150.00 | 53.2 AV | 54.0 | -0.8 | 1.41 H | 330 | 49.6 | 3.6 |
| 3 | *5180.00 | 113.5 PK | | | 1.41 H | 330 | 110.1 | 3.4 |
| 4 | *5180.00 | 107.3 AV | | | 1.41 H | 330 | 103.9 | 3.4 |
| 5 | #10360.00 | 39.2 PK | 68.2 | -29.0 | 1.43 H | 336 | 25.4 | 13.8 |
| 6 | 15540.00 | 47.0 PK | 74.0 | -27.0 | 1.50 H | 232 | 31.5 | 15.5 |
| 7 | 15540.00 | 34.0 AV | 54.0 | -20.0 | 1.50 H | 232 | 18.5 | 15.5 |

Remarks:

1. Emission Level(dBuV/m) = Raw Value(dBuV) + Correction Factor(dB/m)
2. Correction Factor(dB/m) = Antenna Factor(dB/m) + Cable Factor(dB) – Pre-Amplifier Factor(dB)
3. Margin value = Emission Level – Limit value
4. The other emission levels were very low against the limit.
5. " * " : Fundamental frequency, the limit was restricted at the RF Output Power.
6. " # " : The radiated frequency is out of the restricted band.

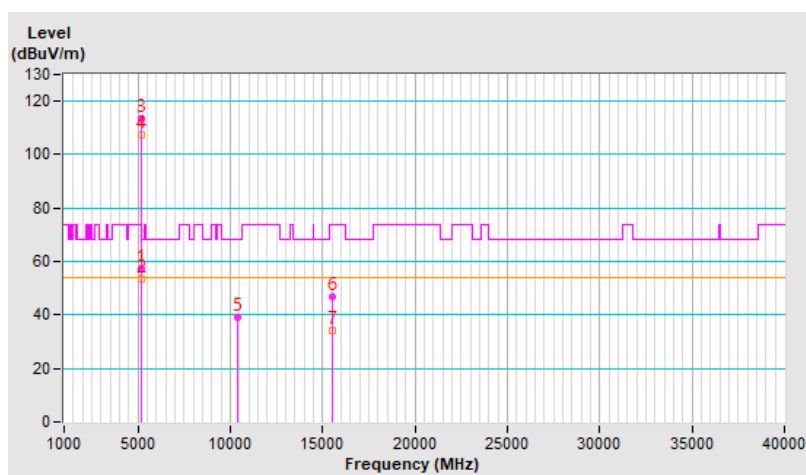

| | | | |
|-----------------------------|----------------|--|--|
| RF Mode | 802.11a | Channel | CH 36 : 5180 MHz |
| Frequency Range | 1 GHz ~ 40 GHz | Detector Function & Bandwidth | Peak (PK), RB = 1 MHz, VB = 3 MHz Peak (AV), RB = 1 MHz, VB = 10 Hz |
| Input Power (System) | 120 Vac, 60 Hz | Environmental Conditions | 25°C, 75% RH |
| Tested By | Sampson Chen | | |

| Antenna Polarity & Test Distance : Vertical at 3 m | | | | | | | | |
|--|-----------------|-------------------------|----------------|-------------|--------------------|----------------------|------------------|--------------------------|
| No | Frequency (MHz) | Emission Level (dBuV/m) | Limit (dBuV/m) | Margin (dB) | Antenna Height (m) | Table Angle (Degree) | Raw Value (dBuV) | Correction Factor (dB/m) |
| 1 | 5150.00 | 64.9 PK | 74.0 | -9.1 | 2.80 V | 61 | 61.3 | 3.6 |
| 2 | 5150.00 | 53.7 AV | 54.0 | -0.3 | 2.80 V | 61 | 50.1 | 3.6 |
| 3 | *5180.00 | 118.8 PK | | | 2.80 V | 61 | 115.4 | 3.4 |
| 4 | *5180.00 | 109.8 AV | | | 2.80 V | 61 | 106.4 | 3.4 |
| 5 | #10360.00 | 46.5 PK | 68.2 | -21.7 | 2.12 V | 217 | 32.7 | 13.8 |
| 6 | 15540.00 | 50.1 PK | 74.0 | -23.9 | 1.54 V | 144 | 34.6 | 15.5 |
| 7 | 15540.00 | 39.6 AV | 54.0 | -14.4 | 1.54 V | 144 | 24.1 | 15.5 |

Remarks:

1. Emission Level(dBuV/m) = Raw Value(dBuV) + Correction Factor(dB/m)
2. Correction Factor(dB/m) = Antenna Factor(dB/m) + Cable Factor(dB) – Pre-Amplifier Factor(dB)
3. Margin value = Emission Level – Limit value
4. The other emission levels were very low against the limit.
5. " * " : Fundamental frequency, the limit was restricted at the RF Output Power.
6. " # " : The radiated frequency is out of the restricted band.

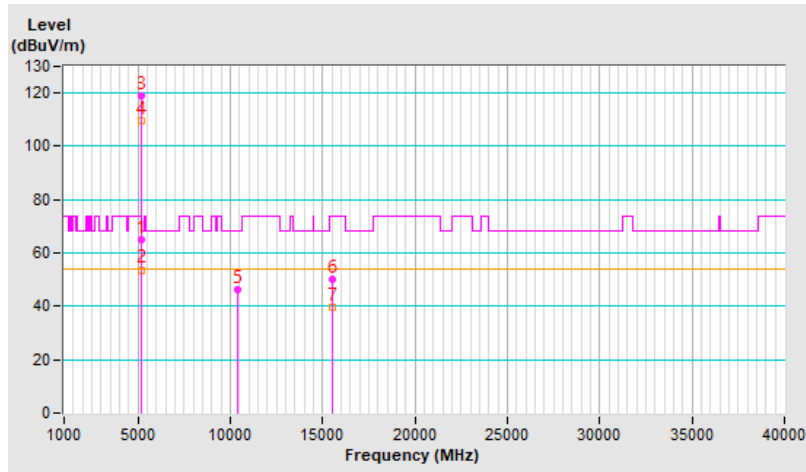

| | | | |
|-----------------------------|----------------|--|--|
| RF Mode | 802.11a | Channel | CH 40 : 5200 MHz |
| Frequency Range | 1 GHz ~ 40 GHz | Detector Function & Bandwidth | Peak (PK), RB = 1 MHz, VB = 3 MHz Peak (AV), RB = 1 MHz, VB = 10 Hz |
| Input Power (System) | 120 Vac, 60 Hz | Environmental Conditions | 25°C, 75% RH |
| Tested By | Sampson Chen | | |

| Antenna Polarity & Test Distance : Horizontal at 3 m | | | | | | | | |
|--|-----------------|-------------------------|----------------|-------------|--------------------|----------------------|------------------|--------------------------|
| No | Frequency (MHz) | Emission Level (dBuV/m) | Limit (dBuV/m) | Margin (dB) | Antenna Height (m) | Table Angle (Degree) | Raw Value (dBuV) | Correction Factor (dB/m) |
| 1 | 5150.00 | 61.9 PK | 74.0 | -12.1 | 1.38 H | 335 | 58.3 | 3.6 |
| 2 | 5150.00 | 50.1 AV | 54.0 | -3.9 | 1.38 H | 335 | 46.5 | 3.6 |
| 3 | *5200.00 | 119.9 PK | | | 1.38 H | 335 | 116.5 | 3.4 |
| 4 | *5200.00 | 110.4 AV | | | 1.38 H | 335 | 107.0 | 3.4 |
| 5 | #10400.00 | 38.6 PK | 68.2 | -29.6 | 1.40 H | 335 | 24.6 | 14.0 |
| 6 | 15600.00 | 47.3 PK | 74.0 | -26.7 | 1.50 H | 244 | 31.7 | 15.6 |
| 7 | 15600.00 | 34.0 AV | 54.0 | -20.0 | 1.50 H | 244 | 18.4 | 15.6 |

Remarks:

1. Emission Level(dBuV/m) = Raw Value(dBuV) + Correction Factor(dB/m)
2. Correction Factor(dB/m) = Antenna Factor(dB/m) + Cable Factor(dB) – Pre-Amplifier Factor(dB)
3. Margin value = Emission Level – Limit value
4. The other emission levels were very low against the limit.
5. " * " : Fundamental frequency, the limit was restricted at the RF Output Power.
6. " # " : The radiated frequency is out of the restricted band.

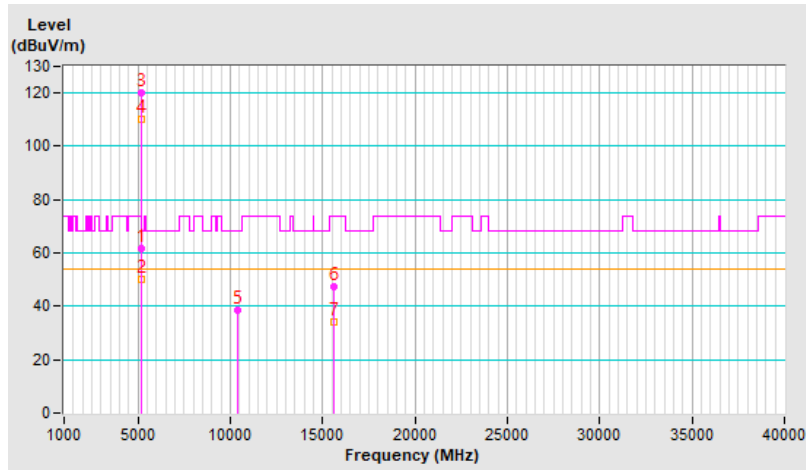

| | | | |
|-----------------------------|----------------|--|--|
| RF Mode | 802.11a | Channel | CH 40 : 5200 MHz |
| Frequency Range | 1 GHz ~ 40 GHz | Detector Function & Bandwidth | Peak (PK), RB = 1 MHz, VB = 3 MHz Peak (AV), RB = 1 MHz, VB = 10 Hz |
| Input Power (System) | 120 Vac, 60 Hz | Environmental Conditions | 25°C, 75% RH |
| Tested By | Sampson Chen | | |

| Antenna Polarity & Test Distance : Vertical at 3 m | | | | | | | | |
|--|-----------------|-------------------------|----------------|-------------|--------------------|----------------------|------------------|--------------------------|
| No | Frequency (MHz) | Emission Level (dBuV/m) | Limit (dBuV/m) | Margin (dB) | Antenna Height (m) | Table Angle (Degree) | Raw Value (dBuV) | Correction Factor (dB/m) |
| 1 | 5150.00 | 65.6 PK | 74.0 | -8.4 | 2.78 V | 62 | 62.0 | 3.6 |
| 2 | 5150.00 | 53.9 AV | 54.0 | -0.1 | 2.78 V | 62 | 50.3 | 3.6 |
| 3 | *5200.00 | 122.2 PK | | | 2.78 V | 62 | 118.8 | 3.4 |
| 4 | *5200.00 | 113.2 AV | | | 2.78 V | 62 | 109.8 | 3.4 |
| 5 | #10400.00 | 46.8 PK | 68.2 | -21.4 | 2.17 V | 233 | 32.8 | 14.0 |
| 6 | 15600.00 | 50.2 PK | 74.0 | -23.8 | 1.55 V | 137 | 34.6 | 15.6 |
| 7 | 15600.00 | 39.6 AV | 54.0 | -14.4 | 1.55 V | 137 | 24.0 | 15.6 |

Remarks:

1. Emission Level(dBuV/m) = Raw Value(dBuV) + Correction Factor(dB/m)
2. Correction Factor(dB/m) = Antenna Factor(dB/m) + Cable Factor(dB) – Pre-Amplifier Factor(dB)
3. Margin value = Emission Level – Limit value
4. The other emission levels were very low against the limit.
5. " * ": Fundamental frequency, the limit was restricted at the RF Output Power.
6. " # ": The radiated frequency is out of the restricted band.

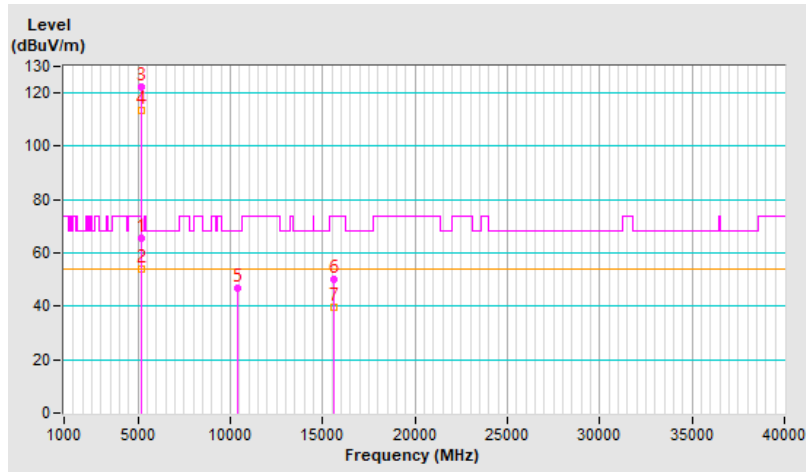

| | | | |
|-----------------------------|----------------|--|--|
| RF Mode | 802.11a | Channel | CH 48 : 5240 MHz |
| Frequency Range | 1 GHz ~ 40 GHz | Detector Function & Bandwidth | Peak (PK), RB = 1 MHz, VB = 3 MHz Peak (AV), RB = 1 MHz, VB = 10 Hz |
| Input Power (System) | 120 Vac, 60 Hz | Environmental Conditions | 25°C, 75% RH |
| Tested By | Sampson Chen | | |

| Antenna Polarity & Test Distance : Horizontal at 3 m | | | | | | | | |
|--|-----------------|-------------------------|----------------|-------------|--------------------|----------------------|------------------|--------------------------|
| No | Frequency (MHz) | Emission Level (dBuV/m) | Limit (dBuV/m) | Margin (dB) | Antenna Height (m) | Table Angle (Degree) | Raw Value (dBuV) | Correction Factor (dB/m) |
| 1 | *5240.00 | 119.0 PK | | | 1.38 H | 334 | 115.7 | 3.3 |
| 2 | *5240.00 | 110.5 AV | | | 1.38 H | 334 | 107.2 | 3.3 |
| 3 | 5350.00 | 50.6 PK | 74.0 | -23.4 | 1.38 H | 334 | 47.3 | 3.3 |
| 4 | 5350.00 | 40.5 AV | 54.0 | -13.5 | 1.38 H | 334 | 37.2 | 3.3 |
| 5 | #10480.00 | 38.8 PK | 68.2 | -29.4 | 1.41 H | 336 | 24.7 | 14.1 |
| 6 | 15720.00 | 47.8 PK | 74.0 | -26.2 | 1.46 H | 230 | 33.9 | 13.9 |
| 7 | 15720.00 | 34.4 AV | 54.0 | -19.6 | 1.46 H | 230 | 20.5 | 13.9 |

Remarks:

1. Emission Level(dBuV/m) = Raw Value(dBuV) + Correction Factor(dB/m)
2. Correction Factor(dB/m) = Antenna Factor(dB/m) + Cable Factor(dB) – Pre-Amplifier Factor(dB)
3. Margin value = Emission Level – Limit value
4. The other emission levels were very low against the limit.
5. " * " : Fundamental frequency, the limit was restricted at the RF Output Power.
6. " # " : The radiated frequency is out of the restricted band.

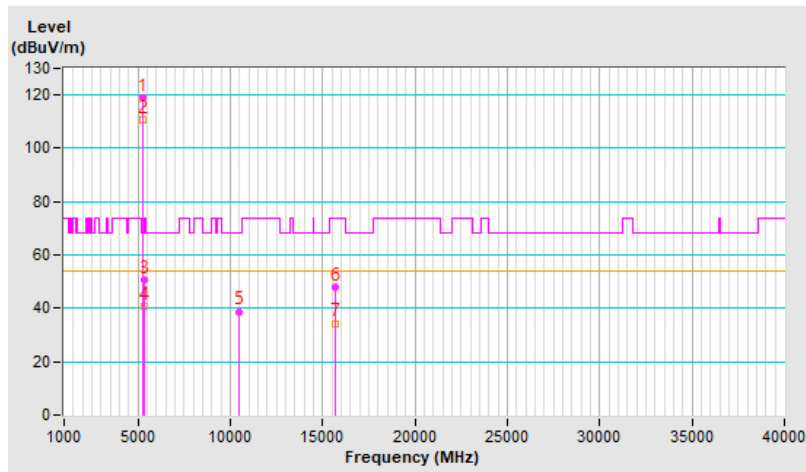

| | | | |
|-----------------------------|----------------|--|--|
| RF Mode | 802.11a | Channel | CH 48 : 5240 MHz |
| Frequency Range | 1 GHz ~ 40 GHz | Detector Function & Bandwidth | Peak (PK), RB = 1 MHz, VB = 3 MHz Peak (AV), RB = 1 MHz, VB = 10 Hz |
| Input Power (System) | 120 Vac, 60 Hz | Environmental Conditions | 25°C, 75% RH |
| Tested By | Sampson Chen | | |

| Antenna Polarity & Test Distance : Vertical at 3 m | | | | | | | | |
|--|-----------------|-------------------------|----------------|-------------|--------------------|----------------------|------------------|--------------------------|
| No | Frequency (MHz) | Emission Level (dBuV/m) | Limit (dBuV/m) | Margin (dB) | Antenna Height (m) | Table Angle (Degree) | Raw Value (dBuV) | Correction Factor (dB/m) |
| 1 | *5240.00 | 121.5 PK | | | 2.78 V | 59 | 118.2 | 3.3 |
| 2 | *5240.00 | 112.7 AV | | | 2.78 V | 59 | 109.4 | 3.3 |
| 3 | 5350.00 | 51.3 PK | 74.0 | -22.7 | 2.78 V | 59 | 48.0 | 3.3 |
| 4 | 5350.00 | 41.0 AV | 54.0 | -13.0 | 2.78 V | 59 | 37.7 | 3.3 |
| 5 | #10480.00 | 46.9 PK | 68.2 | -21.3 | 2.21 V | 224 | 32.8 | 14.1 |
| 6 | 15720.00 | 49.9 PK | 74.0 | -24.1 | 1.57 V | 141 | 36.0 | 13.9 |
| 7 | 15720.00 | 39.3 AV | 54.0 | -14.7 | 1.57 V | 141 | 25.4 | 13.9 |

Remarks:

1. Emission Level(dBuV/m) = Raw Value(dBuV) + Correction Factor(dB/m)
2. Correction Factor(dB/m) = Antenna Factor(dB/m) + Cable Factor(dB) – Pre-Amplifier Factor(dB)
3. Margin value = Emission Level – Limit value
4. The other emission levels were very low against the limit.
5. " * " : Fundamental frequency, the limit was restricted at the RF Output Power.
6. " # " : The radiated frequency is out of the restricted band.

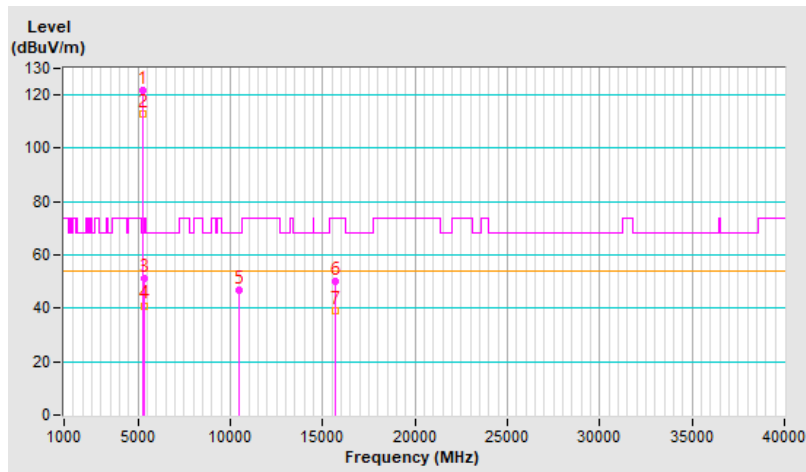

| | | | |
|-----------------------------|----------------|--|--|
| RF Mode | 802.11a | Channel | CH 149 : 5745 MHz |
| Frequency Range | 1 GHz ~ 40 GHz | Detector Function & Bandwidth | Peak (PK), RB = 1 MHz, VB = 3 MHz Peak (AV), RB = 1 MHz, VB = 10 Hz |
| Input Power (System) | 120 Vac, 60 Hz | Environmental Conditions | 20°C, 69% RH |
| Tested By | Sampson Chen | | |

| Antenna Polarity & Test Distance : Horizontal at 3 m | | | | | | | | |
|--|-----------------|-------------------------|----------------|-------------|--------------------|----------------------|------------------|--------------------------|
| No | Frequency (MHz) | Emission Level (dBuV/m) | Limit (dBuV/m) | Margin (dB) | Antenna Height (m) | Table Angle (Degree) | Raw Value (dBuV) | Correction Factor (dB/m) |
| 1 | #5648.75 | 52.2 PK | 68.2 | -16.0 | 1.46 H | 350 | 47.8 | 4.4 |
| 2 | *5745.00 | 122.0 PK | | | 1.46 H | 350 | 117.6 | 4.4 |
| 3 | *5745.00 | 112.2 AV | | | 1.46 H | 350 | 107.8 | 4.4 |
| 4 | #5936.67 | 50.1 PK | 68.2 | -18.1 | 1.46 H | 350 | 45.1 | 5.0 |
| 5 | 11490.00 | 60.6 PK | 74.0 | -13.4 | 1.29 H | 59 | 45.3 | 15.3 |
| 6 | 11490.00 | 48.8 AV | 54.0 | -5.2 | 1.29 H | 59 | 33.5 | 15.3 |
| 7 | #17235.00 | 54.0 PK | 68.2 | -14.2 | 1.50 H | 51 | 37.8 | 16.2 |

Remarks:

1. Emission Level(dBuV/m) = Raw Value(dBuV) + Correction Factor(dB/m)
2. Correction Factor(dB/m) = Antenna Factor(dB/m) + Cable Factor(dB) – Pre-Amplifier Factor(dB)
3. Margin value = Emission Level – Limit value
4. The other emission levels were very low against the limit.
5. " * " : Fundamental frequency, the limit was restricted at the RF Output Power.
6. " # " : The radiated frequency is out of the restricted band.

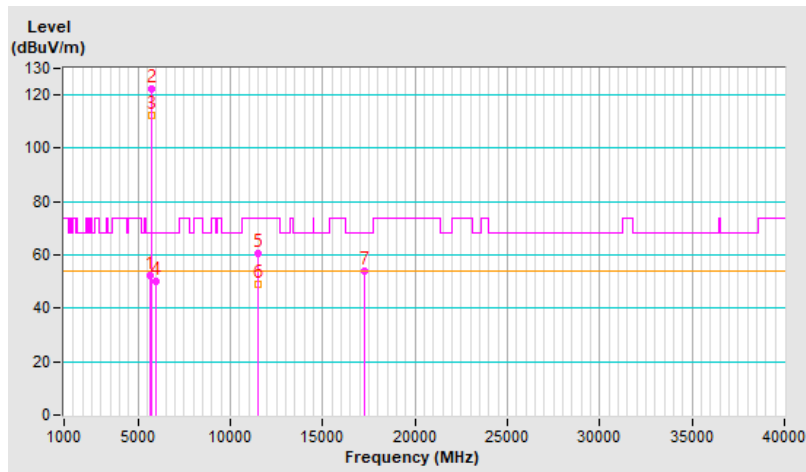

| | | | |
|-----------------------------|----------------|--|--|
| RF Mode | 802.11a | Channel | CH 149 : 5745 MHz |
| Frequency Range | 1 GHz ~ 40 GHz | Detector Function & Bandwidth | Peak (PK), RB = 1 MHz, VB = 3 MHz Peak (AV), RB = 1 MHz, VB = 10 Hz |
| Input Power (System) | 120 Vac, 60 Hz | Environmental Conditions | 20°C, 69% RH |
| Tested By | Sampson Chen | | |

| Antenna Polarity & Test Distance : Vertical at 3 m | | | | | | | | |
|--|-----------------|-------------------------|----------------|-------------|--------------------|----------------------|------------------|--------------------------|
| No | Frequency (MHz) | Emission Level (dBuV/m) | Limit (dBuV/m) | Margin (dB) | Antenna Height (m) | Table Angle (Degree) | Raw Value (dBuV) | Correction Factor (dB/m) |
| 1 | #5640.83 | 51.5 PK | 68.2 | -16.7 | 1.48 V | 236 | 47.1 | 4.4 |
| 2 | *5745.00 | 119.8 PK | | | 1.48 V | 236 | 115.4 | 4.4 |
| 3 | *5745.00 | 110.4 AV | | | 1.48 V | 236 | 106.0 | 4.4 |
| 4 | #5963.05 | 51.4 PK | 68.2 | -16.8 | 1.48 V | 236 | 46.3 | 5.1 |
| 5 | 11490.00 | 61.3 PK | 74.0 | -12.7 | 2.78 V | 133 | 46.0 | 15.3 |
| 6 | 11490.00 | 49.8 AV | 54.0 | -4.2 | 2.78 V | 133 | 34.5 | 15.3 |
| 7 | #17235.00 | 50.0 PK | 68.2 | -18.2 | 1.50 V | 51 | 33.8 | 16.2 |

Remarks:

1. Emission Level(dBuV/m) = Raw Value(dBuV) + Correction Factor(dB/m)
2. Correction Factor(dB/m) = Antenna Factor(dB/m) + Cable Factor(dB) – Pre-Amplifier Factor(dB)
3. Margin value = Emission Level – Limit value
4. The other emission levels were very low against the limit.
5. " * ": Fundamental frequency, the limit was restricted at the RF Output Power.
6. " # ": The radiated frequency is out of the restricted band.

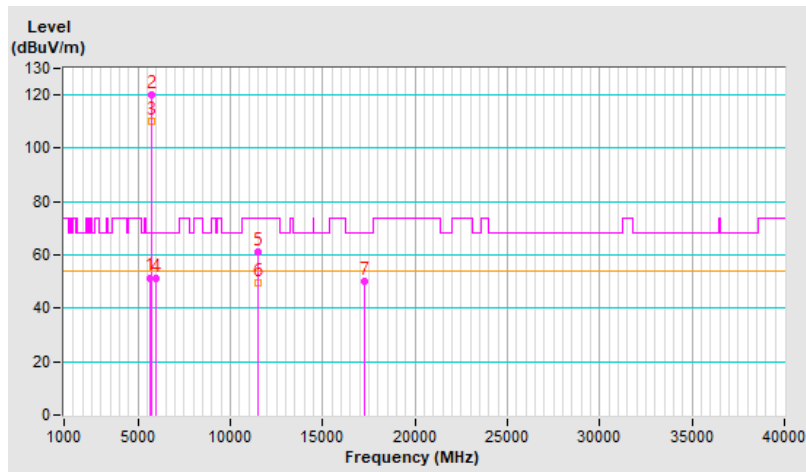

| | | | |
|-----------------------------|----------------|--|--|
| RF Mode | 802.11a | Channel | CH 157 : 5785 MHz |
| Frequency Range | 1 GHz ~ 40 GHz | Detector Function & Bandwidth | Peak (PK), RB = 1 MHz, VB = 3 MHz Peak (AV), RB = 1 MHz, VB = 10 Hz |
| Input Power (System) | 120 Vac, 60 Hz | Environmental Conditions | 20°C, 69% RH |
| Tested By | Sampson Chen | | |

| Antenna Polarity & Test Distance : Horizontal at 3 m | | | | | | | | |
|--|-----------------|-------------------------|----------------|-------------|--------------------|----------------------|------------------|--------------------------|
| No | Frequency (MHz) | Emission Level (dBuV/m) | Limit (dBuV/m) | Margin (dB) | Antenna Height (m) | Table Angle (Degree) | Raw Value (dBuV) | Correction Factor (dB/m) |
| 1 | #5649.38 | 50.3 PK | 68.2 | -17.9 | 1.44 H | 348 | 45.9 | 4.4 |
| 2 | *5785.00 | 122.3 PK | | | 1.44 H | 348 | 117.8 | 4.5 |
| 3 | *5785.00 | 111.8 AV | | | 1.44 H | 348 | 107.3 | 4.5 |
| 4 | #5939.80 | 50.2 PK | 68.2 | -18.0 | 1.44 H | 348 | 45.2 | 5.0 |
| 5 | 11570.00 | 60.4 PK | 74.0 | -13.6 | 1.27 H | 60 | 45.3 | 15.1 |
| 6 | 11570.00 | 48.5 AV | 54.0 | -5.5 | 1.27 H | 60 | 33.4 | 15.1 |
| 7 | #17355.00 | 53.7 PK | 68.2 | -14.5 | 1.55 H | 60 | 36.7 | 17.0 |

Remarks:

1. Emission Level(dBuV/m) = Raw Value(dBuV) + Correction Factor(dB/m)
2. Correction Factor(dB/m) = Antenna Factor(dB/m) + Cable Factor(dB) – Pre-Amplifier Factor(dB)
3. Margin value = Emission Level – Limit value
4. The other emission levels were very low against the limit.
5. " * " : Fundamental frequency, the limit was restricted at the RF Output Power.
6. " # " : The radiated frequency is out of the restricted band.

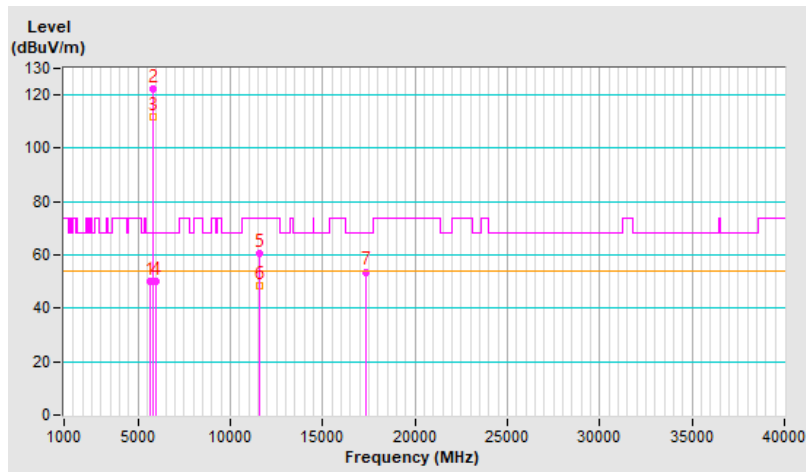

| | | | |
|-----------------------------|----------------|--|--|
| RF Mode | 802.11a | Channel | CH 157 : 5785 MHz |
| Frequency Range | 1 GHz ~ 40 GHz | Detector Function & Bandwidth | Peak (PK), RB = 1 MHz, VB = 3 MHz Peak (AV), RB = 1 MHz, VB = 10 Hz |
| Input Power (System) | 120 Vac, 60 Hz | Environmental Conditions | 20°C, 69% RH |
| Tested By | Sampson Chen | | |

| Antenna Polarity & Test Distance : Vertical at 3 m | | | | | | | | |
|--|-----------------|-------------------------|----------------|-------------|--------------------|----------------------|------------------|--------------------------|
| No | Frequency (MHz) | Emission Level (dBuV/m) | Limit (dBuV/m) | Margin (dB) | Antenna Height (m) | Table Angle (Degree) | Raw Value (dBuV) | Correction Factor (dB/m) |
| 1 | #5639.73 | 51.1 PK | 68.2 | -17.1 | 2.51 V | 269 | 46.7 | 4.4 |
| 2 | *5785.00 | 120.4 PK | | | 2.51 V | 269 | 115.9 | 4.5 |
| 3 | *5785.00 | 110.3 AV | | | 2.51 V | 269 | 105.8 | 4.5 |
| 4 | #5935.81 | 51.5 PK | 68.2 | -16.7 | 2.51 V | 269 | 46.5 | 5.0 |
| 5 | 11570.00 | 61.5 PK | 74.0 | -12.5 | 2.79 V | 131 | 46.4 | 15.1 |
| 6 | 11570.00 | 49.9 AV | 54.0 | -4.1 | 2.79 V | 131 | 34.8 | 15.1 |
| 7 | #17355.00 | 50.5 PK | 68.2 | -17.7 | 1.47 V | 64 | 33.5 | 17.0 |

Remarks:

1. Emission Level(dBuV/m) = Raw Value(dBuV) + Correction Factor(dB/m)
2. Correction Factor(dB/m) = Antenna Factor(dB/m) + Cable Factor(dB) – Pre-Amplifier Factor(dB)
3. Margin value = Emission Level – Limit value
4. The other emission levels were very low against the limit.
5. " * ": Fundamental frequency, the limit was restricted at the RF Output Power.
6. " # ": The radiated frequency is out of the restricted band.

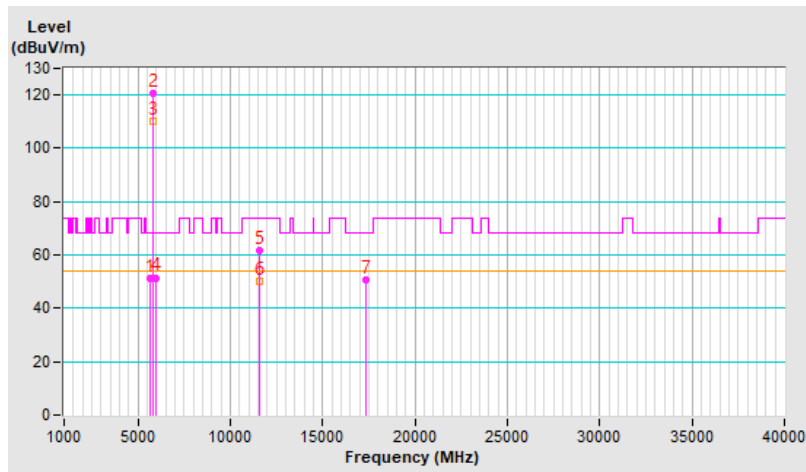

| | | | |
|-----------------------------|----------------|--|--|
| RF Mode | 802.11a | Channel | CH 165 : 5825 MHz |
| Frequency Range | 1 GHz ~ 40 GHz | Detector Function & Bandwidth | Peak (PK), RB = 1 MHz, VB = 3 MHz Peak (AV), RB = 1 MHz, VB = 10 Hz |
| Input Power (System) | 120 Vac, 60 Hz | Environmental Conditions | 20°C, 69% RH |
| Tested By | Sampson Chen | | |

| Antenna Polarity & Test Distance : Horizontal at 3 m | | | | | | | | |
|--|-----------------|-------------------------|----------------|-------------|--------------------|----------------------|------------------|--------------------------|
| No | Frequency (MHz) | Emission Level (dBuV/m) | Limit (dBuV/m) | Margin (dB) | Antenna Height (m) | Table Angle (Degree) | Raw Value (dBuV) | Correction Factor (dB/m) |
| 1 | #5644.88 | 50.5 PK | 68.2 | -17.7 | 1.45 H | 348 | 46.1 | 4.4 |
| 2 | *5825.00 | 118.6 PK | | | 1.45 H | 348 | 114.0 | 4.6 |
| 3 | *5825.00 | 109.6 AV | | | 1.45 H | 348 | 105.0 | 4.6 |
| 4 | #5941.52 | 51.2 PK | 68.2 | -17.0 | 1.45 H | 348 | 46.1 | 5.1 |
| 5 | 11650.00 | 60.6 PK | 74.0 | -13.4 | 1.26 H | 45 | 46.0 | 14.6 |
| 6 | 11650.00 | 49.0 AV | 54.0 | -5.0 | 1.26 H | 45 | 34.4 | 14.6 |
| 7 | #17475.00 | 54.2 PK | 68.2 | -14.0 | 1.49 H | 52 | 35.8 | 18.4 |

Remarks:

1. Emission Level(dBuV/m) = Raw Value(dBuV) + Correction Factor(dB/m)
2. Correction Factor(dB/m) = Antenna Factor(dB/m) + Cable Factor(dB) – Pre-Amplifier Factor(dB)
3. Margin value = Emission Level – Limit value
4. The other emission levels were very low against the limit.
5. " * " : Fundamental frequency, the limit was restricted at the RF Output Power.
6. " # " : The radiated frequency is out of the restricted band.

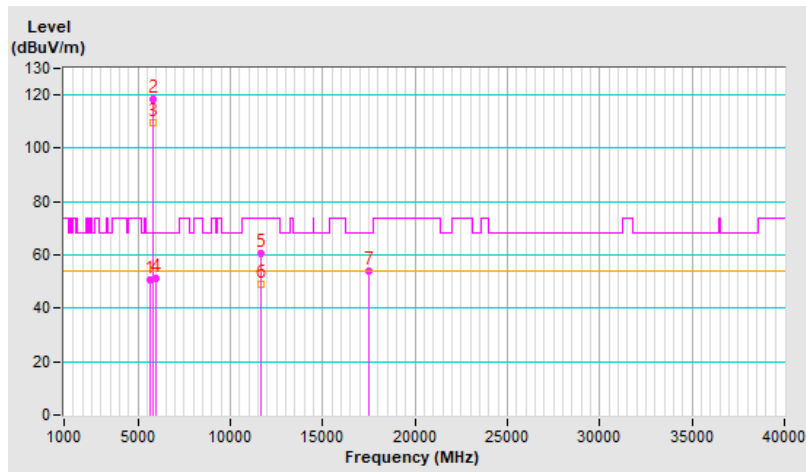

| | | | |
|-----------------------------|----------------|--|--|
| RF Mode | 802.11a | Channel | CH 165 : 5825 MHz |
| Frequency Range | 1 GHz ~ 40 GHz | Detector Function & Bandwidth | Peak (PK), RB = 1 MHz, VB = 3 MHz Peak (AV), RB = 1 MHz, VB = 10 Hz |
| Input Power (System) | 120 Vac, 60 Hz | Environmental Conditions | 20°C, 69% RH |
| Tested By | Sampson Chen | | |

| Antenna Polarity & Test Distance : Vertical at 3 m | | | | | | | | |
|--|-----------------|-------------------------|----------------|-------------|--------------------|----------------------|------------------|--------------------------|
| No | Frequency (MHz) | Emission Level (dBuV/m) | Limit (dBuV/m) | Margin (dB) | Antenna Height (m) | Table Angle (Degree) | Raw Value (dBuV) | Correction Factor (dB/m) |
| 1 | #5626.75 | 50.4 PK | 68.2 | -17.8 | 2.08 V | 268 | 46.0 | 4.4 |
| 2 | *5825.00 | 120.2 PK | | | 2.08 V | 268 | 115.6 | 4.6 |
| 3 | *5825.00 | 110.1 AV | | | 2.08 V | 268 | 105.5 | 4.6 |
| 4 | #5941.44 | 50.9 PK | 68.2 | -17.3 | 2.08 V | 268 | 45.8 | 5.1 |
| 5 | 11650.00 | 61.4 PK | 74.0 | -12.6 | 2.81 V | 124 | 46.8 | 14.6 |
| 6 | 11650.00 | 50.1 AV | 54.0 | -3.9 | 2.81 V | 124 | 35.5 | 14.6 |
| 7 | #17475.00 | 50.6 PK | 68.2 | -17.6 | 1.50 V | 45 | 32.2 | 18.4 |

Remarks:

1. Emission Level(dBuV/m) = Raw Value(dBuV) + Correction Factor(dB/m)
2. Correction Factor(dB/m) = Antenna Factor(dB/m) + Cable Factor(dB) – Pre-Amplifier Factor(dB)
3. Margin value = Emission Level – Limit value
4. The other emission levels were very low against the limit.
5. " * " : Fundamental frequency, the limit was restricted at the RF Output Power.
6. " # " : The radiated frequency is out of the restricted band.

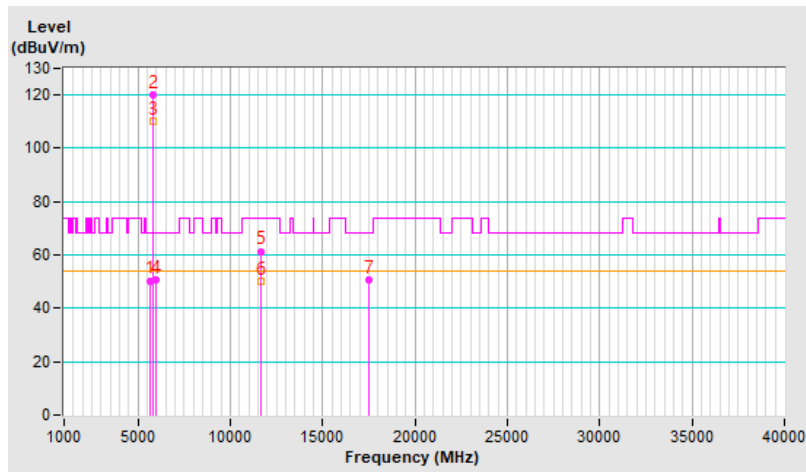

| | | | |
|-----------------------------|-----------------|--|--|
| RF Mode | 802.11ax (HE20) | Channel | CH 36 : 5180 MHz |
| Frequency Range | 1 GHz ~ 40 GHz | Detector Function & Bandwidth | Peak (PK), RB = 1 MHz, VB = 3 MHz Peak (AV), RB = 1 MHz, VB = 10 Hz |
| Input Power (System) | 120 Vac, 60 Hz | Environmental Conditions | 25°C, 75% RH |
| Tested By | Sampson Chen | | |

| Antenna Polarity & Test Distance : Horizontal at 3 m | | | | | | | | |
|--|-----------------|-------------------------|----------------|-------------|--------------------|----------------------|------------------|--------------------------|
| No | Frequency (MHz) | Emission Level (dBuV/m) | Limit (dBuV/m) | Margin (dB) | Antenna Height (m) | Table Angle (Degree) | Raw Value (dBuV) | Correction Factor (dB/m) |
| 1 | 5150.00 | 58.2 PK | 74.0 | -15.8 | 1.38 H | 333 | 54.6 | 3.6 |
| 2 | 5150.00 | 50.7 AV | 54.0 | -3.3 | 1.38 H | 333 | 47.1 | 3.6 |
| 3 | *5180.00 | 116.2 PK | | | 1.38 H | 333 | 112.8 | 3.4 |
| 4 | *5180.00 | 106.4 AV | | | 1.38 H | 333 | 103.0 | 3.4 |
| 5 | #10360.00 | 39.1 PK | 68.2 | -29.1 | 1.36 H | 337 | 25.3 | 13.8 |
| 6 | 15540.00 | 47.6 PK | 74.0 | -26.4 | 1.45 H | 237 | 32.1 | 15.5 |
| 7 | 15540.00 | 34.1 AV | 54.0 | -19.9 | 1.45 H | 237 | 18.6 | 15.5 |

Remarks:

1. Emission Level(dBuV/m) = Raw Value(dBuV) + Correction Factor(dB/m)
2. Correction Factor(dB/m) = Antenna Factor(dB/m) + Cable Factor(dB) – Pre-Amplifier Factor(dB)
3. Margin value = Emission Level – Limit value
4. The other emission levels were very low against the limit.
5. " * ": Fundamental frequency, the limit was restricted at the RF Output Power.
6. " # ": The radiated frequency is out of the restricted band.

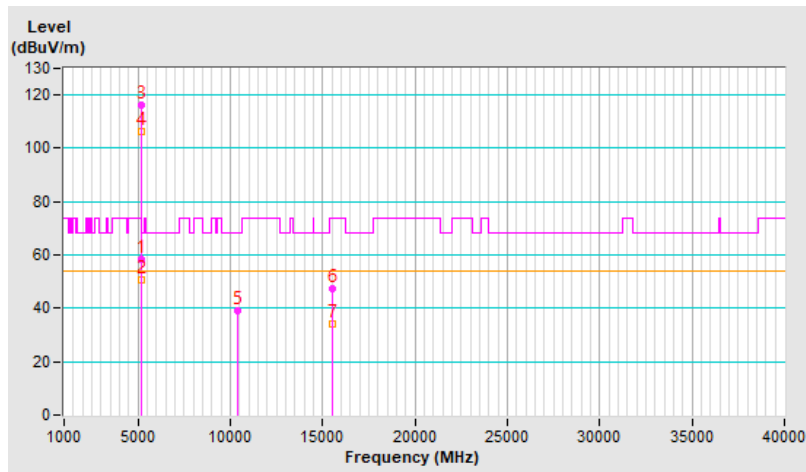

| | | | |
|-----------------------------|-----------------|--|--|
| RF Mode | 802.11ax (HE20) | Channel | CH 36 : 5180 MHz |
| Frequency Range | 1 GHz ~ 40 GHz | Detector Function & Bandwidth | Peak (PK), RB = 1 MHz, VB = 3 MHz Peak (AV), RB = 1 MHz, VB = 10 Hz |
| Input Power (System) | 120 Vac, 60 Hz | Environmental Conditions | 25°C, 75% RH |
| Tested By | Sampson Chen | | |

| Antenna Polarity & Test Distance : Vertical at 3 m | | | | | | | | |
|--|-----------------|-------------------------|----------------|-------------|--------------------|----------------------|------------------|--------------------------|
| No | Frequency (MHz) | Emission Level (dBuV/m) | Limit (dBuV/m) | Margin (dB) | Antenna Height (m) | Table Angle (Degree) | Raw Value (dBuV) | Correction Factor (dB/m) |
| 1 | 5150.00 | 63.8 PK | 74.0 | -10.2 | 2.92 V | 68 | 60.2 | 3.6 |
| 2 | 5150.00 | 51.6 AV | 54.0 | -2.4 | 2.92 V | 68 | 48.0 | 3.6 |
| 3 | *5180.00 | 119.0 PK | | | 2.92 V | 68 | 115.6 | 3.4 |
| 4 | *5180.00 | 108.7 AV | | | 2.92 V | 68 | 105.3 | 3.4 |
| 5 | #10360.00 | 46.5 PK | 68.2 | -21.7 | 2.18 V | 237 | 32.7 | 13.8 |
| 6 | 15540.00 | 50.2 PK | 74.0 | -23.8 | 1.50 V | 138 | 34.7 | 15.5 |
| 7 | 15540.00 | 39.6 AV | 54.0 | -14.4 | 1.50 V | 138 | 24.1 | 15.5 |

Remarks:

1. Emission Level(dBuV/m) = Raw Value(dBuV) + Correction Factor(dB/m)
2. Correction Factor(dB/m) = Antenna Factor(dB/m) + Cable Factor(dB) – Pre-Amplifier Factor(dB)
3. Margin value = Emission Level – Limit value
4. The other emission levels were very low against the limit.
5. " * " : Fundamental frequency, the limit was restricted at the RF Output Power.
6. " # " : The radiated frequency is out of the restricted band.

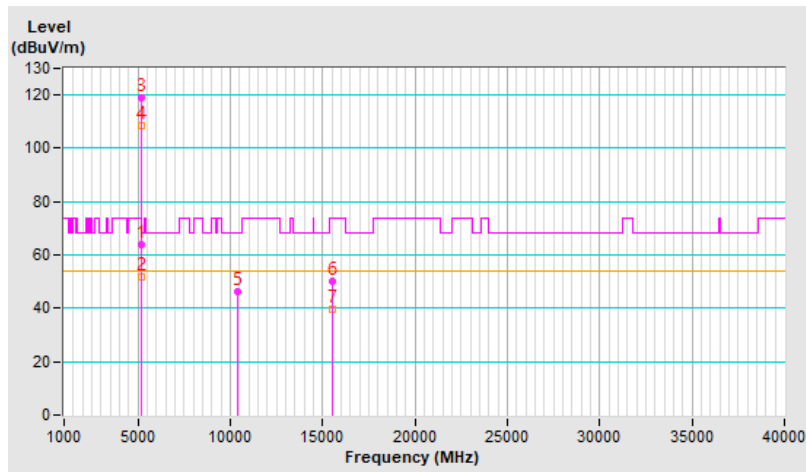

| | | | |
|-----------------------------|-----------------|--|--|
| RF Mode | 802.11ax (HE20) | Channel | CH 40 : 5200 MHz |
| Frequency Range | 1 GHz ~ 40 GHz | Detector Function & Bandwidth | Peak (PK), RB = 1 MHz, VB = 3 MHz Peak (AV), RB = 1 MHz, VB = 10 Hz |
| Input Power (System) | 120 Vac, 60 Hz | Environmental Conditions | 25°C, 75% RH |
| Tested By | Sampson Chen | | |

| Antenna Polarity & Test Distance : Horizontal at 3 m | | | | | | | | |
|--|-----------------|-------------------------|----------------|-------------|--------------------|----------------------|------------------|--------------------------|
| No | Frequency (MHz) | Emission Level (dBuV/m) | Limit (dBuV/m) | Margin (dB) | Antenna Height (m) | Table Angle (Degree) | Raw Value (dBuV) | Correction Factor (dB/m) |
| 1 | 5150.00 | 59.9 PK | 74.0 | -14.1 | 1.38 H | 333 | 56.3 | 3.6 |
| 2 | 5150.00 | 49.3 AV | 54.0 | -4.7 | 1.38 H | 333 | 45.7 | 3.6 |
| 3 | *5200.00 | 119.8 PK | | | 1.38 H | 333 | 116.4 | 3.4 |
| 4 | *5200.00 | 109.5 AV | | | 1.38 H | 333 | 106.1 | 3.4 |
| 5 | #10400.00 | 38.5 PK | 68.2 | -29.7 | 1.43 H | 323 | 24.5 | 14.0 |
| 6 | 15600.00 | 47.3 PK | 74.0 | -26.7 | 1.47 H | 237 | 31.7 | 15.6 |
| 7 | 15600.00 | 33.8 AV | 54.0 | -20.2 | 1.47 H | 237 | 18.2 | 15.6 |

Remarks:

1. Emission Level(dBuV/m) = Raw Value(dBuV) + Correction Factor(dB/m)
2. Correction Factor(dB/m) = Antenna Factor(dB/m) + Cable Factor(dB) – Pre-Amplifier Factor(dB)
3. Margin value = Emission Level – Limit value
4. The other emission levels were very low against the limit.
5. " * " : Fundamental frequency, the limit was restricted at the RF Output Power.
6. " # " : The radiated frequency is out of the restricted band.

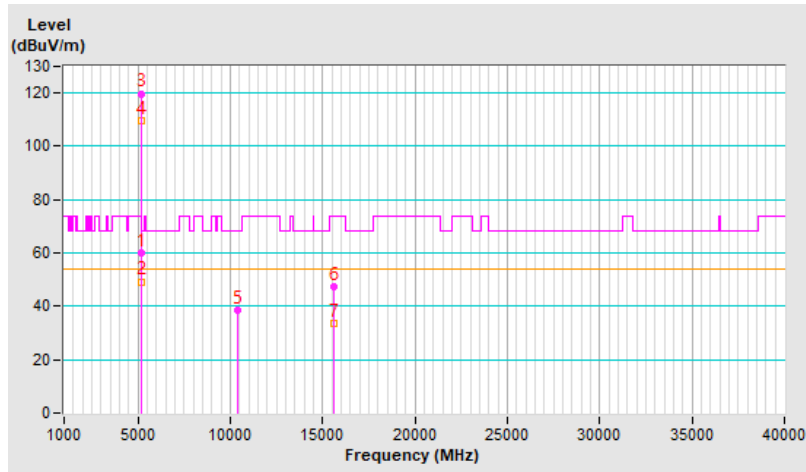

| | | | |
|-----------------------------|-----------------|--|--|
| RF Mode | 802.11ax (HE20) | Channel | CH 40 : 5200 MHz |
| Frequency Range | 1 GHz ~ 40 GHz | Detector Function & Bandwidth | Peak (PK), RB = 1 MHz, VB = 3 MHz Peak (AV), RB = 1 MHz, VB = 10 Hz |
| Input Power (System) | 120 Vac, 60 Hz | Environmental Conditions | 25°C, 75% RH |
| Tested By | Sampson Chen | | |

| Antenna Polarity & Test Distance : Vertical at 3 m | | | | | | | | |
|--|-----------------|-------------------------|----------------|-------------|--------------------|----------------------|------------------|--------------------------|
| No | Frequency (MHz) | Emission Level (dBuV/m) | Limit (dBuV/m) | Margin (dB) | Antenna Height (m) | Table Angle (Degree) | Raw Value (dBuV) | Correction Factor (dB/m) |
| 1 | 5150.00 | 63.0 PK | 74.0 | -11.0 | 2.78 V | 63 | 59.4 | 3.6 |
| 2 | 5150.00 | 51.3 AV | 54.0 | -2.7 | 2.78 V | 63 | 47.7 | 3.6 |
| 3 | *5200.00 | 121.7 PK | | | 2.78 V | 63 | 118.3 | 3.4 |
| 4 | *5200.00 | 111.7 AV | | | 2.78 V | 63 | 108.3 | 3.4 |
| 5 | #10400.00 | 46.2 PK | 68.2 | -22.0 | 2.21 V | 232 | 32.2 | 14.0 |
| 6 | 15600.00 | 49.8 PK | 74.0 | -24.2 | 1.58 V | 131 | 34.2 | 15.6 |
| 7 | 15600.00 | 39.4 AV | 54.0 | -14.6 | 1.58 V | 131 | 23.8 | 15.6 |

Remarks:

1. Emission Level(dBuV/m) = Raw Value(dBuV) + Correction Factor(dB/m)
2. Correction Factor(dB/m) = Antenna Factor(dB/m) + Cable Factor(dB) – Pre-Amplifier Factor(dB)
3. Margin value = Emission Level – Limit value
4. The other emission levels were very low against the limit.
5. " * " : Fundamental frequency, the limit was restricted at the RF Output Power.
6. " # " : The radiated frequency is out of the restricted band.

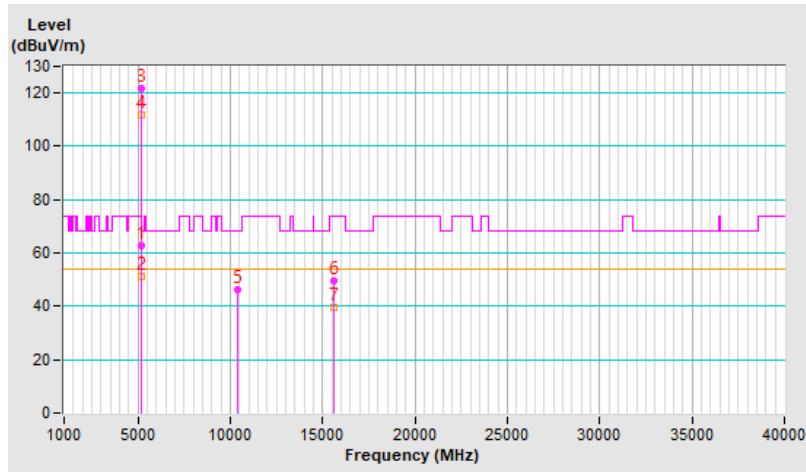

| | | | |
|-----------------------------|-----------------|--|--|
| RF Mode | 802.11ax (HE20) | Channel | CH 48 : 5240 MHz |
| Frequency Range | 1 GHz ~ 40 GHz | Detector Function & Bandwidth | Peak (PK), RB = 1 MHz, VB = 3 MHz Peak (AV), RB = 1 MHz, VB = 10 Hz |
| Input Power (System) | 120 Vac, 60 Hz | Environmental Conditions | 25°C, 75% RH |
| Tested By | Sampson Chen | | |

| Antenna Polarity & Test Distance : Horizontal at 3 m | | | | | | | | |
|--|-----------------|-------------------------|----------------|-------------|--------------------|----------------------|------------------|--------------------------|
| No | Frequency (MHz) | Emission Level (dBuV/m) | Limit (dBuV/m) | Margin (dB) | Antenna Height (m) | Table Angle (Degree) | Raw Value (dBuV) | Correction Factor (dB/m) |
| 1 | *5240.00 | 119.6 PK | | | 1.38 H | 335 | 116.3 | 3.3 |
| 2 | *5240.00 | 110.7 AV | | | 1.38 H | 335 | 107.4 | 3.3 |
| 3 | 5350.00 | 51.5 PK | 74.0 | -22.5 | 1.38 H | 335 | 48.2 | 3.3 |
| 4 | 5350.00 | 40.5 AV | 54.0 | -13.5 | 1.38 H | 335 | 37.2 | 3.3 |
| 5 | #10480.00 | 39.0 PK | 68.2 | -29.2 | 1.40 H | 348 | 24.9 | 14.1 |
| 6 | 15720.00 | 47.1 PK | 74.0 | -26.9 | 1.54 H | 241 | 33.2 | 13.9 |
| 7 | 15720.00 | 33.9 AV | 54.0 | -20.1 | 1.54 H | 241 | 20.0 | 13.9 |

Remarks:

1. Emission Level(dBuV/m) = Raw Value(dBuV) + Correction Factor(dB/m)
2. Correction Factor(dB/m) = Antenna Factor(dB/m) + Cable Factor(dB) – Pre-Amplifier Factor(dB)
3. Margin value = Emission Level – Limit value
4. The other emission levels were very low against the limit.
5. " * " : Fundamental frequency, the limit was restricted at the RF Output Power.
6. " # " : The radiated frequency is out of the restricted band.

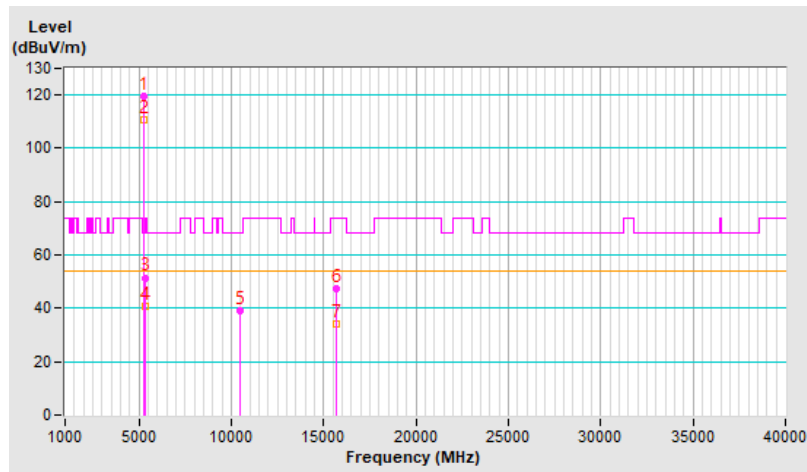

| | | | |
|-----------------------------|-----------------|--|--|
| RF Mode | 802.11ax (HE20) | Channel | CH 48 : 5240 MHz |
| Frequency Range | 1 GHz ~ 40 GHz | Detector Function & Bandwidth | Peak (PK), RB = 1 MHz, VB = 3 MHz Peak (AV), RB = 1 MHz, VB = 10 Hz |
| Input Power (System) | 120 Vac, 60 Hz | Environmental Conditions | 25°C, 75% RH |
| Tested By | Sampson Chen | | |

| Antenna Polarity & Test Distance : Vertical at 3 m | | | | | | | | |
|--|-----------------|-------------------------|----------------|-------------|--------------------|----------------------|------------------|--------------------------|
| No | Frequency (MHz) | Emission Level (dBuV/m) | Limit (dBuV/m) | Margin (dB) | Antenna Height (m) | Table Angle (Degree) | Raw Value (dBuV) | Correction Factor (dB/m) |
| 1 | *5240.00 | 120.2 PK | | | 2.56 V | 68 | 116.9 | 3.3 |
| 2 | *5240.00 | 111.8 AV | | | 2.56 V | 68 | 108.5 | 3.3 |
| 3 | 5350.00 | 51.7 PK | 74.0 | -22.3 | 2.56 V | 68 | 48.4 | 3.3 |
| 4 | 5350.00 | 41.1 AV | 54.0 | -12.9 | 2.56 V | 68 | 37.8 | 3.3 |
| 5 | #10480.00 | 46.3 PK | 68.2 | -21.9 | 2.16 V | 219 | 32.2 | 14.1 |
| 6 | 15720.00 | 50.4 PK | 74.0 | -23.6 | 1.60 V | 146 | 36.5 | 13.9 |
| 7 | 15720.00 | 39.5 AV | 54.0 | -14.5 | 1.60 V | 146 | 25.6 | 13.9 |

Remarks:

1. Emission Level(dBuV/m) = Raw Value(dBuV) + Correction Factor(dB/m)
2. Correction Factor(dB/m) = Antenna Factor(dB/m) + Cable Factor(dB) – Pre-Amplifier Factor(dB)
3. Margin value = Emission Level – Limit value
4. The other emission levels were very low against the limit.
5. " * " : Fundamental frequency, the limit was restricted at the RF Output Power.
6. " # " : The radiated frequency is out of the restricted band.

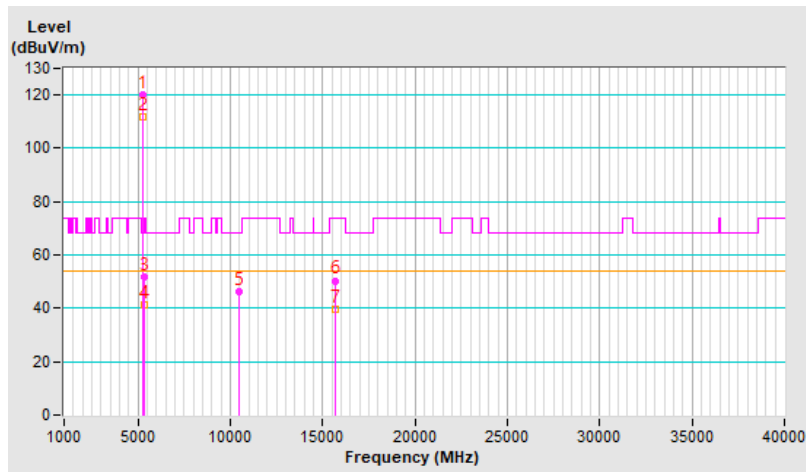

| | | | |
|-----------------------------|-----------------|--|--|
| RF Mode | 802.11ax (HE20) | Channel | CH 149 : 5745 MHz |
| Frequency Range | 1 GHz ~ 40 GHz | Detector Function & Bandwidth | Peak (PK), RB = 1 MHz, VB = 3 MHz Peak (AV), RB = 1 MHz, VB = 10 Hz |
| Input Power (System) | 120 Vac, 60 Hz | Environmental Conditions | 20°C, 69% RH |
| Tested By | Sampson Chen | | |

| Antenna Polarity & Test Distance : Horizontal at 3 m | | | | | | | | |
|--|-----------------|-------------------------|----------------|-------------|--------------------|----------------------|------------------|--------------------------|
| No | Frequency (MHz) | Emission Level (dBuV/m) | Limit (dBuV/m) | Margin (dB) | Antenna Height (m) | Table Angle (Degree) | Raw Value (dBuV) | Correction Factor (dB/m) |
| 1 | #5636.95 | 52.9 PK | 68.2 | -15.3 | 1.70 H | 351 | 48.5 | 4.4 |
| 2 | *5745.00 | 122.5 PK | | | 1.70 H | 351 | 118.1 | 4.4 |
| 3 | *5745.00 | 111.6 AV | | | 1.70 H | 351 | 107.2 | 4.4 |
| 4 | #5946.98 | 50.3 PK | 68.2 | -17.9 | 1.70 H | 351 | 45.2 | 5.1 |
| 5 | 11490.00 | 61.0 PK | 74.0 | -13.0 | 1.26 H | 72 | 45.7 | 15.3 |
| 6 | 11490.00 | 49.2 AV | 54.0 | -4.8 | 1.26 H | 72 | 33.9 | 15.3 |
| 7 | #17235.00 | 53.4 PK | 68.2 | -14.8 | 1.56 H | 65 | 37.2 | 16.2 |

Remarks:

1. Emission Level(dBuV/m) = Raw Value(dBuV) + Correction Factor(dB/m)
2. Correction Factor(dB/m) = Antenna Factor(dB/m) + Cable Factor(dB) – Pre-Amplifier Factor(dB)
3. Margin value = Emission Level – Limit value
4. The other emission levels were very low against the limit.
5. " * " : Fundamental frequency, the limit was restricted at the RF Output Power.
6. " # " : The radiated frequency is out of the restricted band.

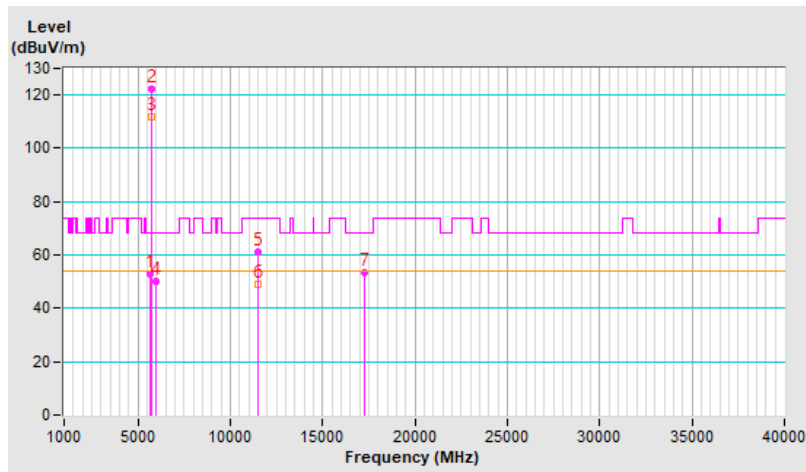

| | | | |
|-----------------------------|-----------------|--|--|
| RF Mode | 802.11ax (HE20) | Channel | CH 149 : 5745 MHz |
| Frequency Range | 1 GHz ~ 40 GHz | Detector Function & Bandwidth | Peak (PK), RB = 1 MHz, VB = 3 MHz Peak (AV), RB = 1 MHz, VB = 10 Hz |
| Input Power (System) | 120 Vac, 60 Hz | Environmental Conditions | 20°C, 69% RH |
| Tested By | Sampson Chen | | |

| Antenna Polarity & Test Distance : Vertical at 3 m | | | | | | | | |
|--|-----------------|-------------------------|----------------|-------------|--------------------|----------------------|------------------|--------------------------|
| No | Frequency (MHz) | Emission Level (dBuV/m) | Limit (dBuV/m) | Margin (dB) | Antenna Height (m) | Table Angle (Degree) | Raw Value (dBuV) | Correction Factor (dB/m) |
| 1 | #5644.16 | 52.4 PK | 68.2 | -15.8 | 1.60 V | 56 | 48.0 | 4.4 |
| 2 | *5745.00 | 120.4 PK | | | 1.60 V | 56 | 116.0 | 4.4 |
| 3 | *5745.00 | 110.3 AV | | | 1.60 V | 56 | 105.9 | 4.4 |
| 4 | #5954.14 | 51.1 PK | 68.2 | -17.1 | 1.60 V | 56 | 46.0 | 5.1 |
| 5 | 11490.00 | 61.7 PK | 74.0 | -12.3 | 2.80 V | 123 | 46.4 | 15.3 |
| 6 | 11490.00 | 49.9 AV | 54.0 | -4.1 | 2.80 V | 123 | 34.6 | 15.3 |
| 7 | #17235.00 | 50.1 PK | 68.2 | -18.1 | 1.49 V | 58 | 33.9 | 16.2 |

Remarks:

1. Emission Level(dBuV/m) = Raw Value(dBuV) + Correction Factor(dB/m)
2. Correction Factor(dB/m) = Antenna Factor(dB/m) + Cable Factor(dB) – Pre-Amplifier Factor(dB)
3. Margin value = Emission Level – Limit value
4. The other emission levels were very low against the limit.
5. " * ": Fundamental frequency, the limit was restricted at the RF Output Power.
6. " # ": The radiated frequency is out of the restricted band.

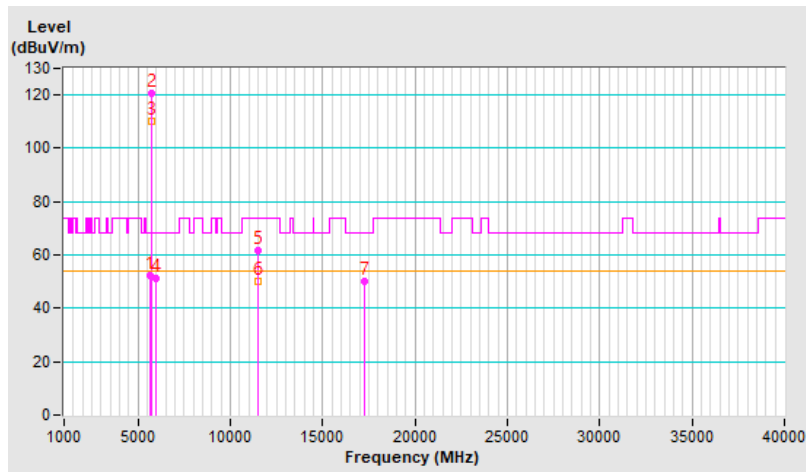

| | | | |
|-----------------------------|-----------------|--|--|
| RF Mode | 802.11ax (HE20) | Channel | CH 157 : 5785 MHz |
| Frequency Range | 1 GHz ~ 40 GHz | Detector Function & Bandwidth | Peak (PK), RB = 1 MHz, VB = 3 MHz Peak (AV), RB = 1 MHz, VB = 10 Hz |
| Input Power (System) | 120 Vac, 60 Hz | Environmental Conditions | 20°C, 69% RH |
| Tested By | Sampson Chen | | |

| Antenna Polarity & Test Distance : Horizontal at 3 m | | | | | | | | |
|--|-----------------|-------------------------|----------------|-------------|--------------------|----------------------|------------------|--------------------------|
| No | Frequency (MHz) | Emission Level (dBuV/m) | Limit (dBuV/m) | Margin (dB) | Antenna Height (m) | Table Angle (Degree) | Raw Value (dBuV) | Correction Factor (dB/m) |
| 1 | #5636.95 | 50.7 PK | 68.2 | -17.5 | 1.67 H | 344 | 46.3 | 4.4 |
| 2 | *5785.00 | 120.3 PK | | | 1.67 H | 344 | 115.8 | 4.5 |
| 3 | *5785.00 | 111.0 AV | | | 1.67 H | 344 | 106.5 | 4.5 |
| 4 | #5927.12 | 49.9 PK | 68.2 | -18.3 | 1.67 H | 344 | 44.9 | 5.0 |
| 5 | 11570.00 | 60.6 PK | 74.0 | -13.4 | 1.31 H | 46 | 45.5 | 15.1 |
| 6 | 11570.00 | 48.7 AV | 54.0 | -5.3 | 1.31 H | 46 | 33.6 | 15.1 |
| 7 | #17355.00 | 54.3 PK | 68.2 | -13.9 | 1.54 H | 51 | 37.3 | 17.0 |

Remarks:

1. Emission Level(dBuV/m) = Raw Value(dBuV) + Correction Factor(dB/m)
2. Correction Factor(dB/m) = Antenna Factor(dB/m) + Cable Factor(dB) – Pre-Amplifier Factor(dB)
3. Margin value = Emission Level – Limit value
4. The other emission levels were very low against the limit.
5. " * " : Fundamental frequency, the limit was restricted at the RF Output Power.
6. " # " : The radiated frequency is out of the restricted band.

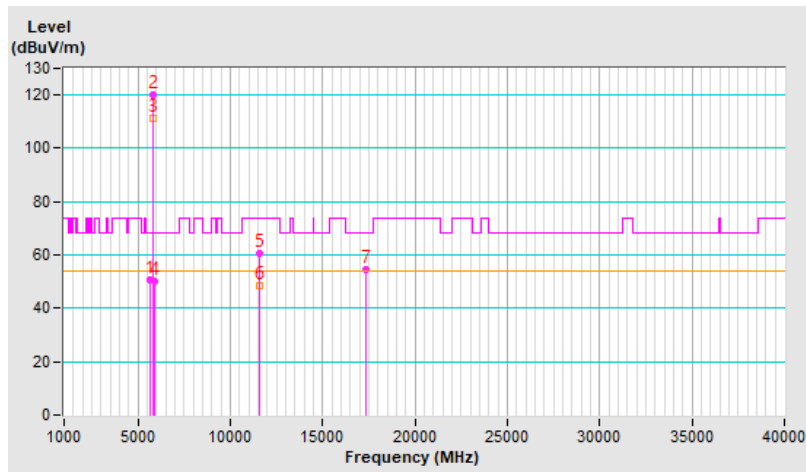

| | | | |
|-----------------------------|-----------------|--|--|
| RF Mode | 802.11ax (HE20) | Channel | CH 157 : 5785 MHz |
| Frequency Range | 1 GHz ~ 40 GHz | Detector Function & Bandwidth | Peak (PK), RB = 1 MHz, VB = 3 MHz Peak (AV), RB = 1 MHz, VB = 10 Hz |
| Input Power (System) | 120 Vac, 60 Hz | Environmental Conditions | 20°C, 69% RH |
| Tested By | Sampson Chen | | |

| Antenna Polarity & Test Distance : Vertical at 3 m | | | | | | | | |
|--|-----------------|-------------------------|----------------|-------------|--------------------|----------------------|------------------|--------------------------|
| No | Frequency (MHz) | Emission Level (dBuV/m) | Limit (dBuV/m) | Margin (dB) | Antenna Height (m) | Table Angle (Degree) | Raw Value (dBuV) | Correction Factor (dB/m) |
| 1 | #5641.40 | 50.4 PK | 68.2 | -17.8 | 2.51 V | 268 | 46.0 | 4.4 |
| 2 | *5785.00 | 121.4 PK | | | 2.51 V | 268 | 116.9 | 4.5 |
| 3 | *5785.00 | 110.0 AV | | | 2.51 V | 268 | 105.5 | 4.5 |
| 4 | #6011.71 | 51.3 PK | 68.2 | -16.9 | 2.51 V | 268 | 46.2 | 5.1 |
| 5 | 11570.00 | 61.1 PK | 74.0 | -12.9 | 2.77 V | 130 | 46.0 | 15.1 |
| 6 | 11570.00 | 49.5 AV | 54.0 | -4.5 | 2.77 V | 130 | 34.4 | 15.1 |
| 7 | #17355.00 | 50.3 PK | 68.2 | -17.9 | 1.54 V | 47 | 33.3 | 17.0 |

Remarks:

1. Emission Level(dBuV/m) = Raw Value(dBuV) + Correction Factor(dB/m)
2. Correction Factor(dB/m) = Antenna Factor(dB/m) + Cable Factor(dB) – Pre-Amplifier Factor(dB)
3. Margin value = Emission Level – Limit value
4. The other emission levels were very low against the limit.
5. " * " : Fundamental frequency, the limit was restricted at the RF Output Power.
6. " # " : The radiated frequency is out of the restricted band.

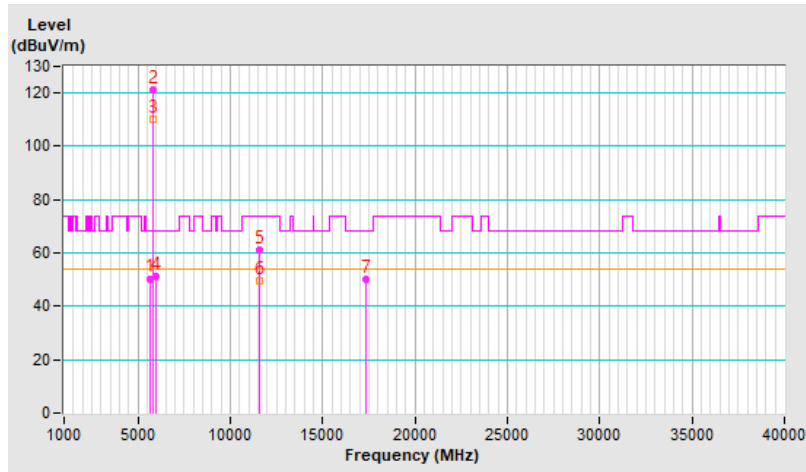

| | | | |
|-----------------------------|-----------------|--|--|
| RF Mode | 802.11ax (HE20) | Channel | CH 165 : 5825 MHz |
| Frequency Range | 1 GHz ~ 40 GHz | Detector Function & Bandwidth | Peak (PK), RB = 1 MHz, VB = 3 MHz Peak (AV), RB = 1 MHz, VB = 10 Hz |
| Input Power (System) | 120 Vac, 60 Hz | Environmental Conditions | 20°C, 69% RH |
| Tested By | Sampson Chen | | |

| Antenna Polarity & Test Distance : Horizontal at 3 m | | | | | | | | |
|--|-----------------|-------------------------|----------------|-------------|--------------------|----------------------|------------------|--------------------------|
| No | Frequency (MHz) | Emission Level (dBuV/m) | Limit (dBuV/m) | Margin (dB) | Antenna Height (m) | Table Angle (Degree) | Raw Value (dBuV) | Correction Factor (dB/m) |
| 1 | #5633.73 | 50.9 PK | 68.2 | -17.3 | 1.68 H | 349 | 46.5 | 4.4 |
| 2 | *5825.00 | 121.3 PK | | | 1.68 H | 349 | 116.7 | 4.6 |
| 3 | *5825.00 | 109.1 AV | | | 1.68 H | 349 | 104.5 | 4.6 |
| 4 | #5945.57 | 51.8 PK | 68.2 | -16.4 | 1.68 H | 349 | 46.7 | 5.1 |
| 5 | 11650.00 | 60.6 PK | 74.0 | -13.4 | 1.33 H | 63 | 46.0 | 14.6 |
| 6 | 11650.00 | 49.1 AV | 54.0 | -4.9 | 1.33 H | 63 | 34.5 | 14.6 |
| 7 | #17475.00 | 54.3 PK | 68.2 | -13.9 | 1.47 H | 39 | 35.9 | 18.4 |

Remarks:

1. Emission Level(dBuV/m) = Raw Value(dBuV) + Correction Factor(dB/m)
2. Correction Factor(dB/m) = Antenna Factor(dB/m) + Cable Factor(dB) – Pre-Amplifier Factor(dB)
3. Margin value = Emission Level – Limit value
4. The other emission levels were very low against the limit.
5. " * " : Fundamental frequency, the limit was restricted at the RF Output Power.
6. " # " : The radiated frequency is out of the restricted band.

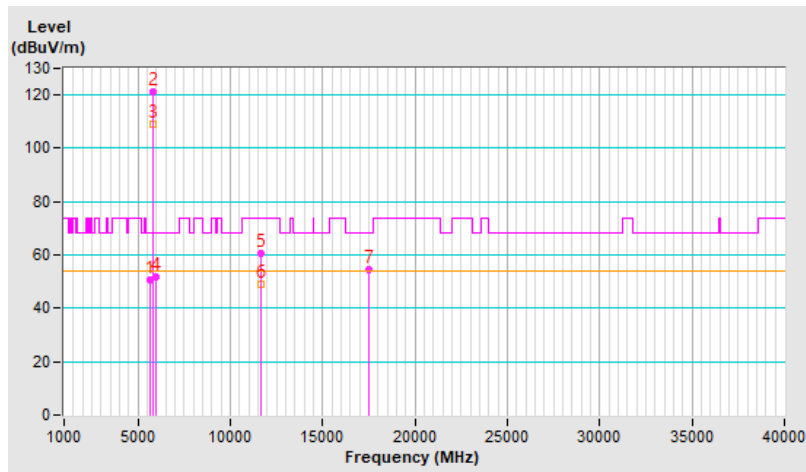

| | | | |
|-----------------------------|-----------------|--|--|
| RF Mode | 802.11ax (HE20) | Channel | CH 165 : 5825 MHz |
| Frequency Range | 1 GHz ~ 40 GHz | Detector Function & Bandwidth | Peak (PK), RB = 1 MHz, VB = 3 MHz Peak (AV), RB = 1 MHz, VB = 10 Hz |
| Input Power (System) | 120 Vac, 60 Hz | Environmental Conditions | 20°C, 69% RH |
| Tested By | Sampson Chen | | |

| Antenna Polarity & Test Distance : Vertical at 3 m | | | | | | | | |
|--|-----------------|-------------------------|----------------|-------------|--------------------|----------------------|------------------|--------------------------|
| No | Frequency (MHz) | Emission Level (dBuV/m) | Limit (dBuV/m) | Margin (dB) | Antenna Height (m) | Table Angle (Degree) | Raw Value (dBuV) | Correction Factor (dB/m) |
| 1 | #5646.07 | 50.1 PK | 68.2 | -18.1 | 2.08 V | 268 | 45.7 | 4.4 |
| 2 | *5825.00 | 120.1 PK | | | 2.08 V | 268 | 115.5 | 4.6 |
| 3 | *5825.00 | 109.8 AV | | | 2.08 V | 268 | 105.2 | 4.6 |
| 4 | #5951.64 | 50.9 PK | 68.2 | -17.3 | 2.08 V | 268 | 45.8 | 5.1 |
| 5 | 11650.00 | 60.6 PK | 74.0 | -13.4 | 2.72 V | 135 | 46.0 | 14.6 |
| 6 | 11650.00 | 49.4 AV | 54.0 | -4.6 | 2.72 V | 135 | 34.8 | 14.6 |
| 7 | #17475.00 | 50.0 PK | 68.2 | -18.2 | 1.51 V | 44 | 31.6 | 18.4 |

Remarks:

1. Emission Level(dBuV/m) = Raw Value(dBuV) + Correction Factor(dB/m)
2. Correction Factor(dB/m) = Antenna Factor(dB/m) + Cable Factor(dB) – Pre-Amplifier Factor(dB)
3. Margin value = Emission Level – Limit value
4. The other emission levels were very low against the limit.
5. " * " : Fundamental frequency, the limit was restricted at the RF Output Power.
6. " # " : The radiated frequency is out of the restricted band.

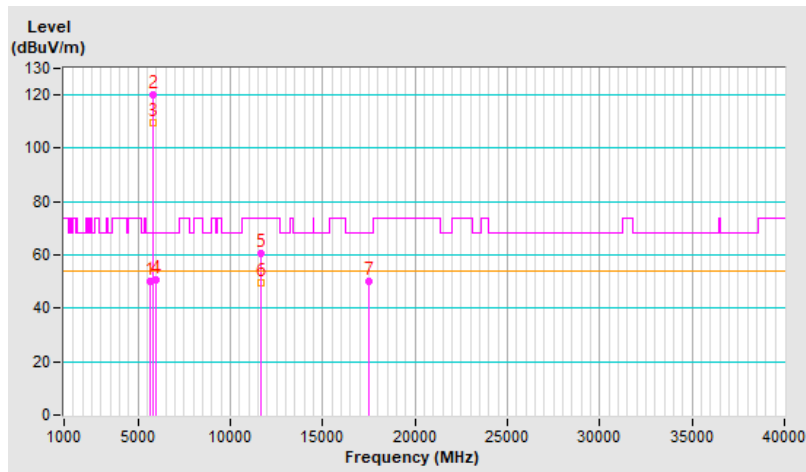

| | | | |
|-----------------------------|-----------------|--|--|
| RF Mode | 802.11ax (HE40) | Channel | CH 38 : 5190 MHz |
| Frequency Range | 1 GHz ~ 40 GHz | Detector Function & Bandwidth | Peak (PK), RB = 1 MHz, VB = 3 MHz Peak (AV), RB = 1 MHz, VB = 10 Hz |
| Input Power (System) | 120 Vac, 60 Hz | Environmental Conditions | 25°C, 75% RH |
| Tested By | Sampson Chen | | |

| Antenna Polarity & Test Distance : Horizontal at 3 m | | | | | | | | |
|--|-----------------|-------------------------|----------------|-------------|--------------------|----------------------|------------------|--------------------------|
| No | Frequency (MHz) | Emission Level (dBuV/m) | Limit (dBuV/m) | Margin (dB) | Antenna Height (m) | Table Angle (Degree) | Raw Value (dBuV) | Correction Factor (dB/m) |
| 1 | 5150.00 | 63.4 PK | 74.0 | -10.6 | 1.43 H | 336 | 59.8 | 3.6 |
| 2 | 5150.00 | 50.0 AV | 54.0 | -4.0 | 1.43 H | 336 | 46.4 | 3.6 |
| 3 | *5190.00 | 112.0 PK | | | 1.43 H | 336 | 108.6 | 3.4 |
| 4 | *5190.00 | 103.5 AV | | | 1.43 H | 336 | 100.1 | 3.4 |
| 5 | #10380.00 | 38.8 PK | 68.2 | -29.4 | 1.37 H | 333 | 24.9 | 13.9 |
| 6 | 15570.00 | 46.9 PK | 74.0 | -27.1 | 1.52 H | 242 | 31.4 | 15.5 |
| 7 | 15570.00 | 33.9 AV | 54.0 | -20.1 | 1.52 H | 242 | 18.4 | 15.5 |

Remarks:

1. Emission Level(dBuV/m) = Raw Value(dBuV) + Correction Factor(dB/m)
2. Correction Factor(dB/m) = Antenna Factor(dB/m) + Cable Factor(dB) – Pre-Amplifier Factor(dB)
3. Margin value = Emission Level – Limit value
4. The other emission levels were very low against the limit.
5. " * " : Fundamental frequency, the limit was restricted at the RF Output Power.
6. " # " : The radiated frequency is out of the restricted band.

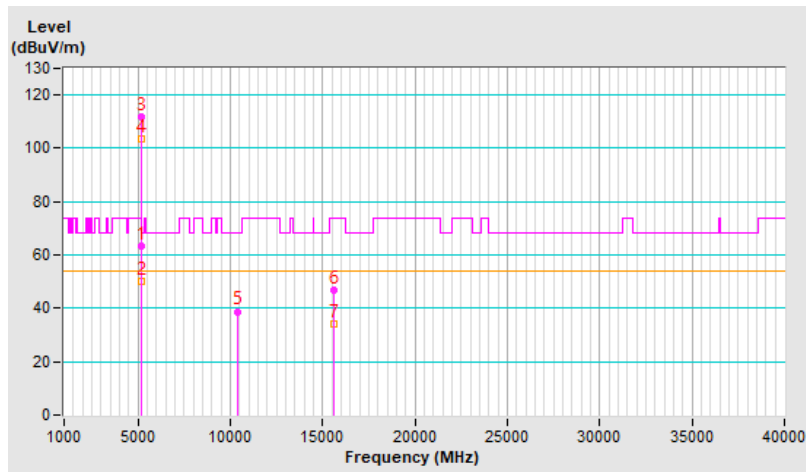

| | | | |
|-----------------------------|-----------------|--|--|
| RF Mode | 802.11ax (HE40) | Channel | CH 38 : 5190 MHz |
| Frequency Range | 1 GHz ~ 40 GHz | Detector Function & Bandwidth | Peak (PK), RB = 1 MHz, VB = 3 MHz Peak (AV), RB = 1 MHz, VB = 10 Hz |
| Input Power (System) | 120 Vac, 60 Hz | Environmental Conditions | 25°C, 75% RH |
| Tested By | Sampson Chen | | |

| Antenna Polarity & Test Distance : Vertical at 3 m | | | | | | | | |
|--|-----------------|-------------------------|----------------|-------------|--------------------|----------------------|------------------|--------------------------|
| No | Frequency (MHz) | Emission Level (dBuV/m) | Limit (dBuV/m) | Margin (dB) | Antenna Height (m) | Table Angle (Degree) | Raw Value (dBuV) | Correction Factor (dB/m) |
| 1 | 5150.00 | 63.4 PK | 74.0 | -10.6 | 2.58 V | 57 | 59.8 | 3.6 |
| 2 | 5150.00 | 52.7 AV | 54.0 | -1.3 | 2.58 V | 57 | 49.1 | 3.6 |
| 3 | *5190.00 | 113.3 PK | | | 2.58 V | 57 | 109.9 | 3.4 |
| 4 | *5190.00 | 105.3 AV | | | 2.58 V | 57 | 101.9 | 3.4 |
| 5 | #10380.00 | 46.2 PK | 68.2 | -22.0 | 2.15 V | 243 | 32.3 | 13.9 |
| 6 | 15570.00 | 49.7 PK | 74.0 | -24.3 | 1.58 V | 133 | 34.2 | 15.5 |
| 7 | 15570.00 | 39.2 AV | 54.0 | -14.8 | 1.58 V | 133 | 23.7 | 15.5 |

Remarks:

1. Emission Level(dBuV/m) = Raw Value(dBuV) + Correction Factor(dB/m)
2. Correction Factor(dB/m) = Antenna Factor(dB/m) + Cable Factor(dB) – Pre-Amplifier Factor(dB)
3. Margin value = Emission Level – Limit value
4. The other emission levels were very low against the limit.
5. " * ": Fundamental frequency, the limit was restricted at the RF Output Power.
6. " # ": The radiated frequency is out of the restricted band.

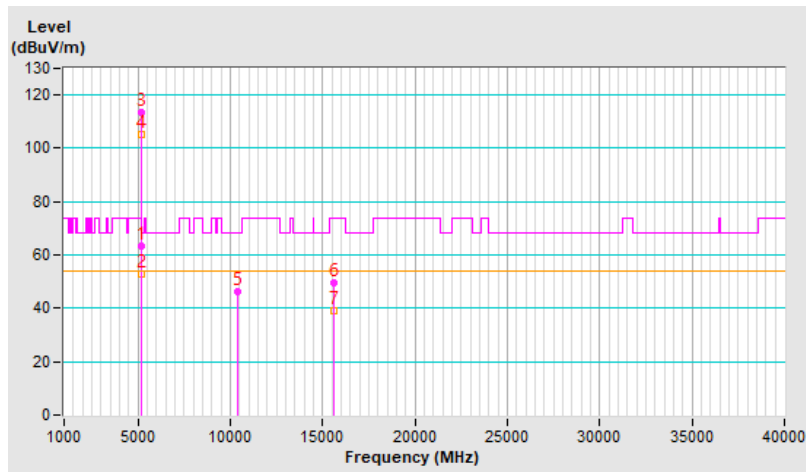

| | | | |
|-----------------------------|-----------------|--|--|
| RF Mode | 802.11ax (HE40) | Channel | CH 46 : 5230 MHz |
| Frequency Range | 1 GHz ~ 40 GHz | Detector Function & Bandwidth | Peak (PK), RB = 1 MHz, VB = 3 MHz Peak (AV), RB = 1 MHz, VB = 10 Hz |
| Input Power (System) | 120 Vac, 60 Hz | Environmental Conditions | 25°C, 75% RH |
| Tested By | Sampson Chen | | |

| Antenna Polarity & Test Distance : Horizontal at 3 m | | | | | | | | |
|--|-----------------|-------------------------|----------------|-------------|--------------------|----------------------|------------------|--------------------------|
| No | Frequency (MHz) | Emission Level (dBuV/m) | Limit (dBuV/m) | Margin (dB) | Antenna Height (m) | Table Angle (Degree) | Raw Value (dBuV) | Correction Factor (dB/m) |
| 1 | *5230.00 | 115.3 PK | | | 1.35 H | 334 | 112.0 | 3.3 |
| 2 | *5230.00 | 107.0 AV | | | 1.35 H | 334 | 103.7 | 3.3 |
| 3 | 5350.00 | 64.6 PK | 74.0 | -9.4 | 1.35 H | 334 | 61.3 | 3.3 |
| 4 | 5350.00 | 53.6 AV | 54.0 | -0.4 | 1.35 H | 334 | 50.3 | 3.3 |
| 5 | #10460.00 | 39.1 PK | 68.2 | -29.1 | 1.37 H | 332 | 25.0 | 14.1 |
| 6 | 15690.00 | 47.8 PK | 74.0 | -26.2 | 1.49 H | 232 | 33.8 | 14.0 |
| 7 | 15690.00 | 34.5 AV | 54.0 | -19.5 | 1.49 H | 232 | 20.5 | 14.0 |

Remarks:

1. Emission Level(dBuV/m) = Raw Value(dBuV) + Correction Factor(dB/m)
2. Correction Factor(dB/m) = Antenna Factor(dB/m) + Cable Factor(dB) – Pre-Amplifier Factor(dB)
3. Margin value = Emission Level – Limit value
4. The other emission levels were very low against the limit.
5. " * " : Fundamental frequency, the limit was restricted at the RF Output Power.
6. " # " : The radiated frequency is out of the restricted band.

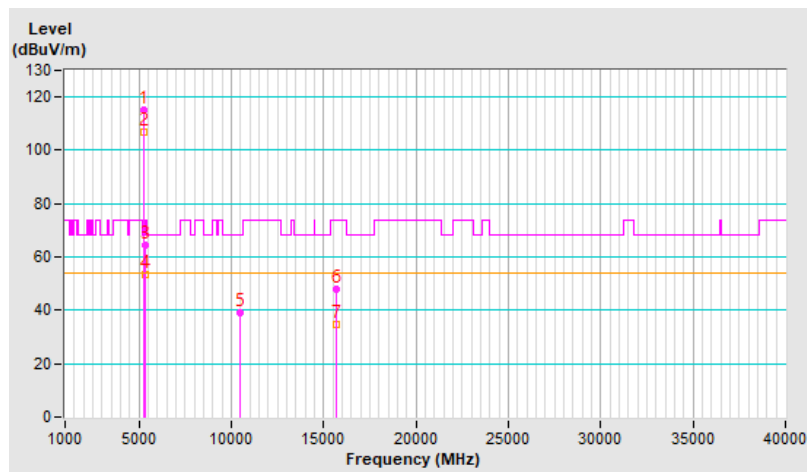

| | | | |
|-----------------------------|-----------------|--|--|
| RF Mode | 802.11ax (HE40) | Channel | CH 46 : 5230 MHz |
| Frequency Range | 1 GHz ~ 40 GHz | Detector Function & Bandwidth | Peak (PK), RB = 1 MHz, VB = 3 MHz Peak (AV), RB = 1 MHz, VB = 10 Hz |
| Input Power (System) | 120 Vac, 60 Hz | Environmental Conditions | 25°C, 75% RH |
| Tested By | Sampson Chen | | |

| Antenna Polarity & Test Distance : Vertical at 3 m | | | | | | | | |
|--|-----------------|-------------------------|----------------|-------------|--------------------|----------------------|------------------|--------------------------|
| No | Frequency (MHz) | Emission Level (dBuV/m) | Limit (dBuV/m) | Margin (dB) | Antenna Height (m) | Table Angle (Degree) | Raw Value (dBuV) | Correction Factor (dB/m) |
| 1 | *5230.00 | 116.8 PK | | | 2.56 V | 60 | 113.5 | 3.3 |
| 2 | *5230.00 | 108.3 AV | | | 2.56 V | 60 | 105.0 | 3.3 |
| 3 | 5350.00 | 65.1 PK | 74.0 | -8.9 | 2.56 V | 60 | 61.8 | 3.3 |
| 4 | 5350.00 | 53.2 AV | 54.0 | -0.8 | 2.56 V | 60 | 49.9 | 3.3 |
| 5 | #10460.00 | 47.2 PK | 68.2 | -21.0 | 2.15 V | 248 | 33.1 | 14.1 |
| 6 | 15690.00 | 49.8 PK | 74.0 | -24.2 | 1.61 V | 135 | 35.8 | 14.0 |
| 7 | 15690.00 | 39.3 AV | 54.0 | -14.7 | 1.61 V | 135 | 25.3 | 14.0 |

Remarks:

1. Emission Level(dBuV/m) = Raw Value(dBuV) + Correction Factor(dB/m)
2. Correction Factor(dB/m) = Antenna Factor(dB/m) + Cable Factor(dB) – Pre-Amplifier Factor(dB)
3. Margin value = Emission Level – Limit value
4. The other emission levels were very low against the limit.
5. " * " : Fundamental frequency, the limit was restricted at the RF Output Power.
6. " # " : The radiated frequency is out of the restricted band.

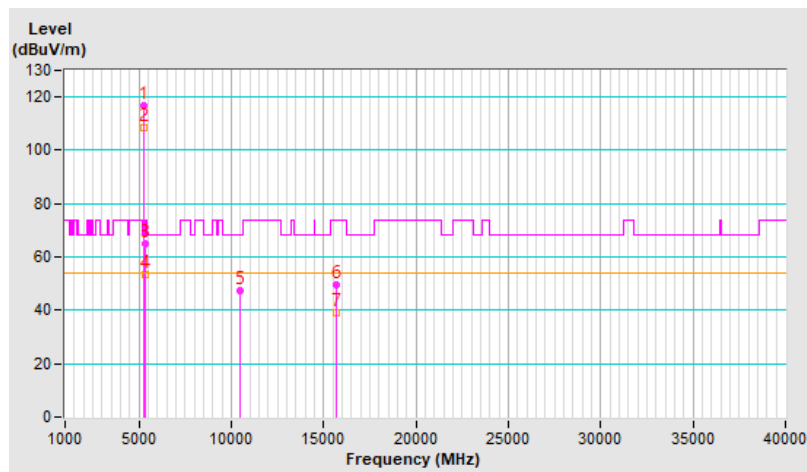

| | | | |
|-----------------------------|-----------------|--|--|
| RF Mode | 802.11ax (HE40) | Channel | CH 151 : 5755 MHz |
| Frequency Range | 1 GHz ~ 40 GHz | Detector Function & Bandwidth | Peak (PK), RB = 1 MHz, VB = 3 MHz Peak (AV), RB = 1 MHz, VB = 10 Hz |
| Input Power (System) | 120 Vac, 60 Hz | Environmental Conditions | 20°C, 69% RH |
| Tested By | Sampson Chen | | |

| Antenna Polarity & Test Distance : Horizontal at 3 m | | | | | | | | |
|--|-----------------|-------------------------|----------------|-------------|--------------------|----------------------|------------------|--------------------------|
| No | Frequency (MHz) | Emission Level (dBuV/m) | Limit (dBuV/m) | Margin (dB) | Antenna Height (m) | Table Angle (Degree) | Raw Value (dBuV) | Correction Factor (dB/m) |
| 1 | #5647.81 | 64.9 PK | 68.2 | -3.3 | 1.52 H | 358 | 60.5 | 4.4 |
| 2 | *5755.00 | 120.5 PK | | | 1.52 H | 358 | 116.0 | 4.5 |
| 3 | *5755.00 | 109.1 AV | | | 1.52 H | 358 | 104.6 | 4.5 |
| 4 | #5948.73 | 51.0 PK | 68.2 | -17.2 | 1.52 H | 358 | 45.9 | 5.1 |
| 5 | 11510.00 | 58.7 PK | 74.0 | -15.3 | 1.29 H | 58 | 43.4 | 15.3 |
| 6 | 11510.00 | 46.7 AV | 54.0 | -7.3 | 1.29 H | 58 | 31.4 | 15.3 |
| 7 | #17265.00 | 50.8 PK | 68.2 | -17.4 | 1.58 H | 57 | 34.4 | 16.4 |

Remarks:

1. Emission Level(dBuV/m) = Raw Value(dBuV) + Correction Factor(dB/m)
2. Correction Factor(dB/m) = Antenna Factor(dB/m) + Cable Factor(dB) – Pre-Amplifier Factor(dB)
3. Margin value = Emission Level – Limit value
4. The other emission levels were very low against the limit.
5. " * " : Fundamental frequency, the limit was restricted at the RF Output Power.
6. " # " : The radiated frequency is out of the restricted band.

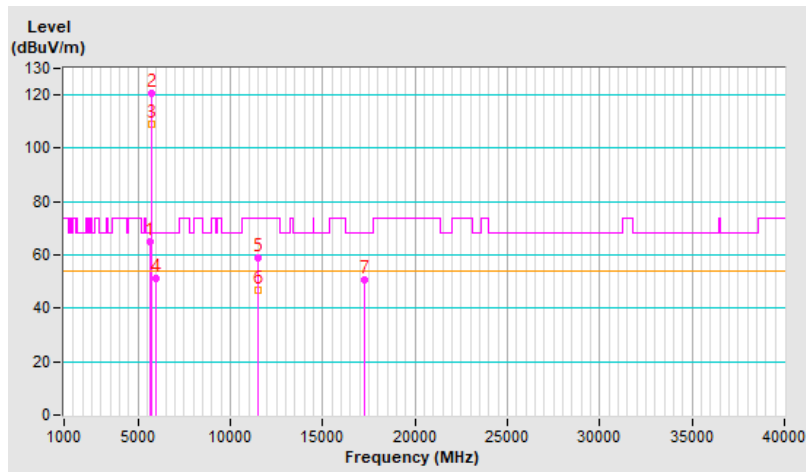

| | | | |
|-----------------------------|-----------------|--|--|
| RF Mode | 802.11ax (HE40) | Channel | CH 151 : 5755 MHz |
| Frequency Range | 1 GHz ~ 40 GHz | Detector Function & Bandwidth | Peak (PK), RB = 1 MHz, VB = 3 MHz Peak (AV), RB = 1 MHz, VB = 10 Hz |
| Input Power (System) | 120 Vac, 60 Hz | Environmental Conditions | 20°C, 69% RH |
| Tested By | Sampson Chen | | |

| Antenna Polarity & Test Distance : Vertical at 3 m | | | | | | | | |
|--|-----------------|-------------------------|----------------|-------------|--------------------|----------------------|------------------|--------------------------|
| No | Frequency (MHz) | Emission Level (dBuV/m) | Limit (dBuV/m) | Margin (dB) | Antenna Height (m) | Table Angle (Degree) | Raw Value (dBuV) | Correction Factor (dB/m) |
| 1 | #5644.73 | 66.4 PK | 68.2 | -1.8 | 1.50 V | 59 | 62.0 | 4.4 |
| 2 | *5755.00 | 119.1 PK | | | 1.50 V | 59 | 114.6 | 4.5 |
| 3 | *5755.00 | 107.5 AV | | | 1.50 V | 59 | 103.0 | 4.5 |
| 4 | #5959.13 | 51.4 PK | 68.2 | -16.8 | 1.50 V | 59 | 46.3 | 5.1 |
| 5 | 11510.00 | 59.3 PK | 74.0 | -14.7 | 2.81 V | 122 | 44.0 | 15.3 |
| 6 | 11510.00 | 47.3 AV | 54.0 | -6.7 | 2.81 V | 122 | 32.0 | 15.3 |
| 7 | #17265.00 | 46.8 PK | 68.2 | -21.4 | 1.55 V | 49 | 30.4 | 16.4 |

Remarks:

1. Emission Level(dBuV/m) = Raw Value(dBuV) + Correction Factor(dB/m)
2. Correction Factor(dB/m) = Antenna Factor(dB/m) + Cable Factor(dB) – Pre-Amplifier Factor(dB)
3. Margin value = Emission Level – Limit value
4. The other emission levels were very low against the limit.
5. " * " : Fundamental frequency, the limit was restricted at the RF Output Power.
6. " # " : The radiated frequency is out of the restricted band.

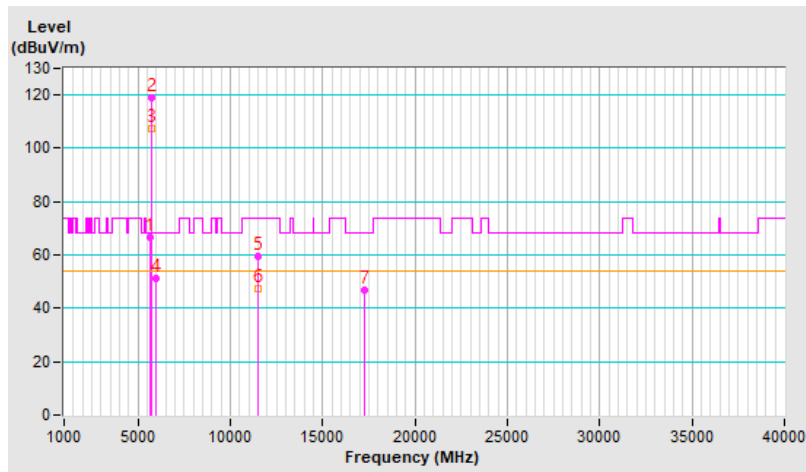

| | | | |
|-----------------------------|-----------------|--|--|
| RF Mode | 802.11ax (HE40) | Channel | CH 159 : 5795 MHz |
| Frequency Range | 1 GHz ~ 40 GHz | Detector Function & Bandwidth | Peak (PK), RB = 1 MHz, VB = 3 MHz Peak (AV), RB = 1 MHz, VB = 10 Hz |
| Input Power (System) | 120 Vac, 60 Hz | Environmental Conditions | 20°C, 69% RH |
| Tested By | Sampson Chen | | |

| Antenna Polarity & Test Distance : Horizontal at 3 m | | | | | | | | |
|--|-----------------|-------------------------|----------------|-------------|--------------------|----------------------|------------------|--------------------------|
| No | Frequency (MHz) | Emission Level (dBuV/m) | Limit (dBuV/m) | Margin (dB) | Antenna Height (m) | Table Angle (Degree) | Raw Value (dBuV) | Correction Factor (dB/m) |
| 1 | #5646.95 | 56.8 PK | 68.2 | -11.4 | 1.49 H | 356 | 52.4 | 4.4 |
| 2 | *5795.00 | 120.2 PK | | | 1.49 H | 356 | 115.7 | 4.5 |
| 3 | *5795.00 | 108.4 AV | | | 1.49 H | 356 | 103.9 | 4.5 |
| 4 | #5946.84 | 50.6 PK | 68.2 | -17.6 | 1.49 H | 356 | 45.5 | 5.1 |
| 5 | 11590.00 | 58.2 PK | 74.0 | -15.8 | 1.25 H | 58 | 43.2 | 15.0 |
| 6 | 11590.00 | 46.5 AV | 54.0 | -7.5 | 1.25 H | 58 | 31.5 | 15.0 |
| 7 | #17385.00 | 50.3 PK | 68.2 | -17.9 | 1.56 H | 64 | 33.1 | 17.2 |

Remarks:

1. Emission Level(dBuV/m) = Raw Value(dBuV) + Correction Factor(dB/m)
2. Correction Factor(dB/m) = Antenna Factor(dB/m) + Cable Factor(dB) – Pre-Amplifier Factor(dB)
3. Margin value = Emission Level – Limit value
4. The other emission levels were very low against the limit.
5. " * " : Fundamental frequency, the limit was restricted at the RF Output Power.
6. " # " : The radiated frequency is out of the restricted band.

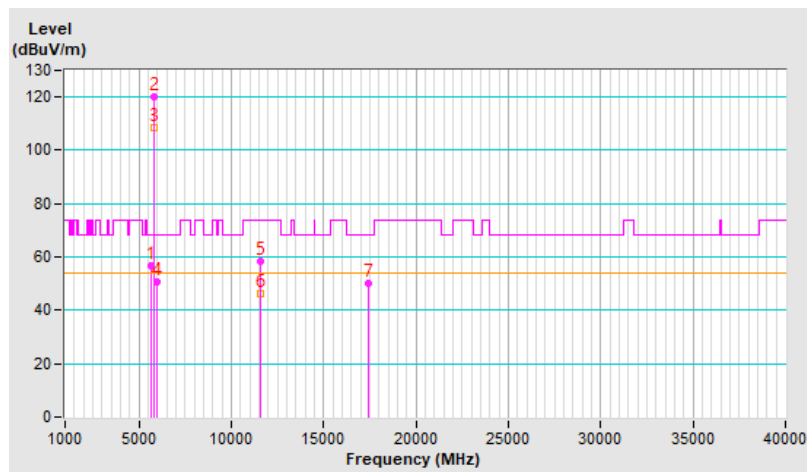

| | | | |
|-----------------------------|-----------------|--|--|
| RF Mode | 802.11ax (HE40) | Channel | CH 159 : 5795 MHz |
| Frequency Range | 1 GHz ~ 40 GHz | Detector Function & Bandwidth | Peak (PK), RB = 1 MHz, VB = 3 MHz Peak (AV), RB = 1 MHz, VB = 10 Hz |
| Input Power (System) | 120 Vac, 60 Hz | Environmental Conditions | 20°C, 69% RH |
| Tested By | Sampson Chen | | |

| Antenna Polarity & Test Distance : Vertical at 3 m | | | | | | | | |
|--|-----------------|-------------------------|----------------|-------------|--------------------|----------------------|------------------|--------------------------|
| No | Frequency (MHz) | Emission Level (dBuV/m) | Limit (dBuV/m) | Margin (dB) | Antenna Height (m) | Table Angle (Degree) | Raw Value (dBuV) | Correction Factor (dB/m) |
| 1 | #5647.30 | 56.2 PK | 68.2 | -12.0 | 2.50 V | 267 | 51.8 | 4.4 |
| 2 | *5795.00 | 119.4 PK | | | 2.50 V | 267 | 114.9 | 4.5 |
| 3 | *5795.00 | 107.7 AV | | | 2.50 V | 267 | 103.2 | 4.5 |
| 4 | #5935.00 | 51.1 PK | 68.2 | -17.1 | 2.50 V | 267 | 46.1 | 5.0 |
| 5 | 11590.00 | 58.8 PK | 74.0 | -15.2 | 2.73 V | 129 | 43.8 | 15.0 |
| 6 | 11590.00 | 47.0 AV | 54.0 | -7.0 | 2.73 V | 129 | 32.0 | 15.0 |
| 7 | #17385.00 | 46.2 PK | 68.2 | -22.0 | 1.48 V | 49 | 29.0 | 17.2 |

Remarks:

1. Emission Level(dBuV/m) = Raw Value(dBuV) + Correction Factor(dB/m)
2. Correction Factor(dB/m) = Antenna Factor(dB/m) + Cable Factor(dB) – Pre-Amplifier Factor(dB)
3. Margin value = Emission Level – Limit value
4. The other emission levels were very low against the limit.
5. " * " : Fundamental frequency, the limit was restricted at the RF Output Power.
6. " # " : The radiated frequency is out of the restricted band.

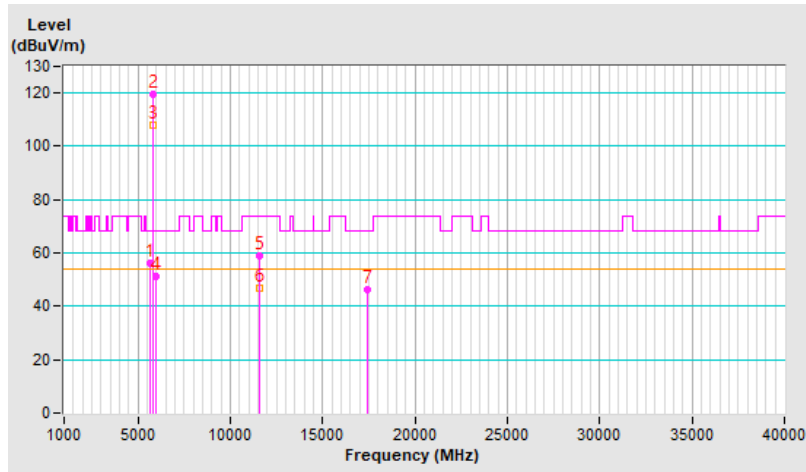

| | | | |
|-----------------------------|-----------------|--|--|
| RF Mode | 802.11ax (HE80) | Channel | CH 42 : 5210 MHz |
| Frequency Range | 1 GHz ~ 40 GHz | Detector Function & Bandwidth | Peak (PK), RB = 1 MHz, VB = 3 MHz Peak (AV), RB = 1 MHz, VB = 10 Hz |
| Input Power (System) | 120 Vac, 60 Hz | Environmental Conditions | 25°C, 75% RH |
| Tested By | Sampson Chen | | |

| Antenna Polarity & Test Distance : Horizontal at 3 m | | | | | | | | |
|--|-----------------|-------------------------|----------------|-------------|--------------------|----------------------|------------------|--------------------------|
| No | Frequency (MHz) | Emission Level (dBuV/m) | Limit (dBuV/m) | Margin (dB) | Antenna Height (m) | Table Angle (Degree) | Raw Value (dBuV) | Correction Factor (dB/m) |
| 1 | 5150.00 | 61.0 PK | 74.0 | -13.0 | 1.35 H | 334 | 57.4 | 3.6 |
| 2 | 5150.00 | 50.6 AV | 54.0 | -3.4 | 1.35 H | 334 | 47.0 | 3.6 |
| 3 | *5210.00 | 109.4 PK | | | 1.35 H | 334 | 106.1 | 3.3 |
| 4 | *5210.00 | 99.6 AV | | | 1.35 H | 334 | 96.3 | 3.3 |
| 5 | 5350.00 | 51.0 PK | 74.0 | -23.0 | 1.35 H | 334 | 47.7 | 3.3 |
| 6 | 5350.00 | 40.4 AV | 54.0 | -13.6 | 1.35 H | 334 | 37.1 | 3.3 |
| 7 | #10420.00 | 38.2 PK | 68.2 | -30.0 | 1.38 H | 330 | 24.3 | 13.9 |
| 8 | 15630.00 | 47.6 PK | 74.0 | -26.4 | 1.55 H | 250 | 32.6 | 15.0 |
| 9 | 15630.00 | 34.3 AV | 54.0 | -19.7 | 1.55 H | 250 | 19.3 | 15.0 |

Remarks:

1. Emission Level(dBuV/m) = Raw Value(dBuV) + Correction Factor(dB/m)
2. Correction Factor(dB/m) = Antenna Factor(dB/m) + Cable Factor(dB) – Pre-Amplifier Factor(dB)
3. Margin value = Emission Level – Limit value
4. The other emission levels were very low against the limit.
5. " * " : Fundamental frequency, the limit was restricted at the RF Output Power.
6. " # " : The radiated frequency is out of the restricted band.

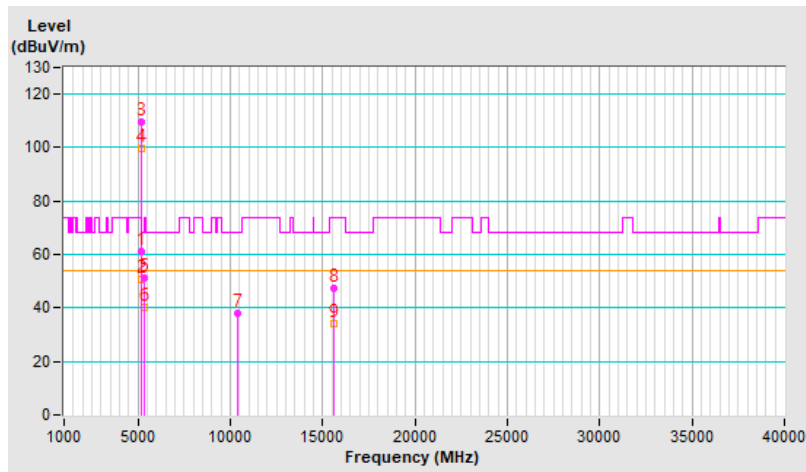

| | | | |
|-----------------------------|-----------------|--|--|
| RF Mode | 802.11ax (HE80) | Channel | CH 42 : 5210 MHz |
| Frequency Range | 1 GHz ~ 40 GHz | Detector Function & Bandwidth | Peak (PK), RB = 1 MHz, VB = 3 MHz Peak (AV), RB = 1 MHz, VB = 10 Hz |
| Input Power (System) | 120 Vac, 60 Hz | Environmental Conditions | 25°C, 75% RH |
| Tested By | Sampson Chen | | |

| Antenna Polarity & Test Distance : Vertical at 3 m | | | | | | | | |
|--|-----------------|-------------------------|----------------|-------------|--------------------|----------------------|------------------|--------------------------|
| No | Frequency (MHz) | Emission Level (dBuV/m) | Limit (dBuV/m) | Margin (dB) | Antenna Height (m) | Table Angle (Degree) | Raw Value (dBuV) | Correction Factor (dB/m) |
| 1 | 5150.00 | 63.9 PK | 74.0 | -10.1 | 2.68 V | 58 | 60.3 | 3.6 |
| 2 | 5150.00 | 52.8 AV | 54.0 | -1.2 | 2.68 V | 58 | 49.2 | 3.6 |
| 3 | *5210.00 | 110.6 PK | | | 2.68 V | 58 | 107.3 | 3.3 |
| 4 | *5210.00 | 101.8 AV | | | 2.68 V | 58 | 98.5 | 3.3 |
| 5 | 5350.00 | 52.2 PK | 74.0 | -21.8 | 2.68 V | 58 | 48.9 | 3.3 |
| 6 | 5350.00 | 40.9 AV | 54.0 | -13.1 | 2.68 V | 58 | 37.6 | 3.3 |
| 7 | #10420.00 | 46.5 PK | 68.2 | -21.7 | 2.15 V | 218 | 32.6 | 13.9 |
| 8 | 15630.00 | 49.8 PK | 74.0 | -24.2 | 1.58 V | 133 | 34.8 | 15.0 |
| 9 | 15630.00 | 39.3 AV | 54.0 | -14.7 | 1.58 V | 133 | 24.3 | 15.0 |

Remarks:

1. Emission Level(dBuV/m) = Raw Value(dBuV) + Correction Factor(dB/m)
2. Correction Factor(dB/m) = Antenna Factor(dB/m) + Cable Factor(dB) – Pre-Amplifier Factor(dB)
3. Margin value = Emission Level – Limit value
4. The other emission levels were very low against the limit.
5. " * " : Fundamental frequency, the limit was restricted at the RF Output Power.
6. " # " : The radiated frequency is out of the restricted band.

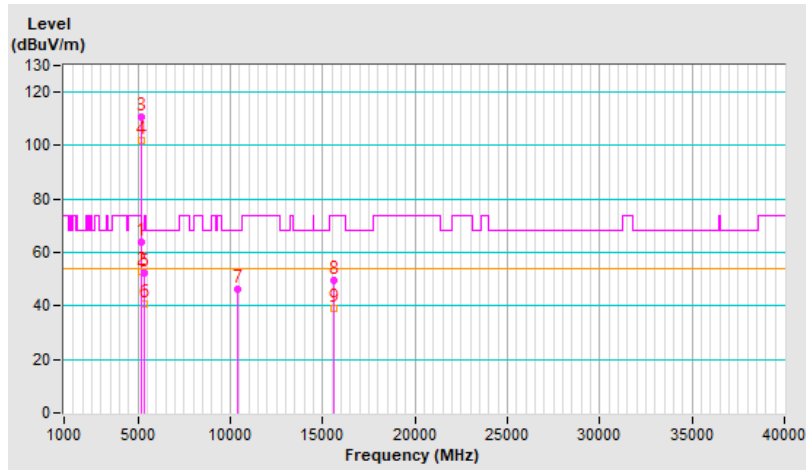

| | | | |
|-----------------------------|-----------------|--|--|
| RF Mode | 802.11ax (HE80) | Channel | CH 155 : 5775 MHz |
| Frequency Range | 1 GHz ~ 40 GHz | Detector Function & Bandwidth | Peak (PK), RB = 1 MHz, VB = 3 MHz Peak (AV), RB = 1 MHz, VB = 10 Hz |
| Input Power (System) | 120 Vac, 60 Hz | Environmental Conditions | 20°C, 69% RH |
| Tested By | Sampson Chen | | |

| Antenna Polarity & Test Distance : Horizontal at 3 m | | | | | | | | |
|--|-----------------|-------------------------|----------------|-------------|--------------------|----------------------|------------------|--------------------------|
| No | Frequency (MHz) | Emission Level (dBuV/m) | Limit (dBuV/m) | Margin (dB) | Antenna Height (m) | Table Angle (Degree) | Raw Value (dBuV) | Correction Factor (dB/m) |
| 1 | #5646.10 | 66.8 PK | 68.2 | -1.4 | 1.51 H | 359 | 62.4 | 4.4 |
| 2 | *5775.00 | 116.2 PK | | | 1.51 H | 359 | 111.7 | 4.5 |
| 3 | *5775.00 | 104.6 AV | | | 1.51 H | 359 | 100.1 | 4.5 |
| 4 | #5935.45 | 51.0 PK | 68.2 | -17.2 | 1.51 H | 359 | 46.0 | 5.0 |
| 5 | 11550.00 | 53.4 PK | 74.0 | -20.6 | 1.24 H | 71 | 38.2 | 15.2 |
| 6 | 11550.00 | 42.8 AV | 54.0 | -11.2 | 1.24 H | 71 | 27.6 | 15.2 |
| 7 | #17325.00 | 46.7 PK | 68.2 | -21.5 | 1.50 H | 55 | 29.7 | 17.0 |

Remarks:

1. Emission Level(dBuV/m) = Raw Value(dBuV) + Correction Factor(dB/m)
2. Correction Factor(dB/m) = Antenna Factor(dB/m) + Cable Factor(dB) – Pre-Amplifier Factor(dB)
3. Margin value = Emission Level – Limit value
4. The other emission levels were very low against the limit.
5. " * ": Fundamental frequency, the limit was restricted at the RF Output Power.
6. " # ": The radiated frequency is out of the restricted band.

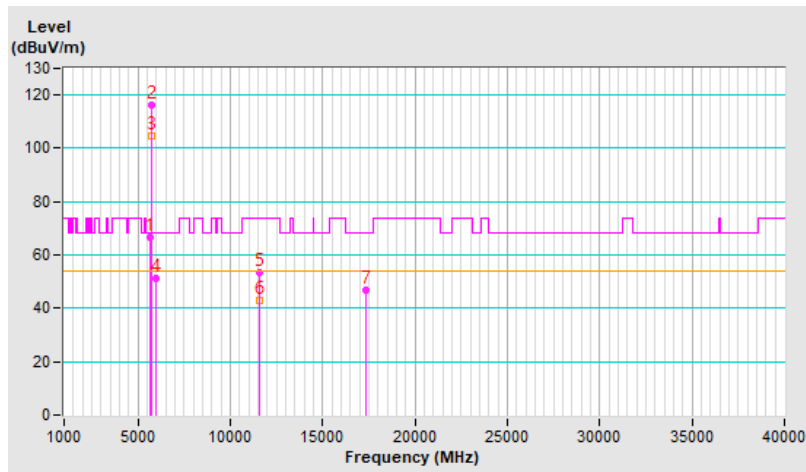

| | | | |
|-----------------------------|-----------------|--|--|
| RF Mode | 802.11ax (HE80) | Channel | CH 155 : 5775 MHz |
| Frequency Range | 1 GHz ~ 40 GHz | Detector Function & Bandwidth | Peak (PK), RB = 1 MHz, VB = 3 MHz Peak (AV), RB = 1 MHz, VB = 10 Hz |
| Input Power (System) | 120 Vac, 60 Hz | Environmental Conditions | 20°C, 69% RH |
| Tested By | Sampson Chen | | |

| Antenna Polarity & Test Distance : Vertical at 3 m | | | | | | | | |
|--|-----------------|-------------------------|----------------|-------------|--------------------|----------------------|------------------|--------------------------|
| No | Frequency (MHz) | Emission Level (dBuV/m) | Limit (dBuV/m) | Margin (dB) | Antenna Height (m) | Table Angle (Degree) | Raw Value (dBuV) | Correction Factor (dB/m) |
| 1 | #5648.85 | 64.6 PK | 68.2 | -3.6 | 2.10 V | 257 | 60.2 | 4.4 |
| 2 | *5775.00 | 115.4 PK | | | 2.10 V | 257 | 110.9 | 4.5 |
| 3 | *5775.00 | 103.7 AV | | | 2.10 V | 257 | 99.2 | 4.5 |
| 4 | #5938.44 | 52.2 PK | 68.2 | -16.0 | 2.10 V | 257 | 47.2 | 5.0 |
| 5 | 11550.00 | 54.1 PK | 74.0 | -19.9 | 2.82 V | 134 | 38.9 | 15.2 |
| 6 | 11550.00 | 43.7 AV | 54.0 | -10.3 | 2.82 V | 134 | 28.5 | 15.2 |
| 7 | #17325.00 | 44.3 PK | 68.2 | -23.9 | 1.50 V | 43 | 27.3 | 17.0 |

Remarks:

1. Emission Level(dBuV/m) = Raw Value(dBuV) + Correction Factor(dB/m)
2. Correction Factor(dB/m) = Antenna Factor(dB/m) + Cable Factor(dB) – Pre-Amplifier Factor(dB)
3. Margin value = Emission Level – Limit value
4. The other emission levels were very low against the limit.
5. " * " : Fundamental frequency, the limit was restricted at the RF Output Power.
6. " # " : The radiated frequency is out of the restricted band.

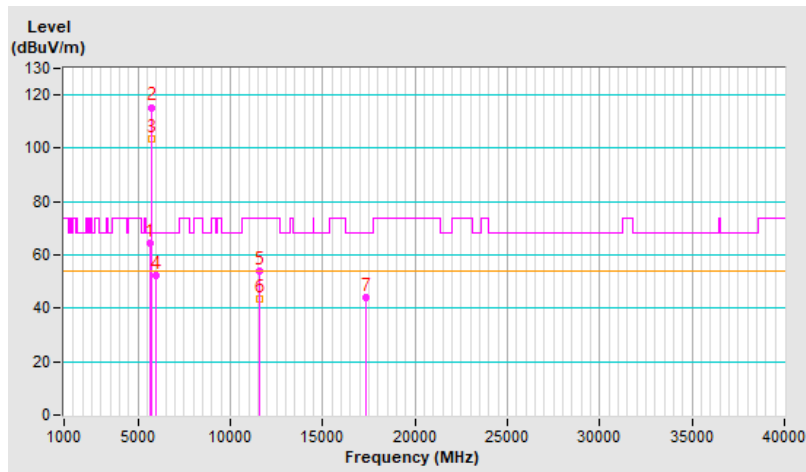

Plot of Band Edge

| | | | |
|-----------------|--------------------|-------------------------------|--|
| Frequency Range | 4.5 GHz ~ 5.46 GHz | Detector Function & Bandwidth | Peak (PK), RB = 1 MHz, VB = 3 MHz Peak (AV), RB = 1 MHz, VB = 10 Hz |
|-----------------|--------------------|-------------------------------|--|

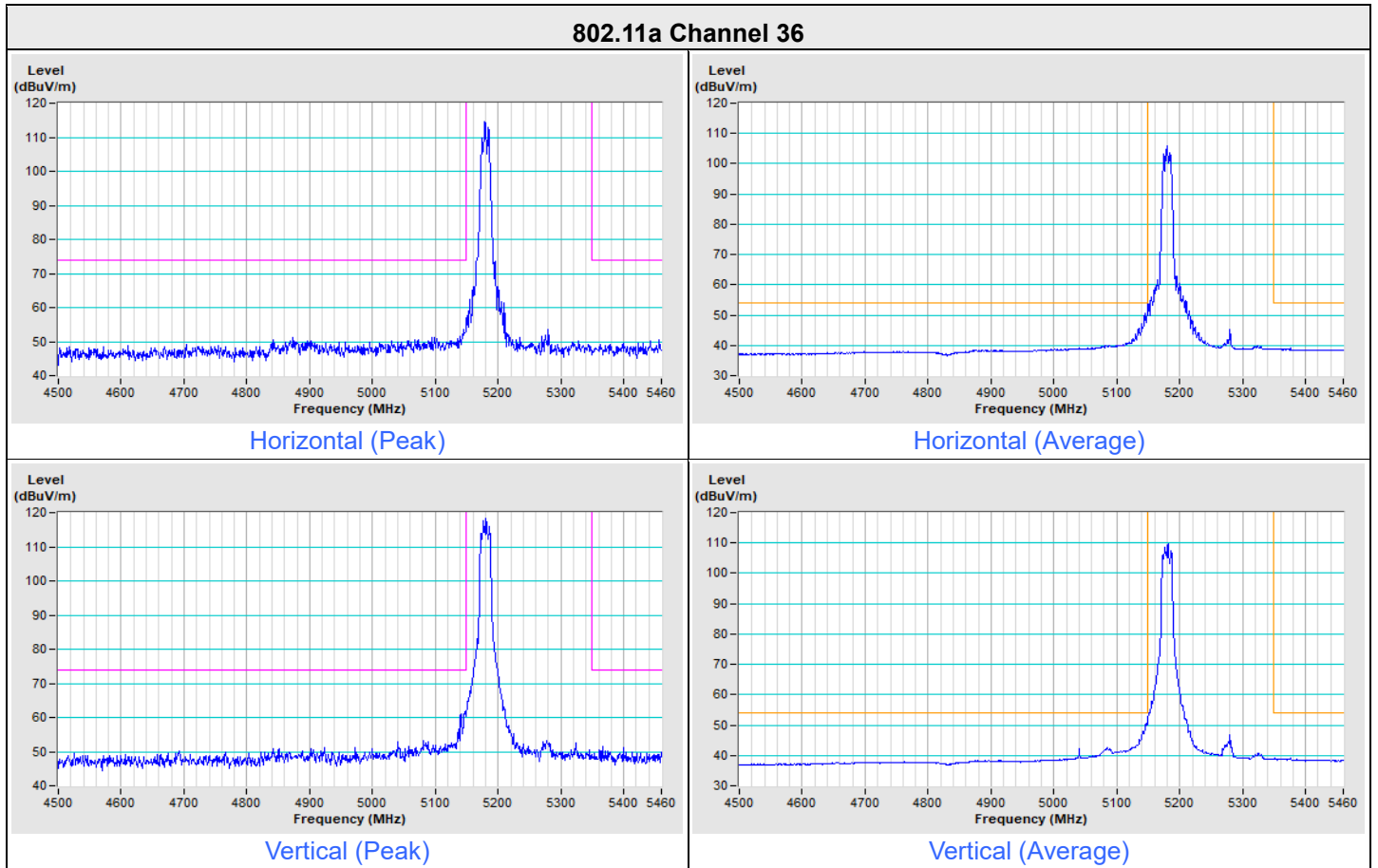

802.11a Channel 48

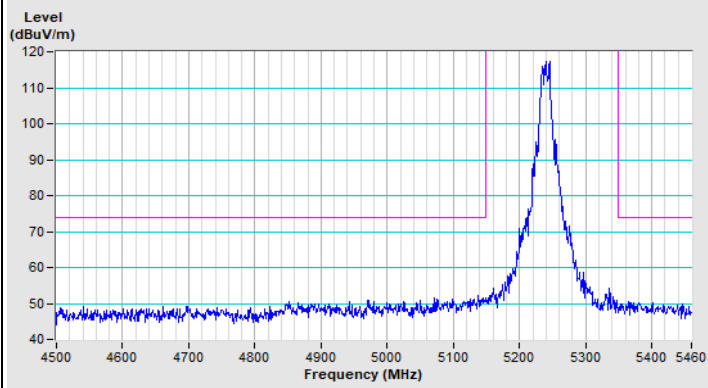

Horizontal (Peak)

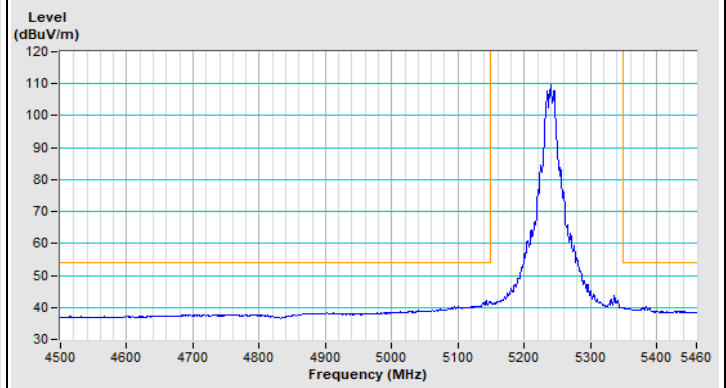

Horizontal (Average)

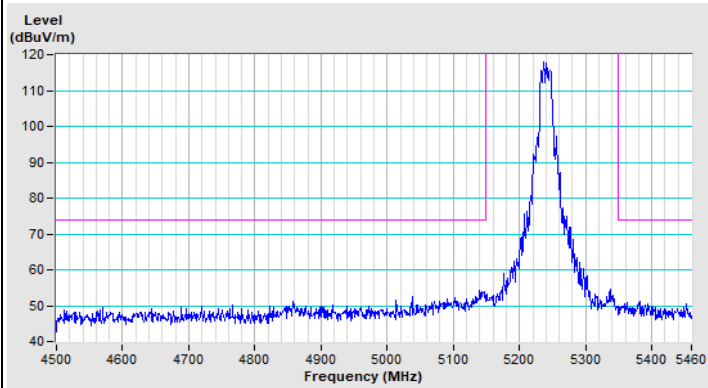

Vertical (Peak)

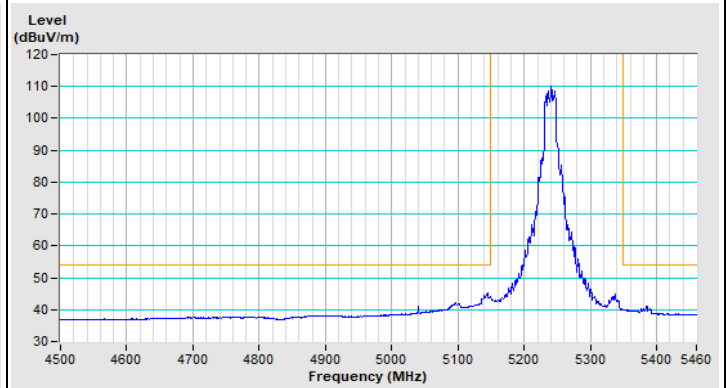

Vertical (Average)

| | | | |
|-----------------|----------------------|-------------------------------|-----------------------------------|
| Frequency Range | 5.55 GHz ~ 6.025 GHz | Detector Function & Bandwidth | Peak (PK), RB = 1 MHz, VB = 3 MHz |
|-----------------|----------------------|-------------------------------|-----------------------------------|

802.11a Channel 149

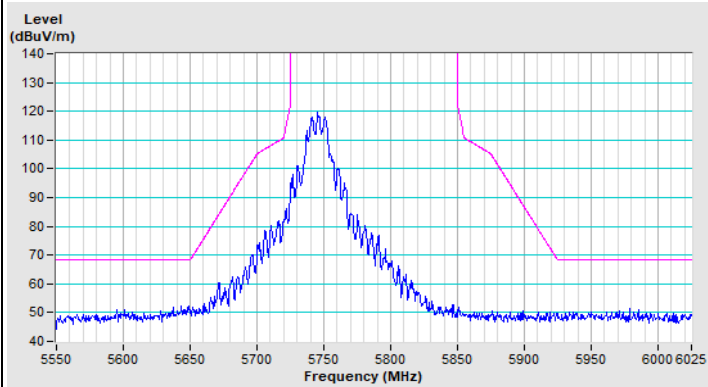

Horizontal (Peak)

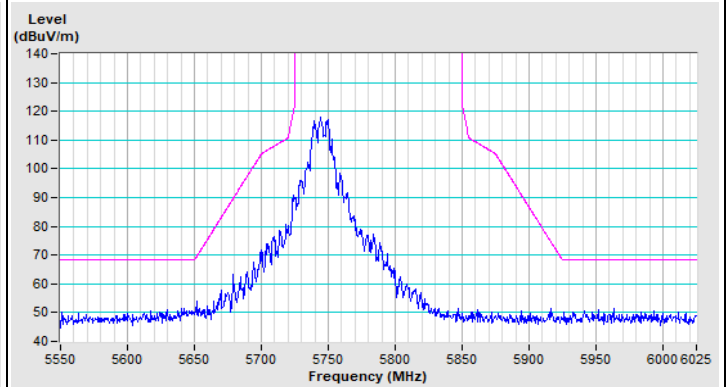

Vertical (Peak)

802.11a Channel 157

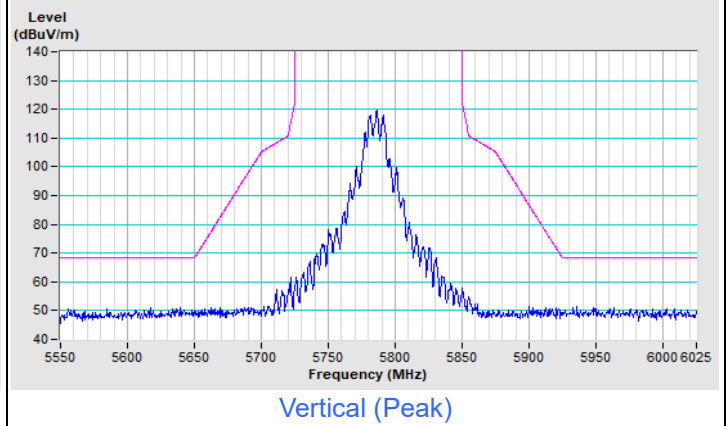
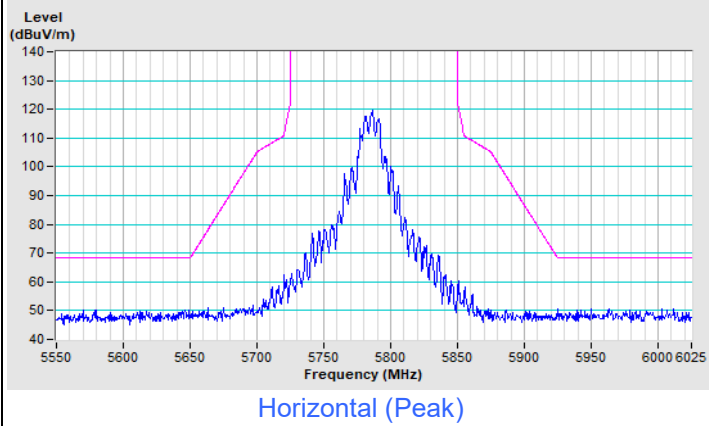

802.11a Channel 165

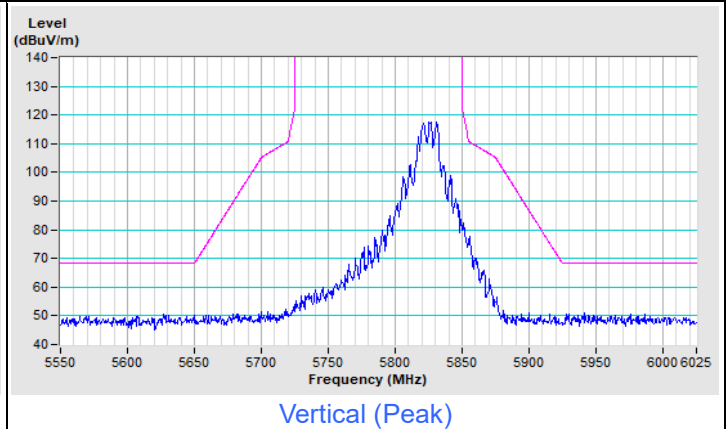
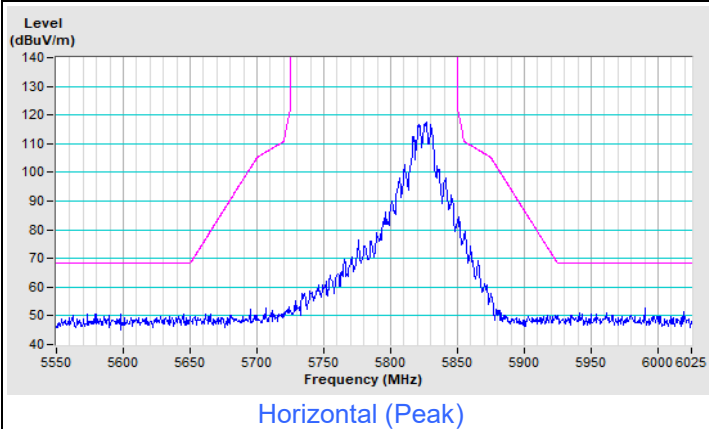

| | | | |
|-----------------|--------------------|-------------------------------|--|
| Frequency Range | 4.5 GHz ~ 5.46 GHz | Detector Function & Bandwidth | Peak (PK), RB = 1 MHz, VB = 3 MHz Peak (AV), RB = 1 MHz, VB = 10 Hz |
|-----------------|--------------------|-------------------------------|--|

802.11ax (HE20) Channel 36

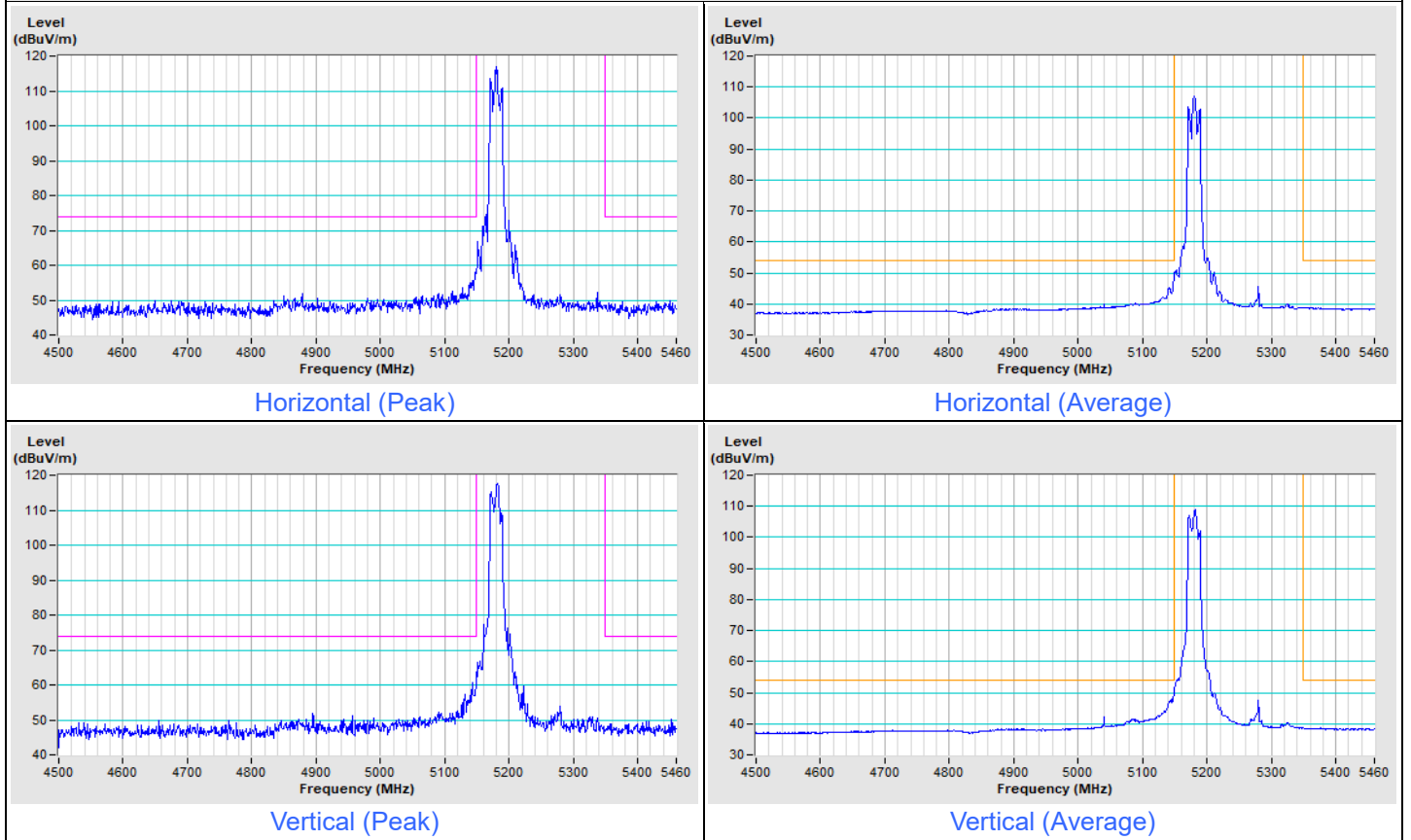

802.11ax (HE20) Channel 48

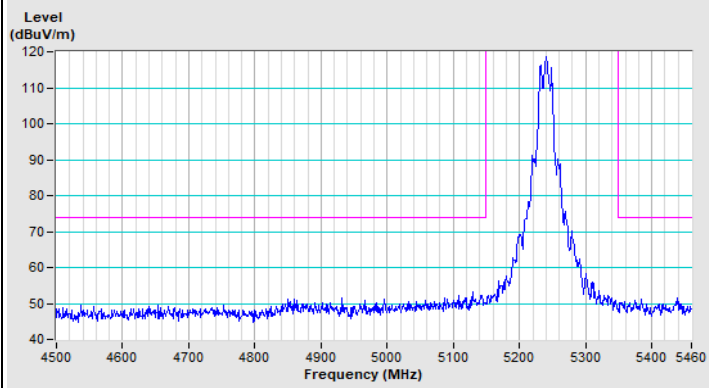

Horizontal (Peak)

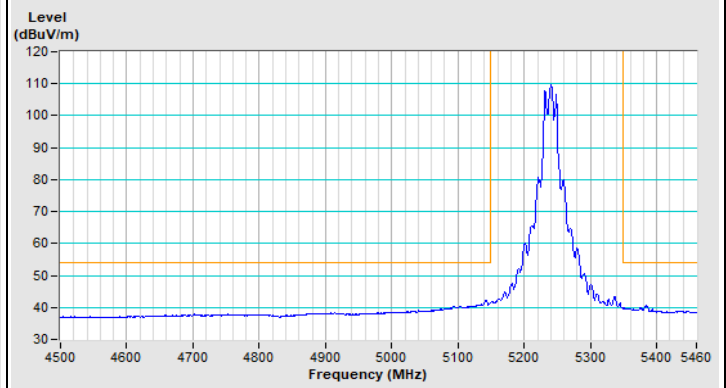

Horizontal (Average)

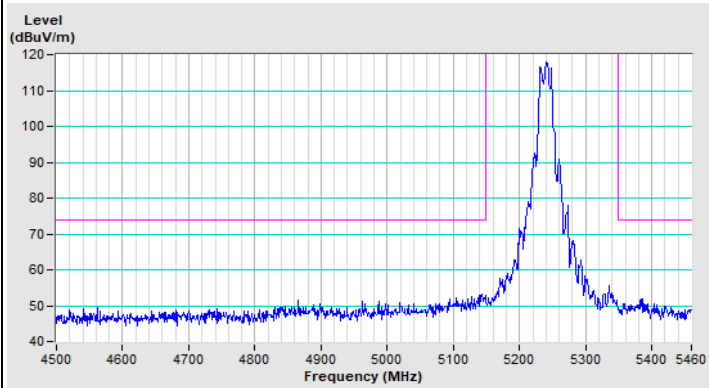

Vertical (Peak)

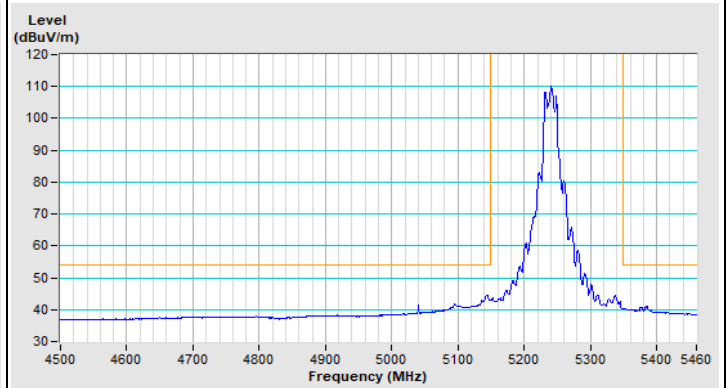

Vertical (Average)

| | | | |
|-----------------|----------------------|-------------------------------|-----------------------------------|
| Frequency Range | 5.55 GHz ~ 6.025 GHz | Detector Function & Bandwidth | Peak (PK), RB = 1 MHz, VB = 3 MHz |
|-----------------|----------------------|-------------------------------|-----------------------------------|

802.11ax (HE20) Channel 149

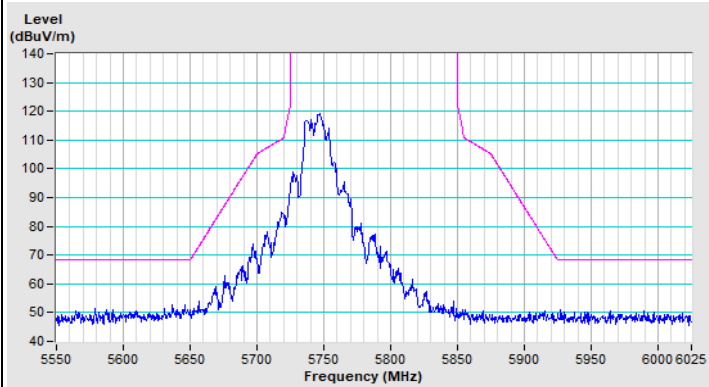

Horizontal (Peak)

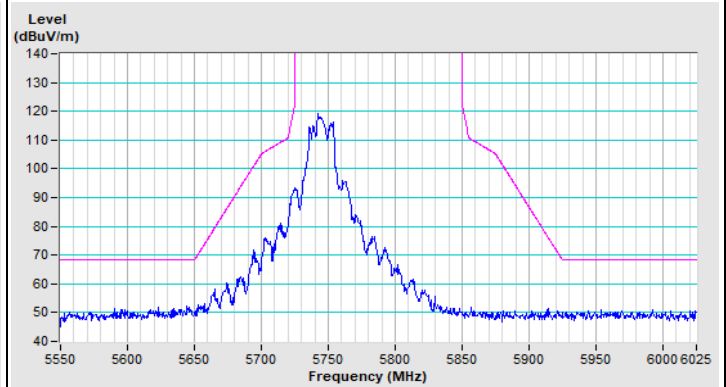

Vertical (Peak)

802.11ax (HE20) Channel 157

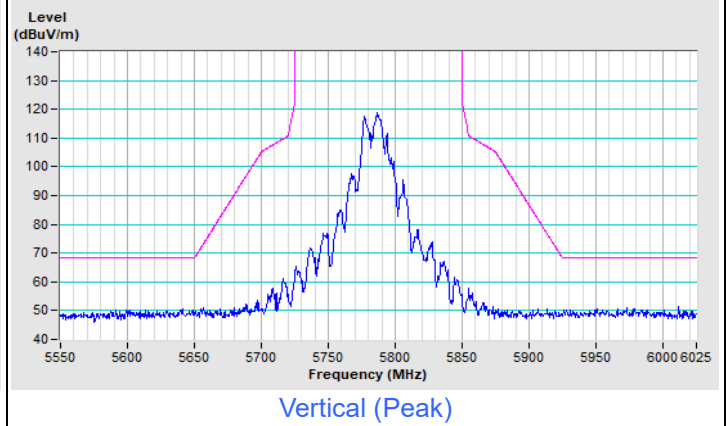
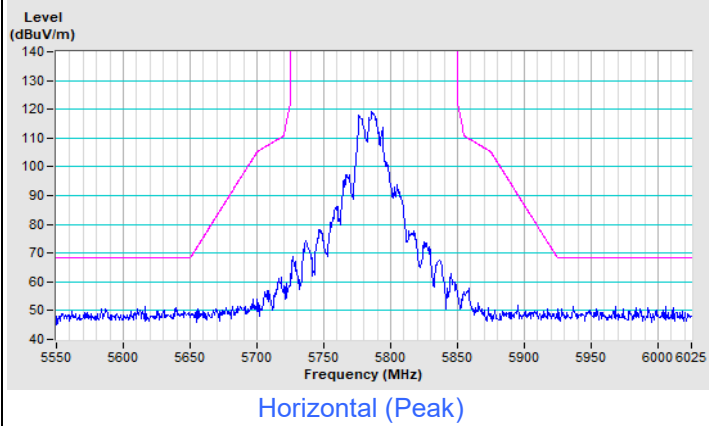

802.11ax (HE20) Channel 165

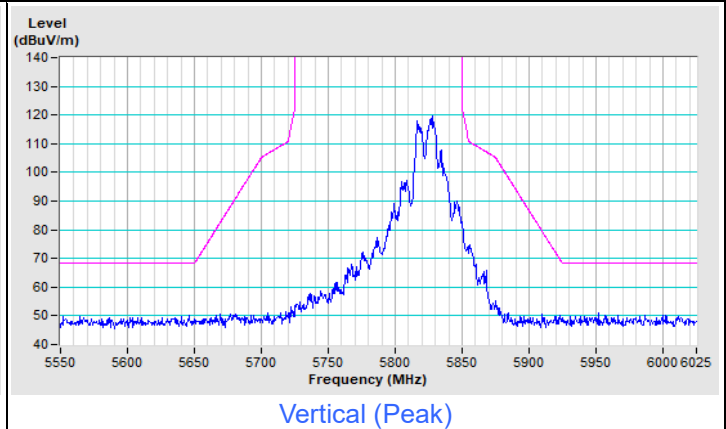
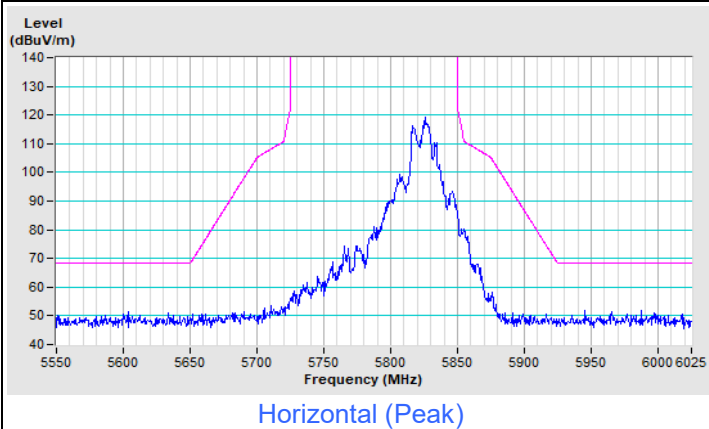

| | | | |
|-----------------|--------------------|-------------------------------|--|
| Frequency Range | 4.5 GHz ~ 5.46 GHz | Detector Function & Bandwidth | Peak (PK), RB = 1 MHz, VB = 3 MHz Peak (AV), RB = 1 MHz, VB = 10 Hz |
|-----------------|--------------------|-------------------------------|--|

802.11ax (HE40) Channel 38

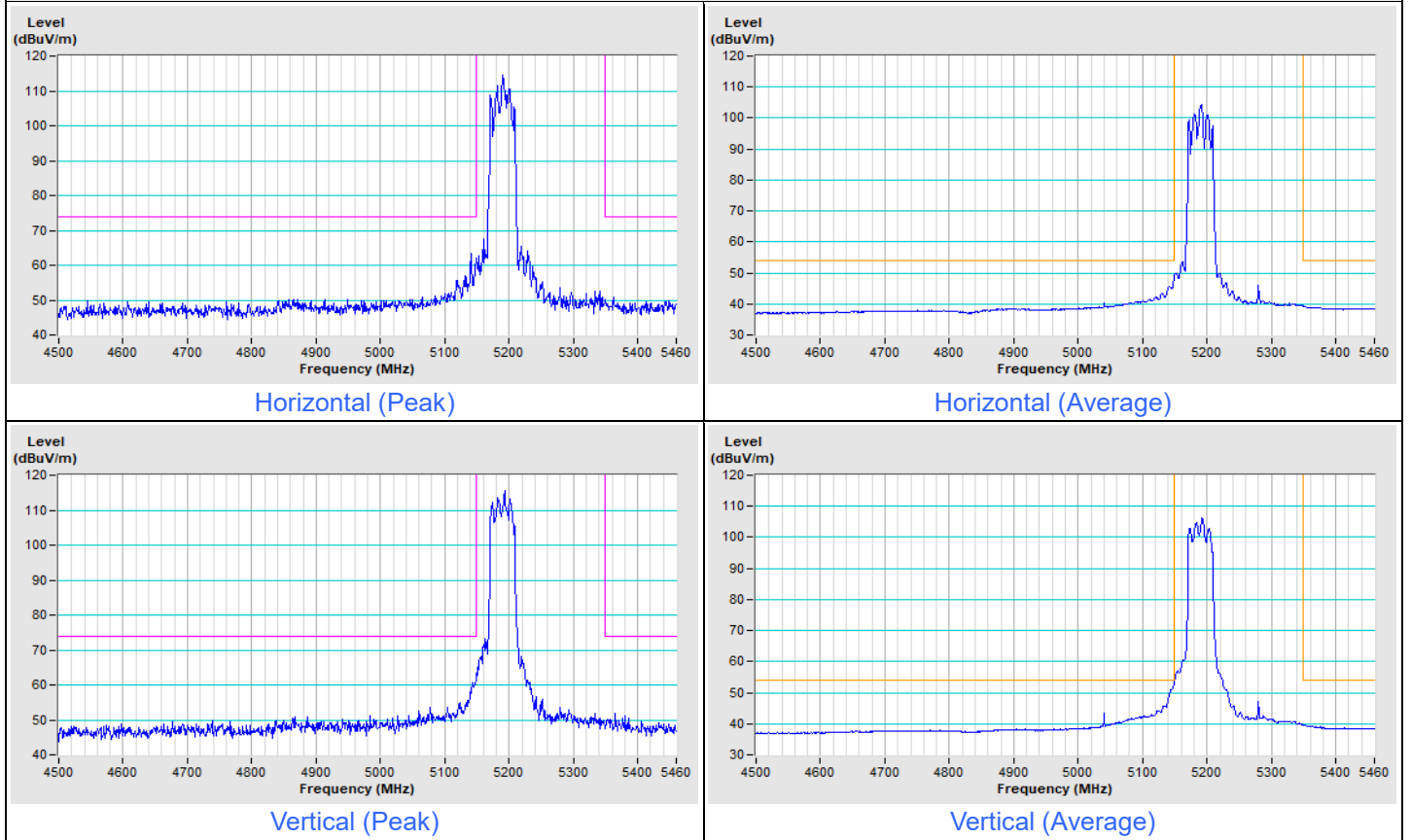

802.11ax (HE40) Channel 46

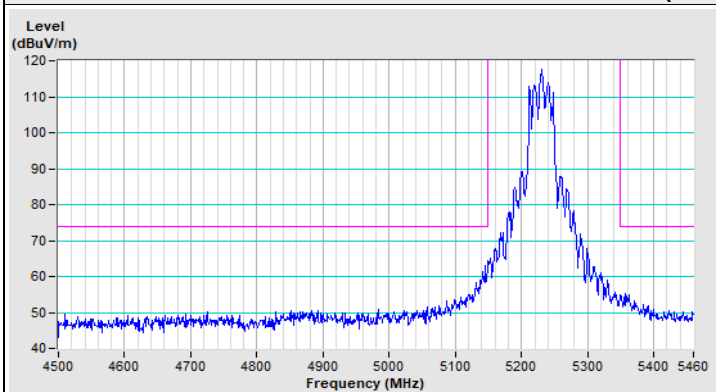

Horizontal (Peak)

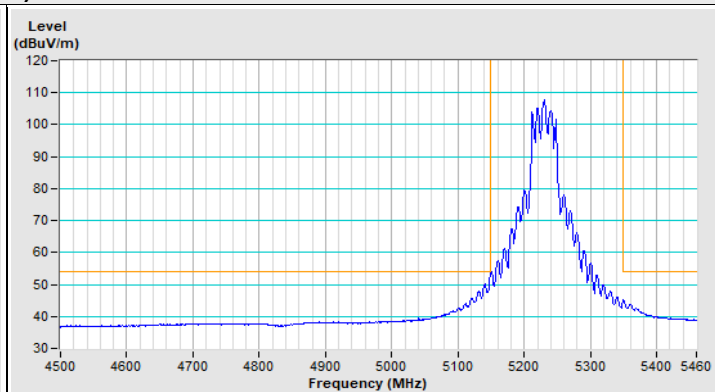

Horizontal (Average)

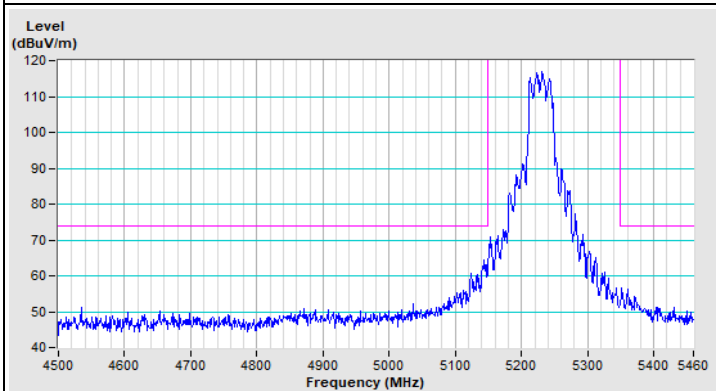

Vertical (Peak)

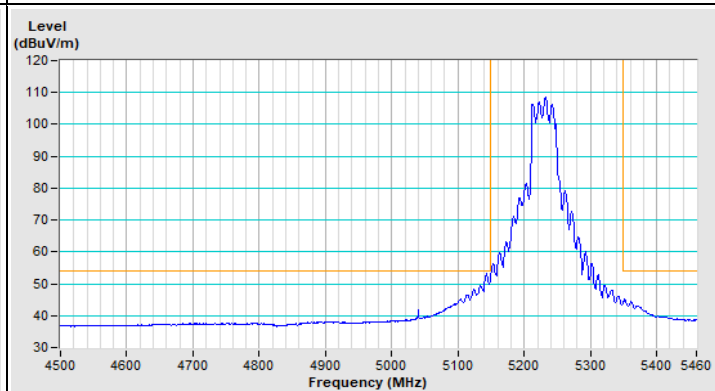

Vertical (Average)

| | | | |
|-----------------|----------------------|-------------------------------|-----------------------------------|
| Frequency Range | 5.55 GHz ~ 6.025 GHz | Detector Function & Bandwidth | Peak (PK), RB = 1 MHz, VB = 3 MHz |
|-----------------|----------------------|-------------------------------|-----------------------------------|

802.11ax (HE40) Channel 151

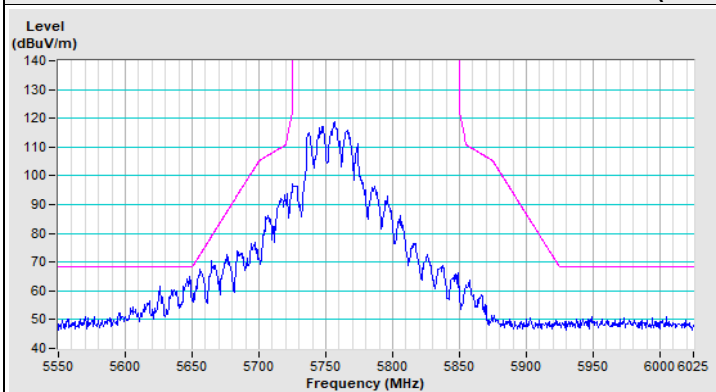

Horizontal (Peak)

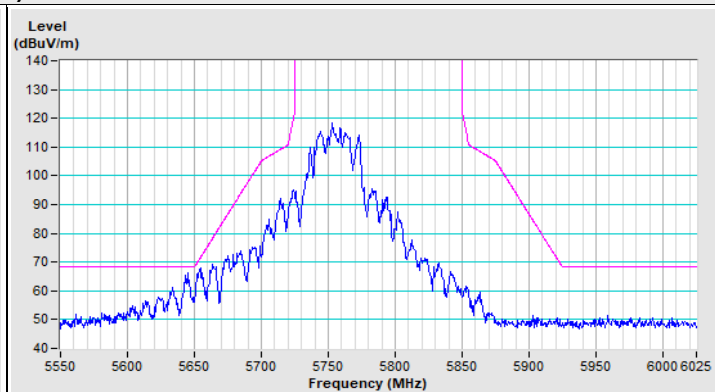

Vertical (Peak)

802.11ax (HE40) Channel 159

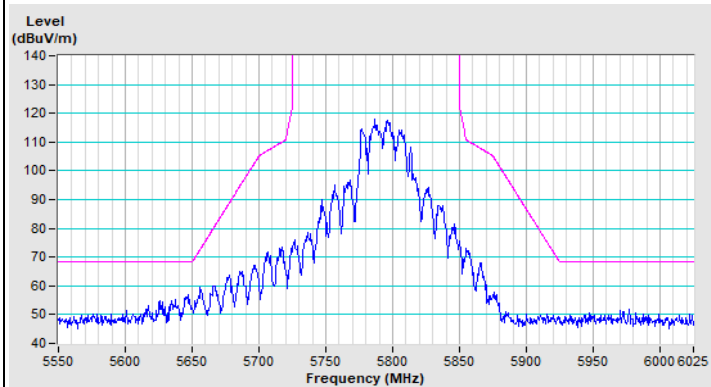

Horizontal (Peak)

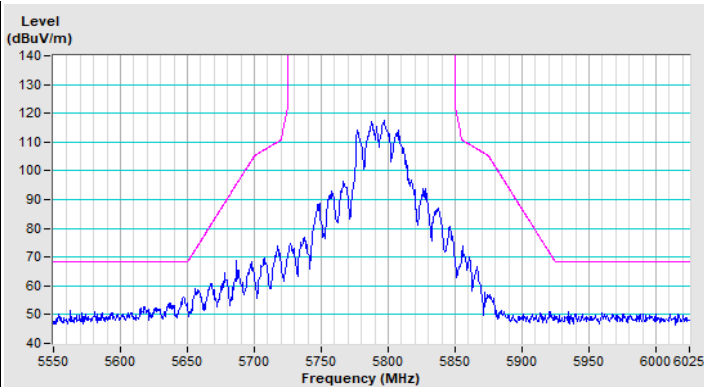

Vertical (Peak)

| | | | |
|-----------------|--------------------|-------------------------------|--|
| Frequency Range | 4.5 GHz ~ 5.46 GHz | Detector Function & Bandwidth | Peak (PK), RB = 1 MHz, VB = 3 MHz Peak (AV), RB = 1 MHz, VB = 10 Hz |
|-----------------|--------------------|-------------------------------|--|

802.11ax (HE80) Channel 42

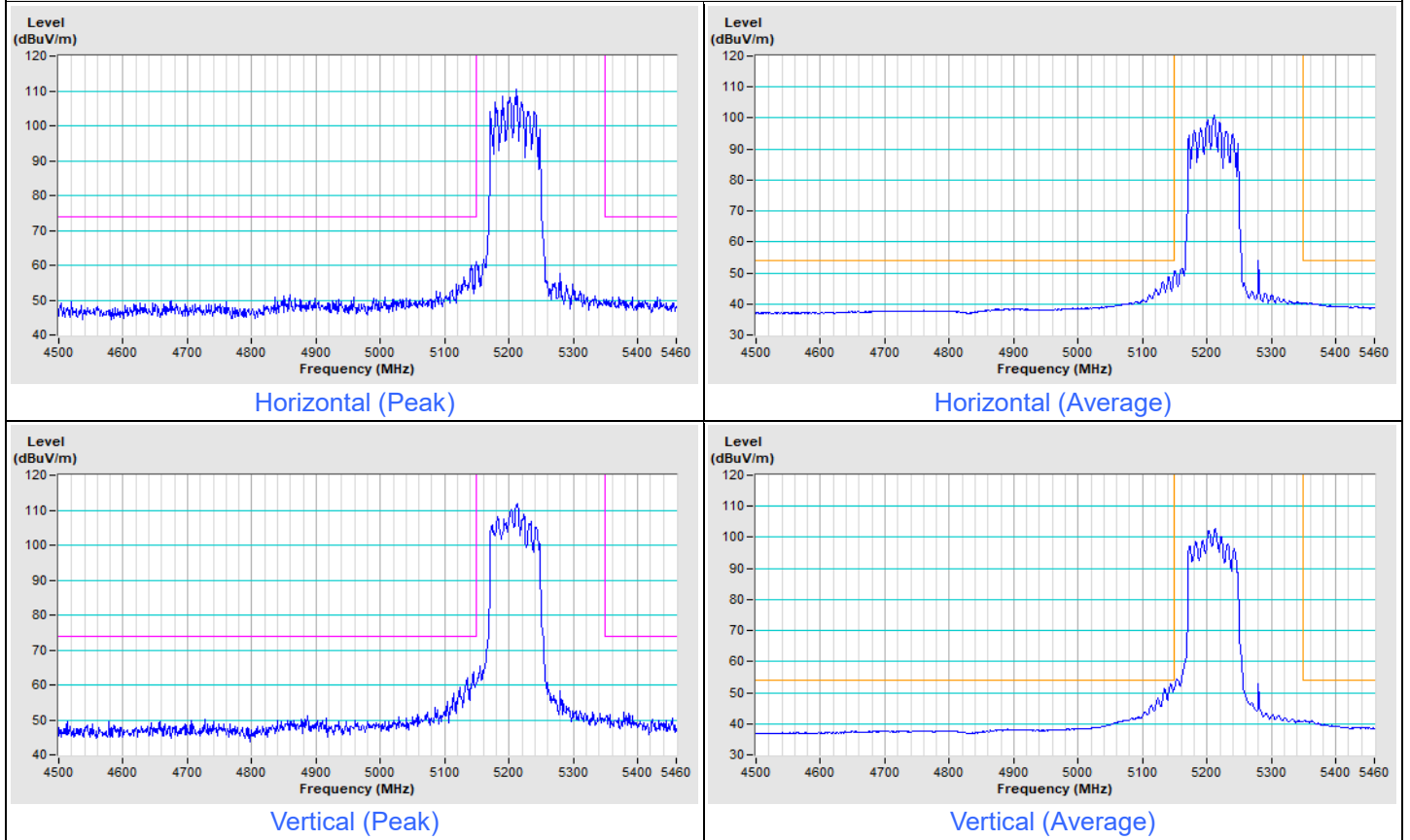

| | | | |
|-----------------|----------------------|-------------------------------|-----------------------------------|
| Frequency Range | 5.55 GHz ~ 6.025 GHz | Detector Function & Bandwidth | Peak (PK), RB = 1 MHz, VB = 3 MHz |
|-----------------|----------------------|-------------------------------|-----------------------------------|

802.11ax (HE80) Channel 155

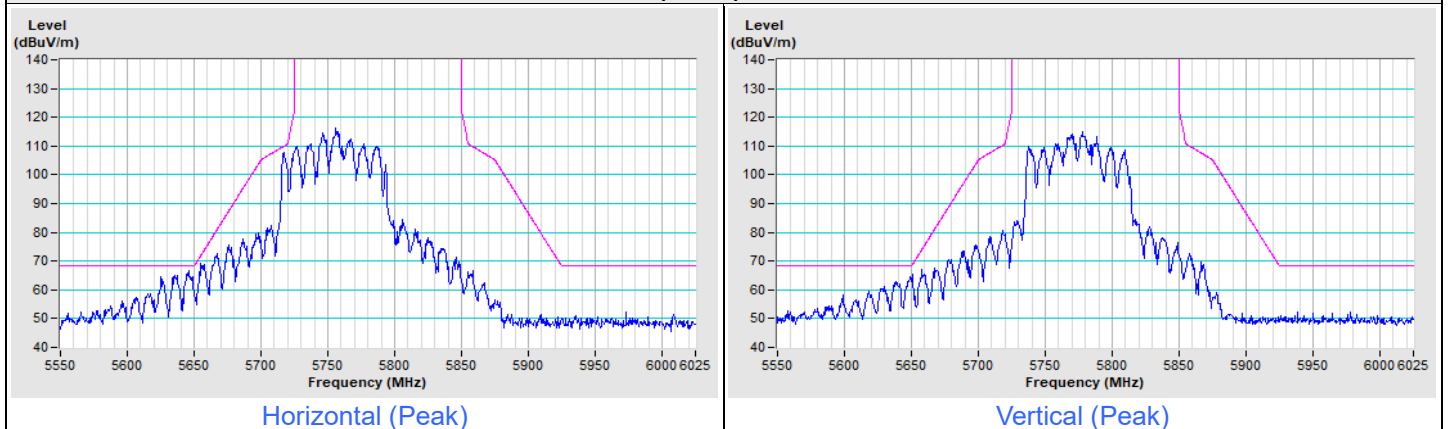

8 Pictures of Test Arrangements

Please refer to the attached file (Test Setup Photo)

9 Information of the Testing Laboratories

We, Bureau Veritas Consumer Products Services (H.K.) Ltd., Taoyuan Branch, were founded in 1988 to provide our best service in EMC, Radio, Telecom and Safety consultation. Our laboratories are FCC recognized accredited test firms and accredited according to ISO/IEC 17025.

If you have any comments, please feel free to contact us at the following:

Lin Kou EMC/RF Lab

Tel: 886-2-26052180

Fax: 886-2-26051924

Hsin Chu EMC/RF/Telecom Lab

Tel: 886-3-6668565

Fax: 886-3-6668323

Hwa Ya EMC/RF/Safety Lab

Tel: 886-3-3183232

Fax: 886-3-3270892

Email: service.adt@bureauveritas.com

Web Site: <http://ee.bureauveritas.com.tw>

The address and road map of all our labs can be found in our web site also.

--- END ---