

# SAR TEST REPORT

## Test Report No. 14937749H-E-R3

Customer	KEYENCE CORPORATION
Description of EUT	WLAN unit
Model Number of EUT	WM-WL
FCC ID	RF41637A
Test Regulation	FCC47CFR 2.1093
Test Result	Complied
Issue Date	April 17, 2024
Remarks	The highest reported SAR Body : 0.68 W/kg (1 g)

**Representative Test Engineer**Hisayoshi Sato  
Engineer**Approved By**Satofumi Matsuyama  
Engineer

CERTIFICATE 5107.02

- The testing in which "Non-accreditation" is displayed is outside the accreditation scopes in UL Japan, Inc.  
 There is no testing item of "Non-accreditation".

Report Cover Page - Form-ULID-003532 (DCS:13-EM-F0429) Issue# 23.0

## ANNOUNCEMENT

- This test report shall not be reproduced in full or partial, without the written approval of UL Japan, Inc.
- The results in this report apply only to the sample tested. (Laboratory was not involved in sampling.)
- This sample tested is in compliance with the limits of the above regulation.
- The test results in this test report are traceable to the national or international standards.
- This test report must not be used by the customer to claim product certification, approval, or endorsement by the A2LA accreditation body.
- This test report covers SAR technical requirements.  
It does not cover administrative issues such as Manual or non-SAR test related Requirements. (if applicable)
- The all test items in this test report are conducted by UL Japan, Inc. Ise EMC Lab.
- The opinions and the interpretations to the result of the description in this report are outside scopes where UL Japan, Inc. has been accredited.
- The information provided from the customer for this report is identified in Section 1.
- For test report(s) referred in this report, the latest version (including any revisions) is always referred.

## REVISION HISTORY

### Original Test Report No. 14937749H-E

This report is a revised version of 14937749H-E-R2. 14937749H-E-R2 is replaced with this report.

Revision	Test report No.	Date	Page Revised Contents
- (Original)	14937749H-E	December 7, 2023	-
1	14937749H-E-R1	January 12, 2024	Cover Page. SECTION 2.1 -Correction of Description of EUT. Wide area CMM→WLAN unit
1	14937749H-E-R1	January 12, 2024	SECTION 2.2: Product Description Radio Specification  -Addition of below note. This report contains data provided by the customer which can impact the validity of results. UL Japan, Inc. is only responsible for the validity of results after the integration of the data provided by the customer. The data provided by the customer is marked "a)" in the table below.  -Addition of a) in the item of antenna gain.
2	14937749H-E-R2	April 8, 2024	2.2: Product Description-  General Specification -Correction of Body-worn accessory. Battery unit→Relay unit.  *1 <Information of the Battery unit> -Correction of Type of Equipment. Battery unit→Relay unit.
2	14937749H-E-R2	April 8, 2024	4.2: Stand-alone SAR result -Deletion of (Include BT LE) for DTS.
2	14937749H-E-R2	April 8, 2024	SECTION 10: Parameter Check -Replacement of table for the target value of the simulated tissue liquid.
3	14937749H-E-R3	April 17, 2024	2.2: Product Description (General Specification) 6.1: Summary of the distance between antenna and surface of Battery unit APPENDIX 4: Photographs of test setup  -Correction of name of Body-worn accessory. Battery unit→Relay unit

**Reference: Abbreviations (Including words undescribed in this report)**

AAN	Asymmetric Artificial Network	GPS	Global Positioning System
AC	Alternating Current	Hori.	Horizontal
AM	Amplitude Modulation	ICES	Interference-Causing Equipment Standard
AMN	Artificial Mains Network	I/O	Input/Output
Amp, AMP	Amplifier	IEC	International Electrotechnical Commission
ANSI	American National Standards Institute	IEEE	Institute of Electrical and Electronics Engineers
Ant, ANT	Antenna	IF	Intermediate Frequency
AP	Access Point	ILAC	International Laboratory Accreditation Conference
ASK	Amplitude Shift Keying	ISED	Innovation, Science and Economic Development Canada
Atten., ATT	Attenuator	ISN	Impedance Stabilization Network
AV	Average	ISO	International Organization for Standardization
BPSK	Binary Phase-Shift Keying	JAB	Japan Accreditation Board
BR	Bluetooth Basic Rate	LAN	Local Area Network
BT	Bluetooth	LCL	Longitudinal Conversion Loss
BT LE	Bluetooth Low Energy	LIMS	Laboratory Information Management System
BW	BandWidth	LISN	Line Impedance Stabilization Network
C.F	Correction Factor	MRA	Mutual Recognition Arrangement
Cal Int	Calibration Interval	N/A	Not Applicable
CAV	CISPR AV	NIST	National Institute of Standards and Technology
CCK	Complementary Code Keying	NS	No signal detect.
CDN	Coupling Decoupling Network	NSA	Normalized Site Attenuation
Ch., CH	Channel	OBW	Occupied BandWidth
CISPR	Comite International Special des Perturbations Radioelectriques	OFDM	Orthogonal Frequency Division Multiplexing
Corr.	Correction	PER	Packet Error Rate
CPE	Customer premise equipment	PK	Peak
CW	Continuous Wave	P <sub>LT</sub>	long-term flicker severity
DBPSK	Differential BPSK	POHC(A)	Partial Odd Harmonic Current
DC	Direct Current	Pol., Pola.	Polarization
DET	Detector	PR-ASK	Phase Reversal ASK
D-factor	Distance factor	P <sub>ST</sub>	short-term flicker severity
Dmax	maximum absolute voltage change during an observation period	QAM	Quadrature Amplitude Modulation
DQPSK	Differential QPSK	QP	Quasi-Peak
DSSS	Direct Sequence Spread Spectrum	QPSK	Quadrature Phase Shift Keying
DUT	Device Under Test	r.m.s., RMS	Root Mean Square
EDR	Enhanced Data Rate	RBW	Resolution BandWidth
e.i.r.p., EIRP	Equivalent Isotropically Radiated Power	RE	Radio Equipment
EM clamp	Electromagnetic clamp	REV	Reverse
EMC	ElectroMagnetic Compatibility	RF	Radio Frequency
EMI	ElectroMagnetic Interference	RFID	Radio Frequency Identifier
EMS	ElectroMagnetic Susceptibility	RNSS	Radio Navigation Satellite Service
EN	European Norm	RSS	Radio Standards Specifications
e.r.p., ERP	Effective Radiated Power	Rx	Receiving
ETSI	European Telecommunications Standards Institute	SINAD	Ratio of (Signal + Noise + Distortion) to (Noise + Distortion)
EU	European Union	S/N	Signal to Noise ratio
EUT	Equipment Under Test	SA, S/A	Spectrum Analyzer
Fac.	Factor	SG	Signal Generator
FCC	Federal Communications Commission	SVSWR	Site-Voltage Standing Wave Ratio
FHSS	Frequency Hopping Spread Spectrum	THC(A)	Total Harmonic Current
FM	Frequency Modulation	THD(%)	Total Harmonic Distortion
Freq.	Frequency	TR, T/R	Test Receiver
FSK	Frequency Shift Keying	Tx	Transmitting
Fund	Fundamental	VBW	Video BandWidth
FWD	Forward	Vert.	Vertical
GFSK	Gaussian Frequency-Shift Keying	WLAN	Wireless LAN
GNSS	Global Navigation Satellite System	xDSL	Generic term for all types of DSL technology (DSL: Digital Subscriber Line)

---

<b>CONTENTS</b>	<b>PAGE</b>
<b>SECTION 1: Customer information</b> .....	<b>5</b>
<b>SECTION 2: Equipment under test (EUT)</b> .....	<b>5</b>
2.1 Identification of EUT.....	5
2.2 Product Description.....	6
<b>SECTION 3: Test standard information</b> .....	<b>7</b>
3.1 Test Specification.....	7
3.2 Procedure .....	7
3.3 Additions or deviations to standard.....	7
3.4 Exposure limit .....	8
3.5 SAR.....	8
3.6 Test Location .....	8
<b>SECTION 4: Test result</b> .....	<b>9</b>
4.1 Result.....	9
4.2 Stand-alone SAR result .....	9
4.3 Simultaneous transmission SAR result.....	9
<b>SECTION 5: Tune-up tolerance information and software information</b> .....	<b>10</b>
<b>SECTION 6: RF Exposure Conditions (Test Configurations)</b> .....	<b>12</b>
6.1 Summary of the distance between antenna and surface of Relay unit .....	12
6.2 SAR test exclusion considerations according to KDB 447498 D01 .....	12
<b>SECTION 7: Description of the Body setup</b> .....	<b>14</b>
7.1 Procedure for SAR test position determination .....	14
7.2 Test position for Body setup .....	14
<b>SECTION 8: Description of the operating mode</b> .....	<b>15</b>
8.1 Output Power and SAR test required .....	15
<b>SECTION 9: Test surrounding</b> .....	<b>17</b>
9.1 Measurement uncertainty .....	17
<b>SECTION 10: Parameter Check</b> .....	<b>19</b>
10.1 For SAR system check .....	19
10.2 For SAR measurement .....	19
<b>SECTION 11: System Check confirmation</b> .....	<b>20</b>
<b>SECTION 12: Measured and Reported (Scaled) SAR Results</b> .....	<b>21</b>
12.1 Result of Body SAR of WLAN 2.4 GHz Band.....	23
12.2 Result of Body SAR of WLAN 5.2 GHz Band.....	24
12.3 Repeated measurement .....	25
<b>SECTION 13: Test instruments</b> .....	<b>26</b>
<b>APPENDIX 1: System Check</b> .....	<b>27</b>
<b>APPENDIX 2: SAR Measurement data</b> .....	<b>31</b>
<b>APPENDIX 3: System specifications</b> .....	<b>34</b>
<b>APPENDIX 4: Photographs of test setup</b> .....	<b>87</b>

## **SECTION 1: Customer information**

Company Name	KEYENCE CORPORATION
Address	1-3-14, Higashinakajima, Higashiyodogawa-ku, Osaka-shi, Osaka, Japan
Telephone Number	+81-6-6379-1111
Contact Person	Takashi Suzuki

The information provided from the customer is as follows;

- Customer, Description of EUT, Model Number of EUT, FCC ID on the cover and other relevant pages
  - Operating/Test Mode(s) (Mode(s)) on all the relevant pages
  - SECTION 1: Customer Information
  - SECTION 2: Equipment Under Test (EUT) other than the Receipt Date and Test Date
  - SECTION 5: Tune-up tolerance information and software information
- \* The laboratory is exempted from liability of any test results affected from the above information in SECTION 2 and 5.

## **SECTION 2: Equipment under test (EUT)**

### **2.1 Identification of EUT**

Description	WLAN unit
Model Number	WM-WL
Serial Number	001
Condition	Production prototype (Not for Sale: This sample is equivalent to mass-produced items.)
Modification	No Modification by the test lab
Receipt Date	November 24, 2023
Test Date	November 27, 2023 (For Output power measurement) November 27 and 29, 2023 (For SAR measurement)

## 2.2 Product Description

### General Specification

Rating	DC 1.8 V / DC 3.3 V
Option battery	N/A
Body-worn accessory	Relay unit *1

#### \*1 <Information of the Relay unit>

Type of Equipment	Relay unit
Model No.	WM-RU
Serial No.	ES01
Rating	Battery: DC 14.4 V 2.5 Ah (M/N: NR-XB1 or NR-XB1A)
Size	114 x 165 x 56 (Width x Depth x Height (mm))

### Radio Specification

This report contains data provided by the customer which can impact the validity of results. UL Japan, Inc. is only responsible for the validity of results after the integration of the data provided by the customer. The data provided by the customer is marked "a)" in the table below.

#### WLAN (IEEE802.11b/11g/11n-20)

Equipment Type	Transceiver
Frequency of Operation	2412 MHz to 2462 MHz
Type of Modulation	DSSS, OFDM
Antenna Gain <sup>a)</sup>	0.6 dBi

#### WLAN (IEEE802.11a/11n-20/11ac-20/11n-40/11ac-40/11ac-80)

Equipment Type	Transceiver	
Frequency of Operation	20 MHz Band	5180 MHz to 5240 MHz
	40 MHz Band	5190 MHz to 5230 MHz
	80 MHz Band	5210 MHz
Type of Modulation	OFDM	
Antenna Gain <sup>a)</sup>	1.80 dBi	

### **SECTION 3: Test standard information**

#### **3.1 Test Specification**

Title : **FCC47CFR 2.1093**  
Radiofrequency radiation exposure evaluation: portable devices.

#### **Published RF exposure KDB procedures**

<input checked="" type="checkbox"/> <b>KDB 447498 D01(v06)</b>	RF Exposure Procedures and Equipment Authorization Policies for Mobile and Portable Devices
<input type="checkbox"/> <b>KDB 447498 D02(v02r01)</b>	SAR Measurement Procedures for USB Dongle Transmitters
<input type="checkbox"/> <b>KDB 648474 D04(v01r03)</b>	SAR Evaluation Considerations for Wireless Handsets
<input type="checkbox"/> <b>KDB 941225 D01(v03r01)</b>	3G SAR Measurement Procedures
<input type="checkbox"/> <b>KDB 941225 D05(v02r05)</b>	SAR Evaluation Considerations for LTE Devices
<input type="checkbox"/> <b>KDB 941225 D06(v02r01)</b>	SAR Evaluation Procedures for Portable Devices with Wireless Router Capabilities (Hot Spot SAR)
<input type="checkbox"/> <b>KDB 941225 D07(v01r02)</b>	SAR Evaluation Procedures for UMPC Mini-Tablet Devices
<input type="checkbox"/> <b>KDB 616217 D04(v01r02)</b>	SAR Evaluation Considerations for Laptop, Notebook, Netbook and Tablet Computers
<input checked="" type="checkbox"/> <b>KDB 865664 D01(v01r04)</b>	SAR Measurement Requirements for 100 MHz to 6 GHz
<input checked="" type="checkbox"/> <b>KDB 248227 D01(v02r02)</b>	SAR Guidance for 802.11(Wi-Fi) Transmitters

#### **Reference**

- [1] Schmid & Partner Engineering AG, DASY Manual, September 2019  
[2] IEEE Std 1528-2013

#### **3.2 Procedure**

<b>Transmitter</b>	<b>WLAN</b>
<b>Test Procedure</b>	Published RF exposure KDB procedures
<b>Category</b>	SAR
Note: UL Japan, Inc.'s SAR Work Procedures: Work Instructions-ULID-003598 and Work Instructions-ULID-003599	

#### **3.3 Additions or deviations to standard**

Other than above, no addition, exclusion nor deviation has been made from the standard.

### 3.4 Exposure limit

(A) Limits for Occupational/Controlled Exposure (W/kg)

Spatial Average (averaged over the whole body)	Spatial Peak (averaged over any 1 g of tissue)	Spatial Peak (hands/wrists/feet/ankles averaged over 10 g)
0.4	8.0	20.0

(B) Limits for General population/Uncontrolled Exposure (W/kg)

Spatial Average (averaged over the whole body)	Spatial Peak (averaged over any 1 g of tissue)	Spatial Peak (hands/wrists/feet/ankles averaged over 10 g)
0.08	1.6	4.0

**Occupational/Controlled Environments:** are defined as locations where there is exposure that may be incurred by people who are aware of the potential for exposure, (i.e. as a result of employment or occupation).

**General Population/Uncontrolled Environments:** are defined as locations where there is the exposure of individuals who have no knowledge or control of their exposure.

**NOTE:GENERAL POPULATION/UNCONTROLLED EXPOSURE  
SPATIAL PEAK(averaged over any 1 g of tissue) LIMIT  
1.6 W/kg**

### 3.5 SAR

Specific Absorption Rate (SAR): The time derivative (rate) of the incremental energy (dW) absorbed by (dissipated in) an incremental mass (dm) contained in a volume element (dV) of a given density ( $\rho$ ), as shown in the following equation:

$$SAR = \frac{d}{dt} \left( \frac{dW}{dm} \right) = \frac{d}{dt} \left( \frac{dW}{\rho dV} \right)$$

SAR is expressed in units of watts per kilogram (W/kg) or equivalently milliwatts per gram (mW/g).

SAR is related to the E-field at a point by the following equation:

$$SAR = \frac{\sigma |E|^2}{\rho}$$

where

$\sigma$  = conductivity of the tissue (S/m)

$\rho$  = mass density of the tissue (kg/m<sup>3</sup>)

E = rms E-field strength (V/m)

### 3.6 Test Location

UL Japan, Inc. Ise EMC Lab.

Shielded room for SAR testing

\*A2LA Certificate Number: 5107.02 / FCC Test Firm Registration Number: 884919

ISED Lab Company Number: 2973C / CAB identifier: JP0002

4383-326 Asama-cho, Ise-shi, Mie-ken 516-0021 JAPAN

Telephone : +81-596-24-8999



---

## **SECTION 4: Test result**

### **4.1 Result**

Complied  
Highest values at each band are listed next section.

### **4.2 Stand-alone SAR result**

RF Exposure Conditions		Equipment Class - Highest Reported SAR (W/kg)	
		DTS	NII
Standalone Tx (1-g SAR)	Body-worn	0.676	0.593

\*Details are shown at section 12.

### **4.3 Simultaneous transmission SAR result**

EUT does not have simultaneous transmission functionality.

## SECTION 5: Tune-up tolerance information and software information

### Maximum tune-up tolerance limit

Mode	Band	Frequency [MHz]	Maximum tune-up tolerance limit (Burst Average) [dBm]	Maximum tune-up tolerance limit (Burst Average) [mW]
WLAN 11b	2.4 GHz	2412 to 2462	16.50	44.67
WLAN 11g	2.4 GHz	2422 to 2452	15.50	35.48
		2412, 2417, 2457, 2462	12.50	17.78
WLAN 11n	2.4 GHz	2422 to 2452	15.50	35.48
		2412, 2417, 2457, 2462	12.50	17.78
WLAN 11a	5.2 GHz	5220, 5240	13.00	19.95
		5180, 5200	12.00	15.85
WLAN 11n-20	5.2 GHz	5220, 5240	13.00	19.95
		5180, 5200	12.00	15.85
WLAN 11n-40	5.2 GHz	5230	13.00	19.95
		5190	12.00	15.85
WLAN 11ac-20	5.2 GHz	5220, 5240	13.00	19.95
		5180, 5200	12.00	15.85
WLAN 11ac-40	5.2 GHz	5230	13.00	19.95
		5190	12.00	15.85
WLAN 11ac-80	5.2 GHz	5210	12.00	15.85

### Software setting

\*The power value of the EUT was set for testing as follows (setting value might be different from product specification value);

Power settings: WLAN: Refer to the following Power Setting table.

Software: Name: cypress-fmac

Version: v5.10.9

\*This setting of software is the worst case.

The test was performed with condition that obtained the maximum average power (Burst) in pre-check.

Any conditions under the normal use do not exceed the condition of setting.

In addition, end users cannot change the settings of the output power of the product.

### [Power Setting]

Mode	Frequency	Power Setting [dBm]
11b	2412 MHz to 2462 MHz	16
11n-40	5190 MHz	10
	5230 MHz	11

Duty conformation

11b 1 Mbps

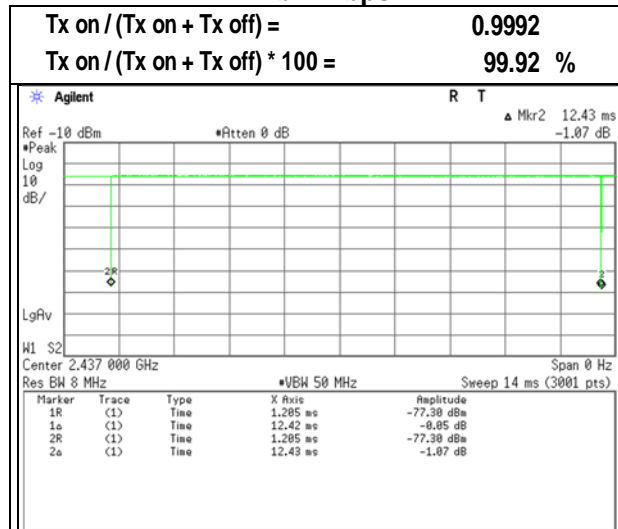

11n-40 (5 GHz) MCS0

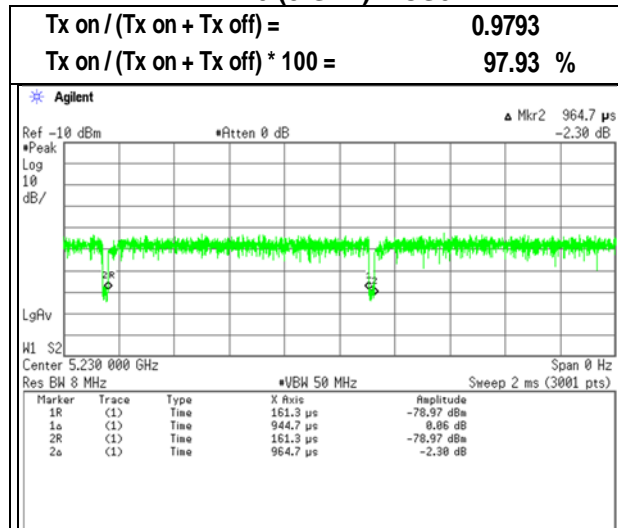

**SECTION 6: RF Exposure Conditions (Test Configurations)**

**6.1 Summary of the distance between antenna and surface of Relay unit**

Test position	Distance
Front	12.325 mm
Rear	42.875 mm
Left	88.9 mm
Right	23.5 mm
Top	136.2 mm
Bottom	28.4 mm
Bottom tilt	14.915 mm

\*Details are shown in Appendix 4

**6.2 SAR test exclusion considerations according to KDB 447498 D01**

The following is based on KDB 447498 D01.

1) The 1-g and 10-g SAR test exclusion thresholds for 100 MHz to 6 GHz at test separation distances ≤ 50 mm are determined by:

$$[(\text{max. power of channel, including tune-up tolerance, mW}) / (\text{min. test separation distance, mm})] \cdot [\sqrt{f(\text{GHz})}] \leq 3.0 \text{ for 1-g SAR and } \leq 7.5 \text{ for 10-g extremity SAR}$$

1. The upper frequency of the frequency band was used in order to calculate standalone SAR test exclusion considerations.
2. Power and distance are rounded to the nearest mW and mm before calculation.
3. The result is rounded to one decimal place for comparison.
4. The test exclusions are applicable only when the minimum test separation distance is ≤ 50 mm and for transmission frequencies between 100 MHz and 6 GHz. When the minimum test separation distance is < 5 mm, a distance of 5 mm is applied to determine SAR test exclusion.
5. "N/A" displayed on below exclusion calculation means not applicable this formula since distance between antenna and surface is > 50 mm.

When the calculated threshold value by a numerical formula above-mentioned in the following table is 3.0 or less, SAR test is excluded.

The following table lists only the highest tune up limit in each frequency band.

The following table lists only the highest channel in each frequency band.

**SAR exclusion calculations for antenna <50mm from the user**

Antenna	Tx Interface	Frequency (MHz)	Output Power		Calculated Threshold Value						
			dBm	mW	Front	Rear	Left	Right	Top	Bottom	Bottom tilt
Main	WLAN 2.4 GHz	2462	16.50	45	5.8 -MEASURE-	1.6 -EXEMPT-	N/A	2.9 -EXEMPT-	N/A	2.5 -EXEMPT-	4.7 -MEASURE-
Main	WLAN 5.2 GHz	5240	13.00	20	3.8 -MEASURE-	1.1 -EXEMPT-	N/A	1.9 -EXEMPT-	N/A	1.6 -EXEMPT-	3 -MEASURE-

\* Conservatively, Right is to be measured.

2) At 100 MHz to 6 GHz and for test separation distances > 50 mm, the SAR test exclusion threshold is determined according to the following.

- a)  $[(3 \cdot 50) / (\sqrt{f(\text{GHz})})] + (\text{test separation distance} - 50 \text{ mm}) \cdot (f(\text{MHz}) / 150) \text{ mW}$  at > 100 MHz and ≤ 1500 MHz  
 b)  $[(3 \cdot 50) / (\sqrt{f(\text{GHz})})] + (\text{test separation distance} - 50 \text{ mm}) \cdot 10 \text{ mW}$  at > 1500 MHz and ≤ 6 GHz

1. The upper frequency of the frequency band was used in order to calculate standalone SAR test exclusion considerations.
2. Power and distance are rounded to the nearest mW and mm before calculation
3. "N/A" displayed on below exclusion calculation means not applicable this formula since distance between antenna and surface is < 50 mm.

When output power is less than the calculated threshold value by a numerical formula above-mentioned in the following table, SAR test is excluded.

The following table lists only the highest tune up limit in each frequency band.

The following table lists only the highest channel in each frequency band.

SAR exclusion calculations for antenna >50mm from the user

Antenna	Tx Interface	Frequency (MHz)	Output Power		Calculated Threshold Value						
			dBm	mW	Front	Rear	Left	Right	Top	Bottom	Bottom tilt
Main	WLAN 2.4 GHz	2462	16.50	45	N/A	N/A	484.6 mW -EXEMPT-	N/A	957.6 mW -EXEMPT-	N/A	N/A
Main	WLAN 5.2 GHz	5240	13.00	20	N/A	N/A	454.5 mW -EXEMPT-	N/A	927.5 mW -EXEMPT-	N/A	N/A

---

## **SECTION 7: Description of the Body setup**

### **7.1 Procedure for SAR test position determination**

The tested procedure was performed according to the KDB 447498 D01 (Mobile and Portable Device RF Exposure Procedures and Equipment Authorization Policies).

### **7.2 Test position for Body setup**

No.	Position	Test distance	WLAN
			Tested
1	Front	0 mm	<input checked="" type="checkbox"/>
2	Rear	0 mm	<input type="checkbox"/>
3	Left	0 mm	<input type="checkbox"/>
4	Right	0 mm	<input checked="" type="checkbox"/>
5	Top	0 mm	<input type="checkbox"/>
6	Bottom	0 mm	<input type="checkbox"/>
7	Bottom tilt	0 mm	<input checked="" type="checkbox"/>

## SECTION 8: Description of the operating mode

### 8.1 Output Power and SAR test required

Date of Output power measurement      November 27, 2023  
Temperature / Humidity                      24 deg. C / 40 % RH

According to KDB 248227 D01, The initial test configuration for 2.4 GHz and 5 GHz OFDM transmission modes is determined by the 802.11 configuration with the highest maximum output power specified for production units, including tune-up tolerance, in each standalone and aggregated frequency band. SAR for the initial test configuration is measured using the highest maximum output power channel determined by the default power measurement procedures. When multiple configurations in a frequency band have the same specified maximum output power, the initial test configuration is determined according to the following steps applied sequentially.

1. The largest channel bandwidth configuration is selected among the multiple configurations with the same specified maximum output power.
2. If multiple configurations have the same specified maximum output power and largest channel bandwidth, the lowest order modulation among the largest channel bandwidth configurations is selected.
3. If multiple configurations have the same specified maximum output power, largest channel bandwidth and lowest order modulation, the lowest data rate configuration among these configurations is selected.
4. When multiple transmission modes (802.11a/g/n/ac) have the same specified maximum output power, largest channel bandwidth, lowest order modulation and lowest data rate, the lowest order 802.11 mode is selected; i.e., 802.11a is chosen over 802.11n then 802.11ac or 802.11g is chosen over 802.11n.

### WLAN 2.4 GHz (DTS Band)

#### SISO

Band	Mode	Data Rate	Ch #	Freq. (MHz)	Tune-up upper Power (dBm) (Burst)	Measured average Power (dBm) (Burst)	Initial test configuration	Note(s)
DTS	11b	1 Mbps	1	2412	16.50	15.94		1
			6	2437	16.50	15.99	Yes	
			11	2462	16.50	15.98		
	11g	6 Mbps	1	2412	12.50	-		
			3	2422	15.50	-		
			6	2437	15.50	-		
			9	2452	15.50	-		
			11	2462	12.50	-		
	11n-20	MCS0	1	2412	12.50	-		
			3	2422	15.50	-		
			6	2437	15.50	-		
			9	2452	15.50	-		
			11	2462	12.50	-		

#### Note(s):

1. According to KDB 248227 D01, SAR is not required for 802.11g/n OFDM channels when the highest reported SAR for DSSS is adjusted by the ratio of OFDM to DSSS specified maximum output power and the adjusted SAR is  $\leq 1.2$  W/kg.
2. SAR test channel was chosen. (shaded blue frame)

**WLAN 5 GHz (U-NII-1 Bands)**

**SISO**

Band	Mode	Data Rate	Ch #	Freq. (MHz)	Tune-up upper Power (dBm) (Burst)	Measured average Power (dBm) (Burst)	Initial test configuration	Note(s)
U-NII-1	11a	6 Mbps	36	5180	12.00	-		1
			44	5220	13.00	-		
			48	5240	13.00	-		
U-NII-1	11n-20	MCS0	36	5180	12.00	-		1
			44	5220	13.00	-		
			48	5240	13.00	-		
U-NII-1	11ac-20	MCS0	36	5180	12.00	-		1
			44	5220	13.00	-		
			48	5240	13.00	-		
U-NII-1	11n-40	MCS0	38	5190	12.00	11.29		
			46	5230	13.00	12.14	Yes	
U-NII-1	11ac-40	MCS0	38	5190	12.00	-		1
			46	5230	13.00	-		
U-NII-1	11ac-80	MCS0	42	5210	12.00	-		1

**Note(s):**

- Excerpt from KDB 248227 D01 clause 5.3.4 b), when the highest reported SAR for the initial test configuration (when applicable, include subsequent highest output channels), according to the initial test position or fixed exposure position requirements, is adjusted by the ratio of the subsequent test configuration to initial test configuration specified maximum output power and the adjusted SAR is  $\leq 1.2$  W/kg, SAR is not required for that subsequent test configuration.
- SAR test channel was chosen. (shaded blue frame)



**SECTION 9: Test surrounding**

**9.1 Measurement uncertainty**

This measurement uncertainty budget is suggested by IEEE Std 1528(2013) and determined by Schmid & Partner Engineering AG (DASY5/6 Uncertainty Budget). Per KDB 865664 D01 SAR Measurement 100 MHz to 6 GHz Section 2.8.1., when the highest measured SAR(1 g) within a frequency band is < 1.5 W/kg, the extensive SAR measurement uncertainty analysis described in IEEE Std.1528 (2013) is not required in SAR reports submitted for equipment approval.

300 MHz to 3 GHz

Error Description	Uncert. value	Prob. Dist.	Div.	(ci) 1g	(ci) 10g	Std. Unc. (1g)	Std.Unc. (10g)
<b>Measurement System</b>							
Probe Calibration	± 6.0 %	N	1	1	1	±6.00%	±6.00%
Axial Isotropy	± 4.7 %	R	√3	0.7	0.7	±1.9%	±1.9%
Hemispherical Isotropy	± 9.6 %	R	√3	0.7	0.7	±3.9%	±3.9%
Boundary Effects	± 1.0 %	R	√3	1	1	±0.6%	±0.6%
Linearity	± 4.7 %	R	√3	1	1	±2.7%	±2.7%
System Detection Limits	± 1.0 %	R	√3	1	1	±0.6%	±0.6%
Modulation Response	± 2.4 %	R	√3	1	1	±1.4%	±1.4%
Readout Electronics	± 0.3 %	N	1	1	1	±0.3%	±0.3%
Response Time	± 0.8 %	R	√3	1	1	±0.5%	±0.5%
Integration Time	± 2.6 %	R	√3	1	1	±1.5%	±1.5%
RF Ambient Noise	± 3.0 %	R	√3	1	1	±1.7%	±1.7%
RF Ambient Reflections	± 3.0 %	R	√3	1	1	±1.7%	±1.7%
Probe Positioner	± 0.02 %	R	√3	1	1	±0.0%	±0.0%
Probe Positioning	± 0.4 %	R	√3	1	1	±0.2%	±0.2%
Max. SAR Eval.	± 2.0 %	R	√3	1	1	±1.2%	±1.2%
<b>Test Sample Related</b>							
Device Positioning	± 2.9 %	N	1	1	1	±2.9%	±2.9%
Device Holder	± 3.6 %	N	1	1	1	±3.6%	±3.6%
Power Scaling	± 0.0 %	R	√3	1	1	±0.0%	±0.0%
Power Drift	± 5.0 %	R	√3	1	1	±2.9%	±2.9%
<b>Phantom and Setup</b>							
Phantom Uncertainty	± 6.1 %	R	√3	1	1	±3.5%	±3.5%
SAR correction	± 1.9 %	N	1	1	0.84	±1.9%	±1.6%
Liquid Conductivity (mea.)	± 5.0 %	N	1	0.78	0.71	±3.9%	±3.6%
Liquid Permittivity (mea.)	± 5.0 %	N	1	0.23	0.26	±1.2%	±1.3%
Temp. unc. - Conductivity	± 3.4 %	R	√3	0.78	0.71	±1.5%	±1.4%
Temp. unc. - Permittivity	± 0.4 %	R	√3	0.23	0.26	±0.1%	±0.1%
Combined Std. Uncertainty						±11.8%	±11.7%
<b>Expanded STD Uncertainty (κ=2)</b>						<b>±23.6%</b>	<b>±23.3%</b>

Note: This uncertainty budget for validation is worst-case. Table of uncertainties are listed for ISO/IEC 17025.

3 GHz to 6 GHz

Error Description	Uncert. value	Prob. Dist.	Div.	(ci) 1g	(ci) 10g	Std. Unc. (1g)	Std.Unc. (10g)
<b>Measurement System</b>							
Probe Calibration	± 6.55 %	N	1	1	1	±6.55%	±6.55%
Axial Isotropy	± 4.7 %	R	√3	0.7	0.7	±1.9%	±1.9%
Hemispherical Isotropy	± 9.6 %	R	√3	0.7	0.7	±3.9%	±3.9%
Boundary Effects	± 2.0 %	R	√3	1	1	±1.2%	±1.2%
Linearity	± 4.7 %	R	√3	1	1	±2.7%	±2.7%
System Detection Limits	± 1.0 %	R	√3	1	1	±0.6%	±0.6%
Modulation Response	± 2.4 %	R	√3	1	1	±1.4%	±1.4%
Readout Electronics	± 0.3 %	N	1	1	1	±0.3%	±0.3%
Response Time	± 0.8 %	R	√3	1	1	±0.5%	±0.5%
Integration Time	± 2.6 %	R	√3	1	1	±1.5%	±1.5%
RF Ambient Noise	± 3.0 %	R	√3	1	1	±1.7%	±1.7%
RF Ambient Reflections	± 3.0 %	R	√3	1	1	±1.7%	±1.7%
Probe Positioner	± 0.04 %	R	√3	1	1	±0.0%	±0.0%
Probe Positioning	± 0.8 %	R	√3	1	1	±0.5%	±0.5%
Max. SAR Eval.	± 4.0 %	R	√3	1	1	±2.3%	±2.3%
<b>Test Sample Related</b>							
Device Positioning	± 2.9 %	N	1	1	1	±2.9%	±2.9%
Device Holder	± 3.6 %	N	1	1	1	±3.6%	±3.6%
Power Scaling	± 0.0 %	R	√3	1	1	±0.0%	±0.0%
Power Drift	± 5.0 %	R	√3	1	1	±2.9%	±2.9%
<b>Phantom and Setup</b>							
Phantom Uncertainty	± 6.6 %	R	√3	1	1	±3.8%	±3.8%
SAR correction	± 1.9 %	N	1	1	0.84	±1.9%	±1.6%
Liquid Conductivity (mea.)	± 5.0 %	N	1	0.78	0.71	±3.9%	±3.6%
Liquid Permittivity (mea.)	± 5.0 %	N	1	0.23	0.26	±1.2%	±1.3%
Temp. unc. - Conductivity	± 3.4 %	R	√3	0.78	0.71	±1.5%	±1.4%
Temp. unc. - Permittivity	± 0.4 %	R	√3	0.23	0.26	±0.1%	±0.1%
Combined Std. Uncertainty						±12.4%	±12.3%
<b>Expanded STD Uncertainty (κ=2)</b>						<b>±24.8%</b>	<b>±24.5%</b>

Note: This uncertainty budget for validation is worst-case.  
Table of uncertainties are listed for ISO/IEC 17025.

## SECTION 10: Parameter Check

The dielectric parameters were checked prior to assessment using the DAK dielectric probe kit. The dielectric parameters measurement is reported in each correspondent section.

According to KDB 865664 D01, +/- 5 % tolerances are required for  $\epsilon_r$  and  $\sigma$  and then below table which is the target value of the simulated tissue liquid is quoted from KDB 865664 D01.

Target Frequency (MHz)	Head		Body	
	$\epsilon_r$	$\sigma$ (S/m)	$\epsilon_r$	$\sigma$ (S/m)
150	52.3	0.76	61.9	0.80
300	45.3	0.87	58.2	0.92
450	43.5	0.87	56.7	0.94
835	41.5	0.90	55.2	0.97
900	41.5	0.97	55.0	1.05
915	41.5	0.98	55.0	1.06
1450	40.5	1.20	54.0	1.30
1610	40.3	1.29	53.8	1.40
1800 – 2000	40.0	1.40	53.3	1.52
2450	39.2	1.80	52.7	1.95
3000	38.5	2.40	52.0	2.73
5800	35.3	5.27	48.2	6.00

( $\epsilon_r$  = relative permittivity,  $\sigma$  = conductivity and  $\rho = 1000 \text{ kg/m}^3$ )

The dielectric parameters are linearly interpolated between the closest pair of target frequencies to determine the applicable dielectric parameters corresponding to the device test frequency.

### 10.1 For SAR system check

DIELECTRIC PARAMETERS MEASUREMENT RESULTS													
Date	Ambient Temp. [deg.c]	Relative Humidity [%]	Liquid type	Liquid Temp. [deg.c]	Measured Frequency [MHz]	Target $\sigma$	Target $\epsilon_r$	Measure $\sigma$	Measure $\epsilon_r$	Deviation $\sigma$ [%]	Deviation $\epsilon_r$ [%]	Limit [%]	Remark
2023/11/27	23.0	35	HBBL600-10000	22.5	2450.0	1.80	39.2	1.74	38.4	-3.6	-2.1	+/- 5	
2023/11/29	20.0	35	HBBL600-10000	20.0	5250.0	4.71	35.9	4.72	35.3	0.3	-1.7	+/- 5	

### 10.2 For SAR measurement

DIELECTRIC PARAMETERS MEASUREMENT RESULTS													
Date	Ambient Temp. [deg.c]	Relative Humidity [%]	Liquid type	Liquid Temp. [deg.c]	Measured Frequency [MHz]	Target $\sigma$	Target $\epsilon_r$	Measure $\sigma$	Measure $\epsilon_r$	Deviation $\sigma$ [%]	Deviation $\epsilon_r$ [%]	Limit [%]	Remark
2023/11/27	23.0	35	HBBL600-10000	22.5	2412.0	1.77	39.3	1.71	38.4	-3.2	-2.2	+/- 5	
2023/11/27	23.0	35	HBBL600-10000	22.5	2437.0	1.79	39.2	1.73	38.4	-3.4	-2.2	+/- 5	
2023/11/27	23.0	35	HBBL600-10000	22.5	2462.0	1.81	39.2	1.74	38.4	-3.8	-2.1	+/- 5	
2023/11/29	20.0	35	HBBL600-10000	20.0	5190.0	4.65	36.0	4.48	35.5	-3.6	-1.4	+/- 5	
2023/11/29	20.0	35	HBBL600-10000	20.0	5230.0	4.69	36.0	4.63	35.4	-1.2	-1.6	+/- 5	

**SECTION 11: System Check confirmation**

The measurements were performed in the flat section of the TWIN SAM or ELI phantom, shell thickness: 2.0 ±0.2 mm (bottom plate) filled with Body or Head simulating liquid of the following parameters.

The depth of tissue-equivalent liquid in a phantom must be ≥ 15.0 cm ± 0.5 cm for SAR measurements ≤ 3 GHz and ≥ 10.0 cm ± 0.5 cm for measurements > 3 GHz.

The DASY system with an E-Field Probe was used for the measurements.

The dipole was mounted on the small tripod so that the dipole feed point was positioned below the center marking of the flat phantom section and the dipole was oriented parallel to the body axis (the long side of the phantom).

The standard measuring distance was 10 mm (above 1 GHz to 6 GHz) and 15 mm (below 1 GHz) from dipole center to the simulating liquid surface.

The coarse grid with a grid spacing of 15 mm (below 2 GHz), 12 mm (2 GHz to 4 GHz) and 10 mm (4 GHz to 6 GHz) was aligned with the dipole.

Around this point found in the coarse grid, a volume of 30 mm x 30 mm x 30 mm or more was assessed by measuring 7 x 7 x 7 points at least for below 3 GHz, a volume of 28 mm x 28 mm x 34 mm or more was assessed by measuring 8 x 8 x 8 (ratio step method) points at least for 3 GHz to 5 GHz and a volume of 28 mm x 28 mm x 24 mm or more was assessed by measuring 8 x 8 x 8 (ratio step method) points at least for 5 GHz to 6 GHz.

Distance between probe sensors and phantom surface was set to 1.4 mm.

The dipole input power (forward power) was 100 mW or 250 mW.

The results are normalized to 1 W input power.

All SAR measurement is performed within 24 hours after the system check are measured.

**Target Value**

Freq [MHz]	Model,S/N		Head	
			(SPEAG) 1 g [W/kg]	(SPEAG) 10 g [W/kg]
2450	D2450V2,713	2450D2450V2,713	53.20	24.76
5250	D5GHV2,1020	5250D5GHV2,1020	80.20	23.00

The target(reference) SAR values can be obtained from the calibration certificate of system validation dipoles(Refer to Appendix 3). The target SAR values are SAR measured value in the calibration certificate scaled to 1 W.

Date Tested	Test Freq	Model,S/N	T.S. Liquid	Measured Results		Target (Ref. Value)	Delta ± 10 %	
				Zoom Scan	Normalize to 1 W			
2023/11/27	2450	D2450V2,713	Head	1 g	13.40	53.60	53.20	0.8
				10 g	6.25	25.00	24.76	1.0
2023/11/29	5250	D5GHV2,1020	Head	1 g	7.79	77.90	80.20	-2.9
				10 g	2.26	22.60	23.00	-1.7

---

## **SECTION 12: Measured and Reported (Scaled) SAR Results**

WLAN SAR Test Reduction criteria are as follows

- **KDB 248227 D01 (SAR Guidance for 802.11(Wi-Fi) Transmitters):**

SAR test reduction for 802.11 WLAN transmission mode configurations are considered separately for DSSS and OFDM. An initial test position is determined to reduce the number of tests required for certain exposure configurations with multiple test positions. An initial test configuration is determined for each frequency band and aggregated band according to maximum output power, channel bandwidth, wireless mode configurations and other operating parameters to streamline the measurement requirements. For 2.4 GHz DSSS, either the initial test position or DSSS procedure is applied to reduce the number of SAR tests; these are mutually exclusive. For OFDM, an initial test position is only applicable to next to the ear, UMPC mini-tablet and hotspot mode configurations, which is tested using the initial test configuration to facilitate test reduction. For other exposure conditions with a fixed test position, SAR test reduction is determined using only the initial test configuration.

The multiple test positions require SAR measurements in head, hotspot mode or UMPC mini-tablet configurations may be reduced according to the highest reported SAR determined using the initial test position(s) by applying the DSSS or OFDM SAR measurement procedures in the required wireless mode test configuration(s). The initial test position(s) is measured using the highest measured maximum output power channel in the required wireless mode test configuration(s). When the reported SAR for the initial test position is:

- ◇  $\leq 0.4$  W/kg, further SAR measurement is not required for the other test positions in that exposure configuration and wireless mode combination within the frequency band or aggregated band. DSSS and OFDM configurations are considered separately according to the required SAR procedures.
- ◇  $> 0.4$  W/kg, SAR is repeated using the same wireless mode test configuration tested in the initial test position to measure the subsequent next closest/smallest test separation distance and maximum coupling test position, on the highest maximum output power channel, until the reported SAR is  $\leq 0.8$  W/kg or all required test positions are tested.
  - For subsequent test positions with equivalent test separation distance or when exposure is dominated by coupling conditions, the position for maximum coupling condition should be tested.
  - When it is unclear, all equivalent conditions must be tested.
- ◇ For all positions/configurations tested using the initial test position and subsequent test positions, when the reported SAR is  $> 0.8$  W/kg, measure the SAR for these positions/configurations on the subsequent next highest measured output power channel(s) until the reported SAR is  $\leq 1.2$  W/kg or all required test channels are considered.
  - The additional power measurements required for this step should be limited to those necessary for identifying subsequent highest output power channels to apply the test reduction.
- ◇ When the specified maximum output power is the same for both UNII 1 and UNII 2A, begin SAR measurements in UNII 2A with the channel with the highest measured output power. If the reported SAR for UNII 2A is  $\leq 1.2$  W/kg, SAR is not required for UNII 1; otherwise treat the remaining bands separately and test them independently for SAR.
- ◇ When the specified maximum output power is different between UNII 1 and UNII 2A, begin SAR with the band that has the higher specified maximum output. If the highest reported SAR for the band with the highest specified power is  $\leq 1.2$  W/kg, testing for the band with the lower specified output power is not required; otherwise test the remaining bands independently for SAR.

To determine the initial test position, Area Scans were performed to determine the position with the *Maximum Value of SAR (measured)*. The position that produced the highest *Maximum Value of SAR* is considered the worst case position; thus used as the initial test position.

- When reported SAR value is exceed 1.2 W/kg(if any), device holder perturbation verification is required; however, since distance between device holder and antenna of EUT is enough, it was not conducted.
- Reported SAR= Measured SAR [W/kg] \* Power Scaled factor \* Duty Scaled factor  
Maximum tune-up tolerance limit is by the specification from a customer.  
\* Power Scaled factor = Maximum tune-up tolerance limit [mW] / Measured power [mW]  
\* Duty Scaled factor = 1 / Duty (%) / 100
- Maximum tune-up tolerance limit is by the specification from a customer.

Note: Measured value is rounded round off to three decimal places

### 12.1 Result of Body SAR of WLAN 2.4 GHz Band

Test Position	Dist. (mm)	Mode	Freq. (MHz)	Power (dBm)		Power Scaled factor	Duty (%)	Duty Scaled factor	1-g SAR (W/kg)		Plot No.
				Tune-up upper Power	Measured average Power				Meas.	Reported	
Front	0	11b	2412	16.50	15.94	1.14	99.92	1.00	0.386	0.439	1
			2437	16.50	15.99	1.12	99.92	1.00	0.601	0.676	
			2462	16.50	15.98	1.13	99.92	1.00	0.568	0.641	
Right	0	11b	2412	16.50	15.94	1.14	99.92	1.00			
			2437	16.50	15.99	1.12	99.92	1.00	0.049	0.055	
			2462	16.50	15.98	1.13	99.92	1.00			
Bottom tilt	0	11b	2412	16.50	15.94	1.14	99.92	1.00			
			2437	16.50	15.99	1.12	99.92	1.00	0.182	0.205	
			2462	16.50	15.98	1.13	99.92	1.00			

**OFDM was excluded from the following table according to KDB 248227 D01.**

SAR is not required for the following 2.4 GHz OFDM conditions according to KDB 248227 D01.

- 1) When KDB 447498 D01 SAR test exclusion applies to the OFDM configuration.
- 2) When the highest reported SAR for DSSS is adjusted by the ratio of OFDM to DSSS specified maximum output power and the adjusted SAR is  $\leq 1.2$  W/kg.

Maximum tune-up tolerance limit		Maximum tune-up tolerance limit		OFDM scaled factor	Position	DSSS Reported SAR value [W/kg]	OFDM Estimated SAR value [W/kg]	Exclusion limit [W/kg]	Standalone SAR request
DSSS		OFDM							
[dBm]	[mW]	[dBm]	[mW]						
16.50	44.67	15.50	35.48	0.794	Front	0.676	0.537	< 1.2	No

**Note(s):**

1. OFDM scaled factor = Maximum tune-up tolerance limit of OFDM [mW] / Maximum tune-up tolerance limit of DSSS [mW]
2. Estimated SAR of OFDM = Reported SAR of DSSS[W/kg] · OFDM scaled factor



## 12.2 Result of Body SAR of WLAN 5.2 GHz Band

Test Position	Dist. (mm)	Mode	Freq. (MHz)	Power (dBm)		Power Scaled factor	Duty (%)	Duty Scaled factor	1-g SAR (W/kg)		Plot No.
				Tune-up upper Power	Measured average Power				Meas.	Reported	
Front	0	11n40	5190	12.00	11.29	1.18	97.93	1.02			
			5230	13.00	12.14	1.22	97.93	1.02	0.236	0.294	
Right	0	11n40	5190	12.00	11.29	1.18	97.93	1.02	0.340	0.409	
			5230	13.00	12.14	1.22	97.93	1.02	0.476	0.593	2
Bottom tilt	0	11n40	5190	12.00	11.29	1.18	97.93	1.02			
			5230	13.00	12.14	1.22	97.93	1.02	0.179	0.223	

Subsequent test configuration was excluded from the following table according to KDB 248227 D01.

SAR is not required for the following exclusion conditions according to KDB 248227 D01.

When the highest reported SAR for initial test configuration is adjusted by the ratio of Subsequent test configuration to initial test configuration specified maximum output power and the adjusted SAR is  $\leq 1.2$  W/kg.

Maximum tune-up tolerance limit		Maximum tune-up tolerance limit		Scaled factor	Position	11n40	11a	Exclusion limit [W/kg]	Standalone SAR request
11n40		11a				Reported SAR value [W/kg]	Estimated SAR value [W/kg]		
[dBm]	[mW]	[dBm]	[mW]						
13.00	19.95	13.00	19.95	1.000	Right	0.593	0.593	< 1.2	No
Maximum tune-up tolerance limit		Maximum tune-up tolerance limit		Scaled factor	Position	11n40	11n20	Exclusion limit [W/kg]	Standalone SAR request
11n40		11n20				Reported SAR value [W/kg]	Estimated SAR value [W/kg]		
[dBm]	[mW]	[dBm]	[mW]						
13.00	19.95	13.00	19.95	1.000	Right	0.593	0.593	< 1.2	No
Maximum tune-up tolerance limit		Maximum tune-up tolerance limit		Scaled factor	Position	11n40	11ac20	Exclusion limit [W/kg]	Standalone SAR request
11n40		11ac20				Reported SAR value [W/kg]	Estimated SAR value [W/kg]		
[dBm]	[mW]	[dBm]	[mW]						
13.00	19.95	13.00	19.95	1.000	Right	0.593	0.593	< 1.2	No
Maximum tune-up tolerance limit		Maximum tune-up tolerance limit		Scaled factor	Position	11n40	11ac40	Exclusion limit [W/kg]	Standalone SAR request
11n40		11ac40				Reported SAR value [W/kg]	Estimated SAR value [W/kg]		
[dBm]	[mW]	[dBm]	[mW]						
13.00	19.95	13.00	19.95	1.000	Right	0.593	0.593	< 1.2	No
Maximum tune-up tolerance limit		Maximum tune-up tolerance limit		Scaled factor	Position	11n40	11ac80	Exclusion limit [W/kg]	Standalone SAR request
11n40		11ac80				Reported SAR value [W/kg]	Estimated SAR value [W/kg]		
[dBm]	[mW]	[dBm]	[mW]						
13.00	19.95	12.00	15.85	0.794	Right	0.593	0.471	< 1.2	No

### Notes:

- Scaled factor = Maximum tune-up tolerance limit of subsequent test configuration [mW] / Maximum tune-up tolerance limit of initial test configuration [mW]
- Estimated SAR of subsequent test configuration = Reported SAR of initial test configuration [W/kg] · scaled factor.



### 12.3 Repeated measurement

According to KDB 865664 D1.

- 1) Repeated measurement is not required when the original highest measured SAR is  $< 0.80$  W/kg; steps 2) through 4) do not apply.
- 2) When the original highest measured SAR is  $\geq 0.80$  W/kg, repeat that measurement once.
- 3) Perform a second repeated measurement only if the ratio of largest to smallest SAR for the original and first repeated measurements is  $> 1.20$  or when the original or repeated measurement is  $\geq 1.45$  W/kg ( $\sim 10\%$  from the 1-g SAR limit).
- 4) Perform a third repeated measurement only if the original, first or second repeated measurement is  $\geq 1.5$  W/kg and the ratio of largest to smallest SAR for the original, first and second repeated measurements is  $> 1.20$ .

Wireless Technologies	Test Configuration			Mode	Freq. (MHz)	Meas. SAR (W/kg)		Largest to Smallest SAR Ratio	Plot No.
	Exposure	Position	Dist. (mm)			Original	Repeated		
WLAN 2.4 GHz	Body	Front	0	11b	2437	0.601	N/A	N/A	-
WLAN 5.2 GHz	Body	Right	0	11n40	5230	0.476	N/A	N/A	-

#### Note(s):

N/A: Repeated Measurement is not required since the original highest measured SAR for all band is  $< 0.80$  W/kg.

### SECTION 13: Test instruments

#### For Output power measurement

LIMS ID	Description	Manufacturer	Model	Serial	Last Cal Date	Interval
141810	Power Meter	Anritsu Corporation	ML2495A	824014	2022/12/26	12
141814	Power Meter	Raditeq (Formerly DARE! Instruments)	RPR3006W	14100048SNO082	2023/10/04	12
141312	Attenuator	Weinschel Associates	WA56-10	56100304	2023/05/18	12
184492	Microwave Cable	Murata Manufacturing Company, Ltd.	MXHS83QE3000	-	2023/09/12	12

#### For SAR measurement

LIMS ID	Description	Manufacturer	Model	Serial	Last Cal Date	Interval
141589	Dosimetric E-Field Probe	Schmid & Partner Engineering AG	EX3DV4	3922	2023/08/11	12
141482	Data Acquisition Electronics	Schmid & Partner Engineering AG	DAE4	509	2023/08/04	12
141457	Dipole Antenna	Schmid & Partner Engineering AG	D2450V2	713	2022/09/12	24
88581	Thermo-Hygrometer	CUSTOM Inc	CTH-201	-	2023/07/18	12
142247	SAR robot	Schmid & Partner Engineering AG	TX60 Lspeag	F10/5E3LA1/A/01	2023/04/27	12
142056	2mm Oval Flat Phantom	Schmid & Partner Engineering AG	QDOVA001BB	1045	2023/05/10	12
141182	Dielectric assessment software	Schmid & Partner Engineering AG	DAK	-	-	-
173900	Software for MA24106A	Anritsu Corporation	Anritsu PowerXpert	-	-	-
141471	Dielectric assessment kit	Schmid & Partner Engineering AG	DAKS-3.5	0008	2023/04/17	12
142313	Attenuator	Telegartner	J01156A0011	42294119	-	-
141551	Vector Reflectometer	Copper Mountain Technologies	PLANAR R140	0030913	2023/04/13	12
141574	Digital thermometer	LKM electronic	DTM3000	-	2023/07/18	12
176484	Head Simulating Liquid	Schmid & Partner Engineering AG	HBBL600-10000V6	SL AAH U16 BC	-	-
141875	Pre Amplifier	R&K	R&K CGA020M602-2633R	B30550	2023/06/27	12
141181	Dasy5	Schmid & Partner Engineering AG	DASY5	-	-	-
141890	Signal Generator	Keysight Technologies Inc	N5181A	MY47421098	2023/11/10	12
142559	Dual Directional Coupler	Hewlett Packard	772D	2839A0016	-	-
141311	Attenuator	Weinschel Associates	WA1-20-33	100131	2023/04/03	12
141808	Dual Power Meter	Keysight Technologies Inc	E4419B	MY45102060	2023/08/25	12
221492	Power sensor	Keysight Technologies Inc	E9300H	MY62080002	2023/08/25	12
221493	Power Sensor	Anritsu Corporation	MA24118A	2123074	2023/08/24	12
221497	Power Sensor	Anritsu Corporation	MA24118A	2123095	2023/08/24	12
141467	Dipole Antenna	Schmid & Partner Engineering AG	D5GHzV2	1020	2023/11/15	12

The expiration date of the calibration is the end of the expired month.

All equipment is calibrated with valid calibrations. Each measurement data is traceable to the national or international standards.

As for some calibrations performed after the tested dates, those test equipment have been controlled by means of an unbroken chains of calibrations.

SAR room is checked before every testing and ambient noise is <0.012 W/kg

## APPENDIX 1: System Check

### System check result 2450 MHz

Communication System: UID 0, CW (0); Communication System Band: D2450 (2450.0 MHz); ; Duty Cycle: 1:1

Medium parameters used:  $f = 2450$  MHz;  $\sigma = 1.736$  S/m;  $\epsilon_r = 38.371$ ;  $\rho = 1000$  kg/m<sup>3</sup>

Phantom section: Flat Section

DASY5 Configuration

Probe: EX3DV4 - SN3922; ConvF(7.88, 7.88, 7.88) @ 2450 MHz;

Sensor-Surface: 1.4mm (Mechanical Surface Detection)

Electronics: DAE4 Sn509;

Phantom: ELI v4.0 (20deg probe tilt); Type: QDOVA001BB;Serial: TP:1045

Measurement SW: DASY52, Version 52.10 (4);SEMCAD X Version 14.6.14 (7501)

### System Performance Check at Frequencies 2450MHz/d=12mm, Pin=250 mW/Area Scan (81x71x1):

Interpolated grid: dx=1.200 mm, dy=1.200 mm

Maximum value of SAR (interpolated) = 22.3 W/kg

### System Performance Check at Frequencies 2450MHz/d=12mm, Pin=250 mW/Z Scan (1x1x18):

Measurement grid: dx=20mm, dy=20mm, dz=5mm

Penetration depth = 7.403 (7.016, 7.722) [mm]

Maximum value of SAR (interpolated) = 27.8 W/kg

### System Performance Check at Frequencies 2450MHz/d=12mm, Pin=250 mW/Zoom Scan (7x7x7)

(7x7x7)/Cube 0: Measurement grid: dx=5mm, dy=5mm, dz=5mm

Reference Value = 118.5 V/m; Power Drift = 0.04 dB

Peak SAR (extrapolated) = 27.5 W/kg

**SAR(1 g) = 13.4 W/kg; SAR(10 g) = 6.25 W/kg**

Smallest distance from peaks to all points 3 dB below = 9 mm

Ratio of SAR at M2 to SAR at M1 = 49.2%

Maximum value of SAR (measured) = 22.5 W/kg

Ambient Temp. : 23.0 degree.C. Liquid Temp.; 22.5 degree.C.

Liquid temp. is kept within the 2 degree.C. during the test.

Date: 2023/11/27

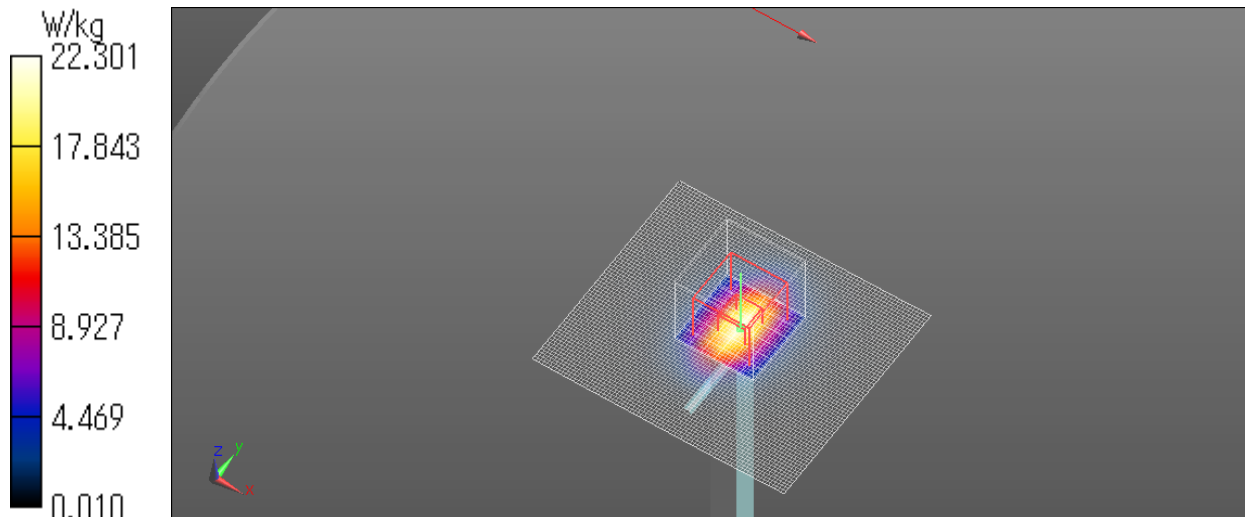

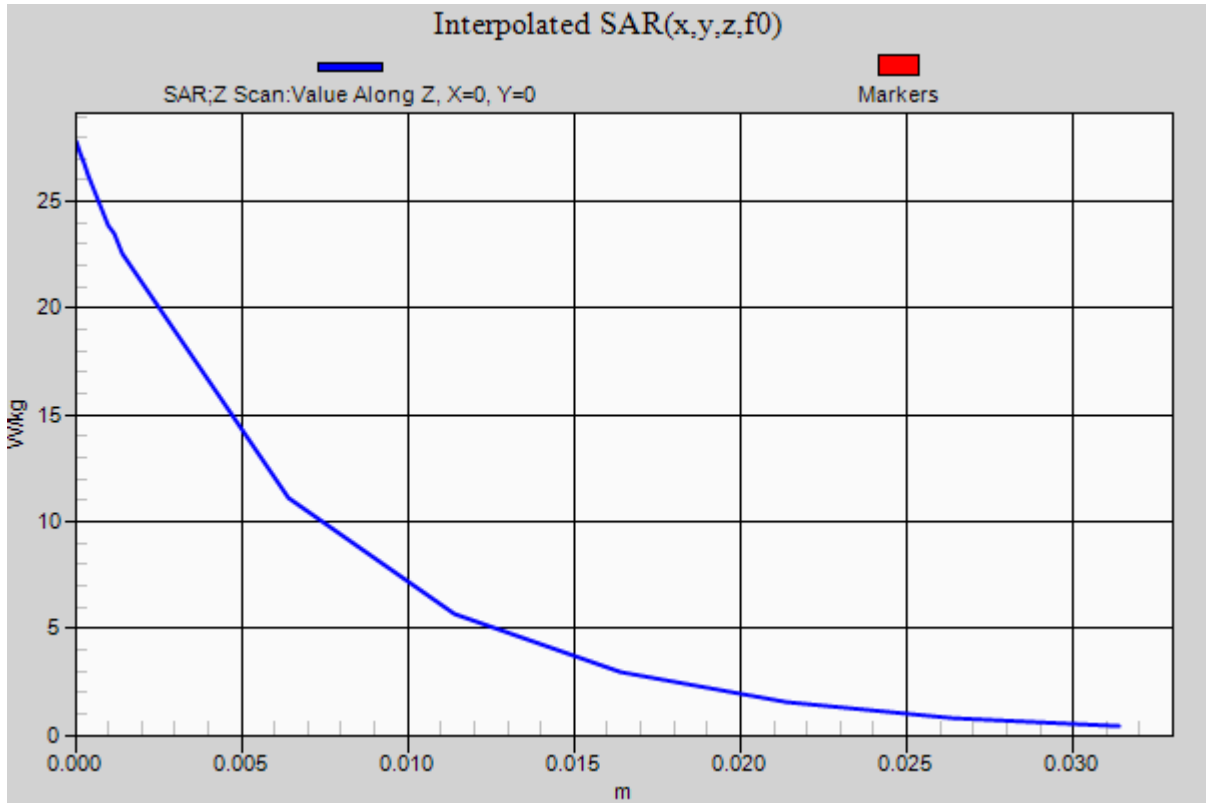

### System check result 5250 MHz

Communication System: UID 0, #CW (0); Communication System Band: D5GHz (5000.0 - 6000.0 MHz); ;  
Duty Cycle: 1:1

Medium parameters used:  $f = 5250$  MHz;  $\sigma = 4.718$  S/m;  $\epsilon_r = 35.333$ ;  $\rho = 1000$  kg/m<sup>3</sup>

Phantom section: Flat Section

DASY5 Configuration

Probe: EX3DV4 - SN3922; ConvF(5.54, 5.54, 5.54) @ 5250 MHz;

Sensor-Surface: 1.4mm (Mechanical Surface Detection)

Electronics: DAE4 Sn509;

Phantom: ELI v4.0 (20deg probe tilt); Type: QDOVA001BB;Serial: TP:1045

Measurement SW: DASY52, Version 52.10 (4);SEMCAD X Version 14.6.14 (7501)

**Head Tissue/START - Find Maximum/Area Scan (41x41x1):** Interpolated grid: dx=1.000 mm, dy=1.000 mm

Maximum value of SAR (interpolated) = 19.3 W/kg

**Head Tissue/Step A, Pin=100mW,/Zoom Scan, dist=1.4mm (8x8x8)/Cube 0:** Measurement grid: dx=4mm, dy=4mm, dz=1.4mm

Reference Value = 72.61 V/m; Power Drift = 0.01 dB

Peak SAR (extrapolated) = 31.0 W/kg

**SAR(1 g) = 7.79 W/kg; SAR(10 g) = 2.26 W/kg**

Smallest distance from peaks to all points 3 dB below = 7.4 mm

Ratio of SAR at M2 to SAR at M1 = 65.9%

Maximum value of SAR (measured) = 18.6 W/kg

**Head Tissue/Step A, Pin=100mW,/Z Scan, Uniform (1x1x25):** Measurement grid: dx=20mm, dy=20mm, dz=1.4mm

Penetration depth = 3.200 (3.474, 3.211) [mm]

Maximum value of SAR (interpolated) = 29.7 W/kg

Ambient Temp. : 20.0 degree.C. Liquid Temp.; 20.0 degree.C.

Liquid temp. is kept within the 2 degree.C. during the test.

Date: 2023/11/29

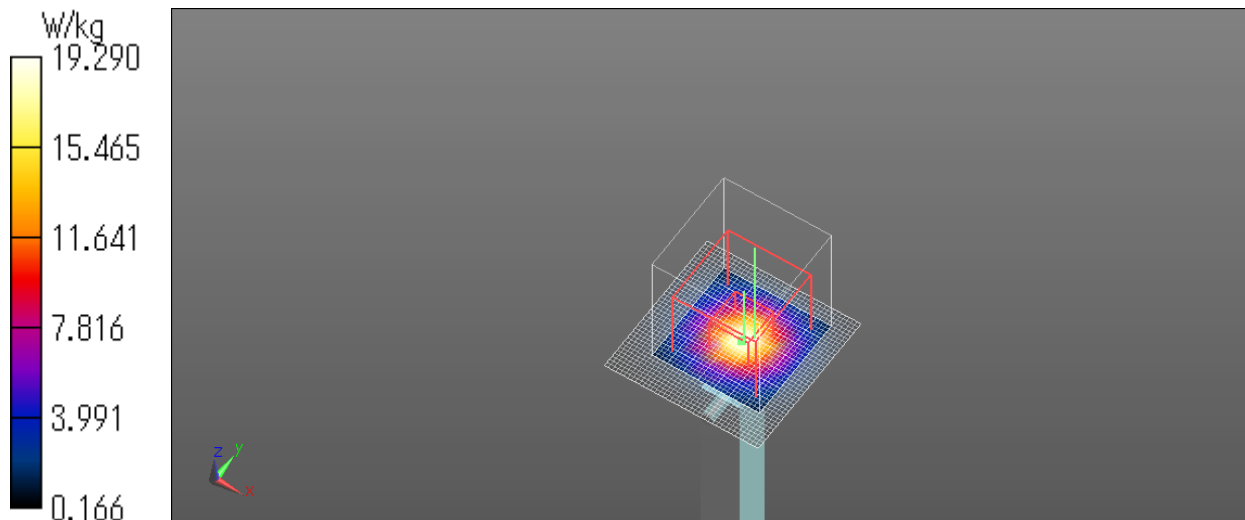

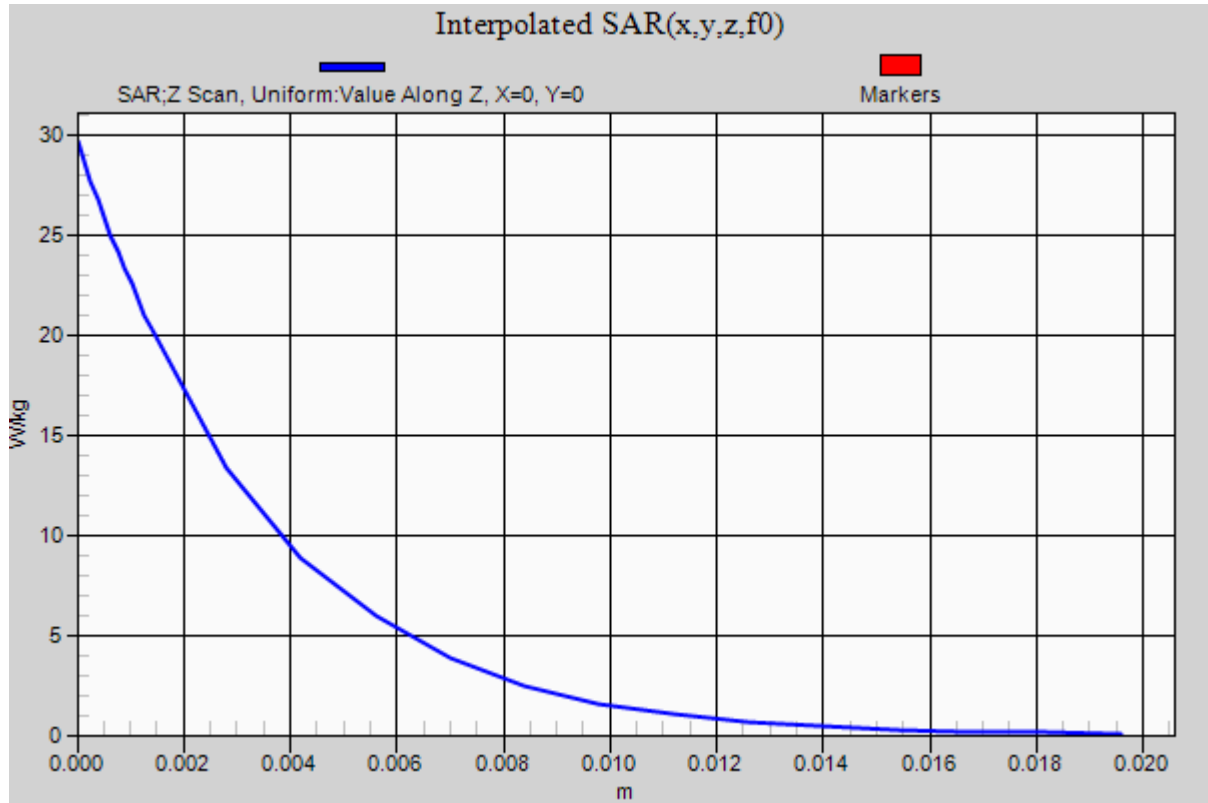

---

## **APPENDIX 2: SAR Measurement data**

### **Evaluation procedure**

**The evaluation was performed with the following procedure:**

**Step 1:** Measurement of the E-field at a fixed location above the ear point or central position of flat phantom was used as a reference value for assessing the power drop.

**Step 2:** The SAR distribution at the exposed side of head or body position was measured at a distance of each device from the inner surface of the shell. The area covered the entire dimension of the antenna of EUT and the horizontal grid spacing was 15 mm x 15 mm, 12 mm x 12 mm or 10 mm x 10 mm. Based on these data, the area of the maximum absorption was determined by spline interpolation.

**Step 3:** Around this point found in the Step 2 (area scan), a volume of 30 mm x 30 mm x 30 mm or more was assessed by measuring 7 x 7 x 7 points at least for below 3 GHz, a volume of 28 mm x 28 mm x 34 mm or more was assessed by measuring 8 x 8 x 8 (ratio step method (\*1)) points at least for 3 GHz to 5 GHz and a volume of 28 mm x 28 mm x 24 mm or more was assessed by measuring 8 x 8 x 8 (ratio step method) points at least for 5 GHz to 6 GHz.

And for any secondary peaks found in the Step2 which are within 2 dB of maximum peak and not with this Step3 (Zoom scan) is repeated. On the basis of this data set, the spatial peak SAR value was evaluated under the following procedure:

(1). The data at the surface were extrapolated, since the center of the dipoles is 1 mm(EX3DV4) away from the tip of the probe and the distance between the surface and the lowest measuring point is 1.3 mm. The extrapolation was based on a least square algorithm [4]. A polynomial of the fourth order was calculated through the points in z-axes.

This polynomial was then used to evaluate the points between the surface and the probe tip.

(2). The maximum interpolated value was searched with a straightforward algorithm. Around this maximum the SAR values averaged over the spatial volumes (1 g or 10 g) were computed by the 3D-Spline interpolation algorithm. The 3D-Spline is composed of three one-dimensional splines with the "Not a knot"-condition (in x, y and z-directions). The volume was integrated with the trapezoidal-algorithm. One thousand points (10 x 10 x 10) were interpolated to calculate the average.

(3). All neighboring volumes were evaluated until no neighboring volume with a higher average value was found.

**\*1. Ratio step method parameters used;**

**The first measurement point: 1.4 mm from the phantom surface, the initial grid separation: 1.4 mm, subsequent graded grid ratio: 1.4**

**These parameters comply with the requirement of the KDB 865664 D01.**

**Step 4:** Re-measurement of the E-field at the same location as in Step 1.

Confirmation after SAR testing

It was checked that the power drift [W] is within +/-5 %. The verification of power drift during the SAR test is that DASY5 system calculates the power drift by measuring the e-field at the same location at beginning and the end of the scan measurement for each test position.

DASY5 system calculation Power drift value[dB] =  $20\log(E_a)/(E_b)$

Before SAR testing :  $E_b$  [V/m]

After SAR testing :  $E_a$  [V/m]

Limit of power drift[W] = +/- 5 %

$X[\text{dB}] = 10\log[P] = 10\log(1.05/1) = 10\log(1.05) - 10\log(1) = 0.212 \text{ dB}$

from E-field relations with power.

$p = E^2/\eta$

Therefore, The correlation of power and the E-field

$X \text{ dB} = 10\log(P) = 10\log(E)^2 = 20\log(E)$

Therefore,

The calculated power drift of DASY5 System must be the less than +/- 0.212 dB.

## Measurement data

Plot No. 1

### WLAN 2.4 GHz

Communication System: UID 0, \_WLAN (0); Communication System Band: 11b/g/n; ; Duty Cycle: 1:1  
Medium parameters used (interpolated):  $f = 2437$  MHz;  $\sigma = 1.727$  S/m;  $\epsilon_r = 38.375$ ;  $\rho = 1000$  kg/m<sup>3</sup>

Phantom section: Flat Section

DASY5 Configuration

Probe: EX3DV4 - SN3922; ConvF(7.88, 7.88, 7.88) @ 2437 MHz;

Sensor-Surface: 1.4mm (Mechanical Surface Detection)

Electronics: DAE4 Sn509;

Phantom: ELI v4.0 (20deg probe tilt); Type: QDOVA001BB;Serial: TP:1045

Measurement SW: DASY52, Version 52.10 (4);SEMCAD X Version 14.6.14 (7501)

**WLAN 2.4 GHz/11b 2437 MHz Front/Area Scan (51x71x1):** Interpolated grid: dx=1.200 mm, dy=1.200 mm

Info: Interpolated medium parameters used for SAR evaluation.

Maximum value of SAR (interpolated) = 1.15 W/kg

**WLAN 2.4 GHz/11b 2437 MHz Front/Zoom Scan (7x7x7)/Cube 0:** Measurement grid: dx=5mm, dy=5mm, dz=5mm

Reference Value = 25.14 V/m; Power Drift = -0.08 dB

Peak SAR (extrapolated) = 1.27 W/kg

**SAR(1 g) = 0.601 W/kg; SAR(10 g) = 0.260 W/kg**

Smallest distance from peaks to all points 3 dB below = 8.5 mm

Ratio of SAR at M2 to SAR at M1 = 51.1%

Info: Interpolated medium parameters used for SAR evaluation.

Maximum value of SAR (measured) = 1.01 W/kg

Ambient Temp. : 23.0 degree.C. Liquid Temp.; 22.5 degree.C.

Liquid temp. is kept within the 2 degree.C. during the test.

Date: 2023/11/27

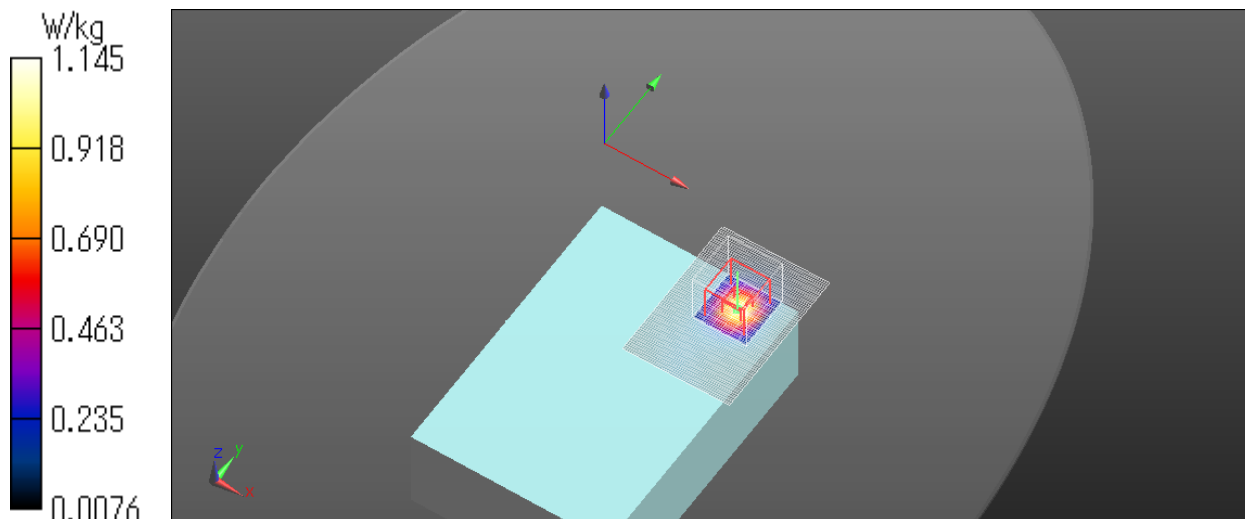



Plot No. 2

**WLAN 5.2 GHz**

Communication System: UID 0, #WLAN 11a/b/g/n (0); Communication System Band: 11a/n (W52 53); ;  
Duty Cycle: 1:1

Medium parameters used:  $f = 5230$  MHz;  $\sigma = 4.632$  S/m;  $\epsilon_r = 35.363$ ;  $\rho = 1000$  kg/m<sup>3</sup>

Phantom section: Flat Section

DASY5 Configuration

Probe: EX3DV4 - SN3922; ConvF(5.54, 5.54, 5.54) @ 5230 MHz;

Sensor-Surface: 1.4mm (Mechanical Surface Detection)

Electronics: DAE4 Sn509;

Phantom: ELI v4.0 (20deg probe tilt); Type: QDOVA001BB;Serial: TP:1045

Measurement SW: DASY52, Version 52.10 (4);SEMCAD X Version 14.6.14 (7501)

**WLAN 5.2 GHz/11n40 5230 MHz Right/Area Scan (91x121x1):** Interpolated grid: dx=1.000 mm, dy=1.000 mm

Maximum value of SAR (interpolated) = 1.15 W/kg

**WLAN 5.2 GHz/11n40 5230 MHz Right/Zoom Scan (8x8x8)/Cube 0:** Measurement grid: dx=4mm, dy=4mm, dz=1.4mm

Reference Value = 16.45 V/m; Power Drift = -0.09 dB

Peak SAR (extrapolated) = 1.59 W/kg

**SAR(1 g) = 0.476 W/kg; SAR(10 g) = 0.163 W/kg**

Smallest distance from peaks to all points 3 dB below = 8 mm

Ratio of SAR at M2 to SAR at M1 = 68.8%

Maximum value of SAR (measured) = 1.08 W/kg

Ambient Temp. : 20.0 degree.C. Liquid Temp.; 20.0 degree.C.

Liquid temp. is kept within the 2 degree.C. during the test.

Date: 2023/11/29

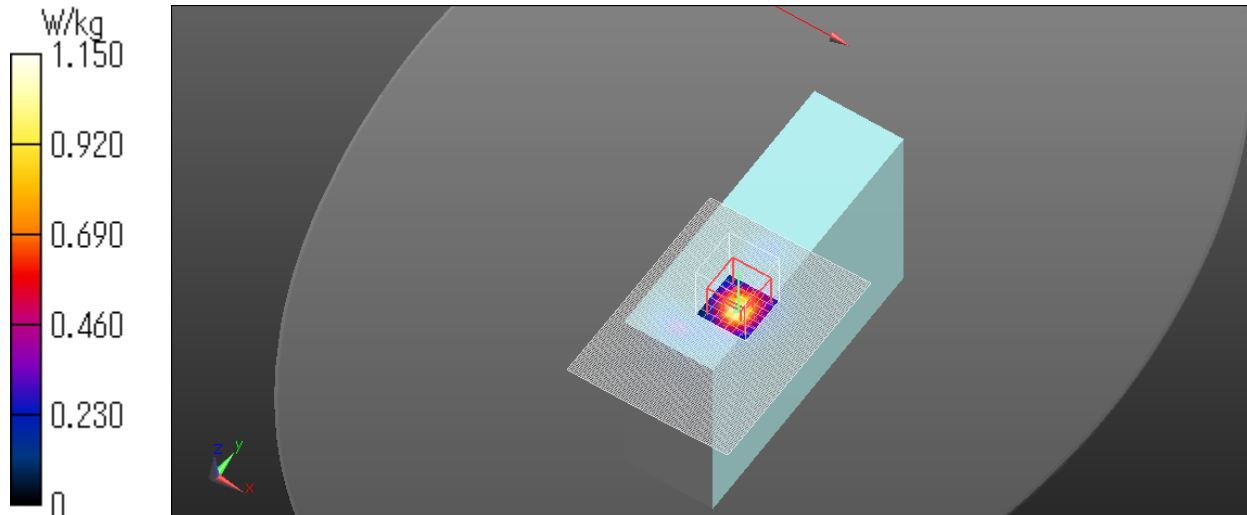

## APPENDIX 3: System specifications

### Configuration and peripherals

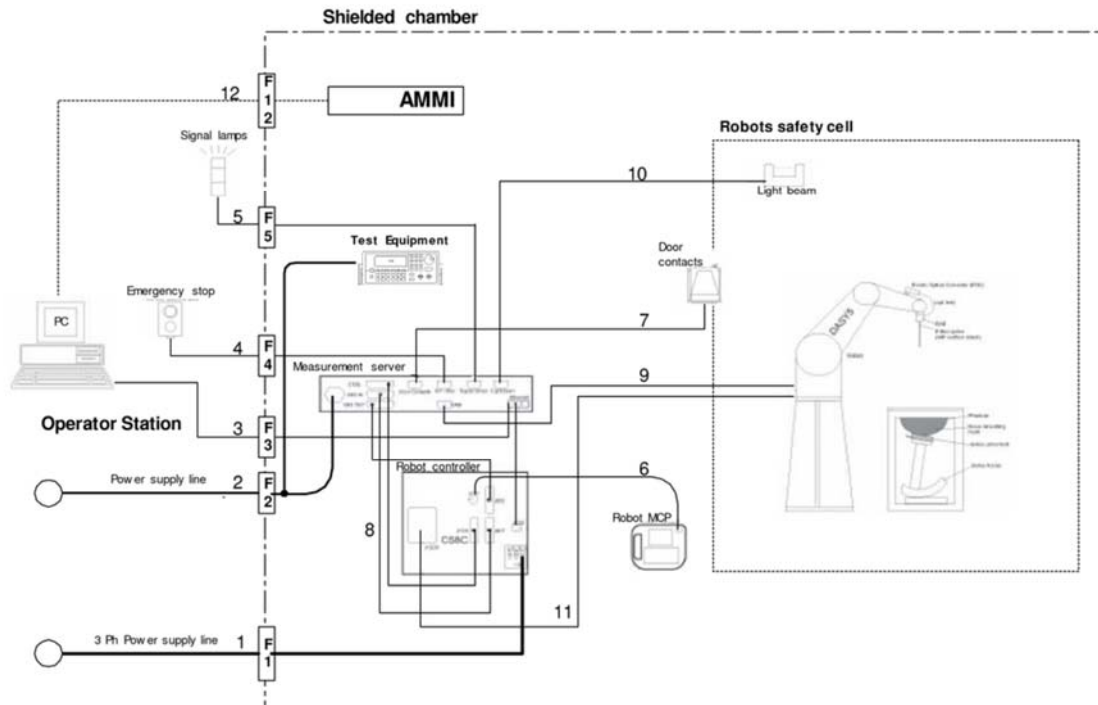

The DASY5 system for performing compliance tests consist of the following items:  
Our system is DASY6; however, it behaves as DASY5.

- a) A standard high precision 6-axis robot (Stäubli RX family) with controller and software.  
An arm extension for accommodating the data acquisition electronics (DAE).
- b) An isotropic field probe optimized and calibrated for the targeted measurement.
- c) A data acquisition electronic (DAE), which performs the signal amplification, signal multiplexing, AD-conversion, offset measurements, mechanical surface detection, collision detection, etc. The unit is battery powered with standard or rechargeable batteries. The signal is optically transmitted to the EOC.
- d) The Electro-optical converter (EOC) performs the conversion between optical and electrical of the signals for the digital communication to the DAE and for the analog signal from the optical surface detection. The EOC is connected to the measurement server.
- e) The function of the measurement server is to perform the time critical tasks such as signal filtering, control of the robot operation and fast movement interrupts.
- f) The Light Beam used is for probe alignment. This improves the (absolute) accuracy of the probe positioning.
- g) A computer running Windows 10 or 7 and the DASY5/6 software.
- h) Remote control with teaches pendant and additional circuitry for robot safety such as warning lamps, etc.
- i) The phantom, the device holder and other accessories according to the targeted measurement.

---

## Specifications

### a) Robot TX60L

Number of Axes	:	6
Nominal Load	:	2 kg
Maximum Load	:	5 kg
Reach	:	920 mm
Repeatability	:	+/-0.03 mm
Control Unit	:	CS8c
Programming Language	:	VAL3
Weight	:	52.2 kg
Manufacture	:	Stäubli Robotics

### b) E-Field Probe

Model	:	EX3DV4
Construction	:	Symmetrical design with triangular core Built-in shielding against static charges PEEK enclosure material (resistant to organic solvents, e.g., glycol ether)
Frequency	:	10 MHz to > 6 GHz Linearity: $\pm 0.2$ dB (30 MHz to 6 GHz)
Directivity	:	+/-0.3 dB in HSL (rotation around probe axis) +/-0.5 dB in tissue material (rotation normal probe axis)
Dynamic Range	:	10 $\mu$ W/g to > 100 mW/g; Linearity +/-0.2 dB (noise: typically < 1 $\mu$ W/g)
Dimensions	:	Overall length: 337 mm (Tip: 20 mm) Tip diameter: 2.5 mm (Body: 12 mm) Typical distance from probe tip to dipole centers: 1 mm
Application	:	Highprecision dosimetric measurement in any exposure scenario (e.g., very strong gradient fields). Only probe which enables compliance testing for frequencies up to 6 GHz with precision of better 30 %.
Manufacture	:	Schmid & Partner Engineering AG



**EX3DV4 E-field Probe**

---

#### **c) Data Acquisition Electronic (DAE4)**

<b>Features</b>	:	Signal amplifier, multiplexer, A/D converter and control logic Serial optical link for communication with DASY5 embedded system (fully remote controlled) Two step probe touch detector for mechanical surface detection and emergency robot stop
<b>Measurement Range</b>	:	-100 to +300 mV (16 bit resolution and two range settings: 4 mV, 400 mV)
<b>Input Offset voltage</b>	:	< 5 $\mu$ V (with auto zero)
<b>Input Resistance</b>	:	200 M $\Omega$
<b>Input Bias Current</b>	:	< 50 fA
<b>Battery Power</b>	:	> 10 h of operation (with two 9.6 V NiMH accus)
<b>Dimension</b>	:	60 x 60 x 68 mm
<b>Manufacture</b>	:	Schmid & Partner Engineering AG

#### **d) Electro-Optic Converter (EOC)**

<b>Version</b>	:	EOC 61
<b>Description</b>	:	for TX60 robot arm, including proximity sensor
<b>Manufacture</b>	:	Schmid & Partner Engineering AG

#### **e) DASY5 Measurement server**

<b>Features</b>	:	Intel ULV Celeron 400 MHz 128 MB chip disk and 128 MB RAM 16 Bit A/D converter for surface detection system Vacuum Fluorescent Display Robot Interface Serial link to DAE (with watchdog supervision) Door contact port (Possibility to connect a light curtain) Emergency stop port (to connect the remote control) Signal lamps port Light beam port Three Ethernet connection ports Two USB 2.0 Ports Two serial links Expansion port for future applications
<b>Dimensions (L x W x H)</b>	:	440 x 241 x 89 mm
<b>Manufacture</b>	:	Schmid & Partner Engineering AG

#### **f) Light Beam Switches**

<b>Version</b>	:	LB5
<b>Dimensions (L x H)</b>	:	110 x 80 mm
<b>Thickness</b>	:	12 mm
<b>Beam-length</b>	:	80 mm
<b>Manufacture</b>	:	Schmid & Partner Engineering AG

#### **g) Software**

<b>Item</b>	:	Dosimetric Assessment System DASY5
<b>Type No.</b>	:	SD 000 401A, SD 000 402A
<b>Software version No.</b>	:	DASY52, Version 52.6 (1)
<b>Manufacture / Origin</b>	:	Schmid & Partner Engineering AG

#### **h) Robot Control Unit**

<b>Weight</b>	:	70 Kg
<b>AC Input Voltage</b>	:	selectable
<b>Manufacturer</b>	:	Stäubli Robotics

---

### i) Phantom and Device Holder

#### Phantom

<b>Type</b>	:	SAM Twin Phantom V4.0
<b>Description</b>	:	The shell corresponds to the specifications of the Specific Anthropomorphic Mannequin (SAM) phantom defined in IEEE 1528 and IEC 62209-1. It enables the dosimetric evaluation of left and right hand phone usage as well as body mounted usage at the flat phantom region. A cover prevents evaporation of the liquid. Reference markings on the phantom allow the complete setup of all predefined phantom positions and measurement grids by teaching three points with the robot.
<b>Material</b>	:	Vinylester, glass fiber reinforced (VE-GF)
<b>Shell Material</b>	:	Fiberglass
<b>Thickness</b>	:	2.0 +/- 0.2 mm
<b>Dimensions</b>	:	Length: 1000 mm Width: 500 mm Height: adjustable feet
<b>Volume</b>	:	Approx. 25 liters
<b>Manufacture</b>	:	Schmid & Partner Engineering AG

<b>Type</b>	:	2 mm Flat phantom ELI4.0 or 5
<b>Description</b>	:	Phantom for compliance testing of handheld and body-mounted wireless devices in the frequency range of 30 MHz to 6 GHz. ELI4 is fully compatible with the latest draft of the standard IEC 62209 Part II and all known tissue simulating liquids. ELI4 has been optimized regarding its performance and can be integrated into our standard phantom tables. A cover prevents evaporation of the liquid. Reference markings on the phantom allow installation of the complete setup, including all predefined phantom positions and measurement grids, by teaching three points. The phantom is supported by software version DASY4.5 and higher and is compatible with all SPEAG dosimetric probes and dipoles.
<b>Material</b>	:	Vinylester, glass fiber reinforced (VE-GF)
<b>Shell Thickness</b>	:	2.0 ± 0.2 mm (sagging: < 1 %)
<b>Filling Volume</b>	:	Approx. 30 liters
<b>Dimensions</b>	:	Major ellipse axis: 600 mm Minor axis: 400 mm
<b>Manufacture</b>	:	Schmid & Partner Engineering AG

#### Device Holder

In combination with the Twin SAM Phantom V4.0/V4.0c or ELI4, the Mounting Device enables the rotation of the mounted transmitter device in spherical coordinates. Rotation point is the ear opening point. Transmitter devices can be easily and accurately positioned according to IEC, IEEE, FCC or other specifications. The device holder can be locked for positioning at different phantom sections (left head, right head, flat).

<b>Material</b>	:	POM
-----------------	---	-----

#### Laptop Extensions kit

Simple but effective and easy-to-use extension for Mounting Device that facilitates the testing of larger devices according to IEC 62209-2 (e.g., laptops, cameras, etc.). It is lightweight and fits easily on the upper part of the Mounting Device in place of the phone positioner. The extension is fully compatible with the Twin-SAM, ELI4 Phantoms.

<b>Material</b>	:	POM, Acrylic glass, Foam
-----------------	---	--------------------------

#### Urethane

For this measurement, the urethane foam was used as device holder.

**j) Simulated Tissues (Liquid)**

The following tissue formulations are provided for reference only as some of the parameters have not been thoroughly verified. The composition of ingredients may be modified accordingly to achieve the desired target tissue parameters required for routine SAR evaluation.

**Product identifier**

Trade name	Broad Band Tissue Simulation Liquid HBBL600-10000V6, MBBL600-6000V6, HU16B, MU16B
Manufacturer/Supplier	Schmid & Partner Engineering AG

**Declarable components:**

CAS: 107-21-1 EINECS: 203-473-3 Reg.nr.: 01-2119456816-28-0000	<b>Ethenediol</b> STOT RE 2, H373; Acute Tox. 4, H302	< 5.2%
CAS: 68608-26-4 EINECS: 271-781-5 Reg.nr.: 01-2119527859-22-0000	<b>Sodium petroleum sulfonate</b> Eye Irrit. 2, H319	< 2.9%
CAS: 107-41-5 EINECS: 203-489-0 Reg.nr.: 01-2119539582-35-0000	<b>Hexylene Glycol / 2-Methyl-pentane-2,4-diol</b> Skin Irrit. 2, H315; Eye Irrit. 2, H319	< 2.9%
CAS: 68920-66-1 NLP: 500-236-9 Reg.nr.: 01-2119489407-26-0000	<b>Alkoxylated alcohol, &gt; C<sub>16</sub></b> Aquatic Chronic 2, H411; Skin Irrit. 2, H315; Eye Irrit. 2, H319	< 2.0%

**System Check Dipole SAR Calibration Certificate -Dipole 2450 MHz (D2450V2 S/N: 713)**

**Calibration Laboratory of  
Schmid & Partner  
Engineering AG**  
Zeughausstrasse 43, 8004 Zurich, Switzerland



**S** Schweizerischer Kalibrierdienst  
**S** Service suisse d'étalonnage  
**C** Servizio svizzero di taratura  
**S** Swiss Calibration Service

Accredited by the Swiss Accreditation Service (SAS)  
The Swiss Accreditation Service is one of the signatories to the EA  
Multilateral Agreement for the recognition of calibration certificates

Accreditation No.: **SCS 0108**

Client **UL Japan Head Office (RCC)**

Certificate No: **D2450V2-713\_Sep22**

CALIBRATION CERTIFICATE			
Object	D2450V2 - SN:713		
Calibration procedure(s)	QA CAL-05.v11 Calibration Procedure for SAR Validation Sources between 0.7-3 GHz		
Calibration date:	September 12, 2022		
This calibration certificate documents the traceability to national standards, which realize the physical units of measurements (SI). The measurements and the uncertainties with confidence probability are given on the following pages and are part of the certificate.			
All calibrations have been conducted in the closed laboratory facility: environment temperature (22 ± 3)°C and humidity < 70%.			
Calibration Equipment used (M&TE critical for calibration)			
Primary Standards	ID #	Cal Date (Certificate No.)	Scheduled Calibration
Power meter NRP	SN: 104778	04-Apr-22 (No. 217-03525/03524)	Apr-23
Power sensor NRP-Z91	SN: 103244	04-Apr-22 (No. 217-03524)	Apr-23
Power sensor NRP-Z91	SN: 103245	04-Apr-22 (No. 217-03525)	Apr-23
Reference 20 dB Attenuator	SN: BH9394 (20k)	04-Apr-22 (No. 217-03527)	Apr-23
Type-N mismatch combination	SN: 310982 / 06327	04-Apr-22 (No. 217-03528)	Apr-23
Reference Probe EX3DV4	SN: 7349	31-Dec-21 (No. EX3-7349_Dec21)	Dec-22
DAE4	SN: 601	31-Aug-22 (No. DAE4-601_Aug22)	Aug-23
Secondary Standards	ID #	Check Date (in house)	Scheduled Check
Power meter E4419B	SN: GB39512475	30-Oct-14 (in house check Oct-20)	In house check: Oct-22
Power sensor HP 8481A	SN: US37292783	07-Oct-15 (in house check Oct-20)	In house check: Oct-22
Power sensor HP 8481A	SN: MY41093315	07-Oct-15 (in house check Oct-20)	In house check: Oct-22
RF generator R&S SMT-06	SN: 100972	15-Jun-15 (in house check Oct-20)	In house check: Oct-22
Network Analyzer Agilent E8358A	SN: US41080477	31-Mar-14 (in house check Oct-20)	In house check: Oct-22
Calibrated by:	Name Michael Weber	Function Laboratory Technician	Signature 
Approved by:	Sven Kühn	Technical Manager	
			Issued: September 13, 2022
This calibration certificate shall not be reproduced except in full without written approval of the laboratory.			

Certificate No: D2450V2-713\_Sep22

Page 1 of 8



**Calibration Laboratory of  
Schmid & Partner  
Engineering AG**  
Zeughausstrasse 43, 8004 Zurich, Switzerland



**S** Schweizerischer Kalibrierdienst  
**C** Service suisse d'étalonnage  
**S** Servizio svizzero di taratura  
**S** Swiss Calibration Service

Accredited by the Swiss Accreditation Service (SAS)  
The Swiss Accreditation Service is one of the signatories to the EA  
Multilateral Agreement for the recognition of calibration certificates

Accreditation No.: **SCS 0108**

**Glossary:**

TSL	tissue simulating liquid
ConvF	sensitivity in TSL / NORM x,y,z
N/A	not applicable or not measured

**Calibration is Performed According to the Following Standards:**

- a) IEC/IEEE 62209-1528, "Measurement Procedure For The Assessment Of Specific Absorption Rate Of Human Exposure To Radio Frequency Fields From Hand-Held And Body-Worn Wireless Communication Devices - Part 1528: Human Models, Instrumentation And Procedures (Frequency Range of 4 MHz to 10 GHz)", October 2020.
- b) KDB 865664, "SAR Measurement Requirements for 100 MHz to 6 GHz"

**Additional Documentation:**

- c) DASYS System Handbook

**Methods Applied and Interpretation of Parameters:**

- *Measurement Conditions:* Further details are available from the Validation Report at the end of the certificate. All figures stated in the certificate are valid at the frequency indicated.
- *Antenna Parameters with TSL:* The source is mounted in a touch configuration below the center marking of the flat phantom.
- *Return Loss:* This parameter is measured with the source positioned under the liquid filled phantom (as described in the measurement condition clause). The Return Loss ensures low reflected power. No uncertainty required.
- *SAR measured:* SAR measured at the stated antenna input power.
- *SAR normalized:* SAR as measured, normalized to an input power of 1 W at the antenna connector.
- *SAR for nominal TSL parameters:* The measured TSL parameters are used to calculate the nominal SAR result.

The reported uncertainty of measurement is stated as the standard uncertainty of measurement multiplied by the coverage factor  $k=2$ , which for a normal distribution corresponds to a coverage probability of approximately 95%.



**Measurement Conditions**

DASY system configuration, as far as not given on page 1.

DASY Version	DASY52	V52.10.4
Extrapolation	Advanced Extrapolation	
Phantom	Modular Flat Phantom	
Distance Dipole Center - TSL	10 mm	with Spacer
Zoom Scan Resolution	dx, dy, dz = 5 mm	
Frequency	2450 MHz ± 1 MHz	

**Head TSL parameters**

The following parameters and calculations were applied.

	Temperature	Permittivity	Conductivity
Nominal Head TSL parameters	22.0 °C	39.2	1.80 mho/m
Measured Head TSL parameters	(22.0 ± 0.2) °C	37.8 ± 6 %	1.84 mho/m ± 6 %
Head TSL temperature change during test	< 0.5 °C	----	----

**SAR result with Head TSL**

SAR averaged over 1 cm <sup>3</sup> (1 g) of Head TSL	Condition	
SAR measured	250 mW input power	13.3 W/kg
SAR for nominal Head TSL parameters	normalized to 1W	<b>52.3 W/kg ± 17.0 % (k=2)</b>

SAR averaged over 10 cm <sup>3</sup> (10 g) of Head TSL	condition	
SAR measured	250 mW input power	6.19 W/kg
SAR for nominal Head TSL parameters	normalized to 1W	<b>24.5 W/kg ± 16.5 % (k=2)</b>

**Body TSL parameters**

The following parameters and calculations were applied.

	Temperature	Permittivity	Conductivity
Nominal Body TSL parameters	22.0 °C	52.7	1.95 mho/m
Measured Body TSL parameters	(22.0 ± 0.2) °C	51.0 ± 6 %	2.03 mho/m ± 6 %
Body TSL temperature change during test	< 0.5 °C	----	----

**SAR result with Body TSL**

SAR averaged over 1 cm <sup>3</sup> (1 g) of Body TSL	Condition	
SAR measured	250 mW input power	13.0 W/kg
SAR for nominal Body TSL parameters	normalized to 1W	<b>50.6 W/kg ± 17.0 % (k=2)</b>

SAR averaged over 10 cm <sup>3</sup> (10 g) of Body TSL	condition	
SAR measured	250 mW input power	6.15 W/kg
SAR for nominal Body TSL parameters	normalized to 1W	<b>24.2 W/kg ± 16.5 % (k=2)</b>

**Appendix (Additional assessments outside the scope of SCS 0108)**

**Antenna Parameters with Head TSL**

Impedance, transformed to feed point	53.0 $\Omega$ + 1.9 j $\Omega$
Return Loss	- 29.2 dB

**Antenna Parameters with Body TSL**

Impedance, transformed to feed point	49.7 $\Omega$ + 4.7 j $\Omega$
Return Loss	- 26.5 dB

**General Antenna Parameters and Design**

Electrical Delay (one direction)	1.160 ns
----------------------------------	----------

After long term use with 100W radiated power, only a slight warming of the dipole near the feedpoint can be measured.

The dipole is made of standard semirigid coaxial cable. The center conductor of the feeding line is directly connected to the second arm of the dipole. The antenna is therefore short-circuited for DC-signals. On some of the dipoles, small end caps are added to the dipole arms in order to improve matching when loaded according to the position as explained in the "Measurement Conditions" paragraph. The SAR data are not affected by this change. The overall dipole length is still according to the Standard.

No excessive force must be applied to the dipole arms, because they might bend or the soldered connections near the feedpoint may be damaged.

**Additional EUT Data**

Manufactured by	SPEAG
-----------------	-------

**DASY5 Validation Report for Head TSL**

Date: 12.09.2022

Test Laboratory: SPEAG, Zurich, Switzerland

**DUT: Dipole 2450 MHz; Type: D2450V2; Serial: D2450V2 - SN: 713**

Communication System: UID 0 - CW; Frequency: 2450 MHz  
Medium parameters used:  $f = 2450$  MHz;  $\sigma = 1.84$  S/m;  $\epsilon_r = 37.8$ ;  $\rho = 1000$  kg/m<sup>3</sup>  
Phantom section: Flat Section  
Measurement Standard: DASY5 (IEEE/IEC/ANSI C63.19-2011)

DASY52 Configuration:

- Probe: EX3DV4 - SN7349; ConvF(7.96, 7.96, 7.96) @ 2450 MHz; Calibrated: 31.12.2021
- Sensor-Surface: 1.4mm (Mechanical Surface Detection)
- Electronics: DAE4 Sn601; Calibrated: 31.08.2022
- Phantom: Flat Phantom 5.0 (front); Type: QD 000 P50 AA; Serial: 1001
- DASY52 52.10.4(1535); SEMCAD X 14.6.14(7501)

**Dipole Calibration for Head Tissue/Pin=250 mW, d=10mm/Zoom Scan (7x7x7)/Cube 0:**

Measurement grid: dx=5mm, dy=5mm, dz=5mm  
Reference Value = 114.4 V/m; Power Drift = 0.07 dB  
Peak SAR (extrapolated) = 26.0 W/kg  
**SAR(1 g) = 13.3 W/kg; SAR(10 g) = 6.19 W/kg**  
Smallest distance from peaks to all points 3 dB below = 9 mm  
Ratio of SAR at M2 to SAR at M1 = 51.3%  
Maximum value of SAR (measured) = 21.6 W/kg

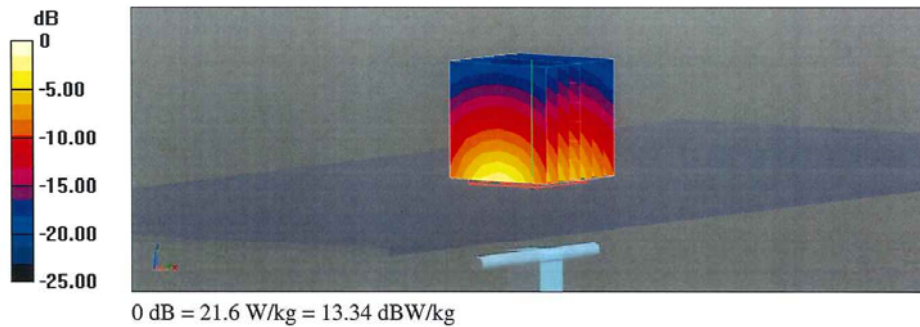

Impedance Measurement Plot for Head TSL

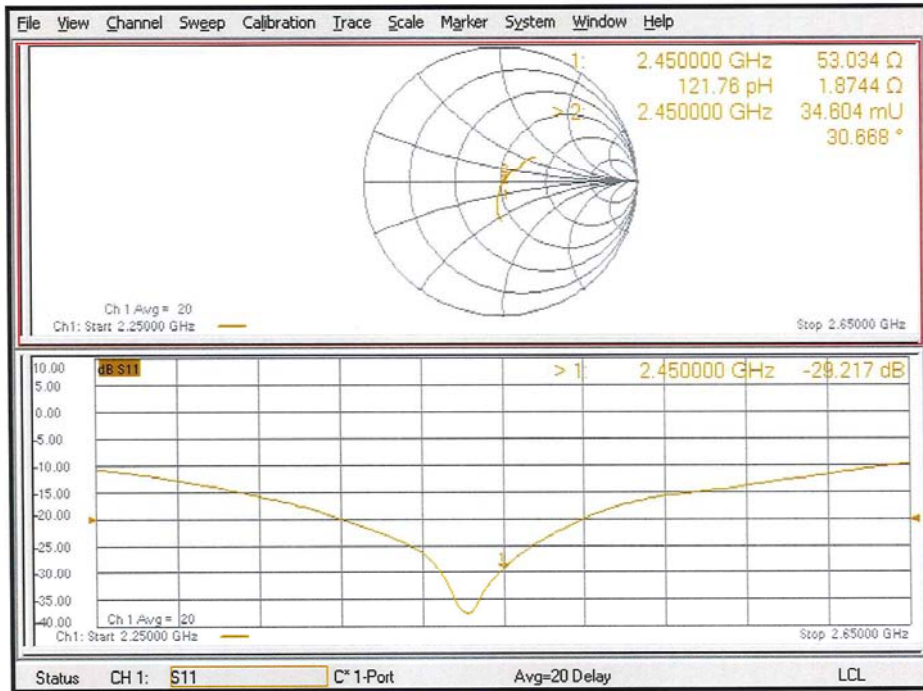

## DASY5 Validation Report for Body TSL

Date: 12.09.2022

Test Laboratory: SPEAG, Zurich, Switzerland

**DUT: Dipole 2450 MHz; Type: D2450V2; Serial: D2450V2 - SN: 713**

Communication System: UID 0 - CW; Frequency: 2450 MHz

Medium parameters used:  $f = 2450$  MHz;  $\sigma = 2.03$  S/m;  $\epsilon_r = 51$ ;  $\rho = 1000$  kg/m<sup>3</sup>

Phantom section: Flat Section

Measurement Standard: DASY5 (IEEE/IEC/ANSI C63.19-2011)

DASY52 Configuration:

- Probe: EX3DV4 - SN7349; ConvF(8.12, 8.12, 8.12) @ 2450 MHz; Calibrated: 31.12.2021
- Sensor-Surface: 1.4mm (Mechanical Surface Detection)
- Electronics: DAE4 Sn601; Calibrated: 31.08.2022
- Phantom: Flat Phantom 5.0 (back); Type: QD 000 P50 AA; Serial: 1002
- DASY52 52.10.4(1535); SEMCAD X 14.6.14(7501)

### Dipole Calibration for Body Tissue/Pin=250 mW, d=10mm/Zoom Scan (7x7x7)/Cube 0:

Measurement grid: dx=5mm, dy=5mm, dz=5mm

Reference Value = 108.3 V/m; Power Drift = -0.07 dB

Peak SAR (extrapolated) = 24.2 W/kg

**SAR(1 g) = 13.0 W/kg; SAR(10 g) = 6.15 W/kg**

Smallest distance from peaks to all points 3 dB below = 9 mm

Ratio of SAR at M2 to SAR at M1 = 55.3%

Maximum value of SAR (measured) = 19.7 W/kg

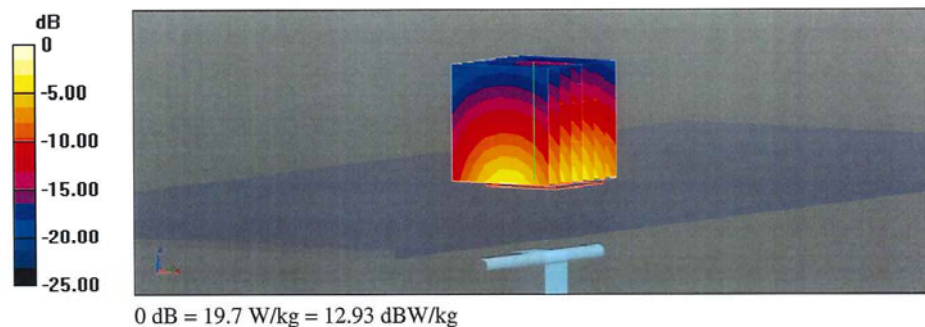

### Impedance Measurement Plot for Body TSL

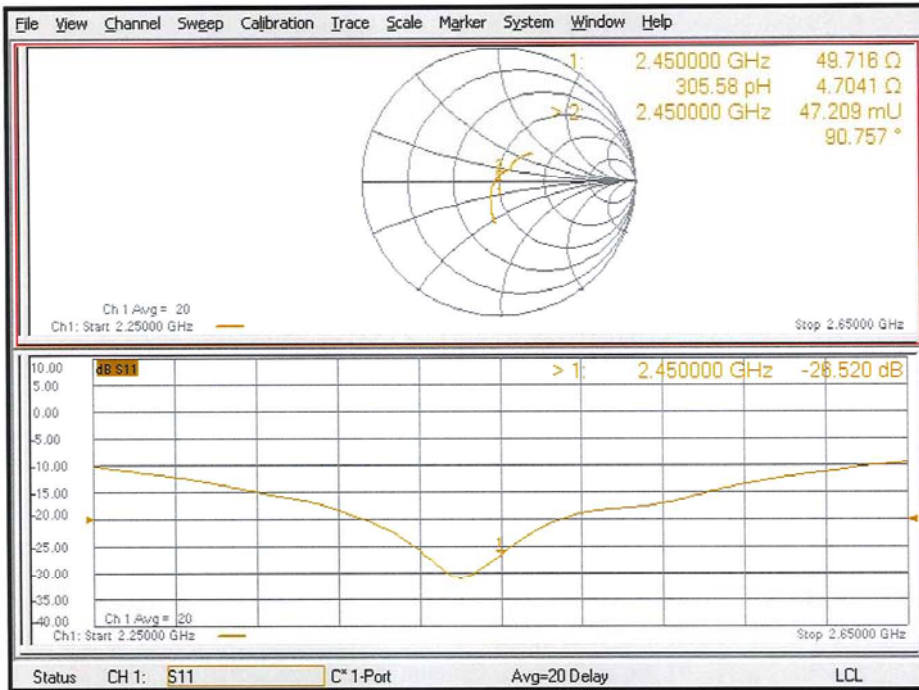

### D2450V2 Calibration for Impedance and Return-loss

Equipment	Dipole Antenna	Model	D2450V2
Manufacture	Schmid & Partner Engineering AG	Serial	713
Tested by	Hisayoshi Sato		

#### 1. Test environment

Date	August 1, 2023		
Ambient Temperature	22.5 deg.C	Relative humidity	40 %RH

#### 2. Equipment used

Local Id	LIMS ID	Description	Manufacturer	Model	Serial	Last Cal Date	Interval
MOS-33	88581	Thermo-Hygrometer	CUSTOM, Inc	CTH-201	-	2023/07/18	12
MPSAM-02	142060	SAM Phantom	Schmid & Partner Engineering AG	QD000P40CB	1333	2023/05/10	12
MPF-02	142056	2mm Oval Flat Phantom	Schmid & Partner Engineering AG	QDOVA001BB	1045	2023/05/10	12
MHBL600-10000	176484	Head Simulating Liquid	Schmid & Partner Engineering AG	HBBL600-10000V6	SL AAH U16 BC	-	-
MMBL600-6000	176483	Body Simulating Liquid	Schmid & Partner Engineering AG	MBBL600-6000	SL AAM U16 BC	-	-
EST-63	150815	Network Analyzer	Keysight Technologies Inc	E5071C	MY46523746	2022/08/23	12
EST-57	141991	2.4mm Calibration Kit	Keysight Technologies Inc	85056A	MY44300225	2022/08/18	12

#### 3. Test Result

Impedance, Transformed to feed point	cal day	Head (real part) [Ω]	Head (img part) [jΩ]	Deviation (real part) [Ω]	Deviation (img part) [jΩ]	Tolerance	Result
Calibration (SPEAG)	2022/9/12	53.03	1.87	-	-	-	-
Calibration(ULJ)	2023/8/1	50.87	3.23	-2.17	1.36	+/- 5 Ω +/- 5 jΩ	Complied

Return loss	cal day	Head [dB]	Deviation [%]	Deviation [dB]	Tolerance [%]	Tolerance [+/- dB]	Result
Calibration (SPEAG)	2022/9/12	-29.22	-	-	-	-	-
Calibration(ULJ)	2023/8/1	-29.58	-1.25	-0.37	+/- 20.00	5.84	Complied

Impedance, Transformed to feed point	cal day	Body (real part) [Ω]	Body (img part) [jΩ]	Deviation (real part) [Ω]	Deviation (img part) [jΩ]	Tolerance	Result
Calibration (SPEAG)	2022/9/12	49.72	4.70	-	-	-	-
Calibration(ULJ)	2023/8/1	48.03	4.17	-1.69	-0.54	+/- 5 Ω +/- 5 jΩ	Complied

Return loss	cal day	Body [dB]	Deviation [%]	Deviation [dB]	Tolerance [%]	Tolerance [+/- dB]	Result
Calibration (SPEAG)	2022/9/12	-26.52	-	-	-	-	-
Calibration(ULJ)	2023/8/1	-26.62	-0.38	-0.10	+/- 20.00	5.30	Complied

Tolerance: According to the KDB 865664 D1

## Measurement Plots

### <Head Liquid>

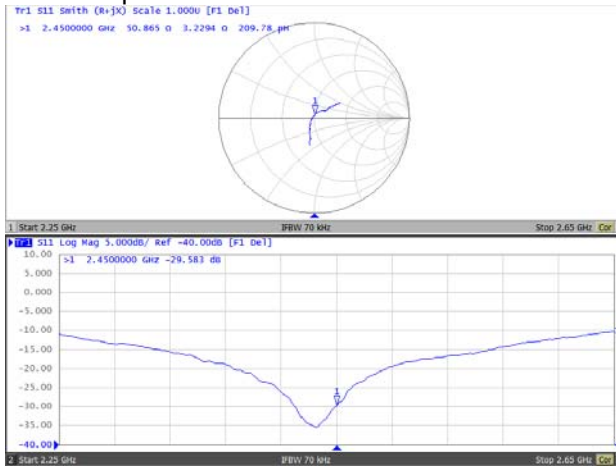

### <Body Liquid>

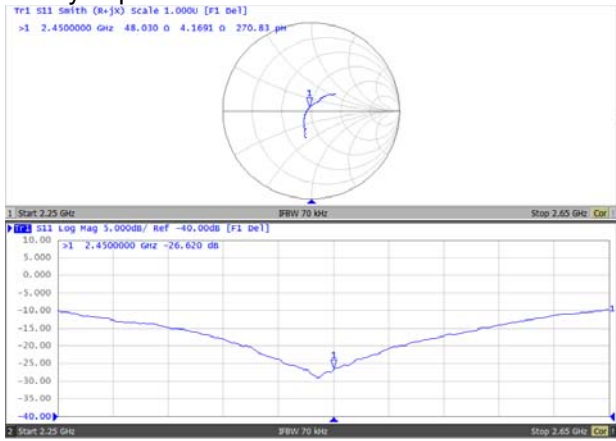



**System Check Dipole SAR Calibration Certificate -Dipole 5 GHz (D5GHzV2 S/N: 1020)**

**Calibration Laboratory of  
Schmid & Partner  
Engineering AG**  
Zeughausstrasse 43, 8004 Zurich, Switzerland



**S** Schweizerischer Kalibrierdienst  
**C** Service suisse d'étalonnage  
**S** Servizio svizzero di taratura  
**S** Swiss Calibration Service

Accreditation No.: **SCS 0108**

Accredited by the Swiss Accreditation Service (SAS)  
The Swiss Accreditation Service is one of the signatories to the EA  
Multilateral Agreement for the recognition of calibration certificates

Client **UL Japan Head Office**  
Ise, Japan

Certificate No. **D5GHzV2-1020\_Nov23**

**CALIBRATION CERTIFICATE**

Object **D5GHzV2 - SN:1020**

Calibration procedure(s) **QA CAL-22.v7  
Calibration Procedure for SAR Validation Sources between 3-10 GHz**

Calibration date: **November 15, 2023**

This calibration certificate documents the traceability to national standards, which realize the physical units of measurements (SI).  
The measurements and the uncertainties with confidence probability are given on the following pages and are part of the certificate.

All calibrations have been conducted in the closed laboratory facility: environment temperature (22 ± 3)°C and humidity < 70%.

Calibration Equipment used (M&TE critical for calibration)

Primary Standards	ID #	Cal Date (Certificate No.)	Scheduled Calibration
Power meter NRP2	SN: 104778	30-Mar-23 (No. 217-03804/03805)	Mar-24
Power sensor NRP-Z91	SN: 103244	30-Mar-23 (No. 217-03804)	Mar-24
Power sensor NRP-Z91	SN: 103245	30-Mar-23 (No. 217-03805)	Mar-24
Reference 20 dB Attenuator	SN: BH9394 (20k)	30-Mar-23 (No. 217-03809)	Mar-24
Type-N mismatch combination	SN: 310982 / 06327	30-Mar-23 (No. 217-03810)	Mar-24
Reference Probe EX3DV4	SN: 3503	07-Mar-23 (No. EX3-3503_Mar23)	Mar-24
DAE4	SN: 601	03-Oct-23 (No. DAE4-601_Oct23)	Oct-24
Secondary Standards	ID #	Check Date (in house)	Scheduled Check
Power meter E4419B	SN: GB39512475	30-Oct-14 (in house check Oct-22)	In house check: Oct-24
Power sensor HP 8481A	SN: US37292783	07-Oct-15 (in house check Oct-22)	In house check: Oct-24
Power sensor HP 8481A	SN: MY41093315	07-Oct-15 (in house check Oct-22)	In house check: Oct-24
RF generator R&S SMT-06	SN: 100972	15-Jun-15 (in house check Oct-22)	In house check: Oct-24
Network Analyzer Agilent E8358A	SN: US41080477	31-Mar-14 (in house check Oct-22)	In house check: Oct-24

Calibrated by:	Name <b>Paulo Pina</b>	Function Laboratory Technician	Signature 
Approved by:	Name <b>Sven Kühn</b>	Function Technical Manager	Signature 

Issued: November 16, 2023

This calibration certificate shall not be reproduced except in full without written approval of the laboratory.

**Calibration Laboratory of**  
Schmid & Partner  
Engineering AG  
Zeughausstrasse 43, 8004 Zurich, Switzerland



**S** Schweizerischer Kalibrierdienst  
**C** Service suisse d'étalonnage  
**S** Servizio svizzero di taratura  
**S** Swiss Calibration Service

Accredited by the Swiss Accreditation Service (SAS)  
The Swiss Accreditation Service is one of the signatories to the EA  
Multilateral Agreement for the recognition of calibration certificates

Accreditation No.: **SCS 0108**

**Glossary:**

TSL	tissue simulating liquid
ConvF	sensitivity in TSL / NORM x,y,z
N/A	not applicable or not measured

**Calibration is Performed According to the Following Standards:**

- IEC/IEEE 62209-1528, "Measurement Procedure For The Assessment Of Specific Absorption Rate Of Human Exposure To Radio Frequency Fields From Hand-Held And Body-Worn Wireless Communication Devices - Part 1528: Human Models, Instrumentation And Procedures (Frequency Range of 4 MHz to 10 GHz)", October 2020.
- KDB 865664, "SAR Measurement Requirements for 100 MHz to 6 GHz"

**Additional Documentation:**

- DASY System Handbook

**Methods Applied and Interpretation of Parameters:**

- Measurement Conditions:* Further details are available from the Validation Report at the end of the certificate. All figures stated in the certificate are valid at the frequency indicated.
- Antenna Parameters with TSL:* The source is mounted in a touch configuration below the center marking of the flat phantom.
- Return Loss:* This parameter is measured with the source positioned under the liquid filled phantom (as described in the measurement condition clause). The Return Loss ensures low reflected power. No uncertainty required.
- SAR measured:* SAR measured at the stated antenna input power.
- SAR normalized:* SAR as measured, normalized to an input power of 1 W at the antenna connector.
- SAR for nominal TSL parameters:* The measured TSL parameters are used to calculate the nominal SAR result.

The reported uncertainty of measurement is stated as the standard uncertainty of measurement multiplied by the coverage factor  $k=2$ , which for a normal distribution corresponds to a coverage probability of approximately 95%.

**Measurement Conditions**

DASY system configuration, as far as not given on page 1.

DASY Version	DASY52	V52.10.4
Extrapolation	Advanced Extrapolation	
Phantom	Modular Flat Phantom V5.0	
Distance Dipole Center - TSL	10 mm	with Spacer
Zoom Scan Resolution	dx, dy = 4.0 mm, dz = 1.4 mm	Graded Ratio = 1.4 (Z direction)
Frequency	5250 MHz ± 1 MHz 5600 MHz ± 1 MHz 5800 MHz ± 1 MHz 5850 MHz ± 1 MHz	

**Head TSL parameters at 5250 MHz**

The following parameters and calculations were applied.

	Temperature	Permittivity	Conductivity
Nominal Head TSL parameters	22.0 °C	35.9	4.71 mho/m
Measured Head TSL parameters	(22.0 ± 0.2) °C	36.5 ± 6 %	4.61 mho/m ± 6 %
Head TSL temperature change during test	< 0.5 °C	----	----

**SAR result with Head TSL at 5250 MHz**

SAR averaged over 1 cm <sup>3</sup> (1 g) of Head TSL	Condition	
SAR measured	100 mW input power	8.02 W/kg
SAR for nominal Head TSL parameters	normalized to 1W	<b>80.4 W/kg ± 19.9 % (k=2)</b>

SAR averaged over 10 cm <sup>3</sup> (10 g) of Head TSL	condition	
SAR measured	100 mW input power	2.30 W/kg
SAR for nominal Head TSL parameters	normalized to 1W	<b>23.1 W/kg ± 19.5 % (k=2)</b>

**Head TSL parameters at 5600 MHz**

The following parameters and calculations were applied.

	Temperature	Permittivity	Conductivity
Nominal Head TSL parameters	22.0 °C	35.5	5.07 mho/m
Measured Head TSL parameters	(22.0 ± 0.2) °C	36.1 ± 6 %	5.01 mho/m ± 6 %
Head TSL temperature change during test	< 0.5 °C	----	----

**SAR result with Head TSL at 5600 MHz**

SAR averaged over 1 cm <sup>3</sup> (1 g) of Head TSL	Condition	
SAR measured	100 mW input power	8.15 W/kg
SAR for nominal Head TSL parameters	normalized to 1W	<b>81.7 W/kg ± 19.9 % (k=2)</b>

SAR averaged over 10 cm <sup>3</sup> (10 g) of Head TSL	condition	
SAR measured	100 mW input power	2.33 W/kg
SAR for nominal Head TSL parameters	normalized to 1W	<b>23.4 W/kg ± 19.5 % (k=2)</b>

### Head TSL parameters at 5800 MHz

The following parameters and calculations were applied.

	Temperature	Permittivity	Conductivity
Nominal Head TSL parameters	22.0 °C	35.3	5.27 mho/m
Measured Head TSL parameters	(22.0 ± 0.2) °C	35.9 ± 6 %	5.20 mho/m ± 6 %
Head TSL temperature change during test	< 0.5 °C	----	----

### SAR result with Head TSL at 5800 MHz

SAR averaged over 1 cm <sup>3</sup> (1 g) of Head TSL	Condition	
SAR measured	100 mW input power	8.03 W/kg
SAR for nominal Head TSL parameters	normalized to 1W	<b>80.5 W/kg ± 19.9 % (k=2)</b>

SAR averaged over 10 cm <sup>3</sup> (10 g) of Head TSL	condition	
SAR measured	100 mW input power	2.25 W/kg
SAR for nominal Head TSL parameters	normalized to 1W	<b>22.6 W/kg ± 19.5 % (k=2)</b>

### Head TSL parameters at 5850 MHz

The following parameters and calculations were applied.

	Temperature	Permittivity	Conductivity
Nominal Head TSL parameters	22.0 °C	35.2	5.32 mho/m
Measured Head TSL parameters	(22.0 ± 0.2) °C	35.8 ± 6 %	5.25 mho/m ± 6 %
Head TSL temperature change during test	< 0.5 °C	----	----

### SAR result with Head TSL at 5850 MHz

SAR averaged over 1 cm <sup>3</sup> (1 g) of Head TSL	Condition	
SAR measured	100 mW input power	8.06 W/kg
SAR for nominal Head TSL parameters	normalized to 1W	<b>80.8 W/kg ± 19.9 % (k=2)</b>

SAR averaged over 10 cm <sup>3</sup> (10 g) of Head TSL	condition	
SAR measured	100 mW input power	2.29 W/kg
SAR for nominal Head TSL parameters	normalized to 1W	<b>23.0 W/kg ± 19.5 % (k=2)</b>

**Body TSL parameters at 5250 MHz**

The following parameters and calculations were applied.

	Temperature	Permittivity	Conductivity
Nominal Body TSL parameters	22.0 °C	48.9	5.36 mho/m
Measured Body TSL parameters	(22.0 ± 0.2) °C	50.1 ± 6 %	5.55 mho/m ± 6 %
Body TSL temperature change during test	< 0.5 °C	----	----

**SAR result with Body TSL at 5250 MHz**

SAR averaged over 1 cm <sup>3</sup> (1 g) of Body TSL	Condition	
SAR measured	100 mW input power	7.55 W/kg
SAR for nominal Body TSL parameters	normalized to 1W	75.9 W/kg ± 19.9 % (k=2)

SAR averaged over 10 cm <sup>3</sup> (10 g) of Body TSL	condition	
SAR measured	100 mW input power	2.11 W/kg
SAR for nominal Body TSL parameters	normalized to 1W	21.3 W/kg ± 19.5 % (k=2)

**Body TSL parameters at 5600 MHz**

The following parameters and calculations were applied.

	Temperature	Permittivity	Conductivity
Nominal Body TSL parameters	22.0 °C	48.5	5.77 mho/m
Measured Body TSL parameters	(22.0 ± 0.2) °C	49.7 ± 6 %	5.94 mho/m ± 6 %
Body TSL temperature change during test	< 0.5 °C	----	----

**SAR result with Body TSL at 5600 MHz**

SAR averaged over 1 cm <sup>3</sup> (1 g) of Body TSL	Condition	
SAR measured	100 mW input power	7.66 W/kg
SAR for nominal Body TSL parameters	normalized to 1W	77.1 W/kg ± 19.9 % (k=2)

SAR averaged over 10 cm <sup>3</sup> (10 g) of Body TSL	condition	
SAR measured	100 mW input power	2.14 W/kg
SAR for nominal Body TSL parameters	normalized to 1W	21.6 W/kg ± 19.5 % (k=2)

**Body TSL parameters at 5800 MHz**

The following parameters and calculations were applied.

	Temperature	Permittivity	Conductivity
Nominal Body TSL parameters	22.0 °C	48.2	6.00 mho/m
Measured Body TSL parameters	(22.0 ± 0.2) °C	49.1 ± 6 %	6.21 mho/m ± 6 %
Body TSL temperature change during test	< 0.5 °C	----	----

**SAR result with Body TSL at 5800 MHz**

SAR averaged over 1 cm <sup>3</sup> (1 g) of Body TSL	Condition	
SAR measured	100 mW input power	7.38 W/kg
SAR for nominal Body TSL parameters	normalized to 1W	74.2 W/kg ± 19.9 % (k=2)

SAR averaged over 10 cm <sup>3</sup> (10 g) of Body TSL	condition	
SAR measured	100 mW input power	2.03 W/kg
SAR for nominal Body TSL parameters	normalized to 1W	20.4 W/kg ± 19.5 % (k=2)

**Body TSL parameters at 5850 MHz**

The following parameters and calculations were applied.

	Temperature	Permittivity	Conductivity
Nominal Body TSL parameters	22.0 °C	48.1	6.06 mho/m
Measured Body TSL parameters	(22.0 ± 0.2) °C	48.9 ± 6 %	6.30 mho/m ± 6 %
Body TSL temperature change during test	< 0.5 °C	----	----

**SAR result with Body TSL at 5850 MHz**

SAR averaged over 1 cm <sup>3</sup> (1 g) of Body TSL	Condition	
SAR measured	100 mW input power	7.74 W/kg
SAR for nominal Body TSL parameters	normalized to 1W	77.8 W/kg ± 19.9 % (k=2)

SAR averaged over 10 cm <sup>3</sup> (10 g) of Body TSL	condition	
SAR measured	100 mW input power	2.14 W/kg
SAR for nominal Body TSL parameters	normalized to 1W	21.5 W/kg ± 19.5 % (k=2)

**Appendix (Additional assessments outside the scope of SCS 0108)**

**Antenna Parameters with Head TSL at 5250 MHz**

Impedance, transformed to feed point	49.2 $\Omega$ - 5.5 j $\Omega$
Return Loss	- 25.1 dB

**Antenna Parameters with Head TSL at 5600 MHz**

Impedance, transformed to feed point	52.7 $\Omega$ - 0.6 j $\Omega$
Return Loss	- 31.4 dB

**Antenna Parameters with Head TSL at 5800 MHz**

Impedance, transformed to feed point	55.2 $\Omega$ + 1.6 j $\Omega$
Return Loss	- 25.8 dB

**Antenna Parameters with Head TSL at 5850 MHz**

Impedance, transformed to feed point	56.4 $\Omega$ + 1.4 j $\Omega$
Return Loss	- 24.3 dB

**Antenna Parameters with Body TSL at 5250 MHz**

Impedance, transformed to feed point	49.7 $\Omega$ - 5.8 j $\Omega$
Return Loss	- 24.7 dB

**Antenna Parameters with Body TSL at 5600 MHz**

Impedance, transformed to feed point	55.6 $\Omega$ - 2.3 j $\Omega$
Return Loss	- 24.9 dB

**Antenna Parameters with Body TSL at 5800 MHz**

Impedance, transformed to feed point	57.7 $\Omega$ + 3.5 j $\Omega$
Return Loss	- 22.1 dB

**Antenna Parameters with Body TSL at 5850 MHz**

Impedance, transformed to feed point	57.0 $\Omega$ + 2.5 j $\Omega$
Return Loss	- 23.2 dB

**General Antenna Parameters and Design**

Electrical Delay (one direction)	1.200 ns
----------------------------------	----------

After long term use with 100W radiated power, only a slight warming of the dipole near the feedpoint can be measured.

The dipole is made of standard semirigid coaxial cable. The center conductor of the feeding line is directly connected to the second arm of the dipole. The antenna is therefore short-circuited for DC-signals. On some of the dipoles, small end caps are added to the dipole arms in order to improve matching when loaded according to the position as explained in the "Measurement Conditions" paragraph. The SAR data are not affected by this change. The overall dipole length is still according to the Standard.

No excessive force must be applied to the dipole arms, because they might bend or the soldered connections near the feedpoint may be damaged.

**Additional EUT Data**

Manufactured by	SPEAG
-----------------	-------



**DASY5 Validation Report for Head TSL**

Date: 10.11.2023

Test Laboratory: SPEAG, Zurich, Switzerland

**DUT: Dipole D5GHzV2; Type: D5GHzV2; Serial: D5GHzV2 - SN:1020**

Communication System: UID 0 - CW; Frequency: 5250 MHz, Frequency: 5600 MHz, Frequency: 5800 MHz, Frequency: 5850 MHz

Medium parameters used:  $f = 5250$  MHz;  $\sigma = 4.61$  S/m;  $\epsilon_r = 36.5$ ;  $\rho = 1000$  kg/m<sup>3</sup>

Medium parameters used:  $f = 5600$  MHz;  $\sigma = 5.01$  S/m;  $\epsilon_r = 36.1$ ;  $\rho = 1000$  kg/m<sup>3</sup>

Medium parameters used:  $f = 5800$  MHz;  $\sigma = 5.2$  S/m;  $\epsilon_r = 35.9$ ;  $\rho = 1000$  kg/m<sup>3</sup>

Medium parameters used:  $f = 5850$  MHz;  $\sigma = 5.25$  S/m;  $\epsilon_r = 35.8$ ;  $\rho = 1000$  kg/m<sup>3</sup>

Phantom section: Flat Section

Measurement Standard: DASY5 (IEEE/IEC/ANSI C63.19-2011)

DASY52 Configuration:

- Probe: EX3DV4 - SN3503; ConvF(5.5, 5.5, 5.5) @ 5250 MHz, ConvF(5.1, 5.1, 5.1) @ 5600 MHz, ConvF(5.01, 5.01, 5.01) @ 5800 MHz, ConvF(4.99, 4.99, 4.99) @ 5850 MHz; Calibrated: 07.03.2023
- Sensor-Surface: 1.4mm (Mechanical Surface Detection)
- Electronics: DAE4 Sn601; Calibrated: 03.10.2023
- Phantom: Flat Phantom 5.0 (front); Type: QD 000 P50 AA; Serial: 1001
- DASY52 52.10.4(1535); SEMCAD X 14.6.14(7501)

**Dipole Calibration for Head Tissue/Pin=100mW, dist=10mm, f=5250 MHz/Zoom Scan,**

**dist=1.4mm (8x8x7)/Cube 0:** Measurement grid: dx=4mm, dy=4mm, dz=1.4mm

Reference Value = 74.47 V/m; Power Drift = 0.08 dB

Peak SAR (extrapolated) = 27.1 W/kg

**SAR(1 g) = 8.02 W/kg; SAR(10 g) = 2.30 W/kg**

Smallest distance from peaks to all points 3 dB below = 7.2 mm

Ratio of SAR at M2 to SAR at M1 = 70.7%

Maximum value of SAR (measured) = 18.2 W/kg

**Dipole Calibration for Head Tissue/Pin=100mW, dist=10mm, f=5600 MHz/Zoom Scan,**

**dist=1.4mm (8x8x7)/Cube 0:** Measurement grid: dx=4mm, dy=4mm, dz=1.4mm

Reference Value = 75.05 V/m; Power Drift = 0.01 dB

Peak SAR (extrapolated) = 29.9 W/kg

**SAR(1 g) = 8.15 W/kg; SAR(10 g) = 2.33 W/kg**

Smallest distance from peaks to all points 3 dB below = 7.2 mm

Ratio of SAR at M2 to SAR at M1 = 68%

Maximum value of SAR (measured) = 19.0 W/kg

**Dipole Calibration for Head Tissue/Pin=100mW, dist=10mm, f=5800 MHz/Zoom Scan,**

**dist=1.4mm (8x8x7)/Cube 0:** Measurement grid: dx=4mm, dy=4mm, dz=1.4mm

Reference Value = 72.84 V/m; Power Drift = -0.00 dB

Peak SAR (extrapolated) = 31.8 W/kg

**SAR(1 g) = 8.03 W/kg; SAR(10 g) = 2.25 W/kg**

Smallest distance from peaks to all points 3 dB below = 7.2 mm

Ratio of SAR at M2 to SAR at M1 = 65.7%

Maximum value of SAR (measured) = 19.2 W/kg

**Dipole Calibration for Head Tissue/Pin=100mW, dist=10mm, f=5850 MHz/Zoom Scan,**

**dist=1.4mm (8x8x7)/Cube 0:** Measurement grid: dx=4mm, dy=4mm, dz=1.4mm

Reference Value = 73.08 V/m; Power Drift = -0.01 dB

Peak SAR (extrapolated) = 32.0 W/kg

**SAR(1 g) = 8.06 W/kg; SAR(10 g) = 2.29 W/kg**

Smallest distance from peaks to all points 3 dB below = 7.2 mm

Ratio of SAR at M2 to SAR at M1 = 64.8%

Maximum value of SAR (measured) = 19.2 W/kg

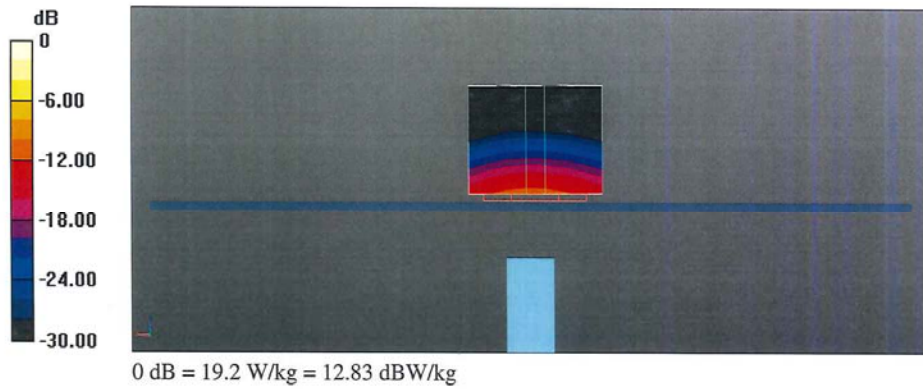

Impedance Measurement Plot for Head TSL

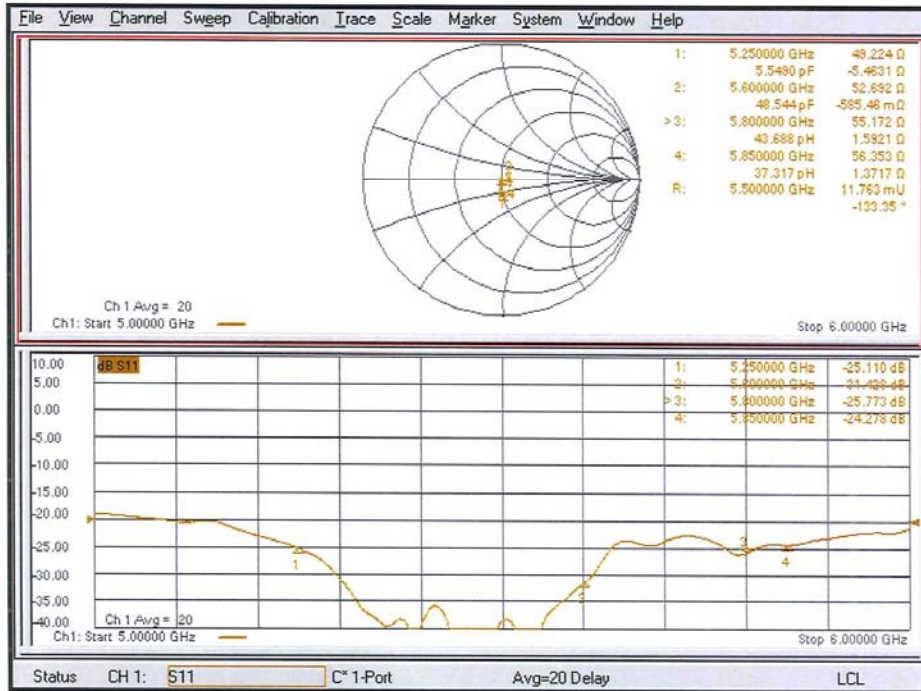

**DASY5 Validation Report for Body TSL**

Date: 15.11.2023

Test Laboratory: SPEAG, Zurich, Switzerland

**DUT: Dipole D5GHzV2; Type: D5GHzV2; Serial: D5GHzV2 - SN:1020**

Communication System: UID 0 - CW; Frequency: 5250 MHz, Frequency: 5600 MHz, Frequency: 5800 MHz, Frequency: 5850 MHz

Medium parameters used:  $f = 5250$  MHz;  $\sigma = 5.55$  S/m;  $\epsilon_r = 50.1$ ;  $\rho = 1000$  kg/m<sup>3</sup>

Medium parameters used:  $f = 5600$  MHz;  $\sigma = 5.94$  S/m;  $\epsilon_r = 49.7$ ;  $\rho = 1000$  kg/m<sup>3</sup>

Medium parameters used:  $f = 5800$  MHz;  $\sigma = 6.21$  S/m;  $\epsilon_r = 49.1$ ;  $\rho = 1000$  kg/m<sup>3</sup>

Medium parameters used:  $f = 5850$  MHz;  $\sigma = 6.3$  S/m;  $\epsilon_r = 48.9$ ;  $\rho = 1000$  kg/m<sup>3</sup>

Phantom section: Flat Section

Measurement Standard: DASY5 (IEEE/IEC/ANSI C63.19-2011)

DASY52 Configuration:

- Probe: EX3DV4 - SN3503; ConvF(5.26, 5.26, 5.26) @ 5250 MHz, ConvF(4.79, 4.79, 4.79) @ 5600 MHz, ConvF(4.62, 4.62, 4.62) @ 5800 MHz, ConvF(4.61, 4.61, 4.61) @ 5850 MHz; Calibrated: 07.03.2023
- Sensor-Surface: 1.4mm (Mechanical Surface Detection)
- Electronics: DAE4 Sn601; Calibrated: 03.10.2023
- Phantom: Flat Phantom 5.0 (back); Type: QD 000 P50 AA; Serial: 1002
- DASY52 52.10.4(1535); SEMCAD X 14.6.14(7501)

**Dipole Calibration for Body Tissue/Pin=100mW, dist=10mm, f=5250 MHz/Zoom Scan, dist=1.4mm (8x8x7)/Cube 0:**

Measurement grid:  $dx=4$ mm,  $dy=4$ mm,  $dz=1.4$ mm

Reference Value = 65.52 V/m; Power Drift = -0.08 dB

Peak SAR (extrapolated) = 28.5 W/kg

**SAR(1 g) = 7.55 W/kg; SAR(10 g) = 2.11 W/kg**

Smallest distance from peaks to all points 3 dB below = 7.2 mm

Ratio of SAR at M2 to SAR at M1 = 67.4%

Maximum value of SAR (measured) = 17.7 W/kg

**Dipole Calibration for Body Tissue/Pin=100mW, dist=10mm, f=5600 MHz/Zoom Scan, dist=1.4mm (8x8x7)/Cube 0:**

Measurement grid:  $dx=4$ mm,  $dy=4$ mm,  $dz=1.4$ mm

Reference Value = 66.33 V/m; Power Drift = -0.09 dB

Peak SAR (extrapolated) = 31.6 W/kg

**SAR(1 g) = 7.66 W/kg; SAR(10 g) = 2.14 W/kg**

Smallest distance from peaks to all points 3 dB below = 7.2 mm

Ratio of SAR at M2 to SAR at M1 = 64.4%

Maximum value of SAR (measured) = 18.5 W/kg

**Dipole Calibration for Body Tissue/Pin=100mW, dist=10mm, f=5800 MHz/Zoom Scan,**

**dist=1.4mm (8x8x7)/Cube 0:** Measurement grid: dx=4mm, dy=4mm, dz=1.4mm

Reference Value = 64.47 V/m; Power Drift = -0.09 dB

Peak SAR (extrapolated) = 31.3 W/kg

**SAR(1 g) = 7.38 W/kg; SAR(10 g) = 2.03 W/kg**

Smallest distance from peaks to all points 3 dB below = 7.2 mm

Ratio of SAR at M2 to SAR at M1 = 63.7%

Maximum value of SAR (measured) = 18.3 W/kg

**Dipole Calibration for Body Tissue/Pin=100mW, dist=10mm, f=5850 MHz/Zoom Scan,**

**dist=1.4mm (8x8x7)/Cube 0:** Measurement grid: dx=4mm, dy=4mm, dz=1.4mm

Reference Value = 64.22 V/m; Power Drift = -0.07 dB

Peak SAR (extrapolated) = 33.9 W/kg

**SAR(1 g) = 7.74 W/kg; SAR(10 g) = 2.14 W/kg**

Smallest distance from peaks to all points 3 dB below = 7.2 mm

Ratio of SAR at M2 to SAR at M1 = 62.7%

Maximum value of SAR (measured) = 19.1 W/kg

