

# **Venus 4 (DX-A400) DVT1 antenna report**

# Venus Sample

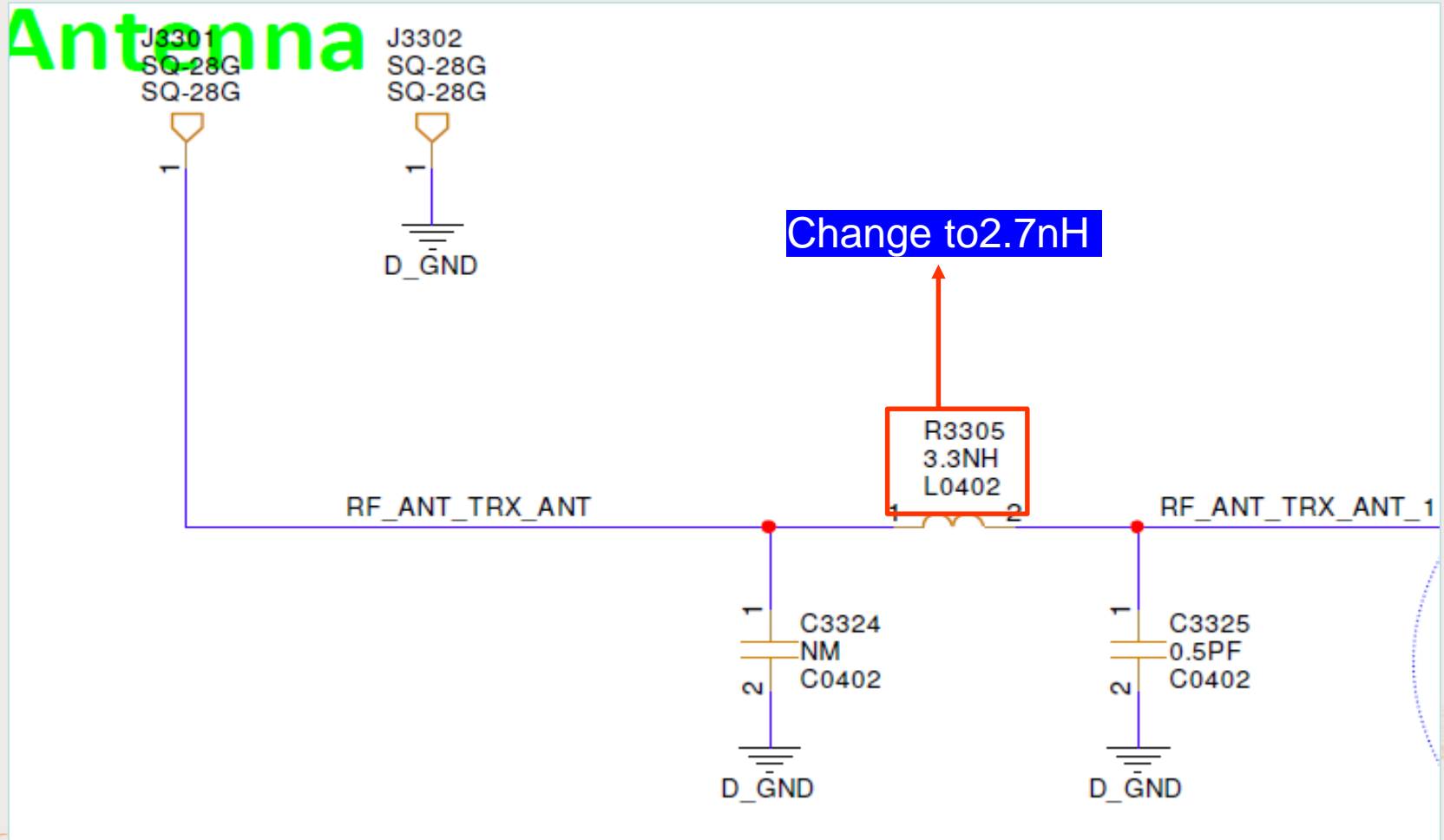

# Main antenna(fine tune)



# Radiation Pattern\_ 2D(main)

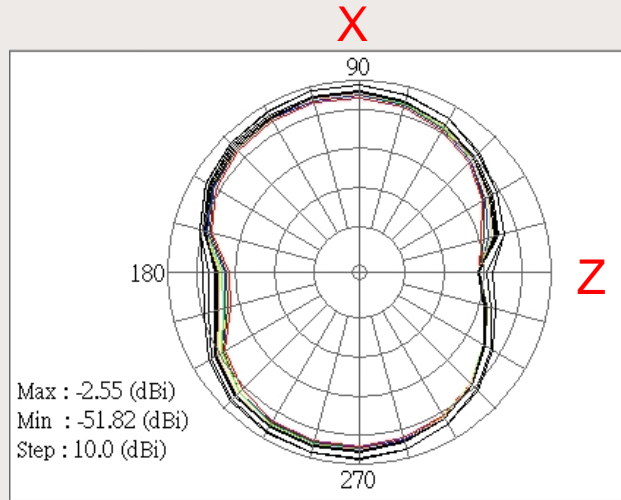

E1 plane

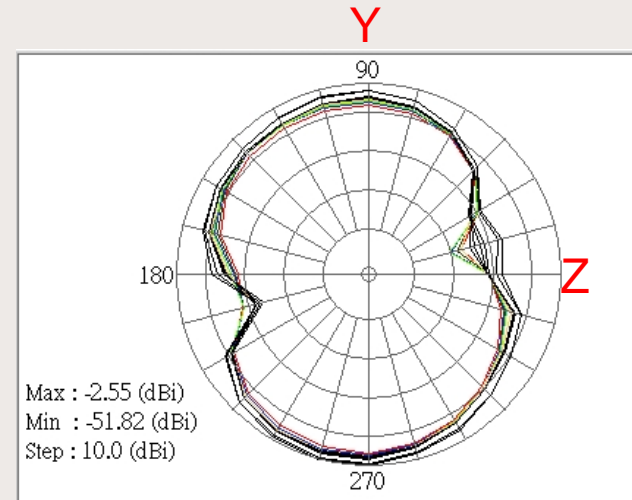

E2 plane

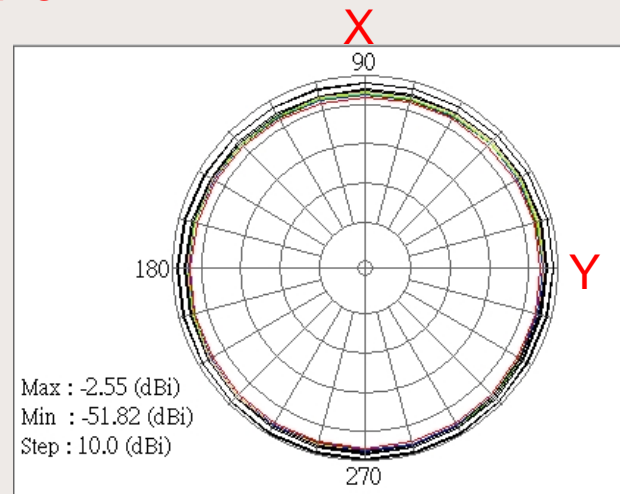

H plane

# 3D Gain of free space(Main)

	Frequency	Peak Gain
LTE main antenna	815 ~ 960 MHz	-2.89
	1710 ~ 2167 MHz	1.86
	2300 ~ 2690 MHz	1.99

# Radiation Pattern\_ 2D(BT/WIFI)

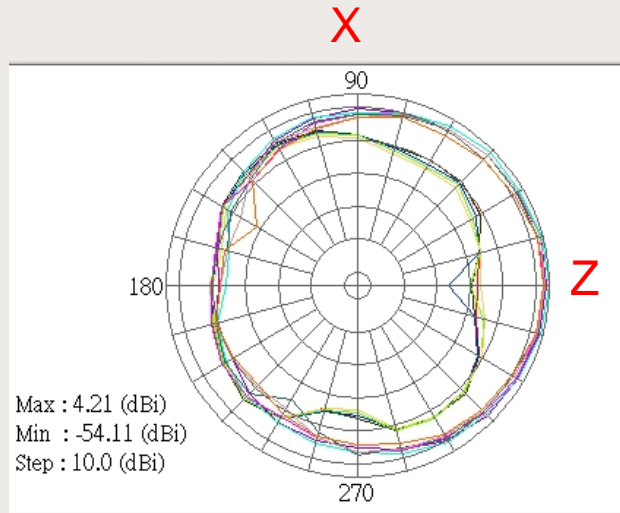

E1 plane

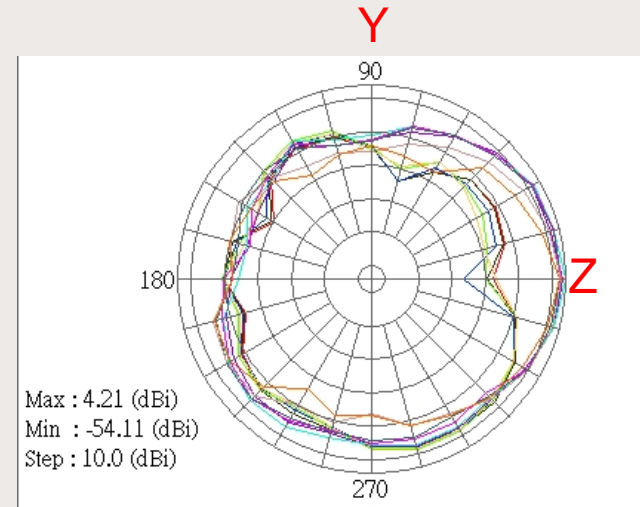

E2 plane

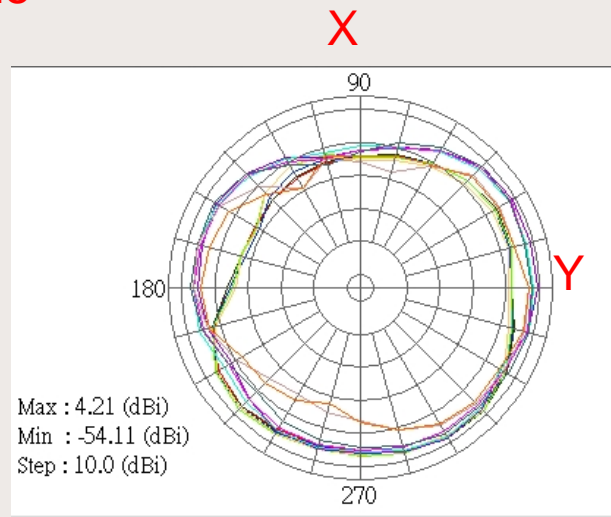

H plane

# 3D Gain of free space(WIFI/BT)

	Frequency	Peak Gain
WIFI/BT 2.4GHz	2402 ~ 2482 MHz	-0.23
WIFI 5GHz	5050 ~ 5835 MHz	4.81