

# FCC C2PC Test Report

**FCC ID** : RF41539C  
**Equipment** : Handheld Terminal  
**Model No.** : DX-A400  
**Brand Name** : KEYENCE  
**Applicant** : KEYENCE CORPORATION  
**Address** : 1-3-14 HIGASHI-NAKAJIMA,  
HIGASHI-YODOGAWA-KU, OSAKA, JAPAN  
**Standard** : 47 CFR FCC Part 15.247  
**Received Date** : Jul. 06, 2023  
**Tested Date** : Jul. 15 ~ Jul. 18, 2023

We, International Certification Corporation, would like to declare that the tested sample has been evaluated and in compliance with the requirement of the above standards. The test results contained in this report refer exclusively to the product. It shall not be reproduced except in full without the written approval of our laboratory.

Reviewed by:

Approved by:

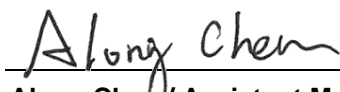

Along Chen / Assistant Manager

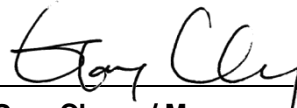

Gary Chang / Manager

---

## Table of Contents

<b>1</b>	<b>GENERAL DESCRIPTION .....</b>	<b>5</b>
1.1	Information.....	5
1.2	Local Support Equipment List .....	7
1.3	Test Setup Chart .....	7
1.4	Test Equipment List and Calibration Data.....	8
1.5	Test Standards .....	9
1.6	Reference Guidance .....	9
1.7	Deviation from Test Standard and Measurement Procedure.....	9
1.8	Measurement Uncertainty .....	9
<b>2</b>	<b>TEST CONFIGURATION.....</b>	<b>10</b>
2.1	Testing Facility .....	10
2.2	The Worst Test Modes and Channel Details .....	10
<b>3</b>	<b>TRANSMITTER TEST RESULTS .....</b>	<b>11</b>
3.1	Conducted Emissions.....	11
3.2	Emissions in Restricted Frequency Bands.....	14
<b>4</b>	<b>TEST LABORATORY INFORMATION .....</b>	<b>18</b>

---

## Release Record

Report No.	Version	Description	Issued Date
FR162103-02AE	Rev. 01	Initial issue	Aug. 10, 2023

## Summary of Test Results

FCC Rules	Test Items	Measured	Result
15.207	AC Power Line Conducted Emissions	[dBuV]: 0.589MHz 37.21 (Margin -18.79dB) - QP	Pass
15.247(d) 15.209	Radiated Emissions	[dBuV/m at 3m]: 50.37MHz 21.69 (Margin -18.31dB) - PK	Pass

### Declaration of Conformity:

The test results with all measurement uncertainty excluded are presented in accordance with the regulation limits or requirements declared by manufacturers.

### Comments and Explanations:

The declared of product specification for EUT presented in the report are provided by the manufacturer, and the manufacturer takes all the responsibilities for the accuracy of product specification.

# 1 General Description

## 1.1 Information

This is a Class II Permissive Change report (C2PC).

This report is issued as a supplementary report to original ICC report no. FR162103AE. The difference is changing components of LPDDR & eMMC.

### 1.1.1 Specification of the Equipment under Test (EUT)

RF General Information				
Frequency Range (MHz)	Bluetooth Mode	Ch. Freq. (MHz)	Channel Number	Data Rate
2400-2483.5	V5.0 LE	2402-2480	0-39 [40]	125 kbps
				500 kbps
				1 Mbps
				2 Mbps
Note: Bluetooth LE (Low energy) uses GFSK modulation.				

### 1.1.2 Antenna Details

Ant. No.	Type	Connector	Gain (dBi)	Remarks
1	PIFA	No	-0.23	---

### 1.1.3 Power Supply Type of Equipment under Test (EUT)

<b>Power Supply Type</b>	3.8Vdc
--------------------------	--------

### 1.1.4 Accessories

Accessories		
No.	Equipment	Description
1	Battery	Brand: KEYENCE Model: DX-BQ3 Rating: 3.8Vdc (11.51Wh) 3030mAh

### 1.1.5 Channel List

Frequency band (MHz)				2400~2483.5			
Channel	Frequency (MHz)	Channel	Frequency (MHz)	Channel	Frequency (MHz)	Channel	Frequency (MHz)
37	2402	9	2422	18	2442	28	2462
0	2404	10	2424	19	2444	29	2464
1	2406	38	2426	20	2446	30	2466
2	2408	11	2428	21	2448	31	2468
3	2410	12	2430	22	2450	32	2470
4	2412	13	2432	23	2452	33	2472
5	2414	14	2434	24	2454	34	2474
6	2416	15	2436	25	2456	35	2476
7	2418	16	2438	26	2458	36	2478
8	2420	17	2440	27	2460	39	2480

## 1.2 Local Support Equipment List

Support Equipment List					
No.	Equipment	Brand	Model	FCC ID	Remarks
1	Adapter	PHIHONG	PSA10F-050Q	---	Provided by applicant. Input: 100-240V~ 50/60Hz, 0.35A Output: 5.0V=2.0A, 10.0W

Note: Adapter is used for charging only.

## 1.3 Test Setup Chart

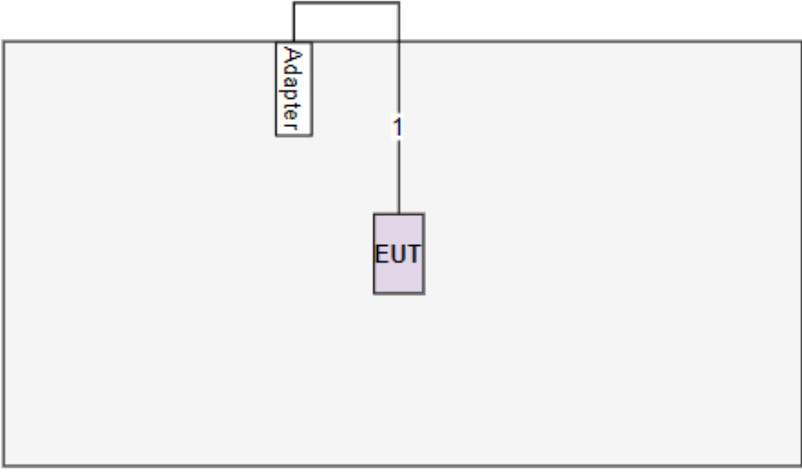
Test Setup Diagram	
	
No.	Signal cable / Length (m)
1	USB, 1m shielded. (Provided by applicant.)

## 1.4 Test Equipment List and Calibration Data

Test Item	Conducted Emission				
Test Site	Conduction room 1 / (CO01-WS)				
Tested Date	Jul. 18, 2023				
Instrument	Brand	Model No.	Serial No.	Calibration Date	Calibration Until
Receiver	R&S	ESR3	101658	Feb. 17, 2023	Feb. 16, 2024
LISN	R&S	ENV216	101579	May 09, 2023	May 08, 2024
LISN (Support Unit)	SCHWARZBECK	Schwarzbeck 8127	8127667	Jan .03, 2023	Jan .02, 2024
RF Cable-CON	Woken	CFD200-NL	CFD200-NL-001	Oct. 17, 2022	Oct. 16, 2023
50 ohm terminal (Support Unit)	NA	50	01	Jun. 14, 2023	Jun. 13, 2024
Measurement Software	AUDIX	e3	6.120210k	NA	NA

Note: Calibration Interval of instruments listed above is one year.

Test Item	Radiated Emission				
Test Site	966 chamber1 / (03CH01-WS)				
Tested Date	Jul. 15, 2023				
Instrument	Brand	Model No.	Serial No.	Calibration Date	Calibration Until
Receiver	R&S	ESR3	101657	Mar. 03, 2023	Mar. 02, 2024
Loop Antenna	R&S	HFH2-Z2	100330	Nov. 01, 2022	Oct. 31, 2023
Bilog Antenna	SCHWARZBECK	VULB9168	VULB9168-522	Aug. 03, 2022	Aug. 02, 2023
Preamplifier	EMC	EMC02325	980225	Jun. 28, 2023	Jun. 27, 2024
Loop Antenna Cable	KOAX KABEL	101354-BW	101354-BW	Oct. 04, 2022	Oct. 03, 2023
LF cable 3M	Woken	CFD400NL-LW	CFD400NL-001	Oct. 04, 2022	Oct. 03, 2023
LF cable 11M	EMC	EMCCFD400-NW-N W-11000	200801	Oct. 04, 2022	Oct. 03, 2023
LF cable 1M	EMC	EMCCFD400-NM-N M-1000	160502	Oct. 04, 2022	Oct. 03, 2023
Measurement Software	AUDIX	e3	6.120210g	NA	NA

Note: Calibration Interval of instruments listed above is one year.



## 1.5 Test Standards

47 CFR FCC Part 15.247

ANSI C63.10-2013

## 1.6 Reference Guidance

FCC KDB 558074 D01 15.247 Meas Guidance v05r02

## 1.7 Deviation from Test Standard and Measurement Procedure

None

## 1.8 Measurement Uncertainty

The measurement uncertainties given below are based on a 95% confidence level (based on a coverage factor (k=2)).

Measurement Uncertainty	
Parameters	Uncertainty
AC conducted emission	±2.92 dB
Radiated emission ≤ 1GHz	±3.41 dB

## 2 Test Configuration

### 2.1 Testing Facility

<b>Test Laboratory</b>	International Certification Corporation
<b>Test Site</b>	CO01-WS, 03CH01-WS
<b>Address of Test Site</b>	No.3-1, Lane 6, Wen San 3rd St., Kwei Shan Dist., Tao Yuan City 33381, Taiwan (R.O.C.)

- FCC Designation No.: TW2732
- FCC site registration No.: 181692
- ISED#: 10807A
- CAB identifier: TW2732

### 2.2 The Worst Test Modes and Channel Details

Test item	Mode	Test Frequency (MHz)	Test Configuration
AC Power Line Conducted Emissions Radiated Emissions ≤ 1GHz	BT LE	2440	---

**NOTE:**

1. The EUT was pretested with 3 orientations placed on the table for the radiated emission measurement – X, Y, and Z-plane. The **X-plane** results were found as the worst case and were shown in this report.

## 3 Transmitter Test Results

### 3.1 Conducted Emissions

#### 3.1.1 Limit of Conducted Emissions

Conducted Emissions Limit		
Frequency Emission (MHz)	Quasi-Peak	Average
0.15-0.5	66 - 56 *	56 - 46 *
0.5-5	56	46
5-30	60	50

Note 1: \* Decreases with the logarithm of the frequency.

#### 3.1.2 Test Procedures

1. The device is placed on a test table, raised 80 cm above the reference ground plane. The vertical conducting plane is located 40 cm to the rear of the device.
2. The device is connected to line impedance stabilization network (LISN) and other accessories are connected to other LISN. Measured levels of AC power line conducted emission are across the 50  $\Omega$  LISN port.
3. AC conducted emission measurements is made over frequency range from 150 kHz to 30 MHz.
4. This measurement was performed with AC 120V/60Hz

#### 3.1.3 Test Setup



- Note: 1. Support units were connected to second LISN.  
 2. Both of LISNs (AMN) are 80 cm from EUT and at least 80 cm from other units and other metal planes

### 3.1.4 Test Result of Conducted Emissions

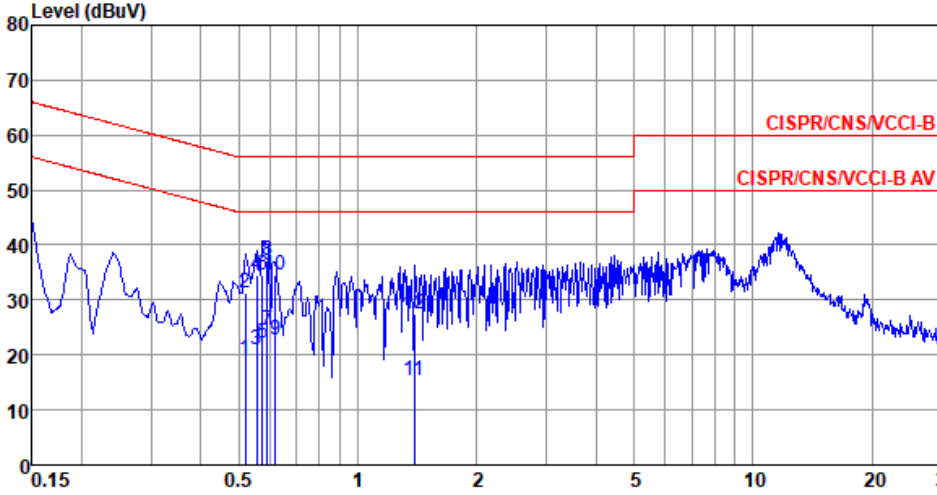
<b>Modulation</b>	BT LE-1Mbps	<b>Test Freq. (MHz)</b>	2440																																																																																																																																		
<b>Power Phase</b>	Line																																																																																																																																				
<p>Test by : Joe Liao      Temperature: 23°C      Humidity: 63%</p>																																																																																																																																					
																																																																																																																																					
<table border="1"> <thead> <tr> <th></th> <th>Freq MHz</th> <th>Level dBuV</th> <th>Limit Line dBuV</th> <th>Over Limit dB</th> <th>Read Level dBuV</th> <th>Factor dB</th> <th>Cable loss dB</th> <th>Aux dB</th> <th>Remark</th> </tr> </thead> <tbody> <tr><td>1</td><td>0.518</td><td>19.26</td><td>46.00</td><td>-26.74</td><td>9.26</td><td>9.62</td><td>0.07</td><td>0.31</td><td>Average</td></tr> <tr><td>2</td><td>0.518</td><td>31.18</td><td>56.00</td><td>-24.82</td><td>21.18</td><td>9.62</td><td>0.07</td><td>0.31</td><td>QP</td></tr> <tr><td>3</td><td>0.555</td><td>21.00</td><td>46.00</td><td>-25.00</td><td>10.99</td><td>9.62</td><td>0.08</td><td>0.31</td><td>Average</td></tr> <tr><td>4</td><td>0.555</td><td>34.59</td><td>56.00</td><td>-21.41</td><td>24.58</td><td>9.62</td><td>0.08</td><td>0.31</td><td>QP</td></tr> <tr><td>5</td><td>0.573</td><td>22.19</td><td>46.00</td><td>-23.81</td><td>12.18</td><td>9.62</td><td>0.08</td><td>0.31</td><td>Average</td></tr> <tr><td>6</td><td>0.573</td><td>34.54</td><td>56.00</td><td>-21.46</td><td>24.53</td><td>9.62</td><td>0.08</td><td>0.31</td><td>QP</td></tr> <tr><td>7</td><td>0.589</td><td>24.36</td><td>46.00</td><td>-21.64</td><td>14.35</td><td>9.62</td><td>0.08</td><td>0.31</td><td>Average</td></tr> <tr><td>8*</td><td>0.589</td><td>37.21</td><td>56.00</td><td>-18.79</td><td>27.20</td><td>9.62</td><td>0.08</td><td>0.31</td><td>QP</td></tr> <tr><td>9</td><td>0.617</td><td>22.59</td><td>46.00</td><td>-23.41</td><td>12.58</td><td>9.62</td><td>0.08</td><td>0.31</td><td>Average</td></tr> <tr><td>10</td><td>0.617</td><td>34.65</td><td>56.00</td><td>-21.35</td><td>24.64</td><td>9.62</td><td>0.08</td><td>0.31</td><td>QP</td></tr> <tr><td>11</td><td>1.388</td><td>15.42</td><td>46.00</td><td>-30.58</td><td>5.33</td><td>9.63</td><td>0.12</td><td>0.34</td><td>Average</td></tr> <tr><td>12</td><td>1.388</td><td>27.39</td><td>56.00</td><td>-28.61</td><td>17.30</td><td>9.63</td><td>0.12</td><td>0.34</td><td>QP</td></tr> </tbody> </table>					Freq MHz	Level dBuV	Limit Line dBuV	Over Limit dB	Read Level dBuV	Factor dB	Cable loss dB	Aux dB	Remark	1	0.518	19.26	46.00	-26.74	9.26	9.62	0.07	0.31	Average	2	0.518	31.18	56.00	-24.82	21.18	9.62	0.07	0.31	QP	3	0.555	21.00	46.00	-25.00	10.99	9.62	0.08	0.31	Average	4	0.555	34.59	56.00	-21.41	24.58	9.62	0.08	0.31	QP	5	0.573	22.19	46.00	-23.81	12.18	9.62	0.08	0.31	Average	6	0.573	34.54	56.00	-21.46	24.53	9.62	0.08	0.31	QP	7	0.589	24.36	46.00	-21.64	14.35	9.62	0.08	0.31	Average	8*	0.589	37.21	56.00	-18.79	27.20	9.62	0.08	0.31	QP	9	0.617	22.59	46.00	-23.41	12.58	9.62	0.08	0.31	Average	10	0.617	34.65	56.00	-21.35	24.64	9.62	0.08	0.31	QP	11	1.388	15.42	46.00	-30.58	5.33	9.63	0.12	0.34	Average	12	1.388	27.39	56.00	-28.61	17.30	9.63	0.12	0.34	QP
	Freq MHz	Level dBuV	Limit Line dBuV	Over Limit dB	Read Level dBuV	Factor dB	Cable loss dB	Aux dB	Remark																																																																																																																												
1	0.518	19.26	46.00	-26.74	9.26	9.62	0.07	0.31	Average																																																																																																																												
2	0.518	31.18	56.00	-24.82	21.18	9.62	0.07	0.31	QP																																																																																																																												
3	0.555	21.00	46.00	-25.00	10.99	9.62	0.08	0.31	Average																																																																																																																												
4	0.555	34.59	56.00	-21.41	24.58	9.62	0.08	0.31	QP																																																																																																																												
5	0.573	22.19	46.00	-23.81	12.18	9.62	0.08	0.31	Average																																																																																																																												
6	0.573	34.54	56.00	-21.46	24.53	9.62	0.08	0.31	QP																																																																																																																												
7	0.589	24.36	46.00	-21.64	14.35	9.62	0.08	0.31	Average																																																																																																																												
8*	0.589	37.21	56.00	-18.79	27.20	9.62	0.08	0.31	QP																																																																																																																												
9	0.617	22.59	46.00	-23.41	12.58	9.62	0.08	0.31	Average																																																																																																																												
10	0.617	34.65	56.00	-21.35	24.64	9.62	0.08	0.31	QP																																																																																																																												
11	1.388	15.42	46.00	-30.58	5.33	9.63	0.12	0.34	Average																																																																																																																												
12	1.388	27.39	56.00	-28.61	17.30	9.63	0.12	0.34	QP																																																																																																																												
<p>Note 1: Level (dBuV) = Read Level (dBuV) + LISN Factor (dB) + Cable Loss (dB) + Aux (dB).            Note 2: Over Limit (dB) = Level (dBuV) – Limit Line (dBuV).</p>																																																																																																																																					

<b>Modulation</b>	BT LE-1Mbps	<b>Test Freq. (MHz)</b>	2440
<b>Power Phase</b>	Neutral		

Test by : Joe Liao      Temperature: 23°C      Humidity: 63%

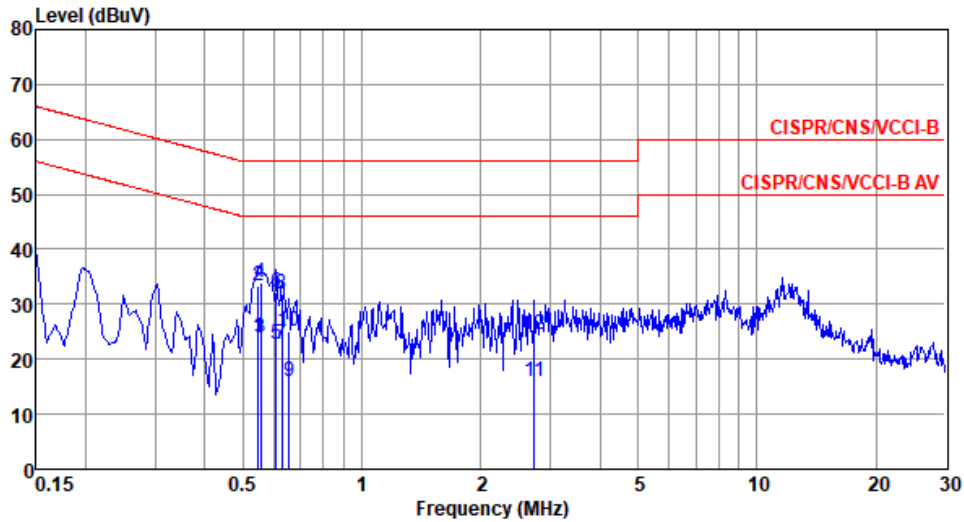

	Freq MHz	Level dBuV	Limit Line dBuV	Over Limit dB	Read Level dBuV	Factor dB	Cable loss dB	Aux dB	Remark
1	0.546	23.86	46.00	-22.14	13.85	9.62	0.08	0.31	Average
2	0.546	33.38	56.00	-22.62	23.37	9.62	0.08	0.31	QP
3*	0.555	23.95	46.00	-22.05	13.94	9.62	0.08	0.31	Average
4	0.555	33.80	56.00	-22.20	23.79	9.62	0.08	0.31	QP
5	0.608	22.72	46.00	-23.28	12.71	9.62	0.08	0.31	Average
6	0.608	32.09	56.00	-23.91	22.08	9.62	0.08	0.31	QP
7	0.627	22.76	46.00	-23.24	12.75	9.62	0.08	0.31	Average
8	0.627	31.79	56.00	-24.21	21.78	9.62	0.08	0.31	QP
9	0.654	15.93	46.00	-30.07	5.89	9.63	0.09	0.32	Average
10	0.654	24.95	56.00	-31.05	14.91	9.63	0.09	0.32	QP
11	2.736	15.89	46.00	-30.11	5.71	9.64	0.15	0.39	Average
12	2.736	24.53	56.00	-31.47	14.35	9.64	0.15	0.39	QP

Note 1: Level (dBuV) = Read Level (dBuV) + LISN Factor (dB) + Cable Loss (dB) + Aux (dB).  
 Note 2: Over Limit (dB) = Level (dBuV) – Limit Line (dBuV).

## 3.2 Emissions in Restricted Frequency Bands

### 3.2.1 Limit of Emissions in Restricted Frequency Bands

Restricted Band Emissions Limit			
Frequency Range (MHz)	Field Strength (uV/m)	Field Strength (dBuV/m)	Measure Distance (m)
0.009~0.490	2400/F(kHz)	48.5 - 13.8	300
0.490~1.705	24000/F(kHz)	33.8 - 23	30
1.705~30.0	30	29	30
30~88	100	40	3
88~216	150	43.5	3
216~960	200	46	3
Above 960	500	54	3

**Note 1:**  
Quasi-Peak value is measured for frequency below 1GHz except for 9–90 kHz, 110–490 kHz frequency band. Peak and average value are measured for frequency above 1GHz. The limit on average radio frequency emission is as above table. The limit on peak radio frequency emissions is 20 dB above the maximum permitted average emission limit

**Note 2:**  
Measurements may be performed at a distance other than what is specified provided. When performing measurements at a distance other than that specified, the results shall be extrapolated to the specified distance using an extrapolation factor as below, Frequency at or above 30 MHz: 20 dB/decade Frequency below 30 MHz: 40 dB/decade.

### 3.2.2 Test Procedures

1. Measurement is made at a semi-anechoic chamber that incorporates a turntable allowing a EUT rotation of 360°. A continuously-rotating, remotely-controlled turntable is installed at the test site to support the EUT and facilitate determination of the direction of maximum radiation for each EUT emission frequency. The EUT is placed at test table. For emissions testing at or below 1 GHz, the table height is 80 cm above the reference ground plane.
2. Measurement is made with the antenna positioned in both the horizontal and vertical planes of polarization. The measurement antenna is varied in height (1m ~ 4m) above the reference ground plane to obtain the maximum signal strength. Distance between EUT and antenna is 3 m.
3. This investigation is performed with the EUT rotated 360°, the antenna height scanned between 1 m and 4 m, and the antenna rotated to repeat the measurements for both the horizontal and vertical antenna polarizations.

Note:

1. 120kHz measurement bandwidth of test receiver and Quasi-peak detector is for radiated emission below 1GHz.

### 3.2.3 Test Setup

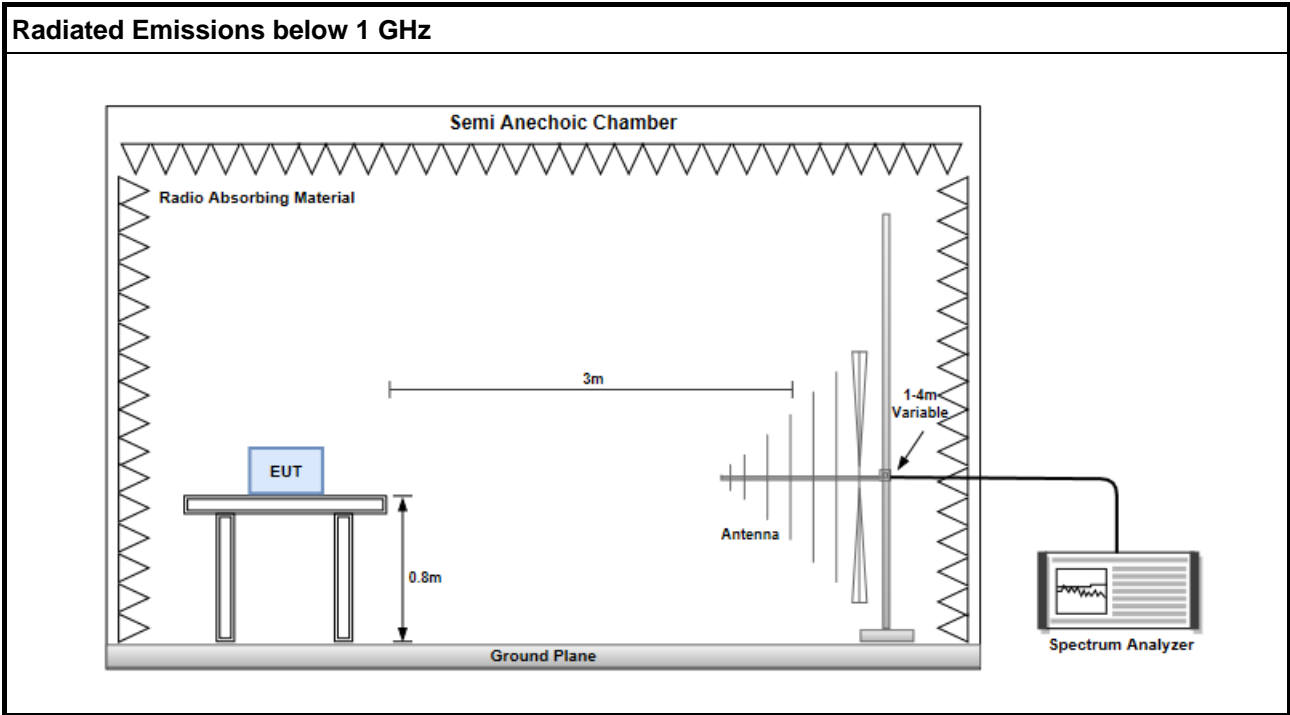

### 3.2.4 Transmitter Radiated Unwanted Emissions (Below 1GHz)

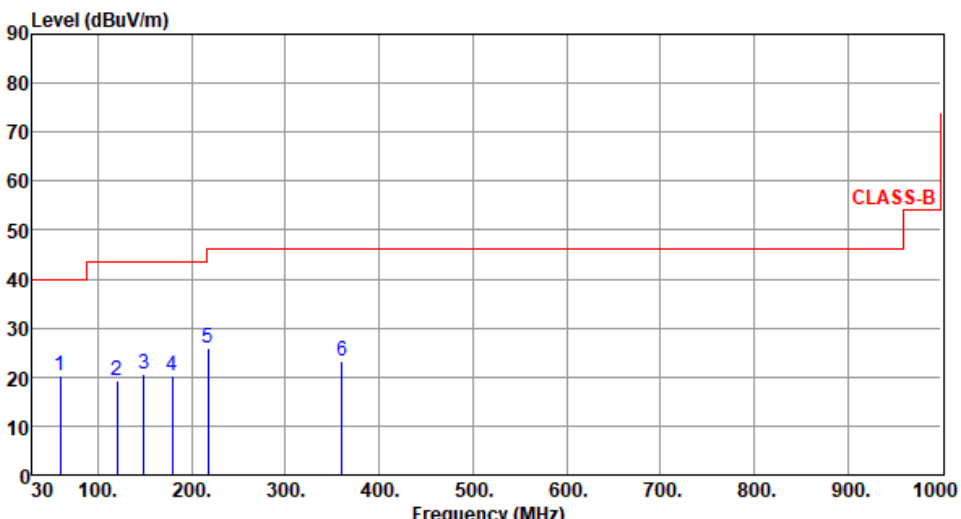
Modulation	BT-LE (1Mbps)	Test Freq. (MHz)	2440						
Polarization	Horizontal								
Test By : Sean Yu      Temperature(°C): 26      Humidity(%): 61									
									
	Freq. MHz	Emission level dBuV/m	Limit dBuV/m	Margin dB	SA reading dBuV	Factor dB/m	Remark	ANT High cm	Turn Table deg
1	60.07	20.34	40.00	-19.66	29.25	-8.91	Peak	---	---
2	120.21	19.33	43.50	-24.17	30.37	-11.04	Peak	---	---
3	149.31	20.68	43.50	-22.82	29.59	-8.91	Peak	---	---
4	179.38	20.21	43.50	-23.29	30.47	-10.26	Peak	---	---
5	217.21	25.77	46.00	-20.23	37.65	-11.88	Peak	---	---
6	360.77	23.16	46.00	-22.84	29.99	-6.83	Peak	---	---

Note 1: Emission Level (dBuV/m) = SA Reading (dBuV/m) + Factor\* (dB)  
\*Factor includes antenna factor , cable loss and amplifier gain  
Note 2: Margin (dB) = Emission level (dBuV/m) – Limit (dBuV/m).  
Note 3: All spurious emissions below 30MHz are more than 20 dB below the limit.



<b>Modulation</b>	BT-LE (1Mbps)	<b>Test Freq. (MHz)</b>	2440
<b>Polarization</b>	Vertical		

Test By : Sean Yu      Temperature(°C): 26      Humidity(%): 61

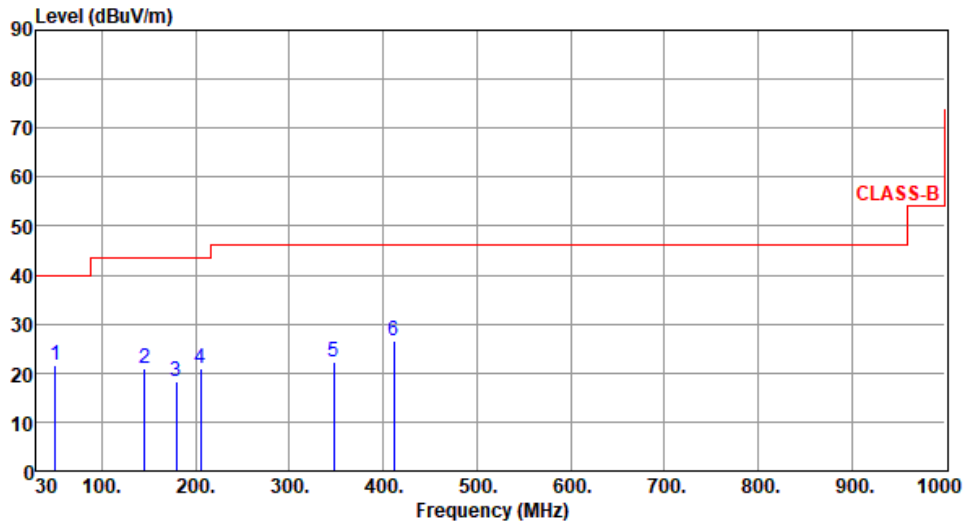

	Freq. MHz	Emission level dBuV/m	Limit dBuV/m	Margin dB	SA reading dBuV	Factor dB/m	Remark	ANT High cm	Turn Table deg
1	50.37	21.69	40.00	-18.31	29.94	-8.25	Peak	---	---
2	145.43	20.78	43.50	-22.72	29.83	-9.05	Peak	---	---
3	179.38	18.43	43.50	-25.07	28.69	-10.26	Peak	---	---
4	205.57	20.90	43.50	-22.60	32.80	-11.90	Peak	---	---
5	347.19	22.18	46.00	-23.82	29.29	-7.11	Peak	---	---
6	411.21	26.42	46.00	-19.58	31.69	-5.27	Peak	---	---

Note 1: Emission Level (dBuV/m) = SA Reading (dBuV/m) + Factor\* (dB)

\*Factor includes antenna factor , cable loss and amplifier gain

Note 2: Margin (dB) = Emission level (dBuV/m) – Limit (dBuV/m).

Note 3: All spurious emissions below 30MHz are more than 20 dB below the limit.

## 4 Test laboratory information

Established in 2012, ICC provides foremost EMC & RF Testing and advisory consultation services by our skilled engineers and technicians. Our services employ a wide variety of advanced edge test equipment and one of the widest certification extents in the business.

International Certification Corporation (EMC and Wireless Communication Laboratory), it is our definitive objective is to institute long term, trust-based associations with our clients. The expectation we set up with our clients is based on outstanding service, practical expertise and devotion to a certified value structure. Our passion is to grant our clients with best EMC / RF services by oriented knowledgeable and accommodating staff.

Our Test sites are located at Linkou District and Kwei Shan District. Location map can be found on our website <http://www.icertifi.com.tw>.

### **Linkou**

Tel: 886-2-2601-1640

No.30-2, Ding Fwu Tsuen, Lin Kou  
District, New Taipei City, Taiwan  
(R.O.C.)

### **Kwei Shan**

Tel: 886-3-271-8666

No.3-1, Lane 6, Wen San 3rd  
St., Kwei Shan Dist., Tao Yuan  
City 33381, Taiwan (R.O.C.)  
No.2-1, Lane 6, Wen San 3rd  
St., Kwei Shan Dist., Tao Yuan  
City 33381, Taiwan (R.O.C.)

### **Kwei Shan Site II**

Tel: 886-3-271-8640

No.14-1, Lane 19, Wen San 3rd  
St., Kwei Shan Dist., Tao Yuan  
City 33381, Taiwan (R.O.C.)

If you have any suggestion, please feel free to contact us as below information.

Tel: 886-3-271-8666

Fax: 886-3-318-0345

Email: ICC\_Service@icertifi.com.tw

==END==