

FCC Test Report

FCC ID : RF41539C
Equipment : Handheld Terminal
Model No. : DX-A400
Brand Name : KEYENCE
Applicant : KEYENCE CORPORATION
Address : 1-3-14 HIGASHI-NAKAJIMA,
HIGASHI-YODOGAWA-KU, OSAKA, JAPAN
Standard : 47 CFR FCC Part 15.247
Received Date : Jun. 21, 2021
Tested Date : Aug. 03 ~ Aug. 12, 2021

We, International Certification Corporation, would like to declare that the tested sample has been evaluated and in compliance with the requirement of the above standards. The test results contained in this report refer exclusively to the product. It may be duplicated completely for legal use with the approval of the applicant. It shall not be reproduced except in full without the written approval of our laboratory.

Reviewed by:

Along Chen / Assistant Manager

Approved by:

Gary Chang / Manager



Table of Contents

1	GENERAL DESCRIPTION	5
1.1	Information.....	5
1.2	Local Support Equipment List	7
1.3	Test Setup Chart	7
1.4	Test Equipment List and Calibration Data.....	8
1.5	Test Standards	9
1.6	Reference Guidance	9
1.7	Deviation from Test Standard and Measurement Procedure.....	9
1.8	Measurement Uncertainty	9
2	TEST CONFIGURATION	10
2.1	Testing Facility.....	10
2.2	The Worst Test Modes and Channel Details	10
3	TRANSMITTER TEST RESULTS.....	11
3.1	Conducted Emissions.....	11
3.2	6dB and Occupied Bandwidth	14
3.3	RF Output Power	22
3.4	Power Spectral Density	25
3.5	Emissions in Restricted Frequency Bands.....	33
3.6	Emissions in non-restricted Frequency Bands.....	49
4	TEST LABORATORY INFORMATION	56

Release Record

Report No.	Version	Description	Issued Date
FR162103AE	Rev. 01	Initial issue	Nov. 16, 2021

Summary of Test Results

FCC Rules	Test Items	Measured	Result
15.207	AC Power Line Conducted Emissions	[dBuV]: 0.582MHz 28.86 (Margin -17.14dB) - AV	Pass
15.247(d) 15.209	Radiated Emissions	[dBuV/m at 3m]: 30.15MHz 34.39 (Margin -5.61dB) - PK	Pass
15.247(b)(3)	Maximum Output Power	Power [dBm]: -2.34	Pass
15.247(a)(2)	6dB Bandwidth	Meet the requirement of limit	Pass
15.247(e)	Power Spectral Density	Meet the requirement of limit	Pass
15.203	Antenna Requirement	Meet the requirement of limit	Pass

Declaration of Conformity:

The test results with all measurement uncertainty excluded are presented in accordance with the regulation limits or requirements declared by manufacturers.

Comments and Explanations:

The declared of product specification for EUT presented in the report are provided by the manufacturer, and the manufacturer takes all the responsibilities for the accuracy of product specification.

1 General Description

1.1 Information

1.1.1 Specification of the Equipment under Test (EUT)

RF General Information				
Frequency Range (MHz)	Bluetooth Mode	Ch. Freq. (MHz)	Channel Number	Data Rate
2400-2483.5	V5.0 LE	2402-2480	0-39 [40]	125 kbps
				500 kbps
				1 Mbps
2400-2483.5	V5.0 LE	2402-2480	0-39 [40]	2 Mbps

Note: Bluetooth LE (Low energy) uses GFSK modulation.

1.1.2 Antenna Details

Ant. No.	Type	Connector	Gain (dBi)	Remarks
1	PIFA	No	-0.23	---

1.1.3 Power Supply Type of Equipment under Test (EUT)

Power Supply Type	3.8Vdc
-------------------	--------

1.1.4 Accessories

Accessories		
No.	Equipment	Description
1	Battery	Brand: KEYENCE Model: DX-BQ3 Rating: 3.8Vdc (11.51Wh) 3030mAh

1.1.5 Channel List

Frequency band (MHz)				2400~2483.5			
Channel	Frequency (MHz)	Channel	Frequency (MHz)	Channel	Frequency (MHz)	Channel	Frequency (MHz)
37	2402	9	2422	18	2442	28	2462
0	2404	10	2424	19	2444	29	2464
1	2406	38	2426	20	2446	30	2466
2	2408	11	2428	21	2448	31	2468
3	2410	12	2430	22	2450	32	2470
4	2412	13	2432	23	2452	33	2472
5	2414	14	2434	24	2454	34	2474
6	2416	15	2436	25	2456	35	2476
7	2418	16	2438	26	2458	36	2478
8	2420	17	2440	27	2460	39	2480

1.1.6 Test Tool and Duty Cycle

Test Tool	Function Test, V10	
Modulation Mode	Duty Cycle Of Test Signal (%)	Duty Factor (dB)
BT-LE(125kbps)	83.80%	0.77
BT-LE(500kbps)	58.53%	2.33
BT-LE(1Mbps)	62.50%	2.04
BT-LE(2Mbps)	32.87%	4.83

1.1.7 Power Index of Test Tool

Modulation Mode	Test Frequency (MHz)		
	2402	2440	2480
BT-LE(125kbps)	Default	Default	Default
BT-LE(500kbps)	Default	Default	Default
BT-LE(1Mbps)	Default	Default	Default
BT-LE(2Mbps)	Default	Default	Default

1.2 Local Support Equipment List

Support Equipment List					
No.	Equipment	Brand	Model	FCC ID	Remarks
1	Adapter	PHIHONG	PSA10F-050Q	---	Provided by applicant. Input: 100-240V~ 50/60Hz, 0.35A Output: 5.0V=2.0A, 10.0W

Note: Adapter is used for charging only.

1.3 Test Setup Chart

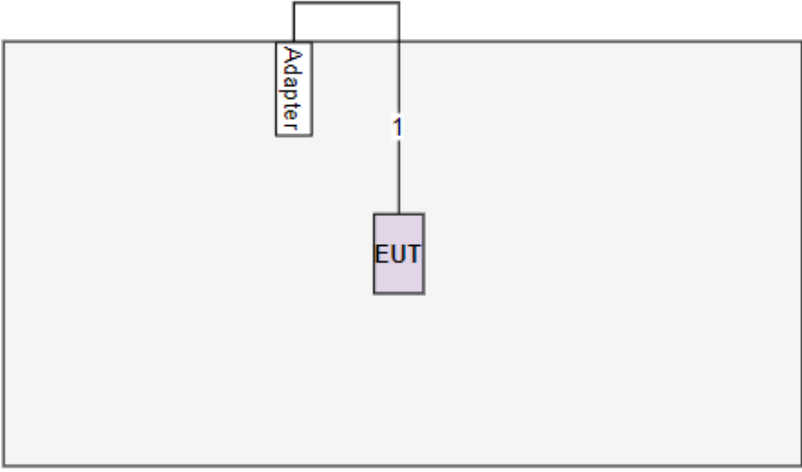
Test Setup Diagram	
	
No.	Signal cable / Length (m)
1	USB, 1m shielded. (Provided by applicant.)

1.4 Test Equipment List and Calibration Data

Test Item	Conducted Emission				
Test Site	Conduction room 1 / (CO01-WS)				
Tested Date	Aug. 12, 2021				
Instrument	Brand	Model No.	Serial No.	Calibration Date	Calibration Until
Receiver	R&S	ESR3	101658	Feb. 08, 2021	Feb. 07, 2022
LISN	R&S	ENV216	101579	Mar. 17, 2021	Mar. 16, 2022
LISN (Support Unit)	SCHWARZBECK	Schwarzbeck 8127	8127-666	Dec. 29, 2020	Dec. 28, 2021
RF Cable-CON	Woken	CFD200-NL	CFD200-NL-001	Oct. 21, 2020	Oct. 20, 2021
50 ohm terminal (Support Unit)	NA	50	04	May 25, 2021	May 24, 2022
Measurement Software	AUDIX	e3	6.120210k	NA	NA
Note: Calibration Interval of instruments listed above is one year.					

Test Item	Radiated Emission				
Test Site	966 chamber1 / (03CH01-WS)				
Tested Date	Aug. 03, 2021				
Instrument	Brand	Model No.	Serial No.	Calibration Date	Calibration Until
Receiver	R&S	ESR3	101657	Mar. 12, 2021	Mar. 11, 2022
Spectrum Analyzer	R&S	FSV40	101498	Dec. 04, 2020	Dec. 03, 2021
Loop Antenna	R&S	HFH2-Z2	100330	Nov. 17, 2020	Nov. 16, 2021
Bilog Antenna	SCHWARZBECK	VULB9168	VULB9168-522	Jun. 30, 2021	Jun. 29, 2022
Horn Antenna 1G-18G	SCHWARZBECK	BBHA 9120 D	BBHA 9120 D 1096	Dec. 11, 2020	Dec. 10, 2021
Horn Antenna 18G-40G	SCHWARZBECK	BBHA 9170	BBHA 9170517	Nov. 06, 2020	Nov. 05, 2021
Preamplifier	EMC	EMC02325	980225	Jun. 29, 2021	Jun. 28, 2022
Preamplifier	Agilent	83017A	MY39501308	Sep. 26, 2020	Sep. 25, 2021
Preamplifier	EMC	EMC184045B	980192	Jul. 14, 2021	Jul. 13, 2022
Loop Antenna Cable	KOAX KABEL	101354-BW	101354-BW	Oct. 06, 2020	Oct. 05, 2021
LF cable 3M	Woken	CFD400NL-LW	CFD400NL-001	Oct. 06, 2020	Oct. 05, 2021
LF cable 11M	EMC	EMCCFD400-NW-N W-11000	200801	Oct. 06, 2020	Oct. 05, 2021
LF cable 1M	EMC	EMCCFD400-NM-N M-1000	160502	Oct. 06, 2020	Oct. 05, 2021
RF Cable	HUBER+SUHNER	SUCOFLEX104	MY16019/4	Oct. 06, 2020	Oct. 05, 2021
RF Cable	HUBER+SUHNER	SUCOFLEX104	MY16014/4	Oct. 06, 2020	Oct. 05, 2021
Measurement Software	AUDIX	e3	6.120210g	NA	NA
Note: Calibration Interval of instruments listed above is one year.					

Test Item	RF Conducted				
Test Site	(TH01-WS)				
Tested Date	Aug. 10, 2021				
Instrument	Brand	Model No.	Serial No.	Calibration Date	Calibration Until
Spectrum Analyzer	R&S	FSV40	101063	Apr. 19, 2021	Apr. 18, 2022
Power Meter	Anritsu	ML2495A	1241002	Nov. 04, 2020	Nov. 03, 2021
Power Sensor	Anritsu	MA2411B	1207366	Nov. 04, 2020	Nov. 03, 2021
Measurement Software	Sporton	SENSE-15247_FS	V5.10.7.11	NA	NA
Note: Calibration Interval of instruments listed above is one year.					

1.5 Test Standards

47 CFR FCC Part 15.247
ANSI C63.10-2013

1.6 Reference Guidance

FCC KDB 558074 D01 15.247 Meas Guidance v05r02

1.7 Deviation from Test Standard and Measurement Procedure

None

1.8 Measurement Uncertainty

The measurement uncertainties given below are based on a 95% confidence level (based on a coverage factor (k=2)).

Measurement Uncertainty	
Parameters	Uncertainty
Bandwidth	±34.130 Hz
Conducted power	±0.808 dB
Power density	±0.583 dB
Conducted emission	±2.715 dB
AC conducted emission	±2.92 dB
Radiated emission ≤ 1GHz	±3.41 dB
Radiated emission > 1GHz	±4.59 dB

2 Test Configuration

2.1 Testing Facility

Test Laboratory	International Certification Corporation
Test Site	CO01-WS, 03CH01-WS, TH01-WS
Address of Test Site	No.3-1, Lane 6, Wen San 3rd St., Kwei Shan Dist., Tao Yuan City 33381, Taiwan (R.O.C.)

- FCC Designation No.: TW2732
- FCC site registration No.: 181692
- ISED#: 10807A
- CAB identifier: TW2732

2.2 The Worst Test Modes and Channel Details

Test item	Mode	Test Frequency (MHz)	Data Rate	Test Configuration
AC Power Line Conducted Emissions Radiated Emissions \leq 1GHz	BT LE	2440	1Mbps	---
Maximum Output Power 6dB bandwidth Power spectral density	BT LE	2402, 2440, 2480	125kbps 500kbps 1Mbps 2Mbps	---
Radiated Emissions > 1GHz	BT LE	2402, 2440, 2480	1Mbps 2Mbps	---
NOTE:				
1. The EUT was pretested with 3 orientations placed on the table for the radiated emission measurement – X, Y, and Z-plane. The X-plane results were found as the worst case and were shown in this report.				

3 Transmitter Test Results

3.1 Conducted Emissions

3.1.1 Limit of Conducted Emissions

Conducted Emissions Limit		
Frequency Emission (MHz)	Quasi-Peak	Average
0.15-0.5	66 - 56 *	56 - 46 *
0.5-5	56	46
5-30	60	50

Note 1: * Decreases with the logarithm of the frequency.

3.1.2 Test Procedures

1. The device is placed on a test table, raised 80 cm above the reference ground plane. The vertical conducting plane is located 40 cm to the rear of the device.
2. The device is connected to line impedance stabilization network (LISN) and other accessories are connected to other LISN. Measured levels of AC power line conducted emission are across the 50 Ω LISN port.
3. AC conducted emission measurements is made over frequency range from 150 kHz to 30 MHz.
4. This measurement was performed with AC 120V/60Hz

3.1.3 Test Setup



- Note: 1. Support units were connected to second LISN.
 2. Both of LISNs (AMN) are 80 cm from EUT and at least 80 cm from other units and other metal planes

3.1.4 Test Result of Conducted Emissions

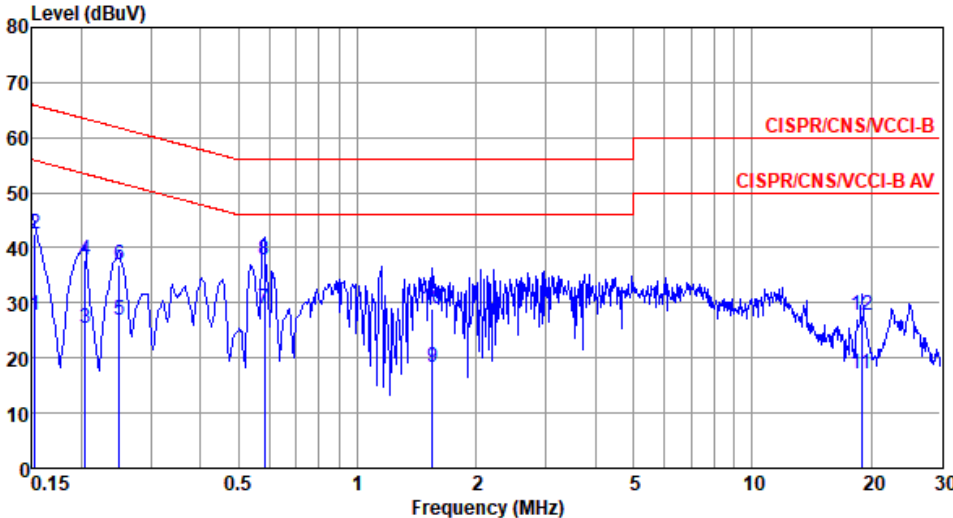
Modulation Mode	BT LE-1Mbps	Test Freq. (MHz)	2440																																																																																																																					
Power Phase	Line																																																																																																																							
Test by : Joe Liao Temperature: 22°C Humidity: 68%																																																																																																																								
																																																																																																																								
<table border="1"> <thead> <tr> <th></th> <th>Freq MHz</th> <th>Level dBuA</th> <th>Limit Line dBuA</th> <th>Over Limit dB</th> <th>Read Level dBuA</th> <th>Factor dB</th> <th>Cable loss dB</th> <th>Remark</th> </tr> </thead> <tbody> <tr><td>1</td><td>0.152</td><td>27.88</td><td>55.87</td><td>-27.99</td><td>18.00</td><td>9.83</td><td>0.05</td><td>Average</td></tr> <tr><td>2</td><td>0.152</td><td>42.43</td><td>65.87</td><td>-23.44</td><td>32.55</td><td>9.83</td><td>0.05</td><td>QP</td></tr> <tr><td>3</td><td>0.204</td><td>25.32</td><td>53.45</td><td>-28.13</td><td>15.42</td><td>9.84</td><td>0.06</td><td>Average</td></tr> <tr><td>4</td><td>0.204</td><td>37.92</td><td>63.45</td><td>-25.53</td><td>28.02</td><td>9.84</td><td>0.06</td><td>QP</td></tr> <tr><td>5</td><td>0.249</td><td>26.76</td><td>51.78</td><td>-25.02</td><td>16.83</td><td>9.86</td><td>0.07</td><td>Average</td></tr> <tr><td>6</td><td>0.249</td><td>37.04</td><td>61.78</td><td>-24.74</td><td>27.11</td><td>9.86</td><td>0.07</td><td>QP</td></tr> <tr><td>7*</td><td>0.582</td><td>28.86</td><td>46.00</td><td>-17.14</td><td>18.83</td><td>9.93</td><td>0.10</td><td>Average</td></tr> <tr><td>8</td><td>0.582</td><td>37.91</td><td>56.00</td><td>-18.09</td><td>27.88</td><td>9.93</td><td>0.10</td><td>QP</td></tr> <tr><td>9</td><td>1.552</td><td>18.25</td><td>46.00</td><td>-27.75</td><td>8.09</td><td>10.00</td><td>0.16</td><td>Average</td></tr> <tr><td>10</td><td>1.552</td><td>28.93</td><td>56.00</td><td>-27.07</td><td>18.77</td><td>10.00</td><td>0.16</td><td>QP</td></tr> <tr><td>11</td><td>18.920</td><td>17.25</td><td>50.00</td><td>-32.75</td><td>6.34</td><td>10.25</td><td>0.66</td><td>Average</td></tr> <tr><td>12</td><td>18.920</td><td>27.83</td><td>60.00</td><td>-32.17</td><td>16.92</td><td>10.25</td><td>0.66</td><td>QP</td></tr> </tbody> </table>					Freq MHz	Level dBuA	Limit Line dBuA	Over Limit dB	Read Level dBuA	Factor dB	Cable loss dB	Remark	1	0.152	27.88	55.87	-27.99	18.00	9.83	0.05	Average	2	0.152	42.43	65.87	-23.44	32.55	9.83	0.05	QP	3	0.204	25.32	53.45	-28.13	15.42	9.84	0.06	Average	4	0.204	37.92	63.45	-25.53	28.02	9.84	0.06	QP	5	0.249	26.76	51.78	-25.02	16.83	9.86	0.07	Average	6	0.249	37.04	61.78	-24.74	27.11	9.86	0.07	QP	7*	0.582	28.86	46.00	-17.14	18.83	9.93	0.10	Average	8	0.582	37.91	56.00	-18.09	27.88	9.93	0.10	QP	9	1.552	18.25	46.00	-27.75	8.09	10.00	0.16	Average	10	1.552	28.93	56.00	-27.07	18.77	10.00	0.16	QP	11	18.920	17.25	50.00	-32.75	6.34	10.25	0.66	Average	12	18.920	27.83	60.00	-32.17	16.92	10.25	0.66	QP
	Freq MHz	Level dBuA	Limit Line dBuA	Over Limit dB	Read Level dBuA	Factor dB	Cable loss dB	Remark																																																																																																																
1	0.152	27.88	55.87	-27.99	18.00	9.83	0.05	Average																																																																																																																
2	0.152	42.43	65.87	-23.44	32.55	9.83	0.05	QP																																																																																																																
3	0.204	25.32	53.45	-28.13	15.42	9.84	0.06	Average																																																																																																																
4	0.204	37.92	63.45	-25.53	28.02	9.84	0.06	QP																																																																																																																
5	0.249	26.76	51.78	-25.02	16.83	9.86	0.07	Average																																																																																																																
6	0.249	37.04	61.78	-24.74	27.11	9.86	0.07	QP																																																																																																																
7*	0.582	28.86	46.00	-17.14	18.83	9.93	0.10	Average																																																																																																																
8	0.582	37.91	56.00	-18.09	27.88	9.93	0.10	QP																																																																																																																
9	1.552	18.25	46.00	-27.75	8.09	10.00	0.16	Average																																																																																																																
10	1.552	28.93	56.00	-27.07	18.77	10.00	0.16	QP																																																																																																																
11	18.920	17.25	50.00	-32.75	6.34	10.25	0.66	Average																																																																																																																
12	18.920	27.83	60.00	-32.17	16.92	10.25	0.66	QP																																																																																																																
Note 1: Level (dBuV) = Read Level (dBuV) + LISN Factor (dB) + Cable Loss (dB). Note 2: Over Limit (dB) = Level (dBuV) – Limit Line (dBuV).																																																																																																																								

Modulation Mode	BT LE-1Mbps	Test Freq. (MHz)	2440
Power Phase	Neutral		

Test by : Joe Liao Temperature: 22°C Humidity: 68%

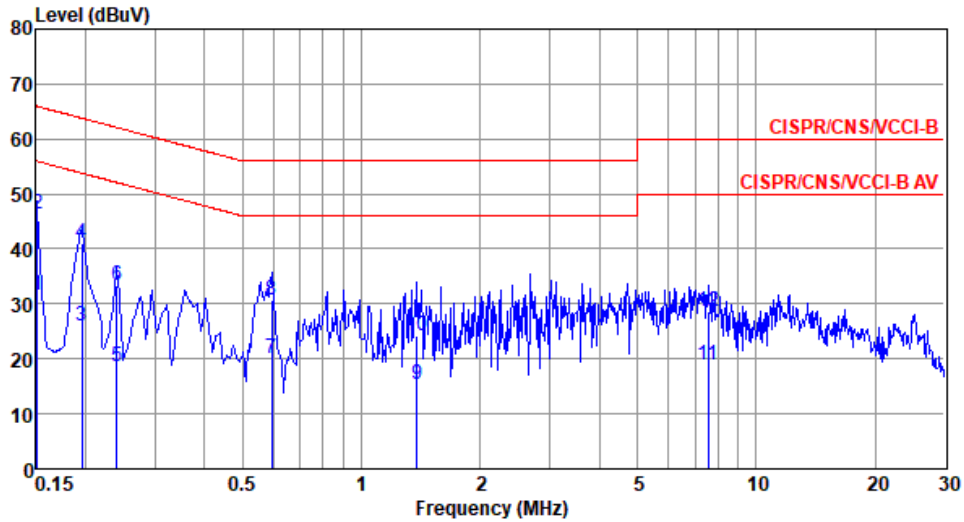

	Freq MHz	Level dBuA	Limit Line dBuA	Over Limit dB	Read Level dBuA	Factor dB	Cable loss dB	Remark
1	0.151	31.49	55.96	-24.47	21.62	9.82	0.05	Average
2*	0.151	46.32	65.96	-19.64	36.45	9.82	0.05	QP
3	0.195	26.12	53.80	-27.68	16.23	9.83	0.06	Average
4	0.195	41.09	63.80	-22.71	31.20	9.83	0.06	QP
5	0.240	18.64	52.08	-33.44	8.73	9.84	0.07	Average
6	0.240	33.25	62.08	-28.83	23.34	9.84	0.07	QP
7	0.592	20.14	46.00	-25.86	10.18	9.86	0.10	Average
8	0.592	30.78	56.00	-25.22	20.82	9.86	0.10	QP
9	1.381	15.32	46.00	-30.68	5.26	9.91	0.15	Average
10	1.381	24.13	56.00	-31.87	14.07	9.91	0.15	QP
11	7.566	18.75	50.00	-31.25	8.33	10.05	0.37	Average
12	7.566	28.76	60.00	-31.24	18.34	10.05	0.37	QP

Note 1: Level (dBuV) = Read Level (dBuV) + LISN Factor (dB) + Cable Loss (dB).
 2: Over Limit (dB) = Level (dBuV) – Limit Line (dBuV).

3.2 6dB and Occupied Bandwidth

3.2.1 Limit of 6dB Bandwidth

The minimum 6dB bandwidth shall be at least 500 kHz.

3.2.2 Test Procedures

6dB Bandwidth

1. Set resolution bandwidth (RBW) = 100 kHz, Video bandwidth = 300 kHz.
2. Detector = Peak, Trace mode = max hold.
3. Sweep = auto couple, Allow the trace to stabilize.
4. Measure the maximum width of the emission that is constrained by the frequencies associated with the two outermost amplitude points (upper and lower) that are attenuated by 6dB relative to the maximum level measured in the fundamental emission.

Occupied Bandwidth

1. Set resolution bandwidth (RBW) = 1% ~ 5 % of OBW, Video bandwidth = 3 x RBW.
2. Detector = Sample, Trace mode = max hold.
3. Sweep = auto couple, Allow the trace to stabilize.
4. Use the OBW measurement function of spectrum analyzer to measure the occupied bandwidth.

3.2.3 Test Setup

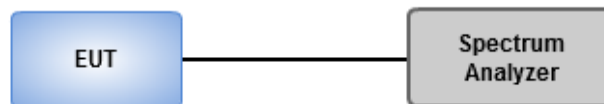

3.2.4 Test Result of 6dB and Occupied Bandwidth

Ambient Condition	22°C / 64%	Tested By	Aska Huang
--------------------------	------------	------------------	------------

Summary

Mode	Max-N dB (Hz)	Max-OBW (Hz)	ITU-Code	Min-N dB (Hz)	Min-OBW (Hz)
2.4-2.4835GHz	-	-	-	-	-
BT-LE(125kbps)	688.406k	1.056M	1M06F1D	684.783k	1.053M
BT-LE(500kbps)	663.043k	1.027M	1M03F1D	659.42k	1.017M
BT-LE(1Mbps)	681.159k	1.031M	1M03F1D	677.536k	1.031M
BT-LE(2Mbps)	1.159M	2.069M	2M07F1D	1.152M	2.062M

Max-N dB = Maximum 6dB down bandwidth; Max-OBW = Maximum 99% occupied bandwidth;
Min-N dB = Minimum 6dB down bandwidth; Min-OBW = Minimum 99% occupied bandwidth

Result

Mode	Result	Limit (Hz)	Port 1-N dB (Hz)	Port 1-OBW (Hz)
BT-LE(125kbps)	-	-	-	-
2402MHz	Pass	500k	688.406k	1.056M
2440MHz	Pass	500k	684.783k	1.053M
2480MHz	Pass	500k	688.406k	1.053M
BT-LE(500kbps)	-	-	-	-
2402MHz	Pass	500k	659.42k	1.027M
2440MHz	Pass	500k	663.043k	1.02M
2480MHz	Pass	500k	659.42k	1.017M
BT-LE(1Mbps)	-	-	-	-
2402MHz	Pass	500k	677.536k	1.031M
2440MHz	Pass	500k	681.159k	1.031M
2480MHz	Pass	500k	677.536k	1.031M
BT-LE(2Mbps)	-	-	-	-
2402MHz	Pass	500k	1.159M	2.069M
2440MHz	Pass	500k	1.159M	2.062M
2480MHz	Pass	500k	1.152M	2.062M

Port X-N dB = Port X 6dB down bandwidth;
Port X-OBW = Port X 99% occupied bandwidth

BT-LE(125kbps)

EBW-DTS

2402MHz

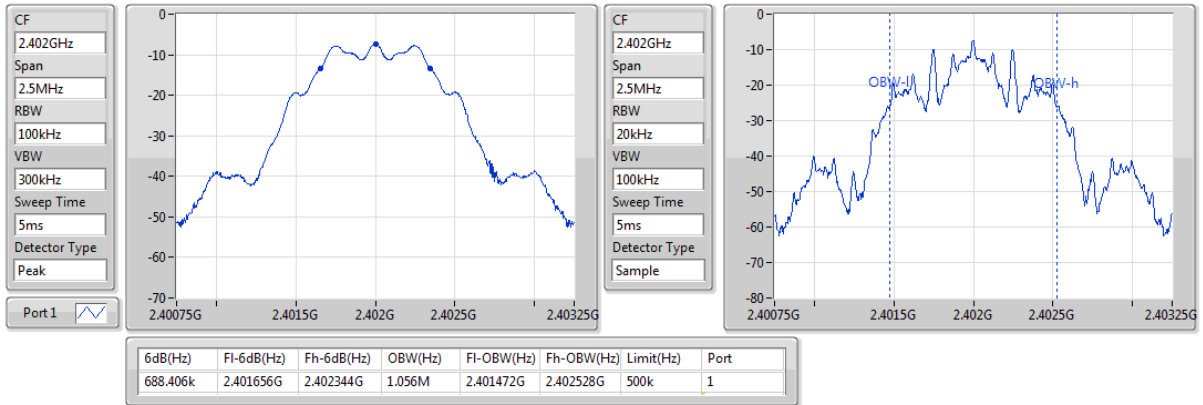

BT-LE(125kbps)

EBW-DTS

2440MHz

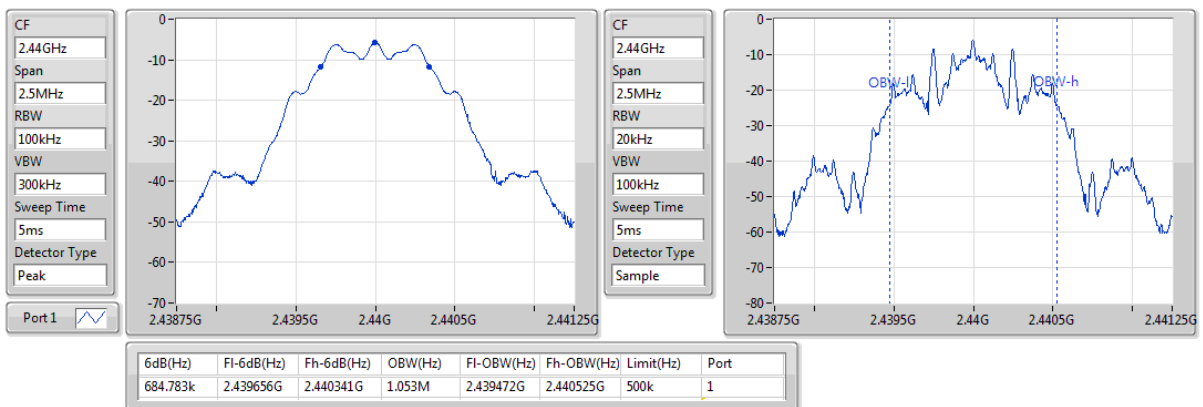

BT-LE(125kbps)

2480MHz

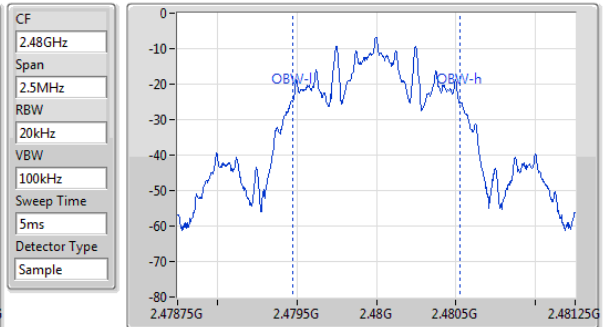
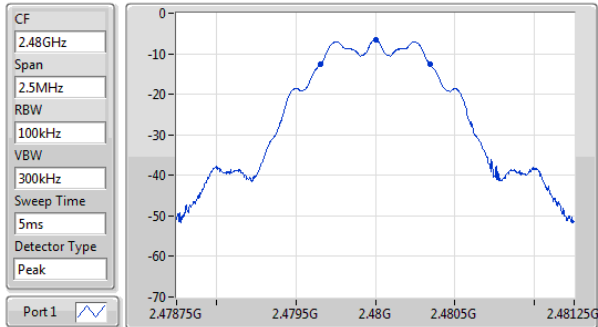

6dB(Hz)	Fl-6dB(Hz)	Fh-6dB(Hz)	OBW(Hz)	Fl-OBW(Hz)	Fh-OBW(Hz)	Limit(Hz)	Port
688.406k	2.479656G	2.480344G	1.053M	2.479472G	2.480525G	500k	1

BT-LE(500kbps)

2402MHz

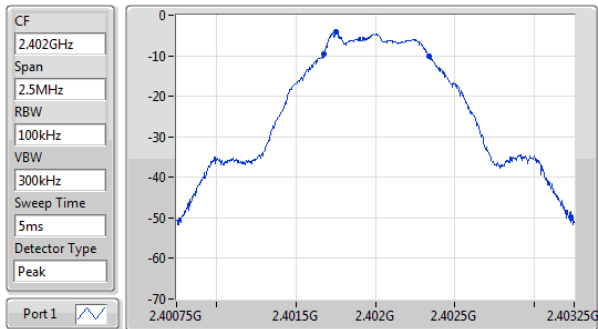

6dB(Hz)	Fl-6dB(Hz)	Fh-6dB(Hz)	OBW(Hz)	Fl-OBW(Hz)	Fh-OBW(Hz)	Limit(Hz)	Port
659.42k	2.401678G	2.402337G	1.027M	2.40149G	2.402517G	500k	1

BT-LE(500kbps)

EBW-DTS

2440MHz

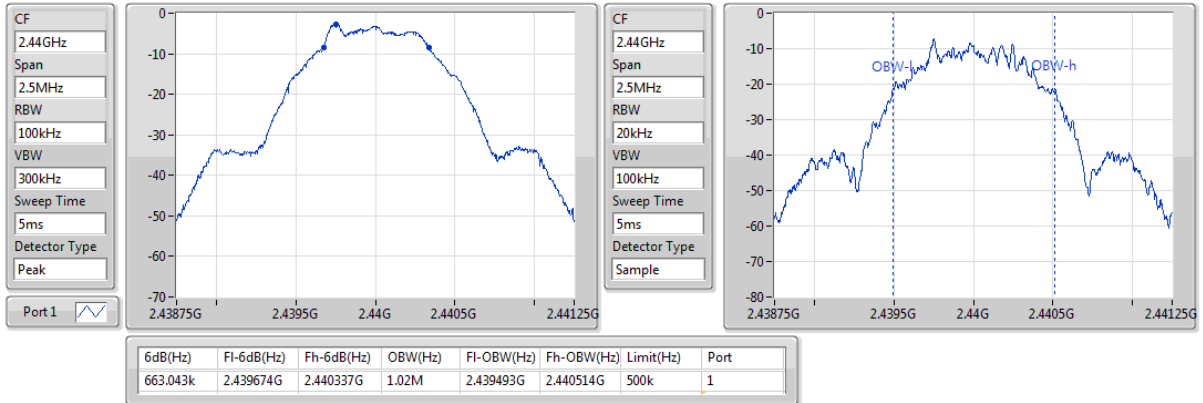

BT-LE(500kbps)

EBW-DTS

2480MHz

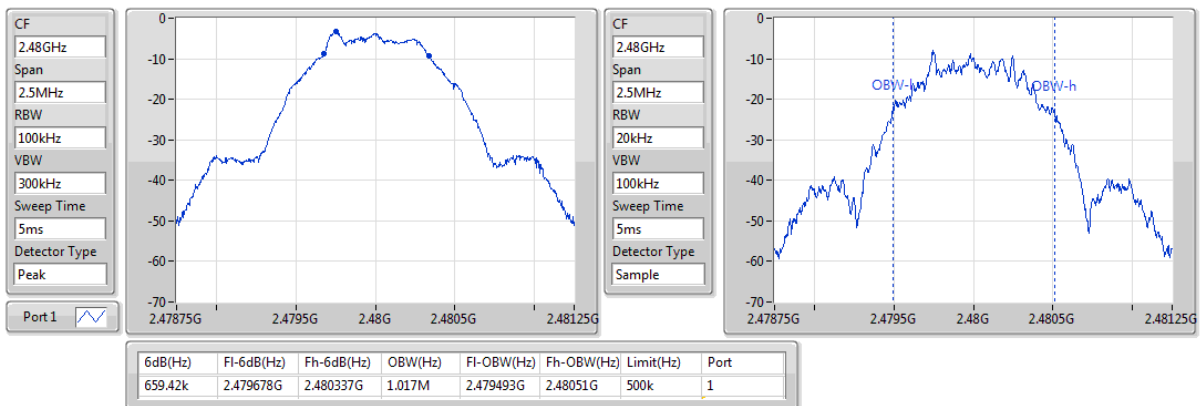

BT-LE(1Mbps)

EBW-DTS

2402MHz

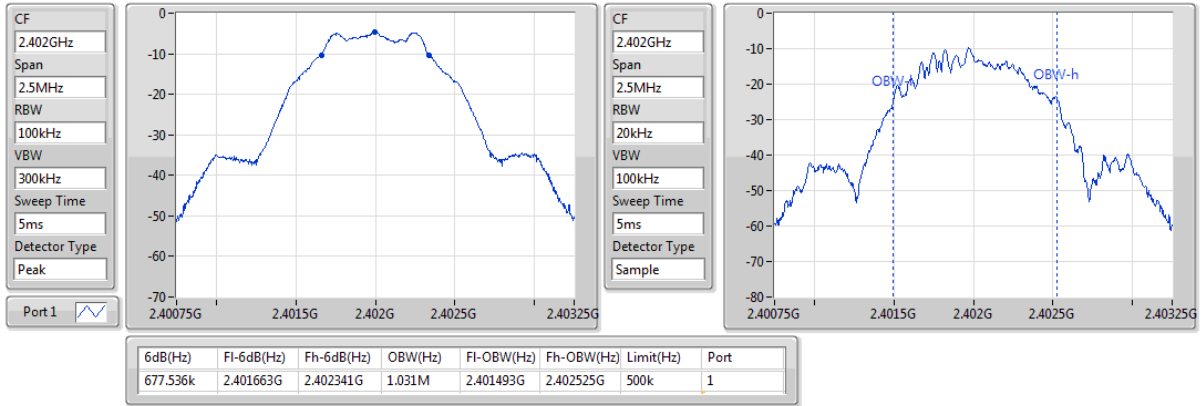

BT-LE(1Mbps)

EBW-DTS

2440MHz

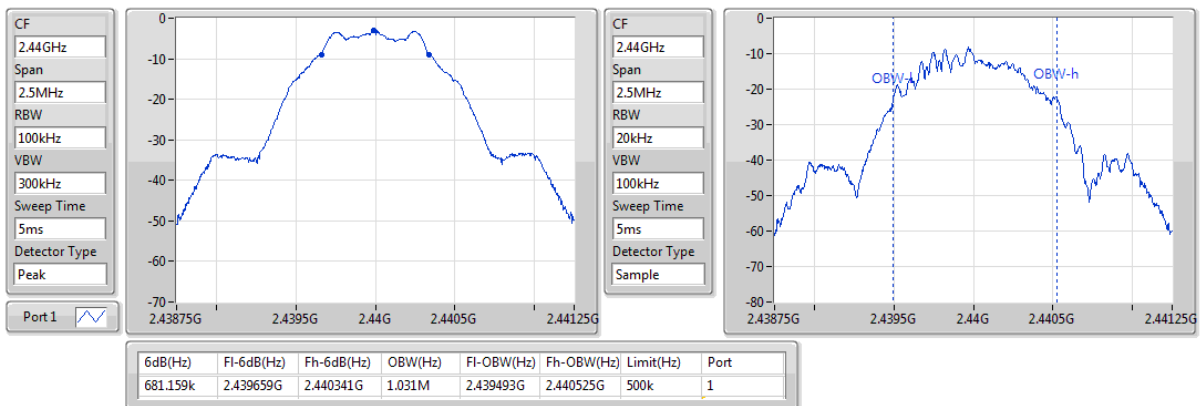

BT-LE(1Mbps)

2480MHz

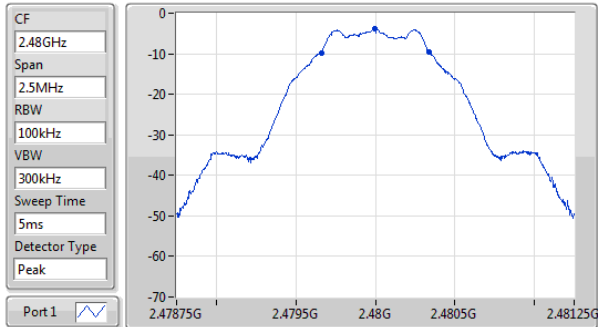

6dB(Hz)	Fl-6dB(Hz)	Fh-6dB(Hz)	OBW(Hz)	Fl-OBW(Hz)	Fh-OBW(Hz)	Limit(Hz)	Port
677.536k	2.479659G	2.480337G	1.031M	2.479493G	2.480525G	500k	1

BT-LE(2Mbps)

2402MHz

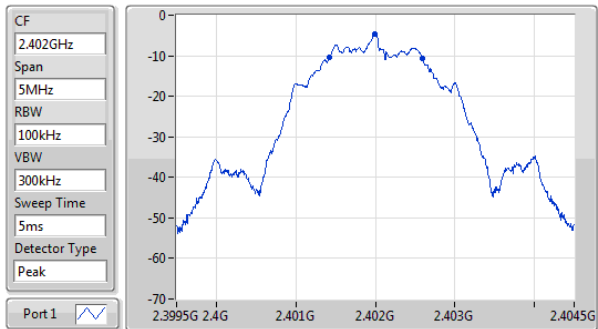

6dB(Hz)	Fl-6dB(Hz)	Fh-6dB(Hz)	OBW(Hz)	Fl-OBW(Hz)	Fh-OBW(Hz)	Limit(Hz)	Port
1.159M	2.401428G	2.402587G	2.069M	2.40098G	2.403049G	500k	1

BT-LE(2Mbps)

2440MHz

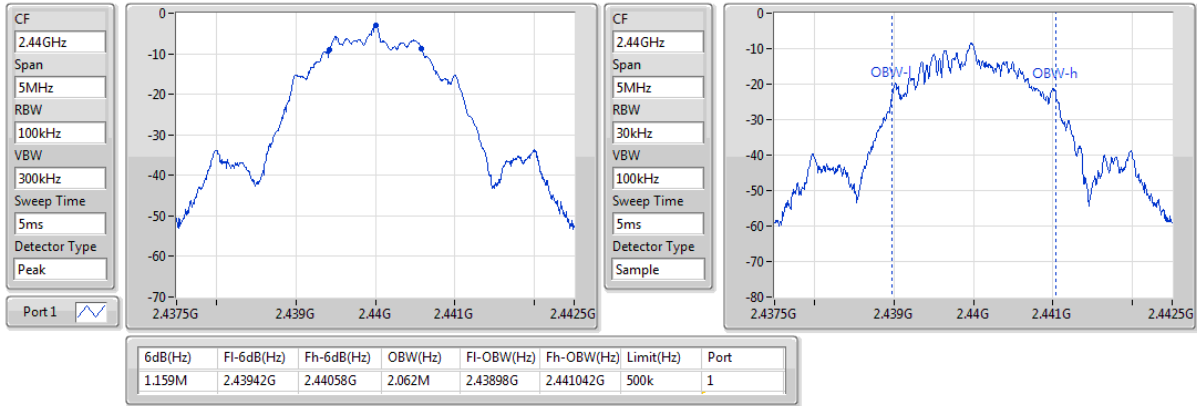

EBW-DTS

BT-LE(2Mbps)

2480MHz

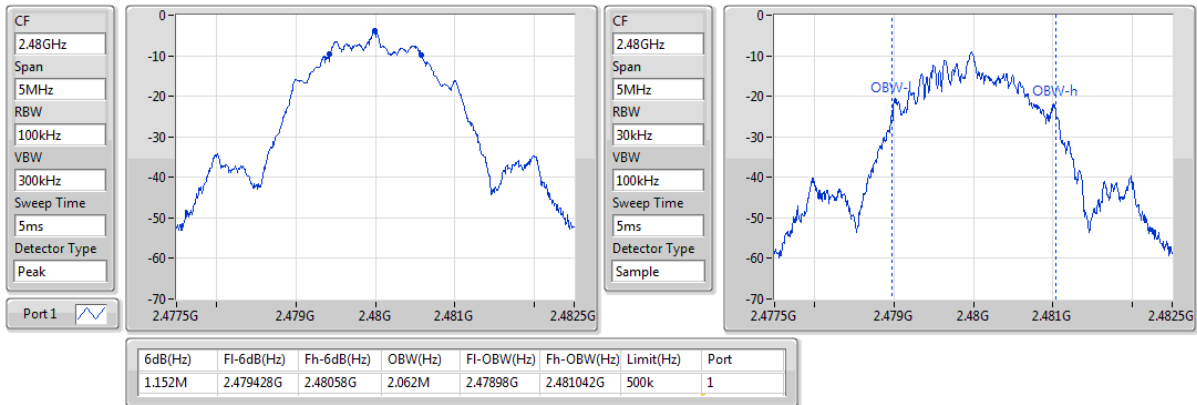

EBW-DTS

3.3 RF Output Power

3.3.1 Limit of RF Output Power

Conducted power shall not exceed 1 Watt.

Antenna gain $\leq 6\text{dBi}$, no any corresponding reduction is in output power limit.

3.3.2 Test Procedures

A broadband RF power meter is used for output power measurement. The video bandwidth of power meter is greater than DTS bandwidth of EUT. If duty cycle of test signal is not 100 %, trigger and gating function of power meter will be enabled to capture transmission burst for measuring output power.

3.3.3 Test Setup

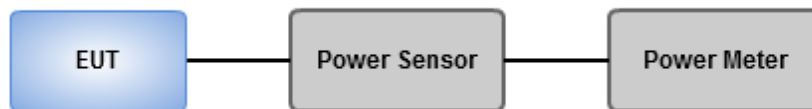

3.3.4 Test Result of Maximum Output Power

Ambient Condition	22°C / 64%	Tested By	Aska Huang
--------------------------	------------	------------------	------------

Summary of Peak Conducted Output Power

Mode	Power (dBm)	Power (W)
2.4-2.4835GHz	-	-
BT-LE(125kbps)	-2.48	0.00056
BT-LE(500kbps)	-2.51	0.00056
BT-LE(1Mbps)	-2.34	0.00058
BT-LE(2Mbps)	-2.35	0.00058

Result

Mode	Result	Gain (dBi)	Power (dBm)	Power Limit (dBm)
BT-LE(125kbps)	-	-	-	-
2402MHz	Pass	-0.23	-3.79	30.00
2440MHz	Pass	-0.23	-2.48	30.00
2480MHz	Pass	-0.23	-3.19	30.00
BT-LE(500kbps)	-	-	-	-
2402MHz	Pass	-0.23	-3.82	30.00
2440MHz	Pass	-0.23	-2.51	30.00
2480MHz	Pass	-0.23	-3.22	30.00
BT-LE(1Mbps)	-	-	-	-
2402MHz	Pass	-0.23	-3.74	30.00
2440MHz	Pass	-0.23	-2.34	30.00
2480MHz	Pass	-0.23	-3.01	30.00
BT-LE(2Mbps)	-	-	-	-
2402MHz	Pass	-0.23	-3.74	30.00
2440MHz	Pass	-0.23	-2.35	30.00
2480MHz	Pass	-0.23	-3.01	30.00

DG = Directional Gain; Port X = Port X output power

Summary of Conducted (Average) Output Power

Mode	Power (dBm)	Power (W)
2.4-2.4835GHz	-	-
BT-LE(125kbps)	-2.62	0.00055
BT-LE(500kbps)	-2.65	0.00054
BT-LE(1Mbps)	-2.51	0.00056
BT-LE(2Mbps)	-2.52	0.00056

Result

Mode	Result	Gain (dBi)	Power (dBm)	Power Limit (dBm)
BT-LE(125kbps)	-	-	-	-
2402MHz	Pass	-0.23	-3.95	-
2440MHz	Pass	-0.23	-2.62	-
2480MHz	Pass	-0.23	-3.32	-
BT-LE(500kbps)	-	-	-	-
2402MHz	Pass	-0.23	-3.97	-
2440MHz	Pass	-0.23	-2.65	-
2480MHz	Pass	-0.23	-3.36	-
BT-LE(1Mbps)	-	-	-	-
2402MHz	Pass	-0.23	-3.91	-
2440MHz	Pass	-0.23	-2.51	-
2480MHz	Pass	-0.23	-3.21	-
BT-LE(2Mbps)	-	-	-	-
2402MHz	Pass	-0.23	-3.91	-
2440MHz	Pass	-0.23	-2.52	-
2480MHz	Pass	-0.23	-3.21	-

Note: Average power is for reference only.

3.4 Power Spectral Density

3.4.1 Limit of Power Spectral Density

Power spectral density shall not be greater than 8 dBm in any 3 kHz band.

3.4.2 Test Procedures

Peak PSD

1. Set the RBW = 3 kHz, VBW = 10 kHz.
2. Detector = Peak, Sweep time = auto couple.
3. Trace mode = max hold, allow trace to fully stabilize.
4. Use the peak marker function to determine the maximum amplitude level.

Average PSD, duty cycle $\geq 98\%$

1. Set the RBW = 30 kHz, VBW = 100 kHz.
2. Detector = RMS, Sweep time = auto couple.
3. Sweep time = auto couple.
4. Employ trace averaging (RMS) mode over a minimum of 100 traces.
5. Use the peak marker function to determine the maximum amplitude level.

Average PSD, duty cycle $< 98\%$

1. Set the RBW = 30 kHz, VBW = 100 kHz. Detector = RMS.
2. Set the sweep time to: ≥ 10 (number of measurement points in sweep) x (total on/off period of the transmitted signal).
3. Perform the measurement over a single sweep.
4. Use the peak marker function to determine the maximum amplitude level.
5. Add $10 \log (1/x)$, where x is the duty cycle.

3.4.3 Test Setup

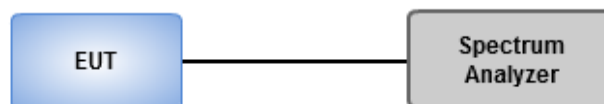

3.4.4 Test Result of Power Spectral Density

Ambient Condition	22°C / 64%	Tested By	Aska Huang
--------------------------	------------	------------------	------------

Summary

Mode	PD (dBm/3kHz)
2.4-2.4835GHz	-
BT-LE(125kbps)	-8.70
BT-LE(500kbps)	-8.84
BT-LE(1Mbps)	-17.42
BT-LE(2Mbps)	-20.05

Result

Mode	Result	Antenna Gain (dBi)	PD (dBm/3kHz)	PD Limit (dBm/3kHz)
BT-LE(125kbps)	-	-	-	-
2402MHz	Pass	-0.23	-10.17	8.00
2440MHz	Pass	-0.23	-8.70	8.00
2480MHz	Pass	-0.23	-9.43	8.00
BT-LE(500kbps)	-	-	-	-
2402MHz	Pass	-0.23	-10.38	8.00
2440MHz	Pass	-0.23	-8.84	8.00
2480MHz	Pass	-0.23	-9.58	8.00
BT-LE(1Mbps)	-	-	-	-
2402MHz	Pass	-0.23	-18.97	8.00
2440MHz	Pass	-0.23	-17.42	8.00
2480MHz	Pass	-0.23	-18.22	8.00
BT-LE(2Mbps)	-	-	-	-
2402MHz	Pass	-0.23	-21.50	8.00
2440MHz	Pass	-0.23	-20.05	8.00
2480MHz	Pass	-0.23	-20.75	8.00

BT-LE(125kbps)

PSD

2402MHz

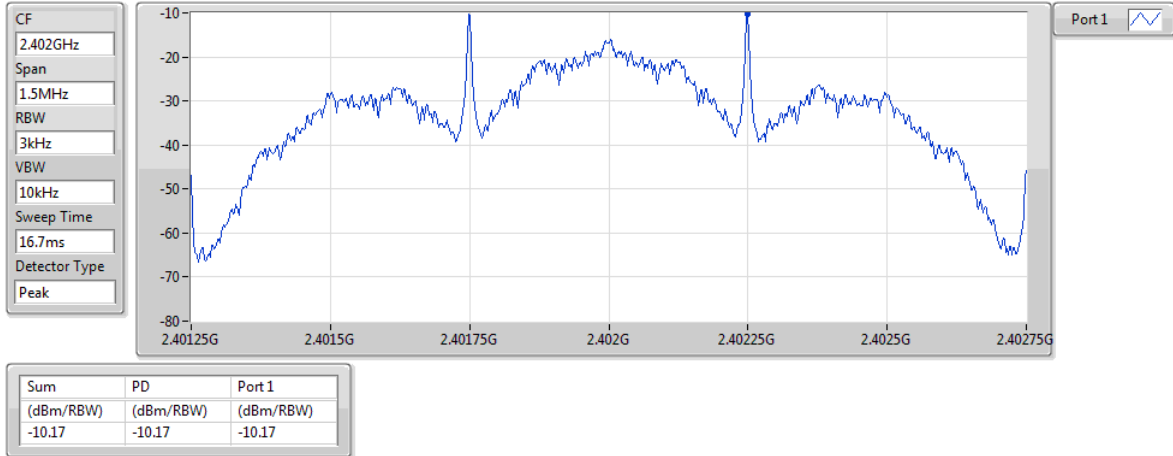

BT-LE(125kbps)

PSD

2440MHz

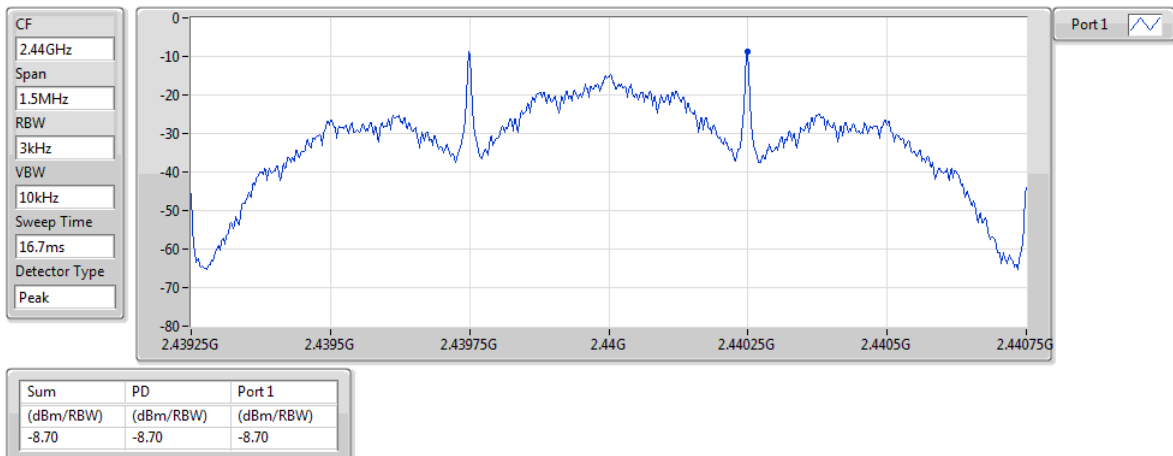

BT-LE(125kbps)

PSD

2480MHz

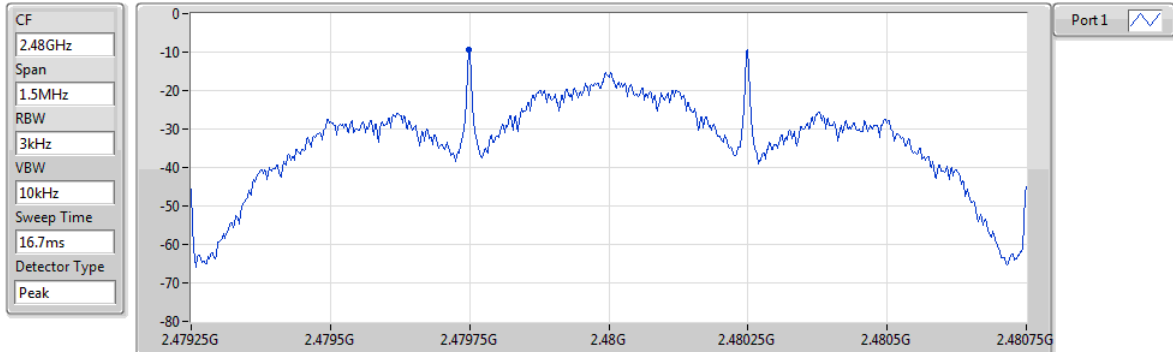

Sum	PD	Port 1
(dBm/RBW)	(dBm/RBW)	(dBm/RBW)
-9.43	-9.43	-9.43

BT-LE(500kbps)

PSD

2402MHz

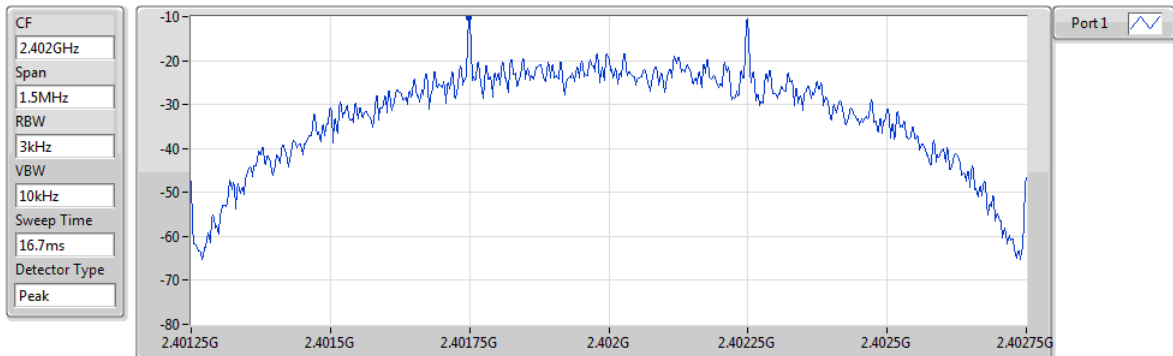

Sum	PD	Port 1
(dBm/RBW)	(dBm/RBW)	(dBm/RBW)
-10.38	-10.38	-10.38

BT-LE(500kbps)

PSD

2440MHz

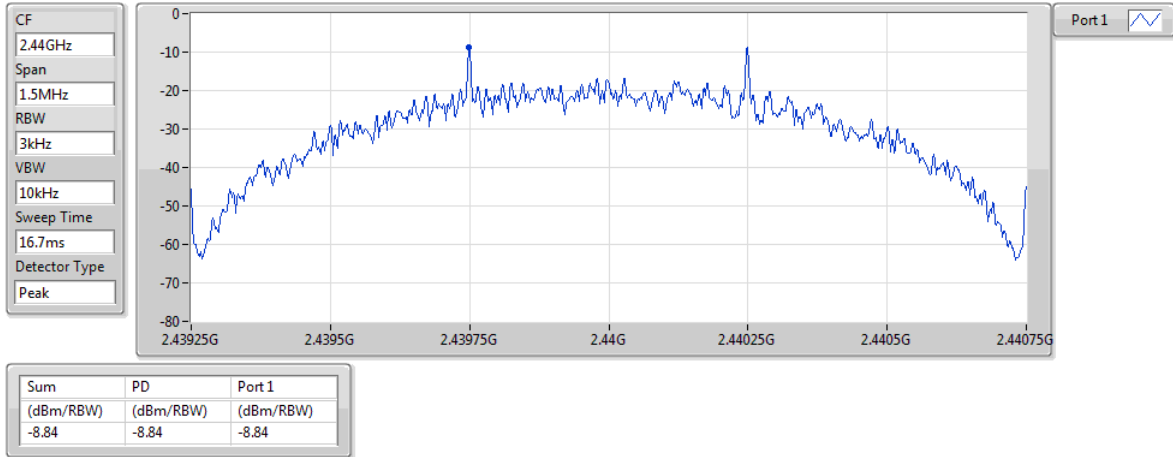

BT-LE(500kbps)

PSD

2480MHz

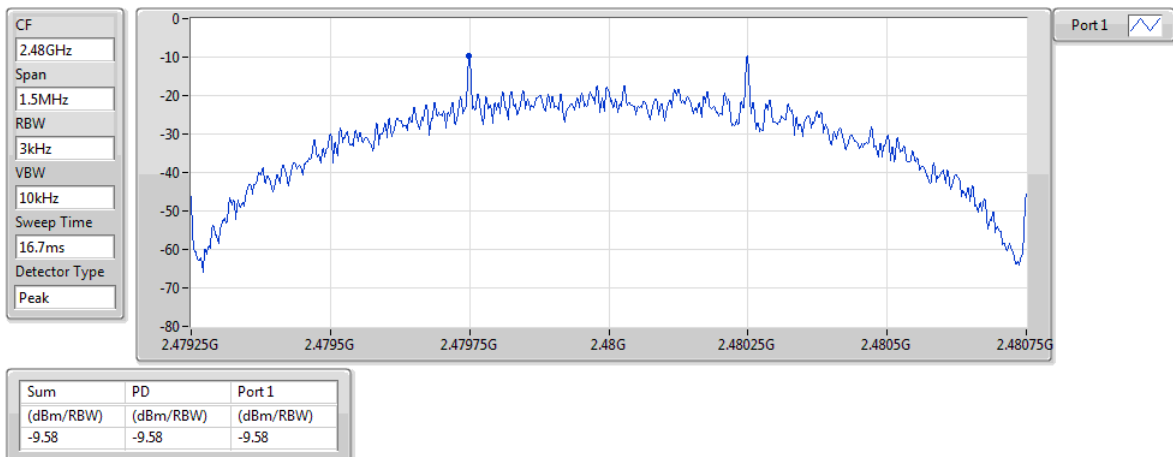

BT-LE(1Mbps)

PSD

2402MHz

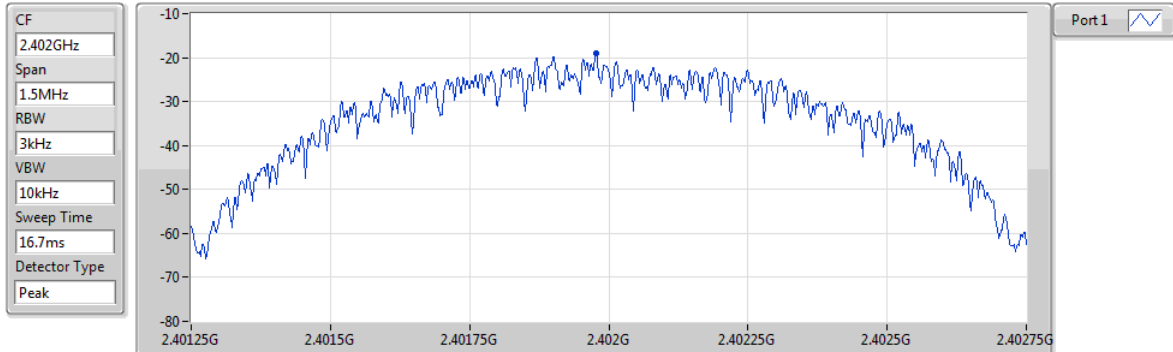

Sum	PD	Port 1
(dBm/RBW)	(dBm/RBW)	(dBm/RBW)
-18.97	-18.97	-18.97

BT-LE(1Mbps)

PSD

2440MHz

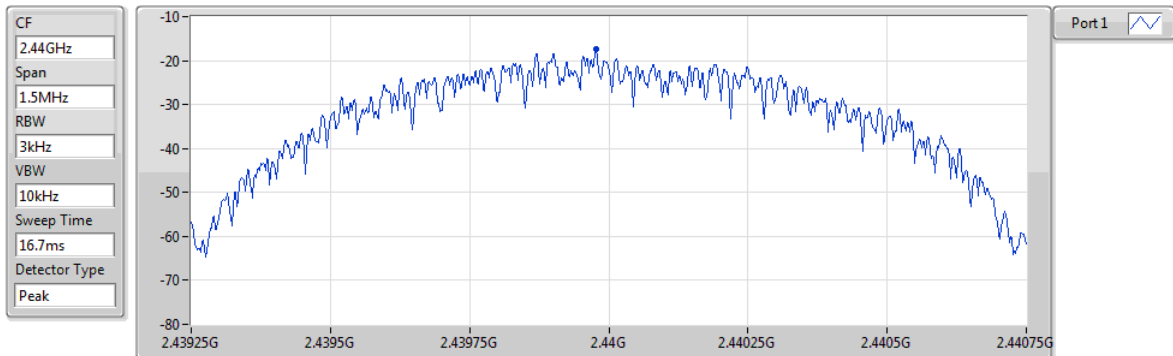

Sum	PD	Port 1
(dBm/RBW)	(dBm/RBW)	(dBm/RBW)
-17.42	-17.42	-17.42

BT-LE(1Mbps)

PSD

2480MHz

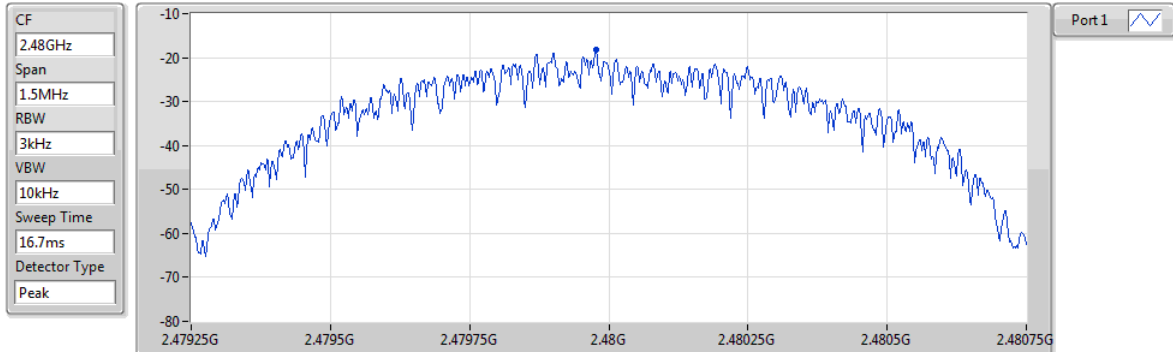

Sum	PD	Port 1
(dBm/RBW)	(dBm/RBW)	(dBm/RBW)
-18.22	-18.22	-18.22

BT-LE(2Mbps)

PSD

2402MHz

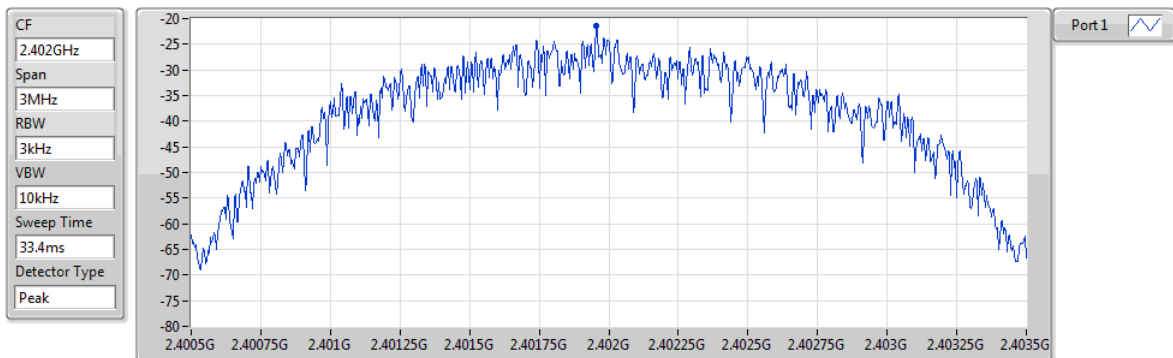

Sum	PD	Port 1
(dBm/RBW)	(dBm/RBW)	(dBm/RBW)
-21.50	-21.50	-21.50

BT-LE(2Mbps)

PSD

2440MHz

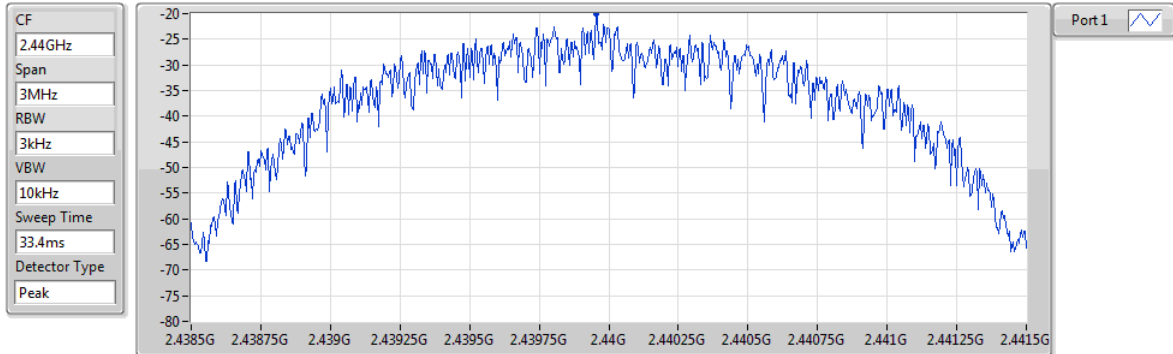

Sum	PD	Port 1
(dBm/RBW)	(dBm/RBW)	(dBm/RBW)
-20.05	-20.05	-20.05

BT-LE(2Mbps)

PSD

2480MHz

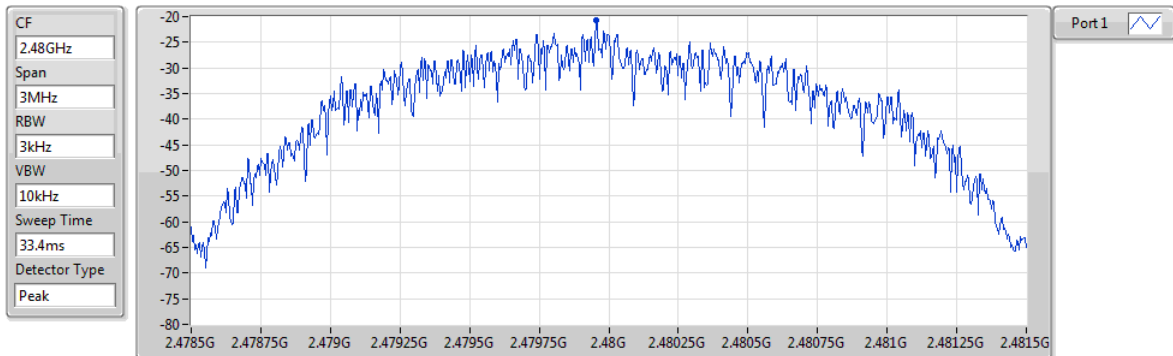

Sum	PD	Port 1
(dBm/RBW)	(dBm/RBW)	(dBm/RBW)
-20.75	-20.75	-20.75

3.5 Emissions in Restricted Frequency Bands

3.5.1 Limit of Emissions in Restricted Frequency Bands

Restricted Band Emissions Limit			
Frequency Range (MHz)	Field Strength (uV/m)	Field Strength (dBuV/m)	Measure Distance (m)
0.009~0.490	2400/F(kHz)	48.5 - 13.8	300
0.490~1.705	24000/F(kHz)	33.8 - 23	30
1.705~30.0	30	29	30
30~88	100	40	3
88~216	150	43.5	3
216~960	200	46	3
Above 960	500	54	3

Note 1:
Quasi-Peak value is measured for frequency below 1GHz except for 9–90 kHz, 110–490 kHz frequency band. Peak and average value are measured for frequency above 1GHz. The limit on average radio frequency emission is as above table. The limit on peak radio frequency emissions is 20 dB above the maximum permitted average emission limit

Note 2:
Measurements may be performed at a distance other than what is specified provided. When performing measurements at a distance other than that specified, the results shall be extrapolated to the specified distance using an extrapolation factor as below, Frequency at or above 30 MHz: 20 dB/decade Frequency below 30 MHz: 40 dB/decade.

3.5.2 Test Procedures

1. Measurement is made at a semi-anechoic chamber that incorporates a turntable allowing a EUT rotation of 360°. A continuously-rotating, remotely-controlled turntable is installed at the test site to support the EUT and facilitate determination of the direction of maximum radiation for each EUT emission frequency. The EUT is placed at test table. For emissions testing at or below 1 GHz, the table height is 80 cm above the reference ground plane. For emission measurements above 1 GHz, the table height is 1.5 m
2. Measurement is made with the antenna positioned in both the horizontal and vertical planes of polarization. The measurement antenna is varied in height (1m ~ 4m) above the reference ground plane to obtain the maximum signal strength. Distance between EUT and antenna is 3 m.
3. This investigation is performed with the EUT rotated 360°, the antenna height scanned between 1 m and 4 m, and the antenna rotated to repeat the measurements for both the horizontal and vertical antenna polarizations.

Note:

1. 120kHz measurement bandwidth of test receiver and Quasi-peak detector is for radiated emission below 1GHz.
2. RBW=1MHz, VBW=3MHz and Peak detector is for peak measured value of radiated emission above 1GHz.
3. RBW=1MHz, VBW=1/T and Peak detector is for average measured value of radiated emission above 1GHz.

3.5.3 Test Setup

Radiated Emissions below 1 GHz

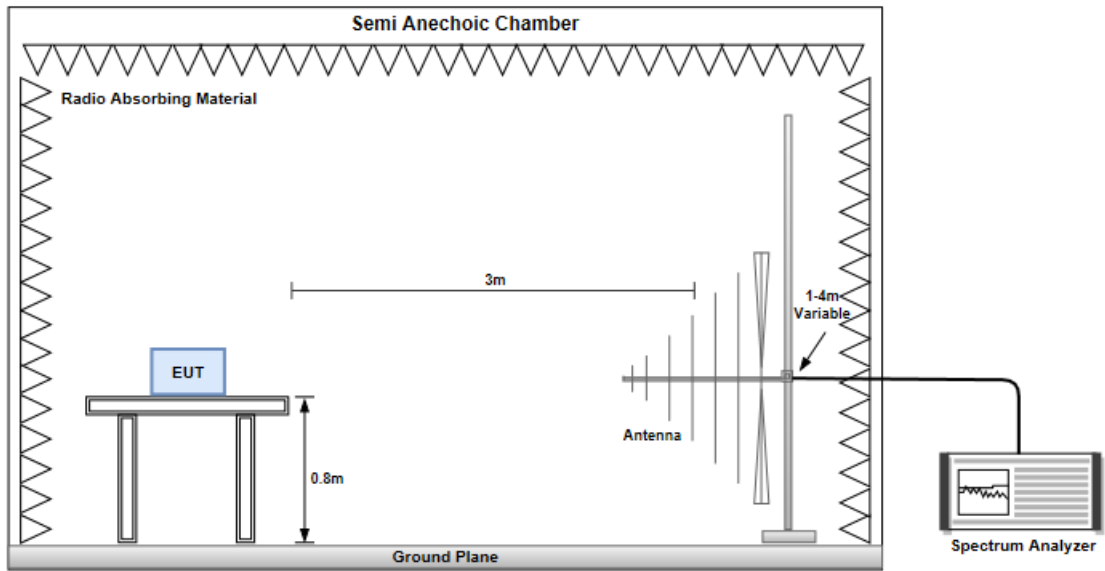

Radiated Emissions above 1 GHz

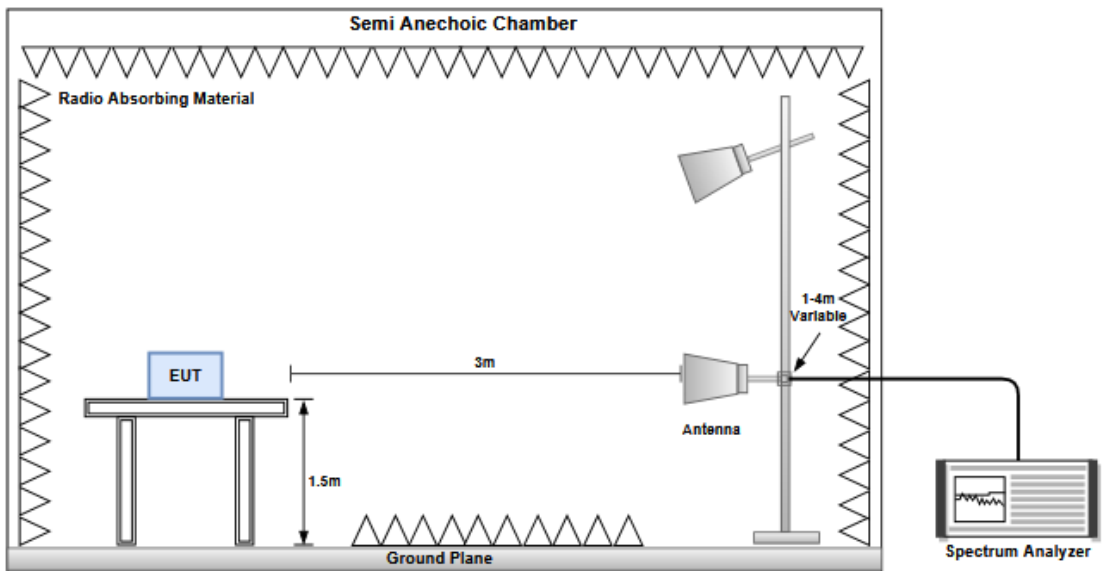

3.5.4 Transmitter Radiated Unwanted Emissions (Below 1GHz)

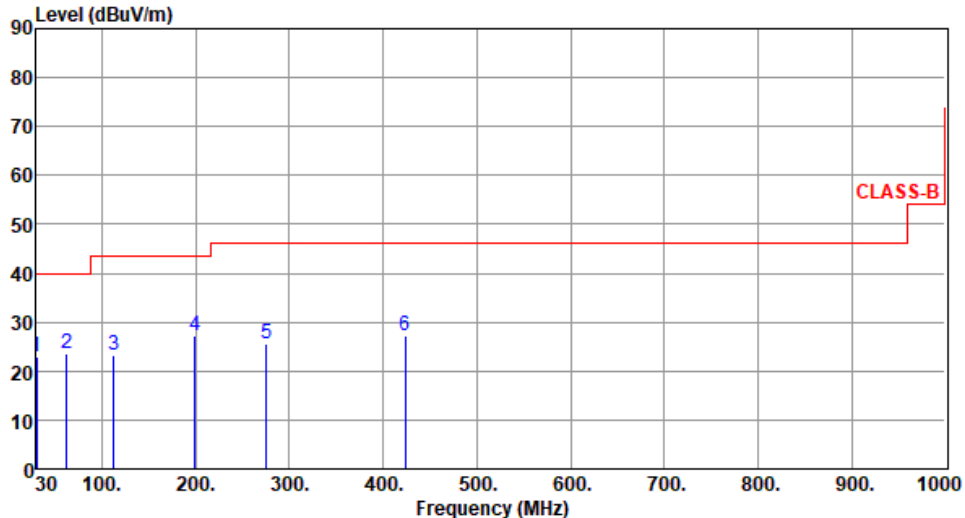
Modulation	BT-LE (1Mbps)	Test Freq. (MHz)	2440																																																																
Polarization	Horizontal																																																																		
Test By : Akun Chung Temperature(°C):25 Humidity(%):64																																																																			
																																																																			
	<table border="1"> <thead> <tr> <th>Freq. MHz</th> <th>Emission level dBuV/m</th> <th>Limit dBuV/m</th> <th>Margin dB</th> <th>SA reading dBuV</th> <th>Factor dB/m</th> <th>Remark</th> <th>ANT High cm</th> <th>Turn Table deg</th> </tr> </thead> <tbody> <tr> <td>1</td> <td>30.28</td> <td>22.95</td> <td>40.00</td> <td>-17.05</td> <td>32.96</td> <td>-10.01</td> <td>Peak</td> <td>---</td> </tr> <tr> <td>2</td> <td>62.45</td> <td>23.61</td> <td>40.00</td> <td>-16.39</td> <td>33.31</td> <td>-9.70</td> <td>Peak</td> <td>---</td> </tr> <tr> <td>3</td> <td>112.31</td> <td>23.40</td> <td>43.50</td> <td>-20.10</td> <td>34.97</td> <td>-11.57</td> <td>Peak</td> <td>---</td> </tr> <tr> <td>4</td> <td>199.15</td> <td>27.29</td> <td>43.50</td> <td>-16.21</td> <td>39.14</td> <td>-11.85</td> <td>Peak</td> <td>---</td> </tr> <tr> <td>5</td> <td>275.65</td> <td>25.64</td> <td>46.00</td> <td>-20.36</td> <td>34.58</td> <td>-8.94</td> <td>Peak</td> <td>---</td> </tr> <tr> <td>6</td> <td>423.56</td> <td>27.22</td> <td>46.00</td> <td>-18.78</td> <td>32.33</td> <td>-5.11</td> <td>Peak</td> <td>---</td> </tr> </tbody> </table>	Freq. MHz	Emission level dBuV/m	Limit dBuV/m	Margin dB	SA reading dBuV	Factor dB/m	Remark	ANT High cm	Turn Table deg	1	30.28	22.95	40.00	-17.05	32.96	-10.01	Peak	---	2	62.45	23.61	40.00	-16.39	33.31	-9.70	Peak	---	3	112.31	23.40	43.50	-20.10	34.97	-11.57	Peak	---	4	199.15	27.29	43.50	-16.21	39.14	-11.85	Peak	---	5	275.65	25.64	46.00	-20.36	34.58	-8.94	Peak	---	6	423.56	27.22	46.00	-18.78	32.33	-5.11	Peak	---			
Freq. MHz	Emission level dBuV/m	Limit dBuV/m	Margin dB	SA reading dBuV	Factor dB/m	Remark	ANT High cm	Turn Table deg																																																											
1	30.28	22.95	40.00	-17.05	32.96	-10.01	Peak	---																																																											
2	62.45	23.61	40.00	-16.39	33.31	-9.70	Peak	---																																																											
3	112.31	23.40	43.50	-20.10	34.97	-11.57	Peak	---																																																											
4	199.15	27.29	43.50	-16.21	39.14	-11.85	Peak	---																																																											
5	275.65	25.64	46.00	-20.36	34.58	-8.94	Peak	---																																																											
6	423.56	27.22	46.00	-18.78	32.33	-5.11	Peak	---																																																											
Note 1: Emission Level (dBuV/m) = SA Reading (dBuV/m) + Factor* (dB) *Factor includes antenna factor , cable loss and amplifier gain Note 2: Margin (dB) = Emission level (dBuV/m) – Limit (dBuV/m). Note 3: All spurious emissions below 30MHz are more than 20 dB below the limit.																																																																			

Modulation	BT-LE (1Mbps)	Test Freq. (MHz)	2440
Polarization	Vertical		

Test By : Akun Chung Temperature(°C): 25 Humidity(%): 64

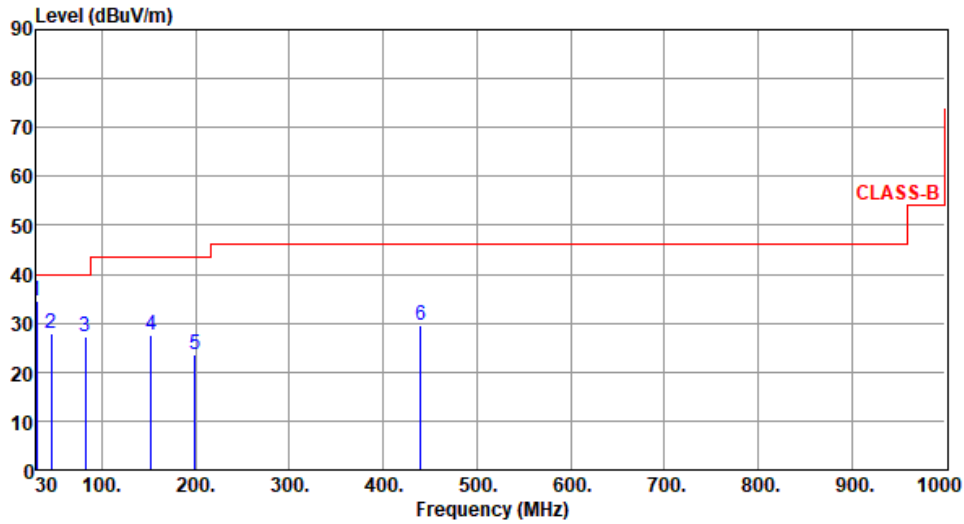

	Freq. MHz	Emission level dBuV/m	Limit dBuV/m	Margin dB	SA reading dBuV	Factor dB/m	Remark	ANT High cm	Turn Table deg
1	30.15	34.39	40.00	-5.61	44.40	-10.01	Peak	---	---
2	46.25	27.85	40.00	-12.15	36.41	-8.56	Peak	---	---
3	82.64	27.15	40.00	-12.85	41.15	-14.00	Peak	---	---
4	152.31	27.46	43.50	-16.04	36.33	-8.87	Peak	---	---
5	199.66	23.64	43.50	-19.86	35.54	-11.90	Peak	---	---
6	440.15	29.68	46.00	-16.32	34.30	-4.62	Peak	---	---

Note 1: Emission Level (dBuV/m) = SA Reading (dBuV/m) + Factor* (dB)

*Factor includes antenna factor , cable loss and amplifier gain

Note 2: Margin (dB) = Emission level (dBuV/m) – Limit (dBuV/m).

Note 3: All spurious emissions below 30MHz are more than 20 dB below the limit.

3.5.5 Transmitter Radiated Unwanted Emissions (Above 1GHz)

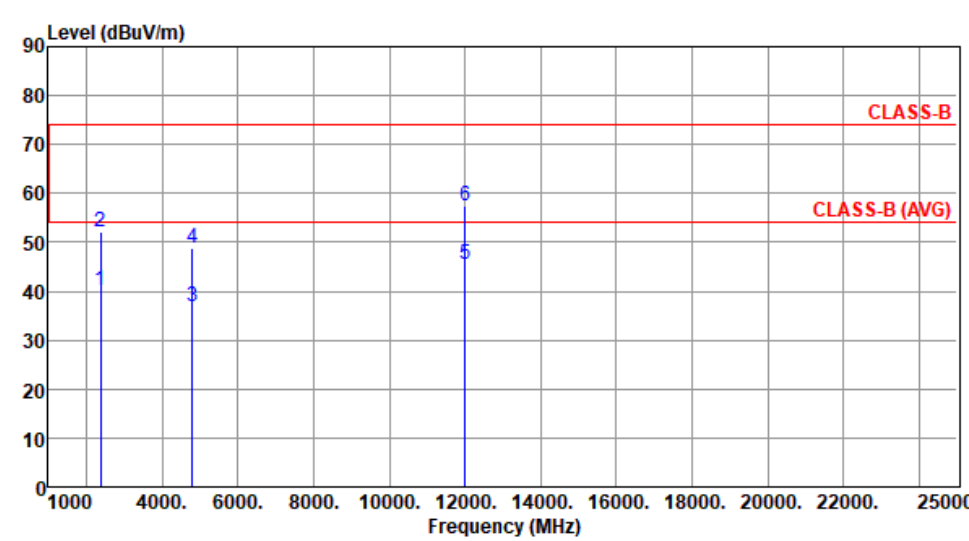
Modulation	BT-LE (1Mbps)	Test Freq. (MHz)	2402						
Polarization	Horizontal								
Test By : Akun Chung Temperature(°C): 25 Humidity(%): 64									
									
	Freq. MHz	Emission level dBuV/m	Limit dBuV/m	Margin dB	SA reading dBuV	Factor dB/m	Remark	ANT High cm	Turn Table deg
1	2390.00	40.10	54.00	-13.90	42.89	-2.79	Average	140	352
2	2390.00	52.11	74.00	-21.89	54.90	-2.79	Peak	140	352
3	4804.00	36.87	54.00	-17.13	33.37	3.50	Average	100	323
4	4804.00	48.72	74.00	-25.28	45.22	3.50	Peak	100	323
5	12010.00	45.51	54.00	-8.49	31.24	14.27	Average	100	329
6	12010.00	57.57	74.00	-16.43	43.30	14.27	Peak	100	329

Note 1: Emission Level (dBuV/m) = SA Reading (dBuV/m) + Factor* (dB)
*Factor includes antenna factor , cable loss and amplifier gain
Note 2: Margin (dB) = Emission level (dBuV/m) – Limit (dBuV/m).

Modulation	BT-LE (1Mbps)	Test Freq. (MHz)	2402
Polarization	Vertical		

Test By :Akun Chung Temperature(°C):25 Humidity(%):64

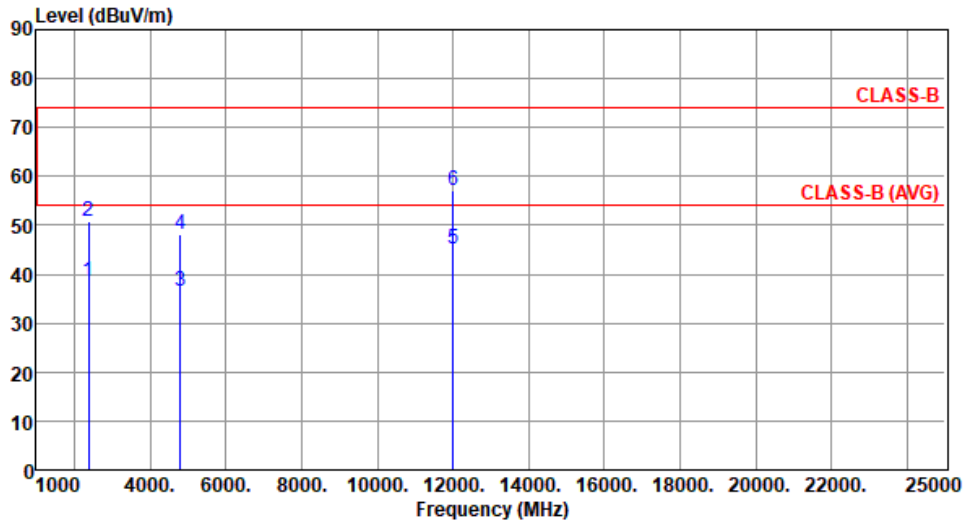

	Freq. MHz	Emission level dBuV/m	Limit dBuV/m	Margin dB	SA reading dBuV	Factor dB/m	Remark	ANT High cm	Turn Table deg
1	2390.00	38.64	54.00	-15.36	41.43	-2.79	Average	100	286
2	2390.00	50.87	74.00	-23.13	53.66	-2.79	Peak	100	286
3	4804.00	36.52	54.00	-17.48	33.02	3.50	Average	100	273
4	4804.00	48.28	74.00	-25.72	44.78	3.50	Peak	100	273
5	12010.00	45.18	54.00	-8.82	30.91	14.27	Average	100	280
6	12010.00	57.13	74.00	-16.87	42.86	14.27	Peak	100	280

Note 1: Emission Level (dBuV/m) = SA Reading (dBuV/m) + Factor* (dB)

*Factor includes antenna factor , cable loss and amplifier gain

Note 2: Margin (dB) = Emission level (dBuV/m) – Limit (dBuV/m).

Modulation	BT-LE (1Mbps)	Test Freq. (MHz)	2440
Polarization	Horizontal		

Test By : Akun Chung Temperature(°C): 25 Humidity(%): 64

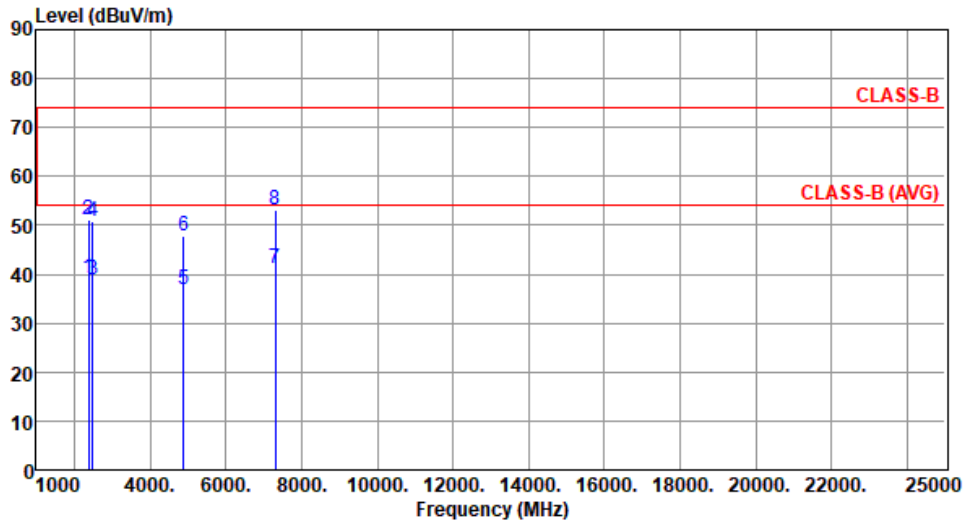

	Freq. MHz	Emission level dBuV/m	Limit dBuV/m	Margin dB	SA reading dBuV	Factor dB/m	Remark	ANT High cm	Turn Table deg
1	2390.00	39.11	54.00	-14.89	41.90	-2.79	Average	139	351
2	2390.00	51.20	74.00	-22.80	53.99	-2.79	Peak	139	351
3	2483.50	38.83	54.00	-15.17	41.57	-2.74	Average	139	351
4	2483.50	50.92	74.00	-23.08	53.66	-2.74	Peak	139	351
5	4880.00	36.93	54.00	-17.07	33.46	3.47	Average	100	332
6	4880.00	47.95	74.00	-26.05	44.48	3.47	Peak	100	332
7	7320.00	41.14	54.00	-12.86	32.12	9.02	Average	100	325
8	7320.00	53.18	74.00	-20.82	44.16	9.02	Peak	100	325

Note 1: Emission Level (dBuV/m) = SA Reading (dBuV/m) + Factor* (dB)

*Factor includes antenna factor , cable loss and amplifier gain

Note 2: Margin (dB) = Emission level (dBuV/m) – Limit (dBuV/m).

Modulation	BT-LE (1Mbps)	Test Freq. (MHz)	2440
Polarization	Vertical		

Test By : Akun Chung Temperature(°C): 25 Humidity(%): 64

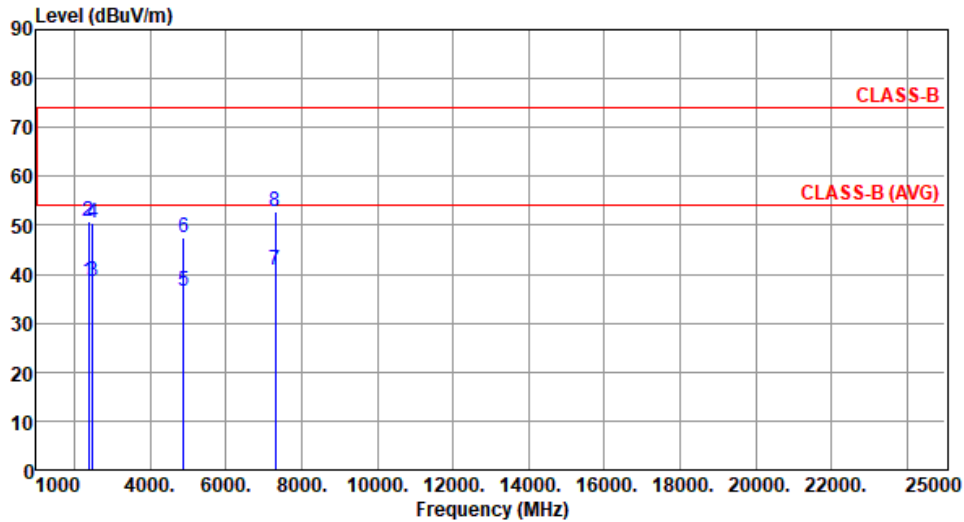

	Freq. MHz	Emission level dBuV/m	Limit dBuV/m	Margin dB	SA reading dBuV	Factor dB/m	Remark	ANT High cm	Turn Table deg
1	2390.00	38.66	54.00	-15.34	41.45	-2.79	Average	100	282
2	2390.00	50.70	74.00	-23.30	53.49	-2.79	Peak	100	282
3	2483.50	38.58	54.00	-15.42	41.32	-2.74	Average	100	282
4	2483.50	50.46	74.00	-23.54	53.20	-2.74	Peak	100	282
5	4880.00	36.47	54.00	-17.53	33.00	3.47	Average	100	275
6	4880.00	47.49	74.00	-26.51	44.02	3.47	Peak	100	275
7	7320.00	40.85	54.00	-13.15	31.83	9.02	Average	100	277
8	7320.00	52.76	74.00	-21.24	43.74	9.02	Peak	100	277

Note 1: Emission Level (dBuV/m) = SA Reading (dBuV/m) + Factor* (dB)

*Factor includes antenna factor , cable loss and amplifier gain

Note 2: Margin (dB) = Emission level (dBuV/m) – Limit (dBuV/m).

Modulation	BT-LE (1Mbps)	Test Freq. (MHz)	2480
Polarization	Horizontal		

Test By : Akun Chung Temperature(°C): 25 Humidity(%): 64

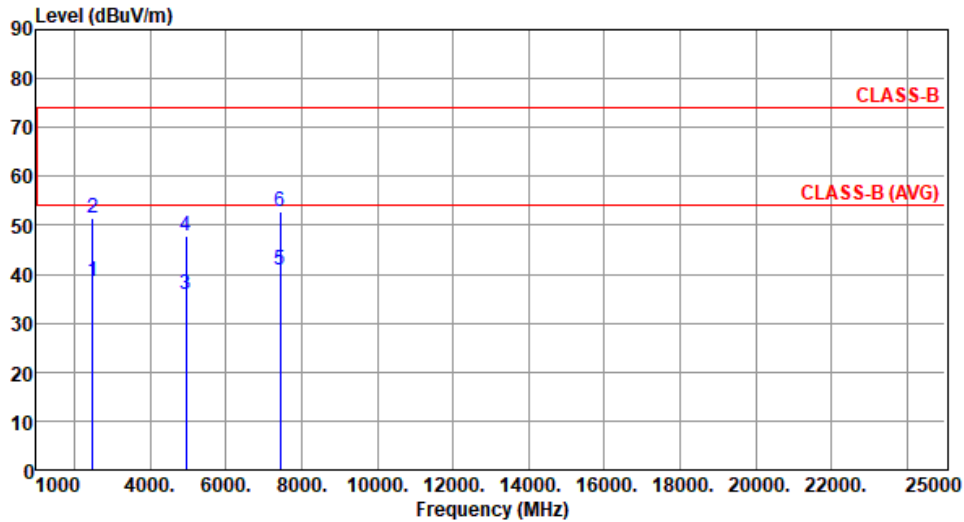

	Freq. MHz	Emission level dBuV/m	Limit dBuV/m	Margin dB	SA reading dBuV	Factor dB/m	Remark	ANT High cm	Turn Table deg
1	2483.50	38.61	54.00	-15.39	41.35	-2.74	Average	147	356
2	2483.50	51.64	74.00	-22.36	54.38	-2.74	Peak	147	356
3	4960.00	35.95	54.00	-18.05	32.27	3.68	Average	100	333
4	4960.00	47.87	74.00	-26.13	44.19	3.68	Peak	100	333
5	7440.00	40.70	54.00	-13.30	31.72	8.98	Average	100	330
6	7440.00	52.78	74.00	-21.22	43.80	8.98	Peak	100	330

Note 1: Emission Level (dBuV/m) = SA Reading (dBuV/m) + Factor* (dB)

*Factor includes antenna factor , cable loss and amplifier gain

Note 2: Margin (dB) = Emission level (dBuV/m) – Limit (dBuV/m).

Modulation	BT-LE (1Mbps)	Test Freq. (MHz)	2480
Polarization	Vertical		

Test By : Akun Chung Temperature(°C): 25 Humidity(%): 64

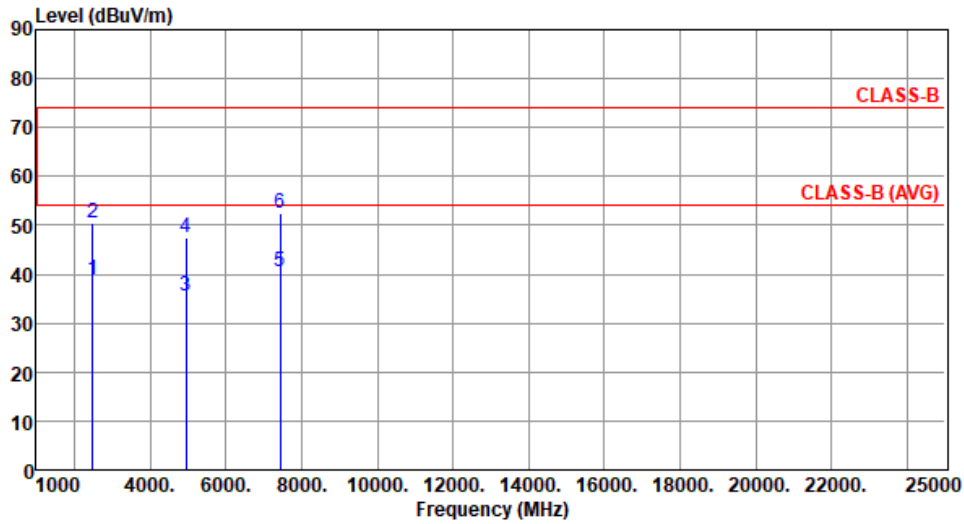

	Freq. MHz	Emission level dBuV/m	Limit dBuV/m	Margin dB	SA reading dBuV	Factor dB/m	Remark	ANT High cm	Turn Table deg
1	2483.50	38.90	54.00	-15.10	41.64	-2.74	Average	100	286
2	2483.50	50.53	74.00	-23.47	53.27	-2.74	Peak	100	286
3	4960.00	35.53	54.00	-18.47	31.85	3.68	Average	100	277
4	4960.00	47.59	74.00	-26.41	43.91	3.68	Peak	100	277
5	7440.00	40.41	54.00	-13.59	31.43	8.98	Average	100	269
6	7440.00	52.46	74.00	-21.54	43.48	8.98	Peak	100	269

Note 1: Emission Level (dBuV/m) = SA Reading (dBuV/m) + Factor* (dB)

*Factor includes antenna factor , cable loss and amplifier gain

Note 2: Margin (dB) = Emission level (dBuV/m) – Limit (dBuV/m).

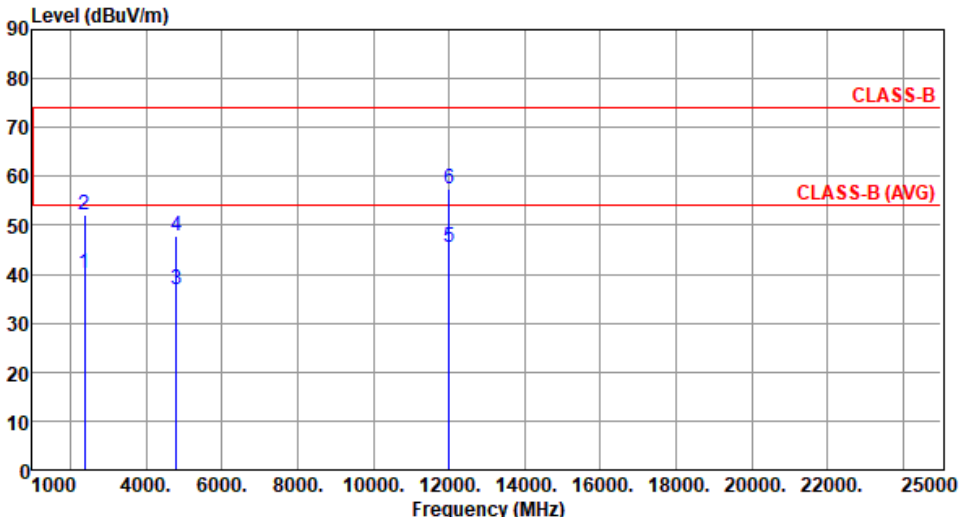
Modulation	BT-LE (2Mbps)	Test Freq. (MHz)	2402						
Polarization	Horizontal								
Test By : Akun Chung Temperature(°C): 25 Humidity(%): 64									
									
	Freq. MHz	Emission level dBuV/m	Limit dBuV/m	Margin dB	SA reading dBuV	Factor dB/m	Remark	ANT High cm	Turn Table deg
1	2390.00	40.18	54.00	-13.82	42.97	-2.79	Average	143	353
2	2390.00	52.19	74.00	-21.81	54.98	-2.79	Peak	143	353
3	4804.00	36.95	54.00	-17.05	33.45	3.50	Average	100	327
4	4804.00	47.88	74.00	-26.12	44.38	3.50	Peak	100	327
5	12010.00	45.36	54.00	-8.64	31.09	14.27	Average	100	328
6	12010.00	57.43	74.00	-16.57	43.16	14.27	Peak	100	328

Note 1: Emission Level (dBuV/m) = SA Reading (dBuV/m) + Factor* (dB)
*Factor includes antenna factor , cable loss and amplifier gain
Note 2: Margin (dB) = Emission level (dBuV/m) – Limit (dBuV/m).

Modulation	BT-LE (2Mbps)	Test Freq. (MHz)	2402
Polarization	Vertical		

Test By : Akun Chung Temperature(°C): 25 Humidity(%): 64

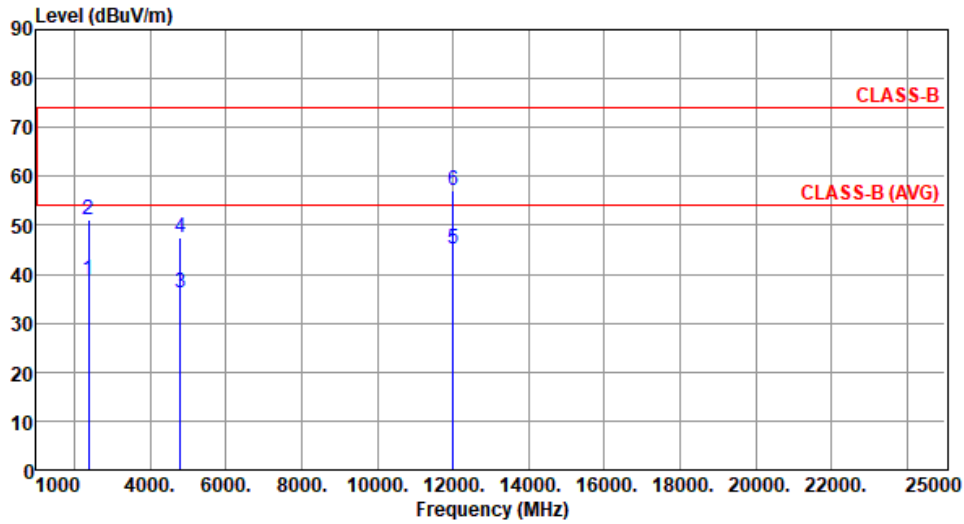

	Freq. MHz	Emission level dBuV/m	Limit dBuV/m	Margin dB	SA reading dBuV	Factor dB/m	Remark	ANT High cm	Turn Table deg
1	2390.00	38.81	54.00	-15.19	41.60	-2.79	Average	100	285
2	2390.00	51.00	74.00	-23.00	53.79	-2.79	Peak	100	285
3	4804.00	36.32	54.00	-17.68	32.82	3.50	Average	100	277
4	4804.00	47.33	74.00	-26.67	43.83	3.50	Peak	100	277
5	12010.00	45.06	54.00	-8.94	30.79	14.27	Average	100	278
6	12010.00	57.07	74.00	-16.93	42.80	14.27	Peak	100	278

Note 1: Emission Level (dBuV/m) = SA Reading (dBuV/m) + Factor* (dB)

*Factor includes antenna factor , cable loss and amplifier gain

Note 2: Margin (dB) = Emission level (dBuV/m) – Limit (dBuV/m).

Modulation	BT-LE (2Mbps)	Test Freq. (MHz)	2440
Polarization	Horizontal		

Test By : Akun Chung Temperature(°C): 25 Humidity(%): 64

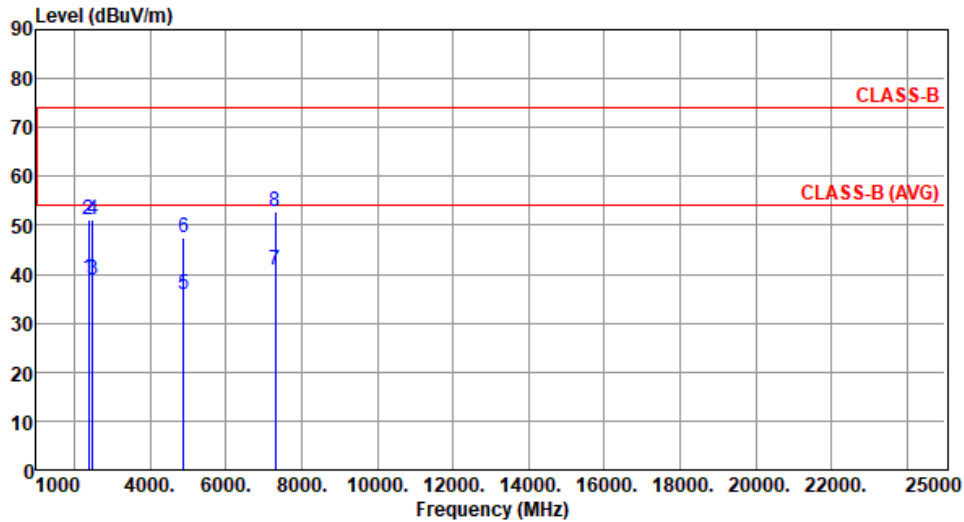

	Freq. MHz	Emission level dBuV/m	Limit dBuV/m	Margin dB	SA reading dBuV	Factor dB/m	Remark	ANT High cm	Turn Table deg
1	2390.00	39.19	54.00	-14.81	41.98	-2.79	Average	142	348
2	2390.00	51.00	74.00	-23.00	53.79	-2.79	Peak	142	348
3	2483.50	39.00	54.00	-15.00	41.74	-2.74	Average	142	348
4	2483.50	50.99	74.00	-23.01	53.73	-2.74	Peak	142	348
5	4880.00	35.76	54.00	-18.24	32.29	3.47	Average	100	320
6	4880.00	47.66	74.00	-26.34	44.19	3.47	Peak	100	320
7	7320.00	40.98	54.00	-13.02	31.96	9.02	Average	100	319
8	7320.00	52.94	74.00	-21.06	43.92	9.02	Peak	100	319

Note 1: Emission Level (dBuV/m) = SA Reading (dBuV/m) + Factor* (dB)

*Factor includes antenna factor , cable loss and amplifier gain

Note 2: Margin (dB) = Emission level (dBuV/m) – Limit (dBuV/m).

Modulation	BT-LE (2Mbps)	Test Freq. (MHz)	2440
Polarization	Vertical		

Test By : Akun Chung Temperature(°C): 25 Humidity(%): 64

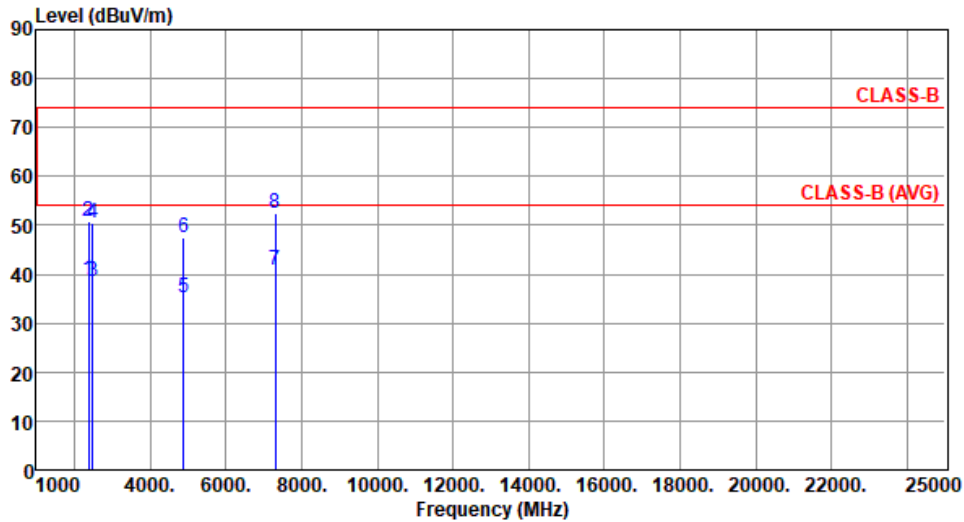

	Freq. MHz	Emission level dBuV/m	Limit dBuV/m	Margin dB	SA reading dBuV	Factor dB/m	Remark	ANT High cm	Turn Table deg
1	2390.00	38.82	54.00	-15.18	41.61	-2.79	Average	100	288
2	2390.00	50.91	74.00	-23.09	53.70	-2.79	Peak	100	288
3	2483.50	38.67	54.00	-15.33	41.41	-2.74	Average	100	288
4	2483.50	50.59	74.00	-23.41	53.33	-2.74	Peak	100	288
5	4880.00	35.26	54.00	-18.74	31.79	3.47	Average	100	273
6	4880.00	47.39	74.00	-26.61	43.92	3.47	Peak	100	273
7	7320.00	40.68	54.00	-13.32	31.66	9.02	Average	100	271
8	7320.00	52.61	74.00	-21.39	43.59	9.02	Peak	100	271

Note 1: Emission Level (dBuV/m) = SA Reading (dBuV/m) + Factor* (dB)

*Factor includes antenna factor , cable loss and amplifier gain

Note 2: Margin (dB) = Emission level (dBuV/m) – Limit (dBuV/m).

Modulation	BT-LE (2Mbps)	Test Freq. (MHz)	2480
Polarization	Horizontal		

Test By :Akun Chung Temperature(°C):25 Humidity(%):64

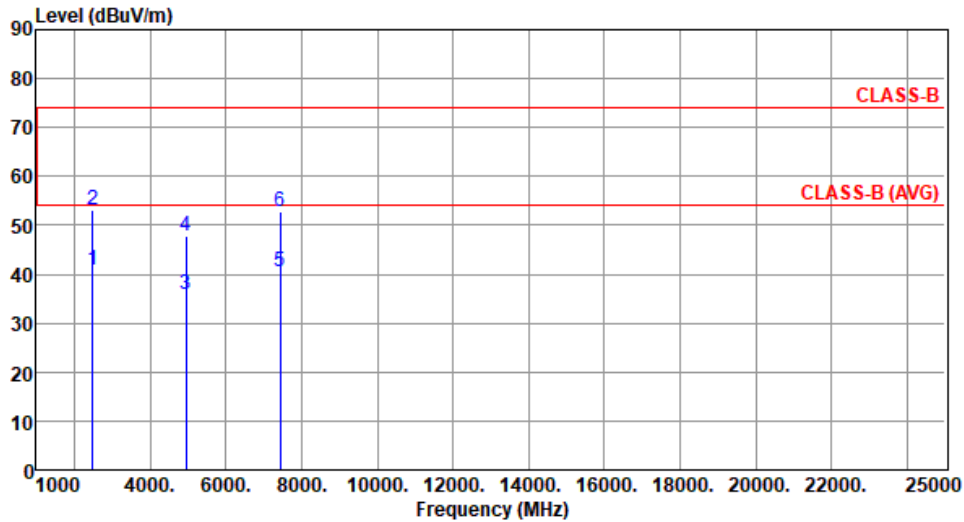

	Freq. MHz	Emission level dBuV/m	Limit dBuV/m	Margin dB	SA reading dBuV	Factor dB/m	Remark	ANT High cm	Turn Table deg
1	2483.50	40.99	54.00	-13.01	43.73	-2.74	Average	100	339
2	2483.50	53.02	74.00	-20.98	55.76	-2.74	Peak	100	339
3	4960.00	35.81	54.00	-18.19	32.13	3.68	Average	100	332
4	4960.00	47.77	74.00	-26.23	44.09	3.68	Peak	100	332
5	7440.00	40.60	54.00	-13.40	31.62	8.98	Average	100	337
6	7440.00	52.72	74.00	-21.28	43.74	8.98	Peak	100	337

Note 1: Emission Level (dBuV/m) = SA Reading (dBuV/m) + Factor* (dB)

*Factor includes antenna factor , cable loss and amplifier gain

Note 2: Margin (dB) = Emission level (dBuV/m) – Limit (dBuV/m).

Modulation	BT-LE (2Mbps)	Test Freq. (MHz)	2480
Polarization	Vertical		

Test By : Akun Chung Temperature(°C): 25 Humidity(%): 64

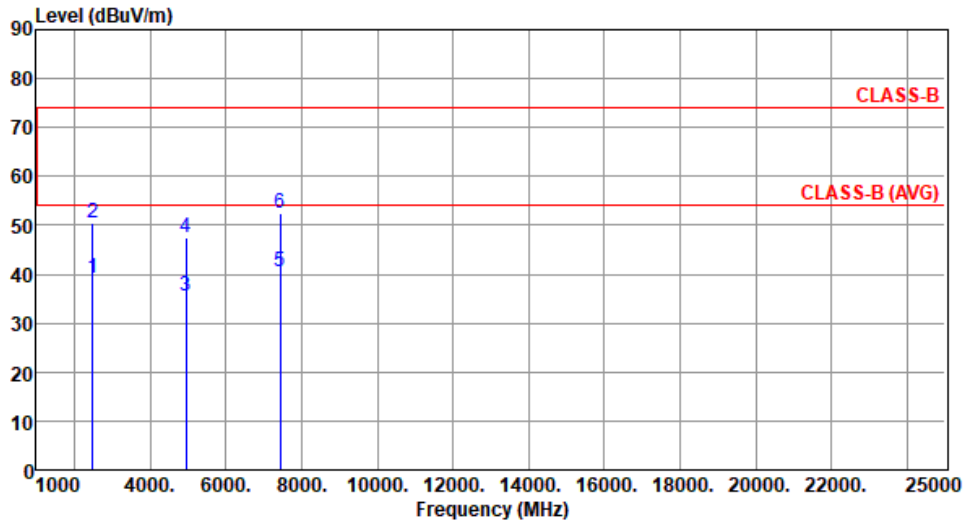

	Freq. MHz	Emission level dBuV/m	Limit dBuV/m	Margin dB	SA reading dBuV	Factor dB/m	Remark	ANT High cm	Turn Table deg
1	2483.50	39.09	54.00	-14.91	41.83	-2.74	Average	100	279
2	2483.50	50.62	74.00	-23.38	53.36	-2.74	Peak	100	279
3	4960.00	35.47	54.00	-18.53	31.79	3.68	Average	100	273
4	4960.00	47.54	74.00	-26.46	43.86	3.68	Peak	100	273
5	7440.00	40.49	54.00	-13.51	31.51	8.98	Average	100	268
6	7440.00	52.53	74.00	-21.47	43.55	8.98	Peak	100	268

Note 1: Emission Level (dBuV/m) = SA Reading (dBuV/m) + Factor* (dB)

*Factor includes antenna factor , cable loss and amplifier gain

Note 2: Margin (dB) = Emission level (dBuV/m) – Limit (dBuV/m).

3.6 Emissions in non-restricted Frequency Bands

3.6.1 Emissions in non-restricted frequency bands limit

Peak power in any 100 kHz bandwidth outside of the authorized frequency band shall be attenuated by at least 20 dB relative to the maximum in-band peak PSD level in 100 kHz

3.6.2 Test Procedures

Reference level measurement

1. Set RBW=100kHz, VBW = 300kHz , Detector = Peak, Sweep time = Auto
2. Trace = max hold , Allow Trace to fully stabilize
3. Use the peak marker function to determine the maximum PSD level

Emission level measurement

1. Set RBW=100kHz, VBW = 300kHz , Detector = Peak, Sweep time = Auto
2. Trace = max hold , Allow Trace to fully stabilize
3. Scan Frequency range is up to 25GHz
4. Use the peak marker function to determine the maximum amplitude level

3.6.3 Test Setup

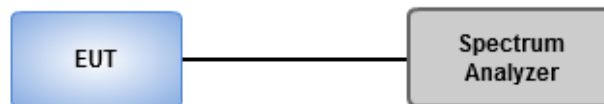

3.6.4 Test Result of Emissions in non-restricted Frequency Bands

Ambient Condition	22°C / 64%	Tested By	Aska Huang
-------------------	------------	-----------	------------

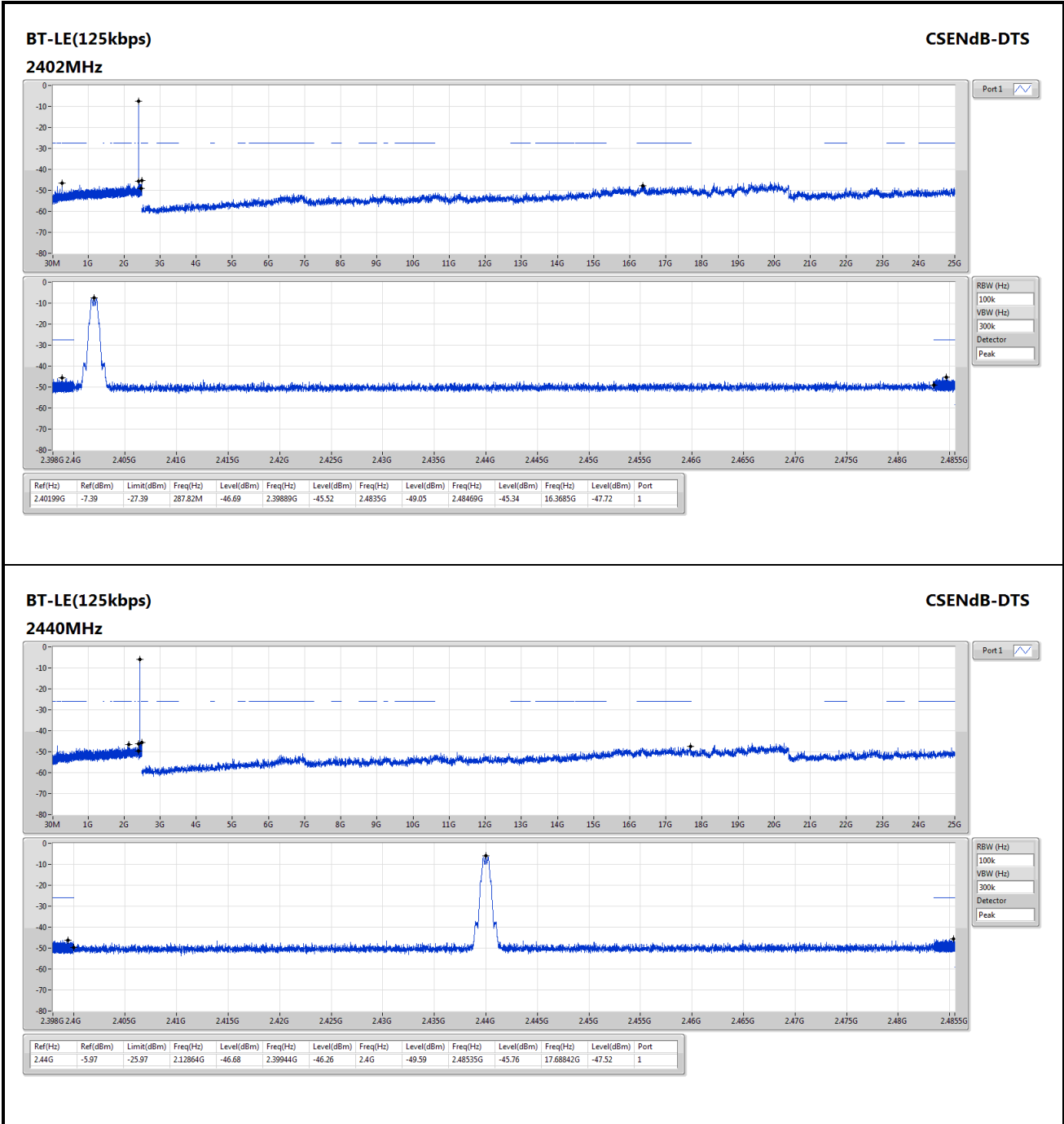

BT-LE(125kbps)
2480MHz

CSENdB-DTS

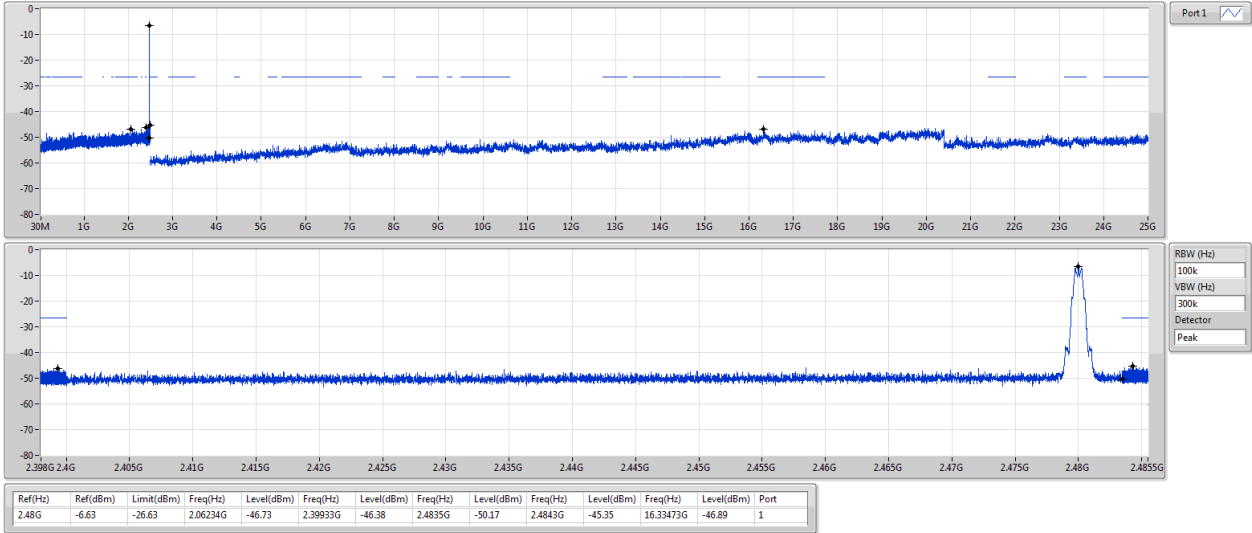

BT-LE(500kbps)
2402MHz

CSENdB-DTS

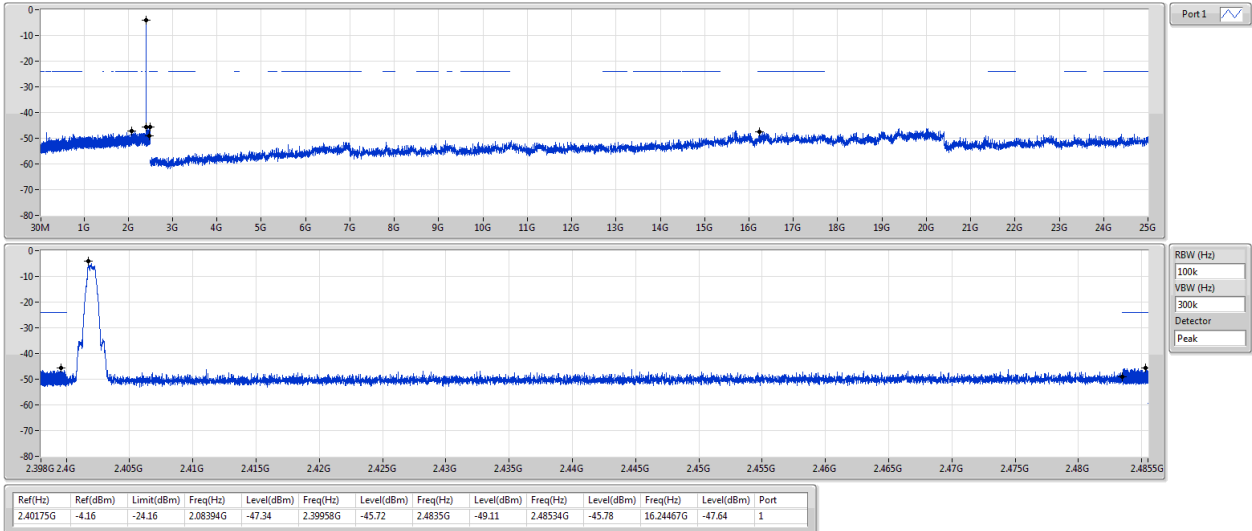

BT-LE(500kbps)
2440MHz

CSENdB-DTS

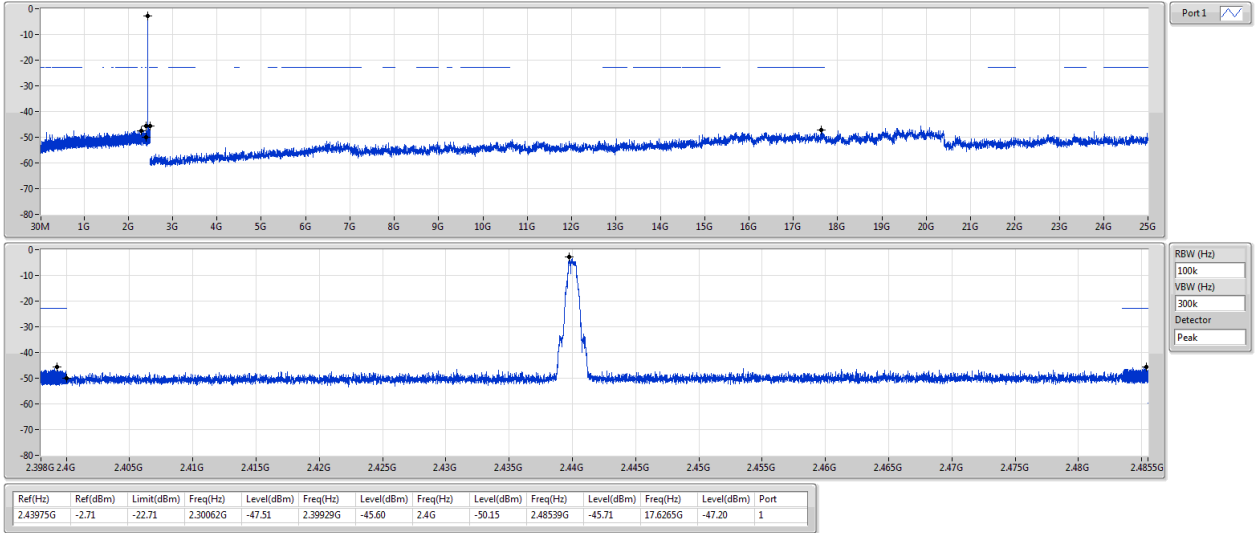

BT-LE(500kbps)
2480MHz

CSENdB-DTS

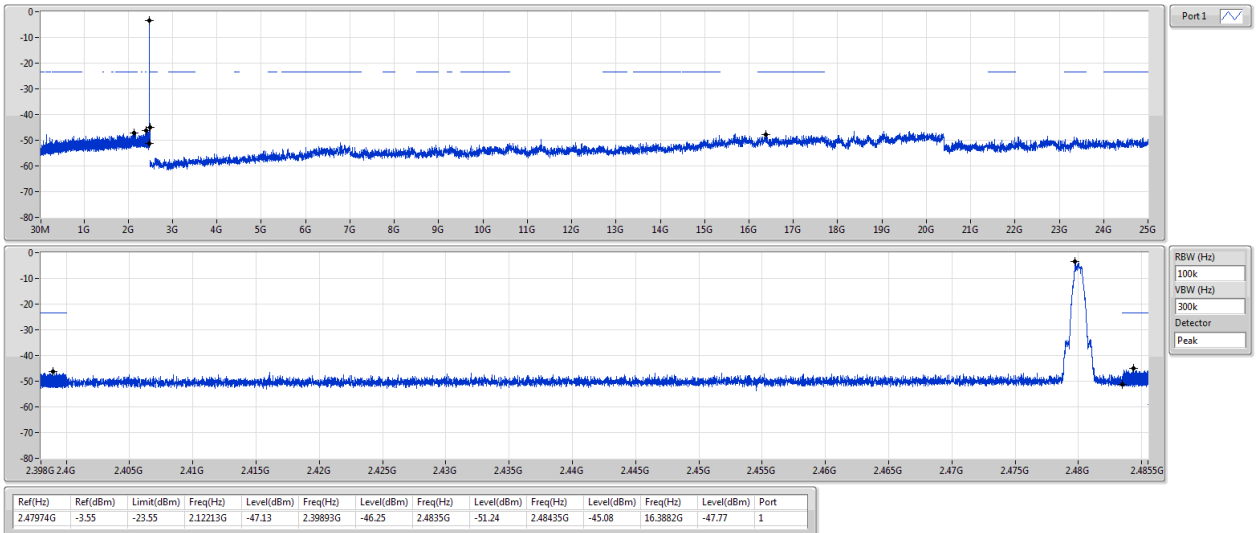

BT-LE(1Mbps)
2402MHz

CSENdB-DTS

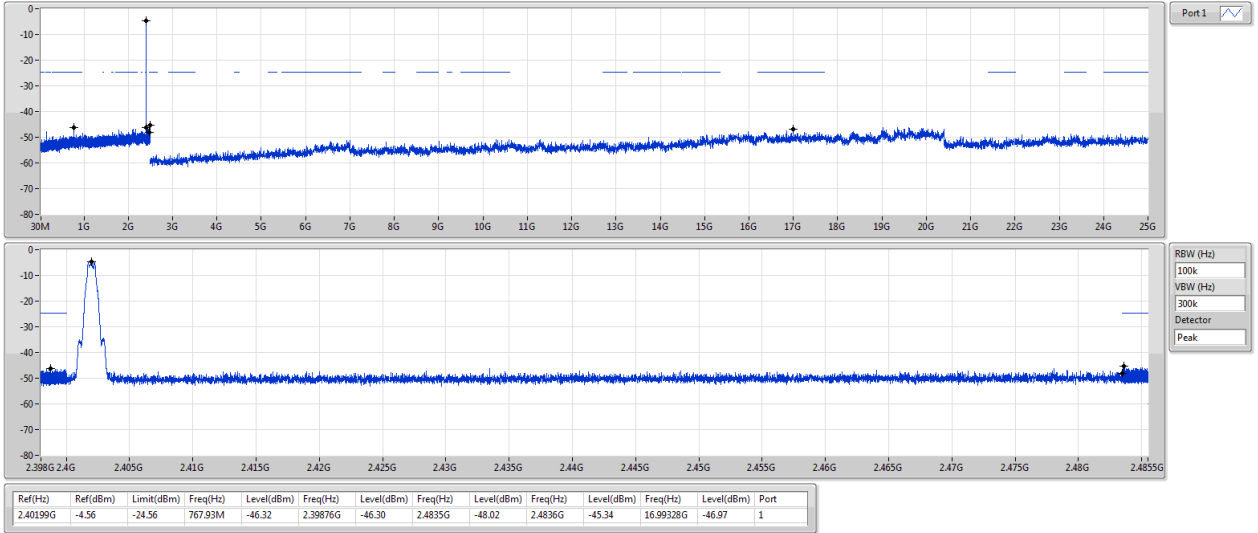

BT-LE(1Mbps)
2440MHz

CSENdB-DTS

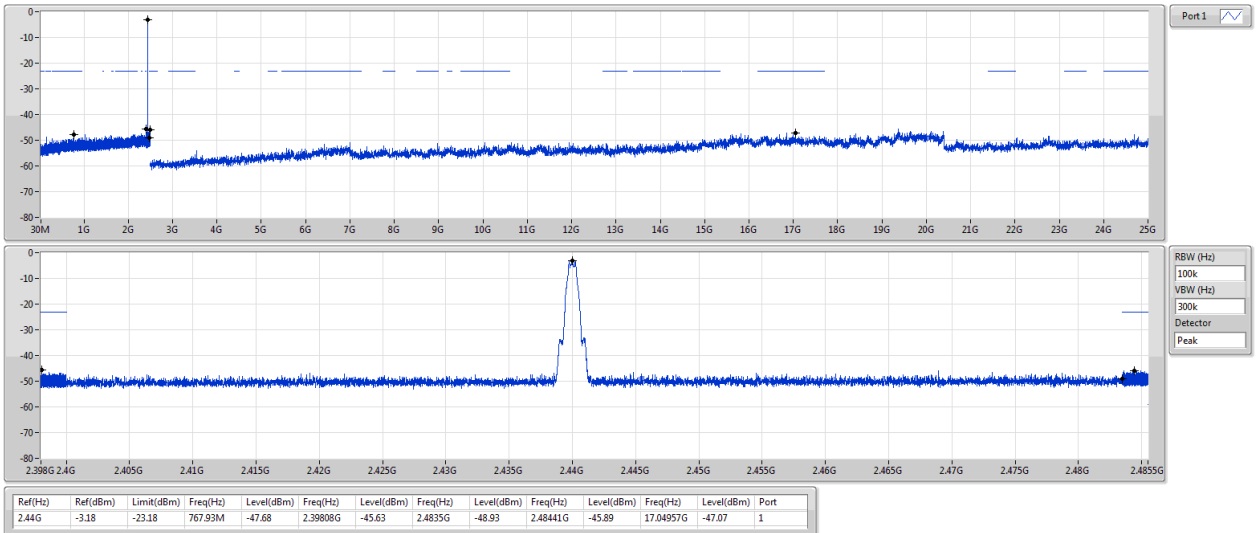

BT-LE(1Mbps)
2480MHz

CSENdB-DTS

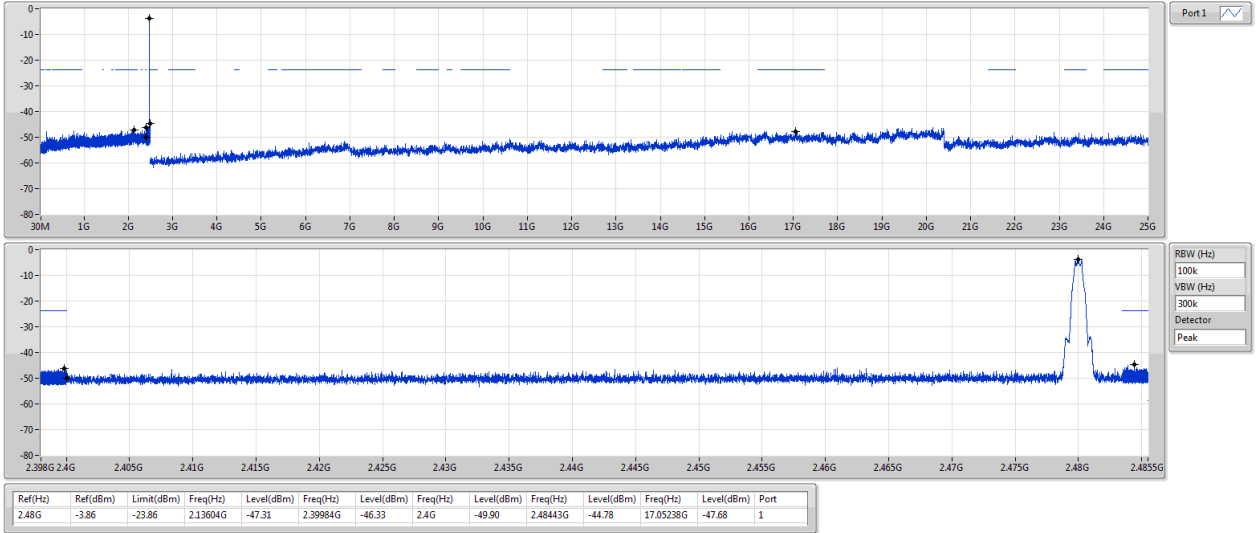

BT-LE(2Mbps)
2402MHz

CSENdB-DTS

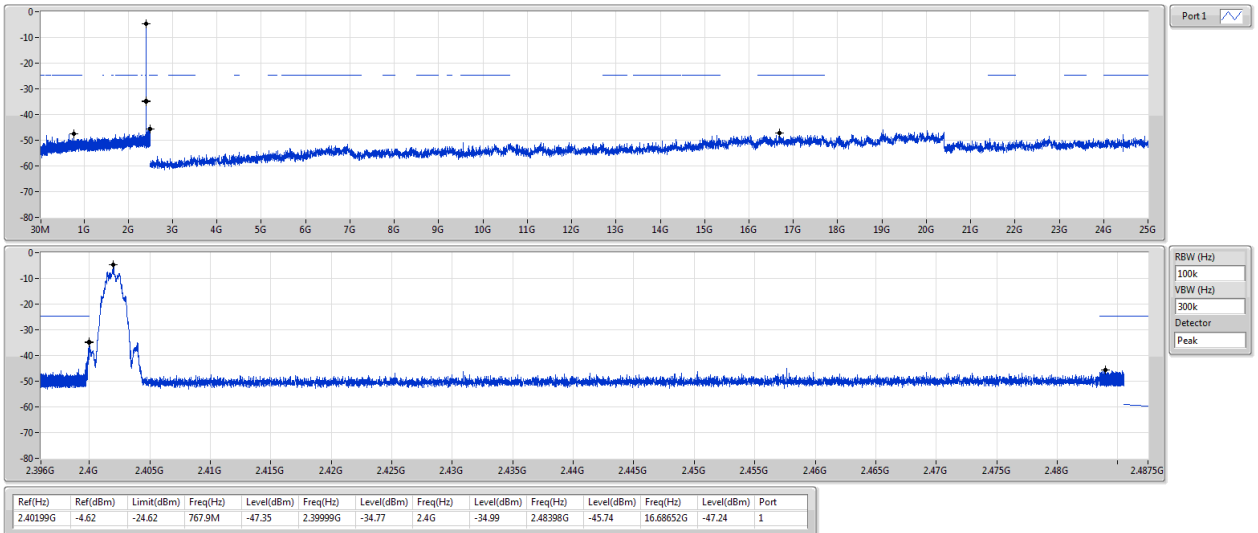

BT-LE(2Mbps)
2440MHz

CSENdB-DTS

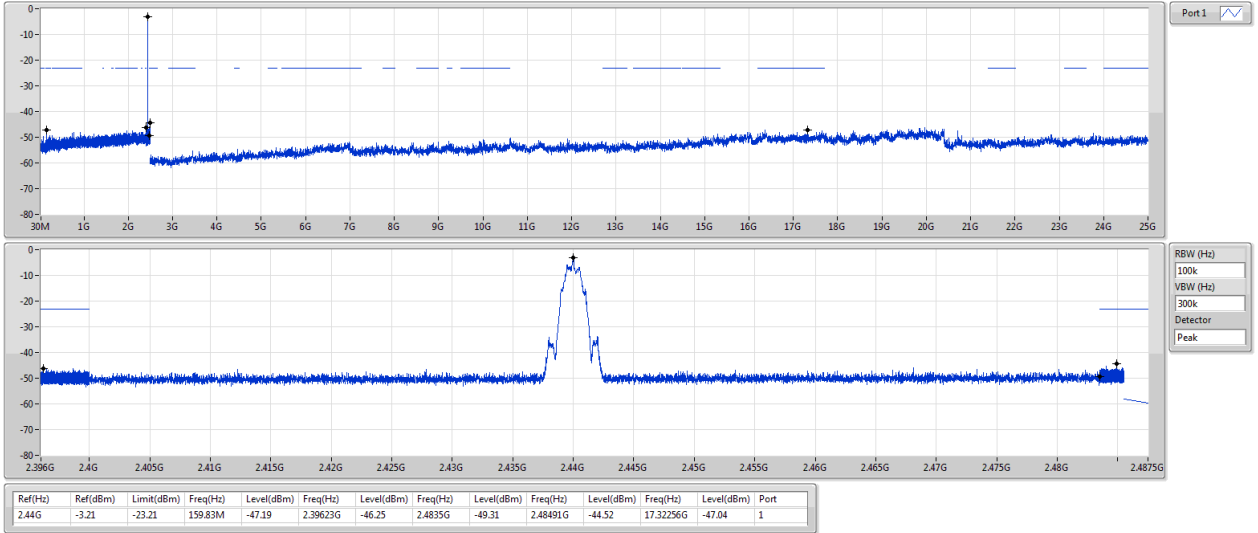

BT-LE(2Mbps)
2480MHz

CSENdB-DTS

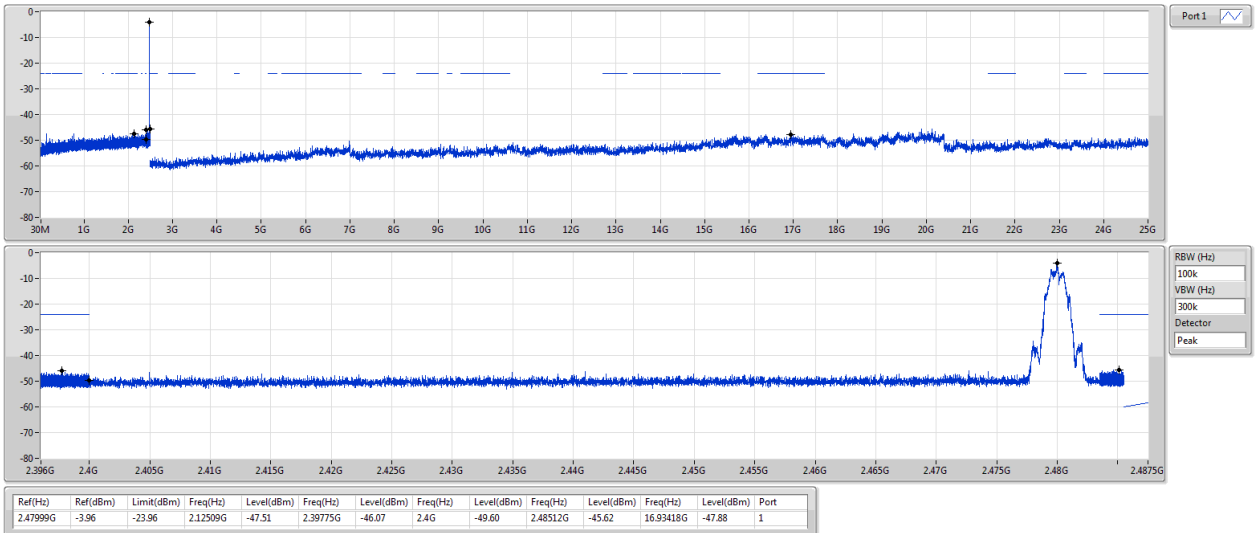

4 Test laboratory information

Established in 2012, ICC provides foremost EMC & RF Testing and advisory consultation services by our skilled engineers and technicians. Our services employ a wide variety of advanced edge test equipment and one of the widest certification extents in the business.

International Certification Corporation (EMC and Wireless Communication Laboratory), it is our definitive objective is to institute long term, trust-based associations with our clients. The expectation we set up with our clients is based on outstanding service, practical expertise and devotion to a certified value structure. Our passion is to grant our clients with best EMC / RF services by oriented knowledgeable and accommodating staff.

Our Test sites are located at Linkou District and Kwei Shan District. Location map can be found on our website <http://www.icertifi.com.tw>.

Linkou

Tel: 886-2-2601-1640

No.30-2, Ding Fwu Tsuen, Lin Kou
District, New Taipei City, Taiwan
(R.O.C.)

Kwei Shan

Tel: 886-3-271-8666

No.3-1, Lane 6, Wen San 3rd
St., Kwei Shan Dist., Tao Yuan
City 33381, Taiwan (R.O.C.)
No.2-1, Lane 6, Wen San 3rd
St., Kwei Shan Dist., Tao Yuan
City 33381, Taiwan (R.O.C.)

Kwei Shan Site II

Tel: 886-3-271-8640

No.14-1, Lane 19, Wen San 3rd
St., Kwei Shan Dist., Tao Yuan
City 333, Taiwan (R.O.C.)

If you have any suggestion, please feel free to contact us as below information.

Tel: 886-3-271-8666

Fax: 886-3-318-0345

Email: ICC_Service@icertifi.com.tw

==END==