

FCC Test Report

FCC ID : RF41539C
Equipment : Handheld Terminal
Model No. : DX-A400
Brand Name : KEYENCE
Applicant : KEYENCE CORPORATION
Address : 1-3-14 HIGASHI-NAKAJIMA,
HIGASHI-YODOGAWA-KU, OSAKA, JAPAN
Standard : 47 CFR FCC Part 15.247
Received Date : Jun. 21, 2021
Tested Date : Aug. 03 ~ Aug. 12, 2021

We, International Certification Corporation, would like to declare that the tested sample has been evaluated and in compliance with the requirement of the above standards. The test results contained in this report refer exclusively to the product. It may be duplicated completely for legal use with the approval of the applicant. It shall not be reproduced except in full without the written approval of our laboratory.

Reviewed by:



Along Chen / Assistant Manager

Approved by:



Gary Chang / Manager



Table of Contents

1	GENERAL DESCRIPTION	5
1.1	Information.....	5
1.2	Local Support Equipment List	8
1.3	Test Setup Chart	8
1.4	The Equipment List	9
1.5	Test Standards	10
1.6	Reference Guidance	10
1.7	Deviation from Test Standard and Measurement Procedure.....	10
1.8	Measurement Uncertainty	10
2	TEST CONFIGURATION	11
2.1	Testing Facility.....	11
2.2	The Worst Test Modes and Channel Details	11
3	TRANSMITTER TEST RESULTS.....	12
3.1	Conducted Emissions.....	12
3.2	6dB and Occupied Bandwidth	15
3.3	RF Output Power	21
3.4	Power Spectral Density	24
3.5	Unwanted Emissions into Restricted Frequency Bands	30
3.6	Emissions in Non-Restricted Frequency Bands.....	58
4	TEST LABORATORY INFORMATION	63

Release Record

Report No.	Version	Description	Issued Date
FR162103AC	Rev. 01	Initial issue	Nov. 16, 2021

Summary of Test Results

FCC Rules	Test Items	Measured	Result
15.207	Conducted Emissions	[dBuV]: 0.538MHz 40.48 (Margin -15.52dB) - QP	Pass
15.247(d) 15.209	Radiated Emissions	[dBuV/m at 3m]: 4874.00MHz 52.96 (Margin -1.04dB) - AV	Pass
15.247(b)(3)	Maximum Output Power	Max Power [dBm]: 22.45	Pass
15.247(a)(2)	6dB Bandwidth	Meet the requirement of limit	Pass
15.247(e)	Power Spectral Density	Meet the requirement of limit	Pass
15.203	Antenna Requirement	Meet the requirement of limit	Pass

Declaration of Conformity:

The test results with all measurement uncertainty excluded are presented in accordance with the regulation limits or requirements declared by manufacturers.

Comments and Explanations:

The declared of product specification for EUT presented in the report are provided by the manufacturer, and the manufacturer takes all the responsibilities for the accuracy of product specification.

1 General Description

1.1 Information

1.1.1 Specification of the Equipment under Test (EUT)

RF General Information					
Frequency Range (MHz)	IEEE Std. 802.11	Ch. Freq. (MHz)	Channel Number	Transmit Chains (N _{TX})	Data Rate / MCS
2400-2483.5	b	2412-2462	1-11 [11]	1	1-11 Mbps
2400-2483.5	g	2412-2462	1-11 [11]	1	6-54 Mbps
2400-2483.5	n (HT20)	2412-2462	1-11 [11]	1	MCS 0-7
2400-2483.5	n (HT40)	2422-2452	3-9 [7]	1	MCS 0-7

Note 1: RF output power specifies that Maximum Peak Conducted Output Power.
 Note 2: 802.11b uses a combination of DSSS-DBPSK, DQPSK, CCK modulation.
 Note 3: 802.11g/n uses a combination of OFDM-BPSK, QPSK, 16QAM, 64QAM modulation.

1.1.2 Antenna Details

Ant. No.	Type	Connector	Operating Frequencies (MHz) / Antenna Gain (dBi)		
			2400~2483.5	5150~5250	5250~5350
1	PIFA	No	-0.23	4.81	4.81

1.1.3 Power Supply Type of Equipment under Test (EUT)

Power Supply Type	3.8Vdc
-------------------	--------

1.1.4 Accessories

Accessories		
No.	Equipment	Description
1	Battery	Brand: KEYENCE Model: DX-BQ3 Rating: 3.8Vdc (11.51Wh) 3030mAh

1.1.5 Channel List

Frequency band (MHz)		2400~2483.5	
802.11 b / g / n HT20		802.11n HT40	
Channel	Frequency(MHz)	Channel	Frequency(MHz)
1	2412	3	2422
2	2417	4	2427
3	2422	5	2432
4	2427	6	2437
5	2432	7	2442
6	2437	8	2447
7	2442	9	2452
8	2447	---	---
9	2452	---	---
10	2457	---	---
11	2462	---	---

1.1.6 Test Tool and Duty Cycle

Test Tool	Function Test, V10		
Duty Cycle and Duty Factor	Mode	Duty Cycle (%)	Duty Factor (dB)
	11b	99.88%	0.01
	11g	97.49%	0.11
	HT20	97.31%	0.12
	HT40	94.56%	0.24

1.1.7 Power Index of Test Tool

Modulation Mode	Test Frequency (MHz)	Power Index
11b	2412	15.5
11b	2437	15.5
11b	2462	15.5
11g	2412	16.5
11g	2437	16.5
11g	2462	16.5
HT20	2412	16.5
HT20	2437	16.5
HT20	2462	16.5
HT40	2422	16
HT40	2437	16
HT40	2452	16

1.2 Local Support Equipment List

Support Equipment List					
No.	Equipment	Brand	Model	FCC ID	Remarks
1	Adapter	PHIHONG	PSA10F-050Q	---	Provided by applicant. Input: 100-240V~ 50/60Hz, 0.35A Output: 5.0V==2.0A, 10.0W

Note: Adapter is used for charging only.

1.3 Test Setup Chart

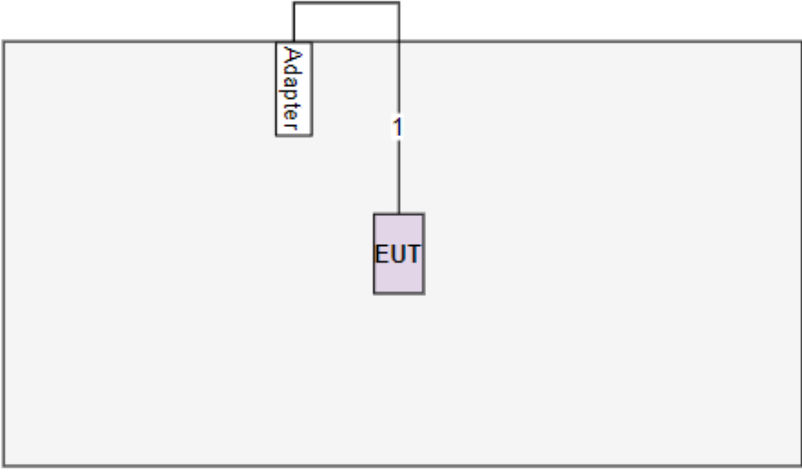
Test Setup Diagram	
	
No.	Signal cable / Length (m)
1	USB, 1m shielded. (Provided by applicant.)

1.4 The Equipment List

Test Item	Conducted Emission				
Test Site	Conduction room 1 / (CO01-WS)				
Tested Date	Aug. 12, 2021				
Instrument	Brand	Model No.	Serial No.	Calibration Date	Calibration Until
Receiver	R&S	ESR3	101658	Feb. 08, 2021	Feb. 07, 2022
LISN	R&S	ENV216	101579	Mar. 17, 2021	Mar. 16, 2022
LISN (Support Unit)	SCHWARZBECK	Schwarzbeck 8127	8127-666	Dec. 29, 2020	Dec. 28, 2021
RF Cable-CON	Woken	CFD200-NL	CFD200-NL-001	Oct. 21, 2020	Oct. 20, 2021
50 ohm terminal (Support Unit)	NA	50	04	May 25, 2021	May 24, 2022
Measurement Software	AUDIX	e3	6.120210k	NA	NA
Note: Calibration Interval of instruments listed above is one year.					

Test Item	Radiated Emission				
Test Site	966 chamber1 / (03CH01-WS)				
Tested Date	Aug. 03 ~ Aug. 04, 2021				
Instrument	Brand	Model No.	Serial No.	Calibration Date	Calibration Until
Receiver	R&S	ESR3	101657	Mar. 12, 2021	Mar. 11, 2022
Spectrum Analyzer	R&S	FSV40	101498	Dec. 04, 2020	Dec. 03, 2021
Loop Antenna	R&S	HFH2-Z2	100330	Nov. 17, 2020	Nov. 16, 2021
Bilog Antenna	SCHWARZBECK	VULB9168	VULB9168-522	Jun. 30, 2021	Jun. 29, 2022
Horn Antenna 1G-18G	SCHWARZBECK	BBHA 9120 D	BBHA 9120 D 1096	Dec. 11, 2020	Dec. 10, 2021
Horn Antenna 18G-40G	SCHWARZBECK	BBHA 9170	BBHA 9170517	Nov. 06, 2020	Nov. 05, 2021
Preamplifier	EMC	EMC02325	980225	Jun. 29, 2021	Jun. 28, 2022
Preamplifier	Agilent	83017A	MY39501308	Sep. 26, 2020	Sep. 25, 2021
Preamplifier	EMC	EMC184045B	980192	Jul. 14, 2021	Jul. 13, 2022
Loop Antenna Cable	KOAX KABEL	101354-BW	101354-BW	Oct. 06, 2020	Oct. 05, 2021
LF cable 3M	Woken	CFD400NL-LW	CFD400NL-001	Oct. 06, 2020	Oct. 05, 2021
LF cable 11M	EMC	EMCCFD400-NW-N W-11000	200801	Oct. 06, 2020	Oct. 05, 2021
LF cable 1M	EMC	EMCCFD400-NM-N M-1000	160502	Oct. 06, 2020	Oct. 05, 2021
RF Cable	HUBER+SUHNER	SUCOFLEX104	MY16019/4	Oct. 06, 2020	Oct. 05, 2021
RF Cable	HUBER+SUHNER	SUCOFLEX104	MY16014/4	Oct. 06, 2020	Oct. 05, 2021
Measurement Software	AUDIX	e3	6.120210g	NA	NA
Note: Calibration Interval of instruments listed above is one year.					

Test Item	RF Conducted				
Test Site	(TH01-WS)				
Tested Date	Aug. 10, 2021				
Instrument	Brand	Model No.	Serial No.	Calibration Date	Calibration Until
Spectrum Analyzer	R&S	FSV40	101063	Apr. 19, 2021	Apr. 18, 2022
Power Meter	Anritsu	ML2495A	1241002	Nov. 04, 2020	Nov. 03, 2021
Power Sensor	Anritsu	MA2411B	1207366	Nov. 04, 2020	Nov. 03, 2021
Measurement Software	Sporton	SENSE-15247_DTS	V5.10	NA	NA
Note: Calibration Interval of instruments listed above is one year.					

1.5 Test Standards

47 CFR FCC Part 15.247
ANSI C63.10-2013

1.6 Reference Guidance

FCC KDB 558074 D01 15.247 Meas Guidance v05r02

1.7 Deviation from Test Standard and Measurement Procedure

None

1.8 Measurement Uncertainty

The measurement uncertainties given below are based on a 95% confidence level (based on a coverage factor (k=2)).

Measurement Uncertainty	
Parameters	Uncertainty
Bandwidth	±34.130 Hz
Conducted power	±0.808 dB
Power density	±0.583 dB
Conducted emission	±2.715 dB
AC conducted emission	±2.92 dB
Radiated emission ≤ 1GHz	±3.41 dB
Radiated emission > 1GHz	±4.59 dB

2 Test Configuration

2.1 Testing Facility

Test Laboratory	International Certification Corporation
Test Site	CO01-WS, 03CH01-WS, TH01-WS
Address of Test Site	No.3-1, Lane 6, Wen San 3rd St., Kwei Shan Dist., Tao Yuan City 33381, Taiwan (R.O.C.)

- FCC Designation No.: TW2732
- FCC site registration No.: 181692
- ISED#: 10807A
- CAB identifier: TW2732

2.2 The Worst Test Modes and Channel Details

Test item	Modulation Mode	Test Frequency (MHz)	Data Rate	Test Configuration
Conducted Emissions	11g	2437	6 Mbps	---
Radiated Emissions ≤1GHz	11g	2437	6 Mbps	---
Radiated Emissions >1GHz	11b	2412 / 2437 / 2462	1 Mbps	---
Maximum Output Power	11g	2412 / 2437 / 2462	6 Mbps	
6dB bandwidth	HT20	2412 / 2437 / 2462	MCS 0	
Power spectral density	HT40	2422 / 2437 / 2452	MCS 0	

NOTE:

1. The EUT was pretested with 3 orientations placed on the table for the radiated emission measurement – X, Y, and Z-plane. The **X-plane** results were found as the worst case and were shown in this report.

3 Transmitter Test Results

3.1 Conducted Emissions

3.1.1 Limit of Conducted Emissions

Conducted Emissions Limit		
Frequency Emission (MHz)	Quasi-Peak	Average
0.15-0.5	66 - 56 *	56 - 46 *
0.5-5	56	46
5-30	60	50

Note 1: * Decreases with the logarithm of the frequency.

3.1.2 Test Procedures

1. The device is placed on a test table, raised 80 cm above the reference ground plane. The vertical conducting plane is located 40 cm to the rear of the device.
2. The device is connected to line impedance stabilization network (LISN) and other accessories are connected to other LISN. Measured levels of AC power line conducted emission are across the 50 Ω LISN port.
3. AC conducted emission measurements is made over frequency range from 150 kHz to 30 MHz.
4. This measurement was performed with AC 120V / 60Hz.

3.1.3 Test Setup



Note: 1. Support units were connected to second LISN.

2. Both of LISNs (AMN) are 80 cm from EUT and at least 80 cm from other units and other metal planes

3.1.4 Test Result of Conducted Emissions

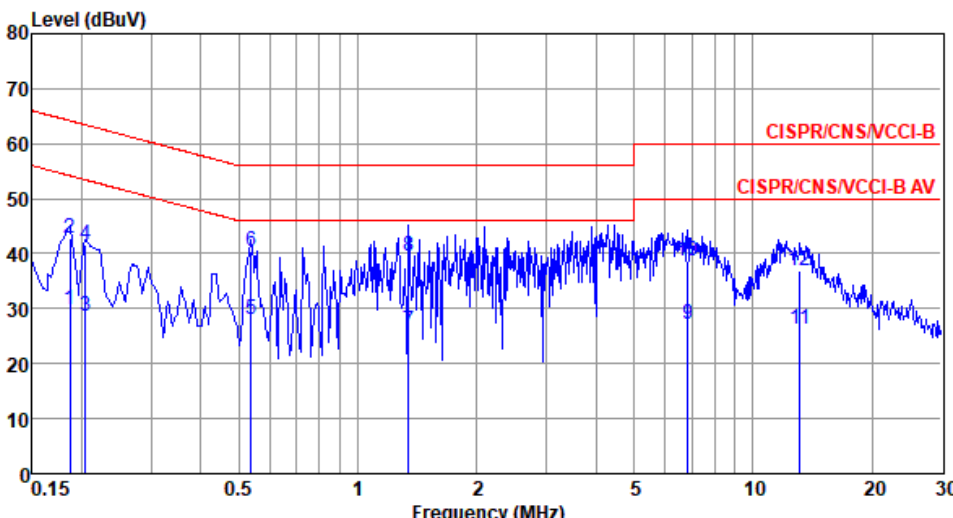
Modulation	11g	Test Freq. (MHz)	2437																																																																																																																					
Power Phase	Line																																																																																																																							
<p>Test by : Joe Liao Temperature: 22°C Humidity: 68%</p>																																																																																																																								
																																																																																																																								
<table border="1"> <thead> <tr> <th></th> <th>Freq MHz</th> <th>Level dBuA</th> <th>Limit Line dBuA</th> <th>Over Limit dB</th> <th>Read Level dBuA</th> <th>Factor dB</th> <th>Cable loss dB</th> <th>Remark</th> </tr> </thead> <tbody> <tr><td>1</td><td>0.186</td><td>29.93</td><td>54.20</td><td>-24.27</td><td>20.03</td><td>9.84</td><td>0.06</td><td>Average</td></tr> <tr><td>2</td><td>0.186</td><td>42.72</td><td>64.20</td><td>-21.48</td><td>32.82</td><td>9.84</td><td>0.06</td><td>QP</td></tr> <tr><td>3</td><td>0.204</td><td>28.73</td><td>53.45</td><td>-24.72</td><td>18.83</td><td>9.84</td><td>0.06</td><td>Average</td></tr> <tr><td>4</td><td>0.204</td><td>41.69</td><td>63.45</td><td>-21.76</td><td>31.79</td><td>9.84</td><td>0.06</td><td>QP</td></tr> <tr><td>5</td><td>0.538</td><td>28.06</td><td>46.00</td><td>-17.94</td><td>18.05</td><td>9.92</td><td>0.09</td><td>Average</td></tr> <tr><td>6*</td><td>0.538</td><td>40.48</td><td>56.00</td><td>-15.52</td><td>30.47</td><td>9.92</td><td>0.09</td><td>QP</td></tr> <tr><td>7</td><td>1.345</td><td>25.84</td><td>46.00</td><td>-20.16</td><td>15.70</td><td>9.99</td><td>0.15</td><td>Average</td></tr> <tr><td>8</td><td>1.345</td><td>39.47</td><td>56.00</td><td>-16.53</td><td>29.33</td><td>9.99</td><td>0.15</td><td>QP</td></tr> <tr><td>9</td><td>6.841</td><td>27.20</td><td>50.00</td><td>-22.80</td><td>16.77</td><td>10.08</td><td>0.35</td><td>Average</td></tr> <tr><td>10</td><td>6.841</td><td>38.71</td><td>60.00</td><td>-21.29</td><td>28.28</td><td>10.08</td><td>0.35</td><td>QP</td></tr> <tr><td>11</td><td>13.127</td><td>26.23</td><td>50.00</td><td>-23.77</td><td>15.53</td><td>10.17</td><td>0.53</td><td>Average</td></tr> <tr><td>12</td><td>13.127</td><td>36.79</td><td>60.00</td><td>-23.21</td><td>26.09</td><td>10.17</td><td>0.53</td><td>QP</td></tr> </tbody> </table>					Freq MHz	Level dBuA	Limit Line dBuA	Over Limit dB	Read Level dBuA	Factor dB	Cable loss dB	Remark	1	0.186	29.93	54.20	-24.27	20.03	9.84	0.06	Average	2	0.186	42.72	64.20	-21.48	32.82	9.84	0.06	QP	3	0.204	28.73	53.45	-24.72	18.83	9.84	0.06	Average	4	0.204	41.69	63.45	-21.76	31.79	9.84	0.06	QP	5	0.538	28.06	46.00	-17.94	18.05	9.92	0.09	Average	6*	0.538	40.48	56.00	-15.52	30.47	9.92	0.09	QP	7	1.345	25.84	46.00	-20.16	15.70	9.99	0.15	Average	8	1.345	39.47	56.00	-16.53	29.33	9.99	0.15	QP	9	6.841	27.20	50.00	-22.80	16.77	10.08	0.35	Average	10	6.841	38.71	60.00	-21.29	28.28	10.08	0.35	QP	11	13.127	26.23	50.00	-23.77	15.53	10.17	0.53	Average	12	13.127	36.79	60.00	-23.21	26.09	10.17	0.53	QP
	Freq MHz	Level dBuA	Limit Line dBuA	Over Limit dB	Read Level dBuA	Factor dB	Cable loss dB	Remark																																																																																																																
1	0.186	29.93	54.20	-24.27	20.03	9.84	0.06	Average																																																																																																																
2	0.186	42.72	64.20	-21.48	32.82	9.84	0.06	QP																																																																																																																
3	0.204	28.73	53.45	-24.72	18.83	9.84	0.06	Average																																																																																																																
4	0.204	41.69	63.45	-21.76	31.79	9.84	0.06	QP																																																																																																																
5	0.538	28.06	46.00	-17.94	18.05	9.92	0.09	Average																																																																																																																
6*	0.538	40.48	56.00	-15.52	30.47	9.92	0.09	QP																																																																																																																
7	1.345	25.84	46.00	-20.16	15.70	9.99	0.15	Average																																																																																																																
8	1.345	39.47	56.00	-16.53	29.33	9.99	0.15	QP																																																																																																																
9	6.841	27.20	50.00	-22.80	16.77	10.08	0.35	Average																																																																																																																
10	6.841	38.71	60.00	-21.29	28.28	10.08	0.35	QP																																																																																																																
11	13.127	26.23	50.00	-23.77	15.53	10.17	0.53	Average																																																																																																																
12	13.127	36.79	60.00	-23.21	26.09	10.17	0.53	QP																																																																																																																
<p>Note 1: Level (dBuV) = Read Level (dBuV) + LISN Factor (dB) + Cable Loss (dB). Note 2: Over Limit (dB) = Level (dBuV) – Limit Line (dBuV).</p>																																																																																																																								

Modulation	11g	Test Freq. (MHz)	2437
Power Phase	Neutral		

Test by : Joe Liao Temperature: 22°C Humidity: 68%

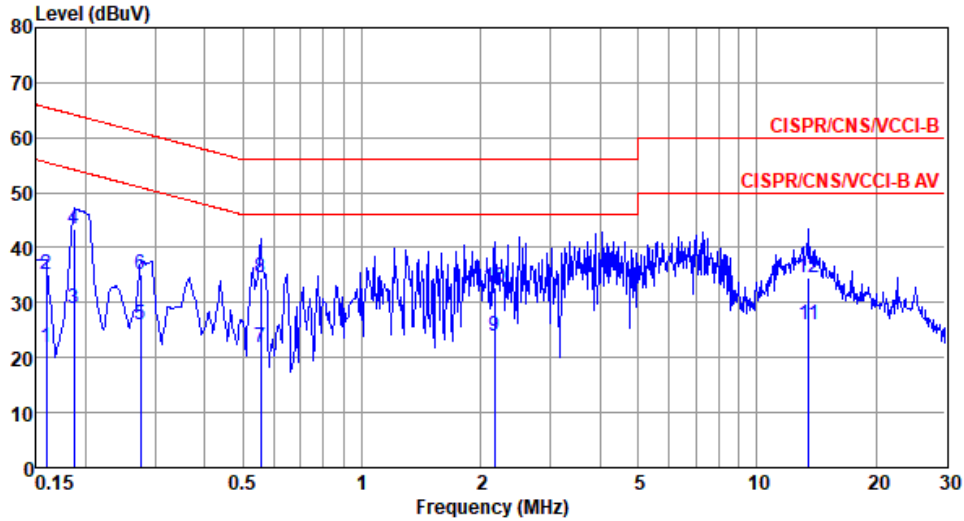

	Freq MHz	Level dBuA	Limit Line dBuA	Over Limit dB	Read Level dBuA	Factor dB	Cable loss dB	Remark
1	0.159	21.94	55.52	-33.58	12.07	9.82	0.05	Average
2	0.159	35.03	65.52	-30.49	25.16	9.82	0.05	QP
3	0.186	29.01	54.20	-25.19	19.12	9.83	0.06	Average
4*	0.186	43.52	64.20	-20.68	33.63	9.83	0.06	QP
5	0.276	25.97	50.94	-24.97	16.06	9.84	0.07	Average
6	0.276	35.02	60.94	-25.92	25.11	9.84	0.07	QP
7	0.555	21.81	46.00	-24.19	11.86	9.86	0.09	Average
8	0.555	34.54	56.00	-21.46	24.59	9.86	0.09	QP
9	2.167	23.79	46.00	-22.21	13.65	9.95	0.19	Average
10	2.167	32.66	56.00	-23.34	22.52	9.95	0.19	QP
11	13.551	25.83	50.00	-24.17	15.09	10.19	0.55	Average
12	13.551	34.41	60.00	-25.59	23.67	10.19	0.55	QP

Note 1: Level (dBuV) = Read Level (dBuV) + LISN Factor (dB) + Cable Loss (dB).
 Note 2: Over Limit (dB) = Level (dBuV) – Limit Line (dBuV).

3.2 6dB and Occupied Bandwidth

3.2.1 Limit of 6dB Bandwidth

The minimum 6dB bandwidth shall be at least 500 kHz.

3.2.2 Test Procedures

6dB Bandwidth

1. Set resolution bandwidth (RBW) = 100 kHz, Video bandwidth = 300 kHz.
2. Detector = Peak, Trace mode = max hold.
3. Sweep = auto couple, Allow the trace to stabilize.
4. Measure the maximum width of the emission that is constrained by the frequencies associated with the two outermost amplitude points (upper and lower) that are attenuated by 6dB relative to the maximum level measured in the fundamental emission.

Occupied Bandwidth

1. Set resolution bandwidth (RBW) = 1% ~ 5 % of OBW, Video bandwidth = 3 x RBW
2. Detector = Sample, Trace mode = max hold.
3. Sweep = auto couple, Allow the trace to stabilize.
4. Use the OBW measurement function of spectrum analyzer to measure the occupied bandwidth.

3.2.3 Test Setup



3.2.4 Test Result of 6dB and Occupied Bandwidth

Ambient Condition	22°C / 64%	Tested By	Aska Huang
--------------------------	------------	------------------	------------

Summary

Mode	Max-N dB (Hz)	Max-OBW (Hz)	ITU-Code	Min-N dB (Hz)	Min-OBW (Hz)
2.4-2.4835GHz	-	-	-	-	-
802.11b_Nss1,(1Mbps)_1TX	8.043M	12.88M	12M9G1D	7.609M	12.663M
802.11g_Nss1,(6Mbps)_1TX	15.652M	20.26M	20M3D1D	14.783M	16.425M
802.11n HT20_Nss1,(MCS0)_1TX	16.087M	21.201M	21M2D1D	13.478M	17.511M
802.11n HT40_Nss1,(MCS0)_1TX	35.072M	36.035M	36M0D1D	28.841M	35.745M

Max-N dB = Maximum 6dB down bandwidth; **Max-OBW** = Maximum 99% occupied bandwidth;
Min-N dB = Minimum 6dB down bandwidth; **Min-OBW** = Minimum 99% occupied bandwidth;

Result

Mode	Result	Limit (Hz)	Port 1-N dB (Hz)	Port 1-OBW (Hz)
802.11b_Nss1,(1Mbps)_1TX	-	-	-	-
2412MHz	Pass	500k	7.609M	12.88M
2437MHz	Pass	500k	8.043M	12.808M
2462MHz	Pass	500k	7.609M	12.663M
802.11g_Nss1,(6Mbps)_1TX	-	-	-	-
2412MHz	Pass	500k	14.783M	20.26M
2437MHz	Pass	500k	15.652M	16.498M
2462MHz	Pass	500k	15.072M	16.425M
802.11n HT20_Nss1,(MCS0)_1TX	-	-	-	-
2412MHz	Pass	500k	13.478M	21.201M
2437MHz	Pass	500k	16.087M	17.583M
2462MHz	Pass	500k	13.841M	17.511M
802.11n HT40_Nss1,(MCS0)_1TX	-	-	-	-
2422MHz	Pass	500k	28.841M	35.745M
2437MHz	Pass	500k	32.754M	36.035M
2452MHz	Pass	500k	35.072M	36.035M

Port X-N dB = Port X 6dB down bandwidth; **Port X-OBW** = Port X 99% occupied bandwidth;

802.11b_Nss1,(1Mbps)_1TX

EBW

2412MHz

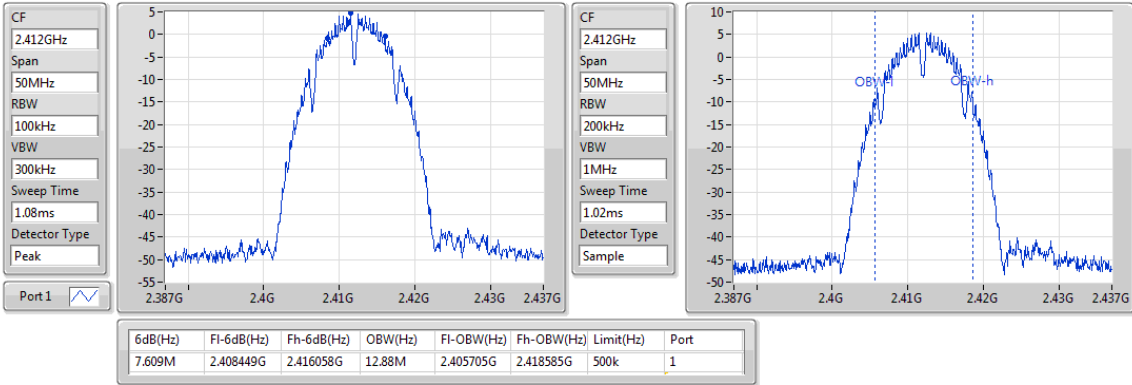

802.11b_Nss1,(1Mbps)_1TX

EBW

2437MHz

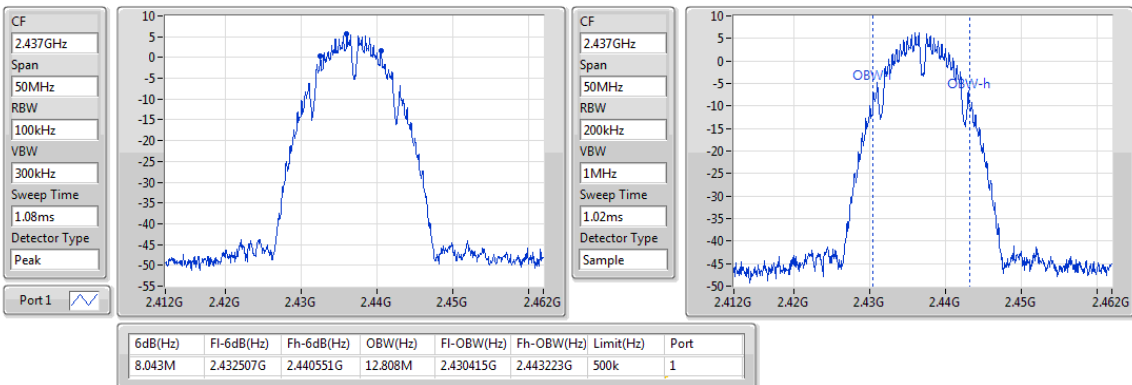

802.11b_Nss1,(1Mbps)_1TX

EBW

2462MHz

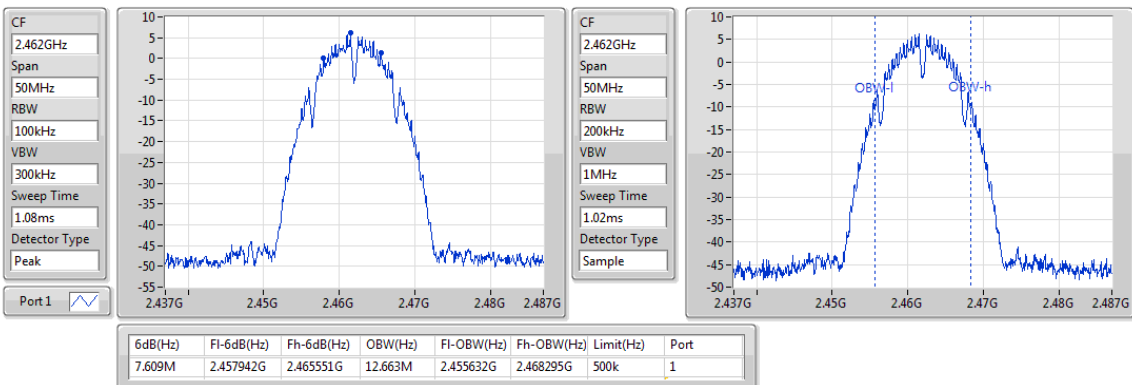

802.11g_Nss1,(6Mbps)_1TX

EBW

2412MHz

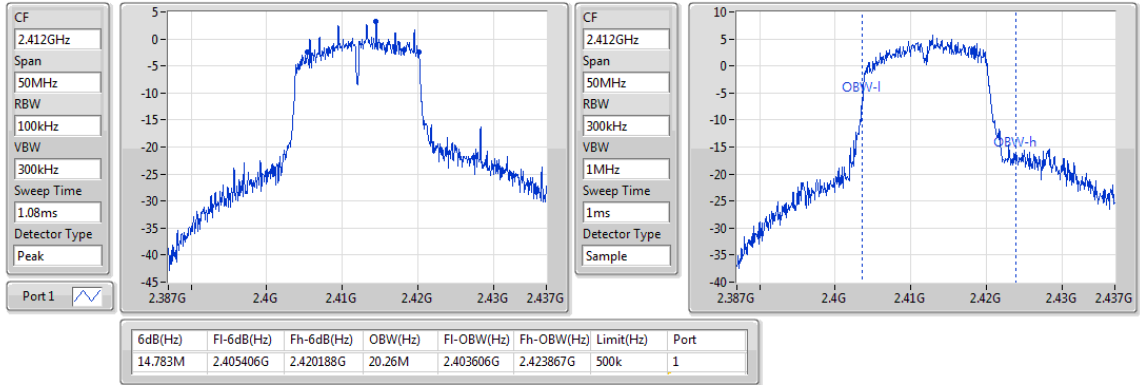

802.11g_Nss1,(6Mbps)_1TX

EBW

2437MHz

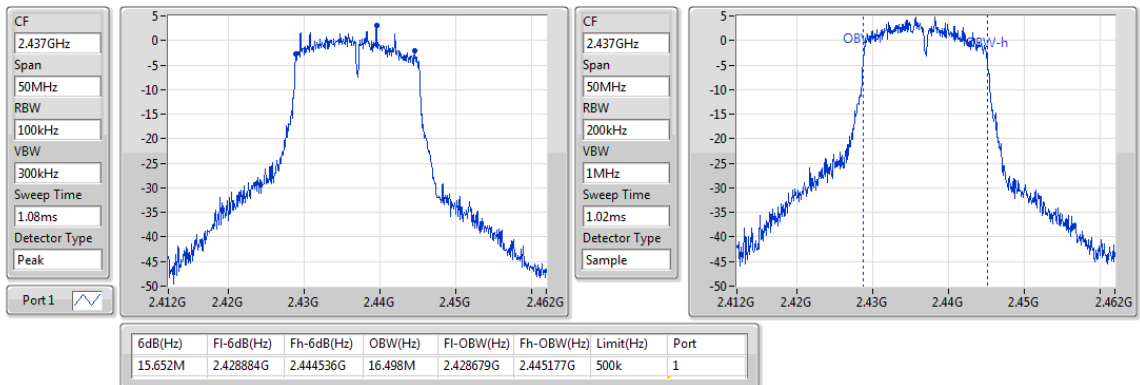

802.11g_Nss1,(6Mbps)_1TX

EBW

2462MHz

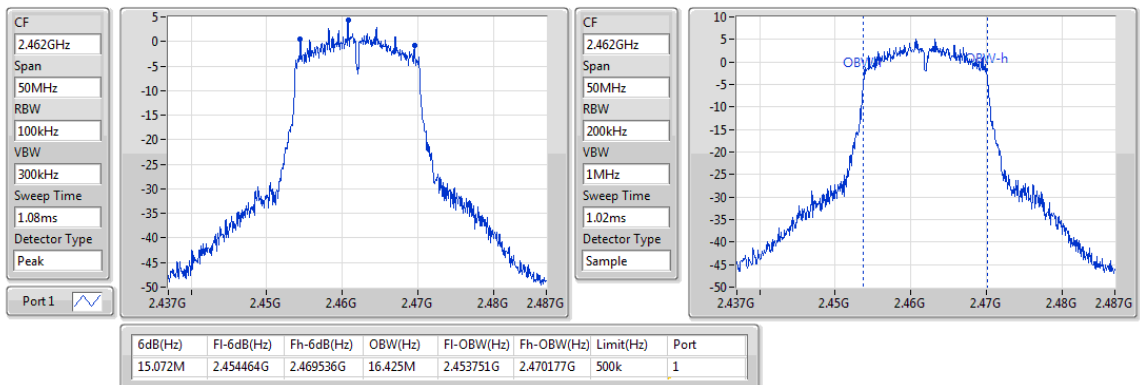

802.11n HT20_Nss1,(MCS0)_1TX

EBW

2412MHz

CF
2.412GHz
Span
50MHz
RBW
100kHz
VBW
300kHz
Sweep Time
1.08ms
Detector Type
Peak
Port 1

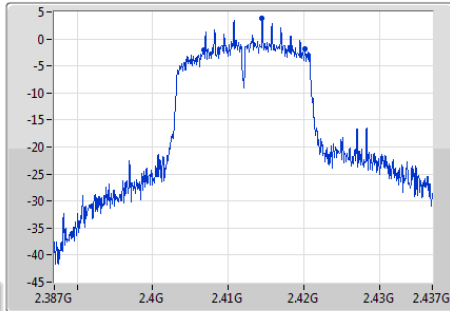

CF
2.412GHz
Span
50MHz
RBW
300kHz
VBW
1MHz
Sweep Time
1ms
Detector Type
Sample

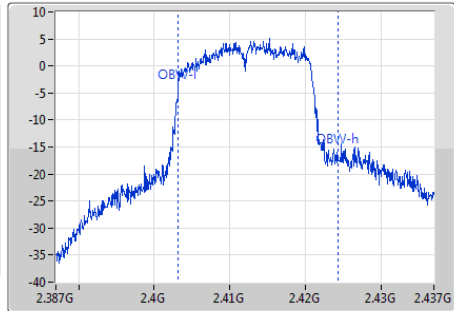

6dB(Hz)	Fl-6dB(Hz)	Fh-6dB(Hz)	OBW(Hz)	Fl-OBW(Hz)	Fh-OBW(Hz)	Limit(Hz)	Port
13.478M	2.40671G	2.420188G	21.201M	2.4031G	2.424301G	500k	1

802.11n HT20_Nss1,(MCS0)_1TX

EBW

2437MHz

CF
2.437GHz
Span
50MHz
RBW
100kHz
VBW
300kHz
Sweep Time
1.08ms
Detector Type
Peak
Port 1

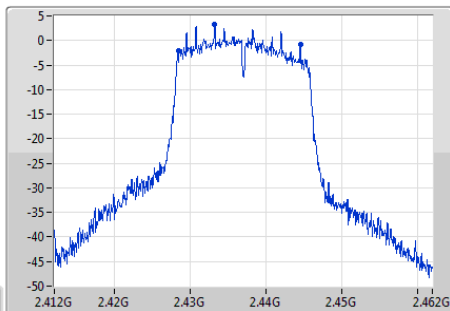

CF
2.437GHz
Span
50MHz
RBW
200kHz
VBW
1MHz
Sweep Time
1.02ms
Detector Type
Sample

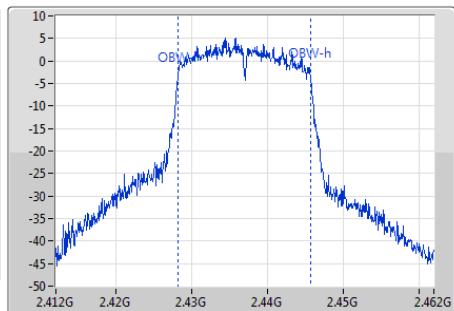

6dB(Hz)	Fl-6dB(Hz)	Fh-6dB(Hz)	OBW(Hz)	Fl-OBW(Hz)	Fh-OBW(Hz)	Limit(Hz)	Port
16.087M	2.428449G	2.444536G	17.583M	2.4281G	2.445683G	500k	1

802.11n HT20_Nss1,(MCS0)_1TX

EBW

2462MHz

CF
2.462GHz
Span
50MHz
RBW
100kHz
VBW
300kHz
Sweep Time
1.08ms
Detector Type
Peak
Port 1

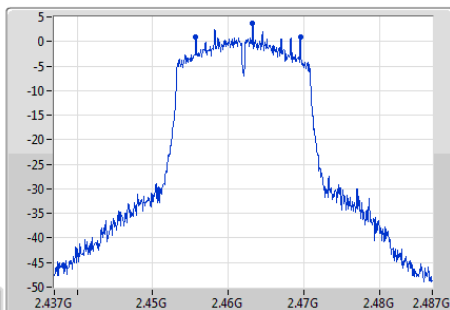

CF
2.462GHz
Span
50MHz
RBW
200kHz
VBW
1MHz
Sweep Time
1.02ms
Detector Type
Sample

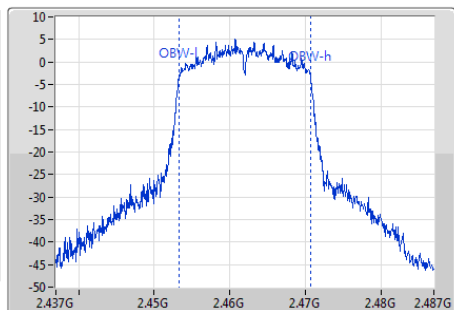

6dB(Hz)	Fl-6dB(Hz)	Fh-6dB(Hz)	OBW(Hz)	Fl-OBW(Hz)	Fh-OBW(Hz)	Limit(Hz)	Port
13.841M	2.455696G	2.469536G	17.511M	2.453245G	2.470755G	500k	1

802.11n HT40_Nss1,(MCS0)_1TX

EBW

2422MHz

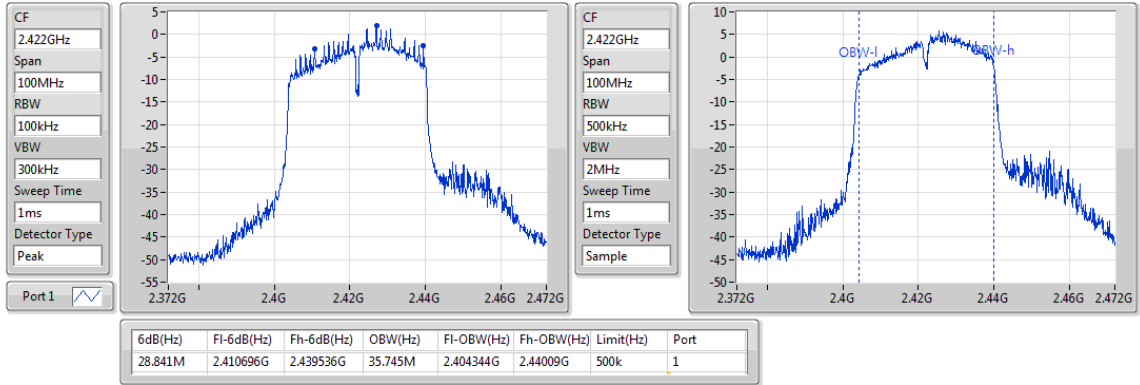

802.11n HT40_Nss1,(MCS0)_1TX

EBW

2437MHz

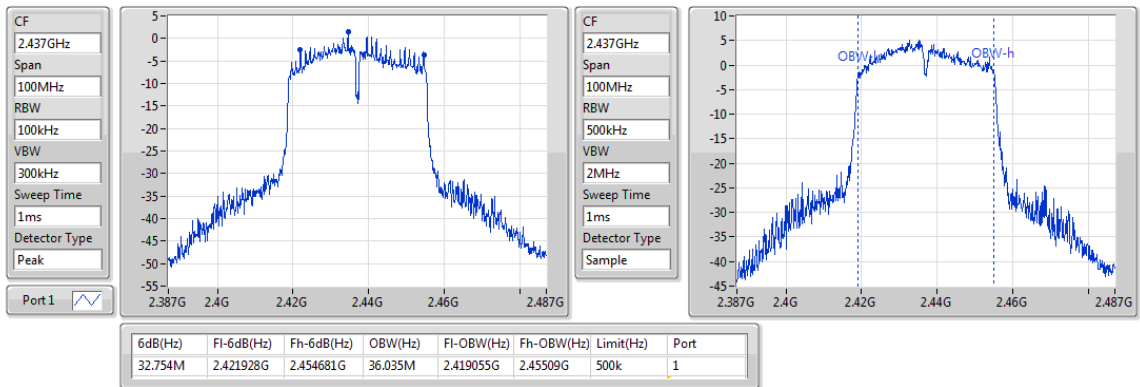

802.11n HT40_Nss1,(MCS0)_1TX

EBW

2452MHz

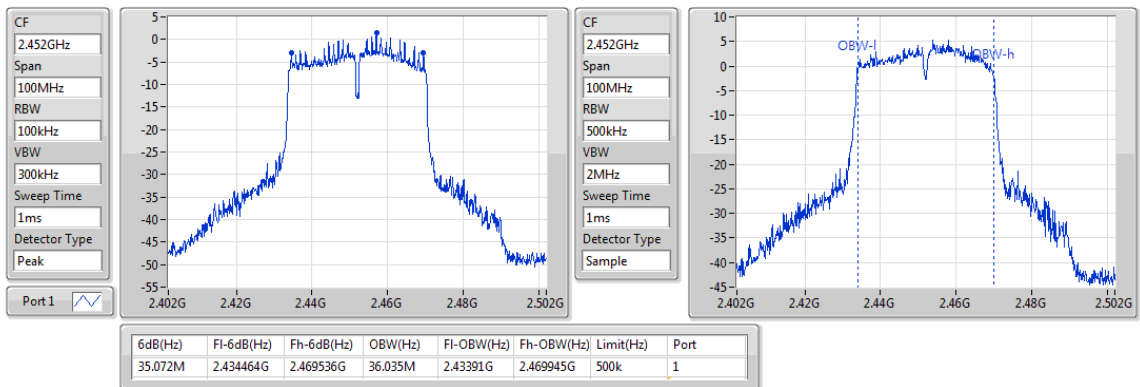

3.3 RF Output Power

3.3.1 Limit of RF Output Power

Conducted power shall not exceed 1Watt.

Antenna gain $\leq 6\text{dBi}$, no any corresponding reduction is in output power limit.

3.3.2 Test Procedures

A broadband RF power meter is used for output power measurement. The video bandwidth of power meter is greater than DTS bandwidth of EUT. If duty cycle of test signal is not 100 %, trigger and gating function of power meter will be enabled to capture transmission burst for measuring output power.

3.3.3 Test Setup

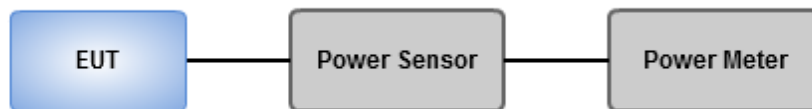

3.3.4 Test Result of Maximum Output Power

Ambient Condition	22°C / 64%	Tested By	Aska Huang
--------------------------	------------	------------------	------------

Summary of Peak Conducted Output Power

Mode	Total Power (dBm)	Total Power (W)
2.4-2.4835GHz	-	-
802.11b_Nss1,(1Mbps)_1TX	16.75	0.04732
802.11g_Nss1,(6Mbps)_1TX	22.45	0.17579
802.11n HT20_Nss1,(MCS0)_1TX	22.43	0.17498
802.11n HT40_Nss1,(MCS0)_1TX	21.87	0.15382

Result

Mode	Result	DG (dBi)	Port 1 (dBm)	Total Power (dBm)	Power Limit (dBm)	EIRP (dBm)	EIRP Limit (dBm)
802.11b_Nss1,(1Mbps)_1TX	-	-	-	-	-	-	-
2412MHz	Pass	-0.23	16.44	16.44	30.00	16.21	36.00
2437MHz	Pass	-0.23	16.75	16.75	30.00	16.52	36.00
2462MHz	Pass	-0.23	16.7	16.70	30.00	16.47	36.00
802.11g_Nss1,(6Mbps)_1TX	-	-	-	-	-	-	-
2412MHz	Pass	-0.23	22.35	22.35	30.00	22.12	36.00
2437MHz	Pass	-0.23	22.45	22.45	30.00	22.22	36.00
2462MHz	Pass	-0.23	22.12	22.12	30.00	21.89	36.00
802.11n HT20_Nss1,(MCS0)_1TX	-	-	-	-	-	-	-
2412MHz	Pass	-0.23	22.25	22.25	30.00	22.02	36.00
2437MHz	Pass	-0.23	22.43	22.43	30.00	22.20	36.00
2462MHz	Pass	-0.23	22.18	22.18	30.00	21.95	36.00
802.11n HT40_Nss1,(MCS0)_1TX	-	-	-	-	-	-	-
2422MHz	Pass	-0.23	21.56	21.56	30.00	21.33	36.00
2437MHz	Pass	-0.23	21.77	21.77	30.00	21.54	36.00
2452MHz	Pass	-0.23	21.87	21.87	30.00	21.64	36.00

DG = Directional Gain; Port X = Port X output power

Summary of Conducted (Average) Output Power

Mode	Total Power (dBm)	Total Power (W)
2.4-2.4835GHz	-	-
802.11b_Nss1,(1Mbps)_1TX	13.84	0.02421
802.11g_Nss1,(6Mbps)_1TX	14.32	0.02704
802.11n HT20_Nss1,(MCS0)_1TX	14.35	0.02723
802.11n HT40_Nss1,(MCS0)_1TX	14.29	0.02685

Result

Mode	Result	DG (dBi)	Port 1 (dBm)	Total Power (dBm)	Power Limit (dBm)	EIRP (dBm)	EIRP Limit (dBm)
802.11b_Nss1,(1Mbps)_1TX	-	-	-	-	-	-	-
2412MHz	Pass	-0.23	13.68	13.68	-	13.45	-
2437MHz	Pass	-0.23	13.84	13.84	-	13.61	-
2462MHz	Pass	-0.23	13.81	13.81	-	13.58	-
802.11g_Nss1,(6Mbps)_1TX	-	-	-	-	-	-	-
2412MHz	Pass	-0.23	14.26	14.26	-	14.03	-
2437MHz	Pass	-0.23	14.32	14.32	-	14.09	-
2462MHz	Pass	-0.23	14.28	14.28	-	14.05	-
802.11n HT20_Nss1,(MCS0)_1TX	-	-	-	-	-	-	-
2412MHz	Pass	-0.23	14.04	14.04	-	13.81	-
2437MHz	Pass	-0.23	14.31	14.31	-	14.08	-
2462MHz	Pass	-0.23	14.35	14.35	-	14.12	-
802.11n HT40_Nss1,(MCS0)_1TX	-	-	-	-	-	-	-
2422MHz	Pass	-0.23	14.27	14.27	-	14.04	-
2437MHz	Pass	-0.23	14.28	14.28	-	14.05	-
2452MHz	Pass	-0.23	14.29	14.29	-	14.06	-

DG = Directional Gain; Port X = Port X output power

Note : Conducted average output power is for reference only

3.4 Power Spectral Density

3.4.1 Limit of Power Spectral Density

Power spectral density shall not be greater than 8 dBm in any 3 kHz band.

3.4.2 Test Procedures

Peak PSD

1. Set the RBW = 3 kHz, VBW = 10 kHz.
2. Detector = Peak, Sweep time = auto couple.
3. Trace mode = max hold, allow trace to fully stabilize.
4. Use the peak marker function to determine the maximum amplitude level.

Average PSD, duty cycle \geq 98%

1. Set the RBW = 30 kHz, VBW = 100 kHz.
2. Detector = RMS, Sweep time = auto couple.
3. Sweep time = auto couple.
4. Employ trace averaging (RMS) mode over a minimum of 100 traces.
5. Use the peak marker function to determine the maximum amplitude level.

Average PSD, duty cycle $<$ 98%

1. Set the RBW = 30 kHz, VBW = 100 kHz. Detector = RMS.
2. Set the sweep time to: ≥ 10 (number of measurement points in sweep) x (total on/off period of the transmitted signal).
3. Perform the measurement over a single sweep.
4. Use the peak marker function to determine the maximum amplitude level.
5. Add $10 \log (1/x)$, where x is the duty cycle.

3.4.3 Test Setup

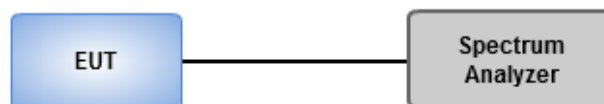

3.4.4 Test Result of Power Spectral Density

Ambient Condition	22°C / 64%	Tested By	Aska Huang
--------------------------	------------	------------------	------------

Summary

Mode	PD (dBm/3kHz)
2.4-2.4835GHz	-
802.11b_Nss1,(1Mbps)_1TX	-8.27
802.11g_Nss1,(6Mbps)_1TX	-10.59
802.11n HT20_Nss1,(MCS0)_1TX	-10.25
802.11n HT40_Nss1,(MCS0)_1TX	-12.54

Result

Mode	Result	DG (dBi)	Port 1 (dBm/3kHz)	PD (dBm/3kHz)	PD Limit (dBm/3kHz)
802.11b_Nss1,(1Mbps)_1TX	-	-	-	-	-
2412MHz	Pass	-0.23	-8.81	-8.81	8.00
2437MHz	Pass	-0.23	-8.27	-8.27	8.00
2462MHz	Pass	-0.23	-9.56	-9.56	8.00
802.11g_Nss1,(6Mbps)_1TX	-	-	-	-	-
2412MHz	Pass	-0.23	-11.67	-11.67	8.00
2437MHz	Pass	-0.23	-10.99	-10.99	8.00
2462MHz	Pass	-0.23	-10.59	-10.59	8.00
802.11n HT20_Nss1,(MCS0)_1TX	-	-	-	-	-
2412MHz	Pass	-0.23	-10.79	-10.79	8.00
2437MHz	Pass	-0.23	-10.25	-10.25	8.00
2462MHz	Pass	-0.23	-10.56	-10.56	8.00
802.11n HT40_Nss1,(MCS0)_1TX	-	-	-	-	-
2422MHz	Pass	-0.23	-12.54	-12.54	8.00
2437MHz	Pass	-0.23	-12.90	-12.90	8.00
2452MHz	Pass	-0.23	-13.25	-13.25	8.00

DG = Directional Gain;

PD = Maximum power density; Port X = Port X power density;

802.11b_Nss1,(1Mbps)_1TX

PSD

2412MHz

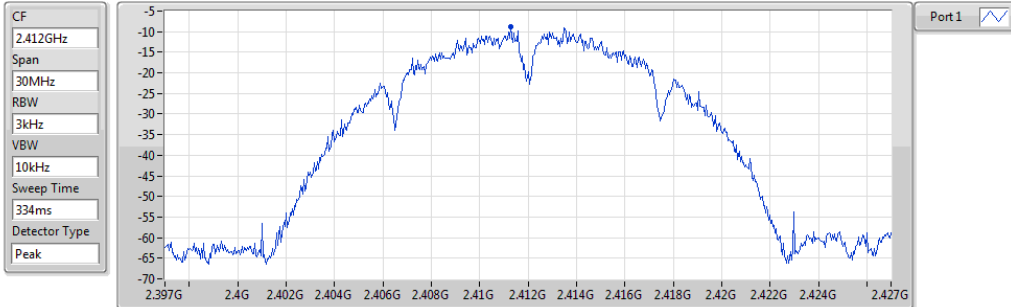

Sum	PD	Port 1
(dBm/RBW)	(dBm/RBW)	(dBm/RBW)
-8.81	-8.81	-8.81

802.11b_Nss1,(1Mbps)_1TX

PSD

2437MHz

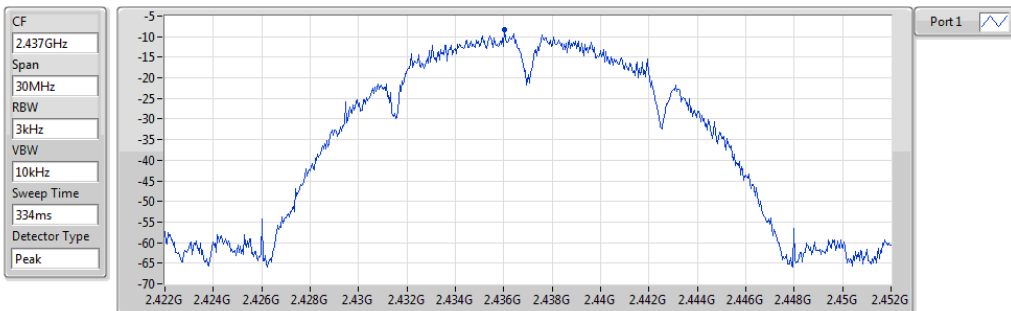

Sum	PD	Port 1
(dBm/RBW)	(dBm/RBW)	(dBm/RBW)
-8.27	-8.27	-8.27

802.11b_Nss1,(1Mbps)_1TX

PSD

2462MHz

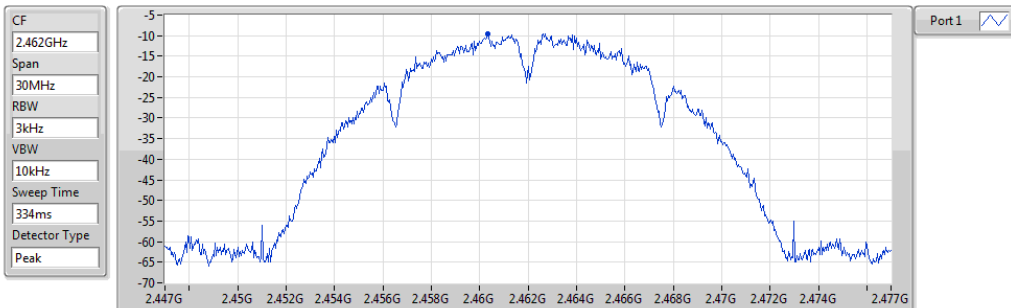

Sum	PD	Port 1
(dBm/RBW)	(dBm/RBW)	(dBm/RBW)
-9.56	-9.56	-9.56

802.11g_Nss1,(6Mbps)_1TX

PSD

2412MHz

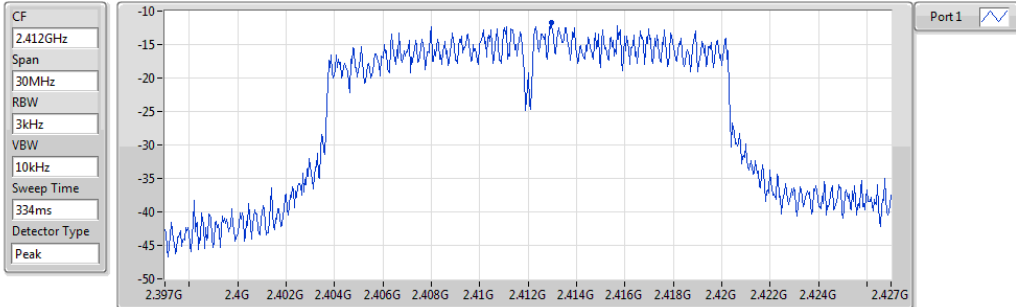

Sum	PD	Port 1
(dBm/RBW)	(dBm/RBW)	(dBm/RBW)
-11.67	-11.67	-11.67

802.11g_Nss1,(6Mbps)_1TX

PSD

2437MHz

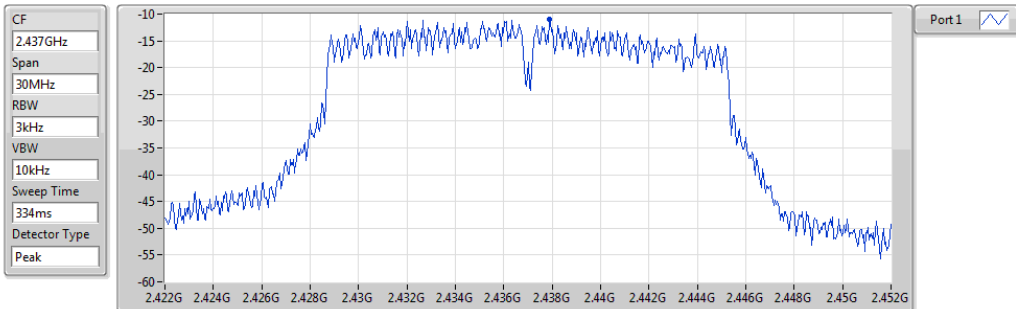

Sum	PD	Port 1
(dBm/RBW)	(dBm/RBW)	(dBm/RBW)
-10.99	-10.99	-10.99

802.11g_Nss1,(6Mbps)_1TX

PSD

2462MHz

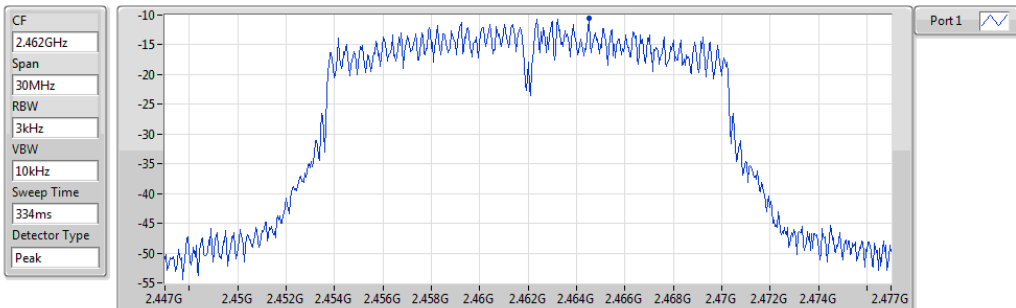

Sum	PD	Port 1
(dBm/RBW)	(dBm/RBW)	(dBm/RBW)
-10.59	-10.59	-10.59

802.11n HT20_Nss1,(MCS0)_1TX

PSD

2412MHz

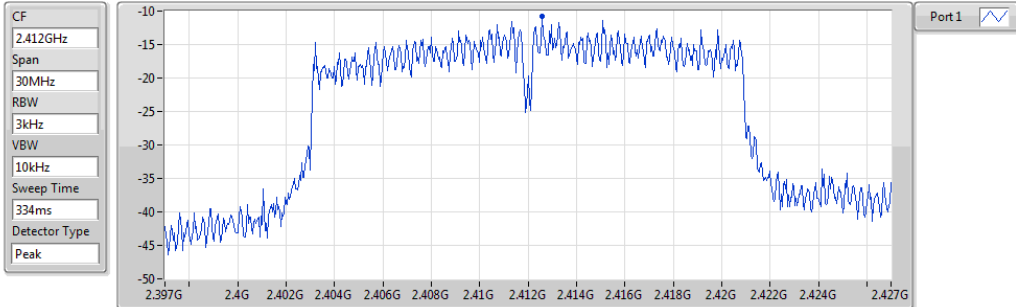

Sum	PD	Port 1
(dBm/RBW)	(dBm/RBW)	(dBm/RBW)
-10.79	-10.79	-10.79

802.11n HT20_Nss1,(MCS0)_1TX

PSD

2437MHz

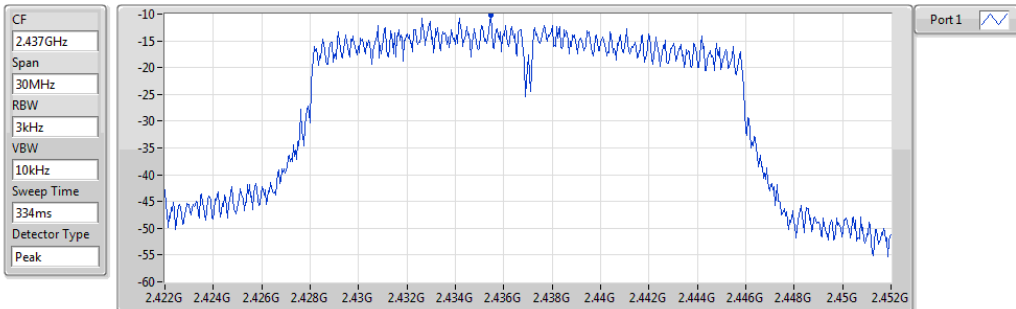

Sum	PD	Port 1
(dBm/RBW)	(dBm/RBW)	(dBm/RBW)
-10.25	-10.25	-10.25

802.11n HT20_Nss1,(MCS0)_1TX

PSD

2462MHz

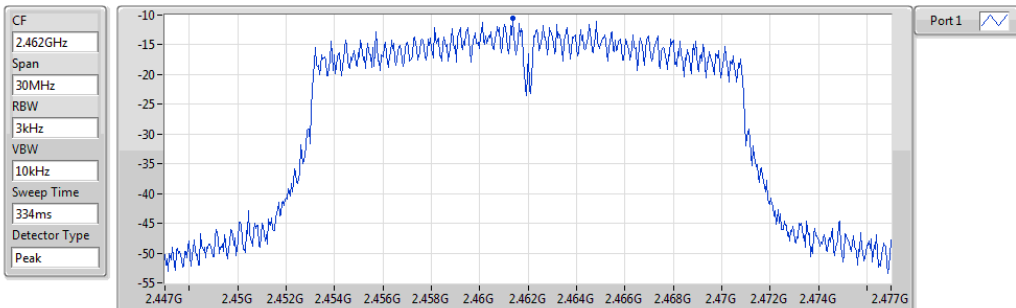

Sum	PD	Port 1
(dBm/RBW)	(dBm/RBW)	(dBm/RBW)
-10.56	-10.56	-10.56

802.11n HT40_Nss1,(MCS0)_1TX

PSD

2422MHz

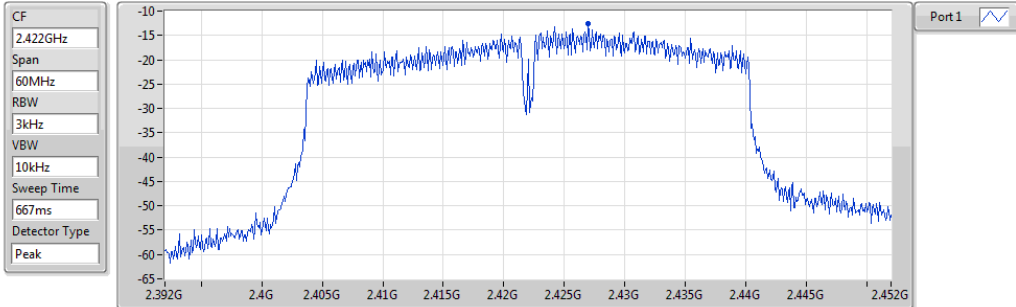

Sum	PD	Port 1
(dBm/RBW)	(dBm/RBW)	(dBm/RBW)
-12.54	-12.54	-12.54

802.11n HT40_Nss1,(MCS0)_1TX

PSD

2437MHz

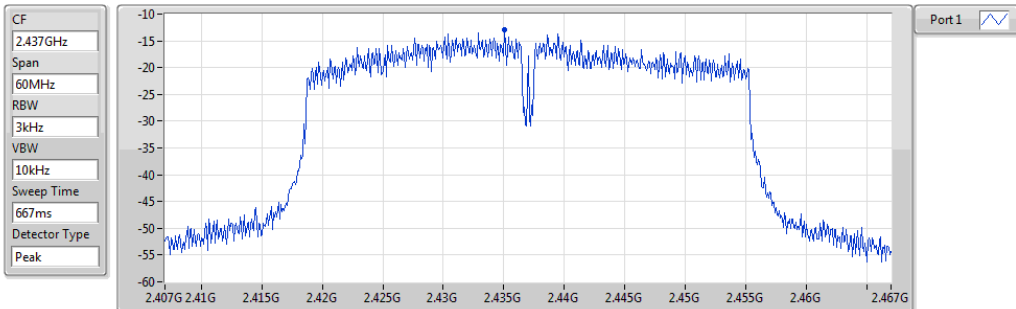

Sum	PD	Port 1
(dBm/RBW)	(dBm/RBW)	(dBm/RBW)
-12.90	-12.90	-12.90

802.11n HT40_Nss1,(MCS0)_1TX

PSD

2452MHz

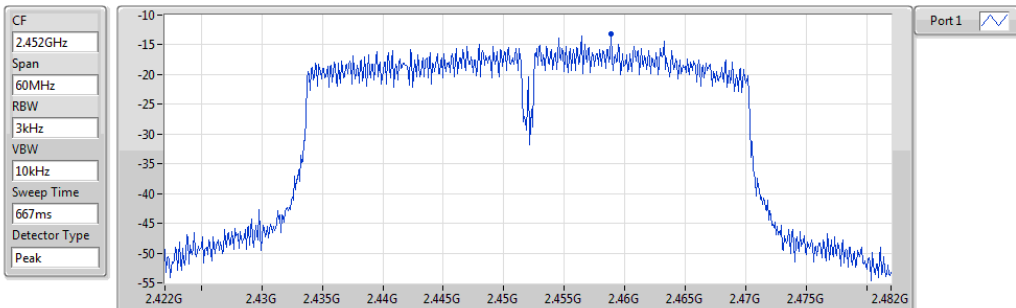

Sum	PD	Port 1
(dBm/RBW)	(dBm/RBW)	(dBm/RBW)
-13.25	-13.25	-13.25

3.5 Unwanted Emissions into Restricted Frequency Bands

3.5.1 Limit of Unwanted Emissions into Restricted Frequency Bands

Restricted Band Emissions Limit			
Frequency Range (MHz)	Field Strength (uV/m)	Field Strength (dBuV/m)	Measure Distance (m)
0.009~0.490	2400/F(kHz)	48.5 - 13.8	300
0.490~1.705	24000/F(kHz)	33.8 - 23	30
1.705~30.0	30	29	30
30~88	100	40	3
88~216	150	43.5	3
216~960	200	46	3
Above 960	500	54	3

Note 1:
Quasi-Peak value is measured for frequency below 1GHz except for 9–90 kHz, 110–490 kHz frequency band. Peak and average value are measured for frequency above 1GHz. The limit on average radio frequency emission is as above table. The limit on peak radio frequency emissions is 20 dB above the maximum permitted average emission limit

Note 2:
Measurements may be performed at a distance other than what is specified provided. When performing measurements at a distance other than that specified, the results shall be extrapolated to the specified distance using an extrapolation factor as below, Frequency at or above 30 MHz: 20 dB/decade Frequency below 30 MHz: 40 dB/decade.

3.5.2 Test Procedures

1. Measurement is made at a semi-anechoic chamber that incorporates a turntable allowing a EUT rotation of 360°. A continuously-rotating, remotely-controlled turntable is installed at the test site to support the EUT and facilitate determination of the direction of maximum radiation for each EUT emission frequency. The EUT is placed at test table. For emissions testing at or below 1 GHz, the table height is 80 cm above the reference ground plane. For emission measurements above 1 GHz, the table height is 1.5 m
2. Measurement is made with the antenna positioned in both the horizontal and vertical planes of polarization. The measurement antenna is varied in height (1m ~ 4m) above the reference ground plane to obtain the maximum signal strength. Distance between EUT and antenna is 3 m.
3. This investigation is performed with the EUT rotated 360°, the antenna height scanned between 1 m and 4 m, and the antenna rotated to repeat the measurements for both the horizontal and vertical antenna polarizations.

Note:

1. 120kHz measurement bandwidth of test receiver and Quasi-peak detector is for radiated emission below 1GHz.
2. RBW=1MHz, VBW=3MHz and Peak detector is for peak measured value of radiated emission above 1GHz.
3. RBW=1MHz, VBW=1/T and Peak detector is for average measured value of radiated emission above 1GHz.

3.5.3 Test Setup

Radiated Emissions below 1 GHz



Radiated Emissions above 1 GHz

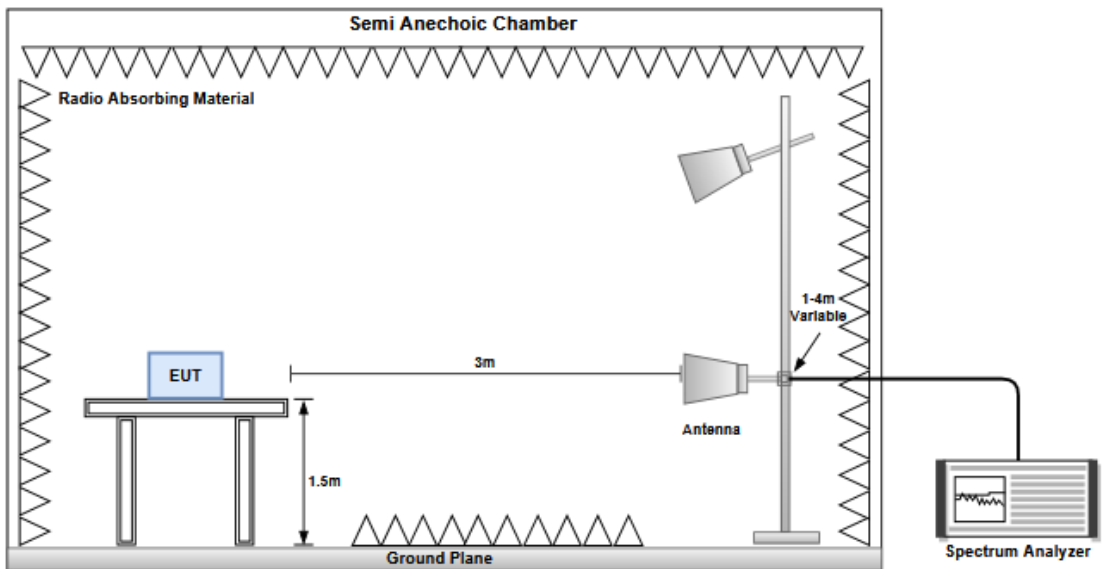

3.5.4 Transmitter Radiated Unwanted Emissions (Below 1GHz)

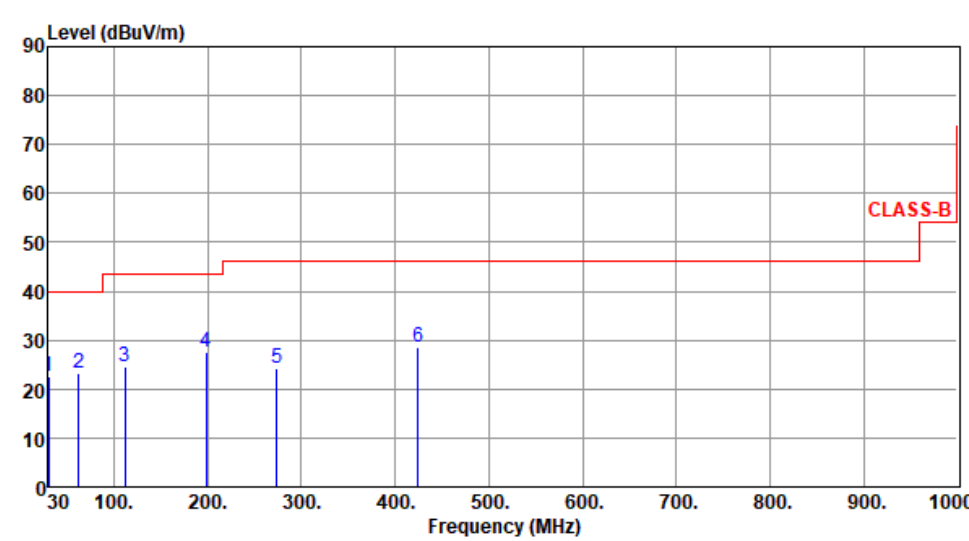
Modulation	11g	Test Freq. (MHz)	2437						
Polarization	Horizontal								
Test By : Akun Chung Temperature(°C): 25 Humidity(%): 64									
									
	Freq. MHz	Emission level dBuV/m	Limit dBuV/m	Margin dB	SA reading dBuV	Factor dB/m	Remark	ANT High cm	Turn Table deg
1	30.00	22.46	40.00	-17.54	32.47	-10.01	Peak	---	---
2	62.01	23.13	40.00	-16.87	32.83	-9.70	Peak	---	---
3	111.48	24.73	43.50	-18.77	36.39	-11.66	Peak	---	---
4	198.78	27.47	43.50	-16.03	39.32	-11.85	Peak	---	---
5	273.47	24.25	46.00	-21.75	33.29	-9.04	Peak	---	---
6	424.79	28.49	46.00	-17.51	33.57	-5.08	Peak	---	---
<p>Note 1: Emission Level (dBuV/m) = SA Reading (dBuV) + Factor* (dB/m) *Factor includes antenna factor , cable loss and amplifier gain Note 2: Margin (dB) = Emission level (dBuV/m) – Limit (dBuV/m). Note 3: All spurious emissions below 30MHz are more than 20 dB below the limit.</p>									

Modulation	11g	Test Freq. (MHz)	2437
Polarization	Vertical		

Test By : Akun Chung Temperature(°C): 25 Humidity(%): 64

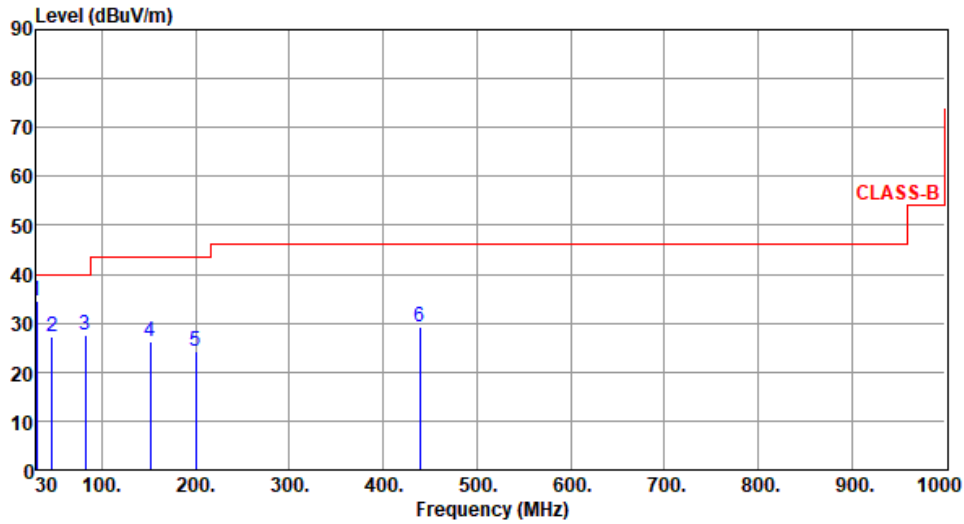

	Freq. MHz	Emission level dBuV/m	Limit dBuV/m	Margin dB	SA reading dBuV	Factor dB/m	Remark	ANT High cm	Turn Table deg
1	30.00	34.43	40.00	-5.57	44.44	-10.01	Peak	---	---
2	46.49	27.12	40.00	-12.88	35.63	-8.51	Peak	---	---
3	82.38	27.70	40.00	-12.30	41.65	-13.95	Peak	---	---
4	151.25	26.35	43.50	-17.15	35.22	-8.87	Peak	---	---
5	199.75	24.09	43.50	-19.41	35.99	-11.90	Peak	---	---
6	439.34	29.08	46.00	-16.92	33.72	-4.64	Peak	---	---

Note 1: Emission Level (dBuV/m) = SA Reading (dBuV) + Factor* (dB/m)

*Factor includes antenna factor , cable loss and amplifier gain

Note 2: Margin (dB) = Emission level (dBuV/m) – Limit (dBuV/m).

Note 3: All spurious emissions below 30MHz are more than 20 dB below the limit.

3.5.5 Transmitter Radiated Unwanted Emissions (Above 1GHz) for 11b

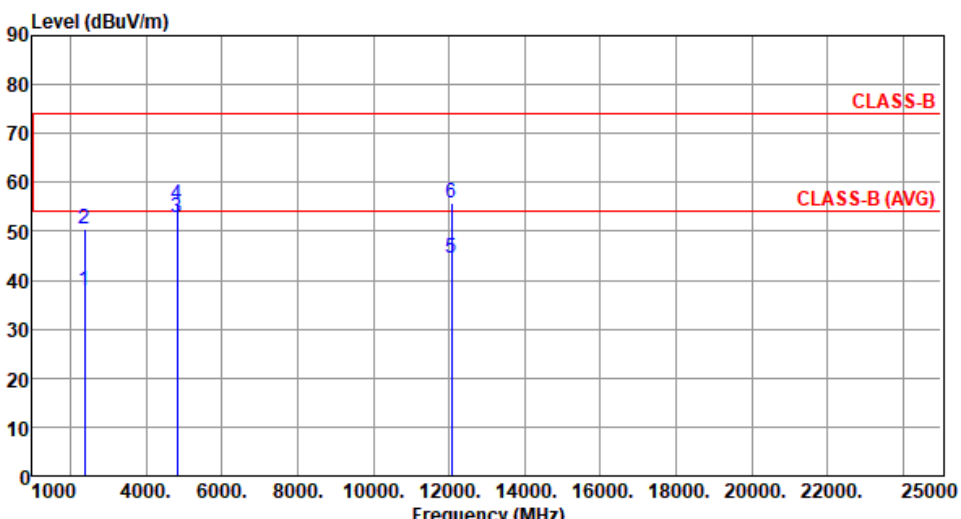
Modulation	11b	Test Freq. (MHz)	2412						
Polarization	Horizontal								
Test By : Akun Chung Temperature(°C): 25 Humidity(%): 67									
									
	Freq.	Emission level	Limit	Margin	SA reading	Factor	Remark	ANT High	Turn Table
	MHz	dBuV/m	dBuV/m	dB	dBuV	dB/m		cm	deg
1	2390.00	37.77	54.00	-16.23	40.56	-2.79	Average	126	347
2	2390.00	50.36	74.00	-23.64	53.15	-2.79	Peak	126	347
3	4824.00	52.74	54.00	-1.26	49.27	3.47	Average	101	284
4	4824.00	55.59	74.00	-18.41	52.12	3.47	Peak	101	284
5	12060.00	44.47	54.00	-9.53	30.15	14.32	Average	100	40
6	12060.00	55.91	74.00	-18.09	41.59	14.32	Peak	100	40

Note 1: Emission Level (dBuV/m) = SA Reading (dBuV) + Factor* (dB/m)
*Factor includes antenna factor , cable loss and amplifier gain
Note 2: Margin (dB) = Emission level (dBuV/m) – Limit (dBuV/m).

Modulation	11b	Test Freq. (MHz)	2412
Polarization	Vertical		

Test By :Akun Chung Temperature(°C):25 Humidity(%):67

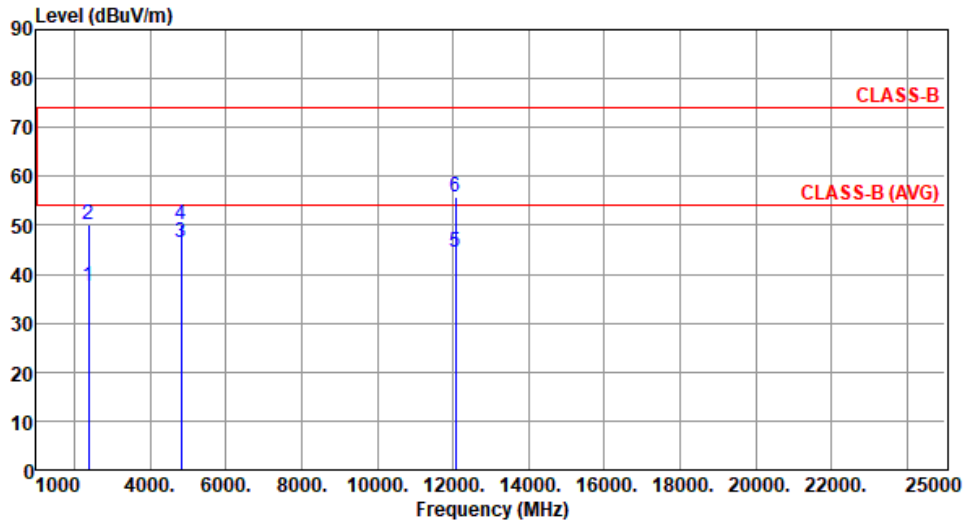

	Freq. MHz	Emission level dBuV/m	Limit dBuV/m	Margin dB	SA reading dBuV	Factor dB/m	Remark	ANT High cm	Turn Table deg
1	2390.00	37.62	54.00	-16.38	40.41	-2.79	Average	100	263
2	2390.00	50.27	74.00	-23.73	53.06	-2.79	Peak	100	263
3	4824.00	46.63	54.00	-7.37	43.16	3.47	Average	261	45
4	4824.00	50.06	74.00	-23.94	46.59	3.47	Peak	261	45
5	12060.00	44.37	54.00	-9.63	30.05	14.32	Average	100	20
6	12060.00	55.78	74.00	-18.22	41.46	14.32	Peak	100	20

Note 1: Emission Level (dBuV/m) = SA Reading (dBuV) + Factor* (dB/m)

*Factor includes antenna factor , cable loss and amplifier gain

Note 2: Margin (dB) = Emission level (dBuV/m) – Limit (dBuV/m).

Modulation	11b	Test Freq. (MHz)	2437
Polarization	Horizontal		

Test By : Akun Chung Temperature(°C): 25 Humidity(%): 67

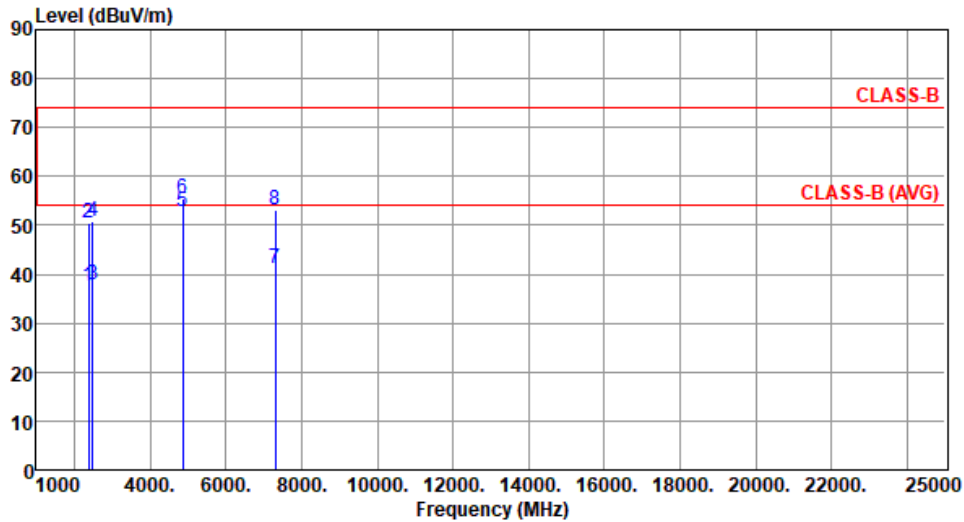

	Freq. MHz	Emission level dBuV/m	Limit dBuV/m	Margin dB	SA reading dBuV	Factor dB/m	Remark	ANT High cm	Turn Table deg
1	2390.00	37.63	54.00	-16.37	40.42	-2.79	Average	122	351
2	2390.00	50.37	74.00	-23.63	53.16	-2.79	Peak	122	351
3	2483.50	37.82	54.00	-16.18	40.56	-2.74	Average	122	351
4	2483.50	50.90	74.00	-23.10	53.64	-2.74	Peak	122	351
5	4874.00	52.96	54.00	-1.04	49.51	3.45	Average	107	282
6	4874.00	55.38	74.00	-18.62	51.93	3.45	Peak	107	282
7	7311.00	41.32	54.00	-12.68	32.33	8.99	Average	100	285
8	7311.00	53.27	74.00	-20.73	44.28	8.99	Peak	100	285

Note 1: Emission Level (dBuV/m) = SA Reading (dBuV) + Factor* (dB/m)

*Factor includes antenna factor , cable loss and amplifier gain

Note 2: Margin (dB) = Emission level (dBuV/m) – Limit (dBuV/m).

Modulation	11b	Test Freq. (MHz)	2437
Polarization	Vertical		

Test By : Akun Chung Temperature(°C): 25 Humidity(%): 67

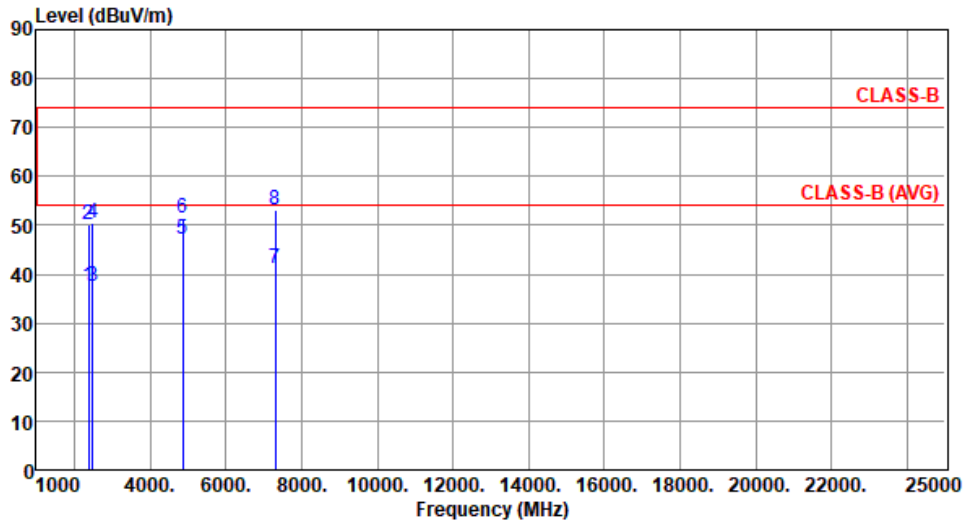

	Freq. MHz	Emission level dBuV/m	Limit dBuV/m	Margin dB	SA reading dBuV	Factor dB/m	Remark	ANT High cm	Turn Table deg
1	2390.00	37.47	54.00	-16.53	40.26	-2.79	Average	100	262
2	2390.00	50.26	74.00	-23.74	53.05	-2.79	Peak	100	262
3	2483.50	37.63	54.00	-16.37	40.37	-2.74	Average	100	262
4	2483.50	50.60	74.00	-23.40	53.34	-2.74	Peak	100	262
5	4874.00	47.04	54.00	-6.96	43.59	3.45	Average	266	43
6	4874.00	51.36	74.00	-22.64	47.91	3.45	Peak	266	43
7	7311.00	41.07	54.00	-12.93	32.08	8.99	Average	100	45
8	7311.00	53.10	74.00	-20.90	44.11	8.99	Peak	100	45

Note 1: Emission Level (dBuV/m) = SA Reading (dBuV) + Factor* (dB/m)

*Factor includes antenna factor , cable loss and amplifier gain

Note 2: Margin (dB) = Emission level (dBuV/m) – Limit (dBuV/m).

Modulation	11b	Test Freq. (MHz)	2462
Polarization	Horizontal		

Test By : Akun Chung Temperature(°C): 25 Humidity(%): 67

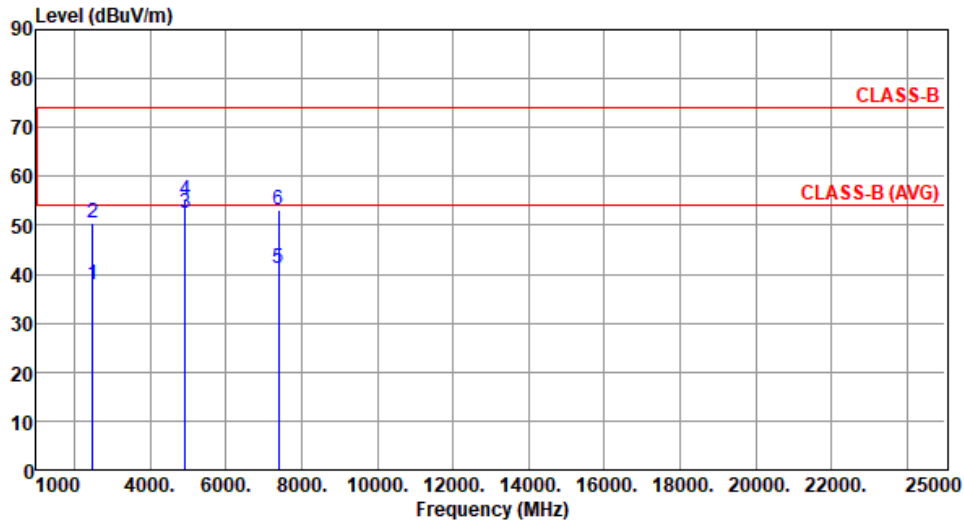

	Freq. MHz	Emission level dBuV/m	Limit dBuV/m	Margin dB	SA reading dBuV	Factor dB/m	Remark	ANT High cm	Turn Table deg
1	2483.50	37.76	54.00	-16.24	40.50	-2.74	Average	100	346
2	2483.50	50.33	74.00	-23.67	53.07	-2.74	Peak	100	346
3	4924.00	52.52	54.00	-1.48	48.97	3.55	Average	100	270
4	4924.00	55.12	74.00	-18.88	51.57	3.55	Peak	100	270
5	7386.00	41.13	54.00	-12.87	32.16	8.97	Average	100	281
6	7386.00	53.14	74.00	-20.86	44.17	8.97	Peak	100	281

Note 1: Emission Level (dBuV/m) = SA Reading (dBuV) + Factor* (dB/m)

*Factor includes antenna factor , cable loss and amplifier gain

Note 2: Margin (dB) = Emission level (dBuV/m) – Limit (dBuV/m).

Modulation	11b	Test Freq. (MHz)	2462
Polarization	Vertical		

Test By : Akun Chung Temperature(°C): 25 Humidity(%): 67

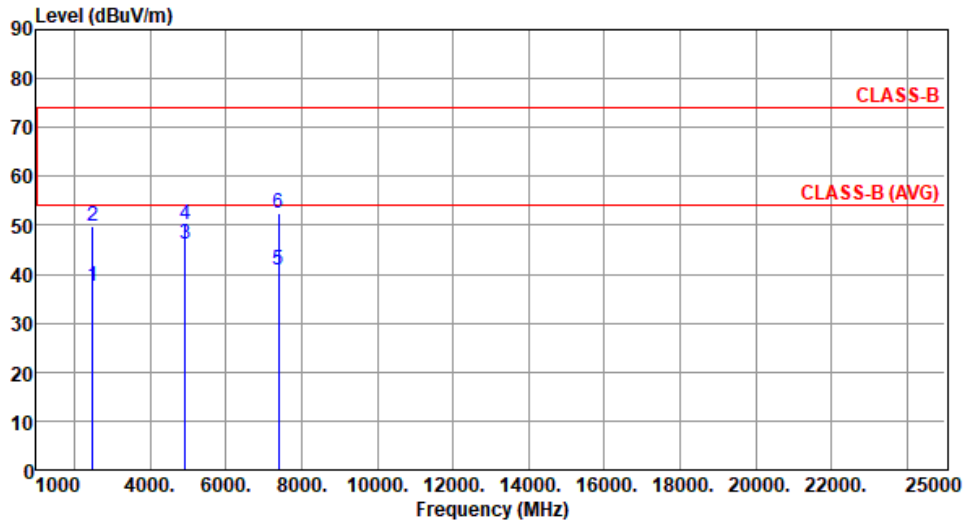

	Freq. MHz	Emission level dBuV/m	Limit dBuV/m	Margin dB	SA reading dBuV	Factor dB/m	Remark	ANT High cm	Turn Table deg
1	2483.50	37.48	54.00	-16.52	40.22	-2.74	Average	100	262
2	2483.50	49.85	74.00	-24.15	52.59	-2.74	Peak	100	262
3	4924.00	46.10	54.00	-7.90	42.55	3.55	Average	262	41
4	4924.00	50.22	74.00	-23.78	46.67	3.55	Peak	262	41
5	7386.00	41.01	54.00	-12.99	32.04	8.97	Average	100	42
6	7386.00	52.57	74.00	-21.43	43.60	8.97	Peak	100	42

Note 1: Emission Level (dBuV/m) = SA Reading (dBuV) + Factor* (dB/m)

*Factor includes antenna factor , cable loss and amplifier gain

Note 2: Margin (dB) = Emission level (dBuV/m) – Limit (dBuV/m).

3.5.6 Transmitter Radiated Unwanted Emissions (Above 1GHz) for 11g

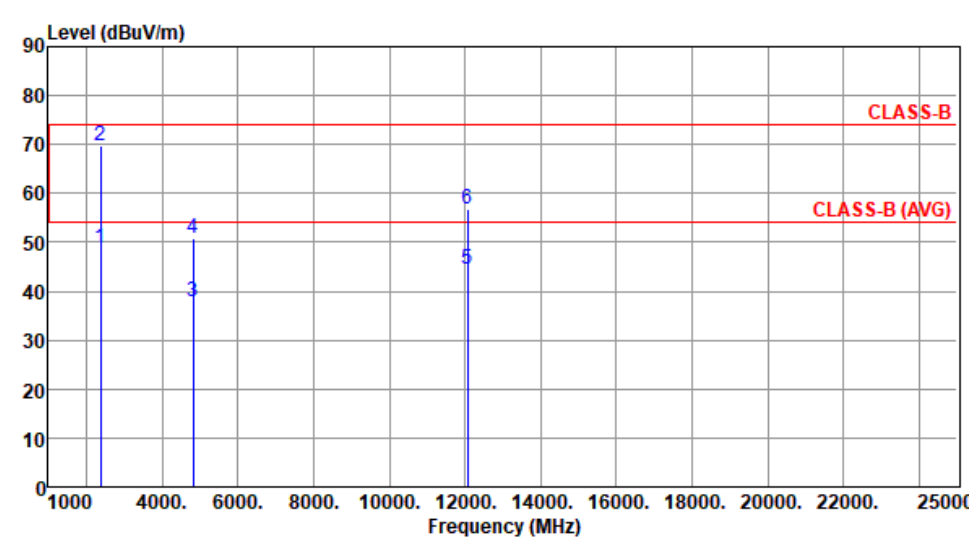
Modulation	11g	Test Freq. (MHz)	2412						
Polarization	Horizontal								
Test By : Akun Chung Temperature(°C): 25 Humidity(%): 67									
									
	Freq. MHz	Emission level dBuV/m	Limit dBuV/m	Margin dB	SA reading dBuV	Factor dB/m	Remark	ANT High cm	Turn Table deg
1	2390.00	48.95	54.00	-5.05	51.74	-2.79	Average	102	341
2	2390.00	69.84	74.00	-4.16	72.63	-2.79	Peak	102	341
3	4824.00	37.85	54.00	-16.15	34.38	3.47	Average	100	265
4	4824.00	50.81	74.00	-23.19	47.34	3.47	Peak	100	265
5	12060.00	44.47	54.00	-9.53	30.15	14.32	Average	100	20
6	12060.00	56.78	74.00	-17.22	42.46	14.32	Peak	100	20
<p>Note 1: Emission Level (dBuV/m) = SA Reading (dBuV) + Factor* (dB/m) *Factor includes antenna factor , cable loss and amplifier gain Note 2: Margin (dB) = Emission level (dBuV/m) – Limit (dBuV/m).</p>									

Modulation	11g	Test Freq. (MHz)	2412
Polarization	Vertical		

Test By :Akun Chung Temperature(°C):25 Humidity(%):67

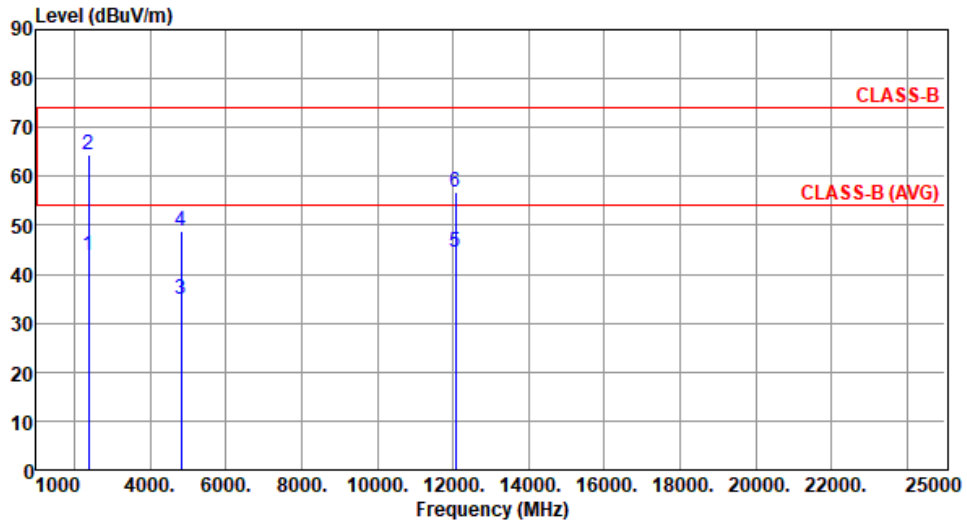

	Freq. MHz	Emission level dBuV/m	Limit dBuV/m	Margin dB	SA reading dBuV	Factor dB/m	Remark	ANT High cm	Turn Table deg
1	2390.00	43.78	54.00	-10.22	46.57	-2.79	Average	100	265
2	2390.00	64.47	74.00	-9.53	67.26	-2.79	Peak	100	265
3	4824.00	34.85	54.00	-19.15	31.38	3.47	Average	262	48
4	4824.00	48.78	74.00	-25.22	45.31	3.47	Peak	262	48
5	12060.00	44.41	54.00	-9.59	30.09	14.32	Average	100	40
6	12060.00	56.66	74.00	-17.34	42.34	14.32	Peak	100	40

Note 1: Emission Level (dBuV/m) = SA Reading (dBuV) + Factor* (dB/m)

*Factor includes antenna factor , cable loss and amplifier gain

Note 2: Margin (dB) = Emission level (dBuV/m) – Limit (dBuV/m).

Modulation	11g	Test Freq. (MHz)	2437
Polarization	Horizontal		

Test By :Roger Lu Temperature(°C):25 Humidity(%):67

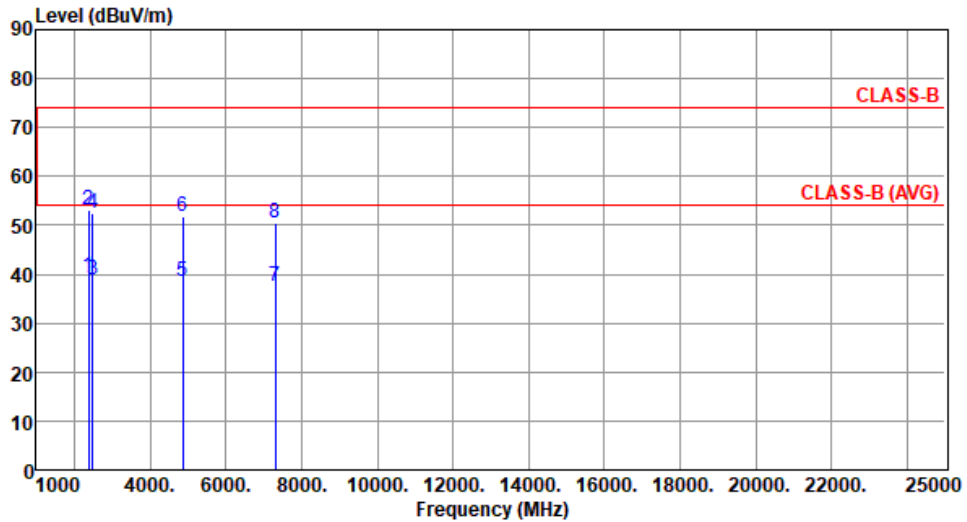

	Freq. MHz	Emission level dBuV/m	Limit dBuV/m	Margin dB	SA reading dBuV	Factor dB/m	Remark	ANT High cm	Turn Table deg
1	2390.00	39.68	54.00	-14.32	42.47	-2.79	Average	158	351
2	2390.00	53.14	74.00	-20.86	55.93	-2.79	Peak	158	351
3	2483.50	38.86	54.00	-15.14	41.60	-2.74	Average	158	351
4	2483.50	52.35	74.00	-21.65	55.09	-2.74	Peak	158	351
5	4874.00	38.69	54.00	-15.31	35.24	3.45	Average	100	262
6	4874.00	51.84	74.00	-22.16	48.39	3.45	Peak	100	262
7	7311.00	37.65	54.00	-16.35	28.66	8.99	Average	100	280
8	7311.00	50.63	74.00	-23.37	41.64	8.99	Peak	100	280

Note 1: Emission Level (dBuV/m) = SA Reading (dBuV) + Factor* (dB/m)

*Factor includes antenna factor , cable loss and amplifier gain

Note 2: Margin (dB) = Emission level (dBuV/m) – Limit (dBuV/m).

Modulation	11g	Test Freq. (MHz)	2437
Polarization	Vertical		

Test By :Roger Lu Temperature(°C):25 Humidity(%):67

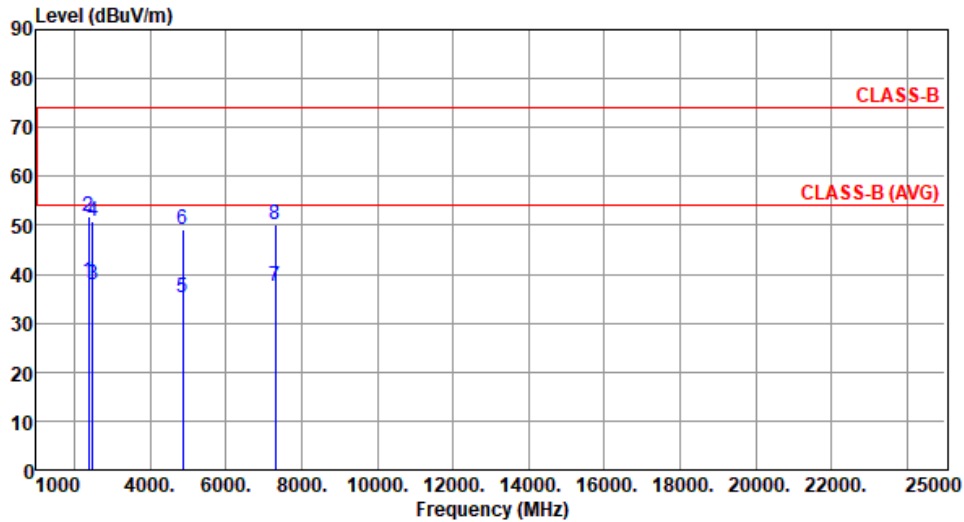

	Freq. MHz	Emission level dBuV/m	Limit dBuV/m	Margin dB	SA reading dBuV	Factor dB/m	Remark	ANT High cm	Turn Table deg
1	2390.00	38.69	54.00	-15.31	41.48	-2.79	Average	100	269
2	2390.00	51.88	74.00	-22.12	54.67	-2.79	Peak	100	269
3	2483.50	37.72	54.00	-16.28	40.46	-2.74	Average	100	269
4	2483.50	50.77	74.00	-23.23	53.51	-2.74	Peak	100	269
5	4874.00	35.05	54.00	-18.95	31.60	3.45	Average	265	45
6	4874.00	49.11	74.00	-24.89	45.66	3.45	Peak	265	45
7	7311.00	37.45	54.00	-16.55	28.46	8.99	Average	100	30
8	7311.00	50.27	74.00	-23.73	41.28	8.99	Peak	100	30

Note 1: Emission Level (dBuV/m) = SA Reading (dBuV) + Factor* (dB/m)

*Factor includes antenna factor , cable loss and amplifier gain

Note 2: Margin (dB) = Emission level (dBuV/m) – Limit (dBuV/m).

Modulation	11g	Test Freq. (MHz)	2462
Polarization	Horizontal		

Test By :Akun Chung Temperature(°C):25 Humidity(%):67

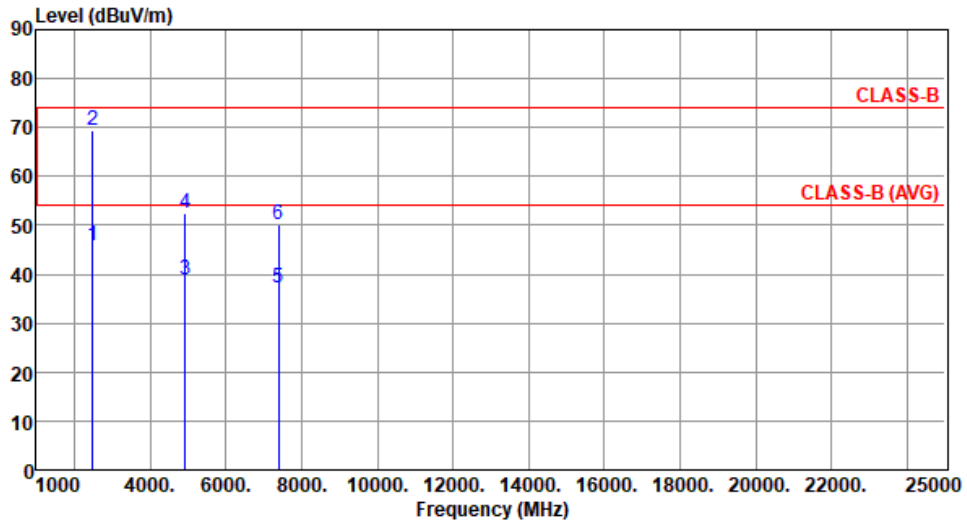

	Freq. MHz	Emission level dBuV/m	Limit dBuV/m	Margin dB	SA reading dBuV	Factor dB/m	Remark	ANT High cm	Turn Table deg
1	2483.50	45.86	54.00	-8.14	48.60	-2.74	Average	105	339
2	2483.50	69.41	74.00	-4.59	72.15	-2.74	Peak	105	339
3	4924.00	38.92	54.00	-15.08	35.37	3.55	Average	100	268
4	4924.00	52.36	74.00	-21.64	48.81	3.55	Peak	100	268
5	7386.00	37.23	54.00	-16.77	28.26	8.97	Average	100	40
6	7386.00	50.27	74.00	-23.73	41.30	8.97	Peak	100	40

Note 1: Emission Level (dBuV/m) = SA Reading (dBuV) + Factor* (dB/m)

*Factor includes antenna factor , cable loss and amplifier gain

Note 2: Margin (dB) = Emission level (dBuV/m) – Limit (dBuV/m).

Modulation	11g	Test Freq. (MHz)	2462
Polarization	Vertical		

Test By :Akun Chung Temperature(°C):25 Humidity(%):67

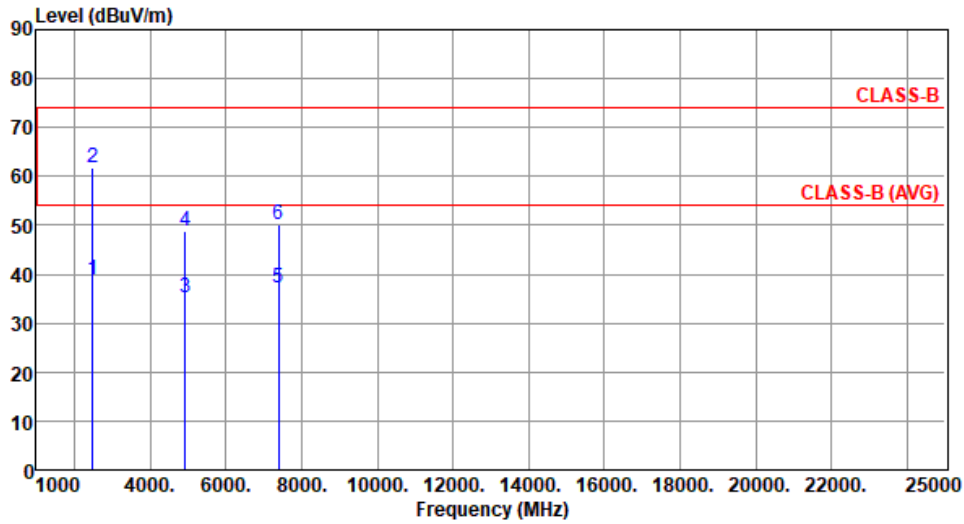

	Freq. MHz	Emission level dBuV/m	Limit dBuV/m	Margin dB	SA reading dBuV	Factor dB/m	Remark	ANT High cm	Turn Table deg
1	2483.50	38.81	54.00	-15.19	41.55	-2.74	Average	100	268
2	2483.50	61.82	74.00	-12.18	64.56	-2.74	Peak	100	268
3	4924.00	35.22	54.00	-18.78	31.67	3.55	Average	262	41
4	4924.00	48.83	74.00	-25.17	45.28	3.55	Peak	262	41
5	7386.00	37.17	54.00	-16.83	28.20	8.97	Average	100	30
6	7386.00	50.14	74.00	-23.86	41.17	8.97	Peak	100	30

Note 1: Emission Level (dBuV/m) = SA Reading (dBuV) + Factor* (dB/m)

*Factor includes antenna factor , cable loss and amplifier gain

Note 2: Margin (dB) = Emission level (dBuV/m) – Limit (dBuV/m).

3.5.7 Transmitter Radiated Unwanted Emissions (Above 1GHz) for HT20

Modulation	HT20	Test Freq. (MHz)	2412						
Polarization	Horizontal								
Test By : Akun Chung Temperature(°C): 25 Humidity(%): 67									
	Freq.	Emission level	Limit	Margin	SA reading	Factor	Remark	ANT High	Turn Table
	MHz	dBuV/m	dBuV/m	dB	dBuV	dB/m		cm	deg
1	2390.00	49.21	54.00	-4.79	52.00	-2.79	Average	103	338
2	2390.00	69.92	74.00	-4.08	72.71	-2.79	Peak	103	338
3	4824.00	38.41	54.00	-15.59	34.94	3.47	Average	105	266
4	4824.00	52.54	74.00	-21.46	49.07	3.47	Peak	105	266
5	12060.00	44.49	54.00	-9.51	30.17	14.32	Average	100	40
6	12060.00	56.71	74.00	-17.29	42.39	14.32	Peak	100	40

Note 1: Emission Level (dBuV/m) = SA Reading (dBuV) + Factor* (dB/m)
 *Factor includes antenna factor , cable loss and amplifier gain
 Note 2: Margin (dB) = Emission level (dBuV/m) – Limit (dBuV/m).

Modulation	HT20	Test Freq. (MHz)	2412
Polarization	Vertical		

Test By : Akun Chung Temperature(°C): 25 Humidity(%): 67

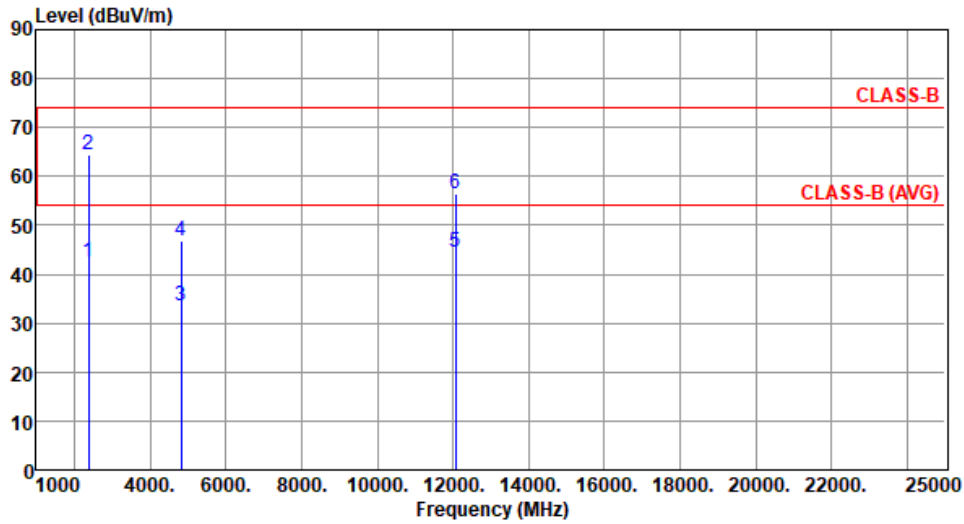

	Freq. MHz	Emission level dBUV/m	Limit dBUV/m	Margin dB	SA reading dBUV	Factor dB/m	Remark	ANT High cm	Turn Table deg
1	2390.00	42.64	54.00	-11.36	45.43	-2.79	Average	100	267
2	2390.00	64.32	74.00	-9.68	67.11	-2.79	Peak	100	267
3	4824.00	33.65	54.00	-20.35	30.18	3.47	Average	245	45
4	4824.00	46.92	74.00	-27.08	43.45	3.47	Peak	245	45
5	12060.00	44.37	54.00	-9.63	30.05	14.32	Average	100	35
6	12060.00	56.48	74.00	-17.52	42.16	14.32	Peak	100	35

Note 1: Emission Level (dBUV/m) = SA Reading (dBUV) + Factor* (dB/m)

*Factor includes antenna factor , cable loss and amplifier gain

Note 2: Margin (dB) = Emission level (dBUV/m) – Limit (dBUV/m).

Modulation	HT20	Test Freq. (MHz)	2437
Polarization	Horizontal		

Test By :Roger Lu Temperature(°C):25 Humidity(%):67

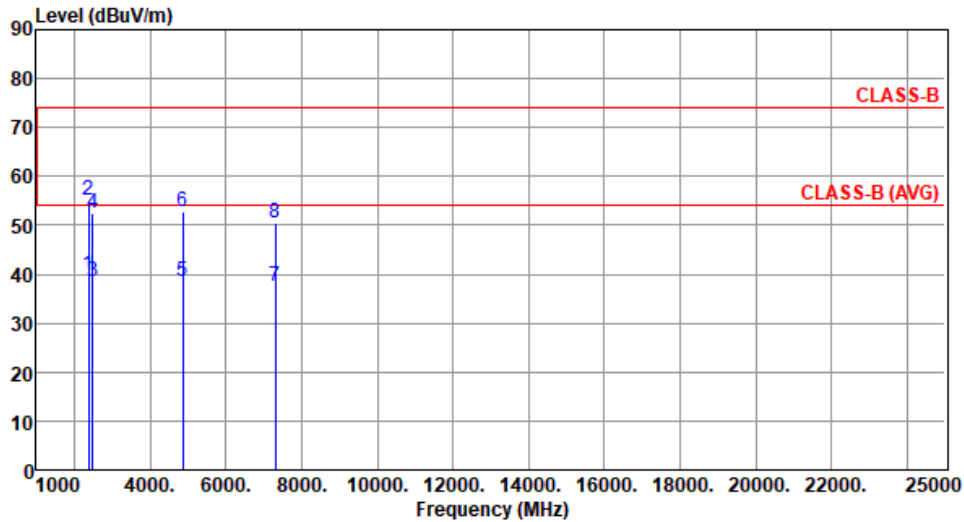

	Freq. MHz	Emission level dBuV/m	Limit dBuV/m	Margin dB	SA reading dBuV	Factor dB/m	Remark	ANT High cm	Turn Table deg
1	2390.00	39.96	54.00	-14.04	42.75	-2.79	Average	156	347
2	2390.00	55.21	74.00	-18.79	58.00	-2.79	Peak	156	347
3	2483.50	38.54	54.00	-15.46	41.28	-2.74	Average	156	347
4	2483.50	52.41	74.00	-21.59	55.15	-2.74	Peak	156	347
5	4874.00	38.45	54.00	-15.55	35.00	3.45	Average	104	265
6	4874.00	52.65	74.00	-21.35	49.20	3.45	Peak	104	265
7	7311.00	37.46	54.00	-16.54	28.47	8.99	Average	100	282
8	7311.00	50.56	74.00	-23.44	41.57	8.99	Peak	100	282

Note 1: Emission Level (dBuV/m) = SA Reading (dBuV) + Factor* (dB/m)

*Factor includes antenna factor , cable loss and amplifier gain

Note 2: Margin (dB) = Emission level (dBuV/m) – Limit (dBuV/m).

Modulation	HT20	Test Freq. (MHz)	2437
Polarization	Vertical		

Test By :Roger Lu Temperature(°C):25 Humidity(%):67

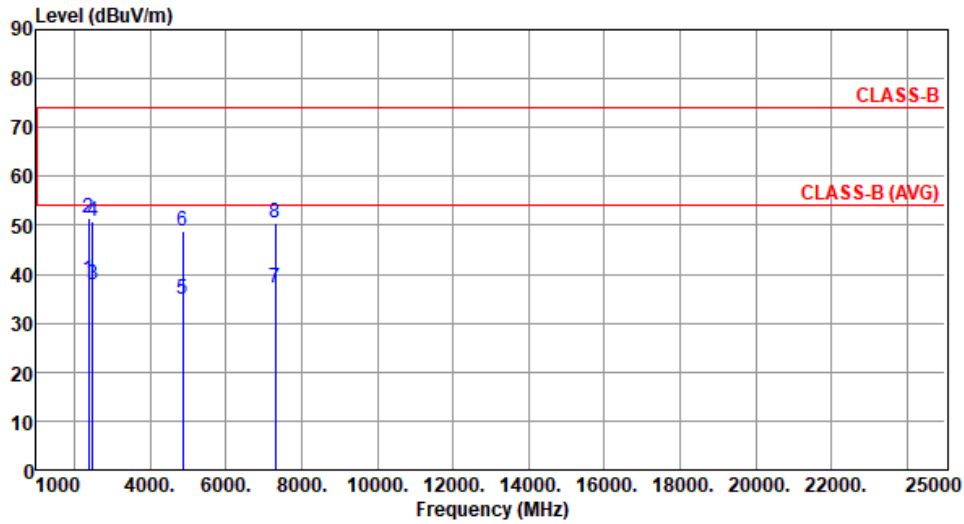

	Freq. MHz	Emission level dBuV/m	Limit dBuV/m	Margin dB	SA reading dBuV	Factor dB/m	Remark	ANT High cm	Turn Table deg
1	2390.00	38.71	54.00	-15.29	41.50	-2.79	Average	100	269
2	2390.00	51.64	74.00	-22.36	54.43	-2.79	Peak	100	269
3	2483.50	37.95	54.00	-16.05	40.69	-2.74	Average	100	269
4	2483.50	50.82	74.00	-23.18	53.56	-2.74	Peak	100	269
5	4874.00	34.95	54.00	-19.05	31.50	3.45	Average	261	47
6	4874.00	48.81	74.00	-25.19	45.36	3.45	Peak	261	47
7	7311.00	37.26	54.00	-16.74	28.27	8.99	Average	100	60
8	7311.00	50.34	74.00	-23.66	41.35	8.99	Peak	100	60

Note 1: Emission Level (dBuV/m) = SA Reading (dBuV) + Factor* (dB/m)
 *Factor includes antenna factor , cable loss and amplifier gain
 Note 2: Margin (dB) = Emission level (dBuV/m) – Limit (dBuV/m).

Modulation	HT20	Test Freq. (MHz)	2462
Polarization	Horizontal		

Test By : Akun Chung Temperature(°C): 25 Humidity(%): 67

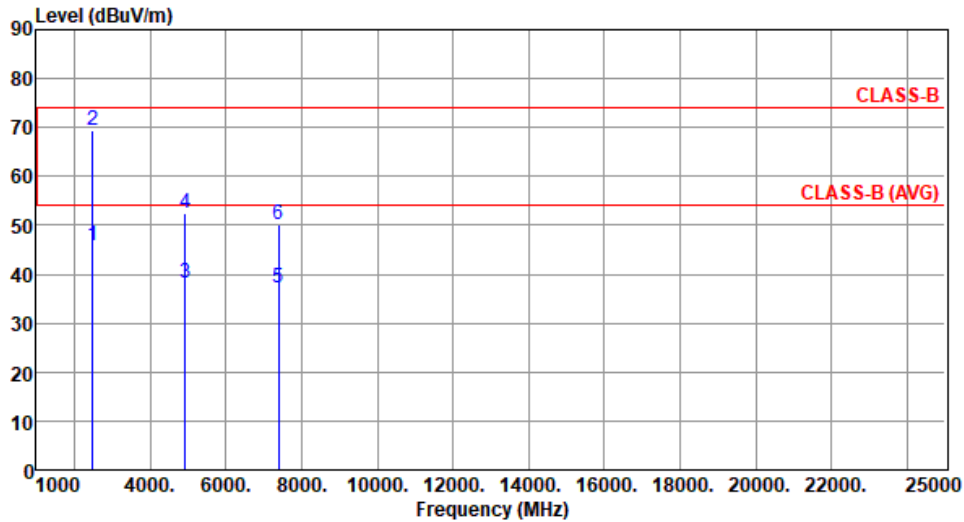

	Freq. MHz	Emission level dBuV/m	Limit dBuV/m	Margin dB	SA reading dBuV	Factor dB/m	Remark	ANT High cm	Turn Table deg
1	2483.50	45.95	54.00	-8.05	48.69	-2.74	Average	103	341
2	2483.50	69.52	74.00	-4.48	72.26	-2.74	Peak	103	341
3	4924.00	38.21	54.00	-15.79	34.66	3.55	Average	102	268
4	4924.00	52.46	74.00	-21.54	48.91	3.55	Peak	102	268
5	7386.00	37.20	54.00	-16.80	28.23	8.97	Average	100	60
6	7386.00	50.16	74.00	-23.84	41.19	8.97	Peak	100	60

Note 1: Emission Level (dBuV/m) = SA Reading (dBuV) + Factor* (dB/m)

*Factor includes antenna factor , cable loss and amplifier gain

Note 2: Margin (dB) = Emission level (dBuV/m) – Limit (dBuV/m).

Modulation	HT20	Test Freq. (MHz)	2462
Polarization	Vertical		

Test By :Akun Chung Temperature(°C):25 Humidity(%):67

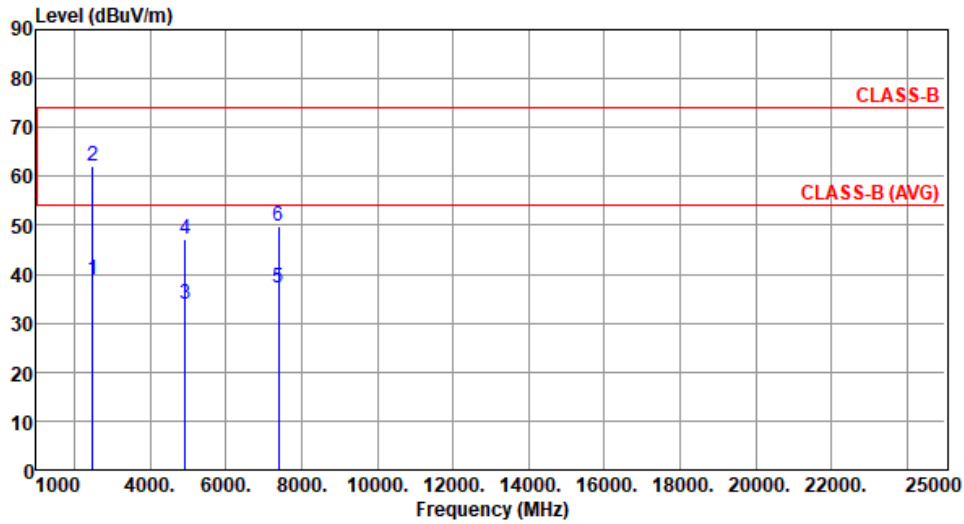

	Freq. MHz	Emission level dBuV/m	Limit dBuV/m	Margin dB	SA reading dBuV	Factor dB/m	Remark	ANT High cm	Turn Table deg
1	2483.50	38.85	54.00	-15.15	41.59	-2.74	Average	100	263
2	2483.50	61.94	74.00	-12.06	64.68	-2.74	Peak	100	263
3	4924.00	34.03	54.00	-19.97	30.48	3.55	Average	258	41
4	4924.00	47.00	74.00	-27.00	43.45	3.55	Peak	258	41
5	7386.00	37.16	54.00	-16.84	28.19	8.97	Average	100	20
6	7386.00	49.66	74.00	-24.34	40.69	8.97	Peak	100	20

Note 1: Emission Level (dBuV/m) = SA Reading (dBuV) + Factor* (dB/m)

*Factor includes antenna factor , cable loss and amplifier gain

Note 2: Margin (dB) = Emission level (dBuV/m) – Limit (dBuV/m).

3.5.8 Transmitter Radiated Unwanted Emissions (Above 1GHz) for HT40

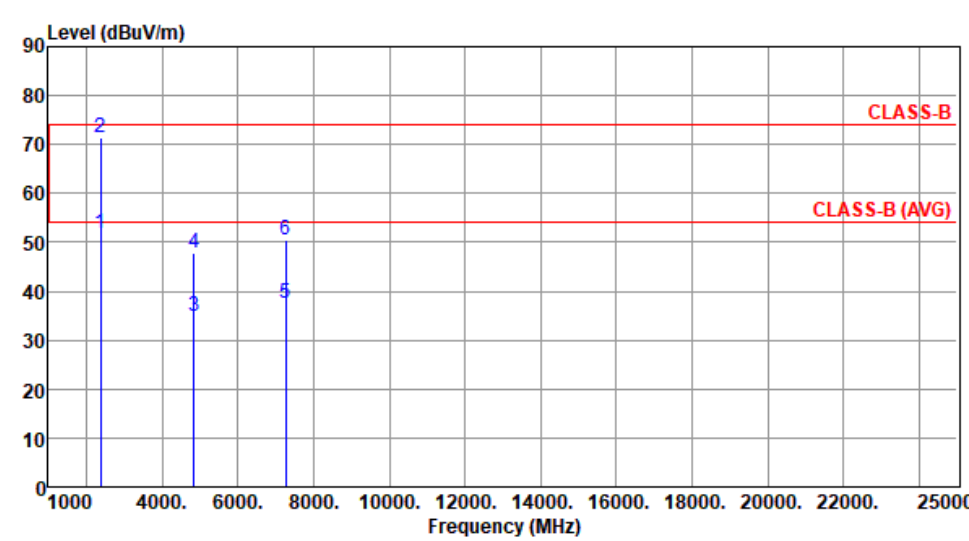
Modulation	HT40	Test Freq. (MHz)	2422						
Polarization	Horizontal								
Test By : Akun Chung Temperature(°C):25 Humidity(%):67									
									
	Freq.	Emission level	Limit	Margin	SA reading	Factor	Remark	ANT High	Turn Table
	MHz	dBuV/m	dBuV/m	dB	dBuV	dB/m		cm	deg
1	2390.00	51.75	54.00	-2.25	54.54	-2.79	Average	107	340
2	2390.00	71.48	74.00	-2.52	74.27	-2.79	Peak	107	340
3	4844.00	34.71	54.00	-19.29	31.26	3.45	Average	100	267
4	4844.00	47.83	74.00	-26.17	44.38	3.45	Peak	100	267
5	7266.00	37.46	54.00	-16.54	28.46	9.00	Average	100	40
6	7266.00	50.38	74.00	-23.62	41.38	9.00	Peak	100	40

Note 1: Emission Level (dBuV/m) = SA Reading (dBuV) + Factor* (dB/m)
*Factor includes antenna factor , cable loss and amplifier gain
Note 2: Margin (dB) = Emission level (dBuV/m) – Limit (dBuV/m).

Modulation	HT40	Test Freq. (MHz)	2422
Polarization	Vertical		

Test By : Akun Chung Temperature(°C): 25 Humidity(%): 67

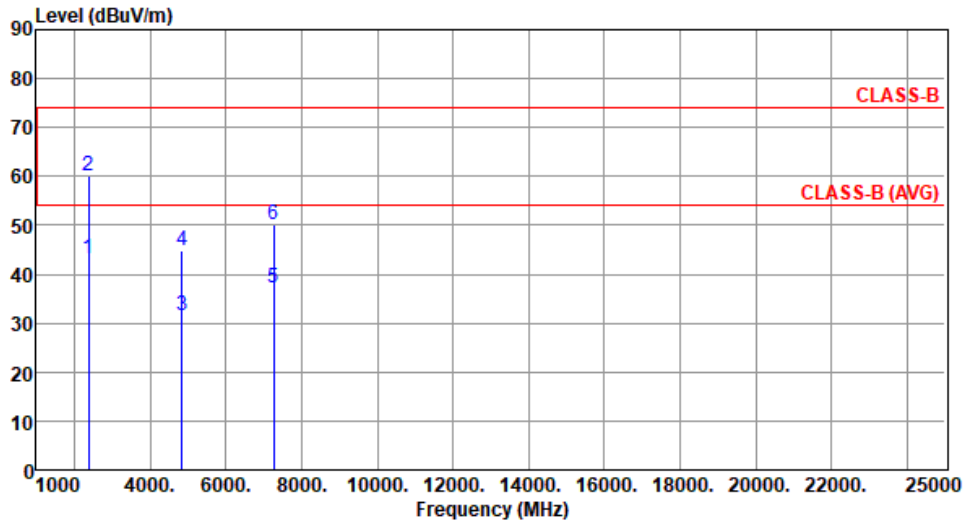

	Freq. MHz	Emission level dBuV/m	Limit dBuV/m	Margin dB	SA reading dBuV	Factor dB/m	Remark	ANT High cm	Turn Table deg
1	2390.00	43.06	54.00	-10.94	45.85	-2.79	Average	100	266
2	2390.00	60.25	74.00	-13.75	63.04	-2.79	Peak	100	266
3	4844.00	31.71	54.00	-22.29	28.26	3.45	Average	100	30
4	4844.00	45.00	74.00	-29.00	41.55	3.45	Peak	100	30
5	7266.00	37.32	54.00	-16.68	28.32	9.00	Average	100	60
6	7266.00	50.16	74.00	-23.84	41.16	9.00	Peak	100	60

Note 1: Emission Level (dBuV/m) = SA Reading (dBuV) + Factor* (dB/m)

*Factor includes antenna factor , cable loss and amplifier gain

Note 2: Margin (dB) = Emission level (dBuV/m) – Limit (dBuV/m).

Modulation	HT40	Test Freq. (MHz)	2437
Polarization	Horizontal		

Test By : Akun Chung Temperature(°C): 25 Humidity(%): 67

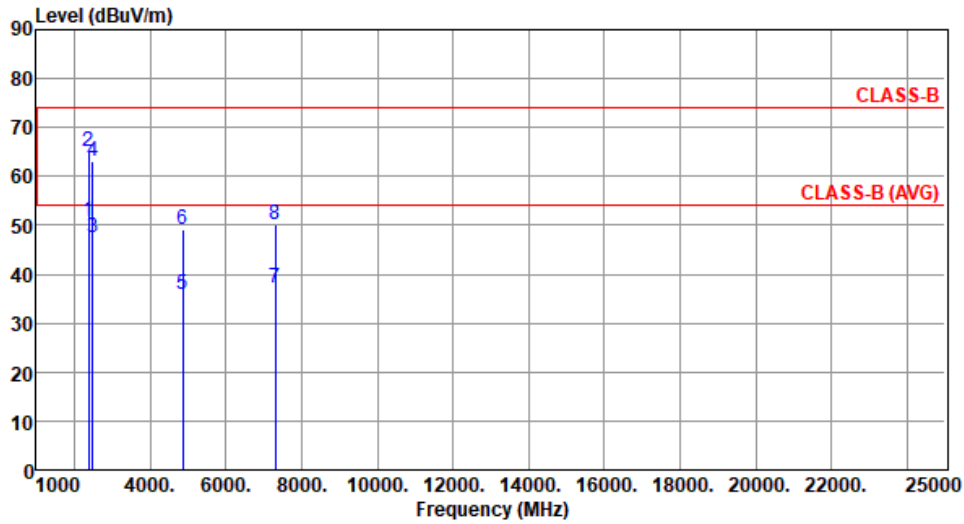

	Freq. MHz	Emission level dBuV/m	Limit dBuV/m	Margin dB	SA reading dBuV	Factor dB/m	Remark	ANT High cm	Turn Table deg
1	2390.00	50.85	54.00	-3.15	53.64	-2.79	Average	155	346
2	2390.00	65.19	74.00	-8.81	67.98	-2.79	Peak	147	346
3	2483.50	47.37	54.00	-6.63	50.11	-2.74	Average	147	346
4	2483.50	63.18	74.00	-10.82	65.92	-2.74	Peak	147	346
5	4874.00	35.91	54.00	-18.09	32.46	3.45	Average	102	263
6	4874.00	49.06	74.00	-24.94	45.61	3.45	Peak	102	263
7	7311.00	37.32	54.00	-16.68	28.33	8.99	Average	100	35
8	7311.00	50.29	74.00	-23.71	41.30	8.99	Peak	100	35

Note 1: Emission Level (dBuV/m) = SA Reading (dBuV) + Factor* (dB/m)

*Factor includes antenna factor , cable loss and amplifier gain

Note 2: Margin (dB) = Emission level (dBuV/m) – Limit (dBuV/m).

Modulation	HT40	Test Freq. (MHz)	2437
Polarization	Vertical		

Test By : Akun Chung Temperature(°C): 25 Humidity(%): 67

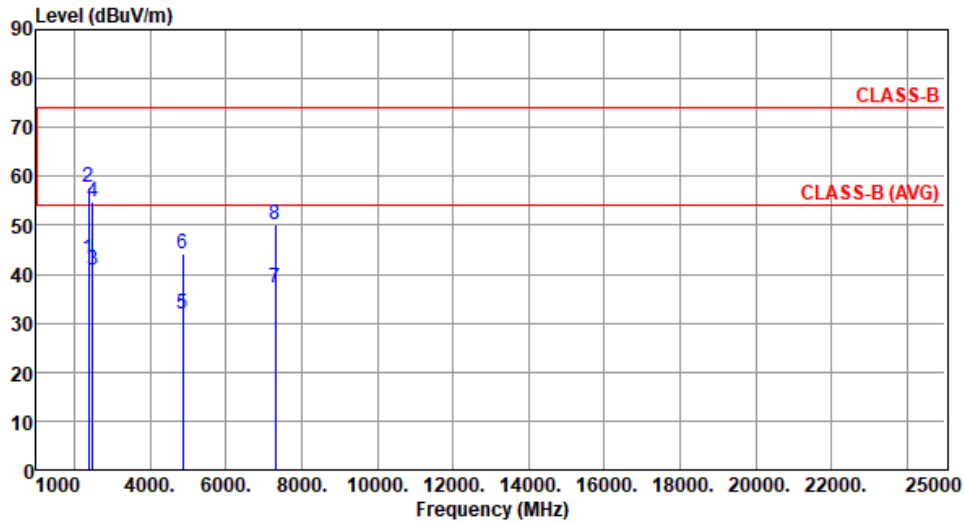

	Freq. MHz	Emission level dBuV/m	Limit dBuV/m	Margin dB	SA reading dBuV	Factor dB/m	Remark	ANT High cm	Turn Table deg
1	2390.00	43.15	54.00	-10.85	45.94	-2.79	Average	105	261
2	2390.00	57.81	74.00	-16.19	60.60	-2.79	Peak	105	261
3	2483.50	40.85	54.00	-13.15	43.59	-2.74	Average	105	261
4	2483.50	54.91	74.00	-19.09	57.65	-2.74	Peak	105	261
5	4874.00	31.72	54.00	-22.28	28.27	3.45	Average	100	40
6	4874.00	44.04	74.00	-29.96	40.59	3.45	Peak	100	40
7	7311.00	37.15	54.00	-16.85	28.16	8.99	Average	100	60
8	7311.00	50.15	74.00	-23.85	41.16	8.99	Peak	100	60

Note 1: Emission Level (dBuV/m) = SA Reading (dBuV) + Factor* (dB/m)

*Factor includes antenna factor , cable loss and amplifier gain

Note 2: Margin (dB) = Emission level (dBuV/m) – Limit (dBuV/m).

Modulation	HT40	Test Freq. (MHz)	2452
Polarization	Horizontal		

Test By : Akun Chung Temperature(°C): 25 Humidity(%): 67

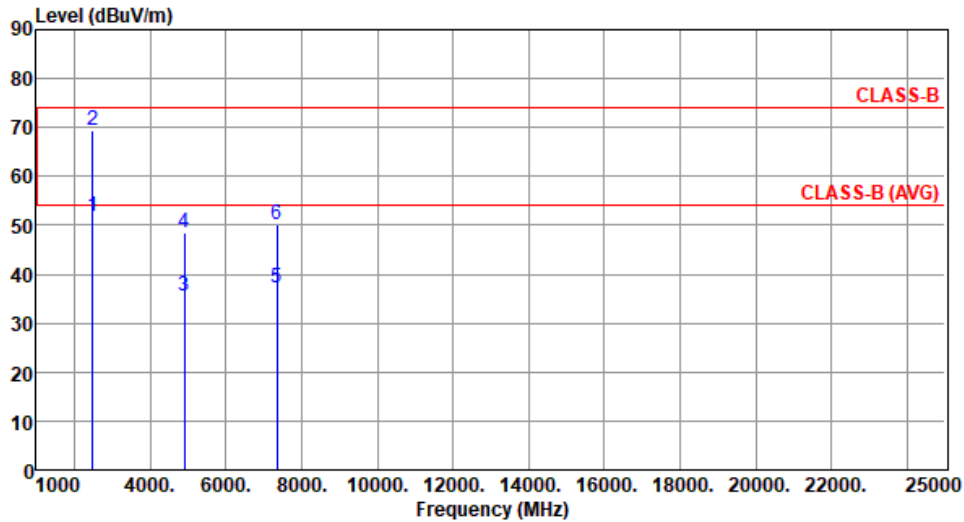

	Freq. MHz	Emission level dBuV/m	Limit dBuV/m	Margin dB	SA reading dBuV	Factor dB/m	Remark	ANT High cm	Turn Table deg
1	2483.50	51.86	54.00	-2.14	54.60	-2.74	Average	148	354
2	2483.50	69.25	74.00	-4.75	71.99	-2.74	Peak	148	354
3	4904.00	35.50	54.00	-18.50	32.01	3.49	Average	105	267
4	4904.00	48.33	74.00	-25.67	44.84	3.49	Peak	105	267
5	7356.00	37.34	54.00	-16.66	28.29	9.05	Average	100	50
6	7356.00	50.16	74.00	-23.84	41.11	9.05	Peak	100	50

Note 1: Emission Level (dBuV/m) = SA Reading (dBuV) + Factor* (dB/m)

*Factor includes antenna factor , cable loss and amplifier gain

Note 2: Margin (dB) = Emission level (dBuV/m) – Limit (dBuV/m).

Modulation	HT40	Test Freq. (MHz)	2452
Polarization	Vertical		

Test By :Akun Chung Temperature(°C):25 Humidity(%):67

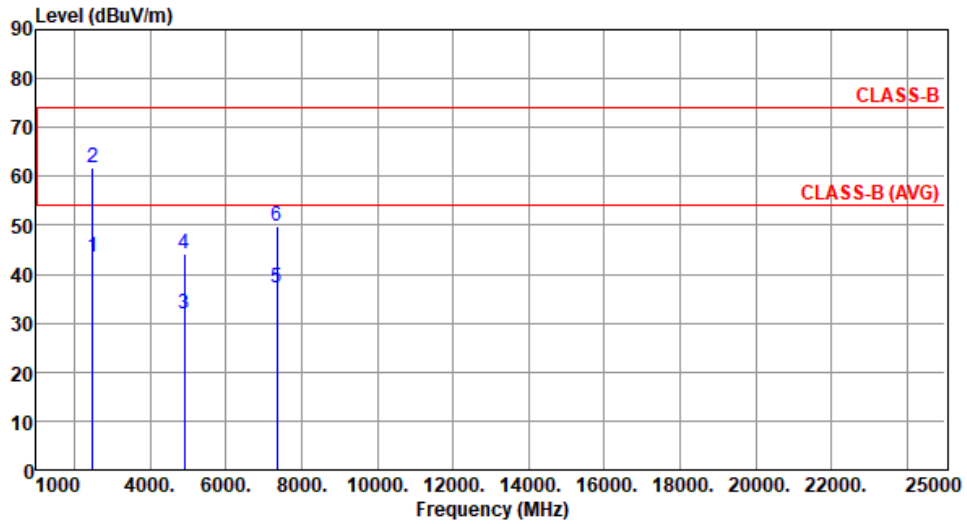

	Freq. MHz	Emission level dBuV/m	Limit dBuV/m	Margin dB	SA reading dBuV	Factor dB/m	Remark	ANT High cm	Turn Table deg
1	2483.50	43.62	54.00	-10.38	46.36	-2.74	Average	100	263
2	2483.50	61.68	74.00	-12.32	64.42	-2.74	Peak	100	263
3	4904.00	31.95	54.00	-22.05	28.46	3.49	Average	100	60
4	4904.00	44.17	74.00	-29.83	40.68	3.49	Peak	100	60
5	7356.00	37.20	54.00	-16.80	28.15	9.05	Average	100	30
6	7356.00	49.70	74.00	-24.30	40.65	9.05	Peak	100	30

Note 1: Emission Level (dBuV/m) = SA Reading (dBuV) + Factor* (dB/m)

*Factor includes antenna factor , cable loss and amplifier gain

Note 2: Margin (dB) = Emission level (dBuV/m) – Limit (dBuV/m).

3.6 Emissions in Non-Restricted Frequency Bands

3.6.1 Emissions in Non-Restricted Frequency Bands Limit

Peak power in any 100 kHz bandwidth outside of the authorized frequency band shall be attenuated by at least 20 dB relative to the maximum in-band peak PSD level in 100 kHz.

3.6.2 Test Procedures

Reference level measurement

1. Set RBW=100kHz, VBW = 300kHz , Detector = Peak, Sweep time = Auto
2. Trace = max hold , Allow Trace to fully stabilize
3. Use the peak marker function to determine the maximum PSD level

Emission level measurement

1. Set RBW=100kHz, VBW = 300kHz , Detector = Peak, Sweep time = Auto
2. Trace = max hold , Allow Trace to fully stabilize
3. Scan Frequency range is up to 25GHz
4. Use the peak marker function to determine the maximum amplitude level

3.6.3 Test Setup

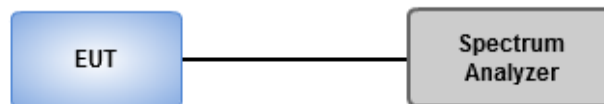

3.6.4 Unwanted Emissions into Non-Restricted Frequency Bands

Ambient Condition	22°C / 64%	Tested By	Aska Huang
-------------------	------------	-----------	------------

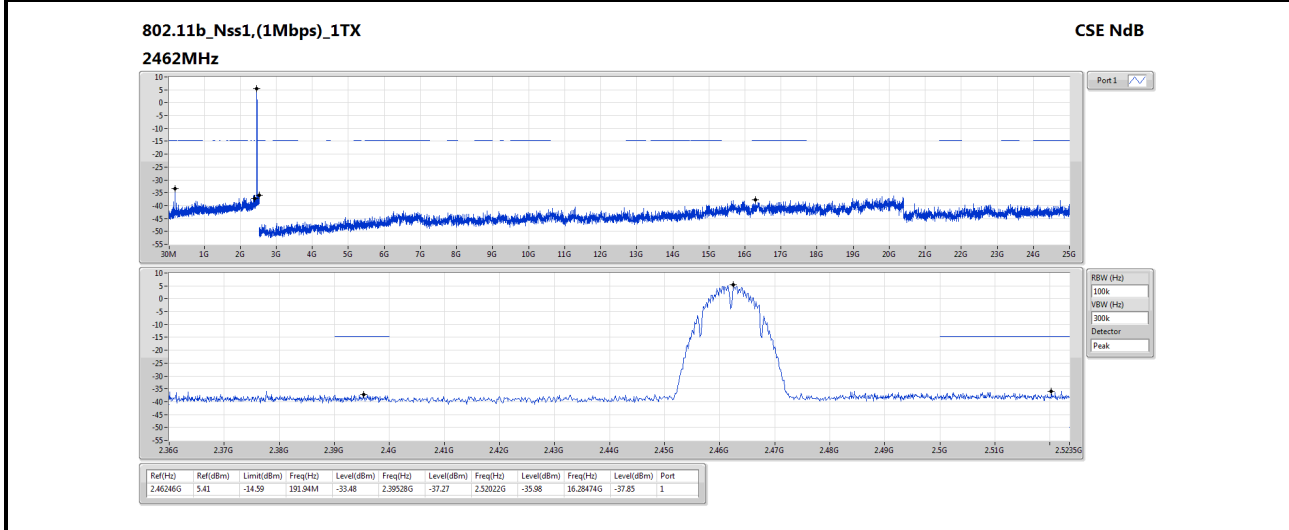
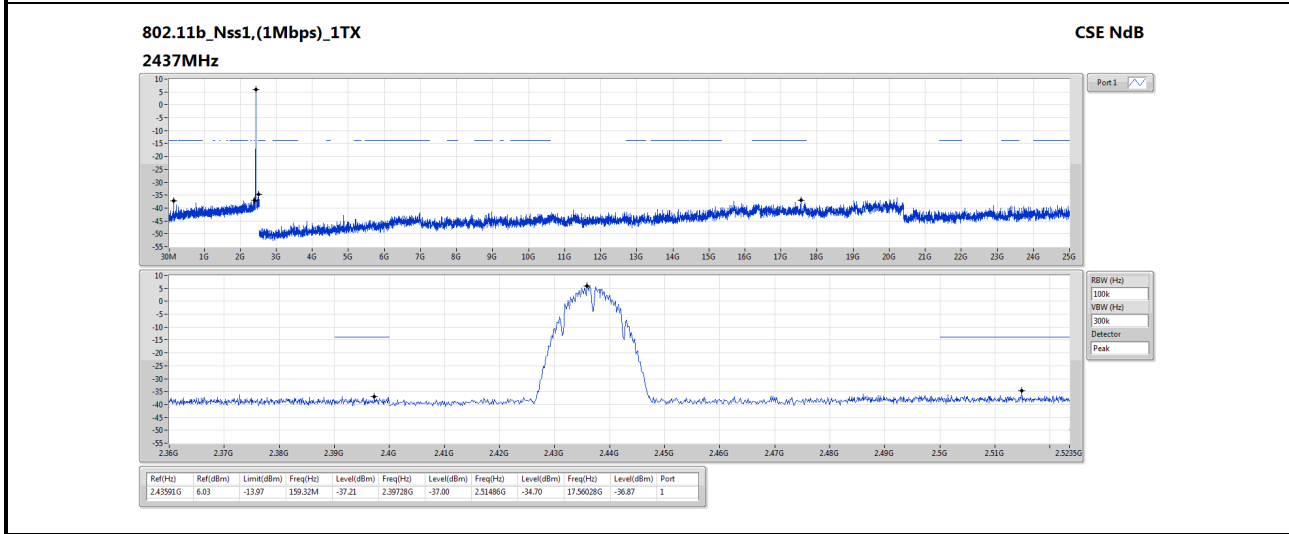
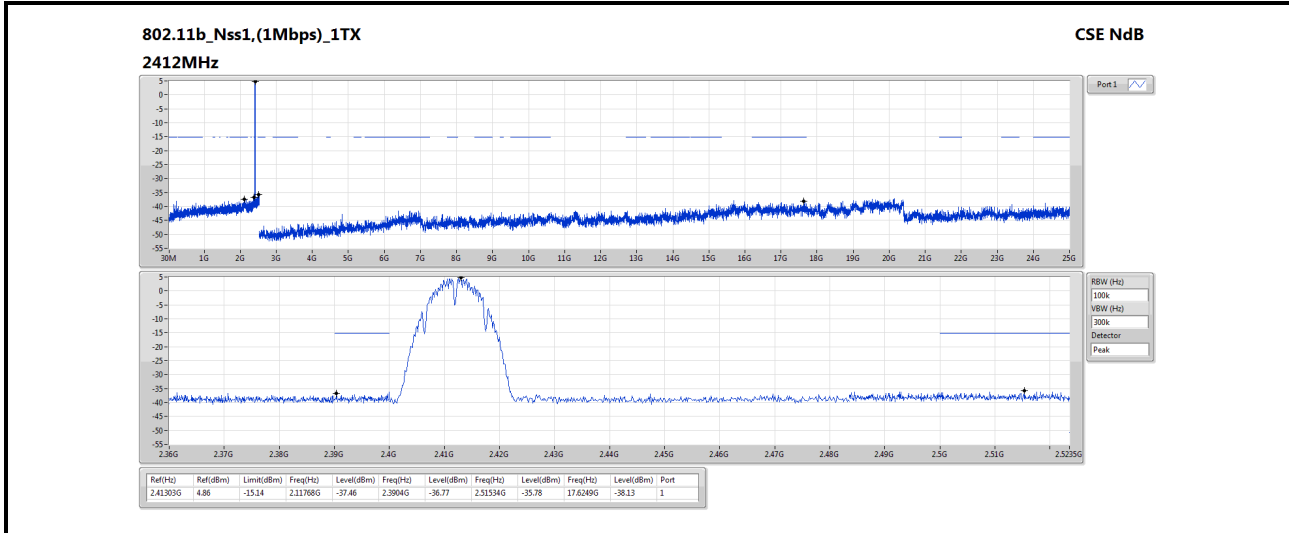

802.11g_Nss1,(6Mbps)_1TX
2412MHz

CSE NdB

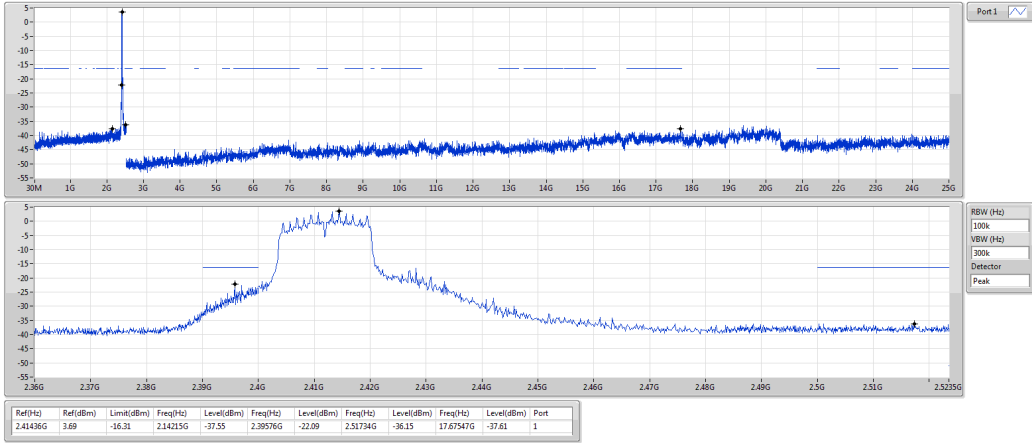

802.11g_Nss1,(6Mbps)_1TX
2437MHz

CSE NdB

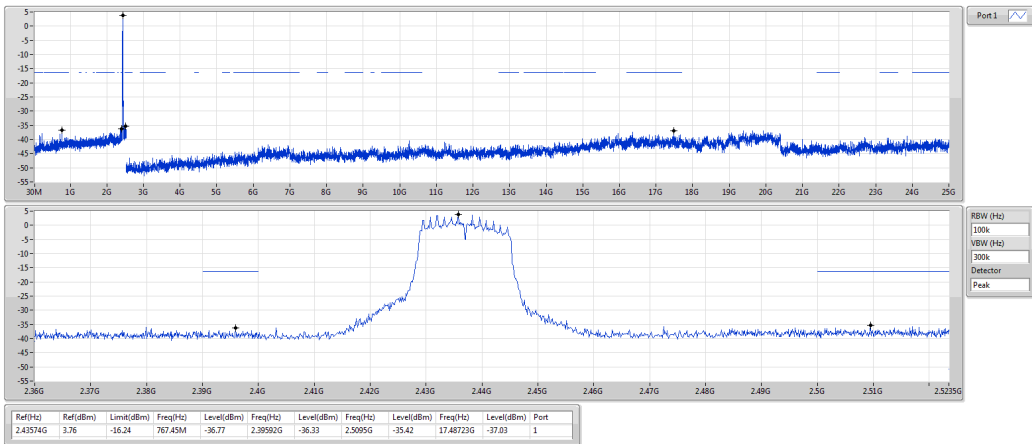

802.11g_Nss1,(6Mbps)_1TX
2462MHz

CSE NdB

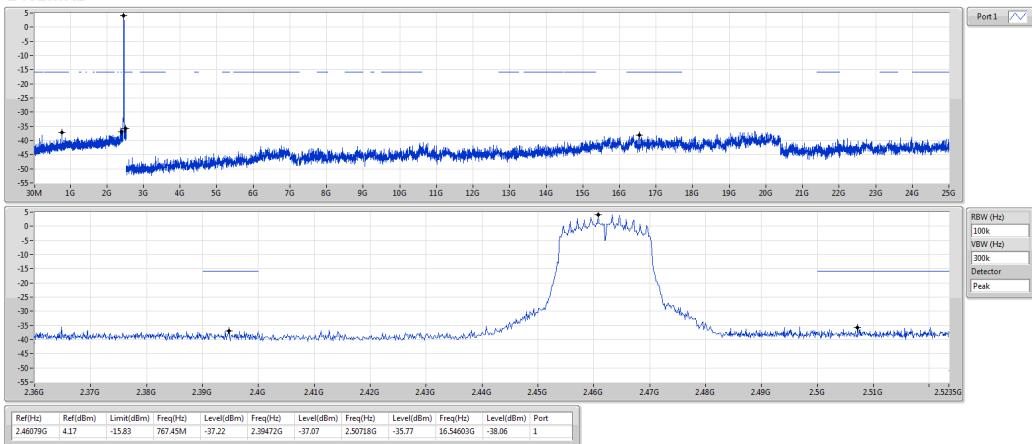

802.11n HT20_Nss1,(MCS0)_1TX
2412MHz

CSE NdB

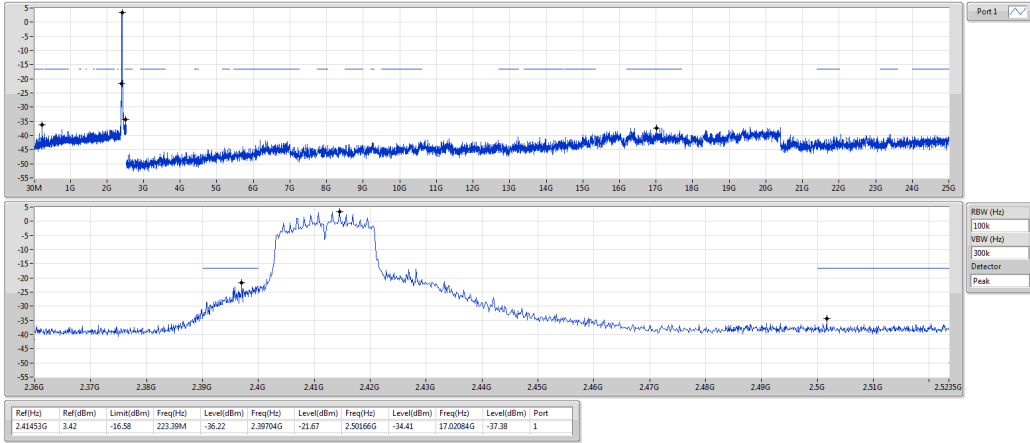

802.11n HT20_Nss1,(MCS0)_1TX
2437MHz

CSE NdB

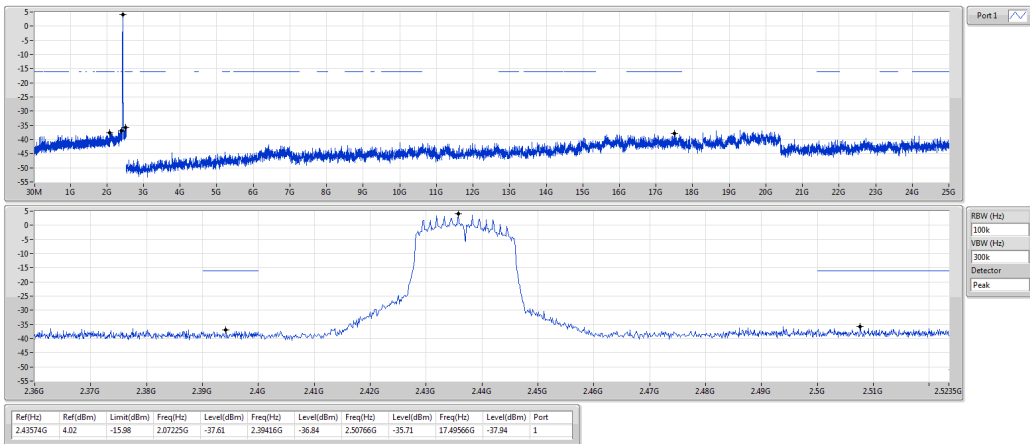

802.11n HT20_Nss1,(MCS0)_1TX
2462MHz

CSE NdB

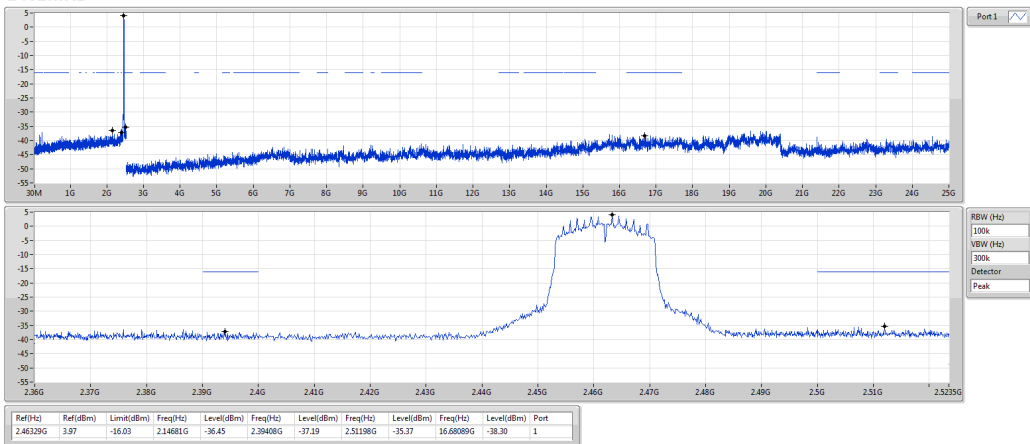

802.11n HT40_Nss1,(MCS0)_1TX
2422MHz

CSE NdB

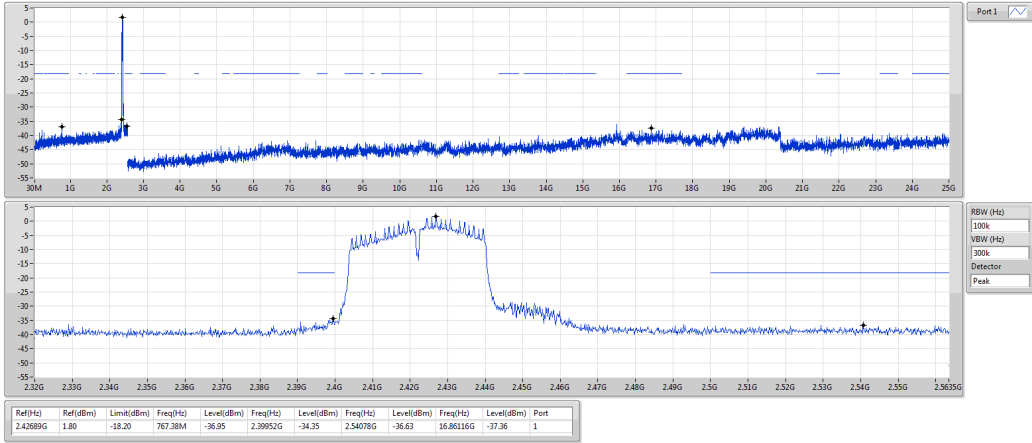

802.11n HT40_Nss1,(MCS0)_1TX
2437MHz

CSE NdB

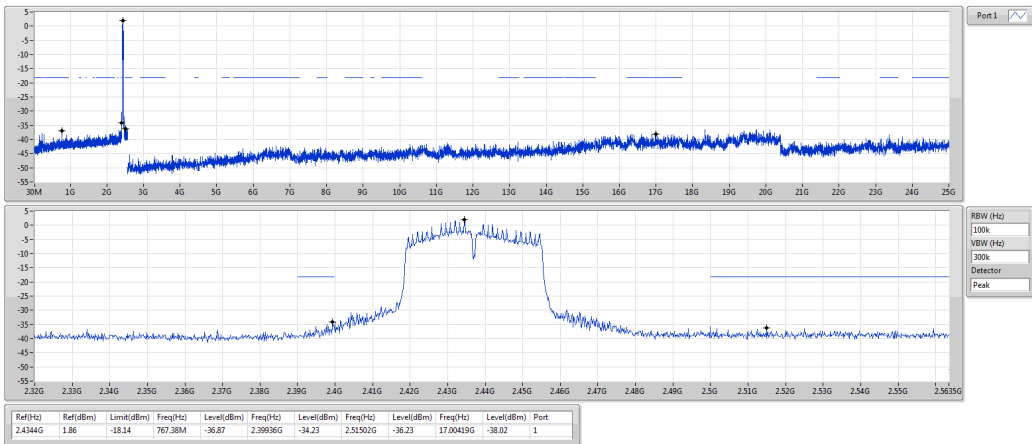

802.11n HT40_Nss1,(MCS0)_1TX
2452MHz

CSE NdB

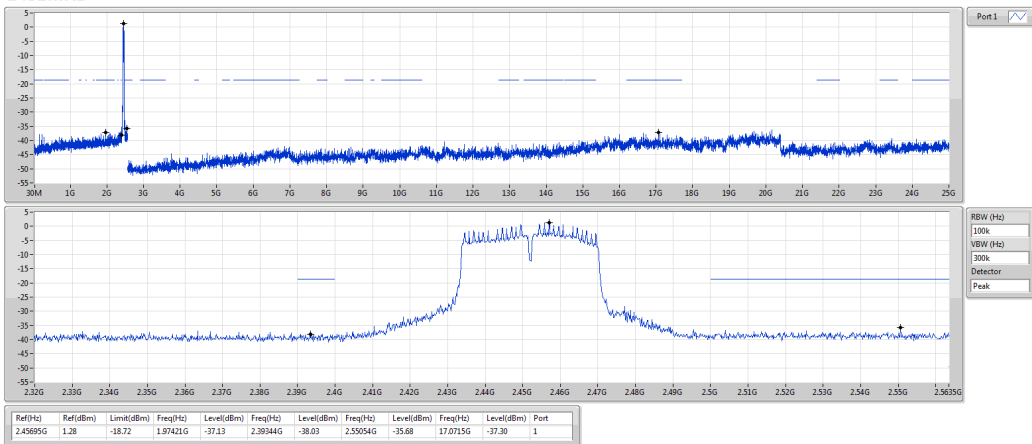

4 Test laboratory information

Established in 2012, ICC provides foremost EMC & RF Testing and advisory consultation services by our skilled engineers and technicians. Our services employ a wide variety of advanced edge test equipment and one of the widest certification extents in the business.

International Certification Corporation (EMC and Wireless Communication Laboratory), it is our definitive objective is to institute long term, trust-based associations with our clients. The expectation we set up with our clients is based on outstanding service, practical expertise and devotion to a certified value structure. Our passion is to grant our clients with best EMC / RF services by oriented knowledgeable and accommodating staff.

Our Test sites are located at Linkou District and Kwei Shan District. Location map can be found on our website <http://www.icertifi.com.tw>.

Linkou

Tel: 886-2-2601-1640

No.30-2, Ding Fwu Tsuen, Lin Kou
District, New Taipei City, Taiwan
(R.O.C.)

Kwei Shan

Tel: 886-3-271-8666

No.3-1, Lane 6, Wen San 3rd
St., Kwei Shan Dist., Tao Yuan
City 33381, Taiwan (R.O.C.)
No.2-1, Lane 6, Wen San 3rd
St., Kwei Shan Dist., Tao Yuan
City 33381, Taiwan (R.O.C.)

Kwei Shan Site II

Tel: 886-3-271-8640

No.14-1, Lane 19, Wen San 3rd
St., Kwei Shan Dist., Tao Yuan
City 333, Taiwan (R.O.C.)

If you have any suggestion, please feel free to contact us as below information.

Tel: 886-3-271-8666

Fax: 886-3-318-0345

Email: ICC_Service@icertifi.com.tw

==END==