

FCC Test Report

Report No.: RF171005C05A

FCC ID: REP-8020-1

Test Model: HotPort 8020

Received Date: Oct. 05, 2017

Test Date: Oct. 23 ~ Dec. 22, 2017

Issued Date: Jan. 03, 2018

Applicant: Firetide Inc.

Address: Firetide Inc. A Division of UNICOM GLOBAL 2105, South Bascom Avenue, Suite 220, Campbell, California, United States, 950008

Issued By: Bureau Veritas Consumer Products Services (H.K.) Ltd., Taoyuan Branch

Lab Address: No. 47-2, 14th Ling, Chia Pau Vil., Lin Kou Dist., New Taipei City, Taiwan (R.O.C.)

Test Location: No. 19, Hwa Ya 2nd Rd., Wen Hwa Vil., Kwei Shan Dist., Taoyuan City 33383, TAIWAN (R.O.C.)

FCC Registration / 788550 / TW0003

Designation Number:



This report is for your exclusive use. Any copying or replication of this report to or for any other person or entity, or use of our name or trademark, is permitted only with our prior written permission. This report sets forth our findings solely with respect to the test samples identified herein. The results set forth in this report are not indicative or representative of the quality or characteristics of the lot from which a test sample was taken or any similar or identical product unless specifically and expressly noted. Our report includes all of the tests requested by you and the results thereof based upon the information that you provided to us. You have 60 days from date of issuance of this report to notify us of any material error or omission caused by our negligence, provided, however, that such notice shall be in writing and shall specifically address the issue you wish to raise. A failure to raise such issue within the prescribed time shall constitute your unqualified acceptance of the completeness of this report, the tests conducted and the correctness of the report contents. Unless specific mention, the uncertainty of measurement has been explicitly taken into account to declare the compliance or non-compliance to the specification. The report must not be used by the client to claim product certification, approval, or endorsement by TAF or any government agencies.

Table of Contents

| | |
|---|-----------|
| Release Control Record | 4 |
| 1 Certificate of Conformity | 5 |
| 2 Summary of Test Results | 6 |
| 2.1 Measurement Uncertainty..... | 6 |
| 2.2 Modification Record..... | 6 |
| 3 General Information | 7 |
| 3.1 General Description of EUT..... | 7 |
| 3.2 Description of Test Modes..... | 10 |
| 3.2.1 Test Mode Applicability and Tested Channel Detail..... | 11 |
| 3.3 Duty Cycle of Test Signal..... | 13 |
| 3.4 Description of Support Units..... | 17 |
| 3.4.1 Configuration of System under Test..... | 17 |
| 3.5 General Description of Applied Standards..... | 17 |
| 4 Test Types and Results | 18 |
| 4.1 Radiated Emission and Bandedge Measurement..... | 18 |
| 4.1.1 Limits of Radiated Emission and Bandedge Measurement..... | 18 |
| 4.1.2 Test Instruments..... | 19 |
| 4.1.3 Test Procedures..... | 20 |
| 4.1.4 Deviation from Test Standard..... | 20 |
| 4.1.5 Test Setup..... | 21 |
| 4.1.6 EUT Operating Conditions..... | 22 |
| 4.1.7 Test Results..... | 23 |
| 4.2 Conducted Emission Measurement..... | 123 |
| 4.2.1 Limits of Conducted Emission Measurement..... | 123 |
| 4.2.2 Test Instruments..... | 123 |
| 4.2.3 Test Procedures..... | 124 |
| 4.2.4 Deviation from Test Standard..... | 124 |
| 4.2.5 Test Setup..... | 124 |
| 4.2.6 EUT Operating Conditions..... | 124 |
| 4.2.7 Test Results..... | 125 |
| 4.3 Transmit Power Measurement..... | 133 |
| 4.3.1 Limits of Transmit Power Measurement..... | 133 |
| 4.3.2 Test Setup..... | 133 |
| 4.3.3 Test Instruments..... | 134 |
| 4.3.4 Test Procedure..... | 134 |
| 4.3.5 Deviation from Test Standard..... | 134 |
| 4.3.6 EUT Operating Conditions..... | 134 |
| 4.3.7 Test Result..... | 135 |
| 4.4 Occupied Bandwidth Measurement..... | 184 |
| 4.4.1 Test Setup..... | 184 |
| 4.4.2 Test Instruments..... | 184 |
| 4.4.3 Test Procedure..... | 184 |
| 4.4.4 Test Result..... | 185 |
| 4.5 Peak Power Spectral Density Measurement..... | 197 |
| 4.5.1 Limits of Peak Power Spectral Density Measurement..... | 197 |
| 4.5.2 Test Setup..... | 197 |
| 4.5.3 Test Instruments..... | 197 |
| 4.5.4 Test Procedures..... | 198 |
| 4.5.5 Deviation from Test Standard..... | 198 |
| 4.5.6 EUT Operating Conditions..... | 198 |
| 4.5.7 Test Results..... | 199 |
| 4.6 Frequency Stability..... | 223 |

| | | |
|----------|---|------------|
| 4.6.1 | Limits of Frequency Stability Measurement | 223 |
| 4.6.2 | Test Setup..... | 223 |
| 4.6.3 | Test Instruments | 223 |
| 4.6.4 | Test Procedure | 223 |
| 4.6.5 | Deviation from Test Standard | 223 |
| 4.6.6 | EUT Operating Condition | 223 |
| 4.6.7 | Test Results | 224 |
| 4.7 | 6dB Bandwidth Measurement..... | 226 |
| 4.7.1 | Limits of 6dB Bandwidth Measurement..... | 226 |
| 4.7.2 | Test Setup..... | 226 |
| 4.7.3 | Test Instruments | 226 |
| 4.7.4 | Test Procedure | 226 |
| 4.7.5 | Deviation from Test Standard | 226 |
| 4.7.6 | EUT Operating Condition | 226 |
| 4.7.7 | Test Results | 227 |
| 5 | Pictures of Test Arrangements..... | 235 |
| | Appendix – Information on the Testing Laboratories | 236 |

Release Control Record

| Issue No. | Description | Date Issued |
|--------------|-------------------|---------------|
| RF171005C05A | Original release. | Jan. 03, 2018 |

1 Certificate of Conformity

Product: Firetide Wireless Mesh Node
Brand: Firetide
Test Model: HotPort 8020
Sample Status: Engineering sample
Applicant: Firetide Inc.
Test Date: Oct. 23 ~ Dec. 22, 2017
Standards: 47 CFR FCC Part 15, Subpart E (Section 15.407)
ANSI C63.10:2013

The above equipment has been tested by **Bureau Veritas Consumer Products Services (H.K.) Ltd., Taoyuan Branch**, and found compliance with the requirement of the above standards. The test record, data evaluation & Equipment Under Test (EUT) configurations represented herein are true and accurate accounts of the measurements of the sample's RF characteristics under the conditions specified in this report.

Prepared by : *Suntee Liu* , **Date:** Jan. 03, 2018
Suntee Liu / Specialist

Approved by : *Bruce Chen* , **Date:** Jan. 03, 2018
Bruce Chen / Project Engineer

2 Summary of Test Results

| 47 CFR FCC Part 15, Subpart E (Section 15.407) | | | |
|--|--|--------|---|
| FCC Clause | Test Item | Result | Remarks |
| 15.407(b)(6) | AC Power Conducted Emissions | Pass | Meet the requirement of limit. Minimum passing margin is -3.10dB at 0.53240MHz. |
| 15.407(b)(1/2/3/4(i/ii)/6) | Radiated Emissions & Band Edge Measurement | Pass | Meet the requirement of limit. Minimum passing margin is -1.0dB at 5725.00MHz. |
| 15.407(a)(1/2/3) | Max Average Transmit Power | Pass | Meet the requirement of limit. |
| --- | Occupied Bandwidth Measurement | - | Reference only. |
| 15.407(a)(1/2/3) | Peak Power Spectral Density | Pass | Meet the requirement of limit. |
| 15.407(e) | 6dB bandwidth | Pass | Meet the requirement of limit. (U-NII-3 Band only) |
| 15.407(g) | Frequency Stability | Pass | Meet the requirement of limit. |
| 15.203 | Antenna Requirement | Pass | Antenna connector is N Plug. (The device is professionally installed) |

*For U-NII-3 Band compliance with rule part 15.407(b)(4)(i), the OOB test plots were recorded in Annex A.

2.1 Measurement Uncertainty

Where relevant, the following measurement uncertainty levels have been estimated for tests performed on the EUT as specified in CISPR 16-4-2:

| Measurement | Frequency | Expanded Uncertainty (k=2) (±) |
|------------------------------------|------------------|--------------------------------|
| Conducted Emissions at mains ports | 150kHz ~ 30MHz | 2.94 dB |
| Radiated Emissions up to 1 GHz | 30MHz ~ 200MHz | 3.86 dB |
| | 200MHz ~ 1000MHz | 3.87 dB |
| Radiated Emissions above 1 GHz | 1GHz ~ 18GHz | 2.29 dB |
| | 18GHz ~ 40GHz | 2.29 dB |

2.2 Modification Record

There were no modifications required for compliance.

3 General Information

3.1 General Description of EUT

| | |
|-----------------------|---|
| Product | Firetide Wireless Mesh Node |
| Brand | Firetide |
| Test Model | HotPort 8020 |
| Sample Status | Engineering sample |
| Power Supply Rating | 54Vdc (POE) |
| Modulation Type | 256QAM, 64QAM, 16QAM, QPSK, BPSK |
| Modulation Technology | OFDM |
| Transfer Rate | 802.11a: 54/48/36/24/18/12/9/6Mbps 802.11n: up to 300Mbps 802.11ac: up to 867Mbps |
| Operating Frequency | 5260~5320MHz, 5500~5720MHz |
| Number of Channel | 5260~5320MHz: 802.11a, 802.11n (HT20), 802.11ac (VHT20): 4 802.11n (HT40), 802.11ac (VHT40): 2 802.11ac (VHT80): 1 5500~5720MHz: 802.11a, 802.11n (HT20), 802.11ac (VHT20): 12 802.11n (HT40), 802.11ac (VHT40): 6 802.11ac (VHT80): 3 |
| Output Power | Refer to Note |
| Antenna Type | Refer to Note |
| Antenna Connector | Refer to Note |
| Accessory Device | NA |
| Cable Supplied | 1.8m non-shielded ground cable without core |

Note:

1. This report is prepared for FCC class II permissive change. The difference compared with the original report (BV CPS report no.: RF171005C05) is adding 5.26GHz to 5.32GHz and 5.50GHz to 5.72GHz by software.
2. The EUT incorporates a MIMO function. Physically, the EUT provides 4 completed transmitters and 4 receivers.

| Modulation Mode | TX Function | Beamforming |
|------------------|-------------|-------------|
| 802.11a | 4TX | Not Support |
| 802.11n (HT20) | 4TX | Support |
| 802.11n (HT40) | 4TX | Support |
| 802.11ac (VHT20) | 4TX | Support |
| 802.11ac (VHT40) | 4TX | Support |
| 802.11ac (VHT80) | 4TX | Support |

* The modulation and bandwidth are similar for 802.11n mode for HT20/HT40 and 802.11ac mode for VHT20/VHT40, therefore investigated worst case to representative mode in test report. (Final test mode refer section 3.2.1)

* CDD mode is the worst case for final tests after pretesting CDD mode and beamforming mode except output power test.

3. The EUT consumes power from following POE. (Support units only)

| POE | |
|--------------|---|
| Brand | EnGenius |
| Model | EPA5006GAT |
| Input Power | 100-240Vac, 0.8A, 50-60Hz |
| Output Power | 54Vdc, 0.6A |
| Power Cable | 0.5m non-shielded AC cable without core |

4. The EUT uses following antennas.

| No. | Function | Antenna Type | Connector | Gain (dBi) | | Remark |
|-----|----------|--------------|-----------|------------|------|-------------------|
| | | | | 4.9G | 5G | |
| 1 | WLAN | Dipole | N Plug | 6.5 | 7 | Radio 1 / Radio 2 |
| 2 | WLAN | Panel | N Plug | 17.5 | 18.5 | Radio 1 / Radio 2 |

* Antenna 2 was cross-polarized antenna, the antenna has +45 H -45 V four polarizations, only three will be co-polarized. so direction gain = $18.5 + 10\log(3) = 23.27\text{dBi}$.

5. Radio 1, 5GHz & Radio 2, 5GHz / Radio 1, 4.9GHz & Radio 2, 4.9GHz can transmit at same time but cannot transmit at same channel.
6. Spurious emission of the simultaneous operation (Radio 1, 5GHz & Radio 2, 5GHz / Radio 1, 4.9GHz & Radio 2, 4.9GHz) has been evaluated and no non-compliance was found.

7. Output Power is listed as below.

| Radio 1, Antenna 1 | | | |
|----------------------|------------------|-------------------|--------------------|
| Frequency Band (MHz) | Mode | Output Power (mW) | Output Power (dBm) |
| 5260~5320 | CDD Mode | 90.387 | 19.56 |
| | Beamforming Mode | 22.597 | 13.54 |
| 5500~5720 | CDD Mode | 136.723 | 21.36 |
| | Beamforming Mode | 34.181 | 15.34 |
| Radio 1, Antenna 2 | | | |
| Frequency Band (MHz) | Mode | Output Power (mW) | Output Power (dBm) |
| 5260~5320 | CDD Mode | 6.895 | 8.39 |
| | Beamforming Mode | 1.724 | 2.36 |
| 5500~5720 | CDD Mode | 6.970 | 8.43 |
| | Beamforming Mode | 1.743 | 2.41 |
| Radio 2, Antenna 1 | | | |
| Frequency Band (MHz) | Mode | Output Power (mW) | Output Power (dBm) |
| 5260~5320 | CDD Mode | 84.859 | 19.29 |
| | Beamforming Mode | 21.215 | 13.27 |
| 5500~5720 | CDD Mode | 136.723 | 21.36 |
| | Beamforming Mode | 34.181 | 15.34 |
| Radio 2, Antenna 2 | | | |
| Frequency Band (MHz) | Mode | Output Power (mW) | Output Power (dBm) |
| 5260~5320 | CDD Mode | 6.838 | 8.35 |
| | Beamforming Mode | 1.710 | 2.33 |
| 5500~5720 | CDD Mode | 6.925 | 8.40 |
| | Beamforming Mode | 1.731 | 2.38 |

3.2 Description of Test Modes

5260~5320MHz:

4 channels are provided for 802.11a, 802.11n (HT20), 802.11ac (VHT20):

| Channel | Frequency | Channel | Frequency |
|---------|-----------|---------|-----------|
| 52 | 5260 MHz | 60 | 5300 MHz |
| 56 | 5280 MHz | 64 | 5320 MHz |

2 channels are provided for 802.11n (HT40), 802.11ac (VHT40):

| Channel | Frequency | Channel | Frequency |
|---------|-----------|---------|-----------|
| 54 | 5270 MHz | 62 | 5310 MHz |

1 channel is provided for 802.11ac (VHT80):

| Channel | Frequency |
|---------|-----------|
| 58 | 5290MHz |

5500~5720MHz:

12 channels are provided for 802.11a, 802.11n (HT20), 802.11ac (VHT20):

| Channel | Frequency | Channel | Frequency |
|---------|-----------|---------|-----------|
| 100 | 5500 MHz | 124 | 5620 MHz |
| 104 | 5520 MHz | 128 | 5640 MHz |
| 108 | 5540 MHz | 132 | 5660 MHz |
| 112 | 5560 MHz | 136 | 5680 MHz |
| 116 | 5580 MHz | 140 | 5700 MHz |
| 120 | 5600 MHz | 144 | 5720 MHz |

6 channels are provided for 802.11n (HT40), 802.11ac (VHT40):

| Channel | Frequency | Channel | Frequency |
|---------|-----------|---------|-----------|
| 102 | 5510 MHz | 126 | 5630 MHz |
| 110 | 5550 MHz | 134 | 5670 MHz |
| 118 | 5590 MHz | 142 | 5710 MHz |

3 channels are provided for 802.11ac (VHT80):

| Channel | Frequency | Channel | Frequency |
|---------|-----------|---------|-----------|
| 106 | 5530 MHz | 122 | 5610 MHz |
| 138 | 5690 MHz | | |

3.2.1 Test Mode Applicability and Tested Channel Detail

| EUT Configure Mode | Applicable to | | | | Description |
|--------------------|---------------|-------|-----|------|--------------------|
| | RE \geq 1G | RE<1G | PLC | APCM | |
| A1 | √ | √ | √ | √ | Radio 1, Antenna 1 |
| A2 | √ | √ | √ | √ | Radio 1, Antenna 2 |
| B1 | √ | √ | √ | √ | Radio 2, Antenna 1 |
| B2 | √ | √ | √ | √ | Radio 2, Antenna 2 |

Where RE \geq 1G: Radiated Emission above 1GHz & Bandedge Measurement
 RE<1G: Radiated Emission below 1GHz
 PLC: Power Line Conducted Emission
 APCM: Antenna Port Conducted Measurement

Note:

1. The EUT had been pre-tested on the positioned of each 3 axis. The worst case was found when positioned on Y-plane for mode A1, B1 and X-plane for mode A2, B2.

Radiated Emission Test (Above 1GHz):

- Pre-Scan has been conducted to determine the worst-case mode from all possible combinations between available modulations, data rates and antenna ports (if EUT with antenna diversity architecture).
- Following channel(s) was (were) selected for the final test as listed below.

| EUT Configure Mode | Mode | Frequency Band (MHz) | Available Channel | Tested Channel | Modulation Technology | Data Rate (Mbps) | Remark |
|--------------------|------------------|----------------------|-------------------|--------------------|-----------------------|------------------|--------|
| A1, A2, B1, B2 | 802.11a | 5260-5320 | 52 to 64 | 52, 60, 64 | OFDM | 6.0 | - |
| | 802.11n (HT20) | | 52 to 64 | 52, 60, 64 | OFDM | 6.5 / MCS0 | - |
| | 802.11n (HT40) | | 54 to 62 | 54, 62 | OFDM | 13.5 / MCS0 | - |
| | 802.11ac (VHT80) | | 58 | 58 | OFDM | 29.3 / MCS0 | - |
| | 802.11a | 5500-5720 | 100 to 144 | 100, 116, 140, 144 | OFDM | 6.0 | - |
| | 802.11n (HT20) | | 100 to 144 | 100, 116, 140, 144 | OFDM | 6.5 / MCS0 | - |
| | 802.11n (HT40) | | 102 to 142 | 102, 110, 134, 142 | OFDM | 13.5 / MCS0 | - |
| | 802.11ac (VHT80) | | 106 to 138 | 106, 122, 138 | OFDM | 29.3 / MCS0 | - |

Radiated Emission Test (Below 1GHz):

- Pre-Scan has been conducted to determine the worst-case mode from all possible combinations between available modulations, data rates and antenna ports (if EUT with antenna diversity architecture).
- Following channel(s) was (were) selected for the final test as listed below.

| EUT Configure Mode | Mode | Frequency Band (MHz) | Available Channel | Tested Channel | Modulation Technology | Data Rate (Mbps) | Remark |
|--------------------|---------|----------------------|-------------------|----------------|-----------------------|------------------|--------|
| A1, A2, B1, B2 | 802.11a | 5260-5320 | 52 to 64 | 52 | OFDM | 6.0 | - |
| | 802.11a | 5500-5720 | 100 to 144 | | OFDM | 6.0 | - |

Power Line Conducted Emission Test:

- Pre-Scan has been conducted to determine the worst-case mode from all possible combinations between available modulations, data rates and antenna ports (if EUT with antenna diversity architecture).
- Following channel(s) was (were) selected for the final test as listed below.

| EUT Configure Mode | Mode | Frequency Band (MHz) | Available Channel | Tested Channel | Modulation Technology | Data Rate (Mbps) | Remark |
|--------------------|---------|----------------------|-------------------|----------------|-----------------------|------------------|--------|
| A1, A2, B1, B2 | 802.11a | 5260-5320 | 52 to 64 | 52 | OFDM | 6.0 | - |
| | 802.11a | 5500-5720 | 100 to 144 | | OFDM | 6.0 | - |

Antenna Port Conducted Measurement:

- This item includes all test value of each mode, but only includes spectrum plot of worst value of each mode.
- Pre-Scan has been conducted to determine the worst-case mode from all possible combinations between available modulations, data rates and antenna ports (if EUT with antenna diversity architecture).
- Following channel(s) was (were) selected for the final test as listed below.

| EUT Configure Mode | Mode | Frequency Band (MHz) | Available Channel | Tested Channel | Modulation Technology | Data Rate (Mbps) | Remark |
|--------------------|------------------|----------------------|-------------------|--------------------|-----------------------|------------------|--------|
| A1, A2, B1, B2 | 802.11a | 5260-5320 | 52 to 64 | 52, 60, 64 | OFDM | 6.0 | - |
| | 802.11n (HT20) | | 52 to 64 | 52, 60, 64 | OFDM | 6.5 / MCS0 | - |
| | 802.11n (HT40) | | 54 to 62 | 54, 62 | OFDM | 13.5 / MCS0 | - |
| | 802.11ac (VHT80) | | 58 | 58 | OFDM | 29.3 / MCS0 | - |
| | 802.11a | 5500-5720 | 100 to 144 | 100, 116, 140, 144 | OFDM | 6.0 | - |
| | 802.11n (HT20) | | 100 to 144 | 100, 116, 140, 144 | OFDM | 6.5 / MCS0 | - |
| | 802.11n (HT40) | | 102 to 142 | 102, 110, 134, 142 | OFDM | 13.5 / MCS0 | - |
| | 802.11ac (VHT80) | | 106 to 138 | 106, 122, 138 | OFDM | 29.3 / MCS0 | - |

Test Condition:

| Applicable to | Environmental Conditions | Input Power (system) | Tested by |
|---------------|--|----------------------|----------------------------|
| RE \geq 1G | 23 deg. C, 69% RH 24 deg. C, 66% RH | 120Vac, 60Hz | Jones Chang Willy Cheng |
| RE<1G | 23 deg. C, 69% RH 25 deg. C, 69% RH | 120Vac, 60Hz | Jones Chang Adair Peng |
| PLC | 25 deg. C, 75% RH | 120Vac, 60Hz | Jones Chang |
| APCM | 25 deg. C, 60% RH | 120Vac, 60Hz | Han Wu Ted Chang |

3.3 Duty Cycle of Test Signal

Duty cycle of test signal is $\geq 98\%$, duty factor is not required.

Duty cycle of test signal is $< 98\%$, duty factor is required.

Mode A1

802.11a: Duty cycle = $2.02/2.12 = 0.953$, Duty factor = $10 * \log(1/0.953) = 0.21$

802.11n (HT20): Duty cycle = $4.995/5.085 = 0.982$

802.11n (HT40): Duty cycle = $2.425/2.497 = 0.971$, Duty factor = $10 * \log(1/0.971) = 0.13$

802.11ac (VHT80): Duty cycle = $1.14/1.21 = 0.942$, Duty factor = $10 * \log(1/0.942) = 0.26$



Mode A2

802.11a: Duty cycle = 2.02/2.12 = 0.953, Duty factor = $10 * \log(1/0.953) = 0.21$

802.11n (HT20): Duty cycle = 4.995/5.085 = 0.982

802.11n (HT40): Duty cycle = 2.425/2.497 = 0.971, Duty factor = $10 * \log(1/0.971) = 0.13$

802.11ac (VHT80): Duty cycle = 1.14/1.21 = 0.942, Duty factor = $10 * \log(1/0.942) = 0.26$



Mode B1

802.11a: Duty cycle = 2.02/2.12 = 0.953, Duty factor = $10 \cdot \log(1/0.953) = 0.21$

802.11n (HT20): Duty cycle = 4.995/5.085 = 0.982

802.11n (HT40): Duty cycle = 2.425/2.497 = 0.971, Duty factor = $10 \cdot \log(1/0.971) = 0.13$

802.11ac (VHT80): Duty cycle = 1.14/1.21 = 0.942, Duty factor = $10 \cdot \log(1/0.942) = 0.26$



Mode B2

802.11a: Duty cycle = $2.042/2.122 = 0.962$, Duty factor = $10 * \log(1/0.962) = 0.17$

802.11n (HT20): Duty cycle = $4.99/5.075 = 0.983$

802.11n (HT40): Duty cycle = $2.425/2.497 = 0.971$, Duty factor = $10 * \log(1/0.971) = 0.13$

802.11ac (VHT80): Duty cycle = $1.14/1.21 = 0.942$, Duty factor = $10 * \log(1/0.942) = 0.26$

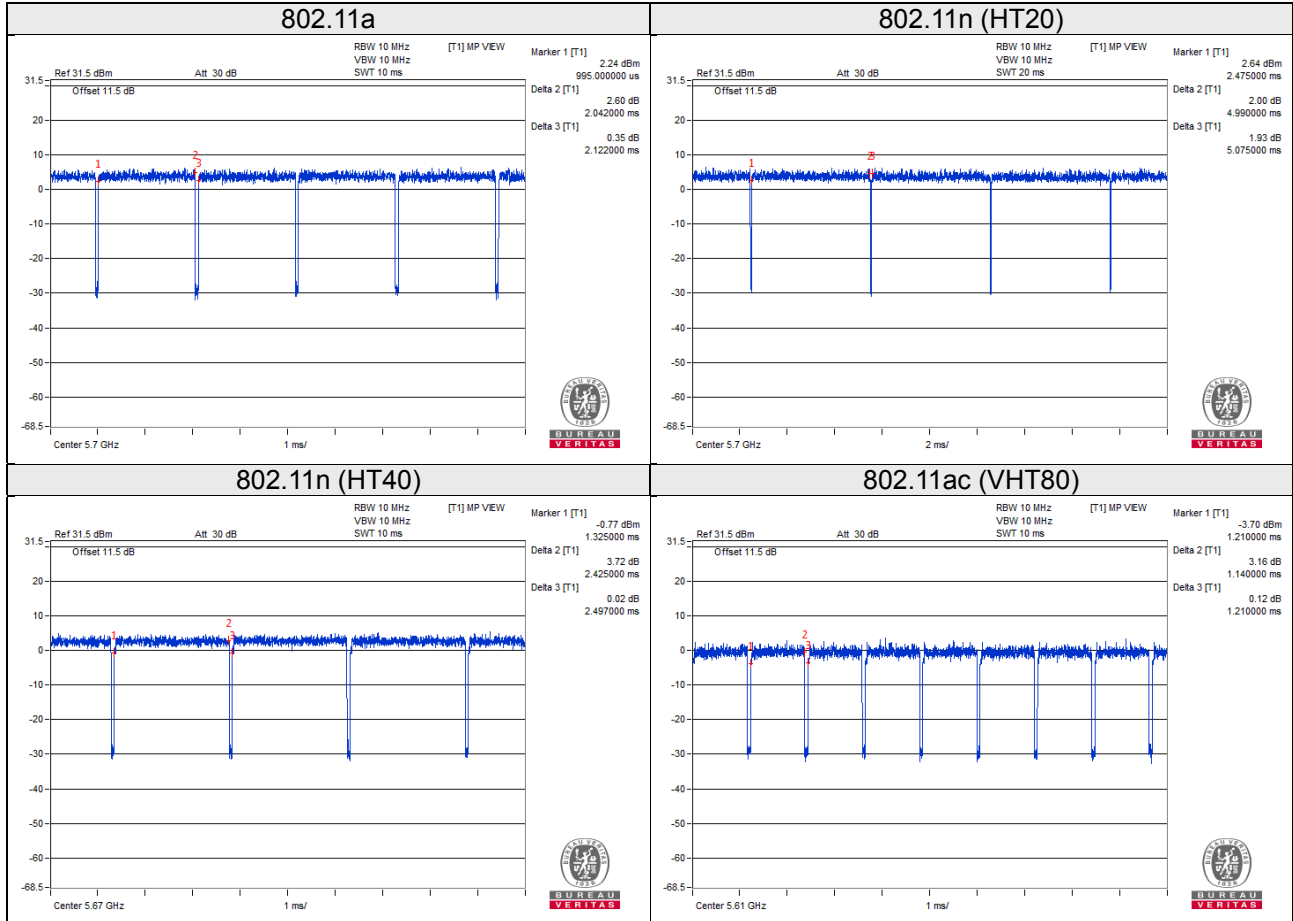

3.4 Description of Support Units

The EUT has been tested as an independent unit together with other necessary accessories or support units. The following support units or accessories were used to form a representative test configuration during the tests.

| ID | Product | Brand | Model No. | Serial No. | FCC ID | Remarks |
|----|----------|----------|------------|------------|------------------|------------------------------|
| A. | Notebook | DELL | E5410 | 1HC2XM1 | FCC DoC Approved | - |
| B. | POE | EnGenius | EPA5006GAT | NA | NA | Supplied by the manufacturer |
| C. | Load | NA | NA | NA | NA | - |

Note:

1. All power cords of the above support units are non-shielded (1.8m).
2. Item A acted as a communication partner to transfer data.

| ID | Descriptions | Qty. | Length (m) | Shielding (Yes/No) | Cores (Qty.) | Remarks |
|----|--------------|------|------------|--------------------|--------------|---------|
| 1. | RJ45, Cat5e | 1 | 10 | N | 0 | - |
| 2. | RJ45, Cat5e | 1 | 1.5 | N | 0 | - |
| 3. | RJ45, Cat5e | 1 | 1.5 | N | 0 | - |
| 4. | RJ45, Cat5e | 1 | 1.5 | N | 0 | - |

3.4.1 Configuration of System under Test

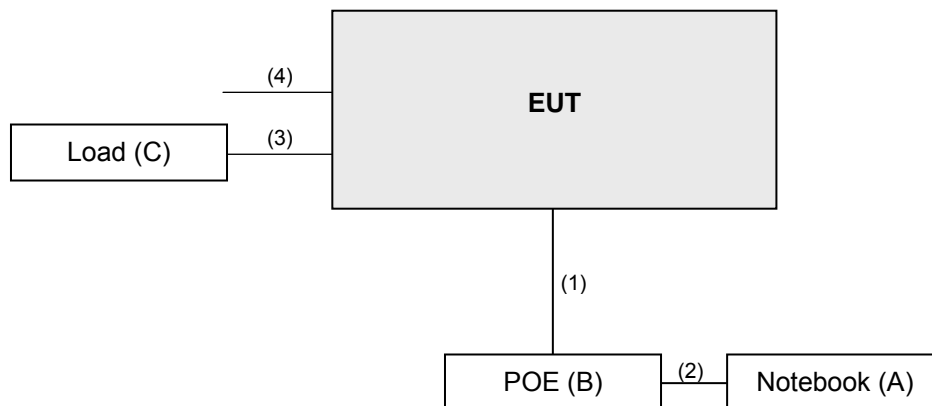

3.5 General Description of Applied Standards

The EUT is a RF Product. According to the specifications of the manufacturer, it must comply with the requirements of the following standards:

FCC Part 15, Subpart E (15.407)

KDB 789033 D02 General UNII Test Procedure New Rules v02r01

662911 D01 Multiple Transmitter Output v02r01

ANSI C63.10:2013

All test items have been performed and recorded as per the above standards.

Note: The EUT has been verified to comply with the requirements of FCC Part 15, Subpart B, Class B (DoC). The test report has been issued separately.

4 Test Types and Results

4.1 Radiated Emission and Bandedge Measurement

4.1.1 Limits of Radiated Emission and Bandedge Measurement

Radiated emissions which fall in the restricted bands must comply with the radiated emission limits specified as below table.

FCC PART 15.209:

| Frequencies (MHz) | Field Strength (microvolts/meter) | Measurement Distance (meters) |
|-------------------|-----------------------------------|-------------------------------|
| 0.009 ~ 0.490 | 2400/F(kHz) | 300 |
| 0.490 ~ 1.705 | 24000/F(kHz) | 30 |
| 1.705 ~ 30.0 | 30 | 30 |
| 30 ~ 88 | 100 | 3 |
| 88 ~ 216 | 150 | 3 |
| 216 ~ 960 | 200 | 3 |
| Above 960 | 500 | 3 |

NOTE:

1. The lower limit shall apply at the transition frequencies.
2. Emission level (dBuV/m) = 20 log Emission level (uV/m).
3. For frequencies above 1000MHz, the field strength limits are based on average detector, however, the peak field strength of any emission shall not exceed the maximum permitted average limits, specified above by more than 20dB under any condition of modulation.

Limits of unwanted emission out of the restricted bands

| Applicable To | | Limit | |
|---|---|--|---|
| 789033 D02 General UNII Test Procedure New Rules v02r01 | | Field Strength at 3m | |
| | | PK: 74 (dBuV/m) | AV: 54 (dBuV/m) |
| Frequency Band | Applicable To | EIRP Limit | Equivalent Field Strength at 3m |
| 5150~5250 MHz | 15.407(b)(1) | PK: -27 (dBm/MHz) | PK: 68.2(dBuV/m) |
| 5250~5350 MHz | 15.407(b)(2) | | |
| 5470~5725 MHz | 15.407(b)(3) | | |
| 5725~5850 MHz | <input checked="" type="checkbox"/> 15.407(b)(4)(i) | PK: -27 (dBm/MHz) ^{*1} PK: 10 (dBm/MHz) ^{*2} PK: 15.6 (dBm/MHz) ^{*3} PK: 27 (dBm/MHz) ^{*4} | PK: 68.2 (dBuV/m) ^{*1} PK: 105.2 (dBuV/m) ^{*2} PK: 110.8 (dBuV/m) ^{*3} PK: 122.2 (dBuV/m) ^{*4} |
| | <input type="checkbox"/> 15.407(b)(4)(ii) | Emission limits in section 15.247(d) | |
| ^{*1} beyond 75 MHz or more above of the band edge. ^{*3} below the band edge increasing linearly to a level of 15.6 dBm/MHz at 5 MHz above. | | ^{*2} below the band edge increasing linearly to 10 dBm/MHz at 25 MHz above. ^{*4} from 5 MHz above or below the band edge increasing linearly to a level of 27 dBm/MHz at the band edge. | |

Note: The following formula is used to convert the equipment isotropic radiated power (eirp) to field strength:

$$E = \frac{1000000 \sqrt{30P}}{3} \quad \mu\text{V/m, where } P \text{ is the eirp (Watts).}$$

4.1.2 Test Instruments

| Description & Manufacturer | Model No. | Serial No. | Cal. Date | Cal. Due |
|---|---------------------------------------|---------------------------------|---------------|---------------|
| Test Receiver ROHDE & SCHWARZ | ESIB7 | 100187 | May 02, 2017 | May 01, 2018 |
| Spectrum Analyzer ROHDE & SCHWARZ | FSP40 | 100040 | Aug. 18, 2017 | Aug. 17, 2018 |
| BILOG Antenna SCHWARZBECK | VULB9168 | 9168-171 | Dec. 28, 2016 | Dec. 27, 2017 |
| HORN Antenna SCHWARZBECK | 9120D | 209 | Dec. 27, 2016 | Dec. 26, 2017 |
| HORN Antenna SCHWARZBECK | BBHA 9170 | BBHA9170241 | Dec. 14, 2016 | Dec. 13, 2017 |
| | | | Dec. 01, 2017 | Nov. 30, 2018 |
| Loop Antenna EMCI | EM-6879 | 269 | Aug. 11, 2017 | Aug. 10, 2018 |
| Preamplifier Agilent (Below 1GHz) | 8447D | 2944A10738 | Aug. 21, 2017 | Aug. 20, 2018 |
| Preamplifier Agilent (Above 1GHz) | 8449B | 3008A02465 | Apr. 05, 2017 | Apr. 04, 2018 |
| RF signal cable HUBER+SUHNER | SUCOFLEX 104 | Cable-CH3-03 (223653/4) | Aug. 21, 2017 | Aug. 20, 2018 |
| RF signal cable HUBER+SUHNER& EMCI | SUCOFLEX 104&EMC104-SM-SM-8 000 | Cable-CH3-03 (309224+170907) | Sep.11, 2017 | Sep. 10, 2018 |
| Software BV ADT | ADT_Radiated_ V7.6.15.9.4 | NA | NA | NA |
| Antenna Tower inn-co GmbH | MA 4000 | 013303 | NA | NA |
| Antenna Tower Controller BV ADT | AT100 | AT93021702 | NA | NA |
| Turn Table BV ADT | TT100 | TT93021702 | NA | NA |
| Turn Table Controller BV ADT | SC100 | SC93021702 | NA | NA |
| 26GHz ~ 40GHz Amplifier Agilent | 8449B | 3008A1960 | Aug. 08, 2017 | Aug. 07, 2018 |
| High Speed Peak Power Meter | ML2495A | 0824012 | Aug. 18, 2017 | Aug. 17, 2018 |
| Power Sensor | MA2411B | 0738171 | Aug. 18, 2017 | Aug. 17, 2018 |
| WIT Standard Temperature And Humidity Chamber | TH-4S-C | W981030 | Jun. 07, 2017 | Jun. 06, 2018 |

- Note: 1. The calibration interval of the above test instruments is 12 months and the calibrations are traceable to NML/ROC and NIST/USA.
2. The test was performed in HwaYa Chamber 3.
3. The horn antenna and preamplifier (model: 8449B) are used only for the measurement of emission frequency above 1GHz if tested.
4. The FCC Designation Number is TW0003. The number will be varied with the Lab location and scope as attached.
5. The IC Site Registration No. is IC 7450F-3.

4.1.3 Test Procedures

For Radiated emission below 30MHz

- a. The EUT was placed on the top of a rotating table 0.8 meters above the ground at a 3 meter chamber room. The table was rotated 360 degrees to determine the position of the highest radiation.
- b. The EUT was set 3 meters away from the interference-receiving antenna, which was mounted on the top of a variable-height antenna tower.
- c. Both X and Y axes of the antenna are set to make the measurement.
- d. For each suspected emission, the EUT was arranged to its worst case and the rotatable table was turned from 0 degrees to 360 degrees to find the maximum reading.
- e. The test-receiver system was set to Quasi-Peak Detect Function and Specified Bandwidth with Maximum Hold Mode.

Note:

1. The resolution bandwidth and video bandwidth of test receiver/spectrum analyzer is 9kHz at frequency below 30MHz.

For Radiated emission above 30MHz

- a. The EUT was placed on the top of a rotating table 0.8 meters (for 30MHz ~ 1GHz) / 1.5 meters (for above 1GHz) above the ground at 3 meter chamber room for test. The table was rotated 360 degrees to determine the position of the highest radiation.
- b. The EUT was set 3 meters away from the interference-receiving antenna, which was mounted on the top of a variable-height antenna tower.
- c. The height of antenna is varied from one meter to four meters above the ground to determine the maximum value of the field strength. Both horizontal and vertical polarizations of the antenna are set to make the measurement.
- d. For each suspected emission, the EUT was arranged to its worst case and then the antenna was tuned to heights from 1 meter to 4 meters and the rotatable table was turned from 0 degrees to 360 degrees to find the maximum reading.
- e. The test-receiver system was set to quasi-peak detect function and specified bandwidth with maximum hold mode when the test frequency is below 1 GHz.
- f. The test-receiver system was set to peak and average detect function and specified bandwidth with maximum hold mode when the test frequency is above 1 GHz. If the peak reading value also meets average limit, measurement with the average detector is unnecessary.

Note:

1. The resolution bandwidth and video bandwidth of test receiver/spectrum analyzer is 120kHz for Quasi-peak detection (QP) at frequency below 1GHz.
2. The resolution bandwidth of test receiver/spectrum analyzer is 1 MHz and the video bandwidth is 3 MHz for Peak detection (PK) at frequency above 1GHz.
3. The resolution bandwidth of test receiver/spectrum analyzer is 1MHz and the video bandwidth is $\geq 1/T$ (Duty cycle < 98%) or 10Hz (Duty cycle $\geq 98\%$) for Average detection (AV) at frequency above 1GHz.
4. All modes of operation were investigated and the worst-case emissions are reported.

4.1.4 Deviation from Test Standard

No deviation.

4.1.5 Test Setup

For Radiated emission below 30MHz

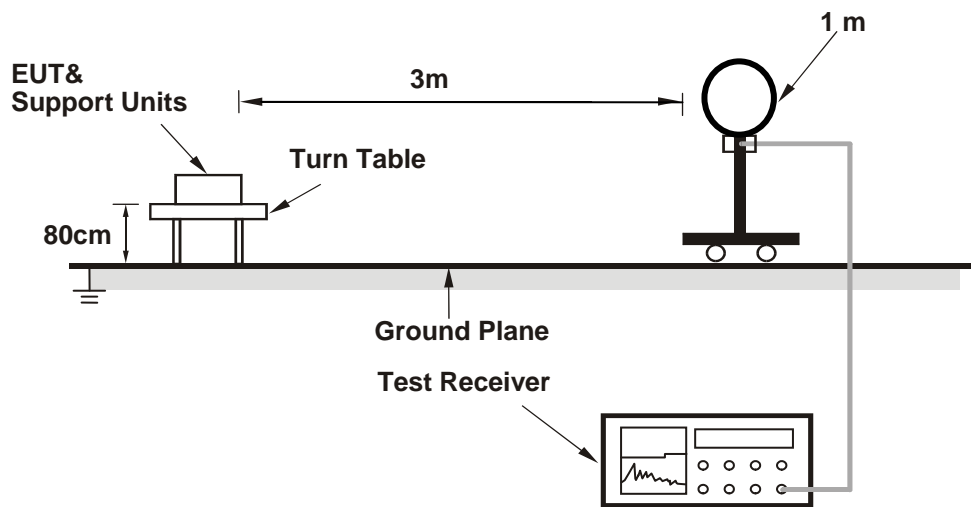

For Radiated emission 30MHz to 1GHz

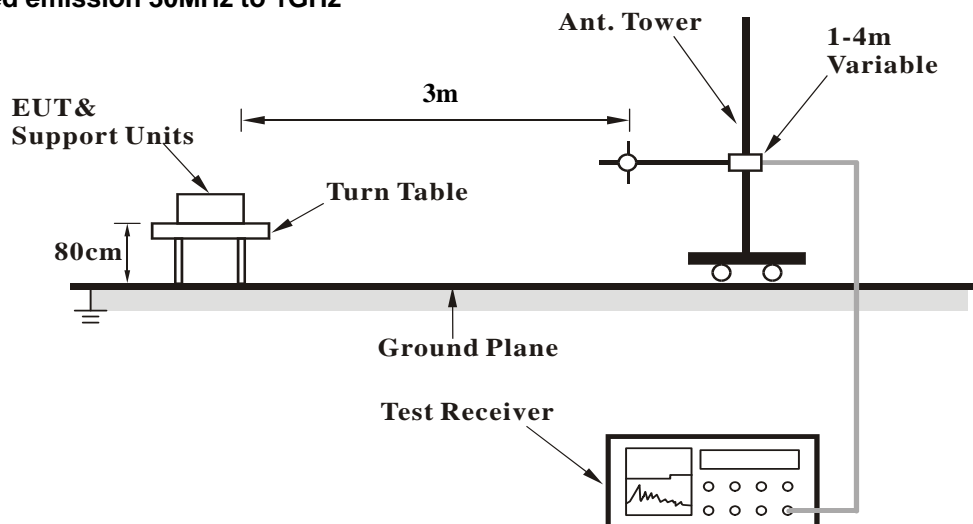

For Radiated emission above 1GHz

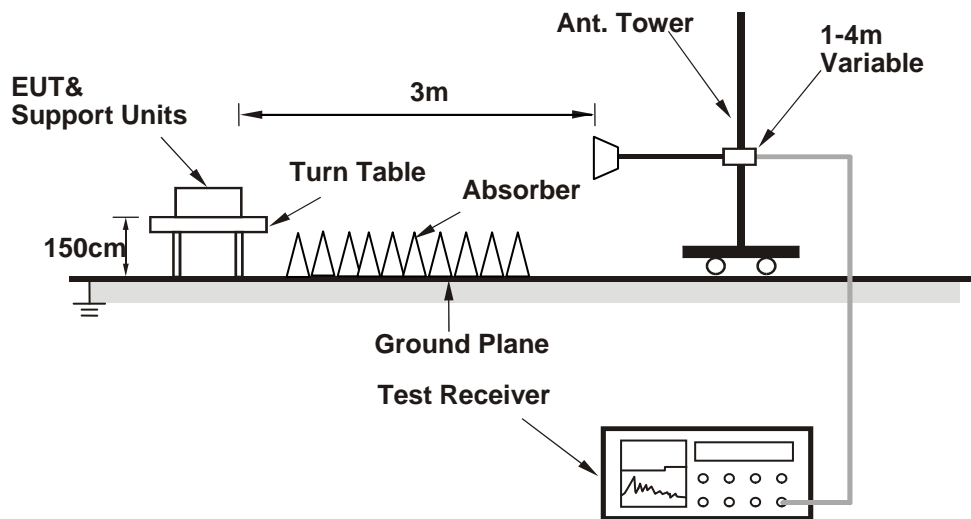

For the actual test configuration, please refer to the attached file (Test Setup Photo).

4.1.6 EUT Operating Conditions

- Placed the EUT on the testing table.
- Prepared a notebook to act as a communication partner and placed it outside of testing area.
- The communication partner connected with EUT via a RJ45 cable and ran a test program (provided by manufacturer) to enable EUT under transmission condition continuously at specific channel frequency.
- The communication partner sent data to EUT by command "PING".

4.1.7 Test Results

Above 1GHz data:

Mode A1

802.11a

| | | | |
|-----------------|---------------|----------------------|--------------|
| CHANNEL | TX Channel 52 | DETECTOR FUNCTION | Peak (PK) |
| FREQUENCY RANGE | 1GHz ~ 40GHz | | Average (AV) |

ANTENNA POLARITY & TEST DISTANCE: HORIZONTAL AT 3 M

| NO. | FREQ. (MHz) | EMISSION LEVEL (dBuV/m) | LIMIT (dBuV/m) | MARGIN (dB) | ANTENNA HEIGHT (m) | TABLE ANGLE (Degree) | RAW VALUE (dBuV) | CORRECTION FACTOR (dB/m) |
|-----|-------------|-------------------------|----------------|-------------|--------------------|----------------------|------------------|--------------------------|
| 1 | 5150.00 | 57.7 PK | 74.0 | -16.3 | 1.50 H | 352 | 54.1 | 3.6 |
| 2 | 5150.00 | 47.6 AV | 54.0 | -6.4 | 1.50 H | 352 | 44.0 | 3.6 |
| 3 | *5260.00 | 122.6 PK | | | 2.02 H | 355 | 83.0 | 39.6 |
| 4 | *5260.00 | 112.7 AV | | | 2.02 H | 355 | 73.1 | 39.6 |
| 5 | #10520.00 | 59.5 PK | 74.0 | -14.5 | 2.13 H | 19 | 42.5 | 17.0 |
| 6 | #10520.00 | 46.5 AV | 54.0 | -7.5 | 2.13 H | 19 | 29.5 | 17.0 |

ANTENNA POLARITY & TEST DISTANCE: VERTICAL AT 3 M

| NO. | FREQ. (MHz) | EMISSION LEVEL (dBuV/m) | LIMIT (dBuV/m) | MARGIN (dB) | ANTENNA HEIGHT (m) | TABLE ANGLE (Degree) | RAW VALUE (dBuV) | CORRECTION FACTOR (dB/m) |
|-----|-------------|-------------------------|----------------|-------------|--------------------|----------------------|------------------|--------------------------|
| 1 | 5150.00 | 56.4 PK | 74.0 | -17.6 | 1.66 V | 354 | 52.8 | 3.6 |
| 2 | 5150.00 | 44.9 AV | 54.0 | -9.1 | 1.66 V | 354 | 41.3 | 3.6 |
| 3 | *5260.00 | 103.4 PK | | | 1.66 V | 354 | 63.8 | 39.6 |
| 4 | *5260.00 | 92.5 AV | | | 1.66 V | 354 | 52.9 | 39.6 |
| 5 | #10520.00 | 59.1 PK | 74.0 | -14.9 | 1.62 V | 320 | 42.1 | 17.0 |
| 6 | #10520.00 | 46.3 AV | 54.0 | -7.7 | 1.62 V | 320 | 29.3 | 17.0 |

Remarks:

1. Emission Level(dBuV/m) = Raw Value(dBuV) + Correction Factor(dB/m)
2. Correction Factor(dB/m) = Antenna Factor(dB/m) + Cable Factor(dB) – Pre-Amplifier Factor(dB)
3. The other emission levels were very low against the limit.
4. Margin value = Emission Level – Limit value
5. " * ": Fundamental frequency.
6. " # ": The radiated frequency is out of the restricted band.

| | | | |
|-----------------|---------------|-------------------|--------------|
| CHANNEL | TX Channel 60 | DETECTOR FUNCTION | Peak (PK) |
| FREQUENCY RANGE | 1GHz ~ 40GHz | | Average (AV) |

ANTENNA POLARITY & TEST DISTANCE: HORIZONTAL AT 3 M

| NO. | FREQ. (MHz) | EMISSION LEVEL (dBuV/m) | LIMIT (dBuV/m) | MARGIN (dB) | ANTENNA HEIGHT (m) | TABLE ANGLE (Degree) | RAW VALUE (dBuV) | CORRECTION FACTOR (dB/m) |
|-----|-------------|-------------------------|----------------|-------------|--------------------|----------------------|------------------|--------------------------|
| 1 | *5300.00 | 123.3 PK | | | 2.01 H | 357 | 83.7 | 39.6 |
| 2 | *5300.00 | 113.2 AV | | | 2.01 H | 357 | 73.6 | 39.6 |
| 3 | 10600.00 | 59.8 PK | 74.0 | -14.2 | 2.18 H | 25 | 42.7 | 17.1 |
| 4 | 10600.00 | 46.8 AV | 54.0 | -7.2 | 2.18 H | 25 | 29.7 | 17.1 |

ANTENNA POLARITY & TEST DISTANCE: VERTICAL AT 3 M

| NO. | FREQ. (MHz) | EMISSION LEVEL (dBuV/m) | LIMIT (dBuV/m) | MARGIN (dB) | ANTENNA HEIGHT (m) | TABLE ANGLE (Degree) | RAW VALUE (dBuV) | CORRECTION FACTOR (dB/m) |
|-----|-------------|-------------------------|----------------|-------------|--------------------|----------------------|------------------|--------------------------|
| 1 | *5300.00 | 102.4 PK | | | 1.76 V | 355 | 62.8 | 39.6 |
| 2 | *5300.00 | 91.3 AV | | | 1.76 V | 355 | 51.7 | 39.6 |
| 3 | 10600.00 | 59.3 PK | 74.0 | -14.7 | 1.66 V | 300 | 42.2 | 17.1 |
| 4 | 10600.00 | 46.5 AV | 54.0 | -7.5 | 1.66 V | 300 | 29.4 | 17.1 |

Remarks:

1. Emission Level(dBuV/m) = Raw Value(dBuV) + Correction Factor(dB/m)
2. Correction Factor(dB/m) = Antenna Factor(dB/m) + Cable Factor(dB) – Pre-Amplifier Factor(dB)
3. The other emission levels were very low against the limit.
4. Margin value = Emission Level – Limit value
5. " * ": Fundamental frequency.
6. " # ": The radiated frequency is out of the restricted band.

| | | | |
|-----------------|---------------|-------------------|--------------|
| CHANNEL | TX Channel 64 | DETECTOR FUNCTION | Peak (PK) |
| FREQUENCY RANGE | 1GHz ~ 40GHz | | Average (AV) |

ANTENNA POLARITY & TEST DISTANCE: HORIZONTAL AT 3 M

| NO. | FREQ. (MHz) | EMISSION LEVEL (dBuV/m) | LIMIT (dBuV/m) | MARGIN (dB) | ANTENNA HEIGHT (m) | TABLE ANGLE (Degree) | RAW VALUE (dBuV) | CORRECTION FACTOR (dB/m) |
|-----|-------------|-------------------------|----------------|-------------|--------------------|----------------------|------------------|--------------------------|
| 1 | *5320.00 | 124.1 PK | | | 2.17 H | 356 | 84.4 | 39.7 |
| 2 | *5320.00 | 113.5 AV | | | 2.17 H | 356 | 73.8 | 39.7 |
| 3 | 5350.00 | 64.1 PK | 74.0 | -9.9 | 1.40 H | 355 | 60.2 | 3.9 |
| 4 | 5350.00 | 51.9 AV | 54.0 | -2.1 | 1.40 H | 355 | 48.0 | 3.9 |
| 5 | 10640.00 | 60.0 PK | 74.0 | -14.0 | 2.26 H | 21 | 42.7 | 17.3 |
| 6 | 10640.00 | 46.9 AV | 54.0 | -7.1 | 2.26 H | 21 | 29.6 | 17.3 |

ANTENNA POLARITY & TEST DISTANCE: VERTICAL AT 3 M

| NO. | FREQ. (MHz) | EMISSION LEVEL (dBuV/m) | LIMIT (dBuV/m) | MARGIN (dB) | ANTENNA HEIGHT (m) | TABLE ANGLE (Degree) | RAW VALUE (dBuV) | CORRECTION FACTOR (dB/m) |
|-----|-------------|-------------------------|----------------|-------------|--------------------|----------------------|------------------|--------------------------|
| 1 | *5320.00 | 100.6 PK | | | 1.76 V | 355 | 60.9 | 39.7 |
| 2 | *5320.00 | 90.1 AV | | | 1.76 V | 355 | 50.4 | 39.7 |
| 3 | 5350.00 | 59.5 PK | 74.0 | -14.5 | 1.73 V | 356 | 55.6 | 3.9 |
| 4 | 5350.00 | 48.8 AV | 54.0 | -5.2 | 1.73 V | 356 | 44.9 | 3.9 |
| 5 | 10640.00 | 59.3 PK | 74.0 | -14.7 | 1.69 V | 321 | 42.0 | 17.3 |
| 6 | 10640.00 | 46.6 AV | 54.0 | -7.4 | 1.69 V | 321 | 29.3 | 17.3 |

Remarks:

1. Emission Level(dBuV/m) = Raw Value(dBuV) + Correction Factor(dB/m)
2. Correction Factor(dB/m) = Antenna Factor(dB/m) + Cable Factor(dB) – Pre-Amplifier Factor(dB)
3. The other emission levels were very low against the limit.
4. Margin value = Emission Level – Limit value
5. " * ": Fundamental frequency.
6. " # ": The radiated frequency is out of the restricted band.

| | | | |
|-----------------|----------------|----------------------|--------------|
| CHANNEL | TX Channel 100 | DETECTOR FUNCTION | Peak (PK) |
| FREQUENCY RANGE | 1GHz ~ 40GHz | | Average (AV) |

| ANTENNA POLARITY & TEST DISTANCE: HORIZONTAL AT 3 M | | | | | | | | |
|---|-------------|-------------------------|----------------|-------------|--------------------|----------------------|------------------|--------------------------|
| NO. | FREQ. (MHz) | EMISSION LEVEL (dBuV/m) | LIMIT (dBuV/m) | MARGIN (dB) | ANTENNA HEIGHT (m) | TABLE ANGLE (Degree) | RAW VALUE (dBuV) | CORRECTION FACTOR (dB/m) |
| 1 | 5460.00 | 59.9 PK | 74.0 | -14.1 | 2.00 H | 344 | 55.9 | 4.0 |
| 2 | 5460.00 | 48.0 AV | 54.0 | -6.0 | 2.00 H | 344 | 44.0 | 4.0 |
| 3 | #5470.00 | 65.9 PK | 74.0 | -8.1 | 2.24 H | 355 | 61.9 | 4.0 |
| 4 | #5470.00 | 52.3 AV | 54.0 | -1.7 | 2.24 H | 355 | 48.3 | 4.0 |
| 5 | *5500.00 | 124.0 PK | | | 2.16 H | 355 | 84.0 | 40.0 |
| 6 | *5500.00 | 113.3 AV | | | 2.16 H | 355 | 73.3 | 40.0 |
| 7 | 11000.00 | 63.0 PK | 74.0 | -11.0 | 1.93 H | 299 | 44.0 | 19.0 |
| 8 | 11000.00 | 49.5 AV | 54.0 | -4.5 | 1.93 H | 299 | 30.5 | 19.0 |

| ANTENNA POLARITY & TEST DISTANCE: VERTICAL AT 3 M | | | | | | | | |
|---|-------------|-------------------------|----------------|-------------|--------------------|----------------------|------------------|--------------------------|
| NO. | FREQ. (MHz) | EMISSION LEVEL (dBuV/m) | LIMIT (dBuV/m) | MARGIN (dB) | ANTENNA HEIGHT (m) | TABLE ANGLE (Degree) | RAW VALUE (dBuV) | CORRECTION FACTOR (dB/m) |
| 1 | 5460.00 | 55.5 PK | 74.0 | -18.5 | 1.70 V | 166 | 51.5 | 4.0 |
| 2 | 5460.00 | 44.5 AV | 54.0 | -9.5 | 1.70 V | 166 | 40.5 | 4.0 |
| 3 | #5470.00 | 58.3 PK | 74.0 | -15.7 | 1.77 V | 163 | 54.3 | 4.0 |
| 4 | #5470.00 | 44.4 AV | 54.0 | -9.6 | 1.77 V | 163 | 40.4 | 4.0 |
| 5 | *5500.00 | 103.2 PK | | | 1.81 V | 153 | 63.2 | 40.0 |
| 6 | *5500.00 | 93.1 AV | | | 1.81 V | 153 | 53.1 | 40.0 |
| 7 | 11000.00 | 62.0 PK | 74.0 | -12.0 | 1.99 V | 203 | 43.0 | 19.0 |
| 8 | 11000.00 | 48.3 AV | 54.0 | -5.7 | 1.99 V | 203 | 29.3 | 19.0 |

Remarks:

1. Emission Level(dBuV/m) = Raw Value(dBuV) + Correction Factor(dB/m)
2. Correction Factor(dB/m) = Antenna Factor(dB/m) + Cable Factor(dB) – Pre-Amplifier Factor(dB)
3. The other emission levels were very low against the limit.
4. Margin value = Emission Level – Limit value
5. " * ": Fundamental frequency.
6. " # ": The radiated frequency is out of the restricted band.

| | | | |
|-----------------|----------------|----------|--------------|
| CHANNEL | TX Channel 116 | DETECTOR | Peak (PK) |
| FREQUENCY RANGE | 1GHz ~ 40GHz | FUNCTION | Average (AV) |

ANTENNA POLARITY & TEST DISTANCE: HORIZONTAL AT 3 M

| NO. | FREQ. (MHz) | EMISSION LEVEL (dBuV/m) | LIMIT (dBuV/m) | MARGIN (dB) | ANTENNA HEIGHT (m) | TABLE ANGLE (Degree) | RAW VALUE (dBuV) | CORRECTION FACTOR (dB/m) |
|-----|-------------|-------------------------|----------------|-------------|--------------------|----------------------|------------------|--------------------------|
| 1 | *5580.00 | 126.3 PK | | | 1.64 H | 354 | 86.2 | 40.1 |
| 2 | *5580.00 | 115.4 AV | | | 1.64 H | 354 | 75.3 | 40.1 |
| 3 | 11160.00 | 62.2 PK | 74.0 | -11.8 | 1.99 H | 287 | 43.5 | 18.7 |
| 4 | 11160.00 | 49.0 AV | 54.0 | -5.0 | 1.99 H | 287 | 30.3 | 18.7 |

ANTENNA POLARITY & TEST DISTANCE: VERTICAL AT 3 M

| NO. | FREQ. (MHz) | EMISSION LEVEL (dBuV/m) | LIMIT (dBuV/m) | MARGIN (dB) | ANTENNA HEIGHT (m) | TABLE ANGLE (Degree) | RAW VALUE (dBuV) | CORRECTION FACTOR (dB/m) |
|-----|-------------|-------------------------|----------------|-------------|--------------------|----------------------|------------------|--------------------------|
| 1 | *5580.00 | 105.2 PK | | | 1.83 V | 177 | 65.1 | 40.1 |
| 2 | *5580.00 | 95.1 AV | | | 1.83 V | 177 | 55.0 | 40.1 |
| 3 | 11160.00 | 60.8 PK | 74.0 | -13.2 | 1.99 V | 282 | 42.1 | 18.7 |
| 4 | 11160.00 | 47.8 AV | 54.0 | -6.2 | 1.99 V | 282 | 29.1 | 18.7 |

Remarks:

1. Emission Level(dBuV/m) = Raw Value(dBuV) + Correction Factor(dB/m)
2. Correction Factor(dB/m) = Antenna Factor(dB/m) + Cable Factor(dB) – Pre-Amplifier Factor(dB)
3. The other emission levels were very low against the limit.
4. Margin value = Emission Level – Limit value
5. " * ": Fundamental frequency.
6. " # ": The radiated frequency is out of the restricted band.

| | | | |
|-----------------|----------------|-------------------|--------------|
| CHANNEL | TX Channel 140 | DETECTOR FUNCTION | Peak (PK) |
| FREQUENCY RANGE | 1GHz ~ 40GHz | | Average (AV) |

| ANTENNA POLARITY & TEST DISTANCE: HORIZONTAL AT 3 M | | | | | | | | |
|---|-------------|-------------------------|----------------|-------------|--------------------|----------------------|------------------|--------------------------|
| NO. | FREQ. (MHz) | EMISSION LEVEL (dBuV/m) | LIMIT (dBuV/m) | MARGIN (dB) | ANTENNA HEIGHT (m) | TABLE ANGLE (Degree) | RAW VALUE (dBuV) | CORRECTION FACTOR (dB/m) |
| 1 | *5700.00 | 124.2 PK | | | 1.65 H | 353 | 83.9 | 40.3 |
| 2 | *5700.00 | 113.7 AV | | | 1.65 H | 353 | 73.4 | 40.3 |
| 3 | #5725.00 | 66.5 PK | 74.0 | -7.5 | 1.50 H | 351 | 62.0 | 4.5 |
| 4 | #5725.00 | 52.3 AV | 54.0 | -1.7 | 1.50 H | 351 | 47.8 | 4.5 |
| 5 | 11140.00 | 62.0 PK | 74.0 | -12.0 | 1.88 H | 258 | 43.4 | 18.6 |
| 6 | 11140.00 | 48.3 AV | 54.0 | -5.7 | 1.88 H | 258 | 29.7 | 18.6 |
| ANTENNA POLARITY & TEST DISTANCE: VERTICAL AT 3 M | | | | | | | | |
| NO. | FREQ. (MHz) | EMISSION LEVEL (dBuV/m) | LIMIT (dBuV/m) | MARGIN (dB) | ANTENNA HEIGHT (m) | TABLE ANGLE (Degree) | RAW VALUE (dBuV) | CORRECTION FACTOR (dB/m) |
| 1 | *5700.00 | 105.1 PK | | | 1.50 V | 169 | 64.8 | 40.3 |
| 2 | *5700.00 | 94.3 AV | | | 1.50 V | 169 | 54.0 | 40.3 |
| 3 | #5725.00 | 58.4 PK | 74.0 | -15.6 | 1.66 V | 181 | 53.9 | 4.5 |
| 4 | #5725.00 | 44.9 AV | 54.0 | -9.1 | 1.66 V | 181 | 40.4 | 4.5 |
| 5 | 11140.00 | 62.5 PK | 74.0 | -11.5 | 1.88 V | 203 | 44.3 | 18.2 |
| 6 | 11140.00 | 48.6 AV | 54.0 | -5.4 | 1.88 V | 203 | 30.4 | 18.2 |

Remarks:

1. Emission Level(dBuV/m) = Raw Value(dBuV) + Correction Factor(dB/m)
2. Correction Factor(dB/m) = Antenna Factor(dB/m) + Cable Factor(dB) – Pre-Amplifier Factor(dB)
3. The other emission levels were very low against the limit.
4. Margin value = Emission Level – Limit value
5. " * ": Fundamental frequency.
6. " # ": The radiated frequency is out of the restricted band.

| | | | |
|-----------------|----------------|----------------------|--------------|
| CHANNEL | TX Channel 144 | DETECTOR FUNCTION | Peak (PK) |
| FREQUENCY RANGE | 1GHz ~ 40GHz | | Average (AV) |

| ANTENNA POLARITY & TEST DISTANCE: HORIZONTAL AT 3 M | | | | | | | | |
|---|-------------|-------------------------|----------------|-------------|--------------------|----------------------|------------------|--------------------------|
| NO. | FREQ. (MHz) | EMISSION LEVEL (dBuV/m) | LIMIT (dBuV/m) | MARGIN (dB) | ANTENNA HEIGHT (m) | TABLE ANGLE (Degree) | RAW VALUE (dBuV) | CORRECTION FACTOR (dB/m) |
| 1 | #5470.00 | 56.7 PK | 74.0 | -17.3 | 1.81 H | 182 | 52.7 | 4.0 |
| 2 | #5470.00 | 43.5 AV | 54.0 | -10.5 | 1.81 H | 182 | 39.5 | 4.0 |
| 3 | *5720.00 | 125.4 PK | | | 1.72 H | 164 | 85.0 | 40.4 |
| 4 | *5720.00 | 114.7 AV | | | 1.72 H | 164 | 74.3 | 40.4 |
| 5 | #5825.00 | 57.2 PK | 74.0 | -16.8 | 1.79 H | 173 | 52.5 | 4.7 |
| 6 | #5825.00 | 44.5 AV | 54.0 | -9.5 | 1.79 H | 173 | 39.8 | 4.7 |
| 7 | 11440.00 | 60.8 PK | 74.0 | -13.2 | 1.89 H | 213 | 42.5 | 18.3 |
| 8 | 11440.00 | 47.7 AV | 54.0 | -6.3 | 1.89 H | 213 | 29.4 | 18.3 |

| ANTENNA POLARITY & TEST DISTANCE: VERTICAL AT 3 M | | | | | | | | |
|---|-------------|-------------------------|----------------|-------------|--------------------|----------------------|------------------|--------------------------|
| NO. | FREQ. (MHz) | EMISSION LEVEL (dBuV/m) | LIMIT (dBuV/m) | MARGIN (dB) | ANTENNA HEIGHT (m) | TABLE ANGLE (Degree) | RAW VALUE (dBuV) | CORRECTION FACTOR (dB/m) |
| 1 | #5470.00 | 55.4 PK | 74.0 | -18.6 | 2.11 V | 111 | 51.4 | 4.0 |
| 2 | #5470.00 | 42.4 AV | 54.0 | -11.6 | 2.11 V | 111 | 38.4 | 4.0 |
| 3 | *5720.00 | 106.4 PK | | | 2.65 V | 84 | 66.0 | 40.4 |
| 4 | *5720.00 | 96.0 AV | | | 2.65 V | 84 | 55.6 | 40.4 |
| 5 | #5825.00 | 56.1 PK | 74.0 | -17.9 | 2.22 V | 123 | 51.4 | 4.7 |
| 6 | #5825.00 | 42.9 AV | 54.0 | -11.1 | 2.22 V | 123 | 38.2 | 4.7 |
| 7 | 11440.00 | 60.7 PK | 74.0 | -13.3 | 1.98 V | 302 | 42.4 | 18.3 |
| 8 | 11440.00 | 47.3 AV | 54.0 | -6.7 | 1.98 V | 302 | 29.0 | 18.3 |

Remarks:

1. Emission Level(dBuV/m) = Raw Value(dBuV) + Correction Factor(dB/m)
2. Correction Factor(dB/m) = Antenna Factor(dB/m) + Cable Factor(dB) – Pre-Amplifier Factor(dB)
3. The other emission levels were very low against the limit.
4. Margin value = Emission Level – Limit value
5. " * ": Fundamental frequency.
6. " # ": The radiated frequency is out of the restricted band.

802.11n (HT20)

| | | | |
|-----------------|---------------|----------------------|--------------|
| CHANNEL | TX Channel 52 | DETECTOR FUNCTION | Peak (PK) |
| FREQUENCY RANGE | 1GHz ~ 40GHz | | Average (AV) |

| ANTENNA POLARITY & TEST DISTANCE: HORIZONTAL AT 3 M | | | | | | | | |
|---|-------------|-------------------------|----------------|-------------|--------------------|----------------------|------------------|--------------------------|
| NO. | FREQ. (MHz) | EMISSION LEVEL (dBuV/m) | LIMIT (dBuV/m) | MARGIN (dB) | ANTENNA HEIGHT (m) | TABLE ANGLE (Degree) | RAW VALUE (dBuV) | CORRECTION FACTOR (dB/m) |
| 1 | 5150.00 | 58.6 PK | 74.0 | -15.4 | 2.03 H | 357 | 55.0 | 3.6 |
| 2 | 5150.00 | 48.2 AV | 54.0 | -5.8 | 2.03 H | 357 | 44.6 | 3.6 |
| 3 | *5260.00 | 123.2 PK | | | 2.02 H | 355 | 83.6 | 39.6 |
| 4 | *5260.00 | 112.7 AV | | | 2.02 H | 355 | 73.1 | 39.6 |
| 5 | #10520.00 | 59.9 PK | 74.0 | -14.1 | 2.18 H | 26 | 42.9 | 17.0 |
| 6 | #10520.00 | 47.0 AV | 54.0 | -7.0 | 2.18 H | 26 | 30.0 | 17.0 |
| ANTENNA POLARITY & TEST DISTANCE: VERTICAL AT 3 M | | | | | | | | |
| NO. | FREQ. (MHz) | EMISSION LEVEL (dBuV/m) | LIMIT (dBuV/m) | MARGIN (dB) | ANTENNA HEIGHT (m) | TABLE ANGLE (Degree) | RAW VALUE (dBuV) | CORRECTION FACTOR (dB/m) |
| 1 | 5150.00 | 57.8 PK | 74.0 | -16.2 | 1.70 V | 347 | 54.2 | 3.6 |
| 2 | 5150.00 | 46.7 AV | 54.0 | -7.3 | 1.70 V | 347 | 43.1 | 3.6 |
| 3 | *5260.00 | 104.7 PK | | | 1.72 V | 349 | 65.1 | 39.6 |
| 4 | *5260.00 | 93.5 AV | | | 1.72 V | 349 | 53.9 | 39.6 |
| 5 | #10520.00 | 59.5 PK | 74.0 | -14.5 | 1.88 V | 323 | 42.5 | 17.0 |
| 6 | #10520.00 | 46.5 AV | 54.0 | -7.5 | 1.88 V | 323 | 29.5 | 17.0 |

Remarks:

1. Emission Level(dBuV/m) = Raw Value(dBuV) + Correction Factor(dB/m)
2. Correction Factor(dB/m) = Antenna Factor(dB/m) + Cable Factor(dB) – Pre-Amplifier Factor(dB)
3. The other emission levels were very low against the limit.
4. Margin value = Emission Level – Limit value
5. " * ": Fundamental frequency.
6. " # ": The radiated frequency is out of the restricted band.

| | | | |
|-----------------|---------------|-------------------|--------------|
| CHANNEL | TX Channel 60 | DETECTOR FUNCTION | Peak (PK) |
| FREQUENCY RANGE | 1GHz ~ 40GHz | | Average (AV) |

ANTENNA POLARITY & TEST DISTANCE: HORIZONTAL AT 3 M

| NO. | FREQ. (MHz) | EMISSION LEVEL (dBuV/m) | LIMIT (dBuV/m) | MARGIN (dB) | ANTENNA HEIGHT (m) | TABLE ANGLE (Degree) | RAW VALUE (dBuV) | CORRECTION FACTOR (dB/m) |
|-----|-------------|-------------------------|----------------|-------------|--------------------|----------------------|------------------|--------------------------|
| 1 | *5300.00 | 123.8 PK | | | 2.11 H | 355 | 84.2 | 39.6 |
| 2 | *5300.00 | 112.8 AV | | | 2.11 H | 355 | 73.2 | 39.6 |
| 3 | 10600.00 | 60.6 PK | 74.0 | -13.4 | 2.29 H | 27 | 43.5 | 17.1 |
| 4 | 10600.00 | 47.3 AV | 54.0 | -6.7 | 2.29 H | 27 | 30.2 | 17.1 |

ANTENNA POLARITY & TEST DISTANCE: VERTICAL AT 3 M

| NO. | FREQ. (MHz) | EMISSION LEVEL (dBuV/m) | LIMIT (dBuV/m) | MARGIN (dB) | ANTENNA HEIGHT (m) | TABLE ANGLE (Degree) | RAW VALUE (dBuV) | CORRECTION FACTOR (dB/m) |
|-----|-------------|-------------------------|----------------|-------------|--------------------|----------------------|------------------|--------------------------|
| 1 | *5300.00 | 103.1 PK | | | 1.67 V | 346 | 63.5 | 39.6 |
| 2 | *5300.00 | 91.9 AV | | | 1.67 V | 346 | 52.3 | 39.6 |
| 3 | 10600.00 | 59.7 PK | 74.0 | -14.3 | 1.92 V | 329 | 42.6 | 17.1 |
| 4 | 10600.00 | 46.5 AV | 54.0 | -7.5 | 1.92 V | 329 | 29.4 | 17.1 |

Remarks:

1. Emission Level(dBuV/m) = Raw Value(dBuV) + Correction Factor(dB/m)
2. Correction Factor(dB/m) = Antenna Factor(dB/m) + Cable Factor(dB) – Pre-Amplifier Factor(dB)
3. The other emission levels were very low against the limit.
4. Margin value = Emission Level – Limit value
5. " * ": Fundamental frequency.
6. " # ": The radiated frequency is out of the restricted band.

| | | | |
|-----------------|---------------|-------------------|--------------|
| CHANNEL | TX Channel 64 | DETECTOR FUNCTION | Peak (PK) |
| FREQUENCY RANGE | 1GHz ~ 40GHz | | Average (AV) |

| ANTENNA POLARITY & TEST DISTANCE: HORIZONTAL AT 3 M | | | | | | | | |
|---|-------------|-------------------------|----------------|-------------|--------------------|----------------------|------------------|--------------------------|
| NO. | FREQ. (MHz) | EMISSION LEVEL (dBuV/m) | LIMIT (dBuV/m) | MARGIN (dB) | ANTENNA HEIGHT (m) | TABLE ANGLE (Degree) | RAW VALUE (dBuV) | CORRECTION FACTOR (dB/m) |
| 1 | *5320.00 | 123.9 PK | | | 2.11 H | 355 | 84.2 | 39.7 |
| 2 | *5320.00 | 113.0 AV | | | 2.11 H | 355 | 73.3 | 39.7 |
| 3 | 5350.00 | 65.2 PK | 74.0 | -8.8 | 1.35 H | 35 | 61.3 | 3.9 |
| 4 | 5350.00 | 51.6 AV | 54.0 | -2.4 | 1.35 H | 35 | 47.7 | 3.9 |
| 5 | 10600.00 | 60.6 PK | 74.0 | -13.4 | 2.29 H | 27 | 43.5 | 17.1 |
| 6 | 10600.00 | 47.3 AV | 54.0 | -6.7 | 2.29 H | 27 | 30.2 | 17.1 |
| ANTENNA POLARITY & TEST DISTANCE: VERTICAL AT 3 M | | | | | | | | |
| NO. | FREQ. (MHz) | EMISSION LEVEL (dBuV/m) | LIMIT (dBuV/m) | MARGIN (dB) | ANTENNA HEIGHT (m) | TABLE ANGLE (Degree) | RAW VALUE (dBuV) | CORRECTION FACTOR (dB/m) |
| 1 | *5320.00 | 103.0 PK | | | 1.67 V | 348 | 63.3 | 39.7 |
| 2 | *5320.00 | 92.0 AV | | | 1.67 V | 348 | 52.3 | 39.7 |
| 3 | 5350.00 | 60.3 PK | 74.0 | -13.7 | 1.67 V | 349 | 56.4 | 3.9 |
| 4 | 5350.00 | 48.3 AV | 54.0 | -5.7 | 1.67 V | 349 | 44.4 | 3.9 |
| 5 | 10640.00 | 59.7 PK | 74.0 | -14.3 | 1.76 V | 312 | 42.4 | 17.3 |
| 6 | 10640.00 | 46.7 AV | 54.0 | -7.3 | 1.76 V | 312 | 29.4 | 17.3 |

Remarks:

1. Emission Level(dBuV/m) = Raw Value(dBuV) + Correction Factor(dB/m)
2. Correction Factor(dB/m) = Antenna Factor(dB/m) + Cable Factor(dB) – Pre-Amplifier Factor(dB)
3. The other emission levels were very low against the limit.
4. Margin value = Emission Level – Limit value
5. " * ": Fundamental frequency.
6. " # ": The radiated frequency is out of the restricted band.

| | | | |
|-----------------|----------------|-------------------|--------------|
| CHANNEL | TX Channel 100 | DETECTOR FUNCTION | Peak (PK) |
| FREQUENCY RANGE | 1GHz ~ 40GHz | | Average (AV) |

| ANTENNA POLARITY & TEST DISTANCE: HORIZONTAL AT 3 M | | | | | | | | |
|---|-------------|-------------------------|----------------|-------------|--------------------|----------------------|------------------|--------------------------|
| NO. | FREQ. (MHz) | EMISSION LEVEL (dBuV/m) | LIMIT (dBuV/m) | MARGIN (dB) | ANTENNA HEIGHT (m) | TABLE ANGLE (Degree) | RAW VALUE (dBuV) | CORRECTION FACTOR (dB/m) |
| 1 | 5460.00 | 61.5 PK | 74.0 | -12.5 | 1.70 H | 351 | 57.5 | 4.0 |
| 2 | 5460.00 | 50.3 AV | 54.0 | -3.7 | 1.70 H | 351 | 46.3 | 4.0 |
| 3 | #5470.00 | 64.3 PK | 74.0 | -9.7 | 1.60 H | 351 | 60.3 | 4.0 |
| 4 | #5470.00 | 52.8 AV | 54.0 | -1.2 | 1.60 H | 351 | 48.8 | 4.0 |
| 5 | *5500.00 | 124.3 PK | | | 1.96 H | 352 | 84.3 | 40.0 |
| 6 | *5500.00 | 113.5 AV | | | 1.96 H | 352 | 73.5 | 40.0 |
| 7 | 11000.00 | 62.8 PK | 74.0 | -11.2 | 2.10 H | 352 | 43.8 | 19.0 |
| 8 | 11000.00 | 49.8 AV | 54.0 | -4.2 | 2.10 H | 352 | 30.8 | 19.0 |

| ANTENNA POLARITY & TEST DISTANCE: VERTICAL AT 3 M | | | | | | | | |
|---|-------------|-------------------------|----------------|-------------|--------------------|----------------------|------------------|--------------------------|
| NO. | FREQ. (MHz) | EMISSION LEVEL (dBuV/m) | LIMIT (dBuV/m) | MARGIN (dB) | ANTENNA HEIGHT (m) | TABLE ANGLE (Degree) | RAW VALUE (dBuV) | CORRECTION FACTOR (dB/m) |
| 1 | 5460.00 | 57.6 PK | 74.0 | -16.4 | 1.67 V | 0 | 53.6 | 4.0 |
| 2 | 5460.00 | 46.5 AV | 54.0 | -7.5 | 1.67 V | 0 | 42.5 | 4.0 |
| 3 | #5470.00 | 58.5 PK | 74.0 | -15.5 | 1.65 V | 359 | 54.5 | 4.0 |
| 4 | #5470.00 | 47.6 AV | 54.0 | -6.4 | 1.65 V | 359 | 43.6 | 4.0 |
| 5 | *5500.00 | 107.3 PK | | | 1.80 V | 354 | 67.3 | 40.0 |
| 6 | *5500.00 | 96.5 AV | | | 1.80 V | 354 | 56.5 | 40.0 |
| 7 | 11000.00 | 61.6 PK | 74.0 | -12.4 | 1.57 V | 252 | 42.6 | 19.0 |
| 8 | 11000.00 | 48.7 AV | 54.0 | -5.3 | 1.57 V | 252 | 29.7 | 19.0 |

Remarks:

1. Emission Level(dBuV/m) = Raw Value(dBuV) + Correction Factor(dB/m)
2. Correction Factor(dB/m) = Antenna Factor(dB/m) + Cable Factor(dB) – Pre-Amplifier Factor(dB)
3. The other emission levels were very low against the limit.
4. Margin value = Emission Level – Limit value
5. " * ": Fundamental frequency.
6. " # ": The radiated frequency is out of the restricted band.

| | | | |
|-----------------|----------------|----------|--------------|
| CHANNEL | TX Channel 116 | DETECTOR | Peak (PK) |
| FREQUENCY RANGE | 1GHz ~ 40GHz | FUNCTION | Average (AV) |

ANTENNA POLARITY & TEST DISTANCE: HORIZONTAL AT 3 M

| NO. | FREQ. (MHz) | EMISSION LEVEL (dBuV/m) | LIMIT (dBuV/m) | MARGIN (dB) | ANTENNA HEIGHT (m) | TABLE ANGLE (Degree) | RAW VALUE (dBuV) | CORRECTION FACTOR (dB/m) |
|-----|-------------|-------------------------|----------------|-------------|--------------------|----------------------|------------------|--------------------------|
| 1 | *5580.00 | 126.0 PK | | | 1.71 H | 355 | 85.9 | 40.1 |
| 2 | *5580.00 | 115.2 AV | | | 1.71 H | 355 | 75.1 | 40.1 |
| 3 | 11160.00 | 62.7 PK | 74.0 | -11.3 | 2.09 H | 355 | 44.0 | 18.7 |
| 4 | 11160.00 | 49.6 AV | 54.0 | -4.4 | 2.09 H | 355 | 30.9 | 18.7 |

ANTENNA POLARITY & TEST DISTANCE: VERTICAL AT 3 M

| NO. | FREQ. (MHz) | EMISSION LEVEL (dBuV/m) | LIMIT (dBuV/m) | MARGIN (dB) | ANTENNA HEIGHT (m) | TABLE ANGLE (Degree) | RAW VALUE (dBuV) | CORRECTION FACTOR (dB/m) |
|-----|-------------|-------------------------|----------------|-------------|--------------------|----------------------|------------------|--------------------------|
| 1 | *5580.00 | 109.0 PK | | | 1.79 V | 353 | 68.9 | 40.1 |
| 2 | *5580.00 | 98.4 AV | | | 1.79 V | 353 | 58.3 | 40.1 |
| 3 | 11160.00 | 62.6 PK | 74.0 | -11.4 | 1.61 V | 259 | 43.9 | 18.7 |
| 4 | 11160.00 | 48.6 AV | 54.0 | -5.4 | 1.61 V | 259 | 29.9 | 18.7 |

Remarks:

1. Emission Level(dBuV/m) = Raw Value(dBuV) + Correction Factor(dB/m)
2. Correction Factor(dB/m) = Antenna Factor(dB/m) + Cable Factor(dB) – Pre-Amplifier Factor(dB)
3. The other emission levels were very low against the limit.
4. Margin value = Emission Level – Limit value
5. " * ": Fundamental frequency.
6. " # ": The radiated frequency is out of the restricted band.

| | | | |
|-----------------|----------------|----------------------|--------------|
| CHANNEL | TX Channel 140 | DETECTOR FUNCTION | Peak (PK) |
| FREQUENCY RANGE | 1GHz ~ 40GHz | | Average (AV) |

ANTENNA POLARITY & TEST DISTANCE: HORIZONTAL AT 3 M

| NO. | FREQ. (MHz) | EMISSION LEVEL (dBuV/m) | LIMIT (dBuV/m) | MARGIN (dB) | ANTENNA HEIGHT (m) | TABLE ANGLE (Degree) | RAW VALUE (dBuV) | CORRECTION FACTOR (dB/m) |
|----------|-----------------|-------------------------------|-------------------|----------------|--------------------------|----------------------------|------------------------|--------------------------------|
| 1 | *5700.00 | 121.2 PK | | | 1.61 H | 351 | 80.9 | 40.3 |
| 2 | *5700.00 | 110.7 AV | | | 1.61 H | 351 | 70.4 | 40.3 |
| 3 | #5725.00 | 68.1 PK | 74.0 | -5.9 | 1.33 H | 351 | 63.6 | 4.5 |
| 4 | #5725.00 | 53.0 AV | 54.0 | -1.0 | 1.33 H | 351 | 48.5 | 4.5 |
| 5 | 11400.00 | 60.3 PK | 74.0 | -13.7 | 2.15 H | 16 | 42.1 | 18.2 |
| 6 | 11400.00 | 47.5 AV | 54.0 | -6.5 | 2.15 H | 16 | 29.3 | 18.2 |

ANTENNA POLARITY & TEST DISTANCE: VERTICAL AT 3 M

| NO. | FREQ. (MHz) | EMISSION LEVEL (dBuV/m) | LIMIT (dBuV/m) | MARGIN (dB) | ANTENNA HEIGHT (m) | TABLE ANGLE (Degree) | RAW VALUE (dBuV) | CORRECTION FACTOR (dB/m) |
|-----|-------------|-------------------------------|-------------------|----------------|--------------------------|----------------------------|------------------------|--------------------------------|
| 1 | *5700.00 | 106.4 PK | | | 1.72 V | 353 | 66.1 | 40.3 |
| 2 | *5700.00 | 95.4 AV | | | 1.72 V | 353 | 55.1 | 40.3 |
| 3 | #5725.00 | 55.1 PK | 74.0 | -18.9 | 1.66 V | 348 | 50.6 | 4.5 |
| 4 | #5725.00 | 45.3 AV | 54.0 | -8.7 | 1.66 V | 348 | 40.8 | 4.5 |
| 5 | 11400.00 | 60.0 PK | 74.0 | -14.0 | 1.52 V | 248 | 41.8 | 18.2 |
| 6 | 11400.00 | 47.2 AV | 54.0 | -6.8 | 1.52 V | 248 | 29.0 | 18.2 |

Remarks:

1. Emission Level(dBuV/m) = Raw Value(dBuV) + Correction Factor(dB/m)
2. Correction Factor(dB/m) = Antenna Factor(dB/m) + Cable Factor(dB) – Pre-Amplifier Factor(dB)
3. The other emission levels were very low against the limit.
4. Margin value = Emission Level – Limit value
5. " * ": Fundamental frequency.
6. " # ": The radiated frequency is out of the restricted band.

| | | | |
|-----------------|----------------|----------------------|--------------|
| CHANNEL | TX Channel 144 | DETECTOR FUNCTION | Peak (PK) |
| FREQUENCY RANGE | 1GHz ~ 40GHz | | Average (AV) |

| ANTENNA POLARITY & TEST DISTANCE: HORIZONTAL AT 3 M | | | | | | | | |
|---|-------------|-------------------------|----------------|-------------|--------------------|----------------------|------------------|--------------------------|
| NO. | FREQ. (MHz) | EMISSION LEVEL (dBuV/m) | LIMIT (dBuV/m) | MARGIN (dB) | ANTENNA HEIGHT (m) | TABLE ANGLE (Degree) | RAW VALUE (dBuV) | CORRECTION FACTOR (dB/m) |
| 1 | #5470.00 | 57.2 PK | 74.0 | -16.8 | 1.83 H | 177 | 53.2 | 4.0 |
| 2 | #5470.00 | 43.2 AV | 54.0 | -10.8 | 1.83 H | 177 | 39.2 | 4.0 |
| 3 | *5720.00 | 124.5 PK | | | 1.79 H | 168 | 84.1 | 40.4 |
| 4 | *5720.00 | 113.7 AV | | | 1.79 H | 168 | 73.3 | 40.4 |
| 5 | #5825.00 | 57.2 PK | 74.0 | -16.8 | 1.69 H | 159 | 52.5 | 4.7 |
| 6 | #5825.00 | 44.3 AV | 54.0 | -9.7 | 1.69 H | 159 | 39.6 | 4.7 |
| 7 | 11440.00 | 61.1 PK | 74.0 | -12.9 | 1.81 H | 216 | 42.8 | 18.3 |
| 8 | 11440.00 | 47.9 AV | 54.0 | -6.1 | 1.81 H | 216 | 29.6 | 18.3 |

| ANTENNA POLARITY & TEST DISTANCE: VERTICAL AT 3 M | | | | | | | | |
|---|-------------|-------------------------|----------------|-------------|--------------------|----------------------|------------------|--------------------------|
| NO. | FREQ. (MHz) | EMISSION LEVEL (dBuV/m) | LIMIT (dBuV/m) | MARGIN (dB) | ANTENNA HEIGHT (m) | TABLE ANGLE (Degree) | RAW VALUE (dBuV) | CORRECTION FACTOR (dB/m) |
| 1 | #5470.00 | 55.8 PK | 74.0 | -18.2 | 1.32 V | 133 | 51.8 | 4.0 |
| 2 | #5470.00 | 42.3 AV | 54.0 | -11.7 | 1.32 V | 133 | 38.3 | 4.0 |
| 3 | *5720.00 | 106.4 PK | | | 1.03 V | 123 | 66.0 | 40.4 |
| 4 | *5720.00 | 95.6 AV | | | 1.03 V | 123 | 55.2 | 40.4 |
| 5 | #5825.00 | 46.7 PK | 74.0 | -27.3 | 1.54 V | 139 | 42.0 | 4.7 |
| 6 | #5825.00 | 43.0 AV | 54.0 | -11.0 | 1.54 V | 139 | 38.3 | 4.7 |
| 7 | 11440.00 | 60.3 PK | 74.0 | -13.7 | 1.91 V | 162 | 42.0 | 18.3 |
| 8 | 11440.00 | 46.9 AV | 54.0 | -7.1 | 1.91 V | 162 | 28.6 | 18.3 |

Remarks:

1. Emission Level(dBuV/m) = Raw Value(dBuV) + Correction Factor(dB/m)
2. Correction Factor(dB/m) = Antenna Factor(dB/m) + Cable Factor(dB) – Pre-Amplifier Factor(dB)
3. The other emission levels were very low against the limit.
4. Margin value = Emission Level – Limit value
5. " * ": Fundamental frequency.
6. " # ": The radiated frequency is out of the restricted band.

802.11n (HT40)

| | | | |
|-----------------|---------------|----------------------|--------------|
| CHANNEL | TX Channel 54 | DETECTOR FUNCTION | Peak (PK) |
| FREQUENCY RANGE | 1GHz ~ 40GHz | | Average (AV) |

ANTENNA POLARITY & TEST DISTANCE: HORIZONTAL AT 3 M

| NO. | FREQ. (MHz) | EMISSION LEVEL (dBuV/m) | LIMIT (dBuV/m) | MARGIN (dB) | ANTENNA HEIGHT (m) | TABLE ANGLE (Degree) | RAW VALUE (dBuV) | CORRECTION FACTOR (dB/m) |
|-----|-------------|-------------------------------|-------------------|----------------|--------------------------|----------------------------|------------------------|--------------------------------|
| 1 | 5150.00 | 59.4 PK | 74.0 | -14.6 | 1.87 H | 352 | 55.8 | 3.6 |
| 2 | 5150.00 | 48.3 AV | 54.0 | -5.7 | 1.87 H | 352 | 44.7 | 3.6 |
| 3 | *5270.00 | 120.1 PK | | | 1.88 H | 353 | 80.5 | 39.6 |
| 4 | *5270.00 | 110.2 AV | | | 1.88 H | 353 | 70.6 | 39.6 |
| 5 | #10540.00 | 59.2 PK | 74.0 | -14.8 | 2.12 H | 30 | 42.1 | 17.1 |
| 6 | #10540.00 | 46.2 AV | 54.0 | -7.8 | 2.12 H | 30 | 29.1 | 17.1 |

ANTENNA POLARITY & TEST DISTANCE: VERTICAL AT 3 M

| NO. | FREQ. (MHz) | EMISSION LEVEL (dBuV/m) | LIMIT (dBuV/m) | MARGIN (dB) | ANTENNA HEIGHT (m) | TABLE ANGLE (Degree) | RAW VALUE (dBuV) | CORRECTION FACTOR (dB/m) |
|-----|-------------|-------------------------------|-------------------|----------------|--------------------------|----------------------------|------------------------|--------------------------------|
| 1 | 5150.00 | 57.0 PK | 74.0 | -17.0 | 1.55 V | 0 | 53.4 | 3.6 |
| 2 | 5150.00 | 46.0 AV | 54.0 | -8.0 | 1.55 V | 0 | 42.4 | 3.6 |
| 3 | *5270.00 | 101.5 PK | | | 1.35 V | 353 | 61.9 | 39.6 |
| 4 | *5270.00 | 91.1 AV | | | 1.35 V | 353 | 51.5 | 39.6 |
| 5 | #10540.00 | 58.7 PK | 74.0 | -15.3 | 1.84 V | 299 | 41.6 | 17.1 |
| 6 | #10540.00 | 45.7 AV | 54.0 | -8.3 | 1.84 V | 299 | 28.6 | 17.1 |

Remarks:

1. Emission Level(dBuV/m) = Raw Value(dBuV) + Correction Factor(dB/m)
2. Correction Factor(dB/m) = Antenna Factor(dB/m) + Cable Factor(dB) – Pre-Amplifier Factor(dB)
3. The other emission levels were very low against the limit.
4. Margin value = Emission Level – Limit value
5. " * ": Fundamental frequency.
6. " # ": The radiated frequency is out of the restricted band.

| | | | |
|-----------------|---------------|----------------------|--------------|
| CHANNEL | TX Channel 62 | DETECTOR FUNCTION | Peak (PK) |
| FREQUENCY RANGE | 1GHz ~ 40GHz | | Average (AV) |

ANTENNA POLARITY & TEST DISTANCE: HORIZONTAL AT 3 M

| NO. | FREQ. (MHz) | EMISSION LEVEL (dBuV/m) | LIMIT (dBuV/m) | MARGIN (dB) | ANTENNA HEIGHT (m) | TABLE ANGLE (Degree) | RAW VALUE (dBuV) | CORRECTION FACTOR (dB/m) |
|-----|-------------|-------------------------------|-------------------|----------------|--------------------------|----------------------------|------------------------|--------------------------------|
| 1 | *5310.00 | 117.0 PK | | | 1.89 H | 357 | 77.4 | 39.6 |
| 2 | *5310.00 | 106.8 AV | | | 1.89 H | 357 | 67.2 | 39.6 |
| 3 | 5350.00 | 66.8 PK | 74.0 | -7.2 | 1.31 H | 353 | 62.9 | 3.9 |
| 4 | 5350.00 | 52.5 AV | 54.0 | -1.5 | 1.31 H | 353 | 48.6 | 3.9 |
| 5 | 10620.00 | 58.9 PK | 74.0 | -15.1 | 2.21 H | 33 | 41.6 | 17.3 |
| 6 | 10620.00 | 45.8 AV | 54.0 | -8.2 | 2.21 H | 33 | 28.5 | 17.3 |

ANTENNA POLARITY & TEST DISTANCE: VERTICAL AT 3 M

| NO. | FREQ. (MHz) | EMISSION LEVEL (dBuV/m) | LIMIT (dBuV/m) | MARGIN (dB) | ANTENNA HEIGHT (m) | TABLE ANGLE (Degree) | RAW VALUE (dBuV) | CORRECTION FACTOR (dB/m) |
|-----|-------------|-------------------------------|-------------------|----------------|--------------------------|----------------------------|------------------------|--------------------------------|
| 1 | *5310.00 | 97.2 PK | | | 1.36 V | 358 | 57.6 | 39.6 |
| 2 | *5310.00 | 87.2 AV | | | 1.36 V | 358 | 47.6 | 39.6 |
| 3 | 5350.00 | 56.6 PK | 74.0 | -17.4 | 1.40 V | 303 | 52.7 | 3.9 |
| 4 | 5350.00 | 45.6 AV | 54.0 | -8.4 | 1.40 V | 303 | 41.7 | 3.9 |
| 5 | 10620.00 | 58.4 PK | 74.0 | -15.6 | 1.90 V | 305 | 41.1 | 17.3 |
| 6 | 10620.00 | 45.5 AV | 54.0 | -8.5 | 1.90 V | 305 | 28.2 | 17.3 |

Remarks:

1. Emission Level(dBuV/m) = Raw Value(dBuV) + Correction Factor(dB/m)
2. Correction Factor(dB/m) = Antenna Factor(dB/m) + Cable Factor(dB) – Pre-Amplifier Factor(dB)
3. The other emission levels were very low against the limit.
4. Margin value = Emission Level – Limit value
5. " * ": Fundamental frequency.
6. " # ": The radiated frequency is out of the restricted band.

| | | | |
|-----------------|----------------|----------------------|--------------|
| CHANNEL | TX Channel 102 | DETECTOR FUNCTION | Peak (PK) |
| FREQUENCY RANGE | 1GHz ~ 40GHz | | Average (AV) |

ANTENNA POLARITY & TEST DISTANCE: HORIZONTAL AT 3 M

| NO. | FREQ. (MHz) | EMISSION LEVEL (dBuV/m) | LIMIT (dBuV/m) | MARGIN (dB) | ANTENNA HEIGHT (m) | TABLE ANGLE (Degree) | RAW VALUE (dBuV) | CORRECTION FACTOR (dB/m) |
|-----|-------------|-------------------------|----------------|-------------|--------------------|----------------------|------------------|--------------------------|
| 1 | 5460.00 | 62.2 PK | 74.0 | -11.8 | 1.96 H | 354 | 58.2 | 4.0 |
| 2 | 5460.00 | 50.5 AV | 54.0 | -3.5 | 1.96 H | 354 | 46.5 | 4.0 |
| 3 | #5470.00 | 67.6 PK | 74.0 | -6.4 | 1.85 H | 352 | 63.6 | 4.0 |
| 4 | #5470.00 | 52.5 AV | 54.0 | -1.5 | 1.85 H | 352 | 48.5 | 4.0 |
| 5 | *5510.00 | 120.0 PK | | | 1.52 H | 354 | 80.0 | 40.0 |
| 6 | *5510.00 | 109.6 AV | | | 1.52 H | 354 | 69.6 | 40.0 |
| 7 | 11020.00 | 60.6 PK | 74.0 | -13.4 | 1.31 H | 19 | 41.7 | 18.9 |
| 8 | 11020.00 | 47.7 AV | 54.0 | -6.3 | 1.31 H | 19 | 28.8 | 18.9 |

ANTENNA POLARITY & TEST DISTANCE: VERTICAL AT 3 M

| NO. | FREQ. (MHz) | EMISSION LEVEL (dBuV/m) | LIMIT (dBuV/m) | MARGIN (dB) | ANTENNA HEIGHT (m) | TABLE ANGLE (Degree) | RAW VALUE (dBuV) | CORRECTION FACTOR (dB/m) |
|-----|-------------|-------------------------|----------------|-------------|--------------------|----------------------|------------------|--------------------------|
| 1 | 5460.00 | 56.2 PK | 74.0 | -17.8 | 1.66 V | 356 | 52.2 | 4.0 |
| 2 | 5460.00 | 45.4 AV | 54.0 | -8.6 | 1.66 V | 356 | 41.4 | 4.0 |
| 3 | #5470.00 | 56.9 PK | 74.0 | -17.1 | 1.73 V | 335 | 52.9 | 4.0 |
| 4 | #5470.00 | 46.3 AV | 54.0 | -7.7 | 1.73 V | 335 | 42.3 | 4.0 |
| 5 | *5510.00 | 102.4 PK | | | 1.48 V | 355 | 62.4 | 40.0 |
| 6 | *5510.00 | 92.2 AV | | | 1.48 V | 355 | 52.2 | 40.0 |
| 7 | 11020.00 | 60.2 PK | 74.0 | -13.8 | 1.41 V | 273 | 41.3 | 18.9 |
| 8 | 11020.00 | 47.3 AV | 54.0 | -6.7 | 1.41 V | 273 | 28.4 | 18.9 |

Remarks:

1. Emission Level(dBuV/m) = Raw Value(dBuV) + Correction Factor(dB/m)
2. Correction Factor(dB/m) = Antenna Factor(dB/m) + Cable Factor(dB) – Pre-Amplifier Factor(dB)
3. The other emission levels were very low against the limit.
4. Margin value = Emission Level – Limit value
5. " * ": Fundamental frequency.
6. " # ": The radiated frequency is out of the restricted band.

| | | | |
|-----------------|----------------|----------|--------------|
| CHANNEL | TX Channel 110 | DETECTOR | Peak (PK) |
| FREQUENCY RANGE | 1GHz ~ 40GHz | FUNCTION | Average (AV) |

ANTENNA POLARITY & TEST DISTANCE: HORIZONTAL AT 3 M

| NO. | FREQ. (MHz) | EMISSION LEVEL (dBuV/m) | LIMIT (dBuV/m) | MARGIN (dB) | ANTENNA HEIGHT (m) | TABLE ANGLE (Degree) | RAW VALUE (dBuV) | CORRECTION FACTOR (dB/m) |
|-----|-------------|-------------------------|----------------|-------------|--------------------|----------------------|------------------|--------------------------|
| 1 | *5550.00 | 122.9 PK | | | 1.71 H | 354 | 82.9 | 40.0 |
| 2 | *5550.00 | 112.9 AV | | | 1.71 H | 354 | 72.9 | 40.0 |
| 3 | 11100.00 | 61.1 PK | 74.0 | -12.9 | 2.18 H | 22 | 42.6 | 18.5 |
| 4 | 11100.00 | 48.2 AV | 54.0 | -5.8 | 2.18 H | 22 | 29.7 | 18.5 |

ANTENNA POLARITY & TEST DISTANCE: VERTICAL AT 3 M

| NO. | FREQ. (MHz) | EMISSION LEVEL (dBuV/m) | LIMIT (dBuV/m) | MARGIN (dB) | ANTENNA HEIGHT (m) | TABLE ANGLE (Degree) | RAW VALUE (dBuV) | CORRECTION FACTOR (dB/m) |
|-----|-------------|-------------------------|----------------|-------------|--------------------|----------------------|------------------|--------------------------|
| 1 | *5550.00 | 105.7 PK | | | 1.67 V | 353 | 65.7 | 40.0 |
| 2 | *5550.00 | 96.1 AV | | | 1.67 V | 353 | 56.1 | 40.0 |
| 3 | 11100.00 | 60.6 PK | 74.0 | -13.4 | 1.45 V | 255 | 42.1 | 18.5 |
| 4 | 11100.00 | 47.7 AV | 54.0 | -6.3 | 1.45 V | 255 | 29.2 | 18.5 |

Remarks:

1. Emission Level(dBuV/m) = Raw Value(dBuV) + Correction Factor(dB/m)
2. Correction Factor(dB/m) = Antenna Factor(dB/m) + Cable Factor(dB) – Pre-Amplifier Factor(dB)
3. The other emission levels were very low against the limit.
4. Margin value = Emission Level – Limit value
5. " * ": Fundamental frequency.
6. " # ": The radiated frequency is out of the restricted band.

| | | | |
|-----------------|----------------|-------------------|--------------|
| CHANNEL | TX Channel 134 | DETECTOR FUNCTION | Peak (PK) |
| FREQUENCY RANGE | 1GHz ~ 40GHz | | Average (AV) |

ANTENNA POLARITY & TEST DISTANCE: HORIZONTAL AT 3 M

| NO. | FREQ. (MHz) | EMISSION LEVEL (dBuV/m) | LIMIT (dBuV/m) | MARGIN (dB) | ANTENNA HEIGHT (m) | TABLE ANGLE (Degree) | RAW VALUE (dBuV) | CORRECTION FACTOR (dB/m) |
|-----|-------------|-------------------------|----------------|-------------|--------------------|----------------------|------------------|--------------------------|
| 1 | *5670.00 | 120.6 PK | | | 1.64 H | 354 | 80.3 | 40.3 |
| 2 | *5670.00 | 110.1 AV | | | 1.64 H | 354 | 69.8 | 40.3 |
| 3 | #5725.00 | 65.6 PK | 74.0 | -8.4 | 1.42 H | 349 | 61.1 | 4.5 |
| 4 | #5725.00 | 52.3 AV | 54.0 | -1.7 | 1.42 H | 349 | 47.8 | 4.5 |
| 5 | 11340.00 | 60.9 PK | 74.0 | -13.1 | 2.20 H | 25 | 42.5 | 18.4 |
| 6 | 11340.00 | 47.6 AV | 54.0 | -6.4 | 2.20 H | 25 | 29.2 | 18.4 |

ANTENNA POLARITY & TEST DISTANCE: VERTICAL AT 3 M

| NO. | FREQ. (MHz) | EMISSION LEVEL (dBuV/m) | LIMIT (dBuV/m) | MARGIN (dB) | ANTENNA HEIGHT (m) | TABLE ANGLE (Degree) | RAW VALUE (dBuV) | CORRECTION FACTOR (dB/m) |
|-----|-------------|-------------------------|----------------|-------------|--------------------|----------------------|------------------|--------------------------|
| 1 | *5670.00 | 104.6 PK | | | 1.63 V | 353 | 64.3 | 40.3 |
| 2 | *5670.00 | 94.4 AV | | | 1.63 V | 353 | 54.1 | 40.3 |
| 3 | #5725.00 | 56.3 PK | 74.0 | -17.7 | 1.65 V | 350 | 51.8 | 4.5 |
| 4 | #5725.00 | 45.1 AV | 54.0 | -8.9 | 1.65 V | 350 | 40.6 | 4.5 |
| 5 | 11340.00 | 60.1 PK | 74.0 | -13.9 | 1.40 V | 271 | 41.7 | 18.4 |
| 6 | 11340.00 | 47.1 AV | 54.0 | -6.9 | 1.40 V | 271 | 28.7 | 18.4 |

Remarks:

1. Emission Level(dBuV/m) = Raw Value(dBuV) + Correction Factor(dB/m)
2. Correction Factor(dB/m) = Antenna Factor(dB/m) + Cable Factor(dB) – Pre-Amplifier Factor(dB)
3. The other emission levels were very low against the limit.
4. Margin value = Emission Level – Limit value
5. " * ": Fundamental frequency.
6. " # ": The radiated frequency is out of the restricted band.

| | | | |
|-----------------|----------------|----------------------|--------------|
| CHANNEL | TX Channel 142 | DETECTOR FUNCTION | Peak (PK) |
| FREQUENCY RANGE | 1GHz ~ 40GHz | | Average (AV) |

| ANTENNA POLARITY & TEST DISTANCE: HORIZONTAL AT 3 M | | | | | | | | |
|---|-------------|-------------------------|----------------|-------------|--------------------|----------------------|------------------|--------------------------|
| NO. | FREQ. (MHz) | EMISSION LEVEL (dBuV/m) | LIMIT (dBuV/m) | MARGIN (dB) | ANTENNA HEIGHT (m) | TABLE ANGLE (Degree) | RAW VALUE (dBuV) | CORRECTION FACTOR (dB/m) |
| 1 | #5470.00 | 57.5 PK | 74.0 | -16.5 | 1.73 H | 181 | 53.5 | 4.0 |
| 2 | #5470.00 | 44.2 AV | 54.0 | -9.8 | 1.73 H | 181 | 40.2 | 4.0 |
| 3 | *5710.00 | 122.6 PK | | | 1.69 H | 164 | 82.2 | 40.4 |
| 4 | *5710.00 | 112.4 AV | | | 1.69 H | 164 | 72.0 | 40.4 |
| 5 | #5825.00 | 58.4 PK | 74.0 | -15.6 | 1.68 H | 173 | 53.7 | 4.7 |
| 6 | #5825.00 | 45.4 AV | 54.0 | -8.6 | 1.68 H | 173 | 40.7 | 4.7 |
| 7 | 11420.00 | 59.8 PK | 74.0 | -14.2 | 1.75 H | 186 | 41.6 | 18.2 |
| 8 | 11420.00 | 47.3 AV | 54.0 | -6.7 | 1.75 H | 186 | 29.1 | 18.2 |

| ANTENNA POLARITY & TEST DISTANCE: VERTICAL AT 3 M | | | | | | | | |
|---|-------------|-------------------------|----------------|-------------|--------------------|----------------------|------------------|--------------------------|
| NO. | FREQ. (MHz) | EMISSION LEVEL (dBuV/m) | LIMIT (dBuV/m) | MARGIN (dB) | ANTENNA HEIGHT (m) | TABLE ANGLE (Degree) | RAW VALUE (dBuV) | CORRECTION FACTOR (dB/m) |
| 1 | #5470.00 | 56.2 PK | 74.0 | -17.8 | 1.49 V | 173 | 52.2 | 4.0 |
| 2 | #5470.00 | 42.9 AV | 54.0 | -11.1 | 1.49 V | 173 | 38.9 | 4.0 |
| 3 | *5710.00 | 103.2 PK | | | 1.28 V | 160 | 62.8 | 40.4 |
| 4 | *5710.00 | 93.0 AV | | | 1.28 V | 160 | 52.6 | 40.4 |
| 5 | #5825.00 | 56.4 PK | 74.0 | -17.6 | 1.49 V | 151 | 51.7 | 4.7 |
| 6 | #5825.00 | 43.4 AV | 54.0 | -10.6 | 1.49 V | 151 | 38.7 | 4.7 |
| 7 | 11420.00 | 60.3 PK | 74.0 | -13.7 | 1.65 V | 154 | 42.1 | 18.2 |
| 8 | 11420.00 | 47.3 AV | 54.0 | -6.7 | 1.65 V | 154 | 29.1 | 18.2 |

Remarks:

1. Emission Level(dBuV/m) = Raw Value(dBuV) + Correction Factor(dB/m)
2. Correction Factor(dB/m) = Antenna Factor(dB/m) + Cable Factor(dB) – Pre-Amplifier Factor(dB)
3. The other emission levels were very low against the limit.
4. Margin value = Emission Level – Limit value
5. " * ": Fundamental frequency.
6. " # ": The radiated frequency is out of the restricted band.

802.11ac (VHT80)

| | | | |
|-----------------|---------------|----------------------|--------------|
| CHANNEL | TX Channel 58 | DETECTOR FUNCTION | Peak (PK) |
| FREQUENCY RANGE | 1GHz ~ 40GHz | | Average (AV) |

| ANTENNA POLARITY & TEST DISTANCE: HORIZONTAL AT 3 M | | | | | | | | |
|---|----------------|-------------------------------|-------------------|----------------|--------------------------|----------------------------|------------------------|--------------------------------|
| NO. | FREQ. (MHz) | EMISSION LEVEL (dBuV/m) | LIMIT (dBuV/m) | MARGIN (dB) | ANTENNA HEIGHT (m) | TABLE ANGLE (Degree) | RAW VALUE (dBuV) | CORRECTION FACTOR (dB/m) |
| 1 | 5150.00 | 57.4 PK | 74.0 | -16.6 | 1.55 H | 359 | 53.8 | 3.6 |
| 2 | 5150.00 | 46.2 AV | 54.0 | -7.8 | 1.55 H | 359 | 42.6 | 3.6 |
| 3 | *5290.00 | 110.1 PK | | | 1.92 H | 356 | 70.5 | 39.6 |
| 4 | *5290.00 | 100.0 AV | | | 1.92 H | 356 | 60.4 | 39.6 |
| 5 | 5350.00 | 64.9 PK | 74.0 | -9.1 | 1.89 H | 357 | 61.0 | 3.9 |
| 6 | 5350.00 | 52.3 AV | 54.0 | -1.7 | 1.89 H | 357 | 48.4 | 3.9 |
| 7 | #10580.00 | 58.4 PK | 74.0 | -15.6 | 2.28 H | 35 | 41.2 | 17.2 |
| 8 | #10580.00 | 45.4 AV | 54.0 | -8.6 | 2.28 H | 35 | 28.2 | 17.2 |
| ANTENNA POLARITY & TEST DISTANCE: VERTICAL AT 3 M | | | | | | | | |
| NO. | FREQ. (MHz) | EMISSION LEVEL (dBuV/m) | LIMIT (dBuV/m) | MARGIN (dB) | ANTENNA HEIGHT (m) | TABLE ANGLE (Degree) | RAW VALUE (dBuV) | CORRECTION FACTOR (dB/m) |
| 1 | 5150.00 | 55.4 PK | 74.0 | -18.6 | 1.60 V | 350 | 51.8 | 3.6 |
| 2 | 5150.00 | 44.5 AV | 54.0 | -9.5 | 1.60 V | 350 | 40.9 | 3.6 |
| 3 | *5290.00 | 91.7 PK | | | 1.46 V | 355 | 52.1 | 39.6 |
| 4 | *5290.00 | 81.8 AV | | | 1.46 V | 355 | 42.2 | 39.6 |
| 5 | 5350.00 | 56.3 PK | 74.0 | -17.7 | 1.59 V | 333 | 52.4 | 3.9 |
| 6 | 5350.00 | 45.7 AV | 54.0 | -8.3 | 1.59 V | 333 | 41.8 | 3.9 |
| 7 | #10580.00 | 58.3 PK | 74.0 | -15.7 | 1.80 V | 311 | 41.1 | 17.2 |
| 8 | #10580.00 | 45.2 AV | 54.0 | -8.8 | 1.80 V | 311 | 28.0 | 17.2 |

Remarks:

1. Emission Level(dBuV/m) = Raw Value(dBuV) + Correction Factor(dB/m)
2. Correction Factor(dB/m) = Antenna Factor(dB/m) + Cable Factor(dB) – Pre-Amplifier Factor(dB)
3. The other emission levels were very low against the limit.
4. Margin value = Emission Level – Limit value
5. " * ": Fundamental frequency.
6. " # ": The radiated frequency is out of the restricted band.

| | | | |
|-----------------|----------------|----------------------|--------------|
| CHANNEL | TX Channel 106 | DETECTOR FUNCTION | Peak (PK) |
| FREQUENCY RANGE | 1GHz ~ 40GHz | | Average (AV) |

ANTENNA POLARITY & TEST DISTANCE: HORIZONTAL AT 3 M

| NO. | FREQ. (MHz) | EMISSION LEVEL (dBuV/m) | LIMIT (dBuV/m) | MARGIN (dB) | ANTENNA HEIGHT (m) | TABLE ANGLE (Degree) | RAW VALUE (dBuV) | CORRECTION FACTOR (dB/m) |
|-----|----------------|-------------------------------|-------------------|----------------|--------------------------|----------------------------|------------------------|--------------------------------|
| 1 | 5460.00 | 69.0 PK | 74.0 | -5.0 | 1.51 H | 350 | 65.0 | 4.0 |
| 2 | 5460.00 | 52.4 AV | 54.0 | -1.6 | 1.51 H | 350 | 48.4 | 4.0 |
| 3 | #5470.00 | 69.6 PK | 74.0 | -4.4 | 1.33 H | 351 | 65.6 | 4.0 |
| 4 | #5470.00 | 51.9 AV | 54.0 | -2.1 | 1.33 H | 351 | 47.9 | 4.0 |
| 5 | *5530.00 | 107.1 PK | | | 1.75 H | 354 | 67.1 | 40.0 |
| 6 | *5530.00 | 94.9 AV | | | 1.75 H | 354 | 54.9 | 40.0 |
| 7 | #5725.00 | 58.6 PK | 74.0 | -15.4 | 1.49 H | 355 | 54.1 | 4.5 |
| 8 | #5725.00 | 45.4 AV | 54.0 | -8.6 | 1.49 H | 355 | 40.9 | 4.5 |
| 9 | 11060.00 | 60.0 PK | 74.0 | -14.0 | 2.21 H | 31 | 41.4 | 18.6 |
| 10 | 11060.00 | 46.9 AV | 54.0 | -7.1 | 2.21 H | 31 | 28.3 | 18.6 |

ANTENNA POLARITY & TEST DISTANCE: VERTICAL AT 3 M

| NO. | FREQ. (MHz) | EMISSION LEVEL (dBuV/m) | LIMIT (dBuV/m) | MARGIN (dB) | ANTENNA HEIGHT (m) | TABLE ANGLE (Degree) | RAW VALUE (dBuV) | CORRECTION FACTOR (dB/m) |
|-----|----------------|-------------------------------|-------------------|----------------|--------------------------|----------------------------|------------------------|--------------------------------|
| 1 | 5460.00 | 56.4 PK | 74.0 | -17.6 | 1.67 V | 355 | 52.4 | 4.0 |
| 2 | 5460.00 | 44.3 AV | 54.0 | -9.7 | 1.67 V | 355 | 40.3 | 4.0 |
| 3 | #5470.00 | 55.2 PK | 74.0 | -18.8 | 1.70 V | 351 | 51.2 | 4.0 |
| 4 | #5470.00 | 43.9 AV | 54.0 | -10.1 | 1.70 V | 351 | 39.9 | 4.0 |
| 5 | *5530.00 | 90.4 PK | | | 1.71 V | 355 | 50.4 | 40.0 |
| 6 | *5530.00 | 80.9 AV | | | 1.71 V | 355 | 40.9 | 40.0 |
| 7 | #5725.00 | 46.4 PK | 74.0 | -27.6 | 1.70 V | 349 | 41.9 | 4.5 |
| 8 | #5725.00 | 44.9 AV | 54.0 | -9.1 | 1.70 V | 349 | 40.4 | 4.5 |
| 9 | 10600.00 | 57.5 PK | 74.0 | -16.5 | 1.44 V | 265 | 40.4 | 17.1 |
| 10 | 10600.00 | 44.4 AV | 54.0 | -9.6 | 1.44 V | 265 | 27.3 | 17.1 |

Remarks:

1. Emission Level(dBuV/m) = Raw Value(dBuV) + Correction Factor(dB/m)
2. Correction Factor(dB/m) = Antenna Factor(dB/m) + Cable Factor(dB) – Pre-Amplifier Factor(dB)
3. The other emission levels were very low against the limit.
4. Margin value = Emission Level – Limit value
5. " * ": Fundamental frequency.
6. " # ": The radiated frequency is out of the restricted band.

| | | | |
|-----------------|----------------|----------------------|--------------|
| CHANNEL | TX Channel 122 | DETECTOR FUNCTION | Peak (PK) |
| FREQUENCY RANGE | 1GHz ~ 40GHz | | Average (AV) |

ANTENNA POLARITY & TEST DISTANCE: HORIZONTAL AT 3 M

| NO. | FREQ. (MHz) | EMISSION LEVEL (dBuV/m) | LIMIT (dBuV/m) | MARGIN (dB) | ANTENNA HEIGHT (m) | TABLE ANGLE (Degree) | RAW VALUE (dBuV) | CORRECTION FACTOR (dB/m) |
|-----|----------------|-------------------------------|-------------------|----------------|--------------------------|----------------------------|------------------------|--------------------------------|
| 1 | 5460.00 | 61.5 PK | 74.0 | -12.5 | 1.71 H | 165 | 57.5 | 4.0 |
| 2 | 5460.00 | 46.5 AV | 54.0 | -7.5 | 1.71 H | 165 | 42.5 | 4.0 |
| 3 | #5470.00 | 66.5 PK | 74.0 | -7.5 | 1.78 H | 163 | 62.5 | 4.0 |
| 4 | #5470.00 | 51.8 AV | 54.0 | -2.2 | 1.78 H | 163 | 47.8 | 4.0 |
| 5 | *5610.00 | 117.6 PK | | | 1.68 H | 163 | 77.4 | 40.2 |
| 6 | *5610.00 | 107.3 AV | | | 1.68 H | 163 | 67.1 | 40.2 |
| 7 | #5725.00 | 66.0 PK | 74.0 | -8.0 | 1.68 H | 163 | 61.5 | 4.5 |
| 8 | #5725.00 | 52.7 AV | 54.0 | -1.3 | 1.68 H | 163 | 48.2 | 4.5 |
| 9 | 11220.00 | 59.8 PK | 74.0 | -14.2 | 1.97 H | 203 | 40.9 | 18.9 |
| 10 | 11220.00 | 47.1 AV | 54.0 | -6.9 | 1.97 H | 203 | 28.2 | 18.9 |

ANTENNA POLARITY & TEST DISTANCE: VERTICAL AT 3 M

| NO. | FREQ. (MHz) | EMISSION LEVEL (dBuV/m) | LIMIT (dBuV/m) | MARGIN (dB) | ANTENNA HEIGHT (m) | TABLE ANGLE (Degree) | RAW VALUE (dBuV) | CORRECTION FACTOR (dB/m) |
|-----|----------------|-------------------------------|-------------------|----------------|--------------------------|----------------------------|------------------------|--------------------------------|
| 1 | 5460.00 | 53.8 PK | 74.0 | -20.2 | 1.19 V | 178 | 49.8 | 4.0 |
| 2 | 5460.00 | 41.7 AV | 54.0 | -12.3 | 1.19 V | 178 | 37.7 | 4.0 |
| 3 | #5470.00 | 56.0 PK | 74.0 | -18.0 | 1.21 V | 178 | 52.0 | 4.0 |
| 4 | #5470.00 | 42.2 AV | 54.0 | -11.8 | 1.21 V | 178 | 38.2 | 4.0 |
| 5 | *5610.00 | 97.9 PK | | | 1.14 V | 166 | 57.7 | 40.2 |
| 6 | *5610.00 | 88.1 AV | | | 1.14 V | 166 | 47.9 | 40.2 |
| 7 | #5725.00 | 56.2 PK | 74.0 | -17.8 | 1.31 V | 173 | 51.7 | 4.5 |
| 8 | #5725.00 | 42.8 AV | 54.0 | -11.2 | 1.31 V | 173 | 38.3 | 4.5 |
| 9 | 11220.00 | 60.6 PK | 74.0 | -13.4 | 1.53 V | 201 | 41.7 | 18.9 |
| 10 | 11220.00 | 47.1 AV | 54.0 | -6.9 | 1.53 V | 201 | 28.2 | 18.9 |

Remarks:

1. Emission Level(dBuV/m) = Raw Value(dBuV) + Correction Factor(dB/m)
2. Correction Factor(dB/m) = Antenna Factor(dB/m) + Cable Factor(dB) – Pre-Amplifier Factor(dB)
3. The other emission levels were very low against the limit.
4. Margin value = Emission Level – Limit value
5. " * ": Fundamental frequency.
6. " # ": The radiated frequency is out of the restricted band.

| | | | |
|-----------------|----------------|-------------------|--------------|
| CHANNEL | TX Channel 138 | DETECTOR FUNCTION | Peak (PK) |
| FREQUENCY RANGE | 1GHz ~ 40GHz | | Average (AV) |

ANTENNA POLARITY & TEST DISTANCE: HORIZONTAL AT 3 M

| NO. | FREQ. (MHz) | EMISSION LEVEL (dBuV/m) | LIMIT (dBuV/m) | MARGIN (dB) | ANTENNA HEIGHT (m) | TABLE ANGLE (Degree) | RAW VALUE (dBuV) | CORRECTION FACTOR (dB/m) |
|-----|-------------|-------------------------|----------------|-------------|--------------------|----------------------|------------------|--------------------------|
| 1 | #5470.00 | 59.0 PK | 74.0 | -15.0 | 1.81 H | 179 | 55.0 | 4.0 |
| 2 | #5470.00 | 45.0 AV | 54.0 | -9.0 | 1.81 H | 179 | 41.0 | 4.0 |
| 3 | *5690.00 | 119.3 PK | | | 1.73 H | 164 | 79.0 | 40.3 |
| 4 | *5690.00 | 108.4 AV | | | 1.73 H | 164 | 68.1 | 40.3 |
| 5 | #5825.00 | 66.0 PK | 74.0 | -8.0 | 1.76 H | 163 | 61.3 | 4.7 |
| 6 | #5825.00 | 52.9 AV | 54.0 | -1.1 | 1.76 H | 163 | 48.2 | 4.7 |
| 7 | 11380.00 | 60.7 PK | 74.0 | -13.3 | 1.91 H | 178 | 42.4 | 18.3 |
| 8 | 11380.00 | 47.9 AV | 54.0 | -6.1 | 1.91 H | 178 | 29.6 | 18.3 |

ANTENNA POLARITY & TEST DISTANCE: VERTICAL AT 3 M

| NO. | FREQ. (MHz) | EMISSION LEVEL (dBuV/m) | LIMIT (dBuV/m) | MARGIN (dB) | ANTENNA HEIGHT (m) | TABLE ANGLE (Degree) | RAW VALUE (dBuV) | CORRECTION FACTOR (dB/m) |
|-----|-------------|-------------------------|----------------|-------------|--------------------|----------------------|------------------|--------------------------|
| 1 | #5470.00 | 45.7 PK | 74.0 | -28.3 | 1.54 V | 169 | 41.7 | 4.0 |
| 2 | #5470.00 | 42.6 AV | 54.0 | -11.4 | 1.54 V | 169 | 38.6 | 4.0 |
| 3 | *5690.00 | 99.4 PK | | | 1.27 V | 158 | 59.1 | 40.3 |
| 4 | *5690.00 | 89.3 AV | | | 1.27 V | 158 | 49.0 | 40.3 |
| 5 | #5825.00 | 56.9 PK | 74.0 | -17.1 | 1.44 V | 167 | 52.2 | 4.7 |
| 6 | #5825.00 | 43.5 AV | 54.0 | -10.5 | 1.44 V | 167 | 38.8 | 4.7 |
| 7 | 11380.00 | 60.9 PK | 74.0 | -13.1 | 1.83 V | 122 | 42.6 | 18.3 |
| 8 | 11380.00 | 47.8 AV | 54.0 | -6.2 | 1.83 V | 122 | 29.5 | 18.3 |

Remarks:

1. Emission Level(dBuV/m) = Raw Value(dBuV) + Correction Factor(dB/m)
2. Correction Factor(dB/m) = Antenna Factor(dB/m) + Cable Factor(dB) – Pre-Amplifier Factor(dB)
3. The other emission levels were very low against the limit.
4. Margin value = Emission Level – Limit value
5. " * ": Fundamental frequency.
6. " # ": The radiated frequency is out of the restricted band.

Mode A2

802.11a

| | | | |
|-----------------|---------------|----------------------|--------------|
| CHANNEL | TX Channel 52 | DETECTOR FUNCTION | Peak (PK) |
| FREQUENCY RANGE | 1GHz ~ 40GHz | | Average (AV) |

ANTENNA POLARITY & TEST DISTANCE: HORIZONTAL AT 3 M

| NO. | FREQ. (MHz) | EMISSION LEVEL (dBuV/m) | LIMIT (dBuV/m) | MARGIN (dB) | ANTENNA HEIGHT (m) | TABLE ANGLE (Degree) | RAW VALUE (dBuV) | CORRECTION FACTOR (dB/m) |
|-----|----------------|-------------------------------|-------------------|----------------|--------------------------|----------------------------|------------------------|--------------------------------|
| 1 | 5150.00 | 55.5 PK | 74.0 | -18.5 | 1.66 H | 347 | 51.9 | 3.6 |
| 2 | 5150.00 | 43.8 AV | 54.0 | -10.2 | 1.66 H | 347 | 40.2 | 3.6 |
| 3 | *5260.00 | 117.3 PK | | | 1.96 H | 355 | 77.7 | 39.6 |
| 4 | *5260.00 | 106.9 AV | | | 1.96 H | 355 | 67.3 | 39.6 |
| 5 | #10520.00 | 58.2 PK | 74.0 | -15.8 | 1.79 H | 328 | 41.2 | 17.0 |
| 6 | #10520.00 | 44.9 AV | 54.0 | -9.1 | 1.79 H | 328 | 27.9 | 17.0 |

ANTENNA POLARITY & TEST DISTANCE: VERTICAL AT 3 M

| NO. | FREQ. (MHz) | EMISSION LEVEL (dBuV/m) | LIMIT (dBuV/m) | MARGIN (dB) | ANTENNA HEIGHT (m) | TABLE ANGLE (Degree) | RAW VALUE (dBuV) | CORRECTION FACTOR (dB/m) |
|-----|----------------|-------------------------------|-------------------|----------------|--------------------------|----------------------------|------------------------|--------------------------------|
| 1 | 5150.00 | 56.1 PK | 74.0 | -17.9 | 1.73 V | 344 | 52.5 | 3.6 |
| 2 | 5150.00 | 44.1 AV | 54.0 | -9.9 | 1.73 V | 344 | 40.5 | 3.6 |
| 3 | *5260.00 | 118.1 PK | | | 1.94 V | 352 | 78.5 | 39.6 |
| 4 | *5260.00 | 107.4 AV | | | 1.94 V | 352 | 67.8 | 39.6 |
| 5 | #10520.00 | 59.1 PK | 74.0 | -14.9 | 1.68 V | 311 | 42.1 | 17.0 |
| 6 | #10520.00 | 45.0 AV | 54.0 | -9.0 | 1.68 V | 311 | 28.0 | 17.0 |

Remarks:

1. Emission Level(dBuV/m) = Raw Value(dBuV) + Correction Factor(dB/m)
2. Correction Factor(dB/m) = Antenna Factor(dB/m) + Cable Factor(dB) – Pre-Amplifier Factor(dB)
3. The other emission levels were very low against the limit.
4. Margin value = Emission Level – Limit value
5. " * ": Fundamental frequency.
6. " # ": The radiated frequency is out of the restricted band.

| | | | |
|-----------------|---------------|----------|--------------|
| CHANNEL | TX Channel 60 | DETECTOR | Peak (PK) |
| FREQUENCY RANGE | 1GHz ~ 40GHz | FUNCTION | Average (AV) |

ANTENNA POLARITY & TEST DISTANCE: HORIZONTAL AT 3 M

| NO. | FREQ. (MHz) | EMISSION LEVEL (dBuV/m) | LIMIT (dBuV/m) | MARGIN (dB) | ANTENNA HEIGHT (m) | TABLE ANGLE (Degree) | RAW VALUE (dBuV) | CORRECTION FACTOR (dB/m) |
|-----|-------------|-------------------------|----------------|-------------|--------------------|----------------------|------------------|--------------------------|
| 1 | *5300.00 | 119.0 PK | | | 1.67 H | 351 | 79.4 | 39.6 |
| 2 | *5300.00 | 107.9 AV | | | 1.67 H | 351 | 68.3 | 39.6 |
| 3 | 10600.00 | 58.4 PK | 74.0 | -15.6 | 1.74 H | 330 | 41.3 | 17.1 |
| 4 | 10600.00 | 45.0 AV | 54.0 | -9.0 | 1.74 H | 330 | 27.9 | 17.1 |

ANTENNA POLARITY & TEST DISTANCE: VERTICAL AT 3 M

| NO. | FREQ. (MHz) | EMISSION LEVEL (dBuV/m) | LIMIT (dBuV/m) | MARGIN (dB) | ANTENNA HEIGHT (m) | TABLE ANGLE (Degree) | RAW VALUE (dBuV) | CORRECTION FACTOR (dB/m) |
|-----|-------------|-------------------------|----------------|-------------|--------------------|----------------------|------------------|--------------------------|
| 1 | *5300.00 | 116.4 PK | | | 1.65 V | 342 | 76.8 | 39.6 |
| 2 | *5300.00 | 105.8 AV | | | 1.65 V | 342 | 66.2 | 39.6 |
| 3 | 10600.00 | 59.1 PK | 74.0 | -14.9 | 1.83 V | 339 | 42.0 | 17.1 |
| 4 | 10600.00 | 45.5 AV | 54.0 | -8.5 | 1.83 V | 339 | 28.4 | 17.1 |

Remarks:

1. Emission Level(dBuV/m) = Raw Value(dBuV) + Correction Factor(dB/m)
2. Correction Factor(dB/m) = Antenna Factor(dB/m) + Cable Factor(dB) – Pre-Amplifier Factor(dB)
3. The other emission levels were very low against the limit.
4. Margin value = Emission Level – Limit value
5. " * ": Fundamental frequency.
6. " # ": The radiated frequency is out of the restricted band.

| | | | |
|-----------------|---------------|-------------------|--------------|
| CHANNEL | TX Channel 64 | DETECTOR FUNCTION | Peak (PK) |
| FREQUENCY RANGE | 1GHz ~ 40GHz | | Average (AV) |

ANTENNA POLARITY & TEST DISTANCE: HORIZONTAL AT 3 M

| NO. | FREQ. (MHz) | EMISSION LEVEL (dBuV/m) | LIMIT (dBuV/m) | MARGIN (dB) | ANTENNA HEIGHT (m) | TABLE ANGLE (Degree) | RAW VALUE (dBuV) | CORRECTION FACTOR (dB/m) |
|-----|-------------|-------------------------|----------------|-------------|--------------------|----------------------|------------------|--------------------------|
| 1 | *5320.00 | 119.9 PK | | | 1.66 H | 351 | 80.2 | 39.7 |
| 2 | *5320.00 | 108.6 AV | | | 1.66 H | 351 | 68.9 | 39.7 |
| 3 | 5350.00 | 57.5 PK | 74.0 | -16.5 | 1.80 H | 354 | 53.6 | 3.9 |
| 4 | 5350.00 | 45.1 AV | 54.0 | -8.9 | 1.80 H | 354 | 41.2 | 3.9 |
| 5 | 10640.00 | 58.4 PK | 74.0 | -15.6 | 1.77 H | 321 | 41.1 | 17.3 |
| 6 | 10640.00 | 45.6 AV | 54.0 | -8.4 | 1.77 H | 321 | 28.3 | 17.3 |

ANTENNA POLARITY & TEST DISTANCE: VERTICAL AT 3 M

| NO. | FREQ. (MHz) | EMISSION LEVEL (dBuV/m) | LIMIT (dBuV/m) | MARGIN (dB) | ANTENNA HEIGHT (m) | TABLE ANGLE (Degree) | RAW VALUE (dBuV) | CORRECTION FACTOR (dB/m) |
|-----|-------------|-------------------------|----------------|-------------|--------------------|----------------------|------------------|--------------------------|
| 1 | *5320.00 | 118.4 PK | | | 1.78 V | 352 | 78.7 | 39.7 |
| 2 | *5320.00 | 107.7 AV | | | 1.78 V | 352 | 68.0 | 39.7 |
| 3 | 5350.00 | 58.3 PK | 74.0 | -15.7 | 1.80 V | 346 | 54.4 | 3.9 |
| 4 | 5350.00 | 45.4 AV | 54.0 | -8.6 | 1.80 V | 346 | 41.5 | 3.9 |
| 5 | 10640.00 | 58.8 PK | 74.0 | -15.2 | 1.79 V | 359 | 41.5 | 17.3 |
| 6 | 10640.00 | 45.1 AV | 54.0 | -8.9 | 1.79 V | 359 | 27.8 | 17.3 |

Remarks:

1. Emission Level(dBuV/m) = Raw Value(dBuV) + Correction Factor(dB/m)
2. Correction Factor(dB/m) = Antenna Factor(dB/m) + Cable Factor(dB) – Pre-Amplifier Factor(dB)
3. The other emission levels were very low against the limit.
4. Margin value = Emission Level – Limit value
5. " * ": Fundamental frequency.
6. " # ": The radiated frequency is out of the restricted band.

| | | | |
|-----------------|----------------|-------------------|--------------|
| CHANNEL | TX Channel 100 | DETECTOR FUNCTION | Peak (PK) |
| FREQUENCY RANGE | 1GHz ~ 40GHz | | Average (AV) |

| ANTENNA POLARITY & TEST DISTANCE: HORIZONTAL AT 3 M | | | | | | | | |
|---|-------------|-------------------------|----------------|-------------|--------------------|----------------------|------------------|--------------------------|
| NO. | FREQ. (MHz) | EMISSION LEVEL (dBuV/m) | LIMIT (dBuV/m) | MARGIN (dB) | ANTENNA HEIGHT (m) | TABLE ANGLE (Degree) | RAW VALUE (dBuV) | CORRECTION FACTOR (dB/m) |
| 1 | 5460.00 | 56.7 PK | 74.0 | -17.3 | 1.79 H | 347 | 52.7 | 4.0 |
| 2 | 5460.00 | 44.3 AV | 54.0 | -9.7 | 1.79 H | 347 | 40.3 | 4.0 |
| 3 | #5470.00 | 57.7 PK | 74.0 | -16.3 | 1.80 H | 359 | 53.7 | 4.0 |
| 4 | #5470.00 | 44.7 AV | 54.0 | -9.3 | 1.80 H | 359 | 40.7 | 4.0 |
| 5 | *5500.00 | 119.3 PK | | | 1.77 H | 350 | 79.3 | 40.0 |
| 6 | *5500.00 | 108.4 AV | | | 1.77 H | 350 | 68.4 | 40.0 |
| 7 | 11000.00 | 60.6 PK | 74.0 | -13.4 | 1.91 H | 326 | 41.6 | 19.0 |
| 8 | 11000.00 | 46.9 AV | 54.0 | -7.1 | 1.91 H | 326 | 27.9 | 19.0 |

| ANTENNA POLARITY & TEST DISTANCE: VERTICAL AT 3 M | | | | | | | | |
|---|-------------|-------------------------|----------------|-------------|--------------------|----------------------|------------------|--------------------------|
| NO. | FREQ. (MHz) | EMISSION LEVEL (dBuV/m) | LIMIT (dBuV/m) | MARGIN (dB) | ANTENNA HEIGHT (m) | TABLE ANGLE (Degree) | RAW VALUE (dBuV) | CORRECTION FACTOR (dB/m) |
| 1 | 5460.00 | 56.7 PK | 74.0 | -17.3 | 1.81 V | 343 | 52.7 | 4.0 |
| 2 | 5460.00 | 44.3 AV | 54.0 | -9.7 | 1.81 V | 343 | 40.3 | 4.0 |
| 3 | #5470.00 | 58.6 PK | 74.0 | -15.4 | 1.69 V | 351 | 54.6 | 4.0 |
| 4 | #5470.00 | 44.9 AV | 54.0 | -9.1 | 1.69 V | 351 | 40.9 | 4.0 |
| 5 | *5500.00 | 117.1 PK | | | 1.76 V | 353 | 77.1 | 40.0 |
| 6 | *5500.00 | 106.3 AV | | | 1.76 V | 353 | 66.3 | 40.0 |
| 7 | 11000.00 | 59.6 PK | 74.0 | -14.4 | 1.83 V | 297 | 40.6 | 19.0 |
| 8 | 11000.00 | 46.7 AV | 54.0 | -7.3 | 1.83 V | 297 | 27.7 | 19.0 |

Remarks:

1. Emission Level(dBuV/m) = Raw Value(dBuV) + Correction Factor(dB/m)
2. Correction Factor(dB/m) = Antenna Factor(dB/m) + Cable Factor(dB) – Pre-Amplifier Factor(dB)
3. The other emission levels were very low against the limit.
4. Margin value = Emission Level – Limit value
5. " * ": Fundamental frequency.
6. " # ": The radiated frequency is out of the restricted band.

| | | | |
|-----------------|----------------|-------------------|--------------|
| CHANNEL | TX Channel 116 | DETECTOR FUNCTION | Peak (PK) |
| FREQUENCY RANGE | 1GHz ~ 40GHz | | Average (AV) |

ANTENNA POLARITY & TEST DISTANCE: HORIZONTAL AT 3 M

| NO. | FREQ. (MHz) | EMISSION LEVEL (dBuV/m) | LIMIT (dBuV/m) | MARGIN (dB) | ANTENNA HEIGHT (m) | TABLE ANGLE (Degree) | RAW VALUE (dBuV) | CORRECTION FACTOR (dB/m) |
|-----|-------------|-------------------------|----------------|-------------|--------------------|----------------------|------------------|--------------------------|
| 1 | *5580.00 | 119.8 PK | | | 1.65 H | 352 | 79.7 | 40.1 |
| 2 | *5580.00 | 108.5 AV | | | 1.65 H | 352 | 68.4 | 40.1 |
| 3 | 11160.00 | 60.3 PK | 74.0 | -13.7 | 1.85 H | 359 | 41.6 | 18.7 |
| 4 | 11160.00 | 46.6 AV | 54.0 | -7.4 | 1.85 H | 359 | 27.9 | 18.7 |

ANTENNA POLARITY & TEST DISTANCE: VERTICAL AT 3 M

| NO. | FREQ. (MHz) | EMISSION LEVEL (dBuV/m) | LIMIT (dBuV/m) | MARGIN (dB) | ANTENNA HEIGHT (m) | TABLE ANGLE (Degree) | RAW VALUE (dBuV) | CORRECTION FACTOR (dB/m) |
|-----|-------------|-------------------------|----------------|-------------|--------------------|----------------------|------------------|--------------------------|
| 1 | *5580.00 | 118.1 PK | | | 1.85 V | 351 | 78.0 | 40.1 |
| 2 | *5580.00 | 107.6 AV | | | 1.85 V | 351 | 67.5 | 40.1 |
| 3 | 11160.00 | 59.9 PK | 74.0 | -14.1 | 1.92 V | 341 | 41.2 | 18.7 |
| 4 | 11160.00 | 46.6 AV | 54.0 | -7.4 | 1.92 V | 341 | 27.9 | 18.7 |

Remarks:

1. Emission Level(dBuV/m) = Raw Value(dBuV) + Correction Factor(dB/m)
2. Correction Factor(dB/m) = Antenna Factor(dB/m) + Cable Factor(dB) – Pre-Amplifier Factor(dB)
3. The other emission levels were very low against the limit.
4. Margin value = Emission Level – Limit value
5. " * ": Fundamental frequency.
6. " # ": The radiated frequency is out of the restricted band.

| | | | |
|-----------------|----------------|-------------------|--------------|
| CHANNEL | TX Channel 140 | DETECTOR FUNCTION | Peak (PK) |
| FREQUENCY RANGE | 1GHz ~ 40GHz | | Average (AV) |

| ANTENNA POLARITY & TEST DISTANCE: HORIZONTAL AT 3 M | | | | | | | | |
|---|-------------|-------------------------|----------------|-------------|--------------------|----------------------|------------------|--------------------------|
| NO. | FREQ. (MHz) | EMISSION LEVEL (dBuV/m) | LIMIT (dBuV/m) | MARGIN (dB) | ANTENNA HEIGHT (m) | TABLE ANGLE (Degree) | RAW VALUE (dBuV) | CORRECTION FACTOR (dB/m) |
| 1 | *5700.00 | 119.9 PK | | | 1.69 H | 350 | 79.6 | 40.3 |
| 2 | *5700.00 | 108.7 AV | | | 1.69 H | 350 | 68.4 | 40.3 |
| 3 | #5725.00 | 58.3 PK | 74.0 | -15.7 | 1.59 H | 341 | 53.8 | 4.5 |
| 4 | #5725.00 | 45.5 AV | 54.0 | -8.5 | 1.59 H | 341 | 41.0 | 4.5 |
| 5 | 11400.00 | 60.6 PK | 74.0 | -13.4 | 1.83 H | 338 | 42.4 | 18.2 |
| 6 | 11400.00 | 47.7 AV | 54.0 | -6.3 | 1.83 H | 338 | 29.5 | 18.2 |
| ANTENNA POLARITY & TEST DISTANCE: VERTICAL AT 3 M | | | | | | | | |
| NO. | FREQ. (MHz) | EMISSION LEVEL (dBuV/m) | LIMIT (dBuV/m) | MARGIN (dB) | ANTENNA HEIGHT (m) | TABLE ANGLE (Degree) | RAW VALUE (dBuV) | CORRECTION FACTOR (dB/m) |
| 1 | *5700.00 | 118.6 PK | | | 1.80 V | 352 | 78.3 | 40.3 |
| 2 | *5700.00 | 107.8 AV | | | 1.80 V | 352 | 67.5 | 40.3 |
| 3 | #5725.00 | 57.2 PK | 74.0 | -16.8 | 1.91 V | 357 | 52.7 | 4.5 |
| 4 | #5725.00 | 45.0 AV | 54.0 | -9.0 | 1.91 V | 357 | 40.5 | 4.5 |
| 5 | 11140.00 | 59.9 PK | 74.0 | -14.1 | 1.99 V | 333 | 41.3 | 18.6 |
| 6 | 11140.00 | 46.3 AV | 54.0 | -7.7 | 1.99 V | 333 | 27.7 | 18.6 |

Remarks:

1. Emission Level(dBuV/m) = Raw Value(dBuV) + Correction Factor(dB/m)
2. Correction Factor(dB/m) = Antenna Factor(dB/m) + Cable Factor(dB) – Pre-Amplifier Factor(dB)
3. The other emission levels were very low against the limit.
4. Margin value = Emission Level – Limit value
5. " * ": Fundamental frequency.
6. " # ": The radiated frequency is out of the restricted band.

| | | | |
|-----------------|----------------|----------------------|--------------|
| CHANNEL | TX Channel 144 | DETECTOR FUNCTION | Peak (PK) |
| FREQUENCY RANGE | 1GHz ~ 40GHz | | Average (AV) |

ANTENNA POLARITY & TEST DISTANCE: HORIZONTAL AT 3 M

| NO. | FREQ. (MHz) | EMISSION LEVEL (dBuV/m) | LIMIT (dBuV/m) | MARGIN (dB) | ANTENNA HEIGHT (m) | TABLE ANGLE (Degree) | RAW VALUE (dBuV) | CORRECTION FACTOR (dB/m) |
|-----|----------------|-------------------------------|-------------------|----------------|--------------------------|----------------------------|------------------------|--------------------------------|
| 1 | #5470.00 | 56.6 PK | 74.0 | -17.4 | 1.60 H | 345 | 52.6 | 4.0 |
| 2 | #5470.00 | 45.4 AV | 54.0 | -8.6 | 1.60 H | 345 | 41.4 | 4.0 |
| 3 | *5720.00 | 118.7 PK | | | 1.58 H | 349 | 78.3 | 40.4 |
| 4 | *5720.00 | 108.5 AV | | | 1.58 H | 349 | 68.1 | 40.4 |
| 5 | #5850.00 | 56.6 PK | 74.0 | -17.4 | 1.61 H | 349 | 51.8 | 4.8 |
| 6 | #5850.00 | 45.4 AV | 54.0 | -8.6 | 1.61 H | 349 | 40.6 | 4.8 |
| 7 | 11440.00 | 60.8 PK | 74.0 | -13.2 | 1.92 H | 12 | 42.5 | 18.3 |
| 8 | 11440.00 | 47.6 AV | 54.0 | -6.4 | 1.92 H | 12 | 29.3 | 18.3 |

ANTENNA POLARITY & TEST DISTANCE: VERTICAL AT 3 M

| NO. | FREQ. (MHz) | EMISSION LEVEL (dBuV/m) | LIMIT (dBuV/m) | MARGIN (dB) | ANTENNA HEIGHT (m) | TABLE ANGLE (Degree) | RAW VALUE (dBuV) | CORRECTION FACTOR (dB/m) |
|-----|----------------|-------------------------------|-------------------|----------------|--------------------------|----------------------------|------------------------|--------------------------------|
| 1 | #5470.00 | 56.7 PK | 74.0 | -17.3 | 2.00 V | 359 | 52.7 | 4.0 |
| 2 | #5470.00 | 45.5 AV | 54.0 | -8.5 | 2.00 V | 359 | 41.5 | 4.0 |
| 3 | *5720.00 | 119.2 PK | | | 1.97 V | 349 | 78.8 | 40.4 |
| 4 | *5720.00 | 109.2 AV | | | 1.97 V | 349 | 68.8 | 40.4 |
| 5 | #5850.00 | 56.6 PK | 74.0 | -17.4 | 2.02 V | 333 | 51.8 | 4.8 |
| 6 | #5850.00 | 45.1 AV | 54.0 | -8.9 | 2.02 V | 333 | 40.3 | 4.8 |
| 7 | 11440.00 | 60.5 PK | 74.0 | -13.5 | 1.22 V | 288 | 42.2 | 18.3 |
| 8 | 11440.00 | 47.5 AV | 54.0 | -6.5 | 1.22 V | 288 | 29.2 | 18.3 |

Remarks:

1. Emission Level(dBuV/m) = Raw Value(dBuV) + Correction Factor(dB/m)
2. Correction Factor(dB/m) = Antenna Factor(dB/m) + Cable Factor(dB) – Pre-Amplifier Factor(dB)
3. The other emission levels were very low against the limit.
4. Margin value = Emission Level – Limit value
5. " * ": Fundamental frequency.
6. " # ": The radiated frequency is out of the restricted band.

802.11n (HT20)

| | | | |
|-----------------|---------------|----------------------|--------------|
| CHANNEL | TX Channel 52 | DETECTOR FUNCTION | Peak (PK) |
| FREQUENCY RANGE | 1GHz ~ 40GHz | | Average (AV) |

ANTENNA POLARITY & TEST DISTANCE: HORIZONTAL AT 3 M

| NO. | FREQ. (MHz) | EMISSION LEVEL (dBuV/m) | LIMIT (dBuV/m) | MARGIN (dB) | ANTENNA HEIGHT (m) | TABLE ANGLE (Degree) | RAW VALUE (dBuV) | CORRECTION FACTOR (dB/m) |
|-----|----------------|-------------------------------|-------------------|----------------|--------------------------|----------------------------|------------------------|--------------------------------|
| 1 | 5150.00 | 54.6 PK | 74.0 | -19.4 | 1.86 H | 333 | 51.0 | 3.6 |
| 2 | 5150.00 | 41.9 AV | 54.0 | -12.1 | 1.86 H | 333 | 38.3 | 3.6 |
| 3 | *5260.00 | 119.4 PK | | | 1.73 H | 350 | 79.8 | 39.6 |
| 4 | *5260.00 | 108.0 AV | | | 1.73 H | 350 | 68.4 | 39.6 |
| 5 | #10520.00 | 58.0 PK | 74.0 | -16.0 | 1.89 H | 327 | 41.0 | 17.0 |
| 6 | #10520.00 | 44.8 AV | 54.0 | -9.2 | 1.89 H | 327 | 27.8 | 17.0 |

ANTENNA POLARITY & TEST DISTANCE: VERTICAL AT 3 M

| NO. | FREQ. (MHz) | EMISSION LEVEL (dBuV/m) | LIMIT (dBuV/m) | MARGIN (dB) | ANTENNA HEIGHT (m) | TABLE ANGLE (Degree) | RAW VALUE (dBuV) | CORRECTION FACTOR (dB/m) |
|-----|----------------|-------------------------------|-------------------|----------------|--------------------------|----------------------------|------------------------|--------------------------------|
| 1 | 5150.00 | 56.1 PK | 74.0 | -17.9 | 1.78 V | 346 | 52.5 | 3.6 |
| 2 | 5150.00 | 43.9 AV | 54.0 | -10.1 | 1.78 V | 346 | 40.3 | 3.6 |
| 3 | *5260.00 | 118.7 PK | | | 1.88 V | 352 | 79.1 | 39.6 |
| 4 | *5260.00 | 107.7 AV | | | 1.88 V | 352 | 68.1 | 39.6 |
| 5 | #10520.00 | 58.6 PK | 74.0 | -15.4 | 1.89 V | 341 | 41.6 | 17.0 |
| 6 | #10520.00 | 45.3 AV | 54.0 | -8.7 | 1.89 V | 341 | 28.3 | 17.0 |

Remarks:

1. Emission Level(dBuV/m) = Raw Value(dBuV) + Correction Factor(dB/m)
2. Correction Factor(dB/m) = Antenna Factor(dB/m) + Cable Factor(dB) – Pre-Amplifier Factor(dB)
3. The other emission levels were very low against the limit.
4. Margin value = Emission Level – Limit value
5. " * ": Fundamental frequency.
6. " # ": The radiated frequency is out of the restricted band.

| | | | |
|-----------------|---------------|----------|--------------|
| CHANNEL | TX Channel 60 | DETECTOR | Peak (PK) |
| FREQUENCY RANGE | 1GHz ~ 40GHz | FUNCTION | Average (AV) |

ANTENNA POLARITY & TEST DISTANCE: HORIZONTAL AT 3 M

| NO. | FREQ. (MHz) | EMISSION LEVEL (dBuV/m) | LIMIT (dBuV/m) | MARGIN (dB) | ANTENNA HEIGHT (m) | TABLE ANGLE (Degree) | RAW VALUE (dBuV) | CORRECTION FACTOR (dB/m) |
|-----|-------------|-------------------------|----------------|-------------|--------------------|----------------------|------------------|--------------------------|
| 1 | *5300.00 | 119.0 PK | | | 1.74 H | 348 | 79.4 | 39.6 |
| 2 | *5300.00 | 107.8 AV | | | 1.74 H | 348 | 68.2 | 39.6 |
| 3 | 10600.00 | 59.0 PK | 74.0 | -15.0 | 1.78 H | 337 | 41.9 | 17.1 |
| 4 | 10600.00 | 45.6 AV | 54.0 | -8.4 | 1.78 H | 337 | 28.5 | 17.1 |

ANTENNA POLARITY & TEST DISTANCE: VERTICAL AT 3 M

| NO. | FREQ. (MHz) | EMISSION LEVEL (dBuV/m) | LIMIT (dBuV/m) | MARGIN (dB) | ANTENNA HEIGHT (m) | TABLE ANGLE (Degree) | RAW VALUE (dBuV) | CORRECTION FACTOR (dB/m) |
|-----|-------------|-------------------------|----------------|-------------|--------------------|----------------------|------------------|--------------------------|
| 1 | *5300.00 | 118.2 PK | | | 1.88 V | 352 | 78.6 | 39.6 |
| 2 | *5300.00 | 107.7 AV | | | 1.88 V | 352 | 68.1 | 39.6 |
| 3 | 10600.00 | 58.7 PK | 74.0 | -15.3 | 1.78 V | 337 | 41.6 | 17.1 |
| 4 | 10600.00 | 45.4 AV | 54.0 | -8.6 | 1.78 V | 337 | 28.3 | 17.1 |

Remarks:

1. Emission Level(dBuV/m) = Raw Value(dBuV) + Correction Factor(dB/m)
2. Correction Factor(dB/m) = Antenna Factor(dB/m) + Cable Factor(dB) – Pre-Amplifier Factor(dB)
3. The other emission levels were very low against the limit.
4. Margin value = Emission Level – Limit value
5. " * ": Fundamental frequency.
6. " # ": The radiated frequency is out of the restricted band.

| | | | |
|-----------------|---------------|-------------------|--------------|
| CHANNEL | TX Channel 64 | DETECTOR FUNCTION | Peak (PK) |
| FREQUENCY RANGE | 1GHz ~ 40GHz | | Average (AV) |

ANTENNA POLARITY & TEST DISTANCE: HORIZONTAL AT 3 M

| NO. | FREQ. (MHz) | EMISSION LEVEL (dBuV/m) | LIMIT (dBuV/m) | MARGIN (dB) | ANTENNA HEIGHT (m) | TABLE ANGLE (Degree) | RAW VALUE (dBuV) | CORRECTION FACTOR (dB/m) |
|-----|-------------|-------------------------|----------------|-------------|--------------------|----------------------|------------------|--------------------------|
| 1 | *5320.00 | 119.5 PK | | | 1.70 H | 350 | 79.8 | 39.7 |
| 2 | *5320.00 | 107.9 AV | | | 1.70 H | 350 | 68.2 | 39.7 |
| 3 | 5350.00 | 58.0 PK | 74.0 | -16.0 | 1.66 H | 354 | 54.1 | 3.9 |
| 4 | 5350.00 | 45.3 AV | 54.0 | -8.7 | 1.66 H | 354 | 41.4 | 3.9 |
| 5 | 10640.00 | 58.1 PK | 74.0 | -15.9 | 1.83 H | 359 | 40.8 | 17.3 |
| 6 | 10640.00 | 44.8 AV | 54.0 | -9.2 | 1.83 H | 359 | 27.5 | 17.3 |

ANTENNA POLARITY & TEST DISTANCE: VERTICAL AT 3 M

| NO. | FREQ. (MHz) | EMISSION LEVEL (dBuV/m) | LIMIT (dBuV/m) | MARGIN (dB) | ANTENNA HEIGHT (m) | TABLE ANGLE (Degree) | RAW VALUE (dBuV) | CORRECTION FACTOR (dB/m) |
|-----|-------------|-------------------------|----------------|-------------|--------------------|----------------------|------------------|--------------------------|
| 1 | *5320.00 | 118.3 PK | | | 1.88 V | 351 | 78.6 | 39.7 |
| 2 | *5320.00 | 107.6 AV | | | 1.88 V | 351 | 67.9 | 39.7 |
| 3 | 5350.00 | 57.8 PK | 74.0 | -16.2 | 1.70 V | 350 | 53.9 | 3.9 |
| 4 | 5350.00 | 44.9 AV | 54.0 | -9.1 | 1.70 V | 350 | 41.0 | 3.9 |
| 5 | 10640.00 | 59.1 PK | 74.0 | -14.9 | 1.75 V | 339 | 41.8 | 17.3 |
| 6 | 10640.00 | 45.0 AV | 54.0 | -9.0 | 1.75 V | 339 | 27.7 | 17.3 |

Remarks:

1. Emission Level(dBuV/m) = Raw Value(dBuV) + Correction Factor(dB/m)
2. Correction Factor(dB/m) = Antenna Factor(dB/m) + Cable Factor(dB) – Pre-Amplifier Factor(dB)
3. The other emission levels were very low against the limit.
4. Margin value = Emission Level – Limit value
5. " * ": Fundamental frequency.
6. " # ": The radiated frequency is out of the restricted band.

| | | | |
|-----------------|----------------|----------------------|--------------|
| CHANNEL | TX Channel 100 | DETECTOR FUNCTION | Peak (PK) |
| FREQUENCY RANGE | 1GHz ~ 40GHz | | Average (AV) |

| ANTENNA POLARITY & TEST DISTANCE: HORIZONTAL AT 3 M | | | | | | | | |
|---|----------------|-------------------------------|-------------------|----------------|--------------------------|----------------------------|------------------------|--------------------------------|
| NO. | FREQ. (MHz) | EMISSION LEVEL (dBuV/m) | LIMIT (dBuV/m) | MARGIN (dB) | ANTENNA HEIGHT (m) | TABLE ANGLE (Degree) | RAW VALUE (dBuV) | CORRECTION FACTOR (dB/m) |
| 1 | 5460.00 | 56.2 PK | 74.0 | -17.8 | 1.77 H | 359 | 52.2 | 4.0 |
| 2 | 5460.00 | 44.0 AV | 54.0 | -10.0 | 1.77 H | 359 | 40.0 | 4.0 |
| 3 | #5470.00 | 57.8 PK | 74.0 | -16.2 | 1.87 H | 349 | 53.8 | 4.0 |
| 4 | #5470.00 | 44.8 AV | 54.0 | -9.2 | 1.87 H | 349 | 40.8 | 4.0 |
| 5 | *5500.00 | 117.2 PK | | | 1.56 H | 357 | 77.2 | 40.0 |
| 6 | *5500.00 | 106.5 AV | | | 1.56 H | 357 | 66.5 | 40.0 |
| 7 | 11000.00 | 61.2 PK | 74.0 | -12.8 | 1.96 H | 309 | 42.2 | 19.0 |
| 8 | 11000.00 | 48.0 AV | 54.0 | -6.0 | 1.96 H | 309 | 29.0 | 19.0 |

| ANTENNA POLARITY & TEST DISTANCE: VERTICAL AT 3 M | | | | | | | | |
|---|----------------|-------------------------------|-------------------|----------------|--------------------------|----------------------------|------------------------|--------------------------------|
| NO. | FREQ. (MHz) | EMISSION LEVEL (dBuV/m) | LIMIT (dBuV/m) | MARGIN (dB) | ANTENNA HEIGHT (m) | TABLE ANGLE (Degree) | RAW VALUE (dBuV) | CORRECTION FACTOR (dB/m) |
| 1 | 5460.00 | 56.1 PK | 74.0 | -17.9 | 1.99 V | 347 | 52.1 | 4.0 |
| 2 | 5460.00 | 43.8 AV | 54.0 | -10.2 | 1.99 V | 347 | 39.8 | 4.0 |
| 3 | #5470.00 | 58.4 PK | 74.0 | -15.6 | 1.99 V | 344 | 54.4 | 4.0 |
| 4 | #5470.00 | 44.6 AV | 54.0 | -9.4 | 1.99 V | 344 | 40.6 | 4.0 |
| 5 | *5500.00 | 118.5 PK | | | 1.83 V | 352 | 78.5 | 40.0 |
| 6 | *5500.00 | 107.7 AV | | | 1.83 V | 352 | 67.7 | 40.0 |
| 7 | 11000.00 | 60.4 PK | 74.0 | -13.6 | 1.63 V | 321 | 41.4 | 19.0 |
| 8 | 11000.00 | 47.0 AV | 54.0 | -7.0 | 1.63 V | 321 | 28.0 | 19.0 |

Remarks:

1. Emission Level(dBuV/m) = Raw Value(dBuV) + Correction Factor(dB/m)
2. Correction Factor(dB/m) = Antenna Factor(dB/m) + Cable Factor(dB) – Pre-Amplifier Factor(dB)
3. The other emission levels were very low against the limit.
4. Margin value = Emission Level – Limit value
5. " * ": Fundamental frequency.
6. " # ": The radiated frequency is out of the restricted band.

| | | | |
|-----------------|----------------|----------|--------------|
| CHANNEL | TX Channel 116 | DETECTOR | Peak (PK) |
| FREQUENCY RANGE | 1GHz ~ 40GHz | FUNCTION | Average (AV) |

ANTENNA POLARITY & TEST DISTANCE: HORIZONTAL AT 3 M

| NO. | FREQ. (MHz) | EMISSION LEVEL (dBuV/m) | LIMIT (dBuV/m) | MARGIN (dB) | ANTENNA HEIGHT (m) | TABLE ANGLE (Degree) | RAW VALUE (dBuV) | CORRECTION FACTOR (dB/m) |
|-----|-------------|-------------------------|----------------|-------------|--------------------|----------------------|------------------|--------------------------|
| 1 | *5580.00 | 119.5 PK | | | 1.65 H | 352 | 79.4 | 40.1 |
| 2 | *5580.00 | 108.1 AV | | | 1.65 H | 352 | 68.0 | 40.1 |
| 3 | 11160.00 | 60.2 PK | 74.0 | -13.8 | 1.82 H | 345 | 41.5 | 18.7 |
| 4 | 11160.00 | 46.5 AV | 54.0 | -7.5 | 1.82 H | 345 | 27.8 | 18.7 |

ANTENNA POLARITY & TEST DISTANCE: VERTICAL AT 3 M

| NO. | FREQ. (MHz) | EMISSION LEVEL (dBuV/m) | LIMIT (dBuV/m) | MARGIN (dB) | ANTENNA HEIGHT (m) | TABLE ANGLE (Degree) | RAW VALUE (dBuV) | CORRECTION FACTOR (dB/m) |
|-----|-------------|-------------------------|----------------|-------------|--------------------|----------------------|------------------|--------------------------|
| 1 | *5580.00 | 117.8 PK | | | 1.66 V | 345 | 77.7 | 40.1 |
| 2 | *5580.00 | 106.7 AV | | | 1.66 V | 345 | 66.6 | 40.1 |
| 3 | 11160.00 | 59.8 PK | 74.0 | -14.2 | 1.87 V | 333 | 41.1 | 18.7 |
| 4 | 11160.00 | 46.2 AV | 54.0 | -7.8 | 1.87 V | 333 | 27.5 | 18.7 |

Remarks:

1. Emission Level(dBuV/m) = Raw Value(dBuV) + Correction Factor(dB/m)
2. Correction Factor(dB/m) = Antenna Factor(dB/m) + Cable Factor(dB) – Pre-Amplifier Factor(dB)
3. The other emission levels were very low against the limit.
4. Margin value = Emission Level – Limit value
5. " * ": Fundamental frequency.
6. " # ": The radiated frequency is out of the restricted band.

| | | | |
|-----------------|----------------|-------------------|--------------|
| CHANNEL | TX Channel 140 | DETECTOR FUNCTION | Peak (PK) |
| FREQUENCY RANGE | 1GHz ~ 40GHz | | Average (AV) |

ANTENNA POLARITY & TEST DISTANCE: HORIZONTAL AT 3 M

| NO. | FREQ. (MHz) | EMISSION LEVEL (dBuV/m) | LIMIT (dBuV/m) | MARGIN (dB) | ANTENNA HEIGHT (m) | TABLE ANGLE (Degree) | RAW VALUE (dBuV) | CORRECTION FACTOR (dB/m) |
|-----|-------------|-------------------------|----------------|-------------|--------------------|----------------------|------------------|--------------------------|
| 1 | *5700.00 | 119.5 PK | | | 1.67 H | 348 | 79.2 | 40.3 |
| 2 | *5700.00 | 108.3 AV | | | 1.67 H | 348 | 68.0 | 40.3 |
| 3 | #5725.00 | 58.5 PK | 74.0 | -15.5 | 1.77 H | 352 | 54.0 | 4.5 |
| 4 | #5725.00 | 45.8 AV | 54.0 | -8.2 | 1.77 H | 352 | 41.3 | 4.5 |
| 5 | 11140.00 | 60.1 PK | 74.0 | -13.9 | 1.82 H | 334 | 41.5 | 18.6 |
| 6 | 11140.00 | 46.8 AV | 54.0 | -7.2 | 1.82 H | 334 | 28.2 | 18.6 |

ANTENNA POLARITY & TEST DISTANCE: VERTICAL AT 3 M

| NO. | FREQ. (MHz) | EMISSION LEVEL (dBuV/m) | LIMIT (dBuV/m) | MARGIN (dB) | ANTENNA HEIGHT (m) | TABLE ANGLE (Degree) | RAW VALUE (dBuV) | CORRECTION FACTOR (dB/m) |
|-----|-------------|-------------------------|----------------|-------------|--------------------|----------------------|------------------|--------------------------|
| 1 | *5700.00 | 117.4 PK | | | 1.75 V | 355 | 77.1 | 40.3 |
| 2 | *5700.00 | 106.5 AV | | | 1.75 V | 355 | 66.2 | 40.3 |
| 3 | #5725.00 | 59.3 PK | 74.0 | -14.7 | 1.93 V | 345 | 54.8 | 4.5 |
| 4 | #5725.00 | 46.1 AV | 54.0 | -7.9 | 1.93 V | 345 | 41.6 | 4.5 |
| 5 | 11400.00 | 61.9 PK | 74.0 | -12.1 | 1.81 V | 299 | 43.7 | 18.2 |
| 6 | 11400.00 | 48.6 AV | 54.0 | -5.4 | 1.81 V | 299 | 30.4 | 18.2 |

Remarks:

1. Emission Level(dBuV/m) = Raw Value(dBuV) + Correction Factor(dB/m)
2. Correction Factor(dB/m) = Antenna Factor(dB/m) + Cable Factor(dB) – Pre-Amplifier Factor(dB)
3. The other emission levels were very low against the limit.
4. Margin value = Emission Level – Limit value
5. " * ": Fundamental frequency.
6. " # ": The radiated frequency is out of the restricted band.

| | | | |
|-----------------|----------------|----------------------|--------------|
| CHANNEL | TX Channel 144 | DETECTOR FUNCTION | Peak (PK) |
| FREQUENCY RANGE | 1GHz ~ 40GHz | | Average (AV) |

ANTENNA POLARITY & TEST DISTANCE: HORIZONTAL AT 3 M

| NO. | FREQ. (MHz) | EMISSION LEVEL (dBuV/m) | LIMIT (dBuV/m) | MARGIN (dB) | ANTENNA HEIGHT (m) | TABLE ANGLE (Degree) | RAW VALUE (dBuV) | CORRECTION FACTOR (dB/m) |
|-----|----------------|-------------------------------|-------------------|----------------|--------------------------|----------------------------|------------------------|--------------------------------|
| 1 | #5470.00 | 56.4 PK | 74.0 | -17.6 | 1.48 H | 355 | 52.4 | 4.0 |
| 2 | #5470.00 | 45.4 AV | 54.0 | -8.6 | 1.48 H | 355 | 41.4 | 4.0 |
| 3 | *5720.00 | 118.9 PK | | | 1.51 H | 351 | 78.5 | 40.4 |
| 4 | *5720.00 | 108.6 AV | | | 1.51 H | 351 | 68.2 | 40.4 |
| 5 | #5850.00 | 55.9 PK | 74.0 | -18.1 | 1.50 H | 350 | 51.1 | 4.8 |
| 6 | #5850.00 | 45.6 AV | 54.0 | -8.4 | 1.50 H | 350 | 40.8 | 4.8 |
| 7 | 11440.00 | 61.0 PK | 74.0 | -13.0 | 1.96 H | 16 | 42.7 | 18.3 |
| 8 | 11440.00 | 47.9 AV | 54.0 | -6.1 | 1.96 H | 16 | 29.6 | 18.3 |

ANTENNA POLARITY & TEST DISTANCE: VERTICAL AT 3 M

| NO. | FREQ. (MHz) | EMISSION LEVEL (dBuV/m) | LIMIT (dBuV/m) | MARGIN (dB) | ANTENNA HEIGHT (m) | TABLE ANGLE (Degree) | RAW VALUE (dBuV) | CORRECTION FACTOR (dB/m) |
|-----|----------------|-------------------------------|-------------------|----------------|--------------------------|----------------------------|------------------------|--------------------------------|
| 1 | #5470.00 | 56.7 PK | 74.0 | -17.3 | 2.00 V | 359 | 52.7 | 4.0 |
| 2 | #5470.00 | 45.5 AV | 54.0 | -8.5 | 2.00 V | 359 | 41.5 | 4.0 |
| 3 | *5720.00 | 119.7 PK | | | 1.97 V | 349 | 79.3 | 40.4 |
| 4 | *5720.00 | 109.7 AV | | | 1.97 V | 349 | 69.3 | 40.4 |
| 5 | #5850.00 | 56.6 PK | 74.0 | -17.4 | 2.02 V | 333 | 51.8 | 4.8 |
| 6 | #5850.00 | 45.1 AV | 54.0 | -8.9 | 2.02 V | 333 | 40.3 | 4.8 |
| 7 | 11440.00 | 60.5 PK | 74.0 | -13.5 | 1.22 V | 288 | 42.2 | 18.3 |
| 8 | 11440.00 | 47.5 AV | 54.0 | -6.5 | 1.22 V | 288 | 29.2 | 18.3 |

Remarks:

1. Emission Level(dBuV/m) = Raw Value(dBuV) + Correction Factor(dB/m)
2. Correction Factor(dB/m) = Antenna Factor(dB/m) + Cable Factor(dB) – Pre-Amplifier Factor(dB)
3. The other emission levels were very low against the limit.
4. Margin value = Emission Level – Limit value
5. " * ": Fundamental frequency.
6. " # ": The radiated frequency is out of the restricted band.

802.11n (HT40)

| | | | |
|-----------------|---------------|----------------------|--------------|
| CHANNEL | TX Channel 54 | DETECTOR FUNCTION | Peak (PK) |
| FREQUENCY RANGE | 1GHz ~ 40GHz | | Average (AV) |

ANTENNA POLARITY & TEST DISTANCE: HORIZONTAL AT 3 M

| NO. | FREQ. (MHz) | EMISSION LEVEL (dBuV/m) | LIMIT (dBuV/m) | MARGIN (dB) | ANTENNA HEIGHT (m) | TABLE ANGLE (Degree) | RAW VALUE (dBuV) | CORRECTION FACTOR (dB/m) |
|-----|----------------|-------------------------------|-------------------|----------------|--------------------------|----------------------------|------------------------|--------------------------------|
| 1 | 5150.00 | 56.4 PK | 74.0 | -17.6 | 1.74 H | 353 | 52.8 | 3.6 |
| 2 | 5150.00 | 46.6 AV | 54.0 | -7.4 | 1.74 H | 353 | 43.0 | 3.6 |
| 3 | *5270.00 | 116.2 PK | | | 1.72 H | 350 | 76.6 | 39.6 |
| 4 | *5270.00 | 105.4 AV | | | 1.72 H | 350 | 65.8 | 39.6 |
| 5 | #10540.00 | 58.7 PK | 74.0 | -15.3 | 1.89 H | 313 | 41.6 | 17.1 |
| 6 | #10540.00 | 45.5 AV | 54.0 | -8.5 | 1.89 H | 313 | 28.4 | 17.1 |

ANTENNA POLARITY & TEST DISTANCE: VERTICAL AT 3 M

| NO. | FREQ. (MHz) | EMISSION LEVEL (dBuV/m) | LIMIT (dBuV/m) | MARGIN (dB) | ANTENNA HEIGHT (m) | TABLE ANGLE (Degree) | RAW VALUE (dBuV) | CORRECTION FACTOR (dB/m) |
|-----|----------------|-------------------------------|-------------------|----------------|--------------------------|----------------------------|------------------------|--------------------------------|
| 1 | 5150.00 | 56.3 PK | 74.0 | -17.7 | 1.77 V | 341 | 52.7 | 3.6 |
| 2 | 5150.00 | 43.6 AV | 54.0 | -10.4 | 1.77 V | 341 | 40.0 | 3.6 |
| 3 | *5270.00 | 114.5 PK | | | 1.64 V | 346 | 74.9 | 39.6 |
| 4 | *5270.00 | 104.2 AV | | | 1.64 V | 346 | 64.6 | 39.6 |
| 5 | #10540.00 | 58.7 PK | 74.0 | -15.3 | 1.51 V | 293 | 41.6 | 17.1 |
| 6 | #10540.00 | 45.6 AV | 54.0 | -8.4 | 1.51 V | 293 | 28.5 | 17.1 |

Remarks:

1. Emission Level(dBuV/m) = Raw Value(dBuV) + Correction Factor(dB/m)
2. Correction Factor(dB/m) = Antenna Factor(dB/m) + Cable Factor(dB) – Pre-Amplifier Factor(dB)
3. The other emission levels were very low against the limit.
4. Margin value = Emission Level – Limit value
5. " * ": Fundamental frequency.
6. " # ": The radiated frequency is out of the restricted band.

| | | | |
|-----------------|---------------|-------------------|--------------|
| CHANNEL | TX Channel 62 | DETECTOR FUNCTION | Peak (PK) |
| FREQUENCY RANGE | 1GHz ~ 40GHz | | Average (AV) |

ANTENNA POLARITY & TEST DISTANCE: HORIZONTAL AT 3 M

| NO. | FREQ. (MHz) | EMISSION LEVEL (dBuV/m) | LIMIT (dBuV/m) | MARGIN (dB) | ANTENNA HEIGHT (m) | TABLE ANGLE (Degree) | RAW VALUE (dBuV) | CORRECTION FACTOR (dB/m) |
|-----|-------------|-------------------------|----------------|-------------|--------------------|----------------------|------------------|--------------------------|
| 1 | *5310.00 | 116.4 PK | | | 1.72 H | 352 | 76.8 | 39.6 |
| 2 | *5310.00 | 105.6 AV | | | 1.72 H | 352 | 66.0 | 39.6 |
| 3 | 5350.00 | 66.1 PK | 74.0 | -7.9 | 1.86 H | 339 | 62.2 | 3.9 |
| 4 | 5350.00 | 45.5 AV | 54.0 | -8.5 | 1.86 H | 339 | 41.6 | 3.9 |
| 5 | 10620.00 | 58.5 PK | 74.0 | -15.5 | 1.93 H | 317 | 41.2 | 17.3 |
| 6 | 10620.00 | 45.0 AV | 54.0 | -9.0 | 1.93 H | 317 | 27.7 | 17.3 |

ANTENNA POLARITY & TEST DISTANCE: VERTICAL AT 3 M

| NO. | FREQ. (MHz) | EMISSION LEVEL (dBuV/m) | LIMIT (dBuV/m) | MARGIN (dB) | ANTENNA HEIGHT (m) | TABLE ANGLE (Degree) | RAW VALUE (dBuV) | CORRECTION FACTOR (dB/m) |
|-----|-------------|-------------------------|----------------|-------------|--------------------|----------------------|------------------|--------------------------|
| 1 | *5310.00 | 114.9 PK | | | 1.55 V | 346 | 75.3 | 39.6 |
| 2 | *5310.00 | 104.5 AV | | | 1.55 V | 346 | 64.9 | 39.6 |
| 3 | 5350.00 | 57.5 PK | 74.0 | -16.5 | 1.51 V | 346 | 53.6 | 3.9 |
| 4 | 5350.00 | 45.9 AV | 54.0 | -8.1 | 1.51 V | 346 | 42.0 | 3.9 |
| 5 | 10620.00 | 58.6 PK | 74.0 | -15.4 | 1.77 V | 336 | 41.3 | 17.3 |
| 6 | 10620.00 | 45.0 AV | 54.0 | -9.0 | 1.77 V | 336 | 27.7 | 17.3 |

Remarks:

1. Emission Level(dBuV/m) = Raw Value(dBuV) + Correction Factor(dB/m)
2. Correction Factor(dB/m) = Antenna Factor(dB/m) + Cable Factor(dB) – Pre-Amplifier Factor(dB)
3. The other emission levels were very low against the limit.
4. Margin value = Emission Level – Limit value
5. " * ": Fundamental frequency.
6. " # ": The radiated frequency is out of the restricted band.

| | | | |
|-----------------|----------------|----------------------|--------------|
| CHANNEL | TX Channel 102 | DETECTOR FUNCTION | Peak (PK) |
| FREQUENCY RANGE | 1GHz ~ 40GHz | | Average (AV) |

ANTENNA POLARITY & TEST DISTANCE: HORIZONTAL AT 3 M

| NO. | FREQ. (MHz) | EMISSION LEVEL (dBuV/m) | LIMIT (dBuV/m) | MARGIN (dB) | ANTENNA HEIGHT (m) | TABLE ANGLE (Degree) | RAW VALUE (dBuV) | CORRECTION FACTOR (dB/m) |
|-----|----------------|-------------------------------|-------------------|----------------|--------------------------|----------------------------|------------------------|--------------------------------|
| 1 | 5460.00 | 61.1 PK | 74.0 | -12.9 | 1.60 H | 350 | 57.1 | 4.0 |
| 2 | 5460.00 | 48.4 AV | 54.0 | -5.6 | 1.60 H | 350 | 44.4 | 4.0 |
| 3 | #5470.00 | 66.2 PK | 74.0 | -7.8 | 1.70 H | 353 | 62.2 | 4.0 |
| 4 | #5470.00 | 50.4 AV | 54.0 | -3.6 | 1.70 H | 353 | 46.4 | 4.0 |
| 5 | *5510.00 | 116.2 PK | | | 1.74 H | 352 | 76.2 | 40.0 |
| 6 | *5510.00 | 105.4 AV | | | 1.74 H | 352 | 65.4 | 40.0 |
| 7 | 11020.00 | 61.7 PK | 74.0 | -12.3 | 2.02 H | 25 | 42.8 | 18.9 |
| 8 | 11020.00 | 48.8 AV | 54.0 | -5.2 | 2.02 H | 25 | 29.9 | 18.9 |

ANTENNA POLARITY & TEST DISTANCE: VERTICAL AT 3 M

| NO. | FREQ. (MHz) | EMISSION LEVEL (dBuV/m) | LIMIT (dBuV/m) | MARGIN (dB) | ANTENNA HEIGHT (m) | TABLE ANGLE (Degree) | RAW VALUE (dBuV) | CORRECTION FACTOR (dB/m) |
|-----|----------------|-------------------------------|-------------------|----------------|--------------------------|----------------------------|------------------------|--------------------------------|
| 1 | 5460.00 | 57.8 PK | 74.0 | -16.2 | 1.50 V | 352 | 53.8 | 4.0 |
| 2 | 5460.00 | 46.5 AV | 54.0 | -7.5 | 1.50 V | 352 | 42.5 | 4.0 |
| 3 | #5470.00 | 62.5 PK | 74.0 | -11.5 | 1.92 V | 349 | 58.5 | 4.0 |
| 4 | #5470.00 | 50.4 AV | 54.0 | -3.6 | 1.92 V | 349 | 46.4 | 4.0 |
| 5 | *5510.00 | 114.3 PK | | | 1.57 V | 349 | 74.3 | 40.0 |
| 6 | *5510.00 | 104.1 AV | | | 1.57 V | 349 | 64.1 | 40.0 |
| 7 | 11020.00 | 61.2 PK | 74.0 | -12.8 | 2.48 V | 281 | 42.3 | 18.9 |
| 8 | 11020.00 | 48.4 AV | 54.0 | -5.6 | 2.48 V | 281 | 29.5 | 18.9 |

Remarks:

1. Emission Level(dBuV/m) = Raw Value(dBuV) + Correction Factor(dB/m)
2. Correction Factor(dB/m) = Antenna Factor(dB/m) + Cable Factor(dB) – Pre-Amplifier Factor(dB)
3. The other emission levels were very low against the limit.
4. Margin value = Emission Level – Limit value
5. " * ": Fundamental frequency.
6. " # ": The radiated frequency is out of the restricted band.

| | | | |
|-----------------|----------------|-------------------|--------------|
| CHANNEL | TX Channel 110 | DETECTOR FUNCTION | Peak (PK) |
| FREQUENCY RANGE | 1GHz ~ 40GHz | | Average (AV) |

ANTENNA POLARITY & TEST DISTANCE: HORIZONTAL AT 3 M

| NO. | FREQ. (MHz) | EMISSION LEVEL (dBuV/m) | LIMIT (dBuV/m) | MARGIN (dB) | ANTENNA HEIGHT (m) | TABLE ANGLE (Degree) | RAW VALUE (dBuV) | CORRECTION FACTOR (dB/m) |
|-----|-------------|-------------------------|----------------|-------------|--------------------|----------------------|------------------|--------------------------|
| 1 | *5550.00 | 115.5 PK | | | 1.75 H | 352 | 75.5 | 40.0 |
| 2 | *5550.00 | 105.8 AV | | | 1.75 H | 352 | 65.8 | 40.0 |
| 3 | 11100.00 | 61.4 PK | 74.0 | -12.6 | 1.99 H | 5 | 42.9 | 18.5 |
| 4 | 11100.00 | 48.6 AV | 54.0 | -5.4 | 1.99 H | 5 | 30.1 | 18.5 |

ANTENNA POLARITY & TEST DISTANCE: VERTICAL AT 3 M

| NO. | FREQ. (MHz) | EMISSION LEVEL (dBuV/m) | LIMIT (dBuV/m) | MARGIN (dB) | ANTENNA HEIGHT (m) | TABLE ANGLE (Degree) | RAW VALUE (dBuV) | CORRECTION FACTOR (dB/m) |
|-----|-------------|-------------------------|----------------|-------------|--------------------|----------------------|------------------|--------------------------|
| 1 | *5550.00 | 114.5 PK | | | 1.59 V | 347 | 74.5 | 40.0 |
| 2 | *5550.00 | 104.4 AV | | | 1.59 V | 347 | 64.4 | 40.0 |
| 3 | 11100.00 | 60.7 PK | 74.0 | -13.3 | 1.70 V | 266 | 42.2 | 18.5 |
| 4 | 11100.00 | 47.8 AV | 54.0 | -6.2 | 1.70 V | 266 | 29.3 | 18.5 |

Remarks:

1. Emission Level(dBuV/m) = Raw Value(dBuV) + Correction Factor(dB/m)
2. Correction Factor(dB/m) = Antenna Factor(dB/m) + Cable Factor(dB) – Pre-Amplifier Factor(dB)
3. The other emission levels were very low against the limit.
4. Margin value = Emission Level – Limit value
5. " * ": Fundamental frequency.
6. " # ": The radiated frequency is out of the restricted band.

| | | | |
|-----------------|----------------|-------------------|--------------|
| CHANNEL | TX Channel 134 | DETECTOR FUNCTION | Peak (PK) |
| FREQUENCY RANGE | 1GHz ~ 40GHz | | Average (AV) |

ANTENNA POLARITY & TEST DISTANCE: HORIZONTAL AT 3 M

| NO. | FREQ. (MHz) | EMISSION LEVEL (dBuV/m) | LIMIT (dBuV/m) | MARGIN (dB) | ANTENNA HEIGHT (m) | TABLE ANGLE (Degree) | RAW VALUE (dBuV) | CORRECTION FACTOR (dB/m) |
|-----|-------------|-------------------------|----------------|-------------|--------------------|----------------------|------------------|--------------------------|
| 1 | *5670.00 | 115.4 PK | | | 1.75 H | 350 | 75.1 | 40.3 |
| 2 | *5670.00 | 105.0 AV | | | 1.75 H | 350 | 64.7 | 40.3 |
| 3 | #5725.00 | 63.8 PK | 74.0 | -10.2 | 1.80 H | 344 | 59.3 | 4.5 |
| 4 | #5725.00 | 46.3 AV | 54.0 | -7.7 | 1.80 H | 344 | 41.8 | 4.5 |
| 5 | 11340.00 | 60.7 PK | 74.0 | -13.3 | 2.03 H | 350 | 42.3 | 18.4 |
| 6 | 11340.00 | 47.7 AV | 54.0 | -6.3 | 2.03 H | 350 | 29.3 | 18.4 |

ANTENNA POLARITY & TEST DISTANCE: VERTICAL AT 3 M

| NO. | FREQ. (MHz) | EMISSION LEVEL (dBuV/m) | LIMIT (dBuV/m) | MARGIN (dB) | ANTENNA HEIGHT (m) | TABLE ANGLE (Degree) | RAW VALUE (dBuV) | CORRECTION FACTOR (dB/m) |
|-----|-------------|-------------------------|----------------|-------------|--------------------|----------------------|------------------|--------------------------|
| 1 | *5670.00 | 114.5 PK | | | 1.57 V | 348 | 74.2 | 40.3 |
| 2 | *5670.00 | 104.5 AV | | | 1.57 V | 348 | 64.2 | 40.3 |
| 3 | #5725.00 | 56.2 PK | 74.0 | -17.8 | 1.60 V | 355 | 51.7 | 4.5 |
| 4 | #5725.00 | 45.0 AV | 54.0 | -9.0 | 1.60 V | 355 | 40.5 | 4.5 |
| 5 | 11340.00 | 60.5 PK | 74.0 | -13.5 | 1.89 V | 290 | 42.1 | 18.4 |
| 6 | 11340.00 | 47.4 AV | 54.0 | -6.6 | 1.89 V | 290 | 29.0 | 18.4 |

Remarks:

1. Emission Level(dBuV/m) = Raw Value(dBuV) + Correction Factor(dB/m)
2. Correction Factor(dB/m) = Antenna Factor(dB/m) + Cable Factor(dB) – Pre-Amplifier Factor(dB)
3. The other emission levels were very low against the limit.
4. Margin value = Emission Level – Limit value
5. " * ": Fundamental frequency.
6. " # ": The radiated frequency is out of the restricted band.

| | | | |
|-----------------|----------------|----------------------|--------------|
| CHANNEL | TX Channel 142 | DETECTOR FUNCTION | Peak (PK) |
| FREQUENCY RANGE | 1GHz ~ 40GHz | | Average (AV) |

| ANTENNA POLARITY & TEST DISTANCE: HORIZONTAL AT 3 M | | | | | | | | |
|---|----------------|-------------------------------|-------------------|----------------|--------------------------|----------------------------|------------------------|--------------------------------|
| NO. | FREQ. (MHz) | EMISSION LEVEL (dBuV/m) | LIMIT (dBuV/m) | MARGIN (dB) | ANTENNA HEIGHT (m) | TABLE ANGLE (Degree) | RAW VALUE (dBuV) | CORRECTION FACTOR (dB/m) |
| 1 | #5470.00 | 57.0 PK | 74.0 | -17.0 | 1.51 H | 311 | 53.0 | 4.0 |
| 2 | #5470.00 | 45.9 AV | 54.0 | -8.1 | 1.51 H | 311 | 41.9 | 4.0 |
| 3 | *5710.00 | 114.5 PK | | | 1.48 H | 349 | 74.1 | 40.4 |
| 4 | *5710.00 | 104.8 AV | | | 1.48 H | 349 | 64.4 | 40.4 |
| 5 | #5850.00 | 56.4 PK | 74.0 | -17.6 | 1.55 H | 334 | 51.6 | 4.8 |
| 6 | #5850.00 | 45.6 AV | 54.0 | -8.4 | 1.55 H | 334 | 40.8 | 4.8 |
| 7 | 11420.00 | 60.0 PK | 74.0 | -14.0 | 1.98 H | 24 | 41.8 | 18.2 |
| 8 | 11420.00 | 47.1 AV | 54.0 | -6.9 | 1.98 H | 24 | 28.9 | 18.2 |

| ANTENNA POLARITY & TEST DISTANCE: VERTICAL AT 3 M | | | | | | | | |
|---|----------------|-------------------------------|-------------------|----------------|--------------------------|----------------------------|------------------------|--------------------------------|
| NO. | FREQ. (MHz) | EMISSION LEVEL (dBuV/m) | LIMIT (dBuV/m) | MARGIN (dB) | ANTENNA HEIGHT (m) | TABLE ANGLE (Degree) | RAW VALUE (dBuV) | CORRECTION FACTOR (dB/m) |
| 1 | #5470.00 | 56.6 PK | 74.0 | -17.4 | 1.99 V | 358 | 52.6 | 4.0 |
| 2 | #5470.00 | 45.7 AV | 54.0 | -8.3 | 1.99 V | 358 | 41.7 | 4.0 |
| 3 | *5710.00 | 115.4 PK | | | 1.99 V | 347 | 75.0 | 40.4 |
| 4 | *5710.00 | 105.8 AV | | | 1.99 V | 347 | 65.4 | 40.4 |
| 5 | #5850.00 | 56.6 PK | 74.0 | -17.4 | 2.00 V | 350 | 51.8 | 4.8 |
| 6 | #5850.00 | 45.4 AV | 54.0 | -8.6 | 2.00 V | 350 | 40.6 | 4.8 |
| 7 | 11420.00 | 59.9 PK | 74.0 | -14.1 | 1.30 V | 289 | 41.7 | 18.2 |
| 8 | 11420.00 | 47.1 AV | 54.0 | -6.9 | 1.30 V | 289 | 28.9 | 18.2 |

Remarks:

1. Emission Level(dBuV/m) = Raw Value(dBuV) + Correction Factor(dB/m)
2. Correction Factor(dB/m) = Antenna Factor(dB/m) + Cable Factor(dB) – Pre-Amplifier Factor(dB)
3. The other emission levels were very low against the limit.
4. Margin value = Emission Level – Limit value
5. " * ": Fundamental frequency.
6. " # ": The radiated frequency is out of the restricted band.

802.11ac (VHT80)

| | | | |
|-----------------|---------------|----------------------|--------------|
| CHANNEL | TX Channel 58 | DETECTOR FUNCTION | Peak (PK) |
| FREQUENCY RANGE | 1GHz ~ 40GHz | | Average (AV) |

| ANTENNA POLARITY & TEST DISTANCE: HORIZONTAL AT 3 M | | | | | | | | |
|---|----------------|-------------------------------|-------------------|----------------|--------------------------|----------------------------|------------------------|--------------------------------|
| NO. | FREQ. (MHz) | EMISSION LEVEL (dBuV/m) | LIMIT (dBuV/m) | MARGIN (dB) | ANTENNA HEIGHT (m) | TABLE ANGLE (Degree) | RAW VALUE (dBuV) | CORRECTION FACTOR (dB/m) |
| 1 | 5150.00 | 57.8 PK | 74.0 | -16.2 | 1.74 H | 341 | 54.2 | 3.6 |
| 2 | 5150.00 | 43.3 AV | 54.0 | -10.7 | 1.74 H | 341 | 39.7 | 3.6 |
| 3 | *5290.00 | 112.6 PK | | | 1.69 H | 352 | 73.0 | 39.6 |
| 4 | *5290.00 | 102.3 AV | | | 1.69 H | 352 | 62.7 | 39.6 |
| 5 | 5350.00 | 70.3 PK | 74.0 | -3.7 | 1.65 H | 355 | 66.4 | 3.9 |
| 6 | 5350.00 | 52.2 AV | 54.0 | -1.8 | 1.65 H | 355 | 48.3 | 3.9 |
| 7 | #10580.00 | 58.6 PK | 74.0 | -15.4 | 1.91 H | 314 | 41.4 | 17.2 |
| 8 | #10580.00 | 45.7 AV | 54.0 | -8.3 | 1.91 H | 314 | 28.5 | 17.2 |
| ANTENNA POLARITY & TEST DISTANCE: VERTICAL AT 3 M | | | | | | | | |
| NO. | FREQ. (MHz) | EMISSION LEVEL (dBuV/m) | LIMIT (dBuV/m) | MARGIN (dB) | ANTENNA HEIGHT (m) | TABLE ANGLE (Degree) | RAW VALUE (dBuV) | CORRECTION FACTOR (dB/m) |
| 1 | 5150.00 | 56.6 PK | 74.0 | -17.4 | 1.73 V | 354 | 53.0 | 3.6 |
| 2 | 5150.00 | 43.8 AV | 54.0 | -10.2 | 1.73 V | 354 | 40.2 | 3.6 |
| 3 | *5290.00 | 110.0 PK | | | 1.68 V | 343 | 70.4 | 39.6 |
| 4 | *5290.00 | 100.0 AV | | | 1.68 V | 343 | 60.4 | 39.6 |
| 5 | 5350.00 | 70.7 PK | 74.0 | -3.3 | 1.55 V | 352 | 66.8 | 3.9 |
| 6 | 5350.00 | 50.4 AV | 54.0 | -3.6 | 1.55 V | 352 | 46.5 | 3.9 |
| 7 | #10580.00 | 59.5 PK | 74.0 | -14.5 | 1.87 V | 322 | 42.3 | 17.2 |
| 8 | #10580.00 | 45.9 AV | 54.0 | -8.1 | 1.87 V | 322 | 28.7 | 17.2 |

Remarks:

1. Emission Level(dBuV/m) = Raw Value(dBuV) + Correction Factor(dB/m)
2. Correction Factor(dB/m) = Antenna Factor(dB/m) + Cable Factor(dB) – Pre-Amplifier Factor(dB)
3. The other emission levels were very low against the limit.
4. Margin value = Emission Level – Limit value
5. " * ": Fundamental frequency.
6. " # ": The radiated frequency is out of the restricted band.

| | | | |
|-----------------|----------------|----------------------|--------------|
| CHANNEL | TX Channel 106 | DETECTOR FUNCTION | Peak (PK) |
| FREQUENCY RANGE | 1GHz ~ 40GHz | | Average (AV) |

ANTENNA POLARITY & TEST DISTANCE: HORIZONTAL AT 3 M

| NO. | FREQ. (MHz) | EMISSION LEVEL (dBuV/m) | LIMIT (dBuV/m) | MARGIN (dB) | ANTENNA HEIGHT (m) | TABLE ANGLE (Degree) | RAW VALUE (dBuV) | CORRECTION FACTOR (dB/m) |
|-----|----------------|-------------------------------|-------------------|----------------|--------------------------|----------------------------|------------------------|--------------------------------|
| 1 | 5460.00 | 64.4 PK | 74.0 | -9.6 | 1.80 H | 354 | 60.4 | 4.0 |
| 2 | 5460.00 | 50.0 AV | 54.0 | -4.0 | 1.80 H | 354 | 46.0 | 4.0 |
| 3 | #5470.00 | 68.6 PK | 74.0 | -5.4 | 1.79 H | 349 | 64.6 | 4.0 |
| 4 | #5470.00 | 52.3 AV | 54.0 | -1.7 | 1.79 H | 349 | 48.3 | 4.0 |
| 5 | *5530.00 | 111.6 PK | | | 1.70 H | 353 | 71.6 | 40.0 |
| 6 | *5530.00 | 101.5 AV | | | 1.70 H | 353 | 61.5 | 40.0 |
| 7 | #5725.00 | 54.6 PK | 74.0 | -19.4 | 1.90 H | 352 | 50.1 | 4.5 |
| 8 | #5725.00 | 44.3 AV | 54.0 | -9.7 | 1.90 H | 352 | 39.8 | 4.5 |
| 9 | 11340.00 | 60.1 PK | 74.0 | -13.9 | 2.98 H | 29 | 41.7 | 18.4 |
| 10 | 11340.00 | 47.1 AV | 54.0 | -6.9 | 2.98 H | 29 | 28.7 | 18.4 |

ANTENNA POLARITY & TEST DISTANCE: VERTICAL AT 3 M

| NO. | FREQ. (MHz) | EMISSION LEVEL (dBuV/m) | LIMIT (dBuV/m) | MARGIN (dB) | ANTENNA HEIGHT (m) | TABLE ANGLE (Degree) | RAW VALUE (dBuV) | CORRECTION FACTOR (dB/m) |
|-----|----------------|-------------------------------|-------------------|----------------|--------------------------|----------------------------|------------------------|--------------------------------|
| 1 | 5460.00 | 63.8 PK | 74.0 | -10.2 | 1.69 V | 348 | 59.8 | 4.0 |
| 2 | 5460.00 | 51.8 AV | 54.0 | -2.2 | 1.69 V | 348 | 47.8 | 4.0 |
| 3 | #5470.00 | 63.3 PK | 74.0 | -10.7 | 1.93 V | 353 | 59.3 | 4.0 |
| 4 | #5470.00 | 50.7 AV | 54.0 | -3.3 | 1.93 V | 353 | 46.7 | 4.0 |
| 5 | *5530.00 | 109.7 PK | | | 1.61 V | 349 | 69.7 | 40.0 |
| 6 | *5530.00 | 99.9 AV | | | 1.61 V | 349 | 59.9 | 40.0 |
| 7 | #5725.00 | 57.8 PK | 74.0 | -16.2 | 1.61 V | 350 | 53.3 | 4.5 |
| 8 | #5725.00 | 46.2 AV | 54.0 | -7.8 | 1.61 V | 350 | 41.7 | 4.5 |
| 9 | 11340.00 | 59.8 PK | 74.0 | -14.2 | 1.88 V | 279 | 41.4 | 18.4 |
| 10 | 11340.00 | 46.9 AV | 54.0 | -7.1 | 1.88 V | 279 | 28.5 | 18.4 |

Remarks:

1. Emission Level(dBuV/m) = Raw Value(dBuV) + Correction Factor(dB/m)
2. Correction Factor(dB/m) = Antenna Factor(dB/m) + Cable Factor(dB) – Pre-Amplifier Factor(dB)
3. The other emission levels were very low against the limit.
4. Margin value = Emission Level – Limit value
5. " * ": Fundamental frequency.
6. " # ": The radiated frequency is out of the restricted band.

| | | | |
|-----------------|----------------|----------------------|--------------|
| CHANNEL | TX Channel 122 | DETECTOR FUNCTION | Peak (PK) |
| FREQUENCY RANGE | 1GHz ~ 40GHz | | Average (AV) |

ANTENNA POLARITY & TEST DISTANCE: HORIZONTAL AT 3 M

| NO. | FREQ. (MHz) | EMISSION LEVEL (dBuV/m) | LIMIT (dBuV/m) | MARGIN (dB) | ANTENNA HEIGHT (m) | TABLE ANGLE (Degree) | RAW VALUE (dBuV) | CORRECTION FACTOR (dB/m) |
|-----|----------------|-------------------------------|-------------------|----------------|--------------------------|----------------------------|------------------------|--------------------------------|
| 1 | 5460.00 | 54.8 PK | 74.0 | -19.2 | 1.60 H | 342 | 50.8 | 4.0 |
| 2 | 5460.00 | 44.0 AV | 54.0 | -10.0 | 1.60 H | 342 | 40.0 | 4.0 |
| 3 | #5470.00 | 56.5 PK | 74.0 | -17.5 | 1.56 H | 351 | 52.5 | 4.0 |
| 4 | #5470.00 | 45.1 AV | 54.0 | -8.9 | 1.56 H | 351 | 41.1 | 4.0 |
| 5 | *5610.00 | 110.4 PK | | | 1.77 H | 352 | 70.2 | 40.2 |
| 6 | *5610.00 | 100.5 AV | | | 1.77 H | 352 | 60.3 | 40.2 |
| 7 | #5725.00 | 59.5 PK | 74.0 | -14.5 | 1.53 H | 350 | 55.0 | 4.5 |
| 8 | #5725.00 | 48.7 AV | 54.0 | -5.3 | 1.53 H | 350 | 44.2 | 4.5 |
| 9 | 11220.00 | 60.7 PK | 74.0 | -13.3 | 2.11 H | 52 | 41.8 | 18.9 |
| 10 | 11220.00 | 47.5 AV | 54.0 | -6.5 | 2.11 H | 52 | 28.6 | 18.9 |

ANTENNA POLARITY & TEST DISTANCE: VERTICAL AT 3 M

| NO. | FREQ. (MHz) | EMISSION LEVEL (dBuV/m) | LIMIT (dBuV/m) | MARGIN (dB) | ANTENNA HEIGHT (m) | TABLE ANGLE (Degree) | RAW VALUE (dBuV) | CORRECTION FACTOR (dB/m) |
|-----|----------------|-------------------------------|-------------------|----------------|--------------------------|----------------------------|------------------------|--------------------------------|
| 1 | 5460.00 | 55.1 PK | 74.0 | -18.9 | 2.24 V | 360 | 51.1 | 4.0 |
| 2 | 5460.00 | 44.6 AV | 54.0 | -9.4 | 2.24 V | 360 | 40.6 | 4.0 |
| 3 | #5470.00 | 56.3 PK | 74.0 | -17.7 | 1.96 V | 305 | 52.3 | 4.0 |
| 4 | #5470.00 | 45.2 AV | 54.0 | -8.8 | 1.96 V | 305 | 41.2 | 4.0 |
| 5 | *5610.00 | 111.0 PK | | | 1.97 V | 349 | 70.8 | 40.2 |
| 6 | *5610.00 | 101.1 AV | | | 1.97 V | 349 | 60.9 | 40.2 |
| 7 | #5850.00 | 56.4 PK | 74.0 | -17.6 | 1.94 V | 202 | 51.6 | 4.8 |
| 8 | #5850.00 | 46.4 AV | 54.0 | -7.6 | 1.94 V | 202 | 41.6 | 4.8 |
| 9 | 11220.00 | 59.9 PK | 74.0 | -14.1 | 1.21 V | 276 | 41.0 | 18.9 |
| 10 | 11220.00 | 47.0 AV | 54.0 | -7.0 | 1.21 V | 276 | 28.1 | 18.9 |

Remarks:

1. Emission Level(dBuV/m) = Raw Value(dBuV) + Correction Factor(dB/m)
2. Correction Factor(dB/m) = Antenna Factor(dB/m) + Cable Factor(dB) – Pre-Amplifier Factor(dB)
3. The other emission levels were very low against the limit.
4. Margin value = Emission Level – Limit value
5. " * ": Fundamental frequency.
6. " # ": The radiated frequency is out of the restricted band.

| | | | |
|-----------------|----------------|----------------------|--------------|
| CHANNEL | TX Channel 138 | DETECTOR FUNCTION | Peak (PK) |
| FREQUENCY RANGE | 1GHz ~ 40GHz | | Average (AV) |

ANTENNA POLARITY & TEST DISTANCE: HORIZONTAL AT 3 M

| NO. | FREQ. (MHz) | EMISSION LEVEL (dBuV/m) | LIMIT (dBuV/m) | MARGIN (dB) | ANTENNA HEIGHT (m) | TABLE ANGLE (Degree) | RAW VALUE (dBuV) | CORRECTION FACTOR (dB/m) |
|-----|----------------|-------------------------------|-------------------|----------------|--------------------------|----------------------------|------------------------|--------------------------------|
| 1 | #5470.00 | 54.6 PK | 74.0 | -19.4 | 1.48 H | 349 | 50.6 | 4.0 |
| 2 | #5470.00 | 44.6 AV | 54.0 | -9.4 | 1.48 H | 349 | 40.6 | 4.0 |
| 3 | *5690.00 | 111.2 PK | | | 1.51 H | 351 | 70.9 | 40.3 |
| 4 | *5690.00 | 101.5 AV | | | 1.51 H | 351 | 61.2 | 40.3 |
| 5 | #5850.00 | 55.0 PK | 74.0 | -19.0 | 1.48 H | 340 | 50.2 | 4.8 |
| 6 | #5850.00 | 44.7 AV | 54.0 | -9.3 | 1.48 H | 340 | 39.9 | 4.8 |
| 7 | 11380.00 | 59.5 PK | 74.0 | -14.5 | 2.11 H | 27 | 41.2 | 18.3 |
| 8 | 11380.00 | 46.6 AV | 54.0 | -7.4 | 2.11 H | 27 | 28.3 | 18.3 |

ANTENNA POLARITY & TEST DISTANCE: VERTICAL AT 3 M

| NO. | FREQ. (MHz) | EMISSION LEVEL (dBuV/m) | LIMIT (dBuV/m) | MARGIN (dB) | ANTENNA HEIGHT (m) | TABLE ANGLE (Degree) | RAW VALUE (dBuV) | CORRECTION FACTOR (dB/m) |
|-----|----------------|-------------------------------|-------------------|----------------|--------------------------|----------------------------|------------------------|--------------------------------|
| 1 | #5470.00 | 56.9 PK | 74.0 | -17.1 | 1.99 V | 347 | 52.9 | 4.0 |
| 2 | #5470.00 | 45.9 AV | 54.0 | -8.1 | 1.99 V | 347 | 41.9 | 4.0 |
| 3 | *5690.00 | 111.5 PK | | | 1.94 V | 350 | 71.2 | 40.3 |
| 4 | *5690.00 | 101.7 AV | | | 1.94 V | 350 | 61.4 | 40.3 |
| 5 | #5850.00 | 56.0 PK | 74.0 | -18.0 | 1.96 V | 340 | 51.2 | 4.8 |
| 6 | #5850.00 | 45.7 AV | 54.0 | -8.3 | 1.96 V | 340 | 40.9 | 4.8 |
| 7 | 11380.00 | 59.7 PK | 74.0 | -14.3 | 1.25 V | 271 | 41.4 | 18.3 |
| 8 | 11380.00 | 46.9 AV | 54.0 | -7.1 | 1.25 V | 271 | 28.6 | 18.3 |

Remarks:

1. Emission Level(dBuV/m) = Raw Value(dBuV) + Correction Factor(dB/m)
2. Correction Factor(dB/m) = Antenna Factor(dB/m) + Cable Factor(dB) – Pre-Amplifier Factor(dB)
3. The other emission levels were very low against the limit.
4. Margin value = Emission Level – Limit value
5. " * ": Fundamental frequency.
6. " # ": The radiated frequency is out of the restricted band.

Mode B1

802.11a

| | | | |
|-----------------|---------------|----------------------|--------------|
| CHANNEL | TX Channel 52 | DETECTOR FUNCTION | Peak (PK) |
| FREQUENCY RANGE | 1GHz ~ 40GHz | | Average (AV) |

ANTENNA POLARITY & TEST DISTANCE: HORIZONTAL AT 3 M

| NO. | FREQ. (MHz) | EMISSION LEVEL (dBuV/m) | LIMIT (dBuV/m) | MARGIN (dB) | ANTENNA HEIGHT (m) | TABLE ANGLE (Degree) | RAW VALUE (dBuV) | CORRECTION FACTOR (dB/m) |
|-----|----------------|-------------------------------|-------------------|----------------|--------------------------|----------------------------|------------------------|--------------------------------|
| 1 | 5150.00 | 59.5 PK | 74.0 | -14.5 | 1.49 H | 171 | 55.9 | 3.6 |
| 2 | 5150.00 | 47.7 AV | 54.0 | -6.3 | 1.49 H | 171 | 44.1 | 3.6 |
| 3 | *5260.00 | 125.8 PK | | | 1.80 H | 171 | 86.2 | 39.6 |
| 4 | *5260.00 | 115.7 AV | | | 1.80 H | 171 | 76.1 | 39.6 |
| 5 | #10520.00 | 58.2 PK | 74.0 | -15.8 | 1.88 H | 203 | 41.2 | 17.0 |
| 6 | #10520.00 | 45.2 AV | 54.0 | -8.8 | 1.88 H | 203 | 28.2 | 17.0 |

ANTENNA POLARITY & TEST DISTANCE: VERTICAL AT 3 M

| NO. | FREQ. (MHz) | EMISSION LEVEL (dBuV/m) | LIMIT (dBuV/m) | MARGIN (dB) | ANTENNA HEIGHT (m) | TABLE ANGLE (Degree) | RAW VALUE (dBuV) | CORRECTION FACTOR (dB/m) |
|-----|----------------|-------------------------------|-------------------|----------------|--------------------------|----------------------------|------------------------|--------------------------------|
| 1 | 5150.00 | 54.7 PK | 74.0 | -19.3 | 1.99 V | 293 | 51.1 | 3.6 |
| 2 | 5150.00 | 42.0 AV | 54.0 | -12.0 | 1.99 V | 293 | 38.4 | 3.6 |
| 3 | *5260.00 | 105.4 PK | | | 2.36 V | 344 | 65.8 | 39.6 |
| 4 | *5260.00 | 94.2 AV | | | 2.36 V | 344 | 54.6 | 39.6 |
| 5 | #10520.00 | 58.0 PK | 74.0 | -16.0 | 2.11 V | 303 | 41.0 | 17.0 |
| 6 | #10520.00 | 45.3 AV | 54.0 | -8.7 | 2.11 V | 303 | 28.3 | 17.0 |

Remarks:

1. Emission Level(dBuV/m) = Raw Value(dBuV) + Correction Factor(dB/m)
2. Correction Factor(dB/m) = Antenna Factor(dB/m) + Cable Factor(dB) – Pre-Amplifier Factor(dB)
3. The other emission levels were very low against the limit.
4. Margin value = Emission Level – Limit value
5. " * ": Fundamental frequency.
6. " # ": The radiated frequency is out of the restricted band.

| | | | |
|-----------------|---------------|-------------------|--------------|
| CHANNEL | TX Channel 60 | DETECTOR FUNCTION | Peak (PK) |
| FREQUENCY RANGE | 1GHz ~ 40GHz | | Average (AV) |

ANTENNA POLARITY & TEST DISTANCE: HORIZONTAL AT 3 M

| NO. | FREQ. (MHz) | EMISSION LEVEL (dBuV/m) | LIMIT (dBuV/m) | MARGIN (dB) | ANTENNA HEIGHT (m) | TABLE ANGLE (Degree) | RAW VALUE (dBuV) | CORRECTION FACTOR (dB/m) |
|-----|-------------|-------------------------|----------------|-------------|--------------------|----------------------|------------------|--------------------------|
| 1 | *5300.00 | 125.0 PK | | | 1.82 H | 174 | 85.4 | 39.6 |
| 2 | *5300.00 | 114.8 AV | | | 1.82 H | 174 | 75.2 | 39.6 |
| 3 | 5350.00 | 60.1 PK | 74.0 | -13.9 | 1.80 H | 174 | 56.2 | 3.9 |
| 4 | 5350.00 | 48.4 AV | 54.0 | -5.6 | 1.80 H | 174 | 44.5 | 3.9 |
| 5 | 10600.00 | 59.1 PK | 74.0 | -14.9 | 1.99 H | 222 | 42.0 | 17.1 |
| 6 | 10600.00 | 45.5 AV | 54.0 | -8.5 | 1.99 H | 222 | 28.4 | 17.1 |

ANTENNA POLARITY & TEST DISTANCE: VERTICAL AT 3 M

| NO. | FREQ. (MHz) | EMISSION LEVEL (dBuV/m) | LIMIT (dBuV/m) | MARGIN (dB) | ANTENNA HEIGHT (m) | TABLE ANGLE (Degree) | RAW VALUE (dBuV) | CORRECTION FACTOR (dB/m) |
|-----|-------------|-------------------------|----------------|-------------|--------------------|----------------------|------------------|--------------------------|
| 1 | *5300.00 | 103.5 PK | | | 2.36 V | 303 | 63.9 | 39.6 |
| 2 | *5300.00 | 92.8 AV | | | 2.36 V | 303 | 53.2 | 39.6 |
| 3 | 5350.00 | 55.3 PK | 74.0 | -18.7 | 1.93 V | 324 | 51.4 | 3.9 |
| 4 | 5350.00 | 42.4 AV | 54.0 | -11.6 | 1.93 V | 324 | 38.5 | 3.9 |
| 5 | 10600.00 | 57.9 PK | 74.0 | -16.1 | 1.89 V | 256 | 40.8 | 17.1 |
| 6 | 10600.00 | 45.5 AV | 54.0 | -8.5 | 1.89 V | 256 | 28.4 | 17.1 |

Remarks:

1. Emission Level(dBuV/m) = Raw Value(dBuV) + Correction Factor(dB/m)
2. Correction Factor(dB/m) = Antenna Factor(dB/m) + Cable Factor(dB) – Pre-Amplifier Factor(dB)
3. The other emission levels were very low against the limit.
4. Margin value = Emission Level – Limit value
5. " * ": Fundamental frequency.
6. " # ": The radiated frequency is out of the restricted band.

| | | | |
|-----------------|---------------|-------------------|--------------|
| CHANNEL | TX Channel 64 | DETECTOR FUNCTION | Peak (PK) |
| FREQUENCY RANGE | 1GHz ~ 40GHz | | Average (AV) |

ANTENNA POLARITY & TEST DISTANCE: HORIZONTAL AT 3 M

| NO. | FREQ. (MHz) | EMISSION LEVEL (dBuV/m) | LIMIT (dBuV/m) | MARGIN (dB) | ANTENNA HEIGHT (m) | TABLE ANGLE (Degree) | RAW VALUE (dBuV) | CORRECTION FACTOR (dB/m) |
|-----|-------------|-------------------------|----------------|-------------|--------------------|----------------------|------------------|--------------------------|
| 1 | *5320.00 | 125.3 PK | | | 1.89 H | 172 | 85.6 | 39.7 |
| 2 | *5320.00 | 115.2 AV | | | 1.89 H | 172 | 75.5 | 39.7 |
| 3 | 5350.00 | 62.9 PK | 74.0 | -11.1 | 1.55 H | 172 | 59.0 | 3.9 |
| 4 | 5350.00 | 50.6 AV | 54.0 | -3.4 | 1.55 H | 172 | 46.7 | 3.9 |
| 5 | 10640.00 | 60.6 PK | 74.0 | -13.4 | 1.89 H | 245 | 43.3 | 17.3 |
| 6 | 10640.00 | 47.0 AV | 54.0 | -7.0 | 1.89 H | 245 | 29.7 | 17.3 |

ANTENNA POLARITY & TEST DISTANCE: VERTICAL AT 3 M

| NO. | FREQ. (MHz) | EMISSION LEVEL (dBuV/m) | LIMIT (dBuV/m) | MARGIN (dB) | ANTENNA HEIGHT (m) | TABLE ANGLE (Degree) | RAW VALUE (dBuV) | CORRECTION FACTOR (dB/m) |
|-----|-------------|-------------------------|----------------|-------------|--------------------|----------------------|------------------|--------------------------|
| 1 | *5320.00 | 103.8 PK | | | 2.62 V | 341 | 64.1 | 39.7 |
| 2 | *5320.00 | 93.4 AV | | | 2.62 V | 341 | 53.7 | 39.7 |
| 3 | 5350.00 | 55.3 PK | 74.0 | -18.7 | 2.31 V | 359 | 51.4 | 3.9 |
| 4 | 5350.00 | 42.4 AV | 54.0 | -11.6 | 2.31 V | 359 | 38.5 | 3.9 |
| 5 | 10640.00 | 59.4 PK | 74.0 | -14.6 | 1.93 V | 287 | 42.1 | 17.3 |
| 6 | 10640.00 | 45.6 AV | 54.0 | -8.4 | 1.93 V | 287 | 28.3 | 17.3 |

Remarks:

1. Emission Level(dBuV/m) = Raw Value(dBuV) + Correction Factor(dB/m)
2. Correction Factor(dB/m) = Antenna Factor(dB/m) + Cable Factor(dB) – Pre-Amplifier Factor(dB)
3. The other emission levels were very low against the limit.
4. Margin value = Emission Level – Limit value
5. " * ": Fundamental frequency.
6. " # ": The radiated frequency is out of the restricted band.

| | | | |
|-----------------|----------------|----------------------|--------------|
| CHANNEL | TX Channel 100 | DETECTOR FUNCTION | Peak (PK) |
| FREQUENCY RANGE | 1GHz ~ 40GHz | | Average (AV) |

ANTENNA POLARITY & TEST DISTANCE: HORIZONTAL AT 3 M

| NO. | FREQ. (MHz) | EMISSION LEVEL (dBuV/m) | LIMIT (dBuV/m) | MARGIN (dB) | ANTENNA HEIGHT (m) | TABLE ANGLE (Degree) | RAW VALUE (dBuV) | CORRECTION FACTOR (dB/m) |
|-----|----------------|-------------------------------|-------------------|----------------|--------------------------|----------------------------|------------------------|--------------------------------|
| 1 | 5460.00 | 61.5 PK | 74.0 | -12.5 | 1.74 H | 346 | 57.5 | 4.0 |
| 2 | 5460.00 | 49.6 AV | 54.0 | -4.4 | 1.74 H | 346 | 45.6 | 4.0 |
| 3 | #5470.00 | 65.4 PK | 74.0 | -8.6 | 1.70 H | 346 | 61.4 | 4.0 |
| 4 | #5470.00 | 52.5 AV | 54.0 | -1.5 | 1.70 H | 346 | 48.5 | 4.0 |
| 5 | *5500.00 | 124.4 PK | | | 1.84 H | 173 | 84.4 | 40.0 |
| 6 | *5500.00 | 114.7 AV | | | 1.84 H | 173 | 74.7 | 40.0 |
| 7 | 11000.00 | 65.0 PK | 74.0 | -9.0 | 1.20 H | 346 | 46.0 | 19.0 |
| 8 | 11000.00 | 52.3 AV | 54.0 | -1.7 | 1.20 H | 346 | 33.3 | 19.0 |

ANTENNA POLARITY & TEST DISTANCE: VERTICAL AT 3 M

| NO. | FREQ. (MHz) | EMISSION LEVEL (dBuV/m) | LIMIT (dBuV/m) | MARGIN (dB) | ANTENNA HEIGHT (m) | TABLE ANGLE (Degree) | RAW VALUE (dBuV) | CORRECTION FACTOR (dB/m) |
|-----|----------------|-------------------------------|-------------------|----------------|--------------------------|----------------------------|------------------------|--------------------------------|
| 1 | 5460.00 | 56.3 PK | 74.0 | -17.7 | 2.60 V | 251 | 52.3 | 4.0 |
| 2 | 5460.00 | 45.6 AV | 54.0 | -8.4 | 2.60 V | 251 | 41.6 | 4.0 |
| 3 | #5470.00 | 58.5 PK | 74.0 | -15.5 | 2.66 V | 270 | 54.5 | 4.0 |
| 4 | #5470.00 | 47.5 AV | 54.0 | -6.5 | 2.66 V | 270 | 43.5 | 4.0 |
| 5 | *5500.00 | 105.3 PK | | | 2.66 V | 264 | 65.3 | 40.0 |
| 6 | *5500.00 | 96.1 AV | | | 2.66 V | 264 | 56.1 | 40.0 |
| 7 | 11000.00 | 62.5 PK | 74.0 | -11.5 | 1.99 V | 183 | 43.5 | 19.0 |
| 8 | 11000.00 | 49.5 AV | 54.0 | -4.5 | 1.99 V | 183 | 30.5 | 19.0 |

Remarks:

1. Emission Level(dBuV/m) = Raw Value(dBuV) + Correction Factor(dB/m)
2. Correction Factor(dB/m) = Antenna Factor(dB/m) + Cable Factor(dB) – Pre-Amplifier Factor(dB)
3. The other emission levels were very low against the limit.
4. Margin value = Emission Level – Limit value
5. " * ": Fundamental frequency.
6. " # ": The radiated frequency is out of the restricted band.

| | | | |
|-----------------|----------------|----------|--------------|
| CHANNEL | TX Channel 116 | DETECTOR | Peak (PK) |
| FREQUENCY RANGE | 1GHz ~ 40GHz | FUNCTION | Average (AV) |

ANTENNA POLARITY & TEST DISTANCE: HORIZONTAL AT 3 M

| NO. | FREQ. (MHz) | EMISSION LEVEL (dBuV/m) | LIMIT (dBuV/m) | MARGIN (dB) | ANTENNA HEIGHT (m) | TABLE ANGLE (Degree) | RAW VALUE (dBuV) | CORRECTION FACTOR (dB/m) |
|-----|-------------|-------------------------|----------------|-------------|--------------------|----------------------|------------------|--------------------------|
| 1 | *5580.00 | 124.2 PK | | | 1.86 H | 173 | 84.1 | 40.1 |
| 2 | *5580.00 | 114.5 AV | | | 1.86 H | 173 | 74.4 | 40.1 |
| 3 | 11160.00 | 63.3 PK | 74.0 | -10.7 | 1.27 H | 349 | 44.6 | 18.7 |
| 4 | 11160.00 | 50.5 AV | 54.0 | -3.5 | 1.27 H | 349 | 31.8 | 18.7 |

ANTENNA POLARITY & TEST DISTANCE: VERTICAL AT 3 M

| NO. | FREQ. (MHz) | EMISSION LEVEL (dBuV/m) | LIMIT (dBuV/m) | MARGIN (dB) | ANTENNA HEIGHT (m) | TABLE ANGLE (Degree) | RAW VALUE (dBuV) | CORRECTION FACTOR (dB/m) |
|-----|-------------|-------------------------|----------------|-------------|--------------------|----------------------|------------------|--------------------------|
| 1 | *5580.00 | 105.6 PK | | | 2.71 V | 263 | 65.5 | 40.1 |
| 2 | *5580.00 | 95.7 AV | | | 2.71 V | 263 | 55.6 | 40.1 |
| 3 | 11160.00 | 62.5 PK | 74.0 | -11.5 | 2.11 V | 192 | 43.8 | 18.7 |
| 4 | 11160.00 | 49.1 AV | 54.0 | -4.9 | 2.11 V | 192 | 30.4 | 18.7 |

Remarks:

1. Emission Level(dBuV/m) = Raw Value(dBuV) + Correction Factor(dB/m)
2. Correction Factor(dB/m) = Antenna Factor(dB/m) + Cable Factor(dB) – Pre-Amplifier Factor(dB)
3. The other emission levels were very low against the limit.
4. Margin value = Emission Level – Limit value
5. " * ": Fundamental frequency.
6. " # ": The radiated frequency is out of the restricted band.

| | | | |
|-----------------|----------------|-------------------|--------------|
| CHANNEL | TX Channel 140 | DETECTOR FUNCTION | Peak (PK) |
| FREQUENCY RANGE | 1GHz ~ 40GHz | | Average (AV) |

ANTENNA POLARITY & TEST DISTANCE: HORIZONTAL AT 3 M

| NO. | FREQ. (MHz) | EMISSION LEVEL (dBuV/m) | LIMIT (dBuV/m) | MARGIN (dB) | ANTENNA HEIGHT (m) | TABLE ANGLE (Degree) | RAW VALUE (dBuV) | CORRECTION FACTOR (dB/m) |
|-----|-------------|-------------------------|----------------|-------------|--------------------|----------------------|------------------|--------------------------|
| 1 | *5700.00 | 124.7 PK | | | 1.76 H | 347 | 84.4 | 40.3 |
| 2 | *5700.00 | 114.6 AV | | | 1.76 H | 347 | 74.3 | 40.3 |
| 3 | #5725.00 | 68.3 PK | 74.0 | -5.7 | 1.75 H | 345 | 63.8 | 4.5 |
| 4 | #5725.00 | 52.7 AV | 54.0 | -1.3 | 1.75 H | 345 | 48.2 | 4.5 |
| 5 | 11400.00 | 62.6 PK | 74.0 | -11.4 | 1.32 H | 345 | 44.4 | 18.2 |
| 6 | 11400.00 | 49.9 AV | 54.0 | -4.1 | 1.32 H | 345 | 31.7 | 18.2 |

ANTENNA POLARITY & TEST DISTANCE: VERTICAL AT 3 M

| NO. | FREQ. (MHz) | EMISSION LEVEL (dBuV/m) | LIMIT (dBuV/m) | MARGIN (dB) | ANTENNA HEIGHT (m) | TABLE ANGLE (Degree) | RAW VALUE (dBuV) | CORRECTION FACTOR (dB/m) |
|-----|-------------|-------------------------|----------------|-------------|--------------------|----------------------|------------------|--------------------------|
| 1 | *5700.00 | 105.6 PK | | | 2.60 V | 258 | 65.3 | 40.3 |
| 2 | *5700.00 | 95.7 AV | | | 2.60 V | 258 | 55.4 | 40.3 |
| 3 | #5725.00 | 58.3 PK | 74.0 | -15.7 | 2.66 V | 280 | 53.8 | 4.5 |
| 4 | #5725.00 | 46.9 AV | 54.0 | -7.1 | 2.66 V | 280 | 42.4 | 4.5 |
| 5 | 11400.00 | 60.9 PK | 74.0 | -13.1 | 2.08 V | 173 | 42.7 | 18.2 |
| 6 | 11400.00 | 47.9 AV | 54.0 | -6.1 | 2.08 V | 173 | 29.7 | 18.2 |

Remarks:

1. Emission Level(dBuV/m) = Raw Value(dBuV) + Correction Factor(dB/m)
2. Correction Factor(dB/m) = Antenna Factor(dB/m) + Cable Factor(dB) – Pre-Amplifier Factor(dB)
3. The other emission levels were very low against the limit.
4. Margin value = Emission Level – Limit value
5. " * ": Fundamental frequency.
6. " # ": The radiated frequency is out of the restricted band.

| | | | |
|-----------------|----------------|----------------------|--------------|
| CHANNEL | TX Channel 144 | DETECTOR FUNCTION | Peak (PK) |
| FREQUENCY RANGE | 1GHz ~ 40GHz | | Average (AV) |

| ANTENNA POLARITY & TEST DISTANCE: HORIZONTAL AT 3 M | | | | | | | | |
|---|----------------|-------------------------------|-------------------|----------------|--------------------------|----------------------------|------------------------|--------------------------------|
| NO. | FREQ. (MHz) | EMISSION LEVEL (dBuV/m) | LIMIT (dBuV/m) | MARGIN (dB) | ANTENNA HEIGHT (m) | TABLE ANGLE (Degree) | RAW VALUE (dBuV) | CORRECTION FACTOR (dB/m) |
| 1 | #5470.00 | 57.7 PK | 74.0 | -16.3 | 1.93 H | 188 | 53.7 | 4.0 |
| 2 | #5470.00 | 43.9 AV | 54.0 | -10.1 | 1.93 H | 188 | 39.9 | 4.0 |
| 3 | *5720.00 | 126.6 PK | | | 1.88 H | 173 | 86.2 | 40.4 |
| 4 | *5720.00 | 115.5 AV | | | 1.88 H | 173 | 75.1 | 40.4 |
| 5 | #5825.00 | 58.0 PK | 74.0 | -16.0 | 1.83 H | 189 | 53.3 | 4.7 |
| 6 | #5825.00 | 44.5 AV | 54.0 | -9.5 | 1.83 H | 189 | 39.8 | 4.7 |
| 7 | 11440.00 | 61.8 PK | 74.0 | -12.2 | 1.73 H | 169 | 43.5 | 18.3 |
| 8 | 11440.00 | 48.4 AV | 54.0 | -5.6 | 1.73 H | 169 | 30.1 | 18.3 |

| ANTENNA POLARITY & TEST DISTANCE: VERTICAL AT 3 M | | | | | | | | |
|---|----------------|-------------------------------|-------------------|----------------|--------------------------|----------------------------|------------------------|--------------------------------|
| NO. | FREQ. (MHz) | EMISSION LEVEL (dBuV/m) | LIMIT (dBuV/m) | MARGIN (dB) | ANTENNA HEIGHT (m) | TABLE ANGLE (Degree) | RAW VALUE (dBuV) | CORRECTION FACTOR (dB/m) |
| 1 | #5470.00 | 56.3 PK | 74.0 | -17.7 | 2.44 V | 333 | 52.3 | 4.0 |
| 2 | #5470.00 | 42.6 AV | 54.0 | -11.4 | 2.44 V | 333 | 38.6 | 4.0 |
| 3 | *5720.00 | 107.6 PK | | | 2.66 V | 304 | 67.2 | 40.4 |
| 4 | *5720.00 | 97.2 AV | | | 2.66 V | 304 | 56.8 | 40.4 |
| 5 | #5825.00 | 57.3 PK | 74.0 | -16.7 | 2.37 V | 334 | 52.6 | 4.7 |
| 6 | #5825.00 | 43.2 AV | 54.0 | -10.8 | 2.37 V | 334 | 38.5 | 4.7 |
| 7 | 11440.00 | 70.9 PK | 74.0 | -3.1 | 1.93 V | 344 | 52.6 | 18.3 |
| 8 | 11440.00 | 47.6 AV | 54.0 | -6.4 | 1.93 V | 344 | 29.3 | 18.3 |

Remarks:

1. Emission Level(dBuV/m) = Raw Value(dBuV) + Correction Factor(dB/m)
2. Correction Factor(dB/m) = Antenna Factor(dB/m) + Cable Factor(dB) – Pre-Amplifier Factor(dB)
3. The other emission levels were very low against the limit.
4. Margin value = Emission Level – Limit value
5. " * ": Fundamental frequency.
6. " # ": The radiated frequency is out of the restricted band.

802.11n (HT20)

| | | | |
|-----------------|---------------|----------------------|--------------|
| CHANNEL | TX Channel 52 | DETECTOR FUNCTION | Peak (PK) |
| FREQUENCY RANGE | 1GHz ~ 40GHz | | Average (AV) |

ANTENNA POLARITY & TEST DISTANCE: HORIZONTAL AT 3 M

| NO. | FREQ. (MHz) | EMISSION LEVEL (dBuV/m) | LIMIT (dBuV/m) | MARGIN (dB) | ANTENNA HEIGHT (m) | TABLE ANGLE (Degree) | RAW VALUE (dBuV) | CORRECTION FACTOR (dB/m) |
|-----|----------------|-------------------------------|-------------------|----------------|--------------------------|----------------------------|------------------------|--------------------------------|
| 1 | 5150.00 | 57.7 PK | 74.0 | -16.3 | 1.62 H | 173 | 54.1 | 3.6 |
| 2 | 5150.00 | 47.1 AV | 54.0 | -6.9 | 1.62 H | 173 | 43.5 | 3.6 |
| 3 | *5260.00 | 124.7 PK | | | 1.86 H | 343 | 85.1 | 39.6 |
| 4 | *5260.00 | 114.3 AV | | | 1.86 H | 343 | 74.7 | 39.6 |
| 5 | #10520.00 | 60.0 PK | 74.0 | -14.0 | 1.99 H | 203 | 43.0 | 17.0 |
| 6 | #10520.00 | 46.6 AV | 54.0 | -7.4 | 1.99 H | 203 | 29.6 | 17.0 |

ANTENNA POLARITY & TEST DISTANCE: VERTICAL AT 3 M

| NO. | FREQ. (MHz) | EMISSION LEVEL (dBuV/m) | LIMIT (dBuV/m) | MARGIN (dB) | ANTENNA HEIGHT (m) | TABLE ANGLE (Degree) | RAW VALUE (dBuV) | CORRECTION FACTOR (dB/m) |
|-----|----------------|-------------------------------|-------------------|----------------|--------------------------|----------------------------|------------------------|--------------------------------|
| 1 | 5150.00 | 54.6 PK | 74.0 | -19.4 | 2.11 V | 297 | 51.0 | 3.6 |
| 2 | 5150.00 | 41.9 AV | 54.0 | -12.1 | 2.11 V | 297 | 38.3 | 3.6 |
| 3 | *5260.00 | 104.8 PK | | | 2.53 V | 340 | 65.2 | 39.6 |
| 4 | *5260.00 | 94.4 AV | | | 2.53 V | 340 | 54.8 | 39.6 |
| 5 | #10520.00 | 59.1 PK | 74.0 | -14.9 | 2.33 V | 324 | 42.1 | 17.0 |
| 6 | #10520.00 | 45.5 AV | 54.0 | -8.5 | 2.33 V | 324 | 28.5 | 17.0 |

Remarks:

1. Emission Level(dBuV/m) = Raw Value(dBuV) + Correction Factor(dB/m)
2. Correction Factor(dB/m) = Antenna Factor(dB/m) + Cable Factor(dB) – Pre-Amplifier Factor(dB)
3. The other emission levels were very low against the limit.
4. Margin value = Emission Level – Limit value
5. " * ": Fundamental frequency.
6. " # ": The radiated frequency is out of the restricted band.

| | | | |
|-----------------|---------------|-------------------|--------------|
| CHANNEL | TX Channel 60 | DETECTOR FUNCTION | Peak (PK) |
| FREQUENCY RANGE | 1GHz ~ 40GHz | | Average (AV) |

| ANTENNA POLARITY & TEST DISTANCE: HORIZONTAL AT 3 M | | | | | | | | |
|---|-------------|-------------------------|----------------|-------------|--------------------|----------------------|------------------|--------------------------|
| NO. | FREQ. (MHz) | EMISSION LEVEL (dBuV/m) | LIMIT (dBuV/m) | MARGIN (dB) | ANTENNA HEIGHT (m) | TABLE ANGLE (Degree) | RAW VALUE (dBuV) | CORRECTION FACTOR (dB/m) |
| 1 | *5300.00 | 125.0 PK | | | 1.91 H | 174 | 85.4 | 39.6 |
| 2 | *5300.00 | 114.6 AV | | | 1.91 H | 174 | 75.0 | 39.6 |
| 3 | 5350.00 | 59.8 PK | 74.0 | -14.2 | 2.03 H | 199 | 55.9 | 3.9 |
| 4 | 5350.00 | 48.0 AV | 54.0 | -6.0 | 2.03 H | 199 | 44.1 | 3.9 |
| 5 | 10600.00 | 59.5 PK | 74.0 | -14.5 | 1.83 H | 293 | 42.4 | 17.1 |
| 6 | 10600.00 | 46.7 AV | 54.0 | -7.3 | 1.83 H | 293 | 29.6 | 17.1 |

| ANTENNA POLARITY & TEST DISTANCE: VERTICAL AT 3 M | | | | | | | | |
|---|-------------|-------------------------|----------------|-------------|--------------------|----------------------|------------------|--------------------------|
| NO. | FREQ. (MHz) | EMISSION LEVEL (dBuV/m) | LIMIT (dBuV/m) | MARGIN (dB) | ANTENNA HEIGHT (m) | TABLE ANGLE (Degree) | RAW VALUE (dBuV) | CORRECTION FACTOR (dB/m) |
| 1 | *5300.00 | 104.1 PK | | | 2.52 V | 341 | 64.5 | 39.6 |
| 2 | *5300.00 | 93.2 AV | | | 2.52 V | 341 | 53.6 | 39.6 |
| 3 | 5350.00 | 55.5 PK | 74.0 | -18.5 | 2.22 V | 333 | 51.6 | 3.9 |
| 4 | 5350.00 | 42.1 AV | 54.0 | -11.9 | 2.22 V | 333 | 38.2 | 3.9 |
| 5 | 10600.00 | 58.2 PK | 74.0 | -15.8 | 2.31 V | 268 | 41.1 | 17.1 |
| 6 | 10600.00 | 45.2 AV | 54.0 | -8.8 | 2.31 V | 268 | 28.1 | 17.1 |

Remarks:

1. Emission Level(dBuV/m) = Raw Value(dBuV) + Correction Factor(dB/m)
2. Correction Factor(dB/m) = Antenna Factor(dB/m) + Cable Factor(dB) – Pre-Amplifier Factor(dB)
3. The other emission levels were very low against the limit.
4. Margin value = Emission Level – Limit value
5. " * ": Fundamental frequency.
6. " # ": The radiated frequency is out of the restricted band.

| | | | |
|-----------------|---------------|----------|--------------|
| CHANNEL | TX Channel 64 | DETECTOR | Peak (PK) |
| FREQUENCY RANGE | 1GHz ~ 40GHz | FUNCTION | Average (AV) |

ANTENNA POLARITY & TEST DISTANCE: HORIZONTAL AT 3 M

| NO. | FREQ. (MHz) | EMISSION LEVEL (dBuV/m) | LIMIT (dBuV/m) | MARGIN (dB) | ANTENNA HEIGHT (m) | TABLE ANGLE (Degree) | RAW VALUE (dBuV) | CORRECTION FACTOR (dB/m) |
|-----|-------------|-------------------------|----------------|-------------|--------------------|----------------------|------------------|--------------------------|
| 1 | *5320.00 | 125.2 PK | | | 1.89 H | 175 | 85.5 | 39.7 |
| 2 | *5320.00 | 114.8 AV | | | 1.89 H | 175 | 75.1 | 39.7 |
| 3 | 5350.00 | 65.1 PK | 74.0 | -8.9 | 1.67 H | 343 | 61.2 | 3.9 |
| 4 | 5350.00 | 52.2 AV | 54.0 | -1.8 | 1.67 H | 343 | 48.3 | 3.9 |
| 5 | 10640.00 | 59.9 PK | 74.0 | -14.1 | 1.98 H | 287 | 42.6 | 17.3 |
| 6 | 10640.00 | 45.7 AV | 54.0 | -8.3 | 1.98 H | 287 | 28.4 | 17.3 |

ANTENNA POLARITY & TEST DISTANCE: VERTICAL AT 3 M

| NO. | FREQ. (MHz) | EMISSION LEVEL (dBuV/m) | LIMIT (dBuV/m) | MARGIN (dB) | ANTENNA HEIGHT (m) | TABLE ANGLE (Degree) | RAW VALUE (dBuV) | CORRECTION FACTOR (dB/m) |
|-----|-------------|-------------------------|----------------|-------------|--------------------|----------------------|------------------|--------------------------|
| 1 | *5320.00 | 103.9 PK | | | 2.64 V | 340 | 64.2 | 39.7 |
| 2 | *5320.00 | 93.4 AV | | | 2.64 V | 340 | 53.7 | 39.7 |
| 3 | 5350.00 | 55.9 PK | 74.0 | -18.1 | 2.54 V | 319 | 52.0 | 3.9 |
| 4 | 5350.00 | 42.5 AV | 54.0 | -11.5 | 2.54 V | 319 | 38.6 | 3.9 |
| 5 | 10640.00 | 58.6 PK | 74.0 | -15.4 | 2.16 V | 278 | 41.3 | 17.3 |
| 6 | 10640.00 | 45.4 AV | 54.0 | -8.6 | 2.16 V | 278 | 28.1 | 17.3 |

Remarks:

1. Emission Level(dBuV/m) = Raw Value(dBuV) + Correction Factor(dB/m)
2. Correction Factor(dB/m) = Antenna Factor(dB/m) + Cable Factor(dB) – Pre-Amplifier Factor(dB)
3. The other emission levels were very low against the limit.
4. Margin value = Emission Level – Limit value
5. " * ": Fundamental frequency.
6. " # ": The radiated frequency is out of the restricted band.

| | | | |
|-----------------|----------------|----------------------|--------------|
| CHANNEL | TX Channel 100 | DETECTOR FUNCTION | Peak (PK) |
| FREQUENCY RANGE | 1GHz ~ 40GHz | | Average (AV) |

ANTENNA POLARITY & TEST DISTANCE: HORIZONTAL AT 3 M

| NO. | FREQ. (MHz) | EMISSION LEVEL (dBuV/m) | LIMIT (dBuV/m) | MARGIN (dB) | ANTENNA HEIGHT (m) | TABLE ANGLE (Degree) | RAW VALUE (dBuV) | CORRECTION FACTOR (dB/m) |
|-----|----------------|-------------------------------|-------------------|----------------|--------------------------|----------------------------|------------------------|--------------------------------|
| 1 | 5460.00 | 62.1 PK | 74.0 | -11.9 | 1.75 H | 345 | 58.1 | 4.0 |
| 2 | 5460.00 | 49.3 AV | 54.0 | -4.7 | 1.75 H | 345 | 45.3 | 4.0 |
| 3 | #5470.00 | 66.9 PK | 74.0 | -7.1 | 1.72 H | 345 | 62.9 | 4.0 |
| 4 | #5470.00 | 52.5 AV | 54.0 | -1.5 | 1.72 H | 345 | 48.5 | 4.0 |
| 5 | *5500.00 | 125.2 PK | | | 1.77 H | 345 | 85.2 | 40.0 |
| 6 | *5500.00 | 114.6 AV | | | 1.77 H | 345 | 74.6 | 40.0 |
| 7 | 11000.00 | 64.1 PK | 74.0 | -9.9 | 1.31 H | 345 | 45.1 | 19.0 |
| 8 | 11000.00 | 51.2 AV | 54.0 | -2.8 | 1.31 H | 345 | 32.2 | 19.0 |

ANTENNA POLARITY & TEST DISTANCE: VERTICAL AT 3 M

| NO. | FREQ. (MHz) | EMISSION LEVEL (dBuV/m) | LIMIT (dBuV/m) | MARGIN (dB) | ANTENNA HEIGHT (m) | TABLE ANGLE (Degree) | RAW VALUE (dBuV) | CORRECTION FACTOR (dB/m) |
|-----|----------------|-------------------------------|-------------------|----------------|--------------------------|----------------------------|------------------------|--------------------------------|
| 1 | 5460.00 | 55.7 PK | 74.0 | -18.3 | 2.35 V | 190 | 51.7 | 4.0 |
| 2 | 5460.00 | 45.1 AV | 54.0 | -8.9 | 2.35 V | 190 | 41.1 | 4.0 |
| 3 | #5470.00 | 56.6 PK | 74.0 | -17.4 | 2.60 V | 210 | 52.6 | 4.0 |
| 4 | #5470.00 | 45.8 AV | 54.0 | -8.2 | 2.60 V | 210 | 41.8 | 4.0 |
| 5 | *5500.00 | 106.4 PK | | | 2.43 V | 259 | 66.4 | 40.0 |
| 6 | *5500.00 | 95.2 AV | | | 2.43 V | 259 | 55.2 | 40.0 |
| 7 | 11000.00 | 61.5 PK | 74.0 | -12.5 | 2.06 V | 244 | 42.5 | 19.0 |
| 8 | 11000.00 | 48.7 AV | 54.0 | -5.3 | 2.06 V | 244 | 29.7 | 19.0 |

Remarks:

1. Emission Level(dBuV/m) = Raw Value(dBuV) + Correction Factor(dB/m)
2. Correction Factor(dB/m) = Antenna Factor(dB/m) + Cable Factor(dB) – Pre-Amplifier Factor(dB)
3. The other emission levels were very low against the limit.
4. Margin value = Emission Level – Limit value
5. " * ": Fundamental frequency.
6. " # ": The radiated frequency is out of the restricted band.

| | | | |
|-----------------|----------------|-------------------|--------------|
| CHANNEL | TX Channel 116 | DETECTOR FUNCTION | Peak (PK) |
| FREQUENCY RANGE | 1GHz ~ 40GHz | | Average (AV) |

ANTENNA POLARITY & TEST DISTANCE: HORIZONTAL AT 3 M

| NO. | FREQ. (MHz) | EMISSION LEVEL (dBuV/m) | LIMIT (dBuV/m) | MARGIN (dB) | ANTENNA HEIGHT (m) | TABLE ANGLE (Degree) | RAW VALUE (dBuV) | CORRECTION FACTOR (dB/m) |
|-----|-------------|-------------------------|----------------|-------------|--------------------|----------------------|------------------|--------------------------|
| 1 | *5580.00 | 125.4 PK | | | 1.75 H | 344 | 85.3 | 40.1 |
| 2 | *5580.00 | 114.7 AV | | | 1.75 H | 344 | 74.6 | 40.1 |
| 3 | 11160.00 | 65.0 PK | 74.0 | -9.0 | 1.28 H | 349 | 46.3 | 18.7 |
| 4 | 11160.00 | 51.9 AV | 54.0 | -2.1 | 1.28 H | 349 | 33.2 | 18.7 |

ANTENNA POLARITY & TEST DISTANCE: VERTICAL AT 3 M

| NO. | FREQ. (MHz) | EMISSION LEVEL (dBuV/m) | LIMIT (dBuV/m) | MARGIN (dB) | ANTENNA HEIGHT (m) | TABLE ANGLE (Degree) | RAW VALUE (dBuV) | CORRECTION FACTOR (dB/m) |
|-----|-------------|-------------------------|----------------|-------------|--------------------|----------------------|------------------|--------------------------|
| 1 | *5580.00 | 106.8 PK | | | 2.72 V | 258 | 66.7 | 40.1 |
| 2 | *5580.00 | 95.7 AV | | | 2.72 V | 258 | 55.6 | 40.1 |
| 3 | 11160.00 | 62.5 PK | 74.0 | -11.5 | 2.11 V | 190 | 43.8 | 18.7 |
| 4 | 11160.00 | 48.7 AV | 54.0 | -5.3 | 2.11 V | 190 | 30.0 | 18.7 |

Remarks:

1. Emission Level(dBuV/m) = Raw Value(dBuV) + Correction Factor(dB/m)
2. Correction Factor(dB/m) = Antenna Factor(dB/m) + Cable Factor(dB) – Pre-Amplifier Factor(dB)
3. The other emission levels were very low against the limit.
4. Margin value = Emission Level – Limit value
5. " * ": Fundamental frequency.
6. " # ": The radiated frequency is out of the restricted band.

| | | | |
|-----------------|----------------|-------------------|--------------|
| CHANNEL | TX Channel 140 | DETECTOR FUNCTION | Peak (PK) |
| FREQUENCY RANGE | 1GHz ~ 40GHz | | Average (AV) |

ANTENNA POLARITY & TEST DISTANCE: HORIZONTAL AT 3 M

| NO. | FREQ. (MHz) | EMISSION LEVEL (dBuV/m) | LIMIT (dBuV/m) | MARGIN (dB) | ANTENNA HEIGHT (m) | TABLE ANGLE (Degree) | RAW VALUE (dBuV) | CORRECTION FACTOR (dB/m) |
|----------|-----------------|-------------------------|----------------|-------------|--------------------|----------------------|------------------|--------------------------|
| 1 | *5700.00 | 122.6 PK | | | 1.79 H | 347 | 82.3 | 40.3 |
| 2 | *5700.00 | 111.8 AV | | | 1.79 H | 347 | 71.5 | 40.3 |
| 3 | #5725.00 | 67.6 PK | 74.0 | -6.4 | 1.75 H | 344 | 63.1 | 4.5 |
| 4 | #5725.00 | 53.0 AV | 54.0 | -1.0 | 1.75 H | 344 | 48.5 | 4.5 |
| 5 | 11400.00 | 61.6 PK | 74.0 | -12.4 | 1.30 H | 348 | 43.4 | 18.2 |
| 6 | 11400.00 | 48.8 AV | 54.0 | -5.2 | 1.30 H | 348 | 30.6 | 18.2 |

ANTENNA POLARITY & TEST DISTANCE: VERTICAL AT 3 M

| NO. | FREQ. (MHz) | EMISSION LEVEL (dBuV/m) | LIMIT (dBuV/m) | MARGIN (dB) | ANTENNA HEIGHT (m) | TABLE ANGLE (Degree) | RAW VALUE (dBuV) | CORRECTION FACTOR (dB/m) |
|-----|-------------|-------------------------|----------------|-------------|--------------------|----------------------|------------------|--------------------------|
| 1 | *5700.00 | 103.5 PK | | | 2.84 V | 259 | 63.2 | 40.3 |
| 2 | *5700.00 | 93.0 AV | | | 2.84 V | 259 | 52.7 | 40.3 |
| 3 | #5725.00 | 59.3 PK | 74.0 | -14.7 | 2.56 V | 244 | 54.8 | 4.5 |
| 4 | #5725.00 | 48.0 AV | 54.0 | -6.0 | 2.56 V | 244 | 43.5 | 4.5 |
| 5 | 11400.00 | 60.9 PK | 74.0 | -13.1 | 2.12 V | 175 | 42.7 | 18.2 |
| 6 | 11400.00 | 47.9 AV | 54.0 | -6.1 | 2.12 V | 175 | 29.7 | 18.2 |

Remarks:

1. Emission Level(dBuV/m) = Raw Value(dBuV) + Correction Factor(dB/m)
2. Correction Factor(dB/m) = Antenna Factor(dB/m) + Cable Factor(dB) – Pre-Amplifier Factor(dB)
3. The other emission levels were very low against the limit.
4. Margin value = Emission Level – Limit value
5. " * ": Fundamental frequency.
6. " # ": The radiated frequency is out of the restricted band.

| | | | |
|-----------------|----------------|----------------------|--------------|
| CHANNEL | TX Channel 144 | DETECTOR FUNCTION | Peak (PK) |
| FREQUENCY RANGE | 1GHz ~ 40GHz | | Average (AV) |

ANTENNA POLARITY & TEST DISTANCE: HORIZONTAL AT 3 M

| NO. | FREQ. (MHz) | EMISSION LEVEL (dBuV/m) | LIMIT (dBuV/m) | MARGIN (dB) | ANTENNA HEIGHT (m) | TABLE ANGLE (Degree) | RAW VALUE (dBuV) | CORRECTION FACTOR (dB/m) |
|-----|----------------|-------------------------------|-------------------|----------------|--------------------------|----------------------------|------------------------|--------------------------------|
| 1 | #5470.00 | 57.2 PK | 74.0 | -16.8 | 1.93 H | 187 | 53.2 | 4.0 |
| 2 | #5470.00 | 43.8 AV | 54.0 | -10.2 | 1.93 H | 187 | 39.8 | 4.0 |
| 3 | *5720.00 | 126.0 PK | | | 1.82 H | 175 | 85.6 | 40.4 |
| 4 | *5720.00 | 115.1 AV | | | 1.82 H | 175 | 74.7 | 40.4 |
| 5 | #5825.00 | 57.7 PK | 74.0 | -16.3 | 1.88 H | 193 | 53.0 | 4.7 |
| 6 | #5825.00 | 44.6 AV | 54.0 | -9.4 | 1.88 H | 193 | 39.9 | 4.7 |
| 7 | 11440.00 | 60.5 PK | 74.0 | -13.5 | 1.76 H | 193 | 42.2 | 18.3 |
| 8 | 11440.00 | 47.9 AV | 54.0 | -6.1 | 1.76 H | 193 | 29.6 | 18.3 |

ANTENNA POLARITY & TEST DISTANCE: VERTICAL AT 3 M

| NO. | FREQ. (MHz) | EMISSION LEVEL (dBuV/m) | LIMIT (dBuV/m) | MARGIN (dB) | ANTENNA HEIGHT (m) | TABLE ANGLE (Degree) | RAW VALUE (dBuV) | CORRECTION FACTOR (dB/m) |
|-----|----------------|-------------------------------|-------------------|----------------|--------------------------|----------------------------|------------------------|--------------------------------|
| 1 | #5470.00 | 56.1 PK | 74.0 | -17.9 | 2.22 V | 319 | 52.1 | 4.0 |
| 2 | #5470.00 | 42.7 AV | 54.0 | -11.3 | 2.22 V | 319 | 38.7 | 4.0 |
| 3 | *5720.00 | 108.1 PK | | | 2.53 V | 301 | 67.7 | 40.4 |
| 4 | *5720.00 | 96.8 AV | | | 2.53 V | 301 | 56.4 | 40.4 |
| 5 | #5825.00 | 56.1 PK | 74.0 | -17.9 | 2.27 V | 325 | 51.4 | 4.7 |
| 6 | #5825.00 | 43.2 AV | 54.0 | -10.8 | 2.27 V | 325 | 38.5 | 4.7 |
| 7 | 11440.00 | 60.9 PK | 74.0 | -13.1 | 2.37 V | 298 | 42.6 | 18.3 |
| 8 | 11440.00 | 47.5 AV | 54.0 | -6.5 | 2.37 V | 298 | 29.2 | 18.3 |

Remarks:

1. Emission Level(dBuV/m) = Raw Value(dBuV) + Correction Factor(dB/m)
2. Correction Factor(dB/m) = Antenna Factor(dB/m) + Cable Factor(dB) – Pre-Amplifier Factor(dB)
3. The other emission levels were very low against the limit.
4. Margin value = Emission Level – Limit value
5. " * ": Fundamental frequency.
6. " # ": The radiated frequency is out of the restricted band.

802.11n (HT40)

| | | | |
|-----------------|---------------|----------------------|--------------|
| CHANNEL | TX Channel 54 | DETECTOR FUNCTION | Peak (PK) |
| FREQUENCY RANGE | 1GHz ~ 40GHz | | Average (AV) |

ANTENNA POLARITY & TEST DISTANCE: HORIZONTAL AT 3 M

| NO. | FREQ. (MHz) | EMISSION LEVEL (dBuV/m) | LIMIT (dBuV/m) | MARGIN (dB) | ANTENNA HEIGHT (m) | TABLE ANGLE (Degree) | RAW VALUE (dBuV) | CORRECTION FACTOR (dB/m) |
|-----|----------------|-------------------------------|-------------------|----------------|--------------------------|----------------------------|------------------------|--------------------------------|
| 1 | 5150.00 | 59.1 PK | 74.0 | -14.9 | 1.68 H | 345 | 55.5 | 3.6 |
| 2 | 5150.00 | 47.6 AV | 54.0 | -6.4 | 1.68 H | 345 | 44.0 | 3.6 |
| 3 | *5270.00 | 121.9 PK | | | 1.72 H | 177 | 82.3 | 39.6 |
| 4 | *5270.00 | 111.5 AV | | | 1.72 H | 177 | 71.9 | 39.6 |
| 5 | #10540.00 | 58.7 PK | 74.0 | -15.3 | 1.92 H | 279 | 41.6 | 17.1 |
| 6 | #10540.00 | 45.9 AV | 54.0 | -8.1 | 1.92 H | 279 | 28.8 | 17.1 |

ANTENNA POLARITY & TEST DISTANCE: VERTICAL AT 3 M

| NO. | FREQ. (MHz) | EMISSION LEVEL (dBuV/m) | LIMIT (dBuV/m) | MARGIN (dB) | ANTENNA HEIGHT (m) | TABLE ANGLE (Degree) | RAW VALUE (dBuV) | CORRECTION FACTOR (dB/m) |
|-----|----------------|-------------------------------|-------------------|----------------|--------------------------|----------------------------|------------------------|--------------------------------|
| 1 | 5150.00 | 54.4 PK | 74.0 | -19.6 | 2.49 V | 223 | 50.8 | 3.6 |
| 2 | 5150.00 | 43.9 AV | 54.0 | -10.1 | 2.49 V | 223 | 40.3 | 3.6 |
| 3 | *5270.00 | 102.1 PK | | | 2.77 V | 219 | 62.5 | 39.6 |
| 4 | *5270.00 | 92.2 AV | | | 2.77 V | 219 | 52.6 | 39.6 |
| 5 | #10540.00 | 58.5 PK | 74.0 | -15.5 | 2.10 V | 290 | 41.4 | 17.1 |
| 6 | #10540.00 | 45.4 AV | 54.0 | -8.6 | 2.10 V | 290 | 28.3 | 17.1 |

Remarks:

1. Emission Level(dBuV/m) = Raw Value(dBuV) + Correction Factor(dB/m)
2. Correction Factor(dB/m) = Antenna Factor(dB/m) + Cable Factor(dB) – Pre-Amplifier Factor(dB)
3. The other emission levels were very low against the limit.
4. Margin value = Emission Level – Limit value
5. " * ": Fundamental frequency.
6. " # ": The radiated frequency is out of the restricted band.

| | | | |
|-----------------|---------------|----------|--------------|
| CHANNEL | TX Channel 62 | DETECTOR | Peak (PK) |
| FREQUENCY RANGE | 1GHz ~ 40GHz | FUNCTION | Average (AV) |

ANTENNA POLARITY & TEST DISTANCE: HORIZONTAL AT 3 M

| NO. | FREQ. (MHz) | EMISSION LEVEL (dBuV/m) | LIMIT (dBuV/m) | MARGIN (dB) | ANTENNA HEIGHT (m) | TABLE ANGLE (Degree) | RAW VALUE (dBuV) | CORRECTION FACTOR (dB/m) |
|-----|-------------|-------------------------|----------------|-------------|--------------------|----------------------|------------------|--------------------------|
| 1 | *5310.00 | 117.9 PK | | | 1.79 H | 176 | 78.3 | 39.6 |
| 2 | *5310.00 | 107.5 AV | | | 1.79 H | 176 | 67.9 | 39.6 |
| 3 | 5350.00 | 66.0 PK | 74.0 | -8.0 | 2.12 H | 348 | 62.1 | 3.9 |
| 4 | 5350.00 | 52.5 AV | 54.0 | -1.5 | 2.12 H | 348 | 48.6 | 3.9 |
| 5 | 10620.00 | 58.6 PK | 74.0 | -15.4 | 2.12 H | 264 | 41.3 | 17.3 |
| 6 | 10620.00 | 45.5 AV | 54.0 | -8.5 | 2.12 H | 264 | 28.2 | 17.3 |

ANTENNA POLARITY & TEST DISTANCE: VERTICAL AT 3 M

| NO. | FREQ. (MHz) | EMISSION LEVEL (dBuV/m) | LIMIT (dBuV/m) | MARGIN (dB) | ANTENNA HEIGHT (m) | TABLE ANGLE (Degree) | RAW VALUE (dBuV) | CORRECTION FACTOR (dB/m) |
|-----|-------------|-------------------------|----------------|-------------|--------------------|----------------------|------------------|--------------------------|
| 1 | *5310.00 | 97.0 PK | | | 2.89 V | 216 | 57.4 | 39.6 |
| 2 | *5310.00 | 87.3 AV | | | 2.89 V | 216 | 47.7 | 39.6 |
| 3 | 5350.00 | 54.2 PK | 74.0 | -19.8 | 2.59 V | 233 | 50.3 | 3.9 |
| 4 | 5350.00 | 43.5 AV | 54.0 | -10.5 | 2.59 V | 233 | 39.6 | 3.9 |
| 5 | 10620.00 | 58.3 PK | 74.0 | -15.7 | 2.19 V | 270 | 41.0 | 17.3 |
| 6 | 10620.00 | 45.2 AV | 54.0 | -8.8 | 2.19 V | 270 | 27.9 | 17.3 |

Remarks:

1. Emission Level(dBuV/m) = Raw Value(dBuV) + Correction Factor(dB/m)
2. Correction Factor(dB/m) = Antenna Factor(dB/m) + Cable Factor(dB) – Pre-Amplifier Factor(dB)
3. The other emission levels were very low against the limit.
4. Margin value = Emission Level – Limit value
5. " * ": Fundamental frequency.
6. " # ": The radiated frequency is out of the restricted band.

| | | | |
|-----------------|----------------|----------------------|--------------|
| CHANNEL | TX Channel 102 | DETECTOR FUNCTION | Peak (PK) |
| FREQUENCY RANGE | 1GHz ~ 40GHz | | Average (AV) |

ANTENNA POLARITY & TEST DISTANCE: HORIZONTAL AT 3 M

| NO. | FREQ. (MHz) | EMISSION LEVEL (dBuV/m) | LIMIT (dBuV/m) | MARGIN (dB) | ANTENNA HEIGHT (m) | TABLE ANGLE (Degree) | RAW VALUE (dBuV) | CORRECTION FACTOR (dB/m) |
|-----|----------------|-------------------------------|-------------------|----------------|--------------------------|----------------------------|------------------------|--------------------------------|
| 1 | 5460.00 | 62.3 PK | 74.0 | -11.7 | 1.77 H | 340 | 58.3 | 4.0 |
| 2 | 5460.00 | 49.0 AV | 54.0 | -5.0 | 1.77 H | 340 | 45.0 | 4.0 |
| 3 | #5470.00 | 69.8 PK | 74.0 | -4.2 | 1.95 H | 344 | 65.8 | 4.0 |
| 4 | #5470.00 | 52.5 AV | 54.0 | -1.5 | 1.95 H | 344 | 48.5 | 4.0 |
| 5 | *5510.00 | 118.8 PK | | | 1.70 H | 346 | 78.8 | 40.0 |
| 6 | *5510.00 | 108.4 AV | | | 1.70 H | 346 | 68.4 | 40.0 |
| 7 | 11020.00 | 61.7 PK | 74.0 | -12.3 | 1.25 H | 348 | 42.8 | 18.9 |
| 8 | 11020.00 | 48.4 AV | 54.0 | -5.6 | 1.25 H | 348 | 29.5 | 18.9 |

ANTENNA POLARITY & TEST DISTANCE: VERTICAL AT 3 M

| NO. | FREQ. (MHz) | EMISSION LEVEL (dBuV/m) | LIMIT (dBuV/m) | MARGIN (dB) | ANTENNA HEIGHT (m) | TABLE ANGLE (Degree) | RAW VALUE (dBuV) | CORRECTION FACTOR (dB/m) |
|-----|----------------|-------------------------------|-------------------|----------------|--------------------------|----------------------------|------------------------|--------------------------------|
| 1 | 5460.00 | 56.4 PK | 74.0 | -17.6 | 2.61 V | 252 | 52.4 | 4.0 |
| 2 | 5460.00 | 45.6 AV | 54.0 | -8.4 | 2.61 V | 252 | 41.6 | 4.0 |
| 3 | #5470.00 | 56.0 PK | 74.0 | -18.0 | 2.70 V | 270 | 52.0 | 4.0 |
| 4 | #5470.00 | 44.8 AV | 54.0 | -9.2 | 2.70 V | 270 | 40.8 | 4.0 |
| 5 | *5510.00 | 99.3 PK | | | 2.78 V | 259 | 59.3 | 40.0 |
| 6 | *5510.00 | 89.4 AV | | | 2.78 V | 259 | 49.4 | 40.0 |
| 7 | 11020.00 | 61.4 PK | 74.0 | -12.6 | 2.19 V | 275 | 42.5 | 18.9 |
| 8 | 11020.00 | 48.0 AV | 54.0 | -6.0 | 2.19 V | 275 | 29.1 | 18.9 |

Remarks:

1. Emission Level(dBuV/m) = Raw Value(dBuV) + Correction Factor(dB/m)
2. Correction Factor(dB/m) = Antenna Factor(dB/m) + Cable Factor(dB) – Pre-Amplifier Factor(dB)
3. The other emission levels were very low against the limit.
4. Margin value = Emission Level – Limit value
5. " * ": Fundamental frequency.
6. " # ": The radiated frequency is out of the restricted band.

| | | | |
|-----------------|----------------|----------|--------------|
| CHANNEL | TX Channel 110 | DETECTOR | Peak (PK) |
| FREQUENCY RANGE | 1GHz ~ 40GHz | FUNCTION | Average (AV) |

ANTENNA POLARITY & TEST DISTANCE: HORIZONTAL AT 3 M

| NO. | FREQ. (MHz) | EMISSION LEVEL (dBuV/m) | LIMIT (dBuV/m) | MARGIN (dB) | ANTENNA HEIGHT (m) | TABLE ANGLE (Degree) | RAW VALUE (dBuV) | CORRECTION FACTOR (dB/m) |
|-----|-------------|-------------------------|----------------|-------------|--------------------|----------------------|------------------|--------------------------|
| 1 | *5550.00 | 122.4 PK | | | 1.72 H | 346 | 82.4 | 40.0 |
| 2 | *5550.00 | 112.4 AV | | | 1.72 H | 346 | 72.4 | 40.0 |
| 3 | 11100.00 | 61.9 PK | 74.0 | -12.1 | 1.39 H | 349 | 43.4 | 18.5 |
| 4 | 11100.00 | 49.3 AV | 54.0 | -4.7 | 1.39 H | 349 | 30.8 | 18.5 |

ANTENNA POLARITY & TEST DISTANCE: VERTICAL AT 3 M

| NO. | FREQ. (MHz) | EMISSION LEVEL (dBuV/m) | LIMIT (dBuV/m) | MARGIN (dB) | ANTENNA HEIGHT (m) | TABLE ANGLE (Degree) | RAW VALUE (dBuV) | CORRECTION FACTOR (dB/m) |
|-----|-------------|-------------------------|----------------|-------------|--------------------|----------------------|------------------|--------------------------|
| 1 | *5550.00 | 102.7 PK | | | 2.62 V | 261 | 62.7 | 40.0 |
| 2 | *5550.00 | 93.4 AV | | | 2.62 V | 261 | 53.4 | 40.0 |
| 3 | 11000.00 | 61.8 PK | 74.0 | -12.2 | 2.03 V | 290 | 42.8 | 19.0 |
| 4 | 11000.00 | 48.9 AV | 54.0 | -5.1 | 2.03 V | 290 | 29.9 | 19.0 |

Remarks:

1. Emission Level(dBuV/m) = Raw Value(dBuV) + Correction Factor(dB/m)
2. Correction Factor(dB/m) = Antenna Factor(dB/m) + Cable Factor(dB) – Pre-Amplifier Factor(dB)
3. The other emission levels were very low against the limit.
4. Margin value = Emission Level – Limit value
5. " * ": Fundamental frequency.
6. " # ": The radiated frequency is out of the restricted band.

| | | | |
|-----------------|----------------|-------------------|--------------|
| CHANNEL | TX Channel 134 | DETECTOR FUNCTION | Peak (PK) |
| FREQUENCY RANGE | 1GHz ~ 40GHz | | Average (AV) |

ANTENNA POLARITY & TEST DISTANCE: HORIZONTAL AT 3 M

| NO. | FREQ. (MHz) | EMISSION LEVEL (dBuV/m) | LIMIT (dBuV/m) | MARGIN (dB) | ANTENNA HEIGHT (m) | TABLE ANGLE (Degree) | RAW VALUE (dBuV) | CORRECTION FACTOR (dB/m) |
|-----|-------------|-------------------------|----------------|-------------|--------------------|----------------------|------------------|--------------------------|
| 1 | *5670.00 | 121.9 PK | | | 1.82 H | 349 | 81.6 | 40.3 |
| 2 | *5670.00 | 112.4 AV | | | 1.82 H | 349 | 72.1 | 40.3 |
| 3 | #5725.00 | 64.4 PK | 74.0 | -9.6 | 1.79 H | 349 | 59.9 | 4.5 |
| 4 | #5725.00 | 52.3 AV | 54.0 | -1.7 | 1.79 H | 349 | 47.8 | 4.5 |
| 5 | 11340.00 | 62.2 PK | 74.0 | -11.8 | 1.45 H | 342 | 43.8 | 18.4 |
| 6 | 11340.00 | 49.3 AV | 54.0 | -4.7 | 1.45 H | 342 | 30.9 | 18.4 |

ANTENNA POLARITY & TEST DISTANCE: VERTICAL AT 3 M

| NO. | FREQ. (MHz) | EMISSION LEVEL (dBuV/m) | LIMIT (dBuV/m) | MARGIN (dB) | ANTENNA HEIGHT (m) | TABLE ANGLE (Degree) | RAW VALUE (dBuV) | CORRECTION FACTOR (dB/m) |
|-----|-------------|-------------------------|----------------|-------------|--------------------|----------------------|------------------|--------------------------|
| 1 | *5670.00 | 102.0 PK | | | 2.76 V | 263 | 61.7 | 40.3 |
| 2 | *5670.00 | 92.5 AV | | | 2.76 V | 263 | 52.2 | 40.3 |
| 3 | #5725.00 | 58.8 PK | 74.0 | -15.2 | 2.59 V | 281 | 54.3 | 4.5 |
| 4 | #5725.00 | 46.9 AV | 54.0 | -7.1 | 2.59 V | 281 | 42.4 | 4.5 |
| 5 | 11340.00 | 60.9 PK | 74.0 | -13.1 | 2.29 V | 224 | 42.5 | 18.4 |
| 6 | 11340.00 | 48.0 AV | 54.0 | -6.0 | 2.29 V | 224 | 29.6 | 18.4 |

Remarks:

1. Emission Level(dBuV/m) = Raw Value(dBuV) + Correction Factor(dB/m)
2. Correction Factor(dB/m) = Antenna Factor(dB/m) + Cable Factor(dB) – Pre-Amplifier Factor(dB)
3. The other emission levels were very low against the limit.
4. Margin value = Emission Level – Limit value
5. " * ": Fundamental frequency.
6. " # ": The radiated frequency is out of the restricted band.

| | | | |
|-----------------|----------------|----------------------|--------------|
| CHANNEL | TX Channel 142 | DETECTOR FUNCTION | Peak (PK) |
| FREQUENCY RANGE | 1GHz ~ 40GHz | | Average (AV) |

| ANTENNA POLARITY & TEST DISTANCE: HORIZONTAL AT 3 M | | | | | | | | |
|---|----------------|-------------------------------|-------------------|----------------|--------------------------|----------------------------|------------------------|--------------------------------|
| NO. | FREQ. (MHz) | EMISSION LEVEL (dBuV/m) | LIMIT (dBuV/m) | MARGIN (dB) | ANTENNA HEIGHT (m) | TABLE ANGLE (Degree) | RAW VALUE (dBuV) | CORRECTION FACTOR (dB/m) |
| 1 | #5470.00 | 56.0 PK | 74.0 | -18.0 | 1.69 H | 203 | 52.0 | 4.0 |
| 2 | #5470.00 | 43.8 AV | 54.0 | -10.2 | 1.69 H | 203 | 39.8 | 4.0 |
| 3 | *5710.00 | 123.0 PK | | | 1.76 H | 347 | 82.6 | 40.4 |
| 4 | *5710.00 | 113.2 AV | | | 1.76 H | 347 | 72.8 | 40.4 |
| 5 | #5825.00 | 57.0 PK | 74.0 | -17.0 | 1.77 H | 193 | 52.3 | 4.7 |
| 6 | #5825.00 | 44.4 AV | 54.0 | -9.6 | 1.77 H | 193 | 39.7 | 4.7 |
| 7 | 11420.00 | 61.0 PK | 74.0 | -13.0 | 1.93 H | 321 | 42.8 | 18.2 |
| 8 | 11420.00 | 48.2 AV | 54.0 | -5.8 | 1.93 H | 321 | 30.0 | 18.2 |

| ANTENNA POLARITY & TEST DISTANCE: VERTICAL AT 3 M | | | | | | | | |
|---|----------------|-------------------------------|-------------------|----------------|--------------------------|----------------------------|------------------------|--------------------------------|
| NO. | FREQ. (MHz) | EMISSION LEVEL (dBuV/m) | LIMIT (dBuV/m) | MARGIN (dB) | ANTENNA HEIGHT (m) | TABLE ANGLE (Degree) | RAW VALUE (dBuV) | CORRECTION FACTOR (dB/m) |
| 1 | #5470.00 | 55.8 PK | 74.0 | -18.2 | 2.19 V | 329 | 51.8 | 4.0 |
| 2 | #5470.00 | 42.5 AV | 54.0 | -11.5 | 2.19 V | 329 | 38.5 | 4.0 |
| 3 | *5710.00 | 104.1 PK | | | 2.54 V | 300 | 63.7 | 40.4 |
| 4 | *5710.00 | 94.4 AV | | | 2.54 V | 300 | 54.0 | 40.4 |
| 5 | #5825.00 | 56.8 PK | 74.0 | -17.2 | 2.17 V | 289 | 52.1 | 4.7 |
| 6 | #5825.00 | 43.3 AV | 54.0 | -10.7 | 2.17 V | 289 | 38.6 | 4.7 |
| 7 | 11420.00 | 61.4 PK | 74.0 | -12.6 | 1.93 V | 333 | 43.2 | 18.2 |
| 8 | 11420.00 | 47.6 AV | 54.0 | -6.4 | 1.93 V | 333 | 29.4 | 18.2 |

Remarks:

1. Emission Level(dBuV/m) = Raw Value(dBuV) + Correction Factor(dB/m)
2. Correction Factor(dB/m) = Antenna Factor(dB/m) + Cable Factor(dB) – Pre-Amplifier Factor(dB)
3. The other emission levels were very low against the limit.
4. Margin value = Emission Level – Limit value
5. " * ": Fundamental frequency.
6. " # ": The radiated frequency is out of the restricted band.

802.11ac (VHT80)

| | | | |
|-----------------|---------------|----------------------|--------------|
| CHANNEL | TX Channel 58 | DETECTOR FUNCTION | Peak (PK) |
| FREQUENCY RANGE | 1GHz ~ 40GHz | | Average (AV) |

| ANTENNA POLARITY & TEST DISTANCE: HORIZONTAL AT 3 M | | | | | | | | |
|---|----------------|-------------------------------|-------------------|----------------|--------------------------|----------------------------|------------------------|--------------------------------|
| NO. | FREQ. (MHz) | EMISSION LEVEL (dBuV/m) | LIMIT (dBuV/m) | MARGIN (dB) | ANTENNA HEIGHT (m) | TABLE ANGLE (Degree) | RAW VALUE (dBuV) | CORRECTION FACTOR (dB/m) |
| 1 | 5150.00 | 56.3 PK | 74.0 | -17.7 | 2.07 H | 162 | 52.7 | 3.6 |
| 2 | 5150.00 | 45.3 AV | 54.0 | -8.7 | 2.07 H | 162 | 41.7 | 3.6 |
| 3 | *5290.00 | 111.9 PK | | | 1.84 H | 347 | 72.3 | 39.6 |
| 4 | *5290.00 | 102.0 AV | | | 1.84 H | 347 | 62.4 | 39.6 |
| 5 | 5350.00 | 66.8 PK | 74.0 | -7.2 | 1.89 H | 346 | 62.9 | 3.9 |
| 6 | 5350.00 | 52.3 AV | 54.0 | -1.7 | 1.89 H | 346 | 48.4 | 3.9 |
| 7 | #10580.00 | 58.2 PK | 74.0 | -15.8 | 2.20 H | 47 | 41.0 | 17.2 |
| 8 | #10580.00 | 44.9 AV | 54.0 | -9.1 | 2.20 H | 47 | 27.7 | 17.2 |
| ANTENNA POLARITY & TEST DISTANCE: VERTICAL AT 3 M | | | | | | | | |
| NO. | FREQ. (MHz) | EMISSION LEVEL (dBuV/m) | LIMIT (dBuV/m) | MARGIN (dB) | ANTENNA HEIGHT (m) | TABLE ANGLE (Degree) | RAW VALUE (dBuV) | CORRECTION FACTOR (dB/m) |
| 1 | 5150.00 | 56.1 PK | 74.0 | -17.9 | 2.39 V | 229 | 52.5 | 3.6 |
| 2 | 5150.00 | 44.9 AV | 54.0 | -9.1 | 2.39 V | 229 | 41.3 | 3.6 |
| 3 | *5290.00 | 92.1 PK | | | 2.78 V | 221 | 52.5 | 39.6 |
| 4 | *5290.00 | 82.1 AV | | | 2.78 V | 221 | 42.5 | 39.6 |
| 5 | 5350.00 | 56.0 PK | 74.0 | -18.0 | 2.55 V | 222 | 52.1 | 3.9 |
| 6 | 5350.00 | 44.4 AV | 54.0 | -9.6 | 2.55 V | 222 | 40.5 | 3.9 |
| 7 | #10580.00 | 57.5 PK | 74.0 | -16.5 | 2.23 V | 284 | 40.3 | 17.2 |
| 8 | #10580.00 | 44.7 AV | 54.0 | -9.3 | 2.23 V | 284 | 27.5 | 17.2 |

Remarks:

1. Emission Level(dBuV/m) = Raw Value(dBuV) + Correction Factor(dB/m)
2. Correction Factor(dB/m) = Antenna Factor(dB/m) + Cable Factor(dB) – Pre-Amplifier Factor(dB)
3. The other emission levels were very low against the limit.
4. Margin value = Emission Level – Limit value
5. " * ": Fundamental frequency.
6. " # ": The radiated frequency is out of the restricted band.

| | | | |
|-----------------|----------------|----------------------|--------------|
| CHANNEL | TX Channel 106 | DETECTOR FUNCTION | Peak (PK) |
| FREQUENCY RANGE | 1GHz ~ 40GHz | | Average (AV) |

ANTENNA POLARITY & TEST DISTANCE: HORIZONTAL AT 3 M

| NO. | FREQ. (MHz) | EMISSION LEVEL (dBuV/m) | LIMIT (dBuV/m) | MARGIN (dB) | ANTENNA HEIGHT (m) | TABLE ANGLE (Degree) | RAW VALUE (dBuV) | CORRECTION FACTOR (dB/m) |
|-----|----------------|-------------------------------|-------------------|----------------|--------------------------|----------------------------|------------------------|--------------------------------|
| 1 | 5460.00 | 69.3 PK | 74.0 | -4.7 | 1.70 H | 347 | 65.3 | 4.0 |
| 2 | 5460.00 | 52.4 AV | 54.0 | -1.6 | 1.70 H | 347 | 48.4 | 4.0 |
| 3 | #5470.00 | 58.5 PK | 74.0 | -15.5 | 1.66 H | 346 | 54.5 | 4.0 |
| 4 | #5470.00 | 46.2 AV | 54.0 | -7.8 | 1.66 H | 346 | 42.2 | 4.0 |
| 5 | *5530.00 | 110.9 PK | | | 1.81 H | 347 | 70.9 | 40.0 |
| 6 | *5530.00 | 100.3 AV | | | 1.81 H | 347 | 60.3 | 40.0 |
| 7 | #5725.00 | 57.3 PK | 74.0 | -16.7 | 1.78 H | 355 | 52.8 | 4.5 |
| 8 | #5725.00 | 46.1 AV | 54.0 | -7.9 | 1.78 H | 355 | 41.6 | 4.5 |
| 9 | 11060.00 | 60.1 PK | 74.0 | -13.9 | 1.30 H | 355 | 41.5 | 18.6 |
| 10 | 11060.00 | 46.8 AV | 54.0 | -7.2 | 1.30 H | 355 | 28.2 | 18.6 |

ANTENNA POLARITY & TEST DISTANCE: VERTICAL AT 3 M

| NO. | FREQ. (MHz) | EMISSION LEVEL (dBuV/m) | LIMIT (dBuV/m) | MARGIN (dB) | ANTENNA HEIGHT (m) | TABLE ANGLE (Degree) | RAW VALUE (dBuV) | CORRECTION FACTOR (dB/m) |
|-----|----------------|-------------------------------|-------------------|----------------|--------------------------|----------------------------|------------------------|--------------------------------|
| 1 | 5460.00 | 55.7 PK | 74.0 | -18.3 | 2.60 V | 277 | 51.7 | 4.0 |
| 2 | 5460.00 | 44.5 AV | 54.0 | -9.5 | 2.60 V | 277 | 40.5 | 4.0 |
| 3 | #5470.00 | 56.3 PK | 74.0 | -17.7 | 2.55 V | 255 | 52.3 | 4.0 |
| 4 | #5470.00 | 44.9 AV | 54.0 | -9.1 | 2.55 V | 255 | 40.9 | 4.0 |
| 5 | *5530.00 | 91.4 PK | | | 2.80 V | 360 | 51.4 | 40.0 |
| 6 | *5530.00 | 81.7 AV | | | 2.80 V | 360 | 41.7 | 40.0 |
| 7 | #5725.00 | 56.4 PK | 74.0 | -17.6 | 2.70 V | 249 | 51.9 | 4.5 |
| 8 | #5725.00 | 45.2 AV | 54.0 | -8.8 | 2.70 V | 249 | 40.7 | 4.5 |
| 9 | 10600.00 | 58.8 PK | 74.0 | -15.2 | 2.13 V | 177 | 41.7 | 17.1 |
| 10 | 10600.00 | 45.6 AV | 54.0 | -8.4 | 2.13 V | 177 | 28.5 | 17.1 |

Remarks:

1. Emission Level(dBuV/m) = Raw Value(dBuV) + Correction Factor(dB/m)
2. Correction Factor(dB/m) = Antenna Factor(dB/m) + Cable Factor(dB) – Pre-Amplifier Factor(dB)
3. The other emission levels were very low against the limit.
4. Margin value = Emission Level – Limit value
5. " * ": Fundamental frequency.
6. " # ": The radiated frequency is out of the restricted band.

| | | | |
|-----------------|----------------|----------------------|--------------|
| CHANNEL | TX Channel 122 | DETECTOR FUNCTION | Peak (PK) |
| FREQUENCY RANGE | 1GHz ~ 40GHz | | Average (AV) |

ANTENNA POLARITY & TEST DISTANCE: HORIZONTAL AT 3 M

| NO. | FREQ. (MHz) | EMISSION LEVEL (dBuV/m) | LIMIT (dBuV/m) | MARGIN (dB) | ANTENNA HEIGHT (m) | TABLE ANGLE (Degree) | RAW VALUE (dBuV) | CORRECTION FACTOR (dB/m) |
|-----|----------------|-------------------------------|-------------------|----------------|--------------------------|----------------------------|------------------------|--------------------------------|
| 1 | 5460.00 | 61.5 PK | 74.0 | -12.5 | 1.81 H | 193 | 57.5 | 4.0 |
| 2 | 5460.00 | 48.0 AV | 54.0 | -6.0 | 1.81 H | 193 | 44.0 | 4.0 |
| 3 | #5470.00 | 67.0 PK | 74.0 | -7.0 | 1.75 H | 174 | 63.0 | 4.0 |
| 4 | #5470.00 | 52.1 AV | 54.0 | -1.9 | 1.75 H | 174 | 48.1 | 4.0 |
| 5 | *5610.00 | 119.0 PK | | | 1.76 H | 173 | 78.8 | 40.2 |
| 6 | *5610.00 | 108.3 AV | | | 1.76 H | 173 | 68.1 | 40.2 |
| 7 | #5725.00 | 66.9 PK | 74.0 | -7.1 | 1.74 H | 173 | 62.4 | 4.5 |
| 8 | #5725.00 | 52.8 AV | 54.0 | -1.2 | 1.74 H | 173 | 48.3 | 4.5 |
| 9 | 11220.00 | 61.0 PK | 74.0 | -13.0 | 1.88 H | 193 | 42.1 | 18.9 |
| 10 | 11220.00 | 47.7 AV | 54.0 | -6.3 | 1.88 H | 193 | 28.8 | 18.9 |

ANTENNA POLARITY & TEST DISTANCE: VERTICAL AT 3 M

| NO. | FREQ. (MHz) | EMISSION LEVEL (dBuV/m) | LIMIT (dBuV/m) | MARGIN (dB) | ANTENNA HEIGHT (m) | TABLE ANGLE (Degree) | RAW VALUE (dBuV) | CORRECTION FACTOR (dB/m) |
|-----|----------------|-------------------------------|-------------------|----------------|--------------------------|----------------------------|------------------------|--------------------------------|
| 1 | 5460.00 | 54.0 PK | 74.0 | -20.0 | 2.99 V | 321 | 50.0 | 4.0 |
| 2 | 5460.00 | 42.4 AV | 54.0 | -11.6 | 2.99 V | 321 | 38.4 | 4.0 |
| 3 | #5470.00 | 56.0 PK | 74.0 | -18.0 | 3.03 V | 311 | 52.0 | 4.0 |
| 4 | #5470.00 | 42.7 AV | 54.0 | -11.3 | 3.03 V | 311 | 38.7 | 4.0 |
| 5 | *5610.00 | 98.5 PK | | | 3.17 V | 298 | 58.3 | 40.2 |
| 6 | *5610.00 | 89.4 AV | | | 3.17 V | 298 | 49.2 | 40.2 |
| 7 | #5725.00 | 56.5 PK | 74.0 | -17.5 | 2.97 V | 287 | 52.0 | 4.5 |
| 8 | #5725.00 | 43.2 AV | 54.0 | -10.8 | 2.97 V | 287 | 38.7 | 4.5 |
| 9 | 11220.00 | 60.4 PK | 74.0 | -13.6 | 1.77 V | 193 | 41.5 | 18.9 |
| 10 | 11220.00 | 47.5 AV | 54.0 | -6.5 | 1.77 V | 193 | 28.6 | 18.9 |

Remarks:

1. Emission Level(dBuV/m) = Raw Value(dBuV) + Correction Factor(dB/m)
2. Correction Factor(dB/m) = Antenna Factor(dB/m) + Cable Factor(dB) – Pre-Amplifier Factor(dB)
3. The other emission levels were very low against the limit.
4. Margin value = Emission Level – Limit value
5. " * ": Fundamental frequency.
6. " # ": The radiated frequency is out of the restricted band.

| | | | |
|-----------------|----------------|-------------------|--------------|
| CHANNEL | TX Channel 138 | DETECTOR FUNCTION | Peak (PK) |
| FREQUENCY RANGE | 1GHz ~ 40GHz | | Average (AV) |

ANTENNA POLARITY & TEST DISTANCE: HORIZONTAL AT 3 M

| NO. | FREQ. (MHz) | EMISSION LEVEL (dBuV/m) | LIMIT (dBuV/m) | MARGIN (dB) | ANTENNA HEIGHT (m) | TABLE ANGLE (Degree) | RAW VALUE (dBuV) | CORRECTION FACTOR (dB/m) |
|-----|-------------|-------------------------|----------------|-------------|--------------------|----------------------|------------------|--------------------------|
| 1 | #5470.00 | 59.1 PK | 74.0 | -14.9 | 1.82 H | 346 | 55.1 | 4.0 |
| 2 | #5470.00 | 49.3 AV | 54.0 | -4.7 | 1.82 H | 346 | 45.3 | 4.0 |
| 3 | *5690.00 | 119.6 PK | | | 1.67 H | 173 | 79.3 | 40.3 |
| 4 | *5690.00 | 109.7 AV | | | 1.67 H | 173 | 69.4 | 40.3 |
| 5 | #5825.00 | 65.4 PK | 74.0 | -8.6 | 1.73 H | 173 | 60.7 | 4.7 |
| 6 | #5825.00 | 52.0 AV | 54.0 | -2.0 | 1.73 H | 173 | 47.3 | 4.7 |
| 7 | 11380.00 | 60.7 PK | 74.0 | -13.3 | 1.79 H | 315 | 42.4 | 18.3 |
| 8 | 11380.00 | 47.4 AV | 54.0 | -6.6 | 1.79 H | 315 | 29.1 | 18.3 |

ANTENNA POLARITY & TEST DISTANCE: VERTICAL AT 3 M

| NO. | FREQ. (MHz) | EMISSION LEVEL (dBuV/m) | LIMIT (dBuV/m) | MARGIN (dB) | ANTENNA HEIGHT (m) | TABLE ANGLE (Degree) | RAW VALUE (dBuV) | CORRECTION FACTOR (dB/m) |
|-----|-------------|-------------------------|----------------|-------------|--------------------|----------------------|------------------|--------------------------|
| 1 | #5470.00 | 55.7 PK | 74.0 | -18.3 | 1.33 V | 311 | 51.7 | 4.0 |
| 2 | #5470.00 | 42.4 AV | 54.0 | -11.6 | 1.33 V | 311 | 38.4 | 4.0 |
| 3 | *5690.00 | 100.9 PK | | | 1.11 V | 301 | 60.6 | 40.3 |
| 4 | *5690.00 | 90.1 AV | | | 1.11 V | 301 | 49.8 | 40.3 |
| 5 | #5825.00 | 56.4 PK | 74.0 | -17.6 | 1.11 V | 293 | 51.7 | 4.7 |
| 6 | #5825.00 | 33.4 AV | 54.0 | -20.6 | 1.11 V | 293 | 28.7 | 4.7 |
| 7 | 11380.00 | 61.0 PK | 74.0 | -13.0 | 1.44 V | 297 | 42.7 | 18.3 |
| 8 | 11380.00 | 47.6 AV | 54.0 | -6.4 | 1.44 V | 297 | 29.3 | 18.3 |

Remarks:

1. Emission Level(dBuV/m) = Raw Value(dBuV) + Correction Factor(dB/m)
2. Correction Factor(dB/m) = Antenna Factor(dB/m) + Cable Factor(dB) – Pre-Amplifier Factor(dB)
3. The other emission levels were very low against the limit.
4. Margin value = Emission Level – Limit value
5. " * ": Fundamental frequency.
6. " # ": The radiated frequency is out of the restricted band.

Mode B2

802.11a

| | | | |
|-----------------|---------------|----------------------|--------------|
| CHANNEL | TX Channel 52 | DETECTOR FUNCTION | Peak (PK) |
| FREQUENCY RANGE | 1GHz ~ 40GHz | | Average (AV) |

ANTENNA POLARITY & TEST DISTANCE: HORIZONTAL AT 3 M

| NO. | FREQ. (MHz) | EMISSION LEVEL (dBuV/m) | LIMIT (dBuV/m) | MARGIN (dB) | ANTENNA HEIGHT (m) | TABLE ANGLE (Degree) | RAW VALUE (dBuV) | CORRECTION FACTOR (dB/m) |
|-----|----------------|-------------------------------|-------------------|----------------|--------------------------|----------------------------|------------------------|--------------------------------|
| 1 | 5150.00 | 58.2 PK | 74.0 | -15.8 | 1.70 H | 1 | 54.6 | 3.6 |
| 2 | 5150.00 | 46.6 AV | 54.0 | -7.4 | 1.70 H | 1 | 43.0 | 3.6 |
| 3 | *5260.00 | 118.8 PK | | | 1.62 H | 352 | 79.2 | 39.6 |
| 4 | *5260.00 | 108.4 AV | | | 1.62 H | 352 | 68.8 | 39.6 |
| 5 | #10520.00 | 59.6 PK | 74.0 | -14.4 | 2.03 H | 16 | 42.6 | 17.0 |
| 6 | #10520.00 | 46.5 AV | 54.0 | -7.5 | 2.03 H | 16 | 29.5 | 17.0 |

ANTENNA POLARITY & TEST DISTANCE: VERTICAL AT 3 M

| NO. | FREQ. (MHz) | EMISSION LEVEL (dBuV/m) | LIMIT (dBuV/m) | MARGIN (dB) | ANTENNA HEIGHT (m) | TABLE ANGLE (Degree) | RAW VALUE (dBuV) | CORRECTION FACTOR (dB/m) |
|-----|----------------|-------------------------------|-------------------|----------------|--------------------------|----------------------------|------------------------|--------------------------------|
| 1 | 5150.00 | 56.3 PK | 74.0 | -17.7 | 1.88 V | 349 | 52.7 | 3.6 |
| 2 | 5150.00 | 45.2 AV | 54.0 | -8.8 | 1.88 V | 349 | 41.6 | 3.6 |
| 3 | *5260.00 | 117.4 PK | | | 1.90 V | 344 | 77.8 | 39.6 |
| 4 | *5260.00 | 107.1 AV | | | 1.90 V | 344 | 67.5 | 39.6 |
| 5 | #10520.00 | 58.4 PK | 74.0 | -15.6 | 1.53 V | 267 | 41.4 | 17.0 |
| 6 | #10520.00 | 45.7 AV | 54.0 | -8.3 | 1.53 V | 267 | 28.7 | 17.0 |

Remarks:

1. Emission Level(dBuV/m) = Raw Value(dBuV) + Correction Factor(dB/m)
2. Correction Factor(dB/m) = Antenna Factor(dB/m) + Cable Factor(dB) – Pre-Amplifier Factor(dB)
3. The other emission levels were very low against the limit.
4. Margin value = Emission Level – Limit value
5. " * ": Fundamental frequency.
6. " # ": The radiated frequency is out of the restricted band.

| | | | |
|-----------------|---------------|----------|--------------|
| CHANNEL | TX Channel 60 | DETECTOR | Peak (PK) |
| FREQUENCY RANGE | 1GHz ~ 40GHz | FUNCTION | Average (AV) |

ANTENNA POLARITY & TEST DISTANCE: HORIZONTAL AT 3 M

| NO. | FREQ. (MHz) | EMISSION LEVEL (dBuV/m) | LIMIT (dBuV/m) | MARGIN (dB) | ANTENNA HEIGHT (m) | TABLE ANGLE (Degree) | RAW VALUE (dBuV) | CORRECTION FACTOR (dB/m) |
|-----|-------------|-------------------------|----------------|-------------|--------------------|----------------------|------------------|--------------------------|
| 1 | *5300.00 | 118.4 PK | | | 1.68 H | 349 | 78.8 | 39.6 |
| 2 | *5300.00 | 107.7 AV | | | 1.68 H | 349 | 68.1 | 39.6 |
| 3 | 10600.00 | 59.4 PK | 74.0 | -14.6 | 2.05 H | 34 | 42.3 | 17.1 |
| 4 | 10600.00 | 46.3 AV | 54.0 | -7.7 | 2.05 H | 34 | 29.2 | 17.1 |

ANTENNA POLARITY & TEST DISTANCE: VERTICAL AT 3 M

| NO. | FREQ. (MHz) | EMISSION LEVEL (dBuV/m) | LIMIT (dBuV/m) | MARGIN (dB) | ANTENNA HEIGHT (m) | TABLE ANGLE (Degree) | RAW VALUE (dBuV) | CORRECTION FACTOR (dB/m) |
|-----|-------------|-------------------------|----------------|-------------|--------------------|----------------------|------------------|--------------------------|
| 1 | *5300.00 | 117.6 PK | | | 1.98 V | 345 | 78.0 | 39.6 |
| 2 | *5300.00 | 106.6 AV | | | 1.98 V | 345 | 67.0 | 39.6 |
| 3 | 10600.00 | 58.1 PK | 74.0 | -15.9 | 1.44 V | 288 | 41.0 | 17.1 |
| 4 | 10600.00 | 45.3 AV | 54.0 | -8.7 | 1.44 V | 288 | 28.2 | 17.1 |

Remarks:

1. Emission Level(dBuV/m) = Raw Value(dBuV) + Correction Factor(dB/m)
2. Correction Factor(dB/m) = Antenna Factor(dB/m) + Cable Factor(dB) – Pre-Amplifier Factor(dB)
3. The other emission levels were very low against the limit.
4. Margin value = Emission Level – Limit value
5. " * ": Fundamental frequency.
6. " # ": The radiated frequency is out of the restricted band.

| | | | |
|-----------------|---------------|----------------------|--------------|
| CHANNEL | TX Channel 64 | DETECTOR FUNCTION | Peak (PK) |
| FREQUENCY RANGE | 1GHz ~ 40GHz | | Average (AV) |

ANTENNA POLARITY & TEST DISTANCE: HORIZONTAL AT 3 M

| NO. | FREQ. (MHz) | EMISSION LEVEL (dBuV/m) | LIMIT (dBuV/m) | MARGIN (dB) | ANTENNA HEIGHT (m) | TABLE ANGLE (Degree) | RAW VALUE (dBuV) | CORRECTION FACTOR (dB/m) |
|-----|----------------|-------------------------------|-------------------|----------------|--------------------------|----------------------------|------------------------|--------------------------------|
| 1 | *5320.00 | 118.6 PK | | | 1.67 H | 350 | 78.9 | 39.7 |
| 2 | *5320.00 | 108.1 AV | | | 1.67 H | 350 | 68.4 | 39.7 |
| 3 | 5350.00 | 59.5 PK | 74.0 | -14.5 | 1.75 H | 352 | 55.6 | 3.9 |
| 4 | 5350.00 | 48.3 AV | 54.0 | -5.7 | 1.75 H | 352 | 44.4 | 3.9 |
| 5 | 10640.00 | 59.5 PK | 74.0 | -14.5 | 2.07 H | 35 | 42.2 | 17.3 |
| 6 | 10640.00 | 46.3 AV | 54.0 | -7.7 | 2.07 H | 35 | 29.0 | 17.3 |

ANTENNA POLARITY & TEST DISTANCE: VERTICAL AT 3 M

| NO. | FREQ. (MHz) | EMISSION LEVEL (dBuV/m) | LIMIT (dBuV/m) | MARGIN (dB) | ANTENNA HEIGHT (m) | TABLE ANGLE (Degree) | RAW VALUE (dBuV) | CORRECTION FACTOR (dB/m) |
|-----|----------------|-------------------------------|-------------------|----------------|--------------------------|----------------------------|------------------------|--------------------------------|
| 1 | *5320.00 | 117.1 PK | | | 1.92 V | 346 | 77.4 | 39.7 |
| 2 | *5320.00 | 107.0 AV | | | 1.92 V | 346 | 67.3 | 39.7 |
| 3 | 5350.00 | 55.7 PK | 74.0 | -18.3 | 1.98 V | 294 | 51.8 | 3.9 |
| 4 | 5350.00 | 45.0 AV | 54.0 | -9.0 | 1.98 V | 294 | 41.1 | 3.9 |
| 5 | 10640.00 | 59.1 PK | 74.0 | -14.9 | 1.47 V | 301 | 41.8 | 17.3 |
| 6 | 10640.00 | 45.3 AV | 54.0 | -8.7 | 1.47 V | 301 | 28.0 | 17.3 |

Remarks:

1. Emission Level(dBuV/m) = Raw Value(dBuV) + Correction Factor(dB/m)
2. Correction Factor(dB/m) = Antenna Factor(dB/m) + Cable Factor(dB) – Pre-Amplifier Factor(dB)
3. The other emission levels were very low against the limit.
4. Margin value = Emission Level – Limit value
5. " * ": Fundamental frequency.
6. " # ": The radiated frequency is out of the restricted band.

| | | | |
|-----------------|----------------|----------|--------------|
| CHANNEL | TX Channel 100 | DETECTOR | Peak (PK) |
| FREQUENCY RANGE | 1GHz ~ 40GHz | FUNCTION | Average (AV) |

| ANTENNA POLARITY & TEST DISTANCE: HORIZONTAL AT 3 M | | | | | | | | |
|---|-------------|-------------------------|----------------|-------------|--------------------|----------------------|------------------|--------------------------|
| NO. | FREQ. (MHz) | EMISSION LEVEL (dBuV/m) | LIMIT (dBuV/m) | MARGIN (dB) | ANTENNA HEIGHT (m) | TABLE ANGLE (Degree) | RAW VALUE (dBuV) | CORRECTION FACTOR (dB/m) |
| 1 | 5460.00 | 58.0 PK | 74.0 | -16.0 | 1.70 H | 347 | 54.0 | 4.0 |
| 2 | 5460.00 | 45.3 AV | 54.0 | -8.7 | 1.70 H | 347 | 41.3 | 4.0 |
| 3 | #5470.00 | 58.3 PK | 74.0 | -15.7 | 1.73 H | 353 | 54.3 | 4.0 |
| 4 | #5470.00 | 46.7 AV | 54.0 | -7.3 | 1.73 H | 353 | 42.7 | 4.0 |
| 5 | *5500.00 | 118.7 PK | | | 1.65 H | 350 | 78.7 | 40.0 |
| 6 | *5500.00 | 108.2 AV | | | 1.65 H | 350 | 68.2 | 40.0 |
| 7 | 11000.00 | 61.5 PK | 74.0 | -12.5 | 1.88 H | 35 | 42.5 | 19.0 |
| 8 | 11000.00 | 48.3 AV | 54.0 | -5.7 | 1.88 H | 35 | 29.3 | 19.0 |

| ANTENNA POLARITY & TEST DISTANCE: VERTICAL AT 3 M | | | | | | | | |
|---|-------------|-------------------------|----------------|-------------|--------------------|----------------------|------------------|--------------------------|
| NO. | FREQ. (MHz) | EMISSION LEVEL (dBuV/m) | LIMIT (dBuV/m) | MARGIN (dB) | ANTENNA HEIGHT (m) | TABLE ANGLE (Degree) | RAW VALUE (dBuV) | CORRECTION FACTOR (dB/m) |
| 1 | 5460.00 | 54.9 PK | 74.0 | -19.1 | 1.90 V | 340 | 50.9 | 4.0 |
| 2 | 5460.00 | 44.2 AV | 54.0 | -9.8 | 1.90 V | 340 | 40.2 | 4.0 |
| 3 | #5470.00 | 56.8 PK | 74.0 | -17.2 | 2.00 V | 343 | 52.8 | 4.0 |
| 4 | #5470.00 | 44.8 AV | 54.0 | -9.2 | 2.00 V | 343 | 40.8 | 4.0 |
| 5 | *5500.00 | 117.7 PK | | | 1.98 V | 345 | 77.7 | 40.0 |
| 6 | *5500.00 | 107.7 AV | | | 1.98 V | 345 | 67.7 | 40.0 |
| 7 | 11000.00 | 61.4 PK | 74.0 | -12.6 | 1.88 V | 282 | 42.4 | 19.0 |
| 8 | 11000.00 | 48.6 AV | 54.0 | -5.4 | 1.88 V | 282 | 29.6 | 19.0 |

Remarks:

1. Emission Level(dBuV/m) = Raw Value(dBuV) + Correction Factor(dB/m)
2. Correction Factor(dB/m) = Antenna Factor(dB/m) + Cable Factor(dB) – Pre-Amplifier Factor(dB)
3. The other emission levels were very low against the limit.
4. Margin value = Emission Level – Limit value
5. " * ": Fundamental frequency.
6. " # ": The radiated frequency is out of the restricted band.

| | | | |
|-----------------|----------------|-------------------|--------------|
| CHANNEL | TX Channel 116 | DETECTOR FUNCTION | Peak (PK) |
| FREQUENCY RANGE | 1GHz ~ 40GHz | | Average (AV) |

ANTENNA POLARITY & TEST DISTANCE: HORIZONTAL AT 3 M

| NO. | FREQ. (MHz) | EMISSION LEVEL (dBuV/m) | LIMIT (dBuV/m) | MARGIN (dB) | ANTENNA HEIGHT (m) | TABLE ANGLE (Degree) | RAW VALUE (dBuV) | CORRECTION FACTOR (dB/m) |
|-----|-------------|-------------------------|----------------|-------------|--------------------|----------------------|------------------|--------------------------|
| 1 | *5580.00 | 119.0 PK | | | 1.66 H | 351 | 78.9 | 40.1 |
| 2 | *5580.00 | 108.4 AV | | | 1.66 H | 351 | 68.3 | 40.1 |
| 3 | 11160.00 | 60.7 PK | 74.0 | -13.3 | 1.96 H | 51 | 42.0 | 18.7 |
| 4 | 11160.00 | 48.1 AV | 54.0 | -5.9 | 1.96 H | 51 | 29.4 | 18.7 |

ANTENNA POLARITY & TEST DISTANCE: VERTICAL AT 3 M

| NO. | FREQ. (MHz) | EMISSION LEVEL (dBuV/m) | LIMIT (dBuV/m) | MARGIN (dB) | ANTENNA HEIGHT (m) | TABLE ANGLE (Degree) | RAW VALUE (dBuV) | CORRECTION FACTOR (dB/m) |
|-----|-------------|-------------------------|----------------|-------------|--------------------|----------------------|------------------|--------------------------|
| 1 | *5580.00 | 118.0 PK | | | 1.98 V | 345 | 77.9 | 40.1 |
| 2 | *5580.00 | 107.8 AV | | | 1.98 V | 345 | 67.7 | 40.1 |
| 3 | 11160.00 | 61.0 PK | 74.0 | -13.0 | 1.77 V | 279 | 42.3 | 18.7 |
| 4 | 11160.00 | 48.1 AV | 54.0 | -5.9 | 1.77 V | 279 | 29.4 | 18.7 |

Remarks:

1. Emission Level(dBuV/m) = Raw Value(dBuV) + Correction Factor(dB/m)
2. Correction Factor(dB/m) = Antenna Factor(dB/m) + Cable Factor(dB) – Pre-Amplifier Factor(dB)
3. The other emission levels were very low against the limit.
4. Margin value = Emission Level – Limit value
5. " * ": Fundamental frequency.
6. " # ": The radiated frequency is out of the restricted band.

| | | | |
|-----------------|----------------|----------------------|--------------|
| CHANNEL | TX Channel 140 | DETECTOR FUNCTION | Peak (PK) |
| FREQUENCY RANGE | 1GHz ~ 40GHz | | Average (AV) |

ANTENNA POLARITY & TEST DISTANCE: HORIZONTAL AT 3 M

| NO. | FREQ. (MHz) | EMISSION LEVEL (dBuV/m) | LIMIT (dBuV/m) | MARGIN (dB) | ANTENNA HEIGHT (m) | TABLE ANGLE (Degree) | RAW VALUE (dBuV) | CORRECTION FACTOR (dB/m) |
|-----|----------------|-------------------------------|-------------------|----------------|--------------------------|----------------------------|------------------------|--------------------------------|
| 1 | *5700.00 | 119.1 PK | | | 1.66 H | 352 | 78.8 | 40.3 |
| 2 | *5700.00 | 108.6 AV | | | 1.66 H | 352 | 68.3 | 40.3 |
| 3 | #5725.00 | 57.8 PK | 74.0 | -16.2 | 1.71 H | 348 | 53.3 | 4.5 |
| 4 | #5725.00 | 46.6 AV | 54.0 | -7.4 | 1.71 H | 348 | 42.1 | 4.5 |
| 5 | 11400.00 | 60.4 PK | 74.0 | -13.6 | 1.86 H | 20 | 42.2 | 18.2 |
| 6 | 11400.00 | 47.7 AV | 54.0 | -6.3 | 1.86 H | 20 | 29.5 | 18.2 |

ANTENNA POLARITY & TEST DISTANCE: VERTICAL AT 3 M

| NO. | FREQ. (MHz) | EMISSION LEVEL (dBuV/m) | LIMIT (dBuV/m) | MARGIN (dB) | ANTENNA HEIGHT (m) | TABLE ANGLE (Degree) | RAW VALUE (dBuV) | CORRECTION FACTOR (dB/m) |
|-----|----------------|-------------------------------|-------------------|----------------|--------------------------|----------------------------|------------------------|--------------------------------|
| 1 | *5700.00 | 117.2 PK | | | 1.93 V | 351 | 76.9 | 40.3 |
| 2 | *5700.00 | 107.7 AV | | | 1.93 V | 351 | 67.4 | 40.3 |
| 3 | #5725.00 | 59.5 PK | 74.0 | -14.5 | 1.96 V | 345 | 55.0 | 4.5 |
| 4 | #5725.00 | 48.2 AV | 54.0 | -5.8 | 1.96 V | 345 | 43.7 | 4.5 |
| 5 | 11400.00 | 60.8 PK | 74.0 | -13.2 | 1.70 V | 289 | 42.6 | 18.2 |
| 6 | 11400.00 | 47.7 AV | 54.0 | -6.3 | 1.70 V | 289 | 29.5 | 18.2 |

Remarks:

1. Emission Level(dBuV/m) = Raw Value(dBuV) + Correction Factor(dB/m)
2. Correction Factor(dB/m) = Antenna Factor(dB/m) + Cable Factor(dB) – Pre-Amplifier Factor(dB)
3. The other emission levels were very low against the limit.
4. Margin value = Emission Level – Limit value
5. " * ": Fundamental frequency.
6. " # ": The radiated frequency is out of the restricted band.

| | | | |
|-----------------|----------------|----------------------|--------------|
| CHANNEL | TX Channel 144 | DETECTOR FUNCTION | Peak (PK) |
| FREQUENCY RANGE | 1GHz ~ 40GHz | | Average (AV) |

| ANTENNA POLARITY & TEST DISTANCE: HORIZONTAL AT 3 M | | | | | | | | |
|---|----------------|-------------------------------|-------------------|----------------|--------------------------|----------------------------|------------------------|--------------------------------|
| NO. | FREQ. (MHz) | EMISSION LEVEL (dBuV/m) | LIMIT (dBuV/m) | MARGIN (dB) | ANTENNA HEIGHT (m) | TABLE ANGLE (Degree) | RAW VALUE (dBuV) | CORRECTION FACTOR (dB/m) |
| 1 | #5470.00 | 54.6 PK | 74.0 | -19.4 | 1.70 H | 345 | 50.6 | 4.0 |
| 2 | #5470.00 | 43.6 AV | 54.0 | -10.4 | 1.70 H | 345 | 39.6 | 4.0 |
| 3 | *5720.00 | 119.5 PK | | | 1.79 H | 349 | 79.1 | 40.4 |
| 4 | *5720.00 | 108.9 AV | | | 1.79 H | 349 | 68.5 | 40.4 |
| 5 | #5850.00 | 57.0 PK | 74.0 | -17.0 | 1.81 H | 352 | 52.2 | 4.8 |
| 6 | #5850.00 | 46.8 AV | 54.0 | -7.2 | 1.81 H | 352 | 42.0 | 4.8 |
| 7 | 11440.00 | 60.7 PK | 74.0 | -13.3 | 2.22 H | 49 | 42.4 | 18.3 |
| 8 | 11440.00 | 47.7 AV | 54.0 | -6.3 | 2.22 H | 49 | 29.4 | 18.3 |

| ANTENNA POLARITY & TEST DISTANCE: VERTICAL AT 3 M | | | | | | | | |
|---|----------------|-------------------------------|-------------------|----------------|--------------------------|----------------------------|------------------------|--------------------------------|
| NO. | FREQ. (MHz) | EMISSION LEVEL (dBuV/m) | LIMIT (dBuV/m) | MARGIN (dB) | ANTENNA HEIGHT (m) | TABLE ANGLE (Degree) | RAW VALUE (dBuV) | CORRECTION FACTOR (dB/m) |
| 1 | #5470.00 | 56.0 PK | 74.0 | -18.0 | 1.98 V | 348 | 52.0 | 4.0 |
| 2 | #5470.00 | 45.6 AV | 54.0 | -8.4 | 1.98 V | 348 | 41.6 | 4.0 |
| 3 | *5720.00 | 118.3 PK | | | 1.98 V | 348 | 77.9 | 40.4 |
| 4 | *5720.00 | 107.7 AV | | | 1.98 V | 348 | 67.3 | 40.4 |
| 5 | #5850.00 | 57.0 PK | 74.0 | -17.0 | 2.01 V | 343 | 52.2 | 4.8 |
| 6 | #5850.00 | 46.7 AV | 54.0 | -7.3 | 2.01 V | 343 | 41.9 | 4.8 |
| 7 | 11440.00 | 59.9 PK | 74.0 | -14.1 | 1.26 V | 355 | 41.6 | 18.3 |
| 8 | 11440.00 | 46.9 AV | 54.0 | -7.1 | 1.26 V | 355 | 28.6 | 18.3 |

Remarks:

1. Emission Level(dBuV/m) = Raw Value(dBuV) + Correction Factor(dB/m)
2. Correction Factor(dB/m) = Antenna Factor(dB/m) + Cable Factor(dB) – Pre-Amplifier Factor(dB)
3. The other emission levels were very low against the limit.
4. Margin value = Emission Level – Limit value
5. " * ": Fundamental frequency.
6. " # ": The radiated frequency is out of the restricted band.

802.11n (HT20)

| | | | |
|-----------------|---------------|----------------------|--------------|
| CHANNEL | TX Channel 52 | DETECTOR FUNCTION | Peak (PK) |
| FREQUENCY RANGE | 1GHz ~ 40GHz | | Average (AV) |

ANTENNA POLARITY & TEST DISTANCE: HORIZONTAL AT 3 M

| NO. | FREQ. (MHz) | EMISSION LEVEL (dBuV/m) | LIMIT (dBuV/m) | MARGIN (dB) | ANTENNA HEIGHT (m) | TABLE ANGLE (Degree) | RAW VALUE (dBuV) | CORRECTION FACTOR (dB/m) |
|-----|----------------|-------------------------------|-------------------|----------------|--------------------------|----------------------------|------------------------|--------------------------------|
| 1 | 5150.00 | 57.4 PK | 74.0 | -16.6 | 1.70 H | 348 | 53.8 | 3.6 |
| 2 | 5150.00 | 46.1 AV | 54.0 | -7.9 | 1.70 H | 348 | 42.5 | 3.6 |
| 3 | *5260.00 | 119.1 PK | | | 1.67 H | 351 | 79.5 | 39.6 |
| 4 | *5260.00 | 108.0 AV | | | 1.67 H | 351 | 68.4 | 39.6 |
| 5 | #10520.00 | 59.8 PK | 74.0 | -14.2 | 2.08 H | 22 | 42.8 | 17.0 |
| 6 | #10520.00 | 46.7 AV | 54.0 | -7.3 | 2.08 H | 22 | 29.7 | 17.0 |

ANTENNA POLARITY & TEST DISTANCE: VERTICAL AT 3 M

| NO. | FREQ. (MHz) | EMISSION LEVEL (dBuV/m) | LIMIT (dBuV/m) | MARGIN (dB) | ANTENNA HEIGHT (m) | TABLE ANGLE (Degree) | RAW VALUE (dBuV) | CORRECTION FACTOR (dB/m) |
|-----|----------------|-------------------------------|-------------------|----------------|--------------------------|----------------------------|------------------------|--------------------------------|
| 1 | 5150.00 | 56.8 PK | 74.0 | -17.2 | 1.88 V | 349 | 53.2 | 3.6 |
| 2 | 5150.00 | 45.6 AV | 54.0 | -8.4 | 1.88 V | 349 | 42.0 | 3.6 |
| 3 | *5260.00 | 117.5 PK | | | 1.96 V | 345 | 77.9 | 39.6 |
| 4 | *5260.00 | 106.6 AV | | | 1.96 V | 345 | 67.0 | 39.6 |
| 5 | #10520.00 | 59.4 PK | 74.0 | -14.6 | 1.66 V | 298 | 42.4 | 17.0 |
| 6 | #10520.00 | 46.4 AV | 54.0 | -7.6 | 1.66 V | 298 | 29.4 | 17.0 |

Remarks:

1. Emission Level(dBuV/m) = Raw Value(dBuV) + Correction Factor(dB/m)
2. Correction Factor(dB/m) = Antenna Factor(dB/m) + Cable Factor(dB) – Pre-Amplifier Factor(dB)
3. The other emission levels were very low against the limit.
4. Margin value = Emission Level – Limit value
5. " * ": Fundamental frequency.
6. " # ": The radiated frequency is out of the restricted band.

| | | | |
|-----------------|---------------|-------------------|--------------|
| CHANNEL | TX Channel 60 | DETECTOR FUNCTION | Peak (PK) |
| FREQUENCY RANGE | 1GHz ~ 40GHz | | Average (AV) |

ANTENNA POLARITY & TEST DISTANCE: HORIZONTAL AT 3 M

| NO. | FREQ. (MHz) | EMISSION LEVEL (dBuV/m) | LIMIT (dBuV/m) | MARGIN (dB) | ANTENNA HEIGHT (m) | TABLE ANGLE (Degree) | RAW VALUE (dBuV) | CORRECTION FACTOR (dB/m) |
|-----|-------------|-------------------------|----------------|-------------|--------------------|----------------------|------------------|--------------------------|
| 1 | *5300.00 | 118.8 PK | | | 1.68 H | 351 | 79.2 | 39.6 |
| 2 | *5300.00 | 108.0 AV | | | 1.68 H | 351 | 68.4 | 39.6 |
| 3 | 10600.00 | 60.0 PK | 74.0 | -14.0 | 2.10 H | 33 | 42.9 | 17.1 |
| 4 | 10600.00 | 47.1 AV | 54.0 | -6.9 | 2.10 H | 33 | 30.0 | 17.1 |

ANTENNA POLARITY & TEST DISTANCE: VERTICAL AT 3 M

| NO. | FREQ. (MHz) | EMISSION LEVEL (dBuV/m) | LIMIT (dBuV/m) | MARGIN (dB) | ANTENNA HEIGHT (m) | TABLE ANGLE (Degree) | RAW VALUE (dBuV) | CORRECTION FACTOR (dB/m) |
|-----|-------------|-------------------------|----------------|-------------|--------------------|----------------------|------------------|--------------------------|
| 1 | *5300.00 | 117.0 PK | | | 1.86 V | 346 | 77.4 | 39.6 |
| 2 | *5300.00 | 106.7 AV | | | 1.86 V | 346 | 67.1 | 39.6 |
| 3 | 10600.00 | 59.6 PK | 74.0 | -14.4 | 1.59 V | 287 | 42.5 | 17.1 |
| 4 | 10600.00 | 46.7 AV | 54.0 | -7.3 | 1.59 V | 287 | 29.6 | 17.1 |

Remarks:

1. Emission Level(dBuV/m) = Raw Value(dBuV) + Correction Factor(dB/m)
2. Correction Factor(dB/m) = Antenna Factor(dB/m) + Cable Factor(dB) – Pre-Amplifier Factor(dB)
3. The other emission levels were very low against the limit.
4. Margin value = Emission Level – Limit value
5. " * ": Fundamental frequency.
6. " # ": The radiated frequency is out of the restricted band.

| | | | |
|-----------------|---------------|----------------------|--------------|
| CHANNEL | TX Channel 64 | DETECTOR FUNCTION | Peak (PK) |
| FREQUENCY RANGE | 1GHz ~ 40GHz | | Average (AV) |

ANTENNA POLARITY & TEST DISTANCE: HORIZONTAL AT 3 M

| NO. | FREQ. (MHz) | EMISSION LEVEL (dBuV/m) | LIMIT (dBuV/m) | MARGIN (dB) | ANTENNA HEIGHT (m) | TABLE ANGLE (Degree) | RAW VALUE (dBuV) | CORRECTION FACTOR (dB/m) |
|-----|----------------|-------------------------------|-------------------|----------------|--------------------------|----------------------------|------------------------|--------------------------------|
| 1 | *5320.00 | 119.2 PK | | | 1.67 H | 351 | 79.5 | 39.7 |
| 2 | *5320.00 | 108.3 AV | | | 1.67 H | 351 | 68.6 | 39.7 |
| 3 | 5350.00 | 58.9 PK | 74.0 | -15.1 | 1.77 H | 349 | 55.0 | 3.9 |
| 4 | 5350.00 | 47.7 AV | 54.0 | -6.3 | 1.77 H | 349 | 43.8 | 3.9 |
| 5 | 10640.00 | 60.6 PK | 74.0 | -13.4 | 2.17 H | 34 | 43.3 | 17.3 |
| 6 | 10640.00 | 47.2 AV | 54.0 | -6.8 | 2.17 H | 34 | 29.9 | 17.3 |

ANTENNA POLARITY & TEST DISTANCE: VERTICAL AT 3 M

| NO. | FREQ. (MHz) | EMISSION LEVEL (dBuV/m) | LIMIT (dBuV/m) | MARGIN (dB) | ANTENNA HEIGHT (m) | TABLE ANGLE (Degree) | RAW VALUE (dBuV) | CORRECTION FACTOR (dB/m) |
|-----|----------------|-------------------------------|-------------------|----------------|--------------------------|----------------------------|------------------------|--------------------------------|
| 1 | *5320.00 | 117.6 PK | | | 1.97 V | 347 | 77.9 | 39.7 |
| 2 | *5320.00 | 107.0 AV | | | 1.97 V | 347 | 67.3 | 39.7 |
| 3 | 5350.00 | 57.4 PK | 74.0 | -16.6 | 1.66 V | 349 | 53.5 | 3.9 |
| 4 | 5350.00 | 45.7 AV | 54.0 | -8.3 | 1.66 V | 349 | 41.8 | 3.9 |
| 5 | 10640.00 | 60.2 PK | 74.0 | -13.8 | 1.57 V | 275 | 42.9 | 17.3 |
| 6 | 10640.00 | 46.7 AV | 54.0 | -7.3 | 1.57 V | 275 | 29.4 | 17.3 |

Remarks:

1. Emission Level(dBuV/m) = Raw Value(dBuV) + Correction Factor(dB/m)
2. Correction Factor(dB/m) = Antenna Factor(dB/m) + Cable Factor(dB) – Pre-Amplifier Factor(dB)
3. The other emission levels were very low against the limit.
4. Margin value = Emission Level – Limit value
5. " * ": Fundamental frequency.
6. " # ": The radiated frequency is out of the restricted band.

| | | | |
|-----------------|----------------|----------------------|--------------|
| CHANNEL | TX Channel 100 | DETECTOR FUNCTION | Peak (PK) |
| FREQUENCY RANGE | 1GHz ~ 40GHz | | Average (AV) |

ANTENNA POLARITY & TEST DISTANCE: HORIZONTAL AT 3 M

| NO. | FREQ. (MHz) | EMISSION LEVEL (dBuV/m) | LIMIT (dBuV/m) | MARGIN (dB) | ANTENNA HEIGHT (m) | TABLE ANGLE (Degree) | RAW VALUE (dBuV) | CORRECTION FACTOR (dB/m) |
|-----|----------------|-------------------------------|-------------------|----------------|--------------------------|----------------------------|------------------------|--------------------------------|
| 1 | 5460.00 | 56.0 PK | 74.0 | -18.0 | 1.72 H | 349 | 52.0 | 4.0 |
| 2 | 5460.00 | 44.9 AV | 54.0 | -9.1 | 1.72 H | 349 | 40.9 | 4.0 |
| 3 | #5470.00 | 56.1 PK | 74.0 | -17.9 | 1.77 H | 350 | 52.1 | 4.0 |
| 4 | #5470.00 | 45.8 AV | 54.0 | -8.2 | 1.77 H | 350 | 41.8 | 4.0 |
| 5 | *5500.00 | 118.9 PK | | | 1.73 H | 348 | 78.9 | 40.0 |
| 6 | *5500.00 | 107.9 AV | | | 1.73 H | 348 | 67.9 | 40.0 |
| 7 | 11000.00 | 61.5 PK | 74.0 | -12.5 | 2.20 H | 28 | 42.5 | 19.0 |
| 8 | 11000.00 | 48.1 AV | 54.0 | -5.9 | 2.20 H | 28 | 29.1 | 19.0 |

ANTENNA POLARITY & TEST DISTANCE: VERTICAL AT 3 M

| NO. | FREQ. (MHz) | EMISSION LEVEL (dBuV/m) | LIMIT (dBuV/m) | MARGIN (dB) | ANTENNA HEIGHT (m) | TABLE ANGLE (Degree) | RAW VALUE (dBuV) | CORRECTION FACTOR (dB/m) |
|-----|----------------|-------------------------------|-------------------|----------------|--------------------------|----------------------------|------------------------|--------------------------------|
| 1 | 5460.00 | 55.8 PK | 74.0 | -18.2 | 1.95 V | 359 | 51.8 | 4.0 |
| 2 | 5460.00 | 44.8 AV | 54.0 | -9.2 | 1.95 V | 359 | 40.8 | 4.0 |
| 3 | #5470.00 | 56.8 PK | 74.0 | -17.2 | 2.01 V | 0 | 52.8 | 4.0 |
| 4 | #5470.00 | 45.7 AV | 54.0 | -8.3 | 2.01 V | 0 | 41.7 | 4.0 |
| 5 | *5500.00 | 117.0 PK | | | 1.98 V | 342 | 77.0 | 40.0 |
| 6 | *5500.00 | 106.6 AV | | | 1.98 V | 342 | 66.6 | 40.0 |
| 7 | 11000.00 | 61.2 PK | 74.0 | -12.8 | 1.75 V | 266 | 42.2 | 19.0 |
| 8 | 11000.00 | 48.6 AV | 54.0 | -5.4 | 1.75 V | 266 | 29.6 | 19.0 |

Remarks:

1. Emission Level(dBuV/m) = Raw Value(dBuV) + Correction Factor(dB/m)
2. Correction Factor(dB/m) = Antenna Factor(dB/m) + Cable Factor(dB) – Pre-Amplifier Factor(dB)
3. The other emission levels were very low against the limit.
4. Margin value = Emission Level – Limit value
5. " * ": Fundamental frequency.
6. " # ": The radiated frequency is out of the restricted band.

| | | | |
|-----------------|----------------|-------------------|--------------|
| CHANNEL | TX Channel 116 | DETECTOR FUNCTION | Peak (PK) |
| FREQUENCY RANGE | 1GHz ~ 40GHz | | Average (AV) |

ANTENNA POLARITY & TEST DISTANCE: HORIZONTAL AT 3 M

| NO. | FREQ. (MHz) | EMISSION LEVEL (dBuV/m) | LIMIT (dBuV/m) | MARGIN (dB) | ANTENNA HEIGHT (m) | TABLE ANGLE (Degree) | RAW VALUE (dBuV) | CORRECTION FACTOR (dB/m) |
|-----|-------------|-------------------------|----------------|-------------|--------------------|----------------------|------------------|--------------------------|
| 1 | *5580.00 | 119.1 PK | | | 1.75 H | 345 | 79.0 | 40.1 |
| 2 | *5580.00 | 107.8 AV | | | 1.75 H | 345 | 67.7 | 40.1 |
| 3 | 11160.00 | 60.8 PK | 74.0 | -13.2 | 2.10 H | 30 | 42.1 | 18.7 |
| 4 | 11160.00 | 48.1 AV | 54.0 | -5.9 | 2.10 H | 30 | 29.4 | 18.7 |

ANTENNA POLARITY & TEST DISTANCE: VERTICAL AT 3 M

| NO. | FREQ. (MHz) | EMISSION LEVEL (dBuV/m) | LIMIT (dBuV/m) | MARGIN (dB) | ANTENNA HEIGHT (m) | TABLE ANGLE (Degree) | RAW VALUE (dBuV) | CORRECTION FACTOR (dB/m) |
|-----|-------------|-------------------------|----------------|-------------|--------------------|----------------------|------------------|--------------------------|
| 1 | *5580.00 | 117.9 PK | | | 1.97 V | 344 | 77.8 | 40.1 |
| 2 | *5580.00 | 106.7 AV | | | 1.97 V | 344 | 66.6 | 40.1 |
| 3 | 11160.00 | 61.2 PK | 74.0 | -12.8 | 1.80 V | 265 | 42.5 | 18.7 |
| 4 | 11160.00 | 48.4 AV | 54.0 | -5.6 | 1.80 V | 265 | 29.7 | 18.7 |

Remarks:

1. Emission Level(dBuV/m) = Raw Value(dBuV) + Correction Factor(dB/m)
2. Correction Factor(dB/m) = Antenna Factor(dB/m) + Cable Factor(dB) – Pre-Amplifier Factor(dB)
3. The other emission levels were very low against the limit.
4. Margin value = Emission Level – Limit value
5. " * ": Fundamental frequency.
6. " # ": The radiated frequency is out of the restricted band.

| | | | |
|-----------------|----------------|-------------------|--------------|
| CHANNEL | TX Channel 140 | DETECTOR FUNCTION | Peak (PK) |
| FREQUENCY RANGE | 1GHz ~ 40GHz | | Average (AV) |

ANTENNA POLARITY & TEST DISTANCE: HORIZONTAL AT 3 M

| NO. | FREQ. (MHz) | EMISSION LEVEL (dBuV/m) | LIMIT (dBuV/m) | MARGIN (dB) | ANTENNA HEIGHT (m) | TABLE ANGLE (Degree) | RAW VALUE (dBuV) | CORRECTION FACTOR (dB/m) |
|-----|-------------|-------------------------|----------------|-------------|--------------------|----------------------|------------------|--------------------------|
| 1 | *5700.00 | 118.8 PK | | | 1.73 H | 348 | 78.5 | 40.3 |
| 2 | *5700.00 | 107.7 AV | | | 1.73 H | 348 | 67.4 | 40.3 |
| 3 | #5725.00 | 57.0 PK | 74.0 | -17.0 | 1.63 H | 349 | 52.5 | 4.5 |
| 4 | #5725.00 | 46.2 AV | 54.0 | -7.8 | 1.63 H | 349 | 41.7 | 4.5 |
| 5 | 11400.00 | 60.8 PK | 74.0 | -13.2 | 2.13 H | 38 | 42.6 | 18.2 |
| 6 | 11400.00 | 48.0 AV | 54.0 | -6.0 | 2.13 H | 38 | 29.8 | 18.2 |

ANTENNA POLARITY & TEST DISTANCE: VERTICAL AT 3 M

| NO. | FREQ. (MHz) | EMISSION LEVEL (dBuV/m) | LIMIT (dBuV/m) | MARGIN (dB) | ANTENNA HEIGHT (m) | TABLE ANGLE (Degree) | RAW VALUE (dBuV) | CORRECTION FACTOR (dB/m) |
|-----|-------------|-------------------------|----------------|-------------|--------------------|----------------------|------------------|--------------------------|
| 1 | *5700.00 | 117.1 PK | | | 1.84 V | 350 | 76.8 | 40.3 |
| 2 | *5700.00 | 106.9 AV | | | 1.84 V | 350 | 66.6 | 40.3 |
| 3 | #5725.00 | 56.4 PK | 74.0 | -17.6 | 1.88 V | 348 | 51.9 | 4.5 |
| 4 | #5725.00 | 45.3 AV | 54.0 | -8.7 | 1.88 V | 348 | 40.8 | 4.5 |
| 5 | 11400.00 | 60.9 PK | 74.0 | -13.1 | 1.60 V | 296 | 42.7 | 18.2 |
| 6 | 11400.00 | 47.5 AV | 54.0 | -6.5 | 1.60 V | 296 | 29.3 | 18.2 |

Remarks:

1. Emission Level(dBuV/m) = Raw Value(dBuV) + Correction Factor(dB/m)
2. Correction Factor(dB/m) = Antenna Factor(dB/m) + Cable Factor(dB) – Pre-Amplifier Factor(dB)
3. The other emission levels were very low against the limit.
4. Margin value = Emission Level – Limit value
5. " * ": Fundamental frequency.
6. " # ": The radiated frequency is out of the restricted band.

| | | | |
|-----------------|----------------|----------------------|--------------|
| CHANNEL | TX Channel 144 | DETECTOR FUNCTION | Peak (PK) |
| FREQUENCY RANGE | 1GHz ~ 40GHz | | Average (AV) |

| ANTENNA POLARITY & TEST DISTANCE: HORIZONTAL AT 3 M | | | | | | | | |
|---|----------------|-------------------------------|-------------------|----------------|--------------------------|----------------------------|------------------------|--------------------------------|
| NO. | FREQ. (MHz) | EMISSION LEVEL (dBuV/m) | LIMIT (dBuV/m) | MARGIN (dB) | ANTENNA HEIGHT (m) | TABLE ANGLE (Degree) | RAW VALUE (dBuV) | CORRECTION FACTOR (dB/m) |
| 1 | #5470.00 | 54.5 PK | 74.0 | -19.5 | 1.60 H | 340 | 50.5 | 4.0 |
| 2 | #5470.00 | 43.9 AV | 54.0 | -10.1 | 1.60 H | 340 | 39.9 | 4.0 |
| 3 | *5720.00 | 118.3 PK | | | 1.67 H | 347 | 77.9 | 40.4 |
| 4 | *5720.00 | 107.8 AV | | | 1.67 H | 347 | 67.4 | 40.4 |
| 5 | #5850.00 | 56.3 PK | 74.0 | -17.7 | 1.57 H | 339 | 51.5 | 4.8 |
| 6 | #5850.00 | 45.0 AV | 54.0 | -9.0 | 1.57 H | 339 | 40.2 | 4.8 |
| 7 | 11440.00 | 60.6 PK | 74.0 | -13.4 | 2.05 H | 36 | 42.3 | 18.3 |
| 8 | 11440.00 | 47.7 AV | 54.0 | -6.3 | 2.05 H | 36 | 29.4 | 18.3 |

| ANTENNA POLARITY & TEST DISTANCE: VERTICAL AT 3 M | | | | | | | | |
|---|----------------|-------------------------------|-------------------|----------------|--------------------------|----------------------------|------------------------|--------------------------------|
| NO. | FREQ. (MHz) | EMISSION LEVEL (dBuV/m) | LIMIT (dBuV/m) | MARGIN (dB) | ANTENNA HEIGHT (m) | TABLE ANGLE (Degree) | RAW VALUE (dBuV) | CORRECTION FACTOR (dB/m) |
| 1 | #5470.00 | 55.6 PK | 74.0 | -18.4 | 1.99 V | 347 | 51.6 | 4.0 |
| 2 | #5470.00 | 44.6 AV | 54.0 | -9.4 | 1.99 V | 347 | 40.6 | 4.0 |
| 3 | *5720.00 | 117.9 PK | | | 1.98 V | 348 | 77.5 | 40.4 |
| 4 | *5720.00 | 107.3 AV | | | 1.98 V | 348 | 66.9 | 40.4 |
| 5 | #5850.00 | 56.7 PK | 74.0 | -17.3 | 2.03 V | 340 | 51.9 | 4.8 |
| 6 | #5850.00 | 46.7 AV | 54.0 | -7.3 | 2.03 V | 340 | 41.9 | 4.8 |
| 7 | 11440.00 | 59.6 PK | 74.0 | -14.4 | 1.27 V | 354 | 41.3 | 18.3 |
| 8 | 11440.00 | 46.6 AV | 54.0 | -7.4 | 1.27 V | 354 | 28.3 | 18.3 |

Remarks:

1. Emission Level(dBuV/m) = Raw Value(dBuV) + Correction Factor(dB/m)
2. Correction Factor(dB/m) = Antenna Factor(dB/m) + Cable Factor(dB) – Pre-Amplifier Factor(dB)
3. The other emission levels were very low against the limit.
4. Margin value = Emission Level – Limit value
5. " * ": Fundamental frequency.
6. " # ": The radiated frequency is out of the restricted band.

802.11n (HT40)

| | | | |
|-----------------|---------------|----------------------|--------------|
| CHANNEL | TX Channel 54 | DETECTOR FUNCTION | Peak (PK) |
| FREQUENCY RANGE | 1GHz ~ 40GHz | | Average (AV) |

ANTENNA POLARITY & TEST DISTANCE: HORIZONTAL AT 3 M

| NO. | FREQ. (MHz) | EMISSION LEVEL (dBuV/m) | LIMIT (dBuV/m) | MARGIN (dB) | ANTENNA HEIGHT (m) | TABLE ANGLE (Degree) | RAW VALUE (dBuV) | CORRECTION FACTOR (dB/m) |
|-----|----------------|-------------------------------|-------------------|----------------|--------------------------|----------------------------|------------------------|--------------------------------|
| 1 | 5150.00 | 57.4 PK | 74.0 | -16.6 | 1.81 H | 348 | 53.8 | 3.6 |
| 2 | 5150.00 | 45.7 AV | 54.0 | -8.3 | 1.81 H | 348 | 42.1 | 3.6 |
| 3 | *5270.00 | 115.5 PK | | | 1.71 H | 351 | 75.9 | 39.6 |
| 4 | *5270.00 | 105.3 AV | | | 1.71 H | 351 | 65.7 | 39.6 |
| 5 | #10540.00 | 58.8 PK | 74.0 | -15.2 | 2.20 H | 51 | 41.7 | 17.1 |
| 6 | #10540.00 | 45.8 AV | 54.0 | -8.2 | 2.20 H | 51 | 28.7 | 17.1 |

ANTENNA POLARITY & TEST DISTANCE: VERTICAL AT 3 M

| NO. | FREQ. (MHz) | EMISSION LEVEL (dBuV/m) | LIMIT (dBuV/m) | MARGIN (dB) | ANTENNA HEIGHT (m) | TABLE ANGLE (Degree) | RAW VALUE (dBuV) | CORRECTION FACTOR (dB/m) |
|-----|----------------|-------------------------------|-------------------|----------------|--------------------------|----------------------------|------------------------|--------------------------------|
| 1 | 5150.00 | 55.4 PK | 74.0 | -18.6 | 1.80 V | 348 | 51.8 | 3.6 |
| 2 | 5150.00 | 44.5 AV | 54.0 | -9.5 | 1.80 V | 348 | 40.9 | 3.6 |
| 3 | *5270.00 | 115.0 PK | | | 1.81 V | 348 | 75.4 | 39.6 |
| 4 | *5270.00 | 104.8 AV | | | 1.81 V | 348 | 65.2 | 39.6 |
| 5 | #10540.00 | 58.5 PK | 74.0 | -15.5 | 1.50 V | 284 | 41.4 | 17.1 |
| 6 | #10540.00 | 45.5 AV | 54.0 | -8.5 | 1.50 V | 284 | 28.4 | 17.1 |

Remarks:

1. Emission Level(dBuV/m) = Raw Value(dBuV) + Correction Factor(dB/m)
2. Correction Factor(dB/m) = Antenna Factor(dB/m) + Cable Factor(dB) – Pre-Amplifier Factor(dB)
3. The other emission levels were very low against the limit.
4. Margin value = Emission Level – Limit value
5. " * ": Fundamental frequency.
6. " # ": The radiated frequency is out of the restricted band.

| | | | |
|-----------------|---------------|-------------------|--------------|
| CHANNEL | TX Channel 62 | DETECTOR FUNCTION | Peak (PK) |
| FREQUENCY RANGE | 1GHz ~ 40GHz | | Average (AV) |

ANTENNA POLARITY & TEST DISTANCE: HORIZONTAL AT 3 M

| NO. | FREQ. (MHz) | EMISSION LEVEL (dBuV/m) | LIMIT (dBuV/m) | MARGIN (dB) | ANTENNA HEIGHT (m) | TABLE ANGLE (Degree) | RAW VALUE (dBuV) | CORRECTION FACTOR (dB/m) |
|-----|-------------|-------------------------|----------------|-------------|--------------------|----------------------|------------------|--------------------------|
| 1 | *5310.00 | 115.3 PK | | | 1.69 H | 349 | 75.7 | 39.6 |
| 2 | *5310.00 | 105.5 AV | | | 1.69 H | 349 | 65.9 | 39.6 |
| 3 | 5350.00 | 64.0 PK | 74.0 | -10.0 | 1.80 H | 352 | 60.1 | 3.9 |
| 4 | 5350.00 | 51.4 AV | 54.0 | -2.6 | 1.80 H | 352 | 47.5 | 3.9 |
| 5 | 10620.00 | 58.7 PK | 74.0 | -15.3 | 2.19 H | 49 | 41.4 | 17.3 |
| 6 | 10620.00 | 45.7 AV | 54.0 | -8.3 | 2.19 H | 49 | 28.4 | 17.3 |

ANTENNA POLARITY & TEST DISTANCE: VERTICAL AT 3 M

| NO. | FREQ. (MHz) | EMISSION LEVEL (dBuV/m) | LIMIT (dBuV/m) | MARGIN (dB) | ANTENNA HEIGHT (m) | TABLE ANGLE (Degree) | RAW VALUE (dBuV) | CORRECTION FACTOR (dB/m) |
|-----|-------------|-------------------------|----------------|-------------|--------------------|----------------------|------------------|--------------------------|
| 1 | *5310.00 | 114.9 PK | | | 1.92 V | 347 | 75.3 | 39.6 |
| 2 | *5310.00 | 104.8 AV | | | 1.92 V | 347 | 65.2 | 39.6 |
| 3 | 5350.00 | 61.0 PK | 74.0 | -13.0 | 1.55 V | 346 | 57.1 | 3.9 |
| 4 | 5350.00 | 48.5 AV | 54.0 | -5.5 | 1.55 V | 346 | 44.6 | 3.9 |
| 5 | 10620.00 | 58.5 PK | 74.0 | -15.5 | 1.52 V | 277 | 41.2 | 17.3 |
| 6 | 10620.00 | 45.3 AV | 54.0 | -8.7 | 1.52 V | 277 | 28.0 | 17.3 |

Remarks:

1. Emission Level(dBuV/m) = Raw Value(dBuV) + Correction Factor(dB/m)
2. Correction Factor(dB/m) = Antenna Factor(dB/m) + Cable Factor(dB) – Pre-Amplifier Factor(dB)
3. The other emission levels were very low against the limit.
4. Margin value = Emission Level – Limit value
5. " * ": Fundamental frequency.
6. " # ": The radiated frequency is out of the restricted band.

| | | | |
|-----------------|----------------|-------------------|--------------|
| CHANNEL | TX Channel 102 | DETECTOR FUNCTION | Peak (PK) |
| FREQUENCY RANGE | 1GHz ~ 40GHz | | Average (AV) |

ANTENNA POLARITY & TEST DISTANCE: HORIZONTAL AT 3 M

| NO. | FREQ. (MHz) | EMISSION LEVEL (dBuV/m) | LIMIT (dBuV/m) | MARGIN (dB) | ANTENNA HEIGHT (m) | TABLE ANGLE (Degree) | RAW VALUE (dBuV) | CORRECTION FACTOR (dB/m) |
|-----|-------------|-------------------------|----------------|-------------|--------------------|----------------------|------------------|--------------------------|
| 1 | 5460.00 | 65.1 PK | 74.0 | -8.9 | 1.66 H | 355 | 61.1 | 4.0 |
| 2 | 5460.00 | 50.7 AV | 54.0 | -3.3 | 1.66 H | 355 | 46.7 | 4.0 |
| 3 | #5470.00 | 63.8 PK | 74.0 | -10.2 | 1.67 H | 354 | 59.8 | 4.0 |
| 4 | #5470.00 | 49.6 AV | 54.0 | -4.4 | 1.67 H | 354 | 45.6 | 4.0 |
| 5 | *5510.00 | 114.2 PK | | | 1.72 H | 352 | 74.2 | 40.0 |
| 6 | *5510.00 | 104.3 AV | | | 1.72 H | 352 | 64.3 | 40.0 |
| 7 | 11020.00 | 60.5 PK | 74.0 | -13.5 | 2.09 H | 23 | 41.6 | 18.9 |
| 8 | 11020.00 | 47.7 AV | 54.0 | -6.3 | 2.09 H | 23 | 28.8 | 18.9 |

ANTENNA POLARITY & TEST DISTANCE: VERTICAL AT 3 M

| NO. | FREQ. (MHz) | EMISSION LEVEL (dBuV/m) | LIMIT (dBuV/m) | MARGIN (dB) | ANTENNA HEIGHT (m) | TABLE ANGLE (Degree) | RAW VALUE (dBuV) | CORRECTION FACTOR (dB/m) |
|-----|-------------|-------------------------|----------------|-------------|--------------------|----------------------|------------------|--------------------------|
| 1 | 5460.00 | 61.5 PK | 74.0 | -12.5 | 2.10 V | 346 | 57.5 | 4.0 |
| 2 | 5460.00 | 45.7 AV | 54.0 | -8.3 | 2.10 V | 346 | 41.7 | 4.0 |
| 3 | #5470.00 | 61.5 PK | 74.0 | -12.5 | 2.12 V | 348 | 57.5 | 4.0 |
| 4 | #5470.00 | 47.9 AV | 54.0 | -6.1 | 2.12 V | 348 | 43.9 | 4.0 |
| 5 | *5510.00 | 115.3 PK | | | 1.85 V | 348 | 75.3 | 40.0 |
| 6 | *5510.00 | 105.3 AV | | | 1.85 V | 348 | 65.3 | 40.0 |
| 7 | 11020.00 | 60.4 PK | 74.0 | -13.6 | 1.80 V | 255 | 41.5 | 18.9 |
| 8 | 11020.00 | 47.2 AV | 54.0 | -6.8 | 1.80 V | 255 | 28.3 | 18.9 |

Remarks:

1. Emission Level(dBuV/m) = Raw Value(dBuV) + Correction Factor(dB/m)
2. Correction Factor(dB/m) = Antenna Factor(dB/m) + Cable Factor(dB) – Pre-Amplifier Factor(dB)
3. The other emission levels were very low against the limit.
4. Margin value = Emission Level – Limit value
5. " * ": Fundamental frequency.
6. " # ": The radiated frequency is out of the restricted band.

| | | | |
|-----------------|----------------|----------|--------------|
| CHANNEL | TX Channel 110 | DETECTOR | Peak (PK) |
| FREQUENCY RANGE | 1GHz ~ 40GHz | FUNCTION | Average (AV) |

ANTENNA POLARITY & TEST DISTANCE: HORIZONTAL AT 3 M

| NO. | FREQ. (MHz) | EMISSION LEVEL (dBuV/m) | LIMIT (dBuV/m) | MARGIN (dB) | ANTENNA HEIGHT (m) | TABLE ANGLE (Degree) | RAW VALUE (dBuV) | CORRECTION FACTOR (dB/m) |
|-----|-------------|-------------------------|----------------|-------------|--------------------|----------------------|------------------|--------------------------|
| 1 | *5550.00 | 114.3 PK | | | 1.64 H | 352 | 74.3 | 40.0 |
| 2 | *5550.00 | 104.3 AV | | | 1.64 H | 352 | 64.3 | 40.0 |
| 3 | 11000.00 | 60.7 PK | 74.0 | -13.3 | 2.26 H | 19 | 41.7 | 19.0 |
| 4 | 11000.00 | 47.5 AV | 54.0 | -6.5 | 2.26 H | 19 | 28.5 | 19.0 |

ANTENNA POLARITY & TEST DISTANCE: VERTICAL AT 3 M

| NO. | FREQ. (MHz) | EMISSION LEVEL (dBuV/m) | LIMIT (dBuV/m) | MARGIN (dB) | ANTENNA HEIGHT (m) | TABLE ANGLE (Degree) | RAW VALUE (dBuV) | CORRECTION FACTOR (dB/m) |
|-----|-------------|-------------------------|----------------|-------------|--------------------|----------------------|------------------|--------------------------|
| 1 | *5550.00 | 115.6 PK | | | 1.92 V | 346 | 75.6 | 40.0 |
| 2 | *5550.00 | 105.4 AV | | | 1.92 V | 346 | 65.4 | 40.0 |
| 3 | 11100.00 | 59.9 PK | 74.0 | -14.1 | 1.62 V | 287 | 41.4 | 18.5 |
| 4 | 11100.00 | 46.8 AV | 54.0 | -7.2 | 1.62 V | 287 | 28.3 | 18.5 |

Remarks:

1. Emission Level(dBuV/m) = Raw Value(dBuV) + Correction Factor(dB/m)
2. Correction Factor(dB/m) = Antenna Factor(dB/m) + Cable Factor(dB) – Pre-Amplifier Factor(dB)
3. The other emission levels were very low against the limit.
4. Margin value = Emission Level – Limit value
5. " * ": Fundamental frequency.
6. " # ": The radiated frequency is out of the restricted band.

| | | | |
|-----------------|----------------|-------------------|--------------|
| CHANNEL | TX Channel 134 | DETECTOR FUNCTION | Peak (PK) |
| FREQUENCY RANGE | 1GHz ~ 40GHz | | Average (AV) |

ANTENNA POLARITY & TEST DISTANCE: HORIZONTAL AT 3 M

| NO. | FREQ. (MHz) | EMISSION LEVEL (dBuV/m) | LIMIT (dBuV/m) | MARGIN (dB) | ANTENNA HEIGHT (m) | TABLE ANGLE (Degree) | RAW VALUE (dBuV) | CORRECTION FACTOR (dB/m) |
|-----|-------------|-------------------------|----------------|-------------|--------------------|----------------------|------------------|--------------------------|
| 1 | *5670.00 | 115.0 PK | | | 1.65 H | 352 | 74.7 | 40.3 |
| 2 | *5670.00 | 104.9 AV | | | 1.65 H | 352 | 64.6 | 40.3 |
| 3 | #5725.00 | 60.0 PK | 74.0 | -14.0 | 1.70 H | 350 | 55.5 | 4.5 |
| 4 | #5725.00 | 46.9 AV | 54.0 | -7.1 | 1.70 H | 350 | 42.4 | 4.5 |
| 5 | 11340.00 | 60.3 PK | 74.0 | -13.7 | 2.29 H | 31 | 41.9 | 18.4 |
| 6 | 11340.00 | 47.6 AV | 54.0 | -6.4 | 2.29 H | 31 | 29.2 | 18.4 |

ANTENNA POLARITY & TEST DISTANCE: VERTICAL AT 3 M

| NO. | FREQ. (MHz) | EMISSION LEVEL (dBuV/m) | LIMIT (dBuV/m) | MARGIN (dB) | ANTENNA HEIGHT (m) | TABLE ANGLE (Degree) | RAW VALUE (dBuV) | CORRECTION FACTOR (dB/m) |
|-----|-------------|-------------------------|----------------|-------------|--------------------|----------------------|------------------|--------------------------|
| 1 | *5670.00 | 115.8 PK | | | 1.92 V | 347 | 75.5 | 40.3 |
| 2 | *5670.00 | 105.8 AV | | | 1.92 V | 347 | 65.5 | 40.3 |
| 3 | #5725.00 | 58.9 PK | 74.0 | -15.1 | 1.94 V | 347 | 54.4 | 4.5 |
| 4 | #5725.00 | 47.0 AV | 54.0 | -7.0 | 1.94 V | 347 | 42.5 | 4.5 |
| 5 | 11340.00 | 60.0 PK | 74.0 | -14.0 | 1.66 V | 285 | 41.6 | 18.4 |
| 6 | 11340.00 | 47.0 AV | 54.0 | -7.0 | 1.66 V | 285 | 28.6 | 18.4 |

Remarks:

1. Emission Level(dBuV/m) = Raw Value(dBuV) + Correction Factor(dB/m)
2. Correction Factor(dB/m) = Antenna Factor(dB/m) + Cable Factor(dB) – Pre-Amplifier Factor(dB)
3. The other emission levels were very low against the limit.
4. Margin value = Emission Level – Limit value
5. " * ": Fundamental frequency.
6. " # ": The radiated frequency is out of the restricted band.

| | | | |
|-----------------|----------------|----------------------|--------------|
| CHANNEL | TX Channel 142 | DETECTOR FUNCTION | Peak (PK) |
| FREQUENCY RANGE | 1GHz ~ 40GHz | | Average (AV) |

ANTENNA POLARITY & TEST DISTANCE: HORIZONTAL AT 3 M

| NO. | FREQ. (MHz) | EMISSION LEVEL (dBuV/m) | LIMIT (dBuV/m) | MARGIN (dB) | ANTENNA HEIGHT (m) | TABLE ANGLE (Degree) | RAW VALUE (dBuV) | CORRECTION FACTOR (dB/m) |
|-----|----------------|-------------------------------|-------------------|----------------|--------------------------|----------------------------|------------------------|--------------------------------|
| 1 | #5470.00 | 55.8 PK | 74.0 | -18.2 | 1.54 H | 338 | 51.8 | 4.0 |
| 2 | #5470.00 | 44.8 AV | 54.0 | -9.2 | 1.54 H | 338 | 40.8 | 4.0 |
| 3 | *5710.00 | 115.1 PK | | | 1.69 H | 349 | 74.7 | 40.4 |
| 4 | *5710.00 | 105.4 AV | | | 1.69 H | 349 | 65.0 | 40.4 |
| 5 | #5850.00 | 56.6 PK | 74.0 | -17.4 | 1.50 H | 330 | 51.8 | 4.8 |
| 6 | #5850.00 | 45.8 AV | 54.0 | -8.2 | 1.50 H | 330 | 41.0 | 4.8 |
| 7 | 11420.00 | 59.5 PK | 74.0 | -14.5 | 2.09 H | 21 | 41.3 | 18.2 |
| 8 | 11420.00 | 46.7 AV | 54.0 | -7.3 | 2.09 H | 21 | 28.5 | 18.2 |

ANTENNA POLARITY & TEST DISTANCE: VERTICAL AT 3 M

| NO. | FREQ. (MHz) | EMISSION LEVEL (dBuV/m) | LIMIT (dBuV/m) | MARGIN (dB) | ANTENNA HEIGHT (m) | TABLE ANGLE (Degree) | RAW VALUE (dBuV) | CORRECTION FACTOR (dB/m) |
|-----|----------------|-------------------------------|-------------------|----------------|--------------------------|----------------------------|------------------------|--------------------------------|
| 1 | #5470.00 | 54.6 PK | 74.0 | -19.4 | 1.96 V | 350 | 50.6 | 4.0 |
| 2 | #5470.00 | 43.6 AV | 54.0 | -10.4 | 1.96 V | 350 | 39.6 | 4.0 |
| 3 | *5710.00 | 114.9 PK | | | 1.76 V | 349 | 74.5 | 40.4 |
| 4 | *5710.00 | 105.2 AV | | | 1.76 V | 349 | 64.8 | 40.4 |
| 5 | #5850.00 | 55.4 PK | 74.0 | -18.6 | 1.77 V | 340 | 50.6 | 4.8 |
| 6 | #5850.00 | 44.3 AV | 54.0 | -9.7 | 1.77 V | 340 | 39.5 | 4.8 |
| 7 | 11420.00 | 59.3 PK | 74.0 | -14.7 | 1.30 V | 356 | 41.1 | 18.2 |
| 8 | 11420.00 | 46.4 AV | 54.0 | -7.6 | 1.30 V | 356 | 28.2 | 18.2 |

Remarks:

1. Emission Level(dBuV/m) = Raw Value(dBuV) + Correction Factor(dB/m)
2. Correction Factor(dB/m) = Antenna Factor(dB/m) + Cable Factor(dB) – Pre-Amplifier Factor(dB)
3. The other emission levels were very low against the limit.
4. Margin value = Emission Level – Limit value
5. " * ": Fundamental frequency.
6. " # ": The radiated frequency is out of the restricted band.

802.11ac (VHT80)

| | | | |
|-----------------|---------------|----------------------|--------------|
| CHANNEL | TX Channel 58 | DETECTOR FUNCTION | Peak (PK) |
| FREQUENCY RANGE | 1GHz ~ 40GHz | | Average (AV) |

| ANTENNA POLARITY & TEST DISTANCE: HORIZONTAL AT 3 M | | | | | | | | |
|---|----------------|-------------------------------|-------------------|----------------|--------------------------|----------------------------|------------------------|--------------------------------|
| NO. | FREQ. (MHz) | EMISSION LEVEL (dBuV/m) | LIMIT (dBuV/m) | MARGIN (dB) | ANTENNA HEIGHT (m) | TABLE ANGLE (Degree) | RAW VALUE (dBuV) | CORRECTION FACTOR (dB/m) |
| 1 | 5150.00 | 55.7 PK | 74.0 | -18.3 | 1.66 H | 345 | 52.1 | 3.6 |
| 2 | 5150.00 | 44.6 AV | 54.0 | -9.4 | 1.66 H | 345 | 41.0 | 3.6 |
| 3 | *5290.00 | 111.4 PK | | | 1.76 H | 349 | 71.8 | 39.6 |
| 4 | *5290.00 | 101.2 AV | | | 1.76 H | 349 | 61.6 | 39.6 |
| 5 | 5350.00 | 69.7 PK | 74.0 | -4.3 | 1.72 H | 348 | 65.8 | 3.9 |
| 6 | 5350.00 | 51.9 AV | 54.0 | -2.1 | 1.72 H | 348 | 48.0 | 3.9 |
| 7 | #10580.00 | 58.4 PK | 74.0 | -15.6 | 2.01 H | 29 | 41.2 | 17.2 |
| 8 | #10580.00 | 45.4 AV | 54.0 | -8.6 | 2.01 H | 29 | 28.2 | 17.2 |
| ANTENNA POLARITY & TEST DISTANCE: VERTICAL AT 3 M | | | | | | | | |
| NO. | FREQ. (MHz) | EMISSION LEVEL (dBuV/m) | LIMIT (dBuV/m) | MARGIN (dB) | ANTENNA HEIGHT (m) | TABLE ANGLE (Degree) | RAW VALUE (dBuV) | CORRECTION FACTOR (dB/m) |
| 1 | 5150.00 | 55.5 PK | 74.0 | -18.5 | 1.70 V | 346 | 51.9 | 3.6 |
| 2 | 5150.00 | 43.6 AV | 54.0 | -10.4 | 1.70 V | 346 | 40.0 | 3.6 |
| 3 | *5290.00 | 111.3 PK | | | 1.91 V | 348 | 71.7 | 39.6 |
| 4 | *5290.00 | 100.9 AV | | | 1.91 V | 348 | 61.3 | 39.6 |
| 5 | 5350.00 | 69.2 PK | 74.0 | -4.8 | 1.85 V | 349 | 65.3 | 3.9 |
| 6 | 5350.00 | 50.4 AV | 54.0 | -3.6 | 1.85 V | 349 | 46.5 | 3.9 |
| 7 | #10580.00 | 58.2 PK | 74.0 | -15.8 | 1.90 V | 298 | 41.0 | 17.2 |
| 8 | #10580.00 | 45.1 AV | 54.0 | -8.9 | 1.90 V | 298 | 27.9 | 17.2 |

Remarks:

1. Emission Level(dBuV/m) = Raw Value(dBuV) + Correction Factor(dB/m)
2. Correction Factor(dB/m) = Antenna Factor(dB/m) + Cable Factor(dB) – Pre-Amplifier Factor(dB)
3. The other emission levels were very low against the limit.
4. Margin value = Emission Level – Limit value
5. " * ": Fundamental frequency.
6. " # ": The radiated frequency is out of the restricted band.

| | | | |
|-----------------|----------------|----------------------|--------------|
| CHANNEL | TX Channel 106 | DETECTOR FUNCTION | Peak (PK) |
| FREQUENCY RANGE | 1GHz ~ 40GHz | | Average (AV) |

ANTENNA POLARITY & TEST DISTANCE: HORIZONTAL AT 3 M

| NO. | FREQ. (MHz) | EMISSION LEVEL (dBuV/m) | LIMIT (dBuV/m) | MARGIN (dB) | ANTENNA HEIGHT (m) | TABLE ANGLE (Degree) | RAW VALUE (dBuV) | CORRECTION FACTOR (dB/m) |
|-----|----------------|-------------------------------|-------------------|----------------|--------------------------|----------------------------|------------------------|--------------------------------|
| 1 | 5460.00 | 68.5 PK | 74.0 | -5.5 | 1.71 H | 349 | 64.5 | 4.0 |
| 2 | 5460.00 | 52.4 AV | 54.0 | -1.6 | 1.71 H | 349 | 48.4 | 4.0 |
| 3 | #5470.00 | 70.5 PK | 74.0 | -3.5 | 1.63 H | 352 | 66.5 | 4.0 |
| 4 | #5470.00 | 52.0 AV | 54.0 | -2.0 | 1.63 H | 352 | 48.0 | 4.0 |
| 5 | *5530.00 | 111.6 PK | | | 1.67 H | 352 | 71.6 | 40.0 |
| 6 | *5530.00 | 100.7 AV | | | 1.67 H | 352 | 60.7 | 40.0 |
| 7 | #5725.00 | 56.5 PK | 74.0 | -17.5 | 1.65 H | 351 | 52.0 | 4.5 |
| 8 | #5725.00 | 45.3 AV | 54.0 | -8.7 | 1.65 H | 351 | 40.8 | 4.5 |
| 9 | 11060.00 | 59.6 PK | 74.0 | -14.4 | 2.27 H | 24 | 41.0 | 18.6 |
| 10 | 11060.00 | 47.0 AV | 54.0 | -7.0 | 2.27 H | 24 | 28.4 | 18.6 |

ANTENNA POLARITY & TEST DISTANCE: VERTICAL AT 3 M

| NO. | FREQ. (MHz) | EMISSION LEVEL (dBuV/m) | LIMIT (dBuV/m) | MARGIN (dB) | ANTENNA HEIGHT (m) | TABLE ANGLE (Degree) | RAW VALUE (dBuV) | CORRECTION FACTOR (dB/m) |
|-----|----------------|-------------------------------|-------------------|----------------|--------------------------|----------------------------|------------------------|--------------------------------|
| 1 | 5460.00 | 69.3 PK | 74.0 | -4.7 | 1.93 V | 347 | 65.3 | 4.0 |
| 2 | 5460.00 | 52.4 AV | 54.0 | -1.6 | 1.93 V | 347 | 48.4 | 4.0 |
| 3 | #5470.00 | 60.0 PK | 74.0 | -14.0 | 1.96 V | 347 | 56.0 | 4.0 |
| 4 | #5470.00 | 48.6 AV | 54.0 | -5.4 | 1.96 V | 347 | 44.6 | 4.0 |
| 5 | *5530.00 | 111.5 PK | | | 1.91 V | 345 | 71.5 | 40.0 |
| 6 | *5530.00 | 101.6 AV | | | 1.91 V | 345 | 61.6 | 40.0 |
| 7 | #5725.00 | 56.6 PK | 74.0 | -17.4 | 1.90 V | 344 | 52.1 | 4.5 |
| 8 | #5725.00 | 44.6 AV | 54.0 | -9.4 | 1.90 V | 344 | 40.1 | 4.5 |
| 9 | 11060.00 | 59.9 PK | 74.0 | -14.1 | 1.53 V | 273 | 41.3 | 18.6 |
| 10 | 11060.00 | 46.6 AV | 54.0 | -7.4 | 1.53 V | 273 | 28.0 | 18.6 |

Remarks:

1. Emission Level(dBuV/m) = Raw Value(dBuV) + Correction Factor(dB/m)
2. Correction Factor(dB/m) = Antenna Factor(dB/m) + Cable Factor(dB) – Pre-Amplifier Factor(dB)
3. The other emission levels were very low against the limit.
4. Margin value = Emission Level – Limit value
5. " * ": Fundamental frequency.
6. " # ": The radiated frequency is out of the restricted band.

| | | | |
|-----------------|----------------|----------------------|--------------|
| CHANNEL | TX Channel 122 | DETECTOR FUNCTION | Peak (PK) |
| FREQUENCY RANGE | 1GHz ~ 40GHz | | Average (AV) |

ANTENNA POLARITY & TEST DISTANCE: HORIZONTAL AT 3 M

| NO. | FREQ. (MHz) | EMISSION LEVEL (dBuV/m) | LIMIT (dBuV/m) | MARGIN (dB) | ANTENNA HEIGHT (m) | TABLE ANGLE (Degree) | RAW VALUE (dBuV) | CORRECTION FACTOR (dB/m) |
|-----|----------------|-------------------------------|-------------------|----------------|--------------------------|----------------------------|------------------------|--------------------------------|
| 1 | 5460.00 | 57.0 PK | 74.0 | -17.0 | 1.59 H | 340 | 53.0 | 4.0 |
| 2 | 5460.00 | 46.5 AV | 54.0 | -7.5 | 1.59 H | 340 | 42.5 | 4.0 |
| 3 | #5470.00 | 57.9 PK | 74.0 | -16.1 | 1.90 H | 355 | 53.9 | 4.0 |
| 4 | #5470.00 | 44.4 AV | 54.0 | -9.6 | 1.90 H | 355 | 40.4 | 4.0 |
| 5 | *5610.00 | 111.5 PK | | | 1.77 H | 348 | 71.3 | 40.2 |
| 6 | *5610.00 | 101.6 AV | | | 1.77 H | 348 | 61.4 | 40.2 |
| 7 | #5725.00 | 60.2 PK | 74.0 | -13.8 | 1.89 H | 353 | 55.7 | 4.5 |
| 8 | #5725.00 | 47.0 AV | 54.0 | -7.0 | 1.89 H | 353 | 42.5 | 4.5 |
| 9 | 11220.00 | 60.2 PK | 74.0 | -13.8 | 2.19 H | 46 | 41.3 | 18.9 |
| 10 | 11220.00 | 47.3 AV | 54.0 | -6.7 | 2.19 H | 46 | 28.4 | 18.9 |

ANTENNA POLARITY & TEST DISTANCE: VERTICAL AT 3 M

| NO. | FREQ. (MHz) | EMISSION LEVEL (dBuV/m) | LIMIT (dBuV/m) | MARGIN (dB) | ANTENNA HEIGHT (m) | TABLE ANGLE (Degree) | RAW VALUE (dBuV) | CORRECTION FACTOR (dB/m) |
|-----|----------------|-------------------------------|-------------------|----------------|--------------------------|----------------------------|------------------------|--------------------------------|
| 1 | 5460.00 | 55.3 PK | 74.0 | -18.7 | 1.70 V | 352 | 51.3 | 4.0 |
| 2 | 5460.00 | 44.6 AV | 54.0 | -9.4 | 1.70 V | 352 | 40.6 | 4.0 |
| 3 | #5470.00 | 59.3 PK | 74.0 | -14.7 | 1.70 V | 335 | 55.3 | 4.0 |
| 4 | #5470.00 | 48.4 AV | 54.0 | -5.6 | 1.70 V | 335 | 44.4 | 4.0 |
| 5 | *5610.00 | 110.6 PK | | | 1.60 V | 351 | 70.4 | 40.2 |
| 6 | *5610.00 | 100.4 AV | | | 1.60 V | 351 | 60.2 | 40.2 |
| 7 | #5725.00 | 58.4 PK | 74.0 | -15.6 | 1.66 V | 350 | 53.9 | 4.5 |
| 8 | #5725.00 | 47.4 AV | 54.0 | -6.6 | 1.66 V | 350 | 42.9 | 4.5 |
| 9 | 11220.00 | 59.2 PK | 74.0 | -14.8 | 1.22 V | 360 | 40.3 | 18.9 |
| 10 | 11220.00 | 46.8 AV | 54.0 | -7.2 | 1.22 V | 360 | 27.9 | 18.9 |

Remarks:

1. Emission Level(dBuV/m) = Raw Value(dBuV) + Correction Factor(dB/m)
2. Correction Factor(dB/m) = Antenna Factor(dB/m) + Cable Factor(dB) – Pre-Amplifier Factor(dB)
3. The other emission levels were very low against the limit.
4. Margin value = Emission Level – Limit value
5. " * ": Fundamental frequency.
6. " # ": The radiated frequency is out of the restricted band.

| | | | |
|-----------------|----------------|----------------------|--------------|
| CHANNEL | TX Channel 138 | DETECTOR FUNCTION | Peak (PK) |
| FREQUENCY RANGE | 1GHz ~ 40GHz | | Average (AV) |

ANTENNA POLARITY & TEST DISTANCE: HORIZONTAL AT 3 M

| NO. | FREQ. (MHz) | EMISSION LEVEL (dBuV/m) | LIMIT (dBuV/m) | MARGIN (dB) | ANTENNA HEIGHT (m) | TABLE ANGLE (Degree) | RAW VALUE (dBuV) | CORRECTION FACTOR (dB/m) |
|-----|----------------|-------------------------------|-------------------|----------------|--------------------------|----------------------------|------------------------|--------------------------------|
| 1 | #5470.00 | 54.1 PK | 74.0 | -19.9 | 1.59 H | 341 | 50.1 | 4.0 |
| 2 | #5470.00 | 43.3 AV | 54.0 | -10.7 | 1.59 H | 341 | 39.3 | 4.0 |
| 3 | *5690.00 | 111.7 PK | | | 1.72 H | 348 | 71.4 | 40.3 |
| 4 | *5690.00 | 101.5 AV | | | 1.72 H | 348 | 61.2 | 40.3 |
| 5 | #5850.00 | 57.5 PK | 74.0 | -16.5 | 1.77 H | 335 | 52.7 | 4.8 |
| 6 | #5850.00 | 46.4 AV | 54.0 | -7.6 | 1.77 H | 335 | 41.6 | 4.8 |
| 7 | 11380.00 | 59.7 PK | 74.0 | -14.3 | 2.25 H | 36 | 41.4 | 18.3 |
| 8 | 11380.00 | 46.3 AV | 54.0 | -7.7 | 2.25 H | 36 | 28.0 | 18.3 |

ANTENNA POLARITY & TEST DISTANCE: VERTICAL AT 3 M

| NO. | FREQ. (MHz) | EMISSION LEVEL (dBuV/m) | LIMIT (dBuV/m) | MARGIN (dB) | ANTENNA HEIGHT (m) | TABLE ANGLE (Degree) | RAW VALUE (dBuV) | CORRECTION FACTOR (dB/m) |
|-----|----------------|-------------------------------|-------------------|----------------|--------------------------|----------------------------|------------------------|--------------------------------|
| 1 | #5470.00 | 55.3 PK | 74.0 | -18.7 | 1.82 V | 345 | 51.3 | 4.0 |
| 2 | #5470.00 | 45.1 AV | 54.0 | -8.9 | 1.82 V | 345 | 41.1 | 4.0 |
| 3 | *5690.00 | 111.2 PK | | | 1.81 V | 348 | 70.9 | 40.3 |
| 4 | *5690.00 | 101.3 AV | | | 1.81 V | 348 | 61.0 | 40.3 |
| 5 | #5850.00 | 56.8 PK | 74.0 | -17.2 | 1.59 V | 356 | 52.0 | 4.8 |
| 6 | #5850.00 | 47.3 AV | 54.0 | -6.7 | 1.59 V | 356 | 42.5 | 4.8 |
| 7 | 11380.00 | 59.1 PK | 74.0 | -14.9 | 1.32 V | 359 | 40.8 | 18.3 |
| 8 | 11380.00 | 45.9 AV | 54.0 | -8.1 | 1.32 V | 359 | 27.6 | 18.3 |

Remarks:

1. Emission Level(dBuV/m) = Raw Value(dBuV) + Correction Factor(dB/m)
2. Correction Factor(dB/m) = Antenna Factor(dB/m) + Cable Factor(dB) – Pre-Amplifier Factor(dB)
3. The other emission levels were very low against the limit.
4. Margin value = Emission Level – Limit value
5. " * ": Fundamental frequency.
6. " # ": The radiated frequency is out of the restricted band.

Below 1GHz Worst-Case Data: 802.11a

Mode A1

| | | | |
|-----------------|---------------|----------------------|-----------------|
| CHANNEL | TX Channel 52 | DETECTOR FUNCTION | Quasi-Peak (QP) |
| FREQUENCY RANGE | 9kHz ~ 1GHz | | |

ANTENNA POLARITY & TEST DISTANCE: HORIZONTAL AT 3 M

| NO. | FREQ. (MHz) | EMISSION LEVEL (dBuV/m) | LIMIT (dBuV/m) | MARGIN (dB) | ANTENNA HEIGHT (m) | TABLE ANGLE (Degree) | RAW VALUE (dBuV) | CORRECTION FACTOR (dB/m) |
|-----|----------------|-------------------------------|-------------------|----------------|--------------------------|----------------------------|------------------------|--------------------------------|
| 1 | 84.34 | 36.1 QP | 40.0 | -3.9 | 1.50 H | 279 | 55.5 | -19.4 |
| 2 | 142.67 | 33.0 QP | 43.5 | -10.5 | 1.00 H | 114 | 47.2 | -14.2 |
| 3 | 189.33 | 38.2 QP | 43.5 | -5.3 | 1.00 H | 14 | 54.4 | -16.2 |
| 4 | 216.55 | 34.2 QP | 46.0 | -11.8 | 1.00 H | 271 | 50.3 | -16.1 |
| 5 | 743.45 | 34.8 QP | 46.0 | -11.2 | 1.00 H | 14 | 39.8 | -5.0 |
| 6 | 875.67 | 35.3 QP | 46.0 | -10.7 | 1.50 H | 53 | 38.8 | -3.5 |

ANTENNA POLARITY & TEST DISTANCE: VERTICAL AT 3 M

| NO. | FREQ. (MHz) | EMISSION LEVEL (dBuV/m) | LIMIT (dBuV/m) | MARGIN (dB) | ANTENNA HEIGHT (m) | TABLE ANGLE (Degree) | RAW VALUE (dBuV) | CORRECTION FACTOR (dB/m) |
|-----|----------------|-------------------------------|-------------------|----------------|--------------------------|----------------------------|------------------------|--------------------------------|
| 1 | 30.90 | 35.1 QP | 40.0 | -4.9 | 2.00 V | 129 | 51.5 | -16.4 |
| 2 | 61.01 | 38.0 QP | 40.0 | -2.0 | 1.51 V | 9 | 53.0 | -15.0 |
| 3 | 78.51 | 37.0 QP | 40.0 | -3.0 | 2.00 V | 123 | 55.2 | -18.2 |
| 4 | 142.67 | 32.2 QP | 43.5 | -11.3 | 1.51 V | 9 | 46.4 | -14.2 |
| 5 | 191.28 | 37.0 QP | 43.5 | -6.5 | 2.00 V | 9 | 53.4 | -16.4 |
| 6 | 743.45 | 39.0 QP | 46.0 | -7.0 | 1.00 V | 3 | 44.0 | -5.0 |

Remarks:

1. Emission Level(dBuV/m) = Raw Value(dBuV) + Correction Factor(dB/m)
2. Correction Factor(dB/m) = Antenna Factor(dB/m) + Cable Factor(dB) – Pre-Amplifier Factor(dB)
3. The other emission levels were very low against the limit.
4. Margin value = Emission Level – Limit value

Mode A2

| | | | |
|-----------------|---------------|----------------------|-----------------|
| CHANNEL | TX Channel 52 | DETECTOR FUNCTION | Quasi-Peak (QP) |
| FREQUENCY RANGE | 9kHz ~ 1GHz | | |

| ANTENNA POLARITY & TEST DISTANCE: HORIZONTAL AT 3 M | | | | | | | | |
|---|----------------|-------------------------------|-------------------|----------------|--------------------------|----------------------------|------------------------|--------------------------------|
| NO. | FREQ. (MHz) | EMISSION LEVEL (dBuV/m) | LIMIT (dBuV/m) | MARGIN (dB) | ANTENNA HEIGHT (m) | TABLE ANGLE (Degree) | RAW VALUE (dBuV) | CORRECTION FACTOR (dB/m) |
| 1 | 61.01 | 35.5 QP | 40.0 | -4.5 | 1.50 H | 220 | 50.5 | -15.0 |
| 2 | 76.56 | 38.9 QP | 40.0 | -1.1 | 1.50 H | 173 | 56.5 | -17.6 |
| 3 | 117.39 | 33.3 QP | 43.5 | -10.2 | 1.50 H | 268 | 49.7 | -16.4 |
| 4 | 185.44 | 37.7 QP | 43.5 | -5.8 | 1.50 H | 238 | 53.6 | -15.9 |
| 5 | 729.84 | 42.2 QP | 46.0 | -3.8 | 1.01 H | 54 | 47.6 | -5.4 |
| 6 | 932.05 | 40.7 QP | 46.0 | -5.3 | 1.01 H | 34 | 43.1 | -2.4 |

| ANTENNA POLARITY & TEST DISTANCE: VERTICAL AT 3 M | | | | | | | | |
|---|----------------|-------------------------------|-------------------|----------------|--------------------------|----------------------------|------------------------|--------------------------------|
| NO. | FREQ. (MHz) | EMISSION LEVEL (dBuV/m) | LIMIT (dBuV/m) | MARGIN (dB) | ANTENNA HEIGHT (m) | TABLE ANGLE (Degree) | RAW VALUE (dBuV) | CORRECTION FACTOR (dB/m) |
| 1 | 39.62 | 37.8 QP | 40.0 | -2.2 | 1.00 V | 279 | 53.1 | -15.3 |
| 2 | 61.01 | 38.2 QP | 40.0 | -1.8 | 1.00 V | 332 | 53.2 | -15.0 |
| 3 | 96.01 | 31.6 QP | 43.5 | -11.9 | 1.00 V | 85 | 50.6 | -19.0 |
| 4 | 193.22 | 35.7 QP | 43.5 | -7.8 | 1.00 V | 83 | 52.2 | -16.5 |
| 5 | 875.67 | 32.2 QP | 46.0 | -13.8 | 1.49 V | 1 | 35.7 | -3.5 |
| 6 | 932.05 | 40.4 QP | 46.0 | -5.6 | 1.00 V | 291 | 42.8 | -2.4 |

Remarks:

1. Emission Level(dBuV/m) = Raw Value(dBuV) + Correction Factor(dB/m)
2. Correction Factor(dB/m) = Antenna Factor(dB/m) + Cable Factor(dB) – Pre-Amplifier Factor(dB)
3. The other emission levels were very low against the limit.
4. Margin value = Emission Level – Limit value

Mode B1

| | | | |
|-----------------|---------------|----------------------|-----------------|
| CHANNEL | TX Channel 52 | DETECTOR FUNCTION | Quasi-Peak (QP) |
| FREQUENCY RANGE | 9kHz ~ 1GHz | | |

| ANTENNA POLARITY & TEST DISTANCE: HORIZONTAL AT 3 M | | | | | | | | |
|---|----------------|-------------------------------|-------------------|----------------|--------------------------|----------------------------|------------------------|--------------------------------|
| NO. | FREQ. (MHz) | EMISSION LEVEL (dBuV/m) | LIMIT (dBuV/m) | MARGIN (dB) | ANTENNA HEIGHT (m) | TABLE ANGLE (Degree) | RAW VALUE (dBuV) | CORRECTION FACTOR (dB/m) |
| 1 | 80.45 | 37.1 QP | 40.0 | -2.9 | 2.00 H | 111 | 55.7 | -18.6 |
| 2 | 138.78 | 35.1 QP | 43.5 | -8.4 | 2.00 H | 83 | 49.6 | -14.5 |
| 3 | 187.39 | 36.2 QP | 43.5 | -7.3 | 1.51 H | 30 | 52.3 | -16.1 |
| 4 | 216.55 | 34.1 QP | 46.0 | -11.9 | 1.00 H | 260 | 50.2 | -16.1 |
| 5 | 500.42 | 31.3 QP | 46.0 | -14.7 | 1.00 H | 16 | 40.8 | -9.5 |
| 6 | 731.79 | 42.2 QP | 46.0 | -3.8 | 2.00 H | 257 | 47.4 | -5.2 |
| ANTENNA POLARITY & TEST DISTANCE: VERTICAL AT 3 M | | | | | | | | |
| NO. | FREQ. (MHz) | EMISSION LEVEL (dBuV/m) | LIMIT (dBuV/m) | MARGIN (dB) | ANTENNA HEIGHT (m) | TABLE ANGLE (Degree) | RAW VALUE (dBuV) | CORRECTION FACTOR (dB/m) |
| 1 | 30.90 | 37.8 QP | 40.0 | -2.2 | 1.49 V | 11 | 54.2 | -16.4 |
| 2 | 47.40 | 37.0 QP | 40.0 | -3.0 | 1.30 V | 254 | 51.5 | -14.5 |
| 3 | 72.67 | 34.9 QP | 40.0 | -5.1 | 1.30 V | 4 | 51.7 | -16.8 |
| 4 | 142.67 | 39.5 QP | 43.5 | -4.0 | 1.00 V | 213 | 53.7 | -14.2 |
| 5 | 193.22 | 28.7 QP | 43.5 | -14.8 | 1.00 V | 36 | 45.2 | -16.5 |
| 6 | 745.40 | 33.5 QP | 46.0 | -12.5 | 1.30 V | 77 | 38.4 | -4.9 |

Remarks:

1. Emission Level(dBuV/m) = Raw Value(dBuV) + Correction Factor(dB/m)
2. Correction Factor(dB/m) = Antenna Factor(dB/m) + Cable Factor(dB) – Pre-Amplifier Factor(dB)
3. The other emission levels were very low against the limit.
4. Margin value = Emission Level – Limit value

Mode B2

| | | | |
|-----------------|---------------|----------------------|-----------------|
| CHANNEL | TX Channel 52 | DETECTOR FUNCTION | Quasi-Peak (QP) |
| FREQUENCY RANGE | 9kHz ~ 1GHz | | |

| ANTENNA POLARITY & TEST DISTANCE: HORIZONTAL AT 3 M | | | | | | | | |
|---|----------------|-------------------------------|-------------------|----------------|--------------------------|----------------------------|------------------------|--------------------------------|
| NO. | FREQ. (MHz) | EMISSION LEVEL (dBuV/m) | LIMIT (dBuV/m) | MARGIN (dB) | ANTENNA HEIGHT (m) | TABLE ANGLE (Degree) | RAW VALUE (dBuV) | CORRECTION FACTOR (dB/m) |
| 1 | 61.01 | 35.3 QP | 40.0 | -4.7 | 1.50 H | 162 | 50.3 | -15.0 |
| 2 | 76.56 | 38.3 QP | 40.0 | -1.7 | 2.00 H | 174 | 55.9 | -17.6 |
| 3 | 90.17 | 37.5 QP | 43.5 | -6.0 | 2.00 H | 259 | 57.1 | -19.6 |
| 4 | 119.34 | 34.4 QP | 43.5 | -9.1 | 1.50 H | 275 | 50.6 | -16.2 |
| 5 | 185.44 | 36.9 QP | 43.5 | -6.6 | 1.50 H | 236 | 52.8 | -15.9 |
| 6 | 932.05 | 40.6 QP | 46.0 | -5.4 | 2.00 H | 216 | 43.0 | -2.4 |
| ANTENNA POLARITY & TEST DISTANCE: VERTICAL AT 3 M | | | | | | | | |
| NO. | FREQ. (MHz) | EMISSION LEVEL (dBuV/m) | LIMIT (dBuV/m) | MARGIN (dB) | ANTENNA HEIGHT (m) | TABLE ANGLE (Degree) | RAW VALUE (dBuV) | CORRECTION FACTOR (dB/m) |
| 1 | 37.68 | 37.9 QP | 40.0 | -2.1 | 1.00 V | 325 | 53.4 | -15.5 |
| 2 | 61.01 | 38.4 QP | 40.0 | -1.6 | 1.00 V | 18 | 53.4 | -15.0 |
| 3 | 97.95 | 31.2 QP | 43.5 | -12.3 | 1.50 V | 126 | 50.0 | -18.8 |
| 4 | 197.11 | 35.0 QP | 43.5 | -8.5 | 1.00 V | 297 | 51.6 | -16.6 |
| 5 | 875.67 | 32.2 QP | 46.0 | -13.8 | 1.00 V | 7 | 35.7 | -3.5 |
| 6 | 933.99 | 41.7 QP | 46.0 | -4.3 | 1.50 V | 9 | 44.1 | -2.4 |

Remarks:

1. Emission Level(dBuV/m) = Raw Value(dBuV) + Correction Factor(dB/m)
2. Correction Factor(dB/m) = Antenna Factor(dB/m) + Cable Factor(dB) – Pre-Amplifier Factor(dB)
3. The other emission levels were very low against the limit.
4. Margin value = Emission Level – Limit value

4.2 Conducted Emission Measurement

4.2.1 Limits of Conducted Emission Measurement

FCC PART 15.207:

| Frequency (MHz) | Conducted Limit (dBuV) | |
|-----------------|------------------------|---------|
| | Quasi-peak | Average |
| 0.15 - 0.5 | 66 - 56 | 56 - 46 |
| 0.50 - 5.0 | 56 | 46 |
| 5.0 - 30.0 | 60 | 50 |

Note: 1. The lower limit shall apply at the transition frequencies.

2. The limit decreases in line with the logarithm of the frequency in the range of 0.15 to 0.50MHz.

4.2.2 Test Instruments

| Description & Manufacturer | Model No. | Serial No. | Cal. Date | Cal. Due |
|--|--------------------------|----------------|---------------|---------------|
| Test Receiver ROHDE & SCHWARZ | ESCS 30 | 100288 | Aug. 17, 2017 | Aug. 16, 2018 |
| RF signal cable (with 10dB PAD) Woken | 5D-FB | Cable-cond1-01 | Sep. 05, 2017 | Sep. 04, 2018 |
| LISN ROHDE & SCHWARZ (EUT) | ESH3-Z5 | 835239/001 | Mar. 10, 2017 | Mar. 09, 2018 |
| LISN ROHDE & SCHWARZ (Peripheral) | ESH3-Z5 | 100311 | Aug. 15, 2017 | Aug. 14, 2018 |
| Software ADT | BV ADT_Cond_ V7.3.7.3 | NA | NA | NA |

Note: 1. The calibration interval of the above test instruments is 12 months and the calibrations are traceable to NML/ROC and NIST/USA.

2. The test was performed in HwaYa Shielded Room 1.

3. The VCCI Site Registration No. is C-2040.

4.2.3 Test Procedures

- The EUT was placed 0.4 meters from the conducting wall of the shielded room with EUT being connected to the power mains through a line impedance stabilization network (LISN). Other support units were connected to the power mains through another LISN. The two LISNs provide 50 ohm/ 50uH of coupling impedance for the measuring instrument.
- Both lines of the power mains connected to the EUT were checked for maximum conducted interference.
- The frequency range from 150kHz to 30MHz was searched. Emission levels under (Limit - 20dB) was not recorded.

NOTE: The resolution bandwidth and video bandwidth of test receiver is 9kHz for quasi-peak detection (QP) and average detection (AV) at frequency 0.15MHz-30MHz.

4.2.4 Deviation from Test Standard

No deviation.

4.2.5 Test Setup

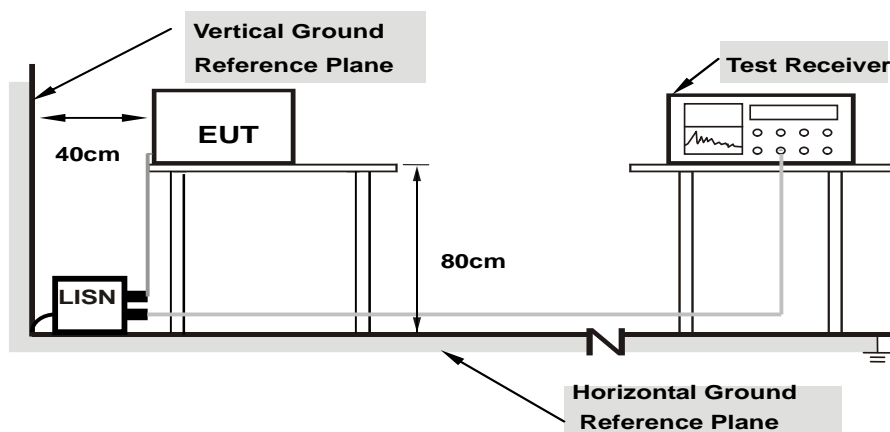

Note: 1.Support units were connected to second LISN.

For the actual test configuration, please refer to the attached file (Test Setup Photo).

4.2.6 EUT Operating Conditions

Same as 4.1.6.

4.2.7 Test Results

Worst-case data: 802.11a

Mode A1

| Phase | Line (L) | Detector Function | Quasi-Peak (QP) / Average (AV) |
|-------|----------|-------------------|--------------------------------|
|-------|----------|-------------------|--------------------------------|

| No | Freq. [MHz] | Corr. Factor (dB) | Reading Value [dB (uV)] | | Emission Level [dB (uV)] | | Limit [dB (uV)] | | Margin (dB) | |
|----------|----------------|-------------------------|----------------------------|--------------|-----------------------------|--------------|--------------------|--------------|----------------|--------------|
| | | | Q.P. | AV. | Q.P. | AV. | Q.P. | AV. | Q.P. | AV. |
| | | | 1 | 0.15000 | 10.39 | 38.00 | 20.77 | 48.39 | 31.16 | 66.00 |
| 2 | 0.25948 | 10.40 | 23.42 | 15.33 | 33.82 | 25.73 | 61.45 | 51.45 | -27.63 | -25.72 |
| 3 | 0.53240 | 10.41 | 37.44 | 32.49 | 47.85 | 42.90 | 56.00 | 46.00 | -8.15 | -3.10 |
| 4 | 0.75188 | 10.42 | 21.81 | 16.73 | 32.23 | 27.15 | 56.00 | 46.00 | -23.77 | -18.85 |
| 5 | 5.49888 | 10.63 | 19.70 | 13.68 | 30.33 | 24.31 | 60.00 | 50.00 | -29.67 | -25.69 |
| 6 | 10.47240 | 10.88 | 23.10 | 18.13 | 33.98 | 29.01 | 60.00 | 50.00 | -26.02 | -20.99 |

Remarks:

1. Q.P. and AV. are abbreviations of quasi-peak and average individually.
2. The emission levels of other frequencies were very low against the limit.
3. Margin value = Emission level - Limit value
4. Correction factor = Insertion loss + Cable loss
5. Emission Level = Correction Factor + Reading Value.

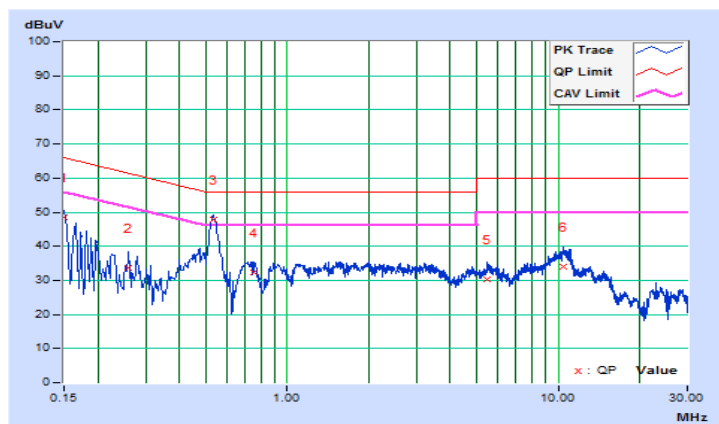

| | | | |
|-------|-------------|-------------------|--------------------------------|
| Phase | Neutral (N) | Detector Function | Quasi-Peak (QP) / Average (AV) |
|-------|-------------|-------------------|--------------------------------|

| No | Freq. [MHz] | Corr. Factor (dB) | Reading Value [dB (uV)] | | Emission Level [dB (uV)] | | Limit [dB (uV)] | | Margin (dB) | |
|----|----------------|-------------------------|----------------------------|---------|-----------------------------|-------|--------------------|-------|----------------|--------|
| | | | Q.P. | AV. | Q.P. | AV. | Q.P. | AV. | Q.P. | AV. |
| | | | 1 | 0.16173 | 10.16 | 34.40 | 17.90 | 44.56 | 28.06 | 65.37 |
| 2 | 0.19692 | 10.16 | 27.76 | 12.37 | 37.92 | 22.53 | 63.74 | 53.74 | -25.82 | -31.21 |
| 3 | 0.53318 | 10.17 | 33.32 | 28.29 | 43.49 | 38.46 | 56.00 | 46.00 | -12.51 | -7.54 |
| 4 | 0.72084 | 10.18 | 20.73 | 16.36 | 30.91 | 26.54 | 56.00 | 46.00 | -25.09 | -19.46 |
| 5 | 2.56247 | 10.26 | 20.51 | 15.76 | 30.77 | 26.02 | 56.00 | 46.00 | -25.23 | -19.98 |
| 6 | 10.85949 | 10.61 | 22.49 | 17.77 | 33.10 | 28.38 | 60.00 | 50.00 | -26.90 | -21.62 |

Remarks:

1. Q.P. and AV. are abbreviations of quasi-peak and average individually.
2. The emission levels of other frequencies were very low against the limit.
3. Margin value = Emission level - Limit value
4. Correction factor = Insertion loss + Cable loss
5. Emission Level = Correction Factor + Reading Value.

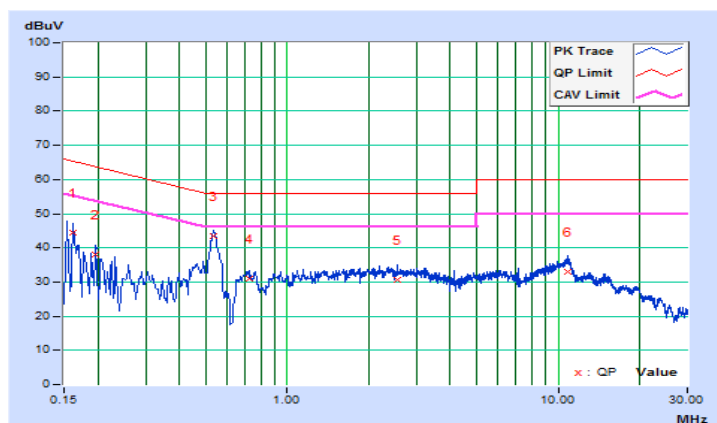

Mode A2

| Phase | Line (L) | Detector Function | Quasi-Peak (QP) / Average (AV) |
|-------|----------|-------------------|--------------------------------|
|-------|----------|-------------------|--------------------------------|

| No | Freq. [MHz] | Corr. Factor (dB) | Reading Value [dB (uV)] | | Emission Level [dB (uV)] | | Limit [dB (uV)] | | Margin (dB) | |
|----|----------------|-------------------------|----------------------------|---------|-----------------------------|-------|--------------------|-------|----------------|--------|
| | | | Q.P. | AV. | Q.P. | AV. | Q.P. | AV. | Q.P. | AV. |
| | | | 1 | 0.15802 | 10.39 | 35.92 | 19.87 | 46.31 | 30.26 | 65.57 |
| 2 | 0.18557 | 10.39 | 30.72 | 15.64 | 41.11 | 26.03 | 64.23 | 54.23 | -23.12 | -28.20 |
| 3 | 0.53240 | 10.41 | 35.07 | 30.07 | 45.48 | 40.48 | 56.00 | 46.00 | -10.52 | -5.52 |
| 4 | 0.71705 | 10.41 | 19.91 | 15.45 | 30.32 | 25.86 | 56.00 | 46.00 | -25.68 | -20.14 |
| 5 | 5.51843 | 10.63 | 16.92 | 10.49 | 27.55 | 21.12 | 60.00 | 50.00 | -32.45 | -28.88 |
| 6 | 10.20261 | 10.87 | 22.03 | 16.80 | 32.90 | 27.67 | 60.00 | 50.00 | -27.10 | -22.33 |

Remarks:

1. Q.P. and AV. are abbreviations of quasi-peak and average individually.
2. The emission levels of other frequencies were very low against the limit.
3. Margin value = Emission level - Limit value
4. Correction factor = Insertion loss + Cable loss
5. Emission Level = Correction Factor + Reading Value.

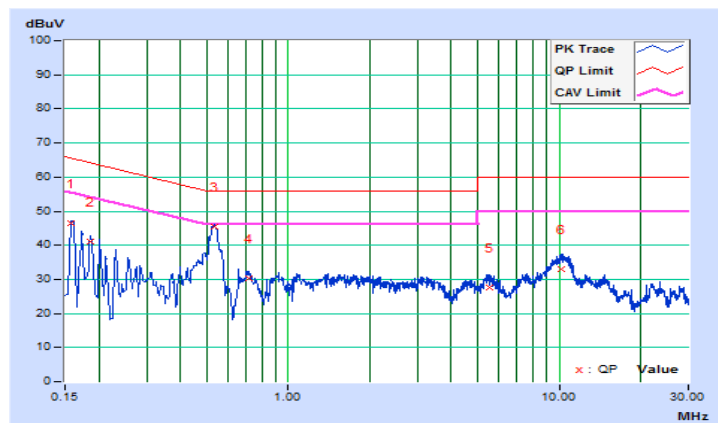

| | | | |
|-------|-------------|-------------------|--------------------------------|
| Phase | Neutral (N) | Detector Function | Quasi-Peak (QP) / Average (AV) |
|-------|-------------|-------------------|--------------------------------|

| No | Freq. [MHz] | Corr. Factor (dB) | Reading Value [dB (uV)] | | Emission Level [dB (uV)] | | Limit [dB (uV)] | | Margin (dB) | |
|----|----------------|----------------------|----------------------------|---------|-----------------------------|-------|--------------------|-------|----------------|--------|
| | | | Q.P. | AV. | Q.P. | AV. | Q.P. | AV. | Q.P. | AV. |
| | | | 1 | 0.15000 | 10.15 | 36.69 | 19.23 | 46.84 | 29.38 | 66.00 |
| 2 | 0.18903 | 10.16 | 30.29 | 14.65 | 40.45 | 24.81 | 64.08 | 54.08 | -23.63 | -29.27 |
| 3 | 0.24775 | 10.16 | 21.71 | 11.93 | 31.87 | 22.09 | 61.83 | 51.83 | -29.96 | -29.74 |
| 4 | 0.53381 | 10.17 | 34.58 | 29.50 | 44.75 | 39.67 | 56.00 | 46.00 | -11.25 | -6.33 |
| 5 | 0.72084 | 10.18 | 21.93 | 17.55 | 32.11 | 27.73 | 56.00 | 46.00 | -23.89 | -18.27 |
| 6 | 10.72655 | 10.61 | 24.13 | 19.45 | 34.74 | 30.06 | 60.00 | 50.00 | -25.26 | -19.94 |

Remarks:

1. Q.P. and AV. are abbreviations of quasi-peak and average individually.
2. The emission levels of other frequencies were very low against the limit.
3. Margin value = Emission level - Limit value
4. Correction factor = Insertion loss + Cable loss
5. Emission Level = Correction Factor + Reading Value.

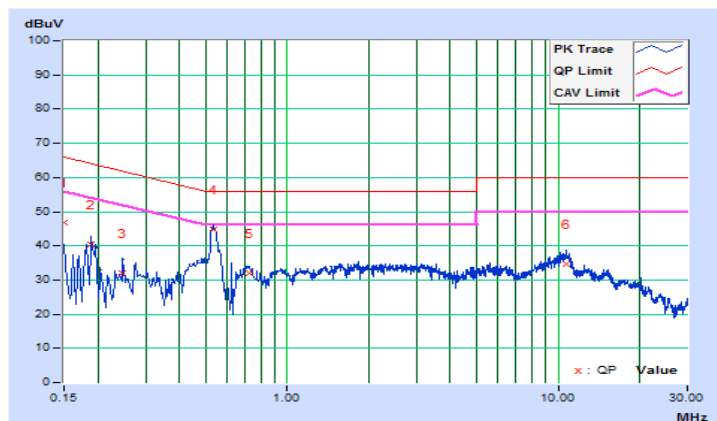

Mode B1

| Phase | Line (L) | Detector Function | Quasi-Peak (QP) / Average (AV) |
|-------|----------|-------------------|--------------------------------|
|-------|----------|-------------------|--------------------------------|

| No | Freq. [MHz] | Corr. Factor (dB) | Reading Value [dB (uV)] | | Emission Level [dB (uV)] | | Limit [dB (uV)] | | Margin (dB) | |
|----|----------------|-------------------------|----------------------------|---------|-----------------------------|-------|--------------------|-------|----------------|--------|
| | | | Q.P. | AV. | Q.P. | AV. | Q.P. | AV. | Q.P. | AV. |
| | | | 1 | 0.16564 | 10.39 | 33.87 | 16.76 | 44.26 | 27.15 | 65.18 |
| 2 | 0.28288 | 10.40 | 21.24 | 15.00 | 31.64 | 25.40 | 60.73 | 50.73 | -29.09 | -25.33 |
| 3 | 0.52821 | 10.41 | 35.67 | 31.07 | 46.08 | 41.48 | 56.00 | 46.00 | -9.92 | -4.52 |
| 4 | 0.68926 | 10.41 | 20.59 | 15.89 | 31.00 | 26.30 | 56.00 | 46.00 | -25.00 | -19.70 |
| 5 | 5.40113 | 10.63 | 17.69 | 11.43 | 28.32 | 22.06 | 60.00 | 50.00 | -31.68 | -27.94 |
| 6 | 10.04979 | 10.86 | 22.01 | 17.04 | 32.87 | 27.90 | 60.00 | 50.00 | -27.13 | -22.10 |

Remarks:

1. Q.P. and AV. are abbreviations of quasi-peak and average individually.
2. The emission levels of other frequencies were very low against the limit.
3. Margin value = Emission level - Limit value
4. Correction factor = Insertion loss + Cable loss
5. Emission Level = Correction Factor + Reading Value.

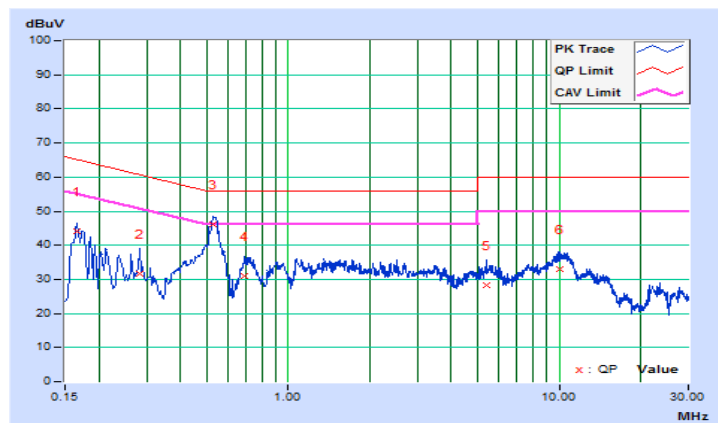

| | | | |
|-------|-------------|-------------------|--------------------------------|
| Phase | Neutral (N) | Detector Function | Quasi-Peak (QP) / Average (AV) |
|-------|-------------|-------------------|--------------------------------|

| No | Freq. [MHz] | Corr. Factor (dB) | Reading Value | | Emission Level | | Limit | | Margin | |
|----|----------------|-------------------------|---------------|-------|----------------|-------|-----------|-------|--------|--------|
| | | | [dB (uV)] | | [dB (uV)] | | [dB (uV)] | | (dB) | |
| | | | Q.P. | AV. | Q.P. | AV. | Q.P. | AV. | Q.P. | AV. |
| 1 | 0.15000 | 10.15 | 36.80 | 19.07 | 46.95 | 29.22 | 66.00 | 56.00 | -19.05 | -26.78 |
| 2 | 0.20865 | 10.16 | 26.72 | 12.80 | 36.88 | 22.96 | 63.26 | 53.26 | -26.38 | -30.30 |
| 3 | 0.26346 | 10.16 | 21.71 | 13.87 | 31.87 | 24.03 | 61.32 | 51.32 | -29.45 | -27.29 |
| 4 | 0.53804 | 10.17 | 33.41 | 28.37 | 43.58 | 38.54 | 56.00 | 46.00 | -12.42 | -7.46 |
| 5 | 0.72084 | 10.18 | 21.27 | 16.90 | 31.45 | 27.08 | 56.00 | 46.00 | -24.55 | -18.92 |
| 6 | 10.74219 | 10.61 | 23.04 | 18.37 | 33.65 | 28.98 | 60.00 | 50.00 | -26.35 | -21.02 |

Remarks:

1. Q.P. and AV. are abbreviations of quasi-peak and average individually.
2. The emission levels of other frequencies were very low against the limit.
3. Margin value = Emission level - Limit value
4. Correction factor = Insertion loss + Cable loss
5. Emission Level = Correction Factor + Reading Value.

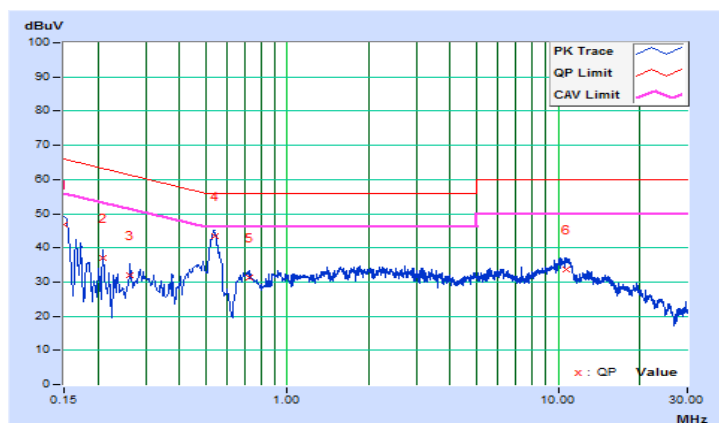

Mode B2

| Phase | Line (L) | Detector Function | Quasi-Peak (QP) / Average (AV) |
|-------|----------|-------------------|--------------------------------|
|-------|----------|-------------------|--------------------------------|

| No | Freq. [MHz] | Corr. Factor (dB) | Reading Value [dB (uV)] | | Emission Level [dB (uV)] | | Limit [dB (uV)] | | Margin (dB) | |
|----|----------------|----------------------|----------------------------|---------|-----------------------------|-------|--------------------|-------|----------------|--------|
| | | | Q.P. | AV. | Q.P. | AV. | Q.P. | AV. | Q.P. | AV. |
| | | | 1 | 0.17737 | 10.39 | 32.53 | 16.55 | 42.92 | 26.94 | 64.61 |
| 2 | 0.23602 | 10.40 | 23.96 | 12.77 | 34.36 | 23.17 | 62.24 | 52.24 | -27.88 | -29.07 |
| 3 | 0.28288 | 10.40 | 20.82 | 14.61 | 31.22 | 25.01 | 60.73 | 50.73 | -29.51 | -25.72 |
| 4 | 0.52960 | 10.41 | 34.98 | 30.39 | 45.39 | 40.80 | 56.00 | 46.00 | -10.61 | -5.20 |
| 5 | 0.73619 | 10.41 | 19.35 | 14.98 | 29.76 | 25.39 | 56.00 | 46.00 | -26.24 | -20.61 |
| 6 | 9.93673 | 10.86 | 21.68 | 16.69 | 32.54 | 27.55 | 60.00 | 50.00 | -27.46 | -22.45 |

Remarks:

1. Q.P. and AV. are abbreviations of quasi-peak and average individually.
2. The emission levels of other frequencies were very low against the limit.
3. Margin value = Emission level - Limit value
4. Correction factor = Insertion loss + Cable loss
5. Emission Level = Correction Factor + Reading Value.

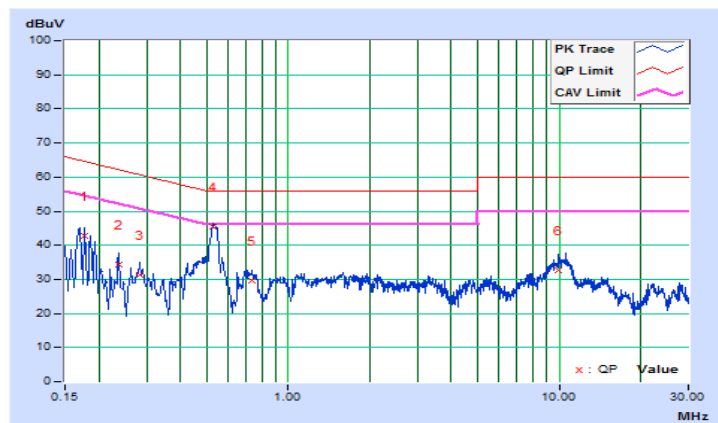

| | | | |
|-------|-------------|-------------------|--------------------------------|
| Phase | Neutral (N) | Detector Function | Quasi-Peak (QP) / Average (AV) |
|-------|-------------|-------------------|--------------------------------|

| No | Freq. [MHz] | Corr. Factor (dB) | Reading Value [dB (uV)] | | Emission Level [dB (uV)] | | Limit [dB (uV)] | | Margin (dB) | |
|----|----------------|-------------------------|----------------------------|---------|-----------------------------|-------|--------------------|-------|----------------|--------|
| | | | Q.P. | AV. | Q.P. | AV. | Q.P. | AV. | Q.P. | AV. |
| | | | 1 | 0.15000 | 10.15 | 36.91 | 19.43 | 47.06 | 29.58 | 66.00 |
| 2 | 0.17346 | 10.16 | 32.10 | 16.07 | 42.26 | 26.23 | 64.79 | 54.79 | -22.53 | -28.56 |
| 3 | 0.19692 | 10.16 | 28.29 | 13.20 | 38.45 | 23.36 | 63.74 | 53.74 | -25.29 | -30.38 |
| 4 | 0.53946 | 10.17 | 33.77 | 28.83 | 43.94 | 39.00 | 56.00 | 46.00 | -12.06 | -7.00 |
| 5 | 2.69541 | 10.27 | 21.36 | 16.64 | 31.63 | 26.91 | 56.00 | 46.00 | -24.37 | -19.09 |
| 6 | 10.84781 | 10.61 | 24.06 | 19.42 | 34.67 | 30.03 | 60.00 | 50.00 | -25.33 | -19.97 |

Remarks:

1. Q.P. and AV. are abbreviations of quasi-peak and average individually.
2. The emission levels of other frequencies were very low against the limit.
3. Margin value = Emission level - Limit value
4. Correction factor = Insertion loss + Cable loss
5. Emission Level = Correction Factor + Reading Value.

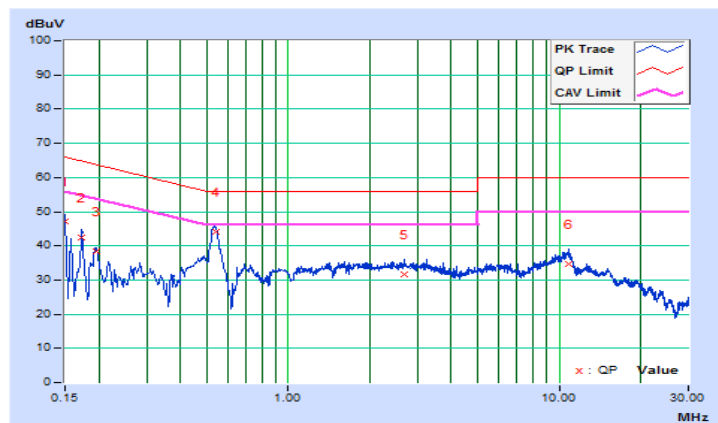

4.3 Transmit Power Measurement

4.3.1 Limits of Transmit Power Measurement

| Operation Band | EUT Category | Limit |
|----------------|-----------------------------------|---|
| U-NII-1 | Outdoor Access Point | 1 Watt (30 dBm) (Max. e.i.r.p \leq 125 mW (21 dBm) at any elevation angle above 30 degrees as measured from the horizon) |
| | Fixed point-to-point Access Point | 1 Watt (30 dBm) |
| | Indoor Access Point | 1 Watt (30 dBm) |
| | Mobile and Portable client device | 250 mW (24 dBm) |
| U-NII-2A | √ | 250 mW (24 dBm) or 11 dBm+10 log B* |
| U-NII-2C | √ | 250 mW (24 dBm) or 11 dBm+10 log B* |
| U-NII-3 | √ | 1 Watt (30 dBm) |

*B is the 26 dB emission bandwidth in megahertz

Per KDB 662911 Method of conducted output power measurement on IEEE 802.11 devices,

Array Gain = 0 dB (i.e., no array gain) for $N_{ANT} \leq 4$;

Array Gain = 0 dB (i.e., no array gain) for channel widths ≥ 40 MHz for any N_{ANT} ;

Array Gain = $5 \log(N_{ANT}/N_{SS})$ dB or 3 dB, whichever is less for 20-MHz channel widths with $N_{ANT} \geq 5$.

For power measurements on all other devices: Array Gain = $10 \log(N_{ANT}/N_{SS})$ dB.

4.3.2 Test Setup

For Power Output

802.11a, 802.11n (HT20), 802.11n (HT40)

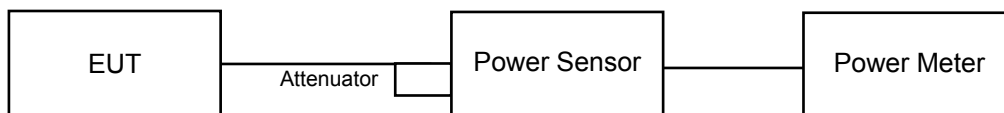

802.11ac (VHT80)

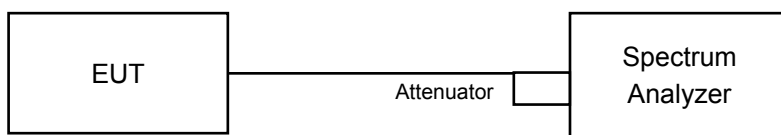

For Bandwidth

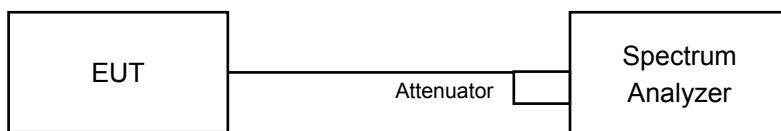

4.3.3 Test Instruments

Refer to section 4.1.2 to get information of above instrument.

4.3.4 Test Procedure

For Average Power Measurement

802.11a, 802.11n (HT20), 802.11n (HT40)

Method PM is used to perform output power measurement, trigger and gating function of wide band power meter is enabled to measure max output power of TX on burst. Duty factor is not added to measured value.

802.11ac (VHT80)

- 1) Set span to encompass the entire 26 dB EBW (or, alternatively, the entire 99% occupied bandwidth) of the signal.
- 2) Set sweep trigger to "free run".
- 3) Set RBW = 1 MHz.
- 4) Set VBW \geq 3 MHz.
- 5) Number of points in sweep \geq 2 Span / RBW.
- 6) Sweep time \leq (number of points in sweep) * T
- 7) Using emission bandwidth to determine the frequency span for integration the channel bandwidth.
- 8) Detector = RMS.
- 9) Trace mode = max hold.
- 10) Allow max hold to run for at least 60 seconds, or longer as needed to allow the trace to stabilize.
- 11) Compute power by integrating the spectrum across the EBW (or, alternatively, the entire 99% occupied bandwidth) of the signal using the instrument's band power measurement function with band limits set equal to the EBW (or occupied bandwidth) band edges. If the instrument does not have a band power function, sum the spectrum levels (in power units) at 1 MHz intervals extending across the EBW (or, alternatively, the entire 99% occupied bandwidth) of the spectrum.

For 26dB Bandwidth

- 1) Set RBW = approximately 1% of the emission bandwidth.
- 2) Set the VBW > RBW.
- 3) Detector = Peak.
- 4) Trace mode = max hold.
- 5) Measure the maximum width of the emission that is 26 dB down from the peak of the emission. Compare this with the RBW setting of the analyzer. Readjust RBW and repeat measurement as needed until the RBW/EBW ratio is approximately 1%.

4.3.5 Deviation from Test Standard

No deviation.

4.3.6 EUT Operating Conditions

The software provided by client to enable the EUT under transmission condition continuously at lowest, middle and highest channel frequencies individually.

4.3.7 Test Result

Power Output:

Mode A1

CDD Mode

802.11a

| Chan. | Freq. (MHz) | Maximum Conducted Power (dBm) | | | | Total Power (mW) | Total Power (dBm) | Power Limit (dBm) | Pass / Fail |
|-------|----------------------|-------------------------------|---------|---------|---------|------------------|-------------------|-------------------|-------------|
| | | Chain 0 | Chain 1 | Chain 2 | Chain 3 | | | | |
| 52 | 5260 | 11.53 | 10.93 | 11.29 | 10.77 | 52.010 | 17.16 | 21.71 | Pass |
| 60 | 5300 | 11.05 | 11.02 | 11.61 | 10.31 | 50.610 | 17.04 | 21.71 | Pass |
| 64 | 5320 | 11.08 | 11.09 | 11.73 | 10.35 | 51.409 | 17.11 | 21.71 | Pass |
| 100 | 5500 | 11.03 | 11.19 | 11.15 | 11.23 | 52.135 | 17.17 | 21.71 | Pass |
| 116 | 5580 | 11.37 | 11.45 | 11.15 | 11.18 | 53.827 | 17.31 | 21.71 | Pass |
| 140 | 5700 | 10.95 | 11.15 | 10.75 | 10.35 | 48.201 | 16.83 | 21.71 | Pass |
| 144 | 5720 For U-NII-2C | 9.55 | 9.80 | 9.56 | 8.77 | 35.136 | 15.46 | 21.71 | Pass |
| 144 | 5720 For U-NII-3 | 4.54 | 4.87 | 4.67 | 4.00 | 11.356 | 10.55 | 29 | Pass |

Note:

- 5260~5320MHz, 5500~5720MHz Gain = 7 > 6dBi, so the limit shall be reduced to 22.71-(7-6) = 21.71dBm.
- 5745~5825MHz Gain = 7 > 6dBi, so the limit shall be reduced to 30-(7-6) = 29dBm.

For U-NII-2A, U-NII-2C

Chain 0

| | | | | | | | | |
|----|---------------|-----------------------|---|-------|-----|---|----|-----|
| 1. | 11dBm + 10log | (19.99) | = | 24.01 | dBm | > | 24 | dBm |
| 2. | 11dBm + 10log | (20.13) | = | 24.04 | dBm | > | 24 | dBm |
| 3. | 11dBm + 10log | (20.10) | = | 24.03 | dBm | > | 24 | dBm |
| 4. | 11dBm + 10log | (20.03) | = | 24.02 | dBm | > | 24 | dBm |
| 5. | 11dBm + 10log | (20.27) | = | 24.07 | dBm | > | 24 | dBm |
| 6. | 11dBm + 10log | (19.95) | = | 24.00 | dBm | > | 24 | dBm |
| 7. | 11dBm + 10log | (5725.00 - 5709.87) | = | 22.80 | dBm | < | 24 | dBm |

Chain 1

| | | | | | | | | |
|----|---------------|-----------------------|---|-------|-----|---|----|-----|
| 1. | 11dBm + 10log | (19.89) | = | 23.99 | dBm | < | 24 | dBm |
| 2. | 11dBm + 10log | (19.87) | = | 23.98 | dBm | < | 24 | dBm |
| 3. | 11dBm + 10log | (19.89) | = | 23.99 | dBm | < | 24 | dBm |
| 4. | 11dBm + 10log | (19.70) | = | 23.94 | dBm | < | 24 | dBm |
| 5. | 11dBm + 10log | (19.87) | = | 23.98 | dBm | < | 24 | dBm |
| 6. | 11dBm + 10log | (19.54) | = | 23.91 | dBm | < | 24 | dBm |
| 7. | 11dBm + 10log | (5725.00 - 5710.02) | = | 22.76 | dBm | < | 24 | dBm |

Chain 2

| | | | | | | | | |
|----|---------------|-----------------------|---|-------|-----|---|----|-----|
| 1. | 11dBm + 10log | (20.21) | = | 24.06 | dBm | > | 24 | dBm |
| 2. | 11dBm + 10log | (20.31) | = | 24.08 | dBm | > | 24 | dBm |
| 3. | 11dBm + 10log | (19.92) | = | 23.99 | dBm | < | 24 | dBm |
| 4. | 11dBm + 10log | (20.19) | = | 24.05 | dBm | > | 24 | dBm |
| 5. | 11dBm + 10log | (20.14) | = | 24.04 | dBm | > | 24 | dBm |
| 6. | 11dBm + 10log | (20.09) | = | 24.03 | dBm | > | 24 | dBm |
| 7. | 11dBm + 10log | (5725.00 - 5709.90) | = | 22.79 | dBm | < | 24 | dBm |

Chain 3

| | | | | | | | | |
|----|---------------|-----------------------|---|-------|-----|---|----|-----|
| 1. | 11dBm + 10log | (19.61) | = | 23.92 | dBm | < | 24 | dBm |
| 2. | 11dBm + 10log | (19.67) | = | 23.94 | dBm | < | 24 | dBm |
| 3. | 11dBm + 10log | (19.97) | = | 24.00 | dBm | = | 24 | dBm |
| 4. | 11dBm + 10log | (19.59) | = | 23.92 | dBm | < | 24 | dBm |
| 5. | 11dBm + 10log | (19.58) | = | 23.92 | dBm | < | 24 | dBm |
| 6. | 11dBm + 10log | (20.07) | = | 24.03 | dBm | > | 24 | dBm |
| 7. | 11dBm + 10log | (5725.00 - 5710.17) | = | 22.71 | dBm | < | 24 | dBm |

802.11n (HT20)

| Chan. | Freq. (MHz) | Maximum Conducted Power (dBm) | | | | Total Power (mW) | Total Power (dBm) | Power Limit (dBm) | Pass / Fail |
|-------|----------------------|-------------------------------|---------|---------|---------|------------------|-------------------|-------------------|-------------|
| | | Chain 0 | Chain 1 | Chain 2 | Chain 3 | | | | |
| 52 | 5260 | 11.32 | 11.05 | 11.43 | 11.15 | 53.219 | 17.26 | 21.84 | Pass |
| 60 | 5300 | 11.45 | 10.99 | 11.65 | 10.55 | 52.496 | 17.20 | 21.84 | Pass |
| 64 | 5320 | 11.69 | 11.58 | 12.11 | 10.94 | 57.817 | 17.62 | 21.84 | Pass |
| 100 | 5500 | 11.25 | 11.35 | 11.28 | 11.45 | 54.373 | 17.35 | 21.84 | Pass |
| 116 | 5580 | 11.65 | 11.47 | 11.35 | 11.22 | 55.539 | 17.45 | 21.84 | Pass |
| 140 | 5700 | 11.31 | 11.23 | 11.02 | 10.35 | 50.281 | 17.01 | 21.84 | Pass |
| 144 | 5720 For U-NII-2C | 9.82 | 10.17 | 9.80 | 9.12 | 37.709 | 15.76 | 21.84 | Pass |
| 144 | 5720 For U-NII-3 | 5.24 | 5.51 | 5.16 | 4.60 | 13.063 | 11.16 | 29 | Pass |

Note:

- 5260~5320MHz, 5500~5720MHz Gain = 7 > 6dBi, so the limit shall be reduced to 22.84-(7-6) = 21.84dBm.
- 5745~5825MHz Gain = 7 > 6dBi, so the limit shall be reduced to 30-(7-6) = 29dBm.

For U-NII-2A, U-NII-2C

Chain 0

- 11dBm + 10log (20.72) = 24.16 dBm > 24 dBm
- 11dBm + 10log (20.85) = 24.19 dBm > 24 dBm
- 11dBm + 10log (20.98) = 24.22 dBm > 24 dBm
- 11dBm + 10log (20.83) = 24.19 dBm > 24 dBm
- 11dBm + 10log (20.69) = 24.16 dBm > 24 dBm
- 11dBm + 10log (20.68) = 24.16 dBm > 24 dBm
- 11dBm + 10log (5725.00 - 5709.54) = 22.89 dBm < 24 dBm

Chain 1

- 11dBm + 10log (20.79) = 24.18 dBm > 24 dBm
- 11dBm + 10log (20.74) = 24.17 dBm > 24 dBm
- 11dBm + 10log (20.82) = 24.18 dBm > 24 dBm
- 11dBm + 10log (20.62) = 24.14 dBm > 24 dBm
- 11dBm + 10log (20.95) = 24.21 dBm > 24 dBm
- 11dBm + 10log (20.84) = 24.19 dBm > 24 dBm
- 11dBm + 10log (5725.00 - 5709.57) = 22.88 dBm < 24 dBm

Chain 2

- 11dBm + 10log (20.69) = 24.16 dBm > 24 dBm
- 11dBm + 10log (20.53) = 24.12 dBm > 24 dBm
- 11dBm + 10log (21.01) = 24.22 dBm > 24 dBm
- 11dBm + 10log (21.15) = 24.25 dBm > 24 dBm
- 11dBm + 10log (20.72) = 24.16 dBm > 24 dBm
- 11dBm + 10log (20.67) = 24.15 dBm > 24 dBm
- 11dBm + 10log (5725.00 - 5709.74) = 22.84 dBm < 24 dBm

Chain 3

- 11dBm + 10log (20.43) = 24.10 dBm > 24 dBm
- 11dBm + 10log (20.51) = 24.12 dBm > 24 dBm
- 11dBm + 10log (20.60) = 24.14 dBm > 24 dBm
- 11dBm + 10log (20.59) = 24.14 dBm > 24 dBm
- 11dBm + 10log (20.64) = 24.15 dBm > 24 dBm
- 11dBm + 10log (20.89) = 24.20 dBm > 24 dBm
- 11dBm + 10log (5725.00 - 5709.65) = 22.86 dBm < 24 dBm

802.11n (HT40)

| Chan. | Freq. (MHz) | Maximum Conducted Power (dBm) | | | | Total Power (mW) | Total Power (dBm) | Power Limit (dBm) | Pass / Fail |
|-------|----------------------|-------------------------------|---------|---------|---------|------------------|-------------------|-------------------|-------------|
| | | Chain 0 | Chain 1 | Chain 2 | Chain 3 | | | | |
| 54 | 5270 | 13.66 | 13.31 | 13.90 | 13.26 | 90.387 | 19.56 | 23 | Pass |
| 62 | 5310 | 12.95 | 12.31 | 13.11 | 12.31 | 74.232 | 18.71 | 23 | Pass |
| 102 | 5510 | 13.69 | 13.79 | 13.55 | 13.66 | 93.194 | 19.69 | 23 | Pass |
| 110 | 5550 | 13.75 | 13.78 | 13.81 | 13.64 | 94.757 | 19.77 | 23 | Pass |
| 134 | 5670 | 13.91 | 13.55 | 13.77 | 13.07 | 91.350 | 19.61 | 23 | Pass |
| 142 | 5710 For U-NII-2C | 13.31 | 13.41 | 13.05 | 12.66 | 81.991 | 19.14 | 23 | Pass |
| 142 | 5710 For U-NII-3 | 5.10 | 5.11 | 4.73 | 4.40 | 12.205 | 10.87 | 29 | Pass |

Note:

- 5260~5320MHz, 5500~5720MHz Gain = 7 > 6dBi, so the limit shall be reduced to 24-(7-6) = 23dBm.
- 5745~5825MHz Gain = 7 > 6dBi, so the limit shall be reduced to 30-(7-6) = 29dBm.

For U-NII-2A, U-NII-2C

Chain 0

- 11dBm + 10log (41.05) = 27.13 dBm > 24 dBm
- 11dBm + 10log (40.99) = 27.13 dBm > 24 dBm
- 11dBm + 10log (40.86) = 27.11 dBm > 24 dBm
- 11dBm + 10log (40.77) = 27.10 dBm > 24 dBm
- 11dBm + 10log (40.69) = 27.09 dBm > 24 dBm
- 11dBm + 10log (5725.00 - 5689.53) = 26.50 dBm > 24 dBm

Chain 1

- 11dBm + 10log (40.85) = 27.11 dBm > 24 dBm
- 11dBm + 10log (40.80) = 27.11 dBm > 24 dBm
- 11dBm + 10log (40.49) = 27.07 dBm > 24 dBm
- 11dBm + 10log (40.67) = 27.09 dBm > 24 dBm
- 11dBm + 10log (40.81) = 27.11 dBm > 24 dBm
- 11dBm + 10log (5725.00 - 5689.66) = 26.48 dBm > 24 dBm

Chain 2

- 11dBm + 10log (40.49) = 27.07 dBm > 24 dBm
- 11dBm + 10log (40.45) = 27.07 dBm > 24 dBm
- 11dBm + 10log (40.38) = 27.06 dBm > 24 dBm
- 11dBm + 10log (40.45) = 27.07 dBm > 24 dBm
- 11dBm + 10log (40.59) = 27.08 dBm > 24 dBm
- 11dBm + 10log (5725.00 - 5689.62) = 26.49 dBm > 24 dBm

Chain 3

- 11dBm + 10log (40.79) = 27.11 dBm > 24 dBm
- 11dBm + 10log (40.59) = 27.08 dBm > 24 dBm
- 11dBm + 10log (40.46) = 27.07 dBm > 24 dBm
- 11dBm + 10log (40.34) = 27.06 dBm > 24 dBm
- 11dBm + 10log (40.48) = 27.07 dBm > 24 dBm
- 11dBm + 10log (5725.00 - 5689.79) = 26.47 dBm > 24 dBm

802.11ac (VHT80)

| Chan. | Freq. (MHz) | Maximum Conducted Power (dBm) | | | | Total Power (mW) | Total Power (dBm) | Power Limit (dBm) | Pass / Fail |
|-------|----------------------|-------------------------------|---------|---------|---------|------------------|-------------------|-------------------|-------------|
| | | Chain 0 | Chain 1 | Chain 2 | Chain 3 | | | | |
| 58 | 5290 | 10.12 | 10.04 | 10.73 | 10.02 | 42.249 | 16.26 | 23 | Pass |
| 106 | 5530 | 9.44 | 9.59 | 8.04 | 8.74 | 31.739 | 15.02 | 23 | Pass |
| 122 | 5610 | 15.77 | 15.25 | 15.13 | 15.17 | 136.723 | 21.36 | 23 | Pass |
| 138 | 5690 For U-NII-2C | 13.61 | 13.32 | 13.47 | 12.87 | 86.036 | 19.35 | 23 | Pass |
| 138 | 5690 For U-NII-3 | 3.76 | 3.03 | 3.30 | 2.67 | 8.373 | 9.23 | 29 | Pass |

Note:

- 5260~5320MHz, 5500~5720MHz Gain = 7 > 6dBi, so the limit shall be reduced to 24-(7-6) = 23dBm.
- 5745~5825MHz Gain = 7 > 6dBi, so the limit shall be reduced to 30-(7-6) = 29dBm.

For U-NII-2A, U-NII-2C

Chain 0

- 11dBm + 10log (85.82) = 30.34 dBm > 24 dBm
- 11dBm + 10log (86.29) = 30.36 dBm > 24 dBm
- 11dBm + 10log (85.69) = 30.33 dBm > 24 dBm
- 11dBm + 10log (5725.00 - 5647.53) = 29.89 dBm > 24 dBm

Chain 1

- 11dBm + 10log (85.25) = 30.31 dBm > 24 dBm
- 11dBm + 10log (85.80) = 30.33 dBm > 24 dBm
- 11dBm + 10log (85.78) = 30.33 dBm > 24 dBm
- 11dBm + 10log (5725.00 - 5647.23) = 29.91 dBm > 24 dBm

Chain 1

- 11dBm + 10log (84.89) = 30.29 dBm > 24 dBm
- 11dBm + 10log (85.43) = 30.32 dBm > 24 dBm
- 11dBm + 10log (85.11) = 30.30 dBm > 24 dBm
- 11dBm + 10log (5725.00 - 5647.94) = 29.87 dBm > 24 dBm

Chain 2

- 11dBm + 10log (85.28) = 30.31 dBm > 24 dBm
- 11dBm + 10log (85.19) = 30.30 dBm > 24 dBm
- 11dBm + 10log (84.94) = 30.29 dBm > 24 dBm
- 11dBm + 10log (5725.00 - 5647.54) = 29.89 dBm > 24 dBm

Beamforming Mode

802.11n (HT20)

| Chan. | Freq. (MHz) | Maximum Conducted Power (dBm) | | | | Total Power (mW) | Total Power (dBm) | Power Limit (dBm) | Pass / Fail |
|-------|----------------------|-------------------------------|---------|---------|---------|------------------|-------------------|-------------------|-------------|
| | | Chain 0 | Chain 1 | Chain 2 | Chain 3 | | | | |
| 52 | 5260 | 5.30 | 5.03 | 5.41 | 5.13 | 13.305 | 11.24 | 15.82 | Pass |
| 60 | 5300 | 5.43 | 4.97 | 5.63 | 4.53 | 13.124 | 11.18 | 15.82 | Pass |
| 64 | 5320 | 5.67 | 5.56 | 6.09 | 4.92 | 14.454 | 11.60 | 15.82 | Pass |
| 100 | 5500 | 5.23 | 5.33 | 5.26 | 5.43 | 13.593 | 11.33 | 15.82 | Pass |
| 116 | 5580 | 5.63 | 5.45 | 5.33 | 5.20 | 13.885 | 11.43 | 15.82 | Pass |
| 140 | 5700 | 5.29 | 5.21 | 5.00 | 4.33 | 12.570 | 10.99 | 15.82 | Pass |
| 144 | 5720 For U-NII-2C | 3.80 | 4.15 | 3.78 | 3.10 | 9.427 | 9.74 | 15.82 | Pass |
| 144 | 5720 For U-NII-3 | -0.78 | -0.51 | -0.86 | -1.42 | 3.266 | 5.14 | 22.98 | Pass |

Note:

- 5260~5320MHz, 5500~5720MHz Directional Gain = $7 + 10\log(4) = 13.02\text{dBi} > 6\text{dBi}$, so the limit shall be reduced to $22.84 - (13.02 - 6) = 15.82\text{dBm}$.
- 5745~5825MHz Directional Gain = $7 + 10\log(4) = 13.02\text{dBi} > 6\text{dBi}$, so the limit shall be reduced to $30 - (13.02 - 6) = 22.98\text{dBm}$.

For U-NII-2A, U-NII-2C

Chain 0

- $11\text{dBm} + 10\log(20.72) = 24.16\text{ dBm} > 24\text{ dBm}$
- $11\text{dBm} + 10\log(20.85) = 24.19\text{ dBm} > 24\text{ dBm}$
- $11\text{dBm} + 10\log(20.98) = 24.22\text{ dBm} > 24\text{ dBm}$
- $11\text{dBm} + 10\log(20.83) = 24.19\text{ dBm} > 24\text{ dBm}$
- $11\text{dBm} + 10\log(20.69) = 24.16\text{ dBm} > 24\text{ dBm}$
- $11\text{dBm} + 10\log(20.68) = 24.16\text{ dBm} > 24\text{ dBm}$
- $11\text{dBm} + 10\log(5725.00 - 5709.54) = 22.89\text{ dBm} < 24\text{ dBm}$

Chain 1

- $11\text{dBm} + 10\log(20.79) = 24.18\text{ dBm} > 24\text{ dBm}$
- $11\text{dBm} + 10\log(20.74) = 24.17\text{ dBm} > 24\text{ dBm}$
- $11\text{dBm} + 10\log(20.82) = 24.18\text{ dBm} > 24\text{ dBm}$
- $11\text{dBm} + 10\log(20.62) = 24.14\text{ dBm} > 24\text{ dBm}$
- $11\text{dBm} + 10\log(20.95) = 24.21\text{ dBm} > 24\text{ dBm}$
- $11\text{dBm} + 10\log(20.84) = 24.19\text{ dBm} > 24\text{ dBm}$
- $11\text{dBm} + 10\log(5725.00 - 5709.57) = 22.88\text{ dBm} < 24\text{ dBm}$

Chain 2

- $11\text{dBm} + 10\log(20.69) = 24.16\text{ dBm} > 24\text{ dBm}$
- $11\text{dBm} + 10\log(20.53) = 24.12\text{ dBm} > 24\text{ dBm}$
- $11\text{dBm} + 10\log(21.01) = 24.22\text{ dBm} > 24\text{ dBm}$
- $11\text{dBm} + 10\log(21.15) = 24.25\text{ dBm} > 24\text{ dBm}$
- $11\text{dBm} + 10\log(20.72) = 24.16\text{ dBm} > 24\text{ dBm}$
- $11\text{dBm} + 10\log(20.67) = 24.15\text{ dBm} > 24\text{ dBm}$
- $11\text{dBm} + 10\log(5725.00 - 5709.74) = 22.84\text{ dBm} < 24\text{ dBm}$

Chain 3

- $11\text{dBm} + 10\log(20.43) = 24.10\text{ dBm} > 24\text{ dBm}$
- $11\text{dBm} + 10\log(20.51) = 24.12\text{ dBm} > 24\text{ dBm}$
- $11\text{dBm} + 10\log(20.60) = 24.14\text{ dBm} > 24\text{ dBm}$
- $11\text{dBm} + 10\log(20.59) = 24.14\text{ dBm} > 24\text{ dBm}$
- $11\text{dBm} + 10\log(20.64) = 24.15\text{ dBm} > 24\text{ dBm}$
- $11\text{dBm} + 10\log(20.89) = 24.20\text{ dBm} > 24\text{ dBm}$
- $11\text{dBm} + 10\log(5725.00 - 5709.65) = 22.86\text{ dBm} < 24\text{ dBm}$

802.11n (HT40)

| Chan. | Freq. (MHz) | Maximum Conducted Power (dBm) | | | | Total Power (mW) | Total Power (dBm) | Power Limit (dBm) | Pass / Fail |
|-------|----------------------|-------------------------------|---------|---------|---------|------------------|-------------------|-------------------|-------------|
| | | Chain 0 | Chain 1 | Chain 2 | Chain 3 | | | | |
| 54 | 5270 | 7.64 | 7.29 | 7.88 | 7.24 | 22.597 | 13.54 | 16.98 | Pass |
| 62 | 5310 | 6.93 | 6.29 | 7.09 | 6.29 | 18.558 | 12.69 | 16.98 | Pass |
| 102 | 5510 | 7.67 | 7.77 | 7.53 | 7.64 | 23.299 | 13.67 | 16.98 | Pass |
| 110 | 5550 | 7.73 | 7.76 | 7.79 | 7.62 | 23.689 | 13.75 | 16.98 | Pass |
| 134 | 5670 | 7.89 | 7.53 | 7.75 | 7.05 | 22.838 | 13.59 | 16.98 | Pass |
| 142 | 5710 For U-NII-2C | 7.29 | 7.39 | 7.03 | 6.64 | 20.498 | 13.12 | 16.98 | Pass |
| 142 | 5710 For U-NII-3 | -0.92 | -0.91 | -1.29 | -1.62 | 3.051 | 4.84 | 22.98 | Pass |

Note:

- 5260~5320MHz, 5500~5720MHz Directional Gain = $7 + 10\log(4) = 13.02\text{dBi} > 6\text{dBi}$, so the limit shall be reduced to $24 - (13.02 - 6) = 16.98\text{dBm}$.
- 5745~5825MHz Directional Gain = $7 + 10\log(4) = 13.02\text{dBi} > 6\text{dBi}$, so the limit shall be reduced to $30 - (13.02 - 6) = 22.98\text{dBm}$.

For U-NII-2A, U-NII-2C

Chain 0

- $11\text{dBm} + 10\log (41.05) = 27.13 \text{ dBm} > 24 \text{ dBm}$
- $11\text{dBm} + 10\log (40.99) = 27.13 \text{ dBm} > 24 \text{ dBm}$
- $11\text{dBm} + 10\log (40.86) = 27.11 \text{ dBm} > 24 \text{ dBm}$
- $11\text{dBm} + 10\log (40.77) = 27.10 \text{ dBm} > 24 \text{ dBm}$
- $11\text{dBm} + 10\log (40.69) = 27.09 \text{ dBm} > 24 \text{ dBm}$
- $11\text{dBm} + 10\log (5725.00 - 5689.53) = 26.50 \text{ dBm} > 24 \text{ dBm}$

Chain 1

- $11\text{dBm} + 10\log (40.85) = 27.11 \text{ dBm} > 24 \text{ dBm}$
- $11\text{dBm} + 10\log (40.80) = 27.11 \text{ dBm} > 24 \text{ dBm}$
- $11\text{dBm} + 10\log (40.49) = 27.07 \text{ dBm} > 24 \text{ dBm}$
- $11\text{dBm} + 10\log (40.67) = 27.09 \text{ dBm} > 24 \text{ dBm}$
- $11\text{dBm} + 10\log (40.81) = 27.11 \text{ dBm} > 24 \text{ dBm}$
- $11\text{dBm} + 10\log (5725.00 - 5689.66) = 26.48 \text{ dBm} > 24 \text{ dBm}$

Chain 2

- $11\text{dBm} + 10\log (40.49) = 27.07 \text{ dBm} > 24 \text{ dBm}$
- $11\text{dBm} + 10\log (40.45) = 27.07 \text{ dBm} > 24 \text{ dBm}$
- $11\text{dBm} + 10\log (40.38) = 27.06 \text{ dBm} > 24 \text{ dBm}$
- $11\text{dBm} + 10\log (40.45) = 27.07 \text{ dBm} > 24 \text{ dBm}$
- $11\text{dBm} + 10\log (40.59) = 27.08 \text{ dBm} > 24 \text{ dBm}$
- $11\text{dBm} + 10\log (5725.00 - 5689.62) = 26.49 \text{ dBm} > 24 \text{ dBm}$

Chain 3

- $11\text{dBm} + 10\log (40.79) = 27.11 \text{ dBm} > 24 \text{ dBm}$
- $11\text{dBm} + 10\log (40.59) = 27.08 \text{ dBm} > 24 \text{ dBm}$
- $11\text{dBm} + 10\log (40.46) = 27.07 \text{ dBm} > 24 \text{ dBm}$
- $11\text{dBm} + 10\log (40.34) = 27.06 \text{ dBm} > 24 \text{ dBm}$
- $11\text{dBm} + 10\log (40.48) = 27.07 \text{ dBm} > 24 \text{ dBm}$
- $11\text{dBm} + 10\log (5725.00 - 5689.79) = 26.47 \text{ dBm} > 24 \text{ dBm}$

802.11ac (VHT80)

| Chan. | Freq. (MHz) | Maximum Conducted Power (dBm) | | | | Total Power (mW) | Total Power (dBm) | Power Limit (dBm) | Pass / Fail |
|-------|----------------------|-------------------------------|---------|---------|---------|------------------|-------------------|-------------------|-------------|
| | | Chain 0 | Chain 1 | Chain 2 | Chain 3 | | | | |
| 58 | 5290 | 4.10 | 4.02 | 4.71 | 4.00 | 10.562 | 10.24 | 16.98 | Pass |
| 106 | 5530 | 3.42 | 3.57 | 2.02 | 2.72 | 7.935 | 9.00 | 16.98 | Pass |
| 122 | 5610 | 9.75 | 9.23 | 9.11 | 9.15 | 34.181 | 15.34 | 16.98 | Pass |
| 138 | 5690 For U-NII-2C | 7.59 | 7.30 | 7.45 | 6.85 | 21.509 | 13.33 | 16.98 | Pass |
| 138 | 5690 For U-NII-3 | -2.26 | -2.99 | -2.72 | -3.35 | 2.093 | 3.21 | 22.98 | Pass |

Note:

- 5260~5320MHz, 5500~5720MHz Directional Gain = $7 + 10\log(4) = 13.02\text{dBi} > 6\text{dBi}$, so the limit shall be reduced to $24 - (13.02 - 6) = 16.98\text{dBm}$.
- 5745~5825MHz Directional Gain = $7 + 10\log(4) = 13.02\text{dBi} > 6\text{dBi}$, so the limit shall be reduced to $30 - (13.02 - 6) = 22.98\text{dBm}$.

For U-NII-2A, U-NII-2C

Chain 0

- $11\text{dBm} + 10\log (85.82) = 30.34 \text{ dBm} > 24 \text{ dBm}$
- $11\text{dBm} + 10\log (86.29) = 30.36 \text{ dBm} > 24 \text{ dBm}$
- $11\text{dBm} + 10\log (85.69) = 30.33 \text{ dBm} > 24 \text{ dBm}$
- $11\text{dBm} + 10\log (5725.00 - 5647.53) = 29.89 \text{ dBm} > 24 \text{ dBm}$

Chain 1

- $11\text{dBm} + 10\log (85.25) = 30.31 \text{ dBm} > 24 \text{ dBm}$
- $11\text{dBm} + 10\log (85.80) = 30.33 \text{ dBm} > 24 \text{ dBm}$
- $11\text{dBm} + 10\log (85.78) = 30.33 \text{ dBm} > 24 \text{ dBm}$
- $11\text{dBm} + 10\log (5725.00 - 5647.23) = 29.91 \text{ dBm} > 24 \text{ dBm}$

Chain 1

- $11\text{dBm} + 10\log (84.89) = 30.29 \text{ dBm} > 24 \text{ dBm}$
- $11\text{dBm} + 10\log (85.43) = 30.32 \text{ dBm} > 24 \text{ dBm}$
- $11\text{dBm} + 10\log (85.11) = 30.30 \text{ dBm} > 24 \text{ dBm}$
- $11\text{dBm} + 10\log (5725.00 - 5647.94) = 29.87 \text{ dBm} > 24 \text{ dBm}$

Chain 2

- $11\text{dBm} + 10\log (85.28) = 30.31 \text{ dBm} > 24 \text{ dBm}$
- $11\text{dBm} + 10\log (85.19) = 30.30 \text{ dBm} > 24 \text{ dBm}$
- $11\text{dBm} + 10\log (84.94) = 30.29 \text{ dBm} > 24 \text{ dBm}$
- $11\text{dBm} + 10\log (5725.00 - 5647.54) = 29.89 \text{ dBm} > 24 \text{ dBm}$

Mode A2

CDD Mode

802.11a

| Chan. | Freq. (MHz) | Maximum Conducted Power (dBm) | | | | Total Power (mW) | Total Power (dBm) | Power Limit (dBm) | Pass / Fail |
|-------|----------------------|-------------------------------|---------|---------|---------|------------------|-------------------|-------------------|-------------|
| | | Chain 0 | Chain 1 | Chain 2 | Chain 3 | | | | |
| 52 | 5260 | 0.92 | 0.83 | 1.23 | 0.89 | 5.001 | 6.99 | 10.2 | Pass |
| 60 | 5300 | 0.91 | 0.72 | 1.31 | 0.46 | 4.877 | 6.88 | 10.2 | Pass |
| 64 | 5320 | 0.87 | 0.79 | 1.12 | 0.62 | 4.868 | 6.87 | 10.2 | Pass |
| 100 | 5500 | 0.93 | 0.97 | 0.89 | 0.88 | 4.941 | 6.94 | 10.2 | Pass |
| 116 | 5580 | 0.74 | 0.69 | 0.89 | 0.87 | 4.807 | 6.82 | 10.2 | Pass |
| 140 | 5700 | 0.78 | 1.03 | 0.93 | 0.85 | 4.920 | 6.92 | 10.2 | Pass |
| 144 | 5720 For U-NII-2C | -0.04 | -0.22 | -0.65 | -1.73 | 3.474 | 5.41 | 10.2 | Pass |
| 144 | 5720 For U-NII-3 | -4.76 | -5.04 | -5.47 | -6.50 | 1.155 | 0.63 | 17.5 | Pass |

Note:

- 5260~5320MHz, 5500~5720MHz Gain = 18.5 > 6dBi, so the limit shall be reduced to 22.70-(18.5-6) = 10.2dBm.
- 5745~5825MHz Gain = 18.5 > 6dBi, so the limit shall be reduced to 30-(18.5-6) = 17.5dBm.

For U-NII-2A, U-NII-2C

Chain 0

- 11dBm + 10log (19.98) = 24.01 dBm > 24 dBm
- 11dBm + 10log (20.08) = 24.03 dBm > 24 dBm
- 11dBm + 10log (20.18) = 24.05 dBm > 24 dBm
- 11dBm + 10log (20.14) = 24.04 dBm > 24 dBm
- 11dBm + 10log (19.82) = 23.97 dBm < 24 dBm
- 11dBm + 10log (20.23) = 24.06 dBm > 24 dBm
- 11dBm + 10log (5725.00 - 5710.02) = 22.76 dBm < 24 dBm

Chain 1

- 11dBm + 10log (20.13) = 24.04 dBm > 24 dBm
- 11dBm + 10log (19.87) = 23.98 dBm < 24 dBm
- 11dBm + 10log (20.20) = 24.05 dBm > 24 dBm
- 11dBm + 10log (20.36) = 24.09 dBm > 24 dBm
- 11dBm + 10log (20.24) = 24.06 dBm > 24 dBm
- 11dBm + 10log (20.15) = 24.04 dBm > 24 dBm
- 11dBm + 10log (5725.00 - 5709.81) = 22.82 dBm < 24 dBm

Chain 2

- 11dBm + 10log (19.84) = 23.98 dBm < 24 dBm
- 11dBm + 10log (20.15) = 24.04 dBm > 24 dBm
- 11dBm + 10log (20.18) = 24.05 dBm > 24 dBm
- 11dBm + 10log (20.23) = 24.06 dBm > 24 dBm
- 11dBm + 10log (19.89) = 23.99 dBm < 24 dBm
- 11dBm + 10log (19.85) = 23.98 dBm < 24 dBm
- 11dBm + 10log (5725.00 - 5710.20) = 22.70 dBm < 24 dBm

Chain 3

- 11dBm + 10log (19.86) = 23.98 dBm < 24 dBm
- 11dBm + 10log (19.99) = 24.01 dBm > 24 dBm
- 11dBm + 10log (19.69) = 23.94 dBm < 24 dBm
- 11dBm + 10log (19.75) = 23.96 dBm < 24 dBm
- 11dBm + 10log (19.93) = 24.00 dBm = 24 dBm
- 11dBm + 10log (19.79) = 23.96 dBm < 24 dBm
- 11dBm + 10log (5725.00 - 5710.14) = 22.72 dBm < 24 dBm

802.11n (HT20)

| Chan. | Freq. (MHz) | Maximum Conducted Power (dBm) | | | | Total Power (mW) | Total Power (dBm) | Power Limit (dBm) | Pass / Fail |
|-------|----------------------|-------------------------------|---------|---------|---------|------------------|-------------------|-------------------|-------------|
| | | Chain 0 | Chain 1 | Chain 2 | Chain 3 | | | | |
| 52 | 5260 | 1.21 | 0.81 | 0.89 | 0.83 | 4.964 | 6.96 | 10.34 | Pass |
| 60 | 5300 | 1.07 | 0.78 | 1.23 | 0.74 | 4.989 | 6.98 | 10.34 | Pass |
| 64 | 5320 | 0.93 | 0.88 | 1.19 | 0.78 | 4.976 | 6.97 | 10.34 | Pass |
| 100 | 5500 | 1.12 | 1.01 | 0.76 | 0.79 | 4.946 | 6.94 | 10.34 | Pass |
| 116 | 5580 | 0.83 | 1.15 | 0.79 | 0.67 | 4.880 | 6.88 | 10.34 | Pass |
| 140 | 5700 | 1.08 | 0.83 | 0.64 | 0.82 | 4.860 | 6.87 | 10.34 | Pass |
| 144 | 5720 For U-NII-2C | 0.14 | 0.10 | -0.08 | -1.08 | 3.818 | 5.82 | 10.34 | Pass |
| 144 | 5720 For U-NII-3 | -4.27 | -4.50 | -4.58 | -5.52 | 1.358 | 1.33 | 17.5 | Pass |

Note:

- 5260~5320MHz, 5500~5720MHz Gain = 18.5 > 6dBi, so the limit shall be reduced to 22.84-(18.5-6) = 10.34dBm.
- 5745~5825MHz Gain = 18.5 > 6dBi, so the limit shall be reduced to 30-(18.5-6) = 17.5dBm.

For U-NII-2A, U-NII-2C

Chain 0

- 11dBm + 10log (20.87) = 24.20 dBm > 24 dBm
- 11dBm + 10log (20.97) = 24.22 dBm > 24 dBm
- 11dBm + 10log (21.16) = 24.26 dBm > 24 dBm
- 11dBm + 10log (20.83) = 24.19 dBm > 24 dBm
- 11dBm + 10log (20.84) = 24.19 dBm > 24 dBm
- 11dBm + 10log (21.02) = 24.23 dBm > 24 dBm
- 11dBm + 10log (5725.00 - 5709.54) = 22.89 dBm < 24 dBm

Chain 1

- 11dBm + 10log (20.67) = 24.15 dBm > 24 dBm
- 11dBm + 10log (20.78) = 24.18 dBm > 24 dBm
- 11dBm + 10log (20.86) = 24.19 dBm > 24 dBm
- 11dBm + 10log (21.12) = 24.25 dBm > 24 dBm
- 11dBm + 10log (21.10) = 24.24 dBm > 24 dBm
- 11dBm + 10log (21.04) = 24.23 dBm > 24 dBm
- 11dBm + 10log (5725.00 - 5709.57) = 22.88 dBm < 24 dBm

Chain 2

- 11dBm + 10log (20.71) = 24.16 dBm > 24 dBm
- 11dBm + 10log (20.86) = 24.19 dBm > 24 dBm
- 11dBm + 10log (20.82) = 24.18 dBm > 24 dBm
- 11dBm + 10log (20.76) = 24.17 dBm > 24 dBm
- 11dBm + 10log (20.70) = 24.16 dBm > 24 dBm
- 11dBm + 10log (20.75) = 24.17 dBm > 24 dBm
- 11dBm + 10log (5725.00 - 5709.68) = 22.85 dBm < 24 dBm

Chain 3

- 11dBm + 10log (20.40) = 24.10 dBm > 24 dBm
- 11dBm + 10log (20.56) = 24.13 dBm > 24 dBm
- 11dBm + 10log (20.81) = 24.18 dBm > 24 dBm
- 11dBm + 10log (20.48) = 24.11 dBm > 24 dBm
- 11dBm + 10log (20.71) = 24.16 dBm > 24 dBm
- 11dBm + 10log (20.77) = 24.17 dBm > 24 dBm
- 11dBm + 10log (5725.00 - 5709.71) = 22.84 dBm < 24 dBm

802.11n (HT40)

| Chan. | Freq. (MHz) | Maximum Conducted Power (dBm) | | | | Total Power (mW) | Total Power (dBm) | Power Limit (dBm) | Pass / Fail |
|-------|----------------------|-------------------------------|---------|---------|---------|------------------|-------------------|-------------------|-------------|
| | | Chain 0 | Chain 1 | Chain 2 | Chain 3 | | | | |
| 54 | 5270 | 2.49 | 1.78 | 2.06 | 1.86 | 6.423 | 8.08 | 11.5 | Pass |
| 62 | 5310 | 2.23 | 1.64 | 2.48 | 1.95 | 6.467 | 8.11 | 11.5 | Pass |
| 102 | 5510 | 2.18 | 2.17 | 1.95 | 1.94 | 6.430 | 8.08 | 11.5 | Pass |
| 110 | 5550 | 2.33 | 2.16 | 1.91 | 1.93 | 6.466 | 8.11 | 11.5 | Pass |
| 134 | 5670 | 2.57 | 2.03 | 2.06 | 1.54 | 6.436 | 8.09 | 11.5 | Pass |
| 142 | 5710 For U-NII-2C | 1.03 | 0.61 | 0.38 | 0.32 | 4.586 | 6.61 | 11.5 | Pass |
| 142 | 5710 For U-NII-3 | -9.90 | -10.45 | -11.06 | -12.57 | 0.326 | -4.87 | 17.5 | Pass |

Note:

- 5260~5320MHz, 5500~5720MHz Gain = 18.5 > 6dBi, so the limit shall be reduced to 24-(18.5-6) = 11.5dBm.
- 5745~5825MHz Gain = 18.5 > 6dBi, so the limit shall be reduced to 30-(18.5-6) = 17.5dBm.

For U-NII-2A, U-NII-2C

Chain 0

- 11dBm + 10log (41.27) = 27.16 dBm > 24 dBm
- 11dBm + 10log (40.93) = 27.12 dBm > 24 dBm
- 11dBm + 10log (41.02) = 27.13 dBm > 24 dBm
- 11dBm + 10log (40.88) = 27.12 dBm > 24 dBm
- 11dBm + 10log (41.11) = 27.14 dBm > 24 dBm
- 11dBm + 10log (5725.00 - 5689.60) = 26.49 dBm > 24 dBm

Chain 1

- 11dBm + 10log (41.00) = 27.13 dBm > 24 dBm
- 11dBm + 10log (41.17) = 27.15 dBm > 24 dBm
- 11dBm + 10log (40.82) = 27.11 dBm > 24 dBm
- 11dBm + 10log (40.88) = 27.12 dBm > 24 dBm
- 11dBm + 10log (41.05) = 27.13 dBm > 24 dBm
- 11dBm + 10log (5725.00 - 5689.81) = 26.46 dBm > 24 dBm

Chain 2

- 11dBm + 10log (40.54) = 27.08 dBm > 24 dBm
- 11dBm + 10log (40.77) = 27.10 dBm > 24 dBm
- 11dBm + 10log (40.43) = 27.07 dBm > 24 dBm
- 11dBm + 10log (40.76) = 27.10 dBm > 24 dBm
- 11dBm + 10log (40.57) = 27.08 dBm > 24 dBm
- 11dBm + 10log (5725.00 - 5689.73) = 26.47 dBm > 24 dBm

Chain 3

- 11dBm + 10log (40.68) = 27.09 dBm > 24 dBm
- 11dBm + 10log (40.60) = 27.09 dBm > 24 dBm
- 11dBm + 10log (40.60) = 27.09 dBm > 24 dBm
- 11dBm + 10log (40.61) = 27.09 dBm > 24 dBm
- 11dBm + 10log (40.70) = 27.10 dBm > 24 dBm
- 11dBm + 10log (5725.00 - 5689.80) = 26.47 dBm > 24 dBm

802.11ac (VHT80)

| Chan. | Freq. (MHz) | Maximum Conducted Power (dBm) | | | | Total Power (mW) | Total Power (dBm) | Power Limit (dBm) | Pass / Fail |
|-------|----------------------|-------------------------------|---------|---------|---------|------------------|-------------------|-------------------|-------------|
| | | Chain 0 | Chain 1 | Chain 2 | Chain 3 | | | | |
| 58 | 5290 | 2.75 | 2.04 | 2.49 | 2.14 | 6.895 | 8.39 | 11.5 | Pass |
| 106 | 5530 | 2.56 | 2.57 | 2.08 | 2.13 | 6.857 | 8.36 | 11.5 | Pass |
| 122 | 5610 | 2.87 | 2.16 | 2.39 | 2.19 | 6.970 | 8.43 | 11.5 | Pass |
| 138 | 5690 For U-NII-2C | 1.04 | 0.25 | 0.71 | 0.01 | 4.510 | 6.54 | 11.5 | Pass |
| 138 | 5690 For U-NII-3 | -11.65 | -13.16 | -12.48 | -12.99 | 0.223 | -6.51 | 17.5 | Pass |

Note:

- 5260~5320MHz, 5500~5720MHz Gain = 18.5 > 6dBi, so the limit shall be reduced to 24-(18.5-6) = 11.5dBm.
- 5745~5825MHz Gain = 18.5 > 6dBi, so the limit shall be reduced to 30-(18.5-6) = 17.5dBm.

For U-NII-2A, U-NII-2C

Chain 0

- 11dBm + 10log (86.01) = 30.35 dBm > 24 dBm
- 11dBm + 10log (86.71) = 30.38 dBm > 24 dBm
- 11dBm + 10log (86.95) = 30.39 dBm > 24 dBm
- 11dBm + 10log (5725.00 - 5641.14) = 30.24 dBm > 24 dBm

Chain 1

- 11dBm + 10log (85.98) = 30.34 dBm > 24 dBm
- 11dBm + 10log (85.69) = 30.33 dBm > 24 dBm
- 11dBm + 10log (85.54) = 30.32 dBm > 24 dBm
- 11dBm + 10log (5725.00 - 5647.35) = 29.90 dBm > 24 dBm

Chain 2

- 11dBm + 10log (85.13) = 30.30 dBm > 24 dBm
- 11dBm + 10log (86.36) = 30.36 dBm > 24 dBm
- 11dBm + 10log (85.20) = 30.30 dBm > 24 dBm
- 11dBm + 10log (5725.00 - 5647.59) = 29.89 dBm > 24 dBm

Chain 3

- 11dBm + 10log (85.28) = 30.31 dBm > 24 dBm
- 11dBm + 10log (85.16) = 30.30 dBm > 24 dBm
- 11dBm + 10log (84.52) = 30.27 dBm > 24 dBm
- 11dBm + 10log (5725.00 - 5647.67) = 29.88 dBm > 24 dBm

Beamforming Mode

802.11n (HT20)

| Chan. | Freq. (MHz) | Maximum Conducted Power (dBm) | | | | Total Power (mW) | Total Power (dBm) | Power Limit (dBm) | Pass / Fail |
|-------|----------------------|-------------------------------|---------|---------|---------|------------------|-------------------|-------------------|-------------|
| | | Chain 0 | Chain 1 | Chain 2 | Chain 3 | | | | |
| 52 | 5260 | -4.81 | -5.21 | -5.13 | -5.19 | 1.241 | 0.94 | 5.57 | Pass |
| 60 | 5300 | -4.95 | -5.24 | -4.79 | -5.28 | 1.247 | 0.96 | 5.57 | Pass |
| 64 | 5320 | -5.09 | -5.14 | -4.83 | -5.24 | 1.244 | 0.95 | 5.57 | Pass |
| 100 | 5500 | -4.90 | -5.01 | -5.26 | -5.23 | 1.237 | 0.92 | 5.57 | Pass |
| 116 | 5580 | -5.19 | -4.87 | -5.23 | -5.35 | 1.220 | 0.86 | 5.57 | Pass |
| 140 | 5700 | -4.94 | -5.19 | -5.38 | -5.20 | 1.215 | 0.85 | 5.57 | Pass |
| 144 | 5720 For U-NII-2C | -5.88 | -5.92 | -6.10 | -7.10 | 0.954 | -0.20 | 5.57 | Pass |
| 144 | 5720 For U-NII-3 | -10.29 | -10.52 | -10.60 | -11.54 | 0.339 | -4.69 | 12.73 | Pass |

Note:

- 5260~5320MHz, 5500~5720MHz Directional Gain = $18.5 + 10\log(3) = 23.27\text{dBi} > 6\text{dBi}$, so the limit shall be reduced to $22.84 - (23.27 - 6) = 5.57\text{dBm}$.
- 5745~5825MHz Directional Gain = $18.5 + 10\log(3) = 23.27\text{dBi} > 6\text{dBi}$, so the limit shall be reduced to $30 - (23.27 - 6) = 12.73\text{dBm}$.

For U-NII-2A, U-NII-2C

Chain 0

- $11\text{dBm} + 10\log(20.87) = 24.20\text{ dBm} > 24\text{ dBm}$
- $11\text{dBm} + 10\log(20.97) = 24.22\text{ dBm} > 24\text{ dBm}$
- $11\text{dBm} + 10\log(21.16) = 24.26\text{ dBm} > 24\text{ dBm}$
- $11\text{dBm} + 10\log(20.83) = 24.19\text{ dBm} > 24\text{ dBm}$
- $11\text{dBm} + 10\log(20.84) = 24.19\text{ dBm} > 24\text{ dBm}$
- $11\text{dBm} + 10\log(21.02) = 24.23\text{ dBm} > 24\text{ dBm}$
- $11\text{dBm} + 10\log(5725.00 - 5709.54) = 22.89\text{ dBm} < 24\text{ dBm}$

Chain 1

- $11\text{dBm} + 10\log(20.67) = 24.15\text{ dBm} > 24\text{ dBm}$
- $11\text{dBm} + 10\log(20.78) = 24.18\text{ dBm} > 24\text{ dBm}$
- $11\text{dBm} + 10\log(20.86) = 24.19\text{ dBm} > 24\text{ dBm}$
- $11\text{dBm} + 10\log(21.12) = 24.25\text{ dBm} > 24\text{ dBm}$
- $11\text{dBm} + 10\log(21.10) = 24.24\text{ dBm} > 24\text{ dBm}$
- $11\text{dBm} + 10\log(21.04) = 24.23\text{ dBm} > 24\text{ dBm}$
- $11\text{dBm} + 10\log(5725.00 - 5709.57) = 22.88\text{ dBm} < 24\text{ dBm}$

Chain 2

- $11\text{dBm} + 10\log(20.71) = 24.16\text{ dBm} > 24\text{ dBm}$
- $11\text{dBm} + 10\log(20.86) = 24.19\text{ dBm} > 24\text{ dBm}$
- $11\text{dBm} + 10\log(20.82) = 24.18\text{ dBm} > 24\text{ dBm}$
- $11\text{dBm} + 10\log(20.76) = 24.17\text{ dBm} > 24\text{ dBm}$
- $11\text{dBm} + 10\log(20.70) = 24.16\text{ dBm} > 24\text{ dBm}$
- $11\text{dBm} + 10\log(20.75) = 24.17\text{ dBm} > 24\text{ dBm}$
- $11\text{dBm} + 10\log(5725.00 - 5709.68) = 22.85\text{ dBm} < 24\text{ dBm}$

Chain 3

- $11\text{dBm} + 10\log(20.40) = 24.10\text{ dBm} > 24\text{ dBm}$
- $11\text{dBm} + 10\log(20.56) = 24.13\text{ dBm} > 24\text{ dBm}$
- $11\text{dBm} + 10\log(20.81) = 24.18\text{ dBm} > 24\text{ dBm}$
- $11\text{dBm} + 10\log(20.48) = 24.11\text{ dBm} > 24\text{ dBm}$
- $11\text{dBm} + 10\log(20.71) = 24.16\text{ dBm} > 24\text{ dBm}$
- $11\text{dBm} + 10\log(20.77) = 24.17\text{ dBm} > 24\text{ dBm}$
- $11\text{dBm} + 10\log(5725.00 - 5709.71) = 22.84\text{ dBm} < 24\text{ dBm}$

802.11n (HT40)

| Chan. | Freq. (MHz) | Maximum Conducted Power (dBm) | | | | Total Power (mW) | Total Power (dBm) | Power Limit (dBm) | Pass / Fail |
|-------|----------------------|-------------------------------|---------|---------|---------|------------------|-------------------|-------------------|-------------|
| | | Chain 0 | Chain 1 | Chain 2 | Chain 3 | | | | |
| 54 | 5270 | -3.53 | -4.24 | -3.96 | -4.16 | 1.606 | 2.06 | 6.73 | Pass |
| 62 | 5310 | -3.79 | -4.38 | -3.54 | -4.07 | 1.617 | 2.09 | 6.73 | Pass |
| 102 | 5510 | -3.84 | -3.85 | -4.07 | -4.08 | 1.608 | 2.06 | 6.73 | Pass |
| 110 | 5550 | -3.69 | -3.86 | -4.11 | -4.09 | 1.617 | 2.09 | 6.73 | Pass |
| 134 | 5670 | -3.45 | -3.99 | -3.96 | -4.48 | 1.609 | 2.07 | 6.73 | Pass |
| 142 | 5710 For U-NII-2C | -4.99 | -5.41 | -5.64 | -5.70 | 1.147 | 0.59 | 6.73 | Pass |
| 142 | 5710 For U-NII-3 | -15.92 | -16.47 | -17.08 | -18.59 | 0.082 | -10.89 | 12.73 | Pass |

Note:

- 5260~5320MHz, 5500~5720MHz Directional Gain = $18.5 + 10\log(3) = 23.27\text{dBi} > 6\text{dBi}$, so the limit shall be reduced to $24 - (23.27 - 6) = 6.73\text{dBm}$.
- 5745~5825MHz Directional Gain = $18.5 + 10\log(3) = 23.27\text{dBi} > 6\text{dBi}$, so the limit shall be reduced to $30 - (23.27 - 6) = 12.73\text{dBm}$.

For U-NII-2A, U-NII-2C

Chain 0

- $11\text{dBm} + 10\log (41.27) = 27.16 \text{ dBm} > 24 \text{ dBm}$
- $11\text{dBm} + 10\log (40.93) = 27.12 \text{ dBm} > 24 \text{ dBm}$
- $11\text{dBm} + 10\log (41.02) = 27.13 \text{ dBm} > 24 \text{ dBm}$
- $11\text{dBm} + 10\log (40.88) = 27.12 \text{ dBm} > 24 \text{ dBm}$
- $11\text{dBm} + 10\log (41.11) = 27.14 \text{ dBm} > 24 \text{ dBm}$
- $11\text{dBm} + 10\log (5725.00 - 5689.60) = 26.49 \text{ dBm} > 24 \text{ dBm}$

Chain 1

- $11\text{dBm} + 10\log (41.00) = 27.13 \text{ dBm} > 24 \text{ dBm}$
- $11\text{dBm} + 10\log (41.17) = 27.15 \text{ dBm} > 24 \text{ dBm}$
- $11\text{dBm} + 10\log (40.82) = 27.11 \text{ dBm} > 24 \text{ dBm}$
- $11\text{dBm} + 10\log (40.88) = 27.12 \text{ dBm} > 24 \text{ dBm}$
- $11\text{dBm} + 10\log (41.05) = 27.13 \text{ dBm} > 24 \text{ dBm}$
- $11\text{dBm} + 10\log (5725.00 - 5689.81) = 26.46 \text{ dBm} > 24 \text{ dBm}$

Chain 2

- $11\text{dBm} + 10\log (40.54) = 27.08 \text{ dBm} > 24 \text{ dBm}$
- $11\text{dBm} + 10\log (40.77) = 27.10 \text{ dBm} > 24 \text{ dBm}$
- $11\text{dBm} + 10\log (40.43) = 27.07 \text{ dBm} > 24 \text{ dBm}$
- $11\text{dBm} + 10\log (40.76) = 27.10 \text{ dBm} > 24 \text{ dBm}$
- $11\text{dBm} + 10\log (40.57) = 27.08 \text{ dBm} > 24 \text{ dBm}$
- $11\text{dBm} + 10\log (5725.00 - 5689.73) = 26.47 \text{ dBm} > 24 \text{ dBm}$

Chain 3

- $11\text{dBm} + 10\log (40.68) = 27.09 \text{ dBm} > 24 \text{ dBm}$
- $11\text{dBm} + 10\log (40.60) = 27.09 \text{ dBm} > 24 \text{ dBm}$
- $11\text{dBm} + 10\log (40.60) = 27.09 \text{ dBm} > 24 \text{ dBm}$
- $11\text{dBm} + 10\log (40.61) = 27.09 \text{ dBm} > 24 \text{ dBm}$
- $11\text{dBm} + 10\log (40.70) = 27.10 \text{ dBm} > 24 \text{ dBm}$
- $11\text{dBm} + 10\log (5725.00 - 5689.80) = 26.47 \text{ dBm} > 24 \text{ dBm}$

802.11ac (VHT80)

| Chan. | Freq. (MHz) | Maximum Conducted Power (dBm) | | | | Total Power (mW) | Total Power (dBm) | Power Limit (dBm) | Pass / Fail |
|-------|----------------------|-------------------------------|---------|---------|---------|------------------|-------------------|-------------------|-------------|
| | | Chain 0 | Chain 1 | Chain 2 | Chain 3 | | | | |
| 58 | 5290 | -3.27 | -3.98 | -3.53 | -3.88 | 1.724 | 2.36 | 6.73 | Pass |
| 106 | 5530 | -3.46 | -3.45 | -3.94 | -3.89 | 1.714 | 2.34 | 6.73 | Pass |
| 122 | 5610 | -3.15 | -3.86 | -3.63 | -3.83 | 1.743 | 2.41 | 6.73 | Pass |
| 138 | 5690 For U-NII-2C | -4.98 | -5.77 | -5.31 | -6.01 | 1.127 | 0.52 | 6.73 | Pass |
| 138 | 5690 For U-NII-3 | -17.67 | -19.18 | -18.50 | -19.01 | 0.056 | -12.53 | 12.73 | Pass |

Note:

- 5260~5320MHz, 5500~5720MHz Directional Gain = $18.5 + 10\log(3) = 23.27\text{dBi} > 6\text{dBi}$, so the limit shall be reduced to $24 - (23.27 - 6) = 6.73\text{dBm}$.
- 5745~5825MHz Directional Gain = $18.5 + 10\log(3) = 23.27\text{dBi} > 6\text{dBi}$, so the limit shall be reduced to $30 - (23.27 - 6) = 12.73\text{dBm}$.

For U-NII-2A, U-NII-2C

Chain 0

- $11\text{dBm} + 10\log(86.01) = 30.35\text{ dBm} > 24\text{ dBm}$
- $11\text{dBm} + 10\log(86.71) = 30.38\text{ dBm} > 24\text{ dBm}$
- $11\text{dBm} + 10\log(86.95) = 30.39\text{ dBm} > 24\text{ dBm}$
- $11\text{dBm} + 10\log(5725.00 - 5641.14) = 30.24\text{ dBm} > 24\text{ dBm}$

Chain 1

- $11\text{dBm} + 10\log(85.98) = 30.34\text{ dBm} > 24\text{ dBm}$
- $11\text{dBm} + 10\log(85.69) = 30.33\text{ dBm} > 24\text{ dBm}$
- $11\text{dBm} + 10\log(85.54) = 30.32\text{ dBm} > 24\text{ dBm}$
- $11\text{dBm} + 10\log(5725.00 - 5647.35) = 29.90\text{ dBm} > 24\text{ dBm}$

Chain 2

- $11\text{dBm} + 10\log(85.13) = 30.30\text{ dBm} > 24\text{ dBm}$
- $11\text{dBm} + 10\log(86.36) = 30.36\text{ dBm} > 24\text{ dBm}$
- $11\text{dBm} + 10\log(85.20) = 30.30\text{ dBm} > 24\text{ dBm}$
- $11\text{dBm} + 10\log(5725.00 - 5647.59) = 29.89\text{ dBm} > 24\text{ dBm}$

Chain 3

- $11\text{dBm} + 10\log(85.28) = 30.31\text{ dBm} > 24\text{ dBm}$
- $11\text{dBm} + 10\log(85.16) = 30.30\text{ dBm} > 24\text{ dBm}$
- $11\text{dBm} + 10\log(84.52) = 30.27\text{ dBm} > 24\text{ dBm}$
- $11\text{dBm} + 10\log(5725.00 - 5647.67) = 29.88\text{ dBm} > 24\text{ dBm}$

Mode B1

CDD Mode

802.11a

| Chan. | Freq. (MHz) | Maximum Conducted Power (dBm) | | | | Total Power (mW) | Total Power (dBm) | Power Limit (dBm) | Pass / Fail |
|-------|----------------------|-------------------------------|---------|---------|---------|------------------|-------------------|-------------------|-------------|
| | | Chain 0 | Chain 1 | Chain 2 | Chain 3 | | | | |
| 52 | 5260 | 10.35 | 10.32 | 10.75 | 10.49 | 44.683 | 16.50 | 21.76 | Pass |
| 60 | 5300 | 10.35 | 10.62 | 10.95 | 10.64 | 46.407 | 16.67 | 21.76 | Pass |
| 64 | 5320 | 10.18 | 10.69 | 10.88 | 10.59 | 45.846 | 16.61 | 21.76 | Pass |
| 100 | 5500 | 10.85 | 10.75 | 11.28 | 11.05 | 50.210 | 17.01 | 21.76 | Pass |
| 116 | 5580 | 10.92 | 10.28 | 11.15 | 11.02 | 48.704 | 16.88 | 21.76 | Pass |
| 140 | 5700 | 10.48 | 10.65 | 11.38 | 10.68 | 48.218 | 16.83 | 21.76 | Pass |
| 144 | 5720 For U-NII-2C | 8.95 | 9.54 | 10.40 | 9.21 | 36.149 | 15.58 | 21.76 | Pass |
| 144 | 5720 For U-NII-3 | 4.21 | 4.85 | 5.36 | 4.47 | 11.926 | 10.76 | 29 | Pass |

Note:

- 5260~5320MHz, 5500~5720MHz Gain = 7 > 6dBi, so the limit shall be reduced to 22.76-(7-6) = 21.76dBm.
- 5745~5825MHz Gain = 7 > 6dBi, so the limit shall be reduced to 30-(7-6) = 29dBm.

For U-NII-2A, U-NII-2C

Chain 0

- 11dBm + 10log (20.19) = 24.05 dBm > 24 dBm
- 11dBm + 10log (19.96) = 24.00 dBm = 24 dBm
- 11dBm + 10log (20.25) = 24.06 dBm > 24 dBm
- 11dBm + 10log (20.02) = 24.01 dBm > 24 dBm
- 11dBm + 10log (20.12) = 24.04 dBm > 24 dBm
- 11dBm + 10log (20.04) = 24.02 dBm > 24 dBm
- 11dBm + 10log (5725.00 - 5709.96) = 22.77 dBm < 24 dBm

Chain 1

- 11dBm + 10log (20.12) = 24.04 dBm > 24 dBm
- 11dBm + 10log (20.09) = 24.03 dBm > 24 dBm
- 11dBm + 10log (19.90) = 23.99 dBm < 24 dBm
- 11dBm + 10log (19.62) = 23.93 dBm < 24 dBm
- 11dBm + 10log (19.98) = 24.01 dBm > 24 dBm
- 11dBm + 10log (19.86) = 23.98 dBm < 24 dBm
- 11dBm + 10log (5725.00 - 5709.89) = 22.79 dBm < 24 dBm

Chain 2

- 11dBm + 10log (19.92) = 23.99 dBm < 24 dBm
- 11dBm + 10log (20.03) = 24.02 dBm > 24 dBm
- 11dBm + 10log (20.09) = 24.03 dBm > 24 dBm
- 11dBm + 10log (19.92) = 23.99 dBm < 24 dBm
- 11dBm + 10log (19.66) = 23.94 dBm < 24 dBm
- 11dBm + 10log (19.89) = 23.99 dBm < 24 dBm
- 11dBm + 10log (5725.00 - 5709.98) = 22.77 dBm < 24 dBm

Chain 3

- 11dBm + 10log (19.69) = 23.94 dBm < 24 dBm
- 11dBm + 10log (19.44) = 23.89 dBm < 24 dBm
- 11dBm + 10log (19.53) = 23.91 dBm < 24 dBm
- 11dBm + 10log (19.73) = 23.95 dBm < 24 dBm
- 11dBm + 10log (19.89) = 23.99 dBm < 24 dBm
- 11dBm + 10log (19.91) = 23.99 dBm < 24 dBm
- 11dBm + 10log (5725.00 - 5709.99) = 22.76 dBm < 24 dBm

802.11n (HT20)

| Chan. | Freq. (MHz) | Maximum Conducted Power (dBm) | | | | Total Power (mW) | Total Power (dBm) | Power Limit (dBm) | Pass / Fail |
|-------|----------------------|-------------------------------|---------|---------|---------|------------------|-------------------|-------------------|-------------|
| | | Chain 0 | Chain 1 | Chain 2 | Chain 3 | | | | |
| 52 | 5260 | 10.48 | 10.28 | 10.74 | 10.45 | 44.785 | 16.51 | 21.86 | Pass |
| 60 | 5300 | 10.47 | 10.74 | 11.02 | 10.78 | 47.615 | 16.78 | 21.86 | Pass |
| 64 | 5320 | 10.45 | 10.91 | 11.12 | 10.82 | 48.443 | 16.85 | 21.86 | Pass |
| 100 | 5500 | 11.07 | 10.78 | 11.41 | 11.25 | 51.932 | 17.15 | 21.86 | Pass |
| 116 | 5580 | 11.12 | 10.59 | 11.41 | 11.32 | 51.785 | 17.14 | 21.86 | Pass |
| 140 | 5700 | 10.55 | 13.78 | 11.35 | 11.66 | 63.529 | 18.03 | 21.86 | Pass |
| 144 | 5720 For U-NII-2C | 9.14 | 9.72 | 10.36 | 9.54 | 37.439 | 15.73 | 21.86 | Pass |
| 144 | 5720 For U-NII-3 | 4.68 | 5.15 | 5.74 | 4.95 | 13.087 | 11.17 | 29 | Pass |

Note:

- 5260~5320MHz, 5500~5720MHz Gain = 7 > 6dBi, so the limit shall be reduced to 22.86-(7-6) = 21.86dBm.
- 5745~5825MHz Gain = 7 > 6dBi, so the limit shall be reduced to 30-(7-6) = 29dBm.

For U-NII-2A, U-NII-2C

Chain 0

- 11dBm + 10log (20.80) = 24.18 dBm > 24 dBm
- 11dBm + 10log (20.85) = 24.19 dBm > 24 dBm
- 11dBm + 10log (20.96) = 24.21 dBm > 24 dBm
- 11dBm + 10log (21.06) = 24.23 dBm > 24 dBm
- 11dBm + 10log (21.18) = 24.26 dBm > 24 dBm
- 11dBm + 10log (20.62) = 24.14 dBm > 24 dBm
- 11dBm + 10log (5725.00 - 5709.63) = 22.87 dBm < 24 dBm

Chain 1

- 11dBm + 10log (20.54) = 24.13 dBm > 24 dBm
- 11dBm + 10log (20.54) = 24.13 dBm > 24 dBm
- 11dBm + 10log (20.66) = 24.15 dBm > 24 dBm
- 11dBm + 10log (20.83) = 24.19 dBm > 24 dBm
- 11dBm + 10log (21.01) = 24.22 dBm > 24 dBm
- 11dBm + 10log (21.05) = 24.23 dBm > 24 dBm
- 11dBm + 10log (5725.00 - 5709.53) = 22.89 dBm < 24 dBm

Chain 2

- 11dBm + 10log (20.77) = 24.17 dBm > 24 dBm
- 11dBm + 10log (21.01) = 24.22 dBm > 24 dBm
- 11dBm + 10log (21.06) = 24.23 dBm > 24 dBm
- 11dBm + 10log (20.85) = 24.19 dBm > 24 dBm
- 11dBm + 10log (20.57) = 24.13 dBm > 24 dBm
- 11dBm + 10log (20.61) = 24.14 dBm > 24 dBm
- 11dBm + 10log (5725.00 - 5709.66) = 22.86 dBm < 24 dBm

Chain 3

- 11dBm + 10log (20.65) = 24.15 dBm > 24 dBm
- 11dBm + 10log (20.51) = 24.12 dBm > 24 dBm
- 11dBm + 10log (20.69) = 24.16 dBm > 24 dBm
- 11dBm + 10log (21.02) = 24.23 dBm > 24 dBm
- 11dBm + 10log (20.82) = 24.18 dBm > 24 dBm
- 11dBm + 10log (20.84) = 24.19 dBm > 24 dBm
- 11dBm + 10log (5725.00 - 5709.43) = 22.92 dBm < 24 dBm

802.11n (HT40)

| Chan. | Freq. (MHz) | Maximum Conducted Power (dBm) | | | | Total Power (mW) | Total Power (dBm) | Power Limit (dBm) | Pass / Fail |
|-------|----------------------|-------------------------------|---------|---------|---------|------------------|-------------------|-------------------|-------------|
| | | Chain 0 | Chain 1 | Chain 2 | Chain 3 | | | | |
| 54 | 5270 | 13.28 | 13.18 | 13.44 | 13.16 | 84.859 | 19.29 | 23 | Pass |
| 62 | 5310 | 12.95 | 12.31 | 13.11 | 12.31 | 74.232 | 18.71 | 23 | Pass |
| 102 | 5510 | 12.77 | 12.01 | 12.94 | 12.87 | 73.851 | 18.68 | 23 | Pass |
| 110 | 5550 | 13.63 | 12.94 | 13.81 | 13.62 | 89.804 | 19.53 | 23 | Pass |
| 134 | 5670 | 13.36 | 12.67 | 14.34 | 13.53 | 89.876 | 19.54 | 23 | Pass |
| 142 | 5710 For U-NII-2C | 12.32 | 12.54 | 13.13 | 12.44 | 73.106 | 18.64 | 23 | Pass |
| 142 | 5710 For U-NII-3 | 4.05 | 4.32 | 5.00 | 4.13 | 10.995 | 10.41 | 29 | Pass |

Note:

- 5260~5320MHz, 5500~5720MHz Gain = 7 > 6dBi, so the limit shall be reduced to 24-(7-6) = 23dBm.
- 5745~5825MHz Gain = 7 > 6dBi, so the limit shall be reduced to 30-(7-6) = 29dBm.

For U-NII-2A, U-NII-2C

Chain 0

- 11dBm + 10log (40.56) = 27.08 dBm > 24 dBm
- 11dBm + 10log (40.81) = 27.11 dBm > 24 dBm
- 11dBm + 10log (40.85) = 27.11 dBm > 24 dBm
- 11dBm + 10log (40.76) = 27.10 dBm > 24 dBm
- 11dBm + 10log (40.81) = 27.11 dBm > 24 dBm
- 11dBm + 10log (5725.00 - 5689.63) = 26.49 dBm > 24 dBm

Chain 1

- 11dBm + 10log (40.71) = 27.10 dBm > 24 dBm
- 11dBm + 10log (40.64) = 27.09 dBm > 24 dBm
- 11dBm + 10log (40.67) = 27.09 dBm > 24 dBm
- 11dBm + 10log (40.96) = 27.12 dBm > 24 dBm
- 11dBm + 10log (40.70) = 27.10 dBm > 24 dBm
- 11dBm + 10log (5725.00 - 5689.54) = 26.50 dBm > 24 dBm

Chain 2

- 11dBm + 10log (40.59) = 27.08 dBm > 24 dBm
- 11dBm + 10log (40.70) = 27.10 dBm > 24 dBm
- 11dBm + 10log (40.55) = 27.08 dBm > 24 dBm
- 11dBm + 10log (40.62) = 27.09 dBm > 24 dBm
- 11dBm + 10log (40.52) = 27.08 dBm > 24 dBm
- 11dBm + 10log (5725.00 - 5689.84) = 26.46 dBm > 24 dBm

Chain 3

- 11dBm + 10log (40.45) = 27.07 dBm > 24 dBm
- 11dBm + 10log (40.60) = 27.09 dBm > 24 dBm
- 11dBm + 10log (40.61) = 27.09 dBm > 24 dBm
- 11dBm + 10log (40.37) = 27.06 dBm > 24 dBm
- 11dBm + 10log (40.36) = 27.06 dBm > 24 dBm
- 11dBm + 10log (5725.00 - 5689.59) = 26.49 dBm > 24 dBm

802.11ac (VHT80)

| Chan. | Freq. (MHz) | Maximum Conducted Power (dBm) | | | | Total Power (mW) | Total Power (dBm) | Power Limit (dBm) | Pass / Fail |
|-------|----------------------|-------------------------------|---------|---------|---------|------------------|-------------------|-------------------|-------------|
| | | Chain 0 | Chain 1 | Chain 2 | Chain 3 | | | | |
| 58 | 5290 | 9.71 | 10.17 | 10.25 | 9.81 | 39.918 | 16.01 | 23 | Pass |
| 106 | 5530 | 8.53 | 8.21 | 8.47 | 8.37 | 27.653 | 14.42 | 23 | Pass |
| 122 | 5610 | 15.77 | 15.25 | 15.13 | 15.17 | 136.723 | 21.36 | 23 | Pass |
| 138 | 5690 For U-NII-2C | 11.40 | 10.71 | 11.88 | 11.61 | 55.485 | 17.44 | 23 | Pass |
| 138 | 5690 For U-NII-3 | -3.21 | -2.70 | -1.71 | -3.77 | 2.109 | 3.24 | 29 | Pass |

Note:

- 5260~5320MHz, 5500~5720MHz Gain = 7 > 6dBi, so the limit shall be reduced to 24-(7-6) = 23dBm.
- 5745~5825MHz Gain = 7 > 6dBi, so the limit shall be reduced to 30-(7-6) = 29dBm.

For U-NII-2A, U-NII-2C

Chain 0

- 11dBm + 10log (86.08) = 30.35 dBm > 24 dBm
- 11dBm + 10log (85.76) = 30.33 dBm > 24 dBm
- 11dBm + 10log (85.49) = 30.32 dBm > 24 dBm
- 11dBm + 10log (5725.00 - 5647.14) = 29.91 dBm > 24 dBm

Chain 1

- 11dBm + 10log (86.42) = 30.37 dBm > 24 dBm
- 11dBm + 10log (86.02) = 30.35 dBm > 24 dBm
- 11dBm + 10log (85.28) = 30.31 dBm > 24 dBm
- 11dBm + 10log (5725.00 - 5647.62) = 29.89 dBm > 24 dBm

Chain 2

- 11dBm + 10log (84.38) = 30.26 dBm > 24 dBm
- 11dBm + 10log (84.53) = 30.27 dBm > 24 dBm
- 11dBm + 10log (98.61) = 30.94 dBm > 24 dBm
- 11dBm + 10log (5725.00 - 5647.27) = 29.91 dBm > 24 dBm

Chain 3

- 11dBm + 10log (84.86) = 30.29 dBm > 24 dBm
- 11dBm + 10log (84.03) = 30.24 dBm > 24 dBm
- 11dBm + 10log (87.08) = 30.40 dBm > 24 dBm
- 11dBm + 10log (5725.00 - 5646.86) = 29.93 dBm > 24 dBm

Beamforming Mode

802.11n (HT20)

| Chan. | Freq. (MHz) | Maximum Conducted Power (dBm) | | | | Total Power (mW) | Total Power (dBm) | Power Limit (dBm) | Pass / Fail |
|-------|----------------------|-------------------------------|---------|---------|---------|------------------|-------------------|-------------------|-------------|
| | | Chain 0 | Chain 1 | Chain 2 | Chain 3 | | | | |
| 52 | 5260 | 4.46 | 4.26 | 4.72 | 4.43 | 11.196 | 10.49 | 15.84 | Pass |
| 60 | 5300 | 4.45 | 4.72 | 5.00 | 4.76 | 11.904 | 10.76 | 15.84 | Pass |
| 64 | 5320 | 4.43 | 4.89 | 5.10 | 4.80 | 12.111 | 10.83 | 15.84 | Pass |
| 100 | 5500 | 5.05 | 4.76 | 5.39 | 5.23 | 12.983 | 11.13 | 15.84 | Pass |
| 116 | 5580 | 5.10 | 4.57 | 5.39 | 5.30 | 12.946 | 11.12 | 15.84 | Pass |
| 140 | 5700 | 4.53 | 7.76 | 5.33 | 5.64 | 15.882 | 12.01 | 15.84 | Pass |
| 144 | 5720 For U-NII-2C | 3.12 | 3.70 | 4.34 | 3.52 | 9.360 | 9.71 | 15.84 | Pass |
| 144 | 5720 For U-NII-3 | -1.34 | -0.87 | -0.28 | -1.07 | 3.272 | 5.15 | 22.98 | Pass |

Note:

- 5260~5320MHz, 5500~5720MHz Directional Gain = $7 + 10\log(4) = 13.02\text{dBi} > 6\text{dBi}$, so the limit shall be reduced to $22.86 - (13.02 - 6) = 15.84\text{dBm}$.
- 5745~5825MHz Directional Gain = $7 + 10\log(4) = 13.02\text{dBi} > 6\text{dBi}$, so the limit shall be reduced to $30 - (13.02 - 6) = 22.98\text{dBm}$.

For U-NII-2A, U-NII-2C

Chain 0

- $11\text{dBm} + 10\log(20.80) = 24.18\text{ dBm} > 24\text{ dBm}$
- $11\text{dBm} + 10\log(20.85) = 24.19\text{ dBm} > 24\text{ dBm}$
- $11\text{dBm} + 10\log(20.96) = 24.21\text{ dBm} > 24\text{ dBm}$
- $11\text{dBm} + 10\log(21.06) = 24.23\text{ dBm} > 24\text{ dBm}$
- $11\text{dBm} + 10\log(21.18) = 24.26\text{ dBm} > 24\text{ dBm}$
- $11\text{dBm} + 10\log(20.62) = 24.14\text{ dBm} > 24\text{ dBm}$
- $11\text{dBm} + 10\log(5725.00 - 5709.63) = 22.87\text{ dBm} < 24\text{ dBm}$

Chain 1

- $11\text{dBm} + 10\log(20.54) = 24.13\text{ dBm} > 24\text{ dBm}$
- $11\text{dBm} + 10\log(20.54) = 24.13\text{ dBm} > 24\text{ dBm}$
- $11\text{dBm} + 10\log(20.66) = 24.15\text{ dBm} > 24\text{ dBm}$
- $11\text{dBm} + 10\log(20.83) = 24.19\text{ dBm} > 24\text{ dBm}$
- $11\text{dBm} + 10\log(21.01) = 24.22\text{ dBm} > 24\text{ dBm}$
- $11\text{dBm} + 10\log(21.05) = 24.23\text{ dBm} > 24\text{ dBm}$
- $11\text{dBm} + 10\log(5725.00 - 5709.53) = 22.89\text{ dBm} < 24\text{ dBm}$

Chain 2

- $11\text{dBm} + 10\log(20.77) = 24.17\text{ dBm} > 24\text{ dBm}$
- $11\text{dBm} + 10\log(21.01) = 24.22\text{ dBm} > 24\text{ dBm}$
- $11\text{dBm} + 10\log(21.06) = 24.23\text{ dBm} > 24\text{ dBm}$
- $11\text{dBm} + 10\log(20.85) = 24.19\text{ dBm} > 24\text{ dBm}$
- $11\text{dBm} + 10\log(20.57) = 24.13\text{ dBm} > 24\text{ dBm}$
- $11\text{dBm} + 10\log(20.61) = 24.14\text{ dBm} > 24\text{ dBm}$
- $11\text{dBm} + 10\log(5725.00 - 5709.66) = 22.86\text{ dBm} < 24\text{ dBm}$

Chain 3

- $11\text{dBm} + 10\log(20.65) = 24.15\text{ dBm} > 24\text{ dBm}$
- $11\text{dBm} + 10\log(20.51) = 24.12\text{ dBm} > 24\text{ dBm}$
- $11\text{dBm} + 10\log(20.69) = 24.16\text{ dBm} > 24\text{ dBm}$
- $11\text{dBm} + 10\log(21.02) = 24.23\text{ dBm} > 24\text{ dBm}$
- $11\text{dBm} + 10\log(20.82) = 24.18\text{ dBm} > 24\text{ dBm}$
- $11\text{dBm} + 10\log(20.84) = 24.19\text{ dBm} > 24\text{ dBm}$
- $11\text{dBm} + 10\log(5725.00 - 5709.43) = 22.92\text{ dBm} < 24\text{ dBm}$

802.11n (HT40)

| Chan. | Freq. (MHz) | Maximum Conducted Power (dBm) | | | | Total Power (mW) | Total Power (dBm) | Power Limit (dBm) | Pass / Fail |
|-------|----------------------|-------------------------------|---------|---------|---------|------------------|-------------------|-------------------|-------------|
| | | Chain 0 | Chain 1 | Chain 2 | Chain 3 | | | | |
| 54 | 5270 | 7.26 | 7.16 | 7.42 | 7.14 | 21.215 | 13.27 | 16.98 | Pass |
| 62 | 5310 | 6.93 | 6.29 | 7.09 | 6.29 | 18.558 | 12.69 | 16.98 | Pass |
| 102 | 5510 | 6.75 | 5.99 | 6.92 | 6.85 | 18.463 | 12.66 | 16.98 | Pass |
| 110 | 5550 | 7.61 | 6.92 | 7.79 | 7.60 | 22.451 | 13.51 | 16.98 | Pass |
| 134 | 5670 | 7.34 | 6.65 | 8.32 | 7.51 | 22.469 | 13.52 | 16.98 | Pass |
| 142 | 5710 For U-NII-2C | 6.30 | 6.52 | 7.11 | 6.42 | 18.276 | 12.62 | 16.98 | Pass |
| 142 | 5710 For U-NII-3 | -1.97 | -1.70 | -1.02 | -1.89 | 2.749 | 4.39 | 22.98 | Pass |

Note:

- 5260~5320MHz, 5500~5720MHz Directional Gain = $7 + 10\log(4) = 13.02\text{dBi} > 6\text{dBi}$, so the limit shall be reduced to $24 - (13.02 - 6) = 16.98\text{dBm}$.
- 5745~5825MHz Directional Gain = $7 + 10\log(4) = 13.02\text{dBi} > 6\text{dBi}$, so the limit shall be reduced to $30 - (13.02 - 6) = 22.98\text{dBm}$.

For U-NII-2A, U-NII-2C

Chain 0

- $11\text{dBm} + 10\log (40.56) = 27.08 \text{ dBm} > 24 \text{ dBm}$
- $11\text{dBm} + 10\log (40.81) = 27.11 \text{ dBm} > 24 \text{ dBm}$
- $11\text{dBm} + 10\log (40.85) = 27.11 \text{ dBm} > 24 \text{ dBm}$
- $11\text{dBm} + 10\log (40.76) = 27.10 \text{ dBm} > 24 \text{ dBm}$
- $11\text{dBm} + 10\log (40.81) = 27.11 \text{ dBm} > 24 \text{ dBm}$
- $11\text{dBm} + 10\log (5725.00 - 5689.63) = 26.49 \text{ dBm} > 24 \text{ dBm}$

Chain 1

- $11\text{dBm} + 10\log (40.71) = 27.10 \text{ dBm} > 24 \text{ dBm}$
- $11\text{dBm} + 10\log (40.64) = 27.09 \text{ dBm} > 24 \text{ dBm}$
- $11\text{dBm} + 10\log (40.67) = 27.09 \text{ dBm} > 24 \text{ dBm}$
- $11\text{dBm} + 10\log (40.96) = 27.12 \text{ dBm} > 24 \text{ dBm}$
- $11\text{dBm} + 10\log (40.70) = 27.10 \text{ dBm} > 24 \text{ dBm}$
- $11\text{dBm} + 10\log (5725.00 - 5689.54) = 26.50 \text{ dBm} > 24 \text{ dBm}$

Chain 2

- $11\text{dBm} + 10\log (40.59) = 27.08 \text{ dBm} > 24 \text{ dBm}$
- $11\text{dBm} + 10\log (40.70) = 27.10 \text{ dBm} > 24 \text{ dBm}$
- $11\text{dBm} + 10\log (40.55) = 27.08 \text{ dBm} > 24 \text{ dBm}$
- $11\text{dBm} + 10\log (40.62) = 27.09 \text{ dBm} > 24 \text{ dBm}$
- $11\text{dBm} + 10\log (40.52) = 27.08 \text{ dBm} > 24 \text{ dBm}$
- $11\text{dBm} + 10\log (5725.00 - 5689.84) = 26.46 \text{ dBm} > 24 \text{ dBm}$

Chain 3

- $11\text{dBm} + 10\log (40.45) = 27.07 \text{ dBm} > 24 \text{ dBm}$
- $11\text{dBm} + 10\log (40.60) = 27.09 \text{ dBm} > 24 \text{ dBm}$
- $11\text{dBm} + 10\log (40.61) = 27.09 \text{ dBm} > 24 \text{ dBm}$
- $11\text{dBm} + 10\log (40.37) = 27.06 \text{ dBm} > 24 \text{ dBm}$
- $11\text{dBm} + 10\log (40.36) = 27.06 \text{ dBm} > 24 \text{ dBm}$
- $11\text{dBm} + 10\log (5725.00 - 5689.59) = 26.49 \text{ dBm} > 24 \text{ dBm}$

802.11ac (VHT80)

| Chan. | Freq. (MHz) | Maximum Conducted Power (dBm) | | | | Total Power (mW) | Total Power (dBm) | Power Limit (dBm) | Pass / Fail |
|-------|----------------------|-------------------------------|---------|---------|---------|------------------|-------------------|-------------------|-------------|
| | | Chain 0 | Chain 1 | Chain 2 | Chain 3 | | | | |
| 58 | 5290 | 3.69 | 4.15 | 4.23 | 3.79 | 9.979 | 9.99 | 16.98 | Pass |
| 106 | 5530 | 2.51 | 2.19 | 2.45 | 2.35 | 6.913 | 8.40 | 16.98 | Pass |
| 122 | 5610 | 9.75 | 9.23 | 9.11 | 9.15 | 34.181 | 15.34 | 16.98 | Pass |
| 138 | 5690 For U-NII-2C | 5.38 | 4.69 | 5.86 | 5.59 | 13.871 | 11.42 | 16.98 | Pass |
| 138 | 5690 For U-NII-3 | -9.23 | -8.72 | -7.73 | -9.79 | 0.527 | -2.78 | 22.98 | Pass |

Note:

- 5260~5320MHz, 5500~5720MHz Directional Gain = $7 + 10\log(4) = 13.02\text{dBi} > 6\text{dBi}$, so the limit shall be reduced to $24 - (13.02 - 6) = 16.98\text{dBm}$.
- 5745~5825MHz Directional Gain = $7 + 10\log(4) = 13.02\text{dBi} > 6\text{dBi}$, so the limit shall be reduced to $30 - (13.02 - 6) = 22.98\text{dBm}$.

For U-NII-2A, U-NII-2C

Chain 0

- $11\text{dBm} + 10\log(86.08) = 30.35\text{ dBm} > 24\text{ dBm}$
- $11\text{dBm} + 10\log(85.76) = 30.33\text{ dBm} > 24\text{ dBm}$
- $11\text{dBm} + 10\log(85.49) = 30.32\text{ dBm} > 24\text{ dBm}$
- $11\text{dBm} + 10\log(5725.00 - 5647.14) = 29.91\text{ dBm} > 24\text{ dBm}$

Chain 1

- $11\text{dBm} + 10\log(86.42) = 30.37\text{ dBm} > 24\text{ dBm}$
- $11\text{dBm} + 10\log(86.02) = 30.35\text{ dBm} > 24\text{ dBm}$
- $11\text{dBm} + 10\log(85.28) = 30.31\text{ dBm} > 24\text{ dBm}$
- $11\text{dBm} + 10\log(5725.00 - 5647.62) = 29.89\text{ dBm} > 24\text{ dBm}$

Chain 2

- $11\text{dBm} + 10\log(84.38) = 30.26\text{ dBm} > 24\text{ dBm}$
- $11\text{dBm} + 10\log(84.53) = 30.27\text{ dBm} > 24\text{ dBm}$
- $11\text{dBm} + 10\log(98.61) = 30.94\text{ dBm} > 24\text{ dBm}$
- $11\text{dBm} + 10\log(5725.00 - 5647.27) = 29.91\text{ dBm} > 24\text{ dBm}$

Chain 3

- $11\text{dBm} + 10\log(84.86) = 30.29\text{ dBm} > 24\text{ dBm}$
- $11\text{dBm} + 10\log(84.03) = 30.24\text{ dBm} > 24\text{ dBm}$
- $11\text{dBm} + 10\log(87.08) = 30.40\text{ dBm} > 24\text{ dBm}$
- $11\text{dBm} + 10\log(5725.00 - 5646.86) = 29.93\text{ dBm} > 24\text{ dBm}$

Mode B2

CDD Mode

802.11a

| Chan. | Freq. (MHz) | Maximum Conducted Power (dBm) | | | | Total Power (mW) | Total Power (dBm) | Power Limit (dBm) | Pass / Fail |
|-------|----------------------|-------------------------------|---------|---------|---------|------------------|-------------------|-------------------|-------------|
| | | Chain 0 | Chain 1 | Chain 2 | Chain 3 | | | | |
| 52 | 5260 | 1.11 | 0.96 | 1.13 | 1.09 | 5.120 | 7.09 | 10.31 | Pass |
| 60 | 5300 | 1.02 | 1.13 | 1.42 | 1.01 | 5.211 | 7.17 | 10.31 | Pass |
| 64 | 5320 | 0.93 | 1.17 | 1.11 | 1.07 | 5.118 | 7.09 | 10.31 | Pass |
| 100 | 5500 | 1.01 | 0.57 | 1.26 | 1.17 | 5.048 | 7.03 | 10.31 | Pass |
| 116 | 5580 | 1.09 | 1.11 | 1.32 | 1.14 | 5.231 | 7.19 | 10.31 | Pass |
| 140 | 5700 | 1.12 | 1.03 | 1.68 | 1.09 | 5.319 | 7.26 | 10.31 | Pass |
| 144 | 5720 For U-NII-2C | -0.93 | -0.71 | -0.39 | -0.90 | 3.383 | 5.29 | 10.31 | Pass |
| 144 | 5720 For U-NII-3 | -5.58 | -5.73 | -5.05 | -5.67 | 1.128 | 0.52 | 17.5 | Pass |

Note:

- 5260~5320MHz, 5500~5720MHz Gain = 18.5 > 6dBi, so the limit shall be reduced to 22.81-(18.5-6) = 10.31dBm.
- 5745~5825MHz Gain = 18.5 > 6dBi, so the limit shall be reduced to 30-(18.5-6) = 17.5dBm.

For U-NII-2A, U-NII-2C

Chain 0

- 11dBm + 10log (20.31) = 24.08 dBm > 24 dBm
- 11dBm + 10log (20.41) = 24.10 dBm > 24 dBm
- 11dBm + 10log (20.22) = 24.06 dBm > 24 dBm
- 11dBm + 10log (20.30) = 24.07 dBm > 24 dBm
- 11dBm + 10log (19.95) = 24.00 dBm = 24 dBm
- 11dBm + 10log (20.22) = 24.06 dBm > 24 dBm
- 11dBm + 10log (5725.00 - 5709.81) = 22.82 dBm < 24 dBm

Chain 1

- 11dBm + 10log (19.95) = 24.00 dBm = 24 dBm
- 11dBm + 10log (20.29) = 24.07 dBm > 24 dBm
- 11dBm + 10log (20.18) = 24.05 dBm > 24 dBm
- 11dBm + 10log (20.30) = 24.07 dBm > 24 dBm
- 11dBm + 10log (20.32) = 24.08 dBm > 24 dBm
- 11dBm + 10log (20.44) = 24.10 dBm > 24 dBm
- 11dBm + 10log (5725.00 - 5709.78) = 22.82 dBm < 24 dBm

Chain 2

- 11dBm + 10log (20.30) = 24.07 dBm > 24 dBm
- 11dBm + 10log (20.45) = 24.11 dBm > 24 dBm
- 11dBm + 10log (19.73) = 23.95 dBm < 24 dBm
- 11dBm + 10log (19.93) = 24.00 dBm > 24 dBm
- 11dBm + 10log (19.67) = 23.94 dBm < 24 dBm
- 11dBm + 10log (19.77) = 23.96 dBm < 24 dBm
- 11dBm + 10log (5725.00 - 5709.79) = 22.82 dBm < 24 dBm

Chain 3

- 11dBm + 10log (20.01) = 24.01 dBm > 24 dBm
- 11dBm + 10log (20.12) = 24.04 dBm > 24 dBm
- 11dBm + 10log (19.89) = 23.99 dBm < 24 dBm
- 11dBm + 10log (20.07) = 24.03 dBm > 24 dBm
- 11dBm + 10log (20.12) = 24.04 dBm > 24 dBm
- 11dBm + 10log (20.33) = 24.08 dBm > 24 dBm
- 11dBm + 10log (5725.00 - 5709.84) = 22.81 dBm < 24 dBm

802.11n (HT20)

| Chan. | Freq. (MHz) | Maximum Conducted Power (dBm) | | | | Total Power (mW) | Total Power (dBm) | Power Limit (dBm) | Pass / Fail |
|-------|----------------------|-------------------------------|---------|---------|---------|------------------|-------------------|-------------------|-------------|
| | | Chain 0 | Chain 1 | Chain 2 | Chain 3 | | | | |
| 52 | 5260 | 1.19 | 0.98 | 1.39 | 1.01 | 5.207 | 7.17 | 10.34 | Pass |
| 60 | 5300 | 1.03 | 1.08 | 1.47 | 1.32 | 5.308 | 7.25 | 10.34 | Pass |
| 64 | 5320 | 1.04 | 1.25 | 1.38 | 1.33 | 5.337 | 7.27 | 10.34 | Pass |
| 100 | 5500 | 1.21 | 1.46 | 1.35 | 1.17 | 5.395 | 7.32 | 10.34 | Pass |
| 116 | 5580 | 1.28 | 1.39 | 1.26 | 1.18 | 5.369 | 7.30 | 10.34 | Pass |
| 140 | 5700 | 0.87 | 0.82 | 1.54 | 1.23 | 5.183 | 7.15 | 10.34 | Pass |
| 144 | 5720 For U-NII-2C | -0.75 | -0.53 | -0.32 | -0.35 | 3.578 | 5.54 | 10.34 | Pass |
| 144 | 5720 For U-NII-3 | -5.89 | -7.31 | -5.75 | -6.38 | 0.940 | -0.27 | 17.5 | Pass |

Note:

- 5260~5320MHz, 5500~5720MHz Gain = 18.5 > 6dBi, so the limit shall be reduced to 22.84-(18.5-6) = 10.34dBm.
- 5745~5825MHz Gain = 18.5 > 6dBi, so the limit shall be reduced to 30-(18.5-6) = 17.5dBm.

For U-NII-2A, U-NII-2C

Chain 0

- 11dBm + 10log (20.75) = 24.17 dBm > 24 dBm
- 11dBm + 10log (20.64) = 24.15 dBm > 24 dBm
- 11dBm + 10log (20.69) = 24.16 dBm > 24 dBm
- 11dBm + 10log (20.54) = 24.13 dBm > 24 dBm
- 11dBm + 10log (20.56) = 24.13 dBm > 24 dBm
- 11dBm + 10log (20.92) = 24.21 dBm > 24 dBm
- 11dBm + 10log (5725.00 - 5709.71) = 22.84 dBm < 24 dBm

Chain 1

- 11dBm + 10log (20.77) = 24.17 dBm > 24 dBm
- 11dBm + 10log (20.73) = 24.17 dBm > 24 dBm
- 11dBm + 10log (20.84) = 24.19 dBm > 24 dBm
- 11dBm + 10log (20.89) = 24.20 dBm > 24 dBm
- 11dBm + 10log (20.73) = 24.17 dBm > 24 dBm
- 11dBm + 10log (20.73) = 24.17 dBm > 24 dBm
- 11dBm + 10log (5725.00 - 5709.58) = 22.88 dBm < 24 dBm

Chain 2

- 11dBm + 10log (20.77) = 24.17 dBm > 24 dBm
- 11dBm + 10log (20.83) = 24.19 dBm > 24 dBm
- 11dBm + 10log (21.00) = 24.22 dBm > 24 dBm
- 11dBm + 10log (20.95) = 24.21 dBm > 24 dBm
- 11dBm + 10log (20.67) = 24.15 dBm > 24 dBm
- 11dBm + 10log (20.66) = 24.15 dBm > 24 dBm
- 11dBm + 10log (5725.00 - 5709.61) = 22.87 dBm < 24 dBm

Chain 3

- 11dBm + 10log (20.61) = 24.14 dBm > 24 dBm
- 11dBm + 10log (20.52) = 24.12 dBm > 24 dBm
- 11dBm + 10log (20.65) = 24.15 dBm > 24 dBm
- 11dBm + 10log (20.62) = 24.14 dBm > 24 dBm
- 11dBm + 10log (20.68) = 24.16 dBm > 24 dBm
- 11dBm + 10log (20.75) = 24.17 dBm > 24 dBm
- 11dBm + 10log (5725.00 - 5709.55) = 22.89 dBm < 24 dBm

802.11n (HT40)

| Chan. | Freq. (MHz) | Maximum Conducted Power (dBm) | | | | Total Power (mW) | Total Power (dBm) | Power Limit (dBm) | Pass / Fail |
|-------|----------------------|-------------------------------|---------|---------|---------|------------------|-------------------|-------------------|-------------|
| | | Chain 0 | Chain 1 | Chain 2 | Chain 3 | | | | |
| 54 | 5270 | 2.49 | 2.00 | 2.59 | 2.21 | 6.838 | 8.35 | 11.5 | Pass |
| 62 | 5310 | 1.94 | 1.83 | 2.22 | 1.96 | 6.324 | 8.01 | 11.5 | Pass |
| 102 | 5510 | 2.25 | 1.36 | 2.23 | 2.11 | 6.344 | 8.02 | 11.5 | Pass |
| 110 | 5550 | 2.35 | 1.26 | 2.26 | 1.99 | 6.319 | 8.01 | 11.5 | Pass |
| 134 | 5670 | 2.49 | 1.61 | 3.11 | 2.19 | 6.925 | 8.40 | 11.5 | Pass |
| 142 | 5710 For U-NII-2C | 1.30 | 1.19 | 1.77 | 1.23 | 5.494 | 7.40 | 11.5 | Pass |
| 142 | 5710 For U-NII-3 | -6.77 | -6.87 | -6.22 | -6.99 | 0.855 | -0.68 | 17.5 | Pass |

Note:

- 5260~5320MHz, 5500~5720MHz Gain = 18.5 > 6dBi, so the limit shall be reduced to 24-(18.5-6) = 11.5dBm.
- 5745~5825MHz Gain = 18.5 > 6dBi, so the limit shall be reduced to 30-(18.5-6) = 17.5dBm.

For U-NII-2A, U-NII-2C

Chain 0

- 11dBm + 10log (40.83) = 27.11 dBm > 24 dBm
- 11dBm + 10log (41.00) = 27.13 dBm > 24 dBm
- 11dBm + 10log (40.98) = 27.13 dBm > 24 dBm
- 11dBm + 10log (40.93) = 27.12 dBm > 24 dBm
- 11dBm + 10log (40.87) = 27.11 dBm > 24 dBm
- 11dBm + 10log (5725.00 - 5689.64) = 26.49 dBm > 24 dBm

Chain 1

- 11dBm + 10log (41.01) = 27.13 dBm > 24 dBm
- 11dBm + 10log (41.12) = 27.14 dBm > 24 dBm
- 11dBm + 10log (40.96) = 27.12 dBm > 24 dBm
- 11dBm + 10log (40.94) = 27.12 dBm > 24 dBm
- 11dBm + 10log (41.11) = 27.14 dBm > 24 dBm
- 11dBm + 10log (5725.00 - 5689.63) = 26.49 dBm > 24 dBm

Chain 2

- 11dBm + 10log (40.68) = 27.09 dBm > 24 dBm
- 11dBm + 10log (40.88) = 27.12 dBm > 24 dBm
- 11dBm + 10log (40.69) = 27.09 dBm > 24 dBm
- 11dBm + 10log (40.66) = 27.09 dBm > 24 dBm
- 11dBm + 10log (40.66) = 27.09 dBm > 24 dBm
- 11dBm + 10log (5725.00 - 5689.72) = 26.48 dBm > 24 dBm

Chain 3

- 11dBm + 10log (40.93) = 27.12 dBm > 24 dBm
- 11dBm + 10log (40.79) = 27.11 dBm > 24 dBm
- 11dBm + 10log (40.75) = 27.10 dBm > 24 dBm
- 11dBm + 10log (40.55) = 27.08 dBm > 24 dBm
- 11dBm + 10log (40.53) = 27.08 dBm > 24 dBm
- 11dBm + 10log (5725.00 - 5689.79) = 26.47 dBm > 24 dBm

802.11ac (VHT80)

| Chan. | Freq. (MHz) | Maximum Conducted Power (dBm) | | | | Total Power (mW) | Total Power (dBm) | Power Limit (dBm) | Pass / Fail |
|-------|----------------------|-------------------------------|---------|---------|---------|------------------|-------------------|-------------------|-------------|
| | | Chain 0 | Chain 1 | Chain 2 | Chain 3 | | | | |
| 58 | 5290 | 2.31 | 2.12 | 2.52 | 2.23 | 6.788 | 8.32 | 11.5 | Pass |
| 106 | 5530 | 2.24 | 1.52 | 2.39 | 2.26 | 6.511 | 8.14 | 11.5 | Pass |
| 122 | 5610 | 2.36 | 1.62 | 2.24 | 2.13 | 6.482 | 8.12 | 11.5 | Pass |
| 138 | 5690 For U-NII-2C | 1.48 | 1.17 | 2.28 | 1.77 | 5.908 | 7.71 | 11.5 | Pass |
| 138 | 5690 For U-NII-3 | -8.15 | -8.24 | -7.58 | -8.18 | 0.630 | -2.01 | 17.5 | Pass |

Note:

1. 5260~5320MHz, 5500~5720MHz Gain = 18.5 > 6dBi, so the limit shall be reduced to 24-(18.5-6) = 11.5dBm.

2. 5745~5825MHz Gain = 18.5 > 6dBi, so the limit shall be reduced to 30-(18.5-6) = 17.5dBm.

For U-NII-2A, U-NII-2C

Chain 0

1. 11dBm + 10log (86.25) = 30.36 dBm > 24 dBm
2. 11dBm + 10log (88.93) = 30.49 dBm > 24 dBm
3. 11dBm + 10log (86.22) = 30.36 dBm > 24 dBm
4. 11dBm + 10log (5725.00 - 5646.60) = 29.94 dBm > 24 dBm

Chain 1

1. 11dBm + 10log (86.33) = 30.36 dBm > 24 dBm
2. 11dBm + 10log (86.69) = 30.38 dBm > 24 dBm
3. 11dBm + 10log (86.88) = 30.39 dBm > 24 dBm
4. 11dBm + 10log (5725.00 - 5647.42) = 29.90 dBm > 24 dBm

Chain 2

1. 11dBm + 10log (86.16) = 30.35 dBm > 24 dBm
2. 11dBm + 10log (86.49) = 30.37 dBm > 24 dBm
3. 11dBm + 10log (86.30) = 30.36 dBm > 24 dBm
4. 11dBm + 10log (5725.00 - 5647.44) = 29.90 dBm > 24 dBm

Chain 3

1. 11dBm + 10log (86.80) = 30.39 dBm > 24 dBm
2. 11dBm + 10log (86.82) = 30.39 dBm > 24 dBm
3. 11dBm + 10log (86.44) = 30.37 dBm > 24 dBm
4. 11dBm + 10log (5725.00 - 5645.46) = 30.01 dBm > 24 dBm

Beamforming Mode

802.11n (HT20)

| Chan. | Freq. (MHz) | Maximum Conducted Power (dBm) | | | | Total Power (mW) | Total Power (dBm) | Power Limit (dBm) | Pass / Fail |
|-------|----------------------|-------------------------------|---------|---------|---------|------------------|-------------------|-------------------|-------------|
| | | Chain 0 | Chain 1 | Chain 2 | Chain 3 | | | | |
| 52 | 5260 | -4.83 | -5.04 | -4.63 | -5.01 | 1.302 | 1.15 | 5.57 | Pass |
| 60 | 5300 | -4.99 | -4.94 | -4.55 | -4.70 | 1.327 | 1.23 | 5.57 | Pass |
| 64 | 5320 | -4.98 | -4.77 | -4.64 | -4.69 | 1.334 | 1.25 | 5.57 | Pass |
| 100 | 5500 | -4.81 | -4.56 | -4.67 | -4.85 | 1.349 | 1.30 | 5.57 | Pass |
| 116 | 5580 | -4.74 | -4.63 | -4.76 | -4.84 | 1.342 | 1.28 | 5.57 | Pass |
| 140 | 5700 | -5.15 | -5.20 | -4.48 | -4.79 | 1.296 | 1.12 | 5.57 | Pass |
| 144 | 5720 For U-NII-2C | -6.77 | -6.55 | -6.34 | -6.37 | 0.895 | -0.48 | 5.57 | Pass |
| 144 | 5720 For U-NII-3 | -11.91 | -13.33 | -11.77 | -12.40 | 0.235 | -6.29 | 12.73 | Pass |

Note:

- 5260~5320MHz, 5500~5720MHz Directional Gain = $18.5 + 10\log(3) = 23.27\text{dBi} > 6\text{dBi}$, so the limit shall be reduced to $22.84 - (23.27 - 6) = 5.57\text{dBm}$.
- 5745~5825MHz Directional Gain = $18.5 + 10\log(3) = 23.27\text{dBi} > 6\text{dBi}$, so the limit shall be reduced to $30 - (23.27 - 6) = 12.73\text{dBm}$.

For U-NII-2A, U-NII-2C

Chain 0

- $11\text{dBm} + 10\log(20.75) = 24.17\text{ dBm} > 24\text{ dBm}$
- $11\text{dBm} + 10\log(20.64) = 24.15\text{ dBm} > 24\text{ dBm}$
- $11\text{dBm} + 10\log(20.69) = 24.16\text{ dBm} > 24\text{ dBm}$
- $11\text{dBm} + 10\log(20.54) = 24.13\text{ dBm} > 24\text{ dBm}$
- $11\text{dBm} + 10\log(20.56) = 24.13\text{ dBm} > 24\text{ dBm}$
- $11\text{dBm} + 10\log(20.92) = 24.21\text{ dBm} > 24\text{ dBm}$
- $11\text{dBm} + 10\log(5725.00 - 5709.71) = 22.84\text{ dBm} < 24\text{ dBm}$

Chain 1

- $11\text{dBm} + 10\log(20.77) = 24.17\text{ dBm} > 24\text{ dBm}$
- $11\text{dBm} + 10\log(20.73) = 24.17\text{ dBm} > 24\text{ dBm}$
- $11\text{dBm} + 10\log(20.84) = 24.19\text{ dBm} > 24\text{ dBm}$
- $11\text{dBm} + 10\log(20.89) = 24.20\text{ dBm} > 24\text{ dBm}$
- $11\text{dBm} + 10\log(20.73) = 24.17\text{ dBm} > 24\text{ dBm}$
- $11\text{dBm} + 10\log(20.73) = 24.17\text{ dBm} > 24\text{ dBm}$
- $11\text{dBm} + 10\log(5725.00 - 5709.58) = 22.88\text{ dBm} < 24\text{ dBm}$

Chain 2

- $11\text{dBm} + 10\log(20.77) = 24.17\text{ dBm} > 24\text{ dBm}$
- $11\text{dBm} + 10\log(20.83) = 24.19\text{ dBm} > 24\text{ dBm}$
- $11\text{dBm} + 10\log(21.00) = 24.22\text{ dBm} > 24\text{ dBm}$
- $11\text{dBm} + 10\log(20.95) = 24.21\text{ dBm} > 24\text{ dBm}$
- $11\text{dBm} + 10\log(20.67) = 24.15\text{ dBm} > 24\text{ dBm}$
- $11\text{dBm} + 10\log(20.66) = 24.15\text{ dBm} > 24\text{ dBm}$
- $11\text{dBm} + 10\log(5725.00 - 5709.61) = 22.87\text{ dBm} < 24\text{ dBm}$

Chain 3

- $11\text{dBm} + 10\log(20.61) = 24.14\text{ dBm} > 24\text{ dBm}$
- $11\text{dBm} + 10\log(20.52) = 24.12\text{ dBm} > 24\text{ dBm}$
- $11\text{dBm} + 10\log(20.65) = 24.15\text{ dBm} > 24\text{ dBm}$
- $11\text{dBm} + 10\log(20.62) = 24.14\text{ dBm} > 24\text{ dBm}$
- $11\text{dBm} + 10\log(20.68) = 24.16\text{ dBm} > 24\text{ dBm}$
- $11\text{dBm} + 10\log(20.75) = 24.17\text{ dBm} > 24\text{ dBm}$
- $11\text{dBm} + 10\log(5725.00 - 5709.55) = 22.89\text{ dBm} < 24\text{ dBm}$

802.11n (HT40)

| Chan. | Freq. (MHz) | Maximum Conducted Power (dBm) | | | | Total Power (mW) | Total Power (dBm) | Power Limit (dBm) | Pass / Fail |
|-------|----------------------|-------------------------------|---------|---------|---------|------------------|-------------------|-------------------|-------------|
| | | Chain 0 | Chain 1 | Chain 2 | Chain 3 | | | | |
| 54 | 5270 | -3.53 | -4.02 | -3.43 | -3.81 | 1.710 | 2.33 | 6.73 | Pass |
| 62 | 5310 | -4.08 | -4.19 | -3.80 | -4.06 | 1.581 | 1.99 | 6.73 | Pass |
| 102 | 5510 | -3.77 | -4.66 | -3.79 | -3.91 | 1.586 | 2.00 | 6.73 | Pass |
| 110 | 5550 | -3.67 | -4.76 | -3.76 | -4.03 | 1.580 | 1.99 | 6.73 | Pass |
| 134 | 5670 | -3.53 | -4.41 | -2.91 | -3.83 | 1.731 | 2.38 | 6.73 | Pass |
| 142 | 5710 For U-NII-2C | -4.72 | -4.83 | -4.25 | -4.79 | 1.374 | 1.38 | 6.73 | Pass |
| 142 | 5710 For U-NII-3 | -12.79 | -12.89 | -12.24 | -13.01 | 0.214 | -6.70 | 12.73 | Pass |

Note:

- 5260~5320MHz, 5500~5720MHz Directional Gain = $18.5 + 10\log(3) = 23.27\text{dBi} > 6\text{dBi}$, so the limit shall be reduced to $24 - (23.27 - 6) = 6.73\text{dBm}$.
- 5745~5825MHz Directional Gain = $18.5 + 10\log(3) = 23.27\text{dBi} > 6\text{dBi}$, so the limit shall be reduced to $30 - (23.27 - 6) = 12.73\text{dBm}$.

For U-NII-2A, U-NII-2C

Chain 0

- $11\text{dBm} + 10\log (40.83) = 27.11 \text{ dBm} > 24 \text{ dBm}$
- $11\text{dBm} + 10\log (41.00) = 27.13 \text{ dBm} > 24 \text{ dBm}$
- $11\text{dBm} + 10\log (40.98) = 27.13 \text{ dBm} > 24 \text{ dBm}$
- $11\text{dBm} + 10\log (40.93) = 27.12 \text{ dBm} > 24 \text{ dBm}$
- $11\text{dBm} + 10\log (40.87) = 27.11 \text{ dBm} > 24 \text{ dBm}$
- $11\text{dBm} + 10\log (5725.00 - 5689.64) = 26.49 \text{ dBm} > 24 \text{ dBm}$

Chain 1

- $11\text{dBm} + 10\log (41.01) = 27.13 \text{ dBm} > 24 \text{ dBm}$
- $11\text{dBm} + 10\log (41.12) = 27.14 \text{ dBm} > 24 \text{ dBm}$
- $11\text{dBm} + 10\log (40.96) = 27.12 \text{ dBm} > 24 \text{ dBm}$
- $11\text{dBm} + 10\log (40.94) = 27.12 \text{ dBm} > 24 \text{ dBm}$
- $11\text{dBm} + 10\log (41.11) = 27.14 \text{ dBm} > 24 \text{ dBm}$
- $11\text{dBm} + 10\log (5725.00 - 5689.63) = 26.49 \text{ dBm} > 24 \text{ dBm}$

Chain 2

- $11\text{dBm} + 10\log (40.68) = 27.09 \text{ dBm} > 24 \text{ dBm}$
- $11\text{dBm} + 10\log (40.88) = 27.12 \text{ dBm} > 24 \text{ dBm}$
- $11\text{dBm} + 10\log (40.69) = 27.09 \text{ dBm} > 24 \text{ dBm}$
- $11\text{dBm} + 10\log (40.66) = 27.09 \text{ dBm} > 24 \text{ dBm}$
- $11\text{dBm} + 10\log (40.66) = 27.09 \text{ dBm} > 24 \text{ dBm}$
- $11\text{dBm} + 10\log (5725.00 - 5689.72) = 26.48 \text{ dBm} > 24 \text{ dBm}$

Chain 3

- $11\text{dBm} + 10\log (40.93) = 27.12 \text{ dBm} > 24 \text{ dBm}$
- $11\text{dBm} + 10\log (40.79) = 27.11 \text{ dBm} > 24 \text{ dBm}$
- $11\text{dBm} + 10\log (40.75) = 27.10 \text{ dBm} > 24 \text{ dBm}$
- $11\text{dBm} + 10\log (40.55) = 27.08 \text{ dBm} > 24 \text{ dBm}$
- $11\text{dBm} + 10\log (40.53) = 27.08 \text{ dBm} > 24 \text{ dBm}$
- $11\text{dBm} + 10\log (5725.00 - 5689.79) = 26.47 \text{ dBm} > 24 \text{ dBm}$

802.11ac (VHT80)

| Chan. | Freq. (MHz) | Maximum Conducted Power (dBm) | | | | Total Power (mW) | Total Power (dBm) | Power Limit (dBm) | Pass / Fail |
|-------|----------------------|-------------------------------|---------|---------|---------|------------------|-------------------|-------------------|-------------|
| | | Chain 0 | Chain 1 | Chain 2 | Chain 3 | | | | |
| 58 | 5290 | -3.71 | -3.90 | -3.50 | -3.79 | 1.697 | 2.30 | 6.73 | Pass |
| 106 | 5530 | -3.78 | -4.50 | -3.63 | -3.76 | 1.628 | 2.12 | 6.73 | Pass |
| 122 | 5610 | -3.66 | -4.40 | -3.78 | -3.89 | 1.620 | 2.10 | 6.73 | Pass |
| 138 | 5690 For U-NII-2C | -4.54 | -4.85 | -3.74 | -4.25 | 1.477 | 1.69 | 6.73 | Pass |
| 138 | 5690 For U-NII-3 | -14.17 | -14.26 | -13.60 | -14.20 | 0.157 | -8.03 | 12.73 | Pass |

Note:

- 5260~5320MHz, 5500~5720MHz Directional Gain = $18.5 + 10\log(3) = 23.27\text{dBi} > 6\text{dBi}$, so the limit shall be reduced to $24 - (23.27 - 6) = 6.73\text{dBm}$.
- 5745~5825MHz Directional Gain = $18.5 + 10\log(3) = 23.27\text{dBi} > 6\text{dBi}$, so the limit shall be reduced to $30 - (23.27 - 6) = 12.73\text{dBm}$.

For U-NII-2A, U-NII-2C

Chain 0

- $11\text{dBm} + 10\log(86.25) = 30.36\text{ dBm} > 24\text{ dBm}$
- $11\text{dBm} + 10\log(88.93) = 30.49\text{ dBm} > 24\text{ dBm}$
- $11\text{dBm} + 10\log(86.22) = 30.36\text{ dBm} > 24\text{ dBm}$
- $11\text{dBm} + 10\log(5725.00 - 5646.60) = 29.94\text{ dBm} > 24\text{ dBm}$

Chain 1

- $11\text{dBm} + 10\log(86.33) = 30.36\text{ dBm} > 24\text{ dBm}$
- $11\text{dBm} + 10\log(86.69) = 30.38\text{ dBm} > 24\text{ dBm}$
- $11\text{dBm} + 10\log(86.88) = 30.39\text{ dBm} > 24\text{ dBm}$
- $11\text{dBm} + 10\log(5725.00 - 5647.42) = 29.90\text{ dBm} > 24\text{ dBm}$

Chain 2

- $11\text{dBm} + 10\log(86.16) = 30.35\text{ dBm} > 24\text{ dBm}$
- $11\text{dBm} + 10\log(86.49) = 30.37\text{ dBm} > 24\text{ dBm}$
- $11\text{dBm} + 10\log(86.30) = 30.36\text{ dBm} > 24\text{ dBm}$
- $11\text{dBm} + 10\log(5725.00 - 5647.44) = 29.90\text{ dBm} > 24\text{ dBm}$

Chain 3

- $11\text{dBm} + 10\log(86.80) = 30.39\text{ dBm} > 24\text{ dBm}$
- $11\text{dBm} + 10\log(86.82) = 30.39\text{ dBm} > 24\text{ dBm}$
- $11\text{dBm} + 10\log(86.44) = 30.37\text{ dBm} > 24\text{ dBm}$
- $11\text{dBm} + 10\log(5725.00 - 5645.46) = 30.01\text{ dBm} > 24\text{ dBm}$

26dB Bandwidth:

Mode A1

802.11a

| Chan. | Freq. (MHz) | 26dBc Bandwidth (MHz) | | | |
|-------|----------------------|-----------------------|---------|---------|---------|
| | | Chain 0 | Chain 1 | Chain 2 | Chain 3 |
| 52 | 5260 | 19.99 | 19.89 | 20.21 | 19.61 |
| 60 | 5300 | 20.13 | 19.87 | 20.31 | 19.67 |
| 64 | 5320 | 20.10 | 19.89 | 19.92 | 19.97 |
| 100 | 5500 | 20.03 | 19.70 | 20.19 | 19.59 |
| 116 | 5580 | 20.27 | 19.87 | 20.14 | 19.58 |
| 140 | 5700 | 19.95 | 19.54 | 20.09 | 20.07 |
| 144 | 5720 For U-NII-2C | 15.13 | 14.98 | 15.10 | 14.83 |
| 144 | 5720 For U-NII-3 | 4.78 | 4.81 | 4.90 | 4.94 |

802.11n (HT20)

| Chan. | Freq. (MHz) | 26dBc Bandwidth (MHz) | | | |
|-------|----------------------|-----------------------|---------|---------|---------|
| | | Chain 0 | Chain 1 | Chain 2 | Chain 3 |
| 52 | 5260 | 20.72 | 20.79 | 20.69 | 20.43 |
| 60 | 5300 | 20.85 | 20.74 | 20.53 | 20.51 |
| 64 | 5320 | 20.98 | 20.82 | 21.01 | 20.60 |
| 100 | 5500 | 20.83 | 20.62 | 21.15 | 20.59 |
| 116 | 5580 | 20.69 | 20.95 | 20.72 | 20.64 |
| 140 | 5700 | 20.68 | 20.84 | 20.67 | 20.89 |
| 144 | 5720 For U-NII-2C | 15.46 | 15.43 | 15.26 | 15.35 |
| 144 | 5720 For U-NII-3 | 5.38 | 5.27 | 5.25 | 5.42 |

802.11n (HT40)

| Chan. | Freq. (MHz) | 26dBc Bandwidth (MHz) | | | |
|-------|----------------------|-----------------------|---------|---------|---------|
| | | Chain 0 | Chain 1 | Chain 2 | Chain 3 |
| 54 | 5270 | 41.05 | 40.85 | 40.49 | 40.79 |
| 62 | 5310 | 40.99 | 40.80 | 40.45 | 40.59 |
| 102 | 5510 | 40.86 | 40.49 | 40.38 | 40.46 |
| 110 | 5550 | 40.77 | 40.67 | 40.45 | 40.34 |
| 134 | 5670 | 40.69 | 40.81 | 40.59 | 40.48 |
| 142 | 5710 For U-NII-2C | 35.47 | 35.34 | 35.38 | 35.21 |
| 142 | 5710 For U-NII-3 | 5.36 | 5.23 | 5.20 | 5.26 |

802.11ac (VHT80)

| Chan. | Freq. (MHz) | 26dBc Bandwidth (MHz) | | | |
|-------|----------------------|-----------------------|---------|---------|---------|
| | | Chain 0 | Chain 1 | Chain 2 | Chain 3 |
| 58 | 5290 | 85.82 | 85.25 | 84.89 | 85.28 |
| 106 | 5530 | 86.29 | 85.80 | 85.43 | 85.19 |
| 122 | 5610 | 85.69 | 85.78 | 85.11 | 84.94 |
| 138 | 5690 For U-NII-2C | 77.47 | 77.77 | 77.06 | 77.46 |
| 138 | 5690 For U-NII-3 | 8.01 | 7.27 | 7.41 | 7.39 |

Spectrum Plot of Worst Value

802.11a

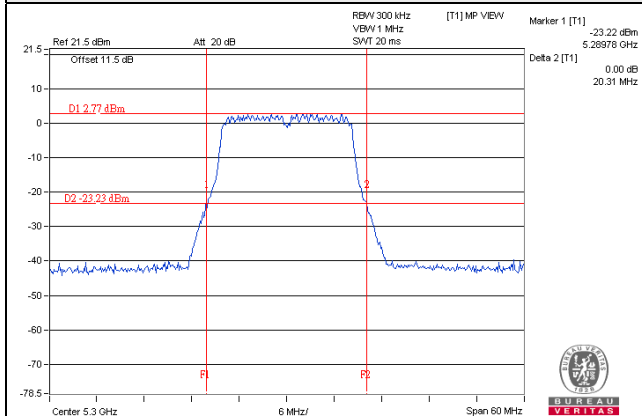

802.11n (HT20)

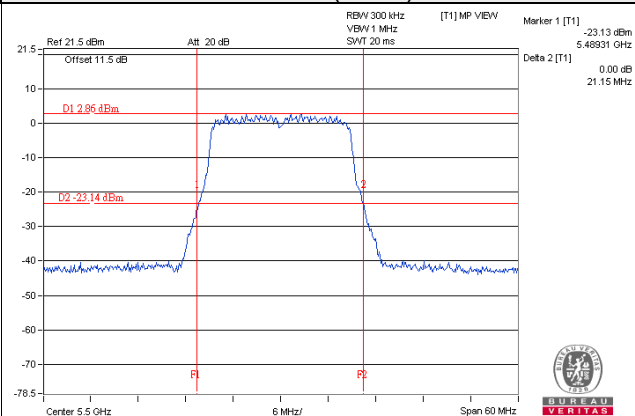

802.11n (HT40)

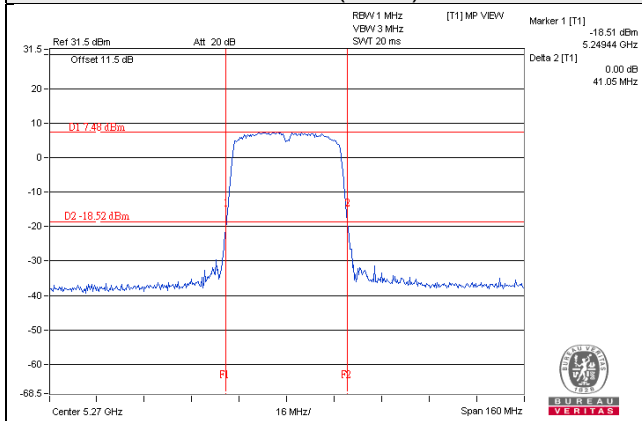

802.11ac (VHT80)

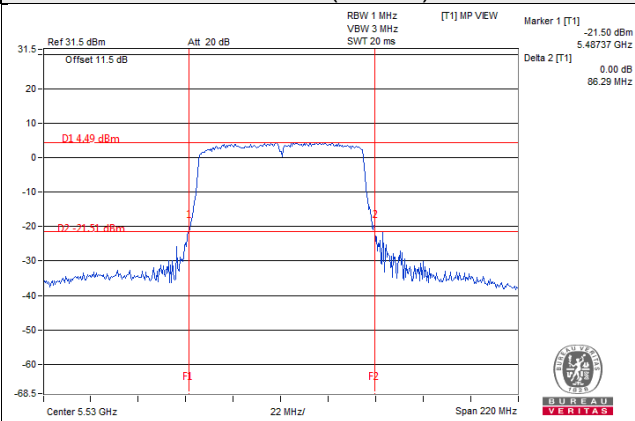

Mode A2

802.11a

| Chan. | Freq. (MHz) | 26dBc Bandwidth (MHz) | | | |
|-------|----------------------|-----------------------|---------|---------|---------|
| | | Chain 0 | Chain 1 | Chain 2 | Chain 3 |
| 52 | 5260 | 19.98 | 20.13 | 19.84 | 19.86 |
| 60 | 5300 | 20.08 | 19.87 | 20.15 | 19.99 |
| 64 | 5320 | 20.18 | 20.20 | 20.18 | 19.69 |
| 100 | 5500 | 20.14 | 20.36 | 20.23 | 19.75 |
| 116 | 5580 | 19.82 | 20.24 | 19.89 | 19.93 |
| 140 | 5700 | 20.23 | 20.15 | 19.85 | 19.79 |
| 144 | 5720 For U-NII-2C | 14.98 | 15.19 | 14.80 | 14.86 |
| 144 | 5720 For U-NII-3 | 5.06 | 5.01 | 4.87 | 4.96 |

802.11n (HT20)

| Chan. | Freq. (MHz) | 26dBc Bandwidth (MHz) | | | |
|-------|----------------------|-----------------------|---------|---------|---------|
| | | Chain 0 | Chain 1 | Chain 2 | Chain 3 |
| 52 | 5260 | 20.87 | 20.67 | 20.71 | 20.40 |
| 60 | 5300 | 20.97 | 20.78 | 20.86 | 20.56 |
| 64 | 5320 | 21.16 | 20.86 | 20.82 | 20.81 |
| 100 | 5500 | 20.83 | 21.12 | 20.76 | 20.48 |
| 116 | 5580 | 20.84 | 21.10 | 20.70 | 20.71 |
| 140 | 5700 | 21.02 | 21.04 | 20.75 | 20.77 |
| 144 | 5720 For U-NII-2C | 15.46 | 15.43 | 15.32 | 15.29 |
| 144 | 5720 For U-NII-3 | 5.61 | 5.35 | 5.44 | 5.50 |

802.11n (HT40)

| Chan. | Freq. (MHz) | 26dBc Bandwidth (MHz) | | | |
|-------|----------------------|-----------------------|---------|---------|---------|
| | | Chain 0 | Chain 1 | Chain 2 | Chain 3 |
| 54 | 5270 | 41.27 | 41.00 | 40.54 | 40.68 |
| 62 | 5310 | 40.93 | 41.17 | 40.77 | 40.60 |
| 102 | 5510 | 41.02 | 40.82 | 40.43 | 40.60 |
| 110 | 5550 | 40.88 | 40.88 | 40.76 | 40.61 |
| 134 | 5670 | 41.11 | 41.05 | 40.57 | 40.70 |
| 142 | 5710 For U-NII-2C | 35.40 | 35.19 | 35.27 | 35.20 |
| 142 | 5710 For U-NII-3 | 5.70 | 5.35 | 5.45 | 5.31 |

802.11ac (VHT80)

| Chan. | Freq. (MHz) | 26dBc Bandwidth (MHz) | | | |
|-------|----------------------|-----------------------|---------|---------|---------|
| | | Chain 0 | Chain 1 | Chain 2 | Chain 3 |
| 58 | 5290 | 86.01 | 85.98 | 85.13 | 85.28 |
| 106 | 5530 | 86.71 | 85.69 | 86.36 | 85.16 |
| 122 | 5610 | 86.95 | 85.54 | 85.20 | 84.52 |
| 138 | 5690 For U-NII-2C | 83.86 | 77.65 | 77.41 | 77.33 |
| 138 | 5690 For U-NII-3 | 8.45 | 8.35 | 7.97 | 7.72 |

Spectrum Plot of Worst Value

802.11a

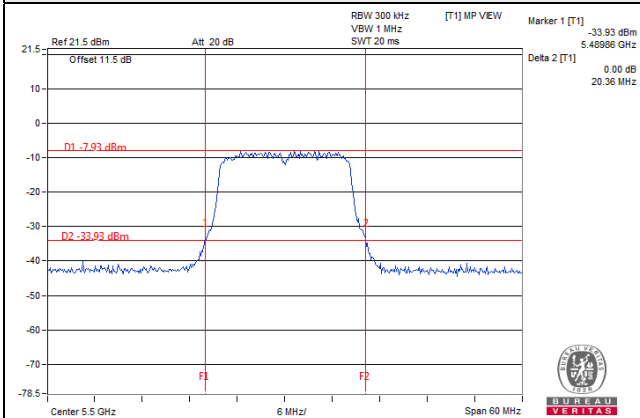

802.11n (HT20)

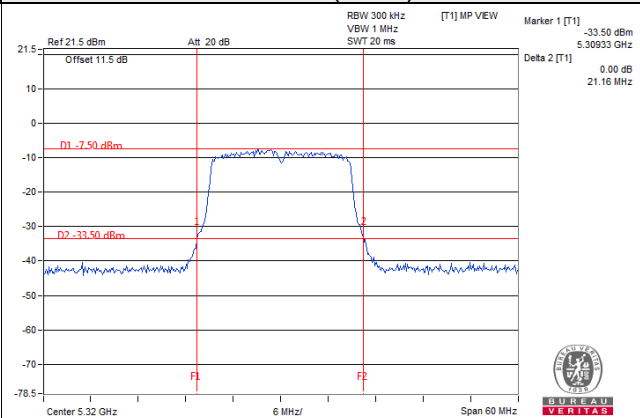

802.11n (HT40)

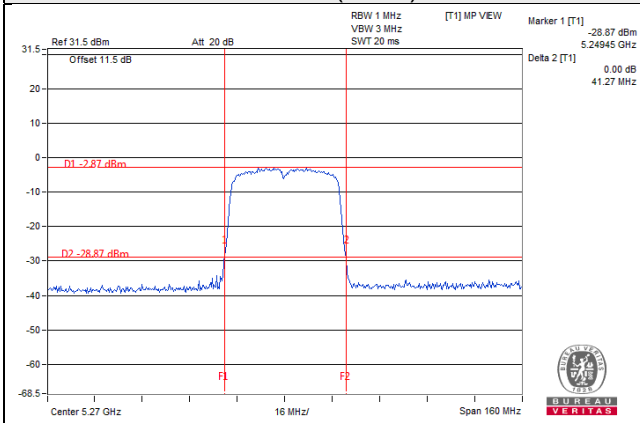

802.11ac (VHT80)

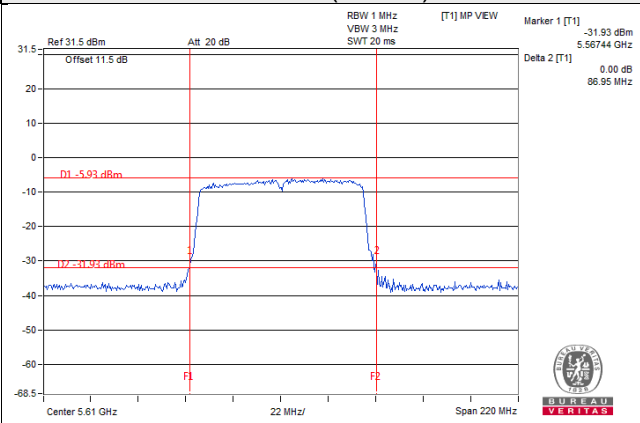

Mode B1

802.11a

| Chan. | Freq. (MHz) | 26dBc Bandwidth (MHz) | | | |
|-------|----------------------|-----------------------|---------|---------|---------|
| | | Chain 0 | Chain 1 | Chain 2 | Chain 3 |
| 52 | 5260 | 20.19 | 20.12 | 19.92 | 19.69 |
| 60 | 5300 | 19.96 | 20.09 | 20.03 | 19.44 |
| 64 | 5320 | 20.25 | 19.90 | 20.09 | 19.53 |
| 100 | 5500 | 20.02 | 19.62 | 19.92 | 19.73 |
| 116 | 5580 | 20.12 | 19.98 | 19.66 | 19.89 |
| 140 | 5700 | 20.04 | 19.86 | 19.89 | 19.91 |
| 144 | 5720 For U-NII-2C | 15.04 | 15.11 | 15.02 | 15.01 |
| 144 | 5720 For U-NII-3 | 5.05 | 5.13 | 4.71 | 5.04 |

802.11n (HT20)

| Chan. | Freq. (MHz) | 26dBc Bandwidth (MHz) | | | |
|-------|----------------------|-----------------------|---------|---------|---------|
| | | Chain 0 | Chain 1 | Chain 2 | Chain 3 |
| 52 | 5260 | 20.80 | 20.54 | 20.77 | 20.65 |
| 60 | 5300 | 20.85 | 20.54 | 21.01 | 20.51 |
| 64 | 5320 | 20.96 | 20.66 | 21.06 | 20.69 |
| 100 | 5500 | 21.06 | 20.83 | 20.85 | 21.02 |
| 116 | 5580 | 21.18 | 21.01 | 20.57 | 20.82 |
| 140 | 5700 | 20.62 | 21.05 | 20.61 | 20.84 |
| 144 | 5720 For U-NII-2C | 15.37 | 15.47 | 15.34 | 15.57 |
| 144 | 5720 For U-NII-3 | 5.51 | 5.40 | 5.29 | 5.41 |

802.11n (HT40)

| Chan. | Freq. (MHz) | 26dBc Bandwidth (MHz) | | | |
|-------|----------------------|-----------------------|---------|---------|---------|
| | | Chain 0 | Chain 1 | Chain 2 | Chain 3 |
| 54 | 5270 | 40.56 | 40.71 | 40.59 | 40.45 |
| 62 | 5310 | 40.81 | 40.64 | 40.70 | 40.60 |
| 102 | 5510 | 40.85 | 40.67 | 40.55 | 40.61 |
| 110 | 5550 | 40.76 | 40.96 | 40.62 | 40.37 |
| 134 | 5670 | 40.81 | 40.70 | 40.52 | 40.36 |
| 142 | 5710 For U-NII-2C | 35.37 | 35.46 | 35.16 | 35.41 |
| 142 | 5710 For U-NII-3 | 5.27 | 5.34 | 5.41 | 5.22 |

802.11ac (VHT80)

| Chan. | Freq. (MHz) | 26dBc Bandwidth (MHz) | | | |
|-------|----------------------|-----------------------|---------|---------|---------|
| | | Chain 0 | Chain 1 | Chain 2 | Chain 3 |
| 58 | 5290 | 86.08 | 86.42 | 84.38 | 84.86 |
| 106 | 5530 | 85.76 | 86.02 | 84.53 | 84.03 |
| 122 | 5610 | 85.49 | 85.28 | 98.61 | 87.08 |
| 138 | 5690 For U-NII-2C | 77.86 | 77.38 | 77.73 | 78.14 |
| 138 | 5690 For U-NII-3 | 9.47 | 7.97 | 7.37 | 7.17 |

Spectrum Plot of Worst Value

802.11a

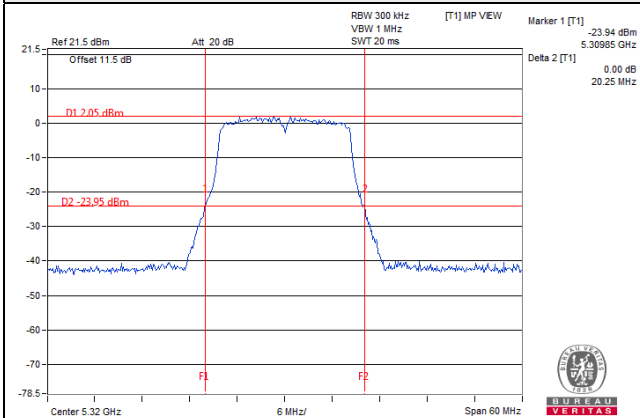

802.11n (HT20)

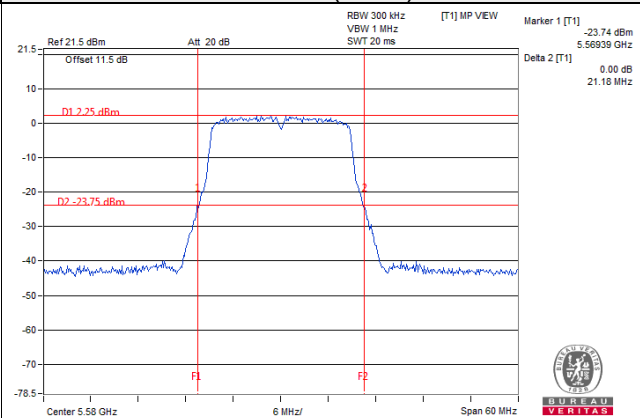

802.11n (HT40)

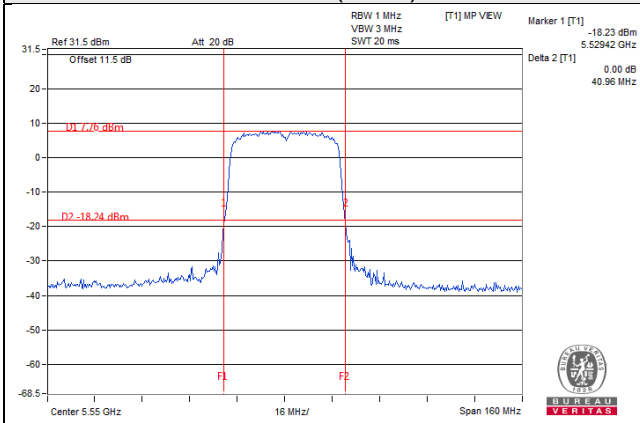

802.11ac (VHT80)

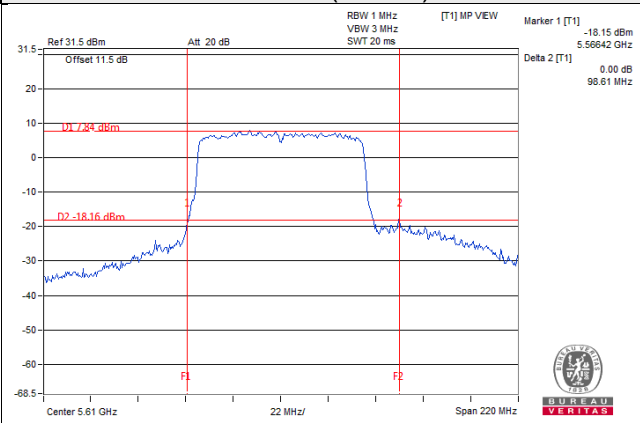

Mode B2

802.11a

| Chan. | Freq. (MHz) | 26dBc Bandwidth (MHz) | | | |
|-------|----------------------|-----------------------|---------|---------|---------|
| | | Chain 0 | Chain 1 | Chain 2 | Chain 3 |
| 52 | 5260 | 20.31 | 19.95 | 20.30 | 20.01 |
| 60 | 5300 | 20.41 | 20.29 | 20.45 | 20.12 |
| 64 | 5320 | 20.22 | 20.18 | 19.73 | 19.89 |
| 100 | 5500 | 20.30 | 20.30 | 19.93 | 20.07 |
| 116 | 5580 | 19.95 | 20.32 | 19.67 | 20.12 |
| 140 | 5700 | 20.22 | 20.44 | 19.77 | 20.33 |
| 144 | 5720 For U-NII-2C | 15.19 | 15.22 | 15.21 | 15.16 |
| 144 | 5720 For U-NII-3 | 5.20 | 4.79 | 5.20 | 5.06 |

802.11n (HT20)

| Chan. | Freq. (MHz) | 26dBc Bandwidth (MHz) | | | |
|-------|----------------------|-----------------------|---------|---------|---------|
| | | Chain 0 | Chain 1 | Chain 2 | Chain 3 |
| 52 | 5260 | 20.75 | 20.77 | 20.77 | 20.61 |
| 60 | 5300 | 20.64 | 20.73 | 20.83 | 20.52 |
| 64 | 5320 | 20.69 | 20.84 | 21.00 | 20.65 |
| 100 | 5500 | 20.54 | 20.89 | 20.95 | 20.62 |
| 116 | 5580 | 20.56 | 20.73 | 20.67 | 20.68 |
| 140 | 5700 | 20.92 | 20.73 | 20.66 | 20.75 |
| 144 | 5720 For U-NII-2C | 15.29 | 15.42 | 15.39 | 15.45 |
| 144 | 5720 For U-NII-3 | 5.42 | 5.37 | 5.38 | 5.33 |

802.11n (HT40)

| Chan. | Freq. (MHz) | 26dBc Bandwidth (MHz) | | | |
|-------|----------------------|-----------------------|---------|---------|---------|
| | | Chain 0 | Chain 1 | Chain 2 | Chain 3 |
| 54 | 5270 | 40.83 | 41.01 | 40.68 | 40.93 |
| 62 | 5310 | 41.00 | 41.12 | 40.88 | 40.79 |
| 102 | 5510 | 40.98 | 40.96 | 40.69 | 40.75 |
| 110 | 5550 | 40.93 | 40.94 | 40.66 | 40.55 |
| 134 | 5670 | 40.87 | 41.11 | 40.66 | 40.53 |
| 142 | 5710 For U-NII-2C | 35.36 | 35.37 | 35.28 | 35.21 |
| 142 | 5710 For U-NII-3 | 5.51 | 5.53 | 5.41 | 5.30 |

802.11ac (VHT80)

| Chan. | Freq. (MHz) | 26dBc Bandwidth (MHz) | | | |
|-------|----------------------|-----------------------|---------|---------|---------|
| | | Chain 0 | Chain 1 | Chain 2 | Chain 3 |
| 58 | 5290 | 86.25 | 86.33 | 86.16 | 86.80 |
| 106 | 5530 | 88.93 | 86.69 | 86.49 | 86.82 |
| 122 | 5610 | 86.22 | 86.88 | 86.30 | 86.44 |
| 138 | 5690 For U-NII-2C | 78.40 | 77.58 | 77.56 | 79.54 |
| 138 | 5690 For U-NII-3 | 8.53 | 8.88 | 8.00 | 8.41 |

Spectrum Plot of Worst Value

802.11a

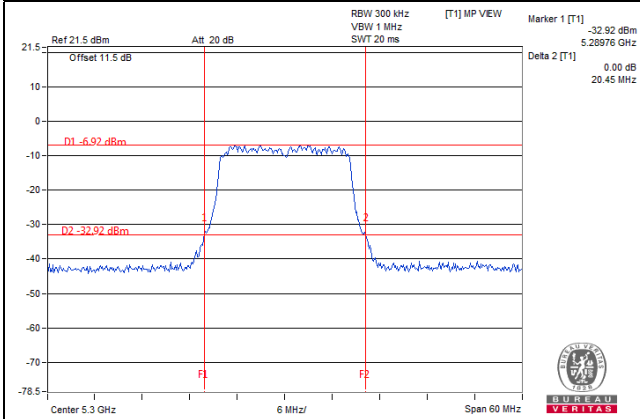

802.11n (HT20)

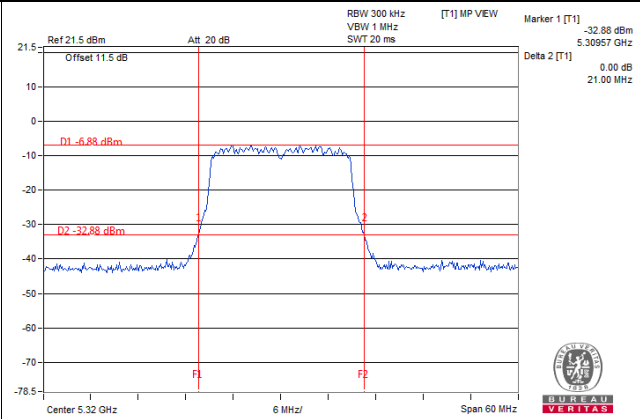

802.11n (HT40)

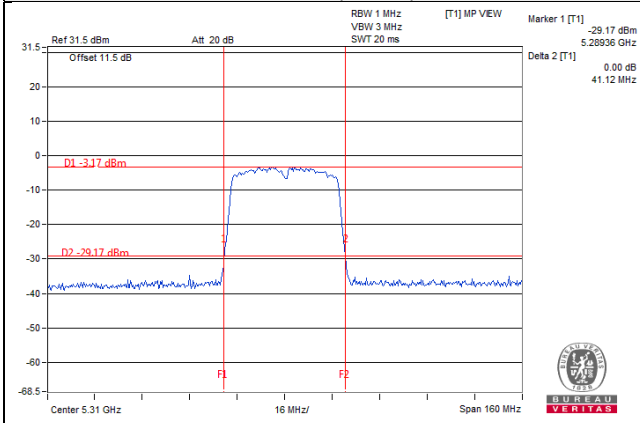

802.11ac (VHT80)

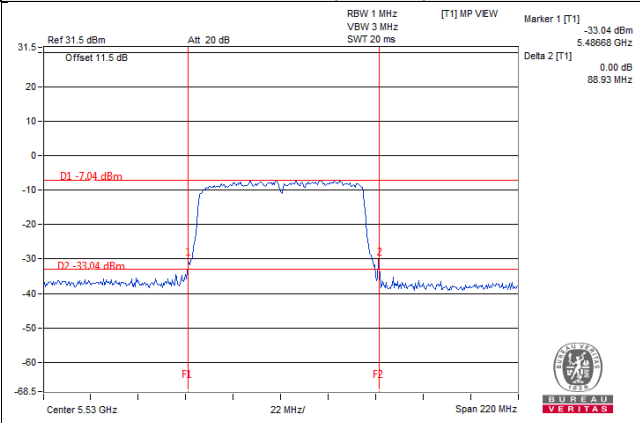

EUT Maximum Conducted Power

Mode A1

CDD Mode

802.11a

| Frequency Band (MHz) | Max. Power | |
|----------------------|-------------------|--------------------|
| | Output Power (mW) | Output Power (dBm) |
| 5250~5350 | 52.010 | 17.16 |
| 5470~5725 | 53.827 | 17.31 |

802.11n (HT20)

| Frequency Band (MHz) | Max. Power | |
|----------------------|-------------------|--------------------|
| | Output Power (mW) | Output Power (dBm) |
| 5250~5350 | 57.817 | 17.62 |
| 5470~5725 | 55.539 | 17.45 |

802.11n (HT40)

| Frequency Band (MHz) | Max. Power | |
|----------------------|-------------------|--------------------|
| | Output Power (mW) | Output Power (dBm) |
| 5250~5350 | 90.387 | 19.56 |
| 5470~5725 | 94.757 | 19.77 |

802.11ac (VHT80)

| Frequency Band (MHz) | Max. Power | |
|----------------------|-------------------|--------------------|
| | Output Power (mW) | Output Power (dBm) |
| 5250~5350 | 42.249 | 16.26 |
| 5470~5725 | 136.723 | 21.36 |

Beamforming Mode

802.11n (HT20)

| Frequency Band (MHz) | Max. Power | |
|----------------------|-------------------|--------------------|
| | Output Power (mW) | Output Power (dBm) |
| 5250~5350 | 14.454 | 11.60 |
| 5470~5725 | 13.885 | 11.43 |

802.11n (HT40)

| Frequency Band (MHz) | Max. Power | |
|----------------------|-------------------|--------------------|
| | Output Power (mW) | Output Power (dBm) |
| 5250~5350 | 22.597 | 13.54 |
| 5470~5725 | 23.689 | 13.75 |

802.11ac (VHT80)

| Frequency Band (MHz) | Max. Power | |
|----------------------|-------------------|--------------------|
| | Output Power (mW) | Output Power (dBm) |
| 5250~5350 | 10.562 | 10.24 |
| 5470~5725 | 34.181 | 15.34 |

Mode A2

CDD Mode

802.11a

| Frequency Band (MHz) | Max. Power | |
|----------------------|-------------------|--------------------|
| | Output Power (mW) | Output Power (dBm) |
| 5250~5350 | 5.001 | 6.99 |
| 5470~5725 | 4.941 | 6.94 |

802.11n (HT20)

| Frequency Band (MHz) | Max. Power | |
|----------------------|-------------------|--------------------|
| | Output Power (mW) | Output Power (dBm) |
| 5250~5350 | 4.989 | 6.98 |
| 5470~5725 | 4.946 | 6.94 |

802.11n (HT40)

| Frequency Band (MHz) | Max. Power | |
|----------------------|-------------------|--------------------|
| | Output Power (mW) | Output Power (dBm) |
| 5250~5350 | 6.467 | 8.11 |
| 5470~5725 | 6.466 | 8.11 |

802.11ac (VHT80)

| Frequency Band (MHz) | Max. Power | |
|----------------------|-------------------|--------------------|
| | Output Power (mW) | Output Power (dBm) |
| 5250~5350 | 6.895 | 8.39 |
| 5470~5725 | 6.970 | 8.43 |

Beamforming Mode

802.11n (HT20)

| Frequency Band (MHz) | Max. Power | |
|----------------------|-------------------|--------------------|
| | Output Power (mW) | Output Power (dBm) |
| 5250~5350 | 1.247 | 0.96 |
| 5470~5725 | 1.237 | 0.92 |

802.11n (HT40)

| Frequency Band (MHz) | Max. Power | |
|----------------------|-------------------|--------------------|
| | Output Power (mW) | Output Power (dBm) |
| 5250~5350 | 1.617 | 2.09 |
| 5470~5725 | 1.617 | 2.09 |

802.11ac (VHT80)

| Frequency Band (MHz) | Max. Power | |
|----------------------|-------------------|--------------------|
| | Output Power (mW) | Output Power (dBm) |
| 5250~5350 | 1.724 | 2.36 |
| 5470~5725 | 1.743 | 2.41 |

Mode B1

CDD Mode

802.11a

| Frequency Band (MHz) | Max. Power | |
|----------------------|-------------------|--------------------|
| | Output Power (mW) | Output Power (dBm) |
| 5250~5350 | 46.407 | 16.67 |
| 5470~5725 | 50.210 | 17.01 |

802.11n (HT20)

| Frequency Band (MHz) | Max. Power | |
|----------------------|-------------------|--------------------|
| | Output Power (mW) | Output Power (dBm) |
| 5250~5350 | 48.443 | 16.85 |
| 5470~5725 | 63.529 | 18.03 |

802.11n (HT40)

| Frequency Band (MHz) | Max. Power | |
|----------------------|-------------------|--------------------|
| | Output Power (mW) | Output Power (dBm) |
| 5250~5350 | 84.859 | 19.29 |
| 5470~5725 | 89.876 | 19.54 |

802.11ac (VHT80)

| Frequency Band (MHz) | Max. Power | |
|----------------------|-------------------|--------------------|
| | Output Power (mW) | Output Power (dBm) |
| 5250~5350 | 39.918 | 16.01 |
| 5470~5725 | 136.723 | 21.36 |

Beamforming Mode

802.11n (HT20)

| Frequency Band (MHz) | Max. Power | |
|----------------------|-------------------|--------------------|
| | Output Power (mW) | Output Power (dBm) |
| 5250~5350 | 12.111 | 10.83 |
| 5470~5725 | 15.882 | 12.01 |

802.11n (HT40)

| Frequency Band (MHz) | Max. Power | |
|----------------------|-------------------|--------------------|
| | Output Power (mW) | Output Power (dBm) |
| 5250~5350 | 21.215 | 13.27 |
| 5470~5725 | 22.469 | 13.52 |

802.11ac (VHT80)

| Frequency Band (MHz) | Max. Power | |
|----------------------|-------------------|--------------------|
| | Output Power (mW) | Output Power (dBm) |
| 5250~5350 | 9.979 | 9.99 |
| 5470~5725 | 34.181 | 15.34 |

Mode B2

CDD Mode

802.11a

| Frequency Band (MHz) | Max. Power | |
|----------------------|-------------------|--------------------|
| | Output Power (mW) | Output Power (dBm) |
| 5250~5350 | 5.211 | 7.17 |
| 5470~5725 | 5.319 | 7.26 |

802.11n (HT20)

| Frequency Band (MHz) | Max. Power | |
|----------------------|-------------------|--------------------|
| | Output Power (mW) | Output Power (dBm) |
| 5250~5350 | 5.337 | 7.27 |
| 5470~5725 | 5.395 | 7.32 |

802.11n (HT40)

| Frequency Band (MHz) | Max. Power | |
|----------------------|-------------------|--------------------|
| | Output Power (mW) | Output Power (dBm) |
| 5250~5350 | 6.838 | 8.35 |
| 5470~5725 | 6.925 | 8.40 |

802.11ac (VHT80)

| Frequency Band (MHz) | Max. Power | |
|----------------------|-------------------|--------------------|
| | Output Power (mW) | Output Power (dBm) |
| 5250~5350 | 6.788 | 8.32 |
| 5470~5725 | 6.511 | 8.14 |

Beamforming Mode

802.11n (HT20)

| Frequency Band (MHz) | Max. Power | |
|----------------------|-------------------|--------------------|
| | Output Power (mW) | Output Power (dBm) |
| 5250~5350 | 1.334 | 1.25 |
| 5470~5725 | 1.349 | 1.30 |

802.11n (HT40)

| Frequency Band (MHz) | Max. Power | |
|----------------------|-------------------|--------------------|
| | Output Power (mW) | Output Power (dBm) |
| 5250~5350 | 1.710 | 2.33 |
| 5470~5725 | 1.731 | 2.38 |

802.11ac (VHT80)

| Frequency Band (MHz) | Max. Power | |
|----------------------|-------------------|--------------------|
| | Output Power (mW) | Output Power (dBm) |
| 5250~5350 | 1.697 | 2.30 |
| 5470~5725 | 1.628 | 2.12 |

4.4 Occupied Bandwidth Measurement

4.4.1 Test Setup

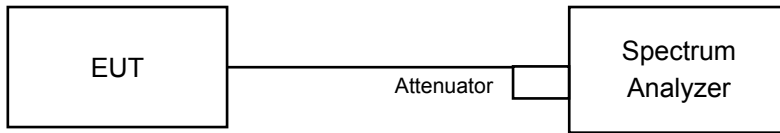

4.4.2 Test Instruments

Refer to section 4.1.2 to get information of above instrument.

4.4.3 Test Procedure

The transmitter output was connected to the spectrum analyzer through an attenuator. The bandwidth of the fundamental frequency was measured by spectrum analyzer with resolution bandwidth in the range of 1% to 5% of the anticipated emission bandwidth, and a video bandwidth at least 3x the resolution bandwidth and set the detector to sampling. The width of a frequency band such that, below the lower and above the upper frequency limits, the mean powers emitted are each equal to a specified percentage 0.5 %of the total mean power of a given emission.

4.4.4 Test Result

Mode A

802.11a

| Chan. | Freq. (MHz) | Occupied Bandwidth (MHz) | | | |
|-------|----------------------|--------------------------|---------|---------|---------|
| | | Chain 0 | Chain 1 | Chain 2 | Chain 3 |
| 52 | 5260 | 16.44 | 16.44 | 16.56 | 16.44 |
| 60 | 5300 | 16.44 | 16.44 | 16.56 | 16.44 |
| 64 | 5320 | 16.44 | 16.44 | 16.56 | 16.44 |
| 100 | 5500 | 16.44 | 16.56 | 16.44 | 16.44 |
| 116 | 5580 | 16.56 | 16.44 | 16.56 | 16.44 |
| 140 | 5700 | 16.44 | 16.56 | 16.44 | 16.56 |
| 144 | 5720 For U-NII-2C | 13.16 | 13.16 | 13.16 | 13.16 |
| 144 | 5720 For U-NII-3 | 3.16 | 3.16 | 3.16 | 3.16 |

802.11n (HT20)

| Chan. | Freq. (MHz) | Occupied Bandwidth (MHz) | | | |
|-------|----------------------|--------------------------|---------|---------|---------|
| | | Chain 0 | Chain 1 | Chain 2 | Chain 3 |
| 52 | 5260 | 17.64 | 17.64 | 17.64 | 17.64 |
| 60 | 5300 | 17.64 | 17.64 | 17.64 | 17.64 |
| 64 | 5320 | 17.64 | 17.64 | 17.64 | 17.64 |
| 100 | 5500 | 17.64 | 17.64 | 17.64 | 17.64 |
| 116 | 5580 | 17.64 | 17.64 | 17.64 | 17.64 |
| 140 | 5700 | 17.64 | 17.64 | 17.64 | 17.64 |
| 144 | 5720 For U-NII-2C | 13.88 | 13.88 | 13.88 | 13.76 |
| 144 | 5720 For U-NII-3 | 3.76 | 3.76 | 3.76 | 3.76 |

802.11n (HT40)

| Chan. | Freq. (MHz) | Occupied Bandwidth (MHz) | | | |
|-------|----------------------|--------------------------|---------|---------|---------|
| | | Chain 0 | Chain 1 | Chain 2 | Chain 3 |
| 54 | 5270 | 36.12 | 36.12 | 36.00 | 36.24 |
| 62 | 5310 | 36.12 | 36.12 | 36.12 | 36.12 |
| 102 | 5510 | 36.12 | 36.00 | 36.12 | 36.00 |
| 110 | 5550 | 36.12 | 36.00 | 36.12 | 36.12 |
| 134 | 5670 | 36.00 | 36.00 | 36.00 | 36.00 |
| 142 | 5710 For U-NII-2C | 33.12 | 33.12 | 33.12 | 33.00 |
| 142 | 5710 For U-NII-3 | 3.00 | 3.00 | 3.00 | 3.00 |

802.11ac (VHT80)

| Chan. | Freq. (MHz) | Occupied Bandwidth (MHz) | | | |
|-------|----------------------|--------------------------|---------|---------|---------|
| | | Chain 0 | Chain 1 | Chain 2 | Chain 3 |
| 58 | 5290 | 75.84 | 75.84 | 75.84 | 76.08 |
| 106 | 5530 | 75.84 | 75.84 | 75.84 | 75.84 |
| 122 | 5610 | 75.84 | 75.84 | 76.32 | 75.84 |
| 138 | 5690 For U-NII-2C | 72.92 | 72.92 | 72.92 | 72.92 |
| 138 | 5690 For U-NII-3 | 2.92 | 2.92 | 2.92 | 2.92 |

Spectrum Plot of Worst Value

802.11a

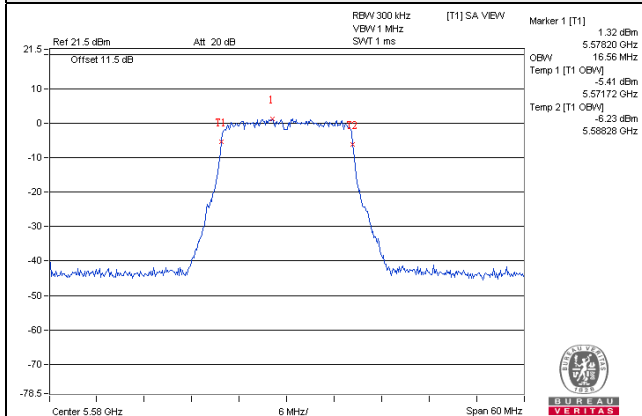

802.11n (HT20)

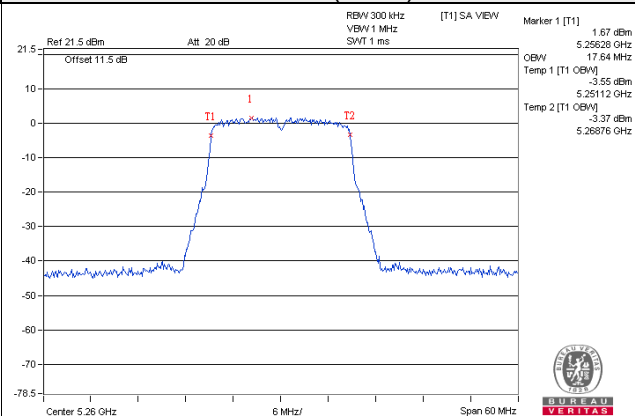

802.11n (HT40)

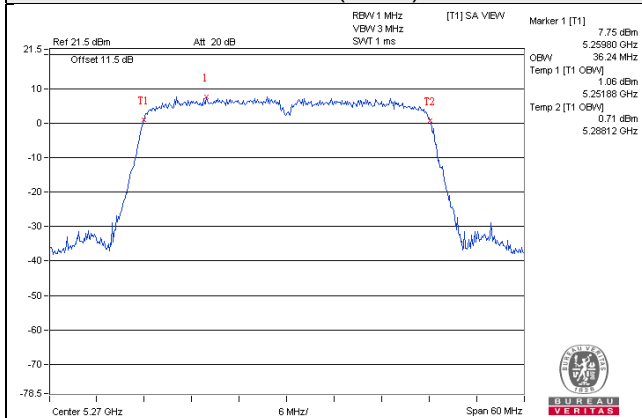

802.11ac (VHT80)

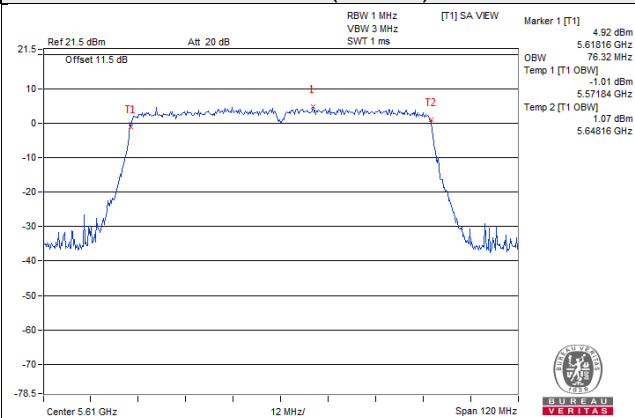

Mode A2

802.11a

| Chan. | Freq. (MHz) | Occupied Bandwidth (MHz) | | | |
|-------|----------------------|--------------------------|---------|---------|---------|
| | | Chain 0 | Chain 1 | Chain 2 | Chain 3 |
| 52 | 5260 | 16.56 | 16.56 | 16.56 | 16.56 |
| 60 | 5300 | 16.56 | 16.56 | 16.56 | 16.56 |
| 64 | 5320 | 16.56 | 16.56 | 16.56 | 16.56 |
| 100 | 5500 | 16.56 | 16.56 | 16.56 | 16.44 |
| 116 | 5580 | 16.56 | 16.56 | 16.56 | 16.56 |
| 140 | 5700 | 16.56 | 16.56 | 16.56 | 16.56 |
| 144 | 5720 For U-NII-2C | 13.16 | 13.16 | 13.16 | 13.16 |
| 144 | 5720 For U-NII-3 | 3.16 | 3.16 | 3.16 | 3.16 |

802.11n (HT20)

| Chan. | Freq. (MHz) | Occupied Bandwidth (MHz) | | | |
|-------|----------------------|--------------------------|---------|---------|---------|
| | | Chain 0 | Chain 1 | Chain 2 | Chain 3 |
| 52 | 5260 | 17.64 | 17.64 | 17.76 | 17.64 |
| 60 | 5300 | 17.64 | 17.64 | 17.76 | 17.64 |
| 64 | 5320 | 17.76 | 17.64 | 17.76 | 17.64 |
| 100 | 5500 | 17.76 | 17.76 | 17.76 | 17.64 |
| 116 | 5580 | 17.76 | 17.76 | 17.76 | 17.64 |
| 140 | 5700 | 17.64 | 17.76 | 17.64 | 17.76 |
| 144 | 5720 For U-NII-2C | 13.76 | 13.76 | 13.76 | 13.76 |
| 144 | 5720 For U-NII-3 | 3.76 | 3.76 | 3.76 | 3.76 |

802.11n (HT40)

| Chan. | Freq. (MHz) | Occupied Bandwidth (MHz) | | | |
|-------|----------------------|--------------------------|---------|---------|---------|
| | | Chain 0 | Chain 1 | Chain 2 | Chain 3 |
| 54 | 5270 | 36.12 | 36.24 | 36.12 | 36.12 |
| 62 | 5310 | 36.00 | 36.12 | 36.00 | 36.12 |
| 102 | 5510 | 36.12 | 36.12 | 36.12 | 36.12 |
| 110 | 5550 | 36.12 | 36.12 | 36.12 | 36.12 |
| 134 | 5670 | 36.12 | 36.00 | 36.12 | 36.00 |
| 142 | 5710 For U-NII-2C | 33.12 | 33.12 | 33.00 | 33.00 |
| 142 | 5710 For U-NII-3 | 3.12 | 3.12 | 3.12 | 3.12 |

802.11ac (VHT80)

| Chan. | Freq. (MHz) | Occupied Bandwidth (MHz) | | | |
|-------|----------------------|--------------------------|---------|---------|---------|
| | | Chain 0 | Chain 1 | Chain 2 | Chain 3 |
| 58 | 5290 | 75.84 | 75.84 | 75.84 | 75.84 |
| 106 | 5530 | 76.08 | 76.08 | 76.08 | 75.84 |
| 122 | 5610 | 76.08 | 75.84 | 76.08 | 75.84 |
| 138 | 5690 For U-NII-2C | 72.92 | 72.92 | 72.92 | 72.92 |
| 138 | 5690 For U-NII-3 | 2.92 | 2.92 | 3.16 | 3.16 |

Spectrum Plot of Worst Value

802.11a

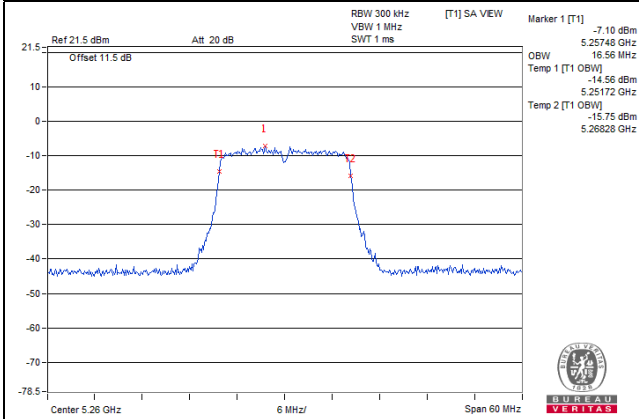

802.11n (HT20)

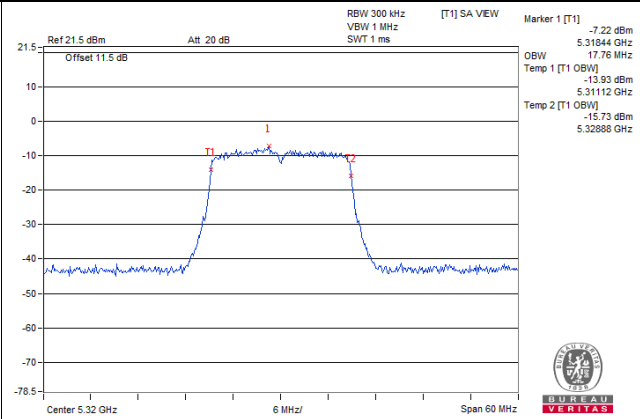

802.11n (HT40)

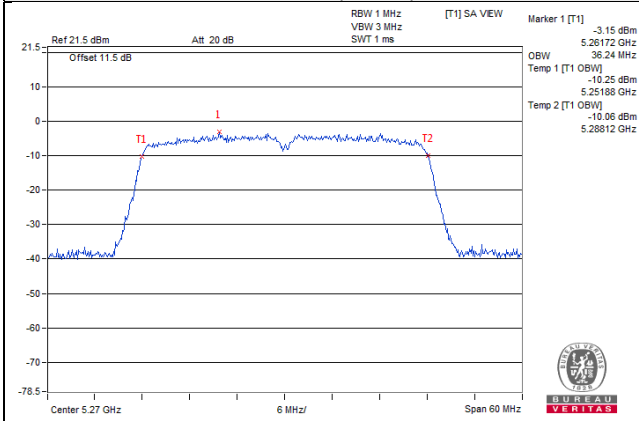

802.11ac (VHT80)

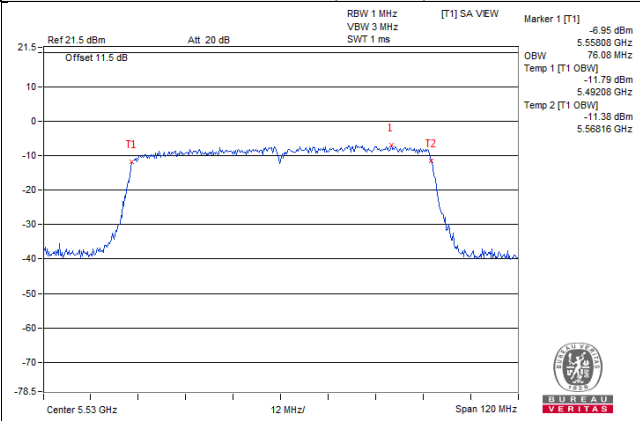

Mode B1

802.11a

| Chan. | Freq. (MHz) | Occupied Bandwidth (MHz) | | | |
|-------|----------------------|--------------------------|---------|---------|---------|
| | | Chain 0 | Chain 1 | Chain 2 | Chain 3 |
| 52 | 5260 | 16.44 | 16.44 | 16.44 | 16.44 |
| 60 | 5300 | 16.44 | 16.44 | 16.56 | 16.44 |
| 64 | 5320 | 16.44 | 16.56 | 16.44 | 16.44 |
| 100 | 5500 | 16.44 | 16.44 | 16.44 | 16.44 |
| 116 | 5580 | 16.44 | 16.44 | 16.44 | 16.44 |
| 140 | 5700 | 16.44 | 16.44 | 16.44 | 16.44 |
| 144 | 5720 For U-NII-2C | 13.16 | 13.16 | 13.16 | 13.28 |
| 144 | 5720 For U-NII-3 | 3.16 | 3.16 | 3.16 | 3.16 |

802.11n (HT20)

| Chan. | Freq. (MHz) | Occupied Bandwidth (MHz) | | | |
|-------|----------------------|--------------------------|---------|---------|---------|
| | | Chain 0 | Chain 1 | Chain 2 | Chain 3 |
| 52 | 5260 | 17.64 | 17.64 | 17.64 | 17.64 |
| 60 | 5300 | 17.64 | 17.64 | 17.64 | 17.64 |
| 64 | 5320 | 17.64 | 17.64 | 17.64 | 17.64 |
| 100 | 5500 | 17.64 | 17.64 | 17.64 | 17.64 |
| 116 | 5580 | 17.64 | 17.64 | 17.64 | 17.64 |
| 140 | 5700 | 17.64 | 17.64 | 17.64 | 17.64 |
| 144 | 5720 For U-NII-2C | 13.88 | 13.88 | 13.88 | 13.88 |
| 144 | 5720 For U-NII-3 | 3.76 | 3.76 | 3.76 | 3.76 |

802.11n (HT40)

| Chan. | Freq. (MHz) | Occupied Bandwidth (MHz) | | | |
|-------|----------------------|--------------------------|---------|---------|---------|
| | | Chain 0 | Chain 1 | Chain 2 | Chain 3 |
| 54 | 5270 | 36.12 | 36.12 | 36.00 | 36.12 |
| 62 | 5310 | 36.12 | 36.00 | 36.00 | 36.12 |
| 102 | 5510 | 36.12 | 36.12 | 36.00 | 36.12 |
| 110 | 5550 | 36.12 | 36.12 | 36.12 | 36.00 |
| 134 | 5670 | 36.12 | 36.00 | 36.12 | 36.00 |
| 142 | 5710 For U-NII-2C | 33.12 | 33.12 | 33.12 | 33.12 |
| 142 | 5710 For U-NII-3 | 3.00 | 3.00 | 3.00 | 3.00 |

802.11ac (VHT80)

| Chan. | Freq. (MHz) | Occupied Bandwidth (MHz) | | | |
|-------|----------------------|--------------------------|---------|---------|---------|
| | | Chain 0 | Chain 1 | Chain 2 | Chain 3 |
| 58 | 5290 | 75.84 | 76.08 | 75.84 | 75.60 |
| 106 | 5530 | 75.84 | 75.84 | 75.84 | 75.84 |
| 122 | 5610 | 76.32 | 76.32 | 76.56 | 76.32 |
| 138 | 5690 For U-NII-2C | 73.16 | 72.92 | 72.92 | 72.92 |
| 138 | 5690 For U-NII-3 | 2.92 | 2.92 | 2.92 | 2.68 |

Spectrum Plot of Worst Value

802.11a

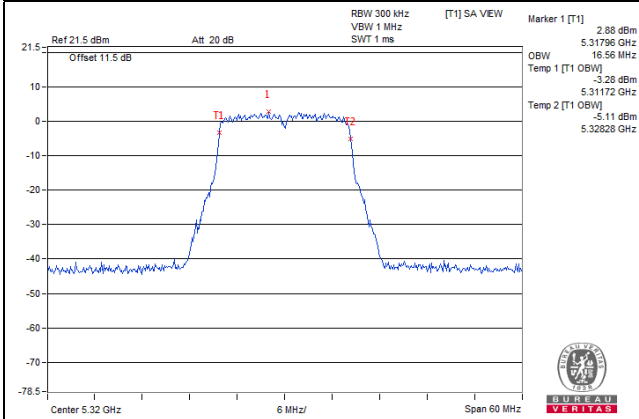

802.11n (HT20)

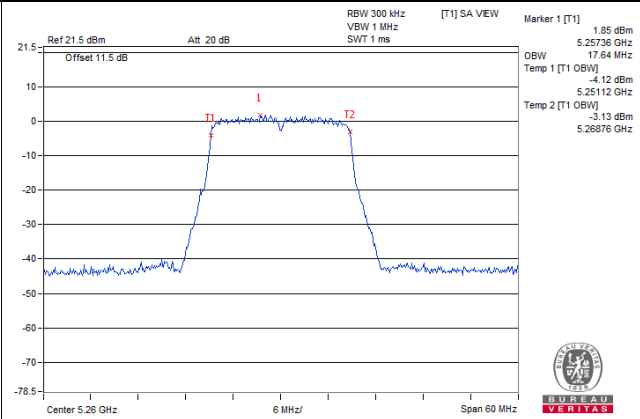

802.11n (HT40)

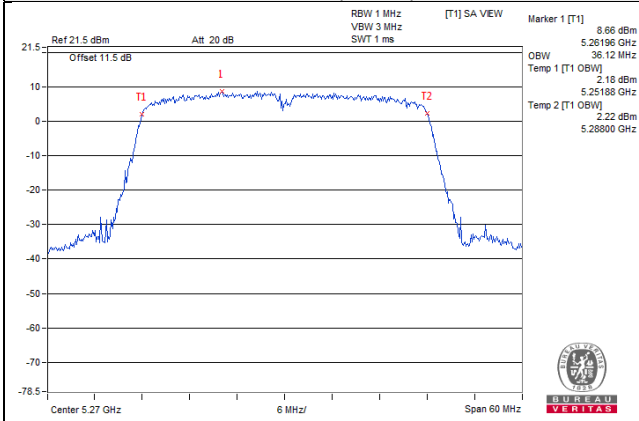

802.11ac (VHT80)

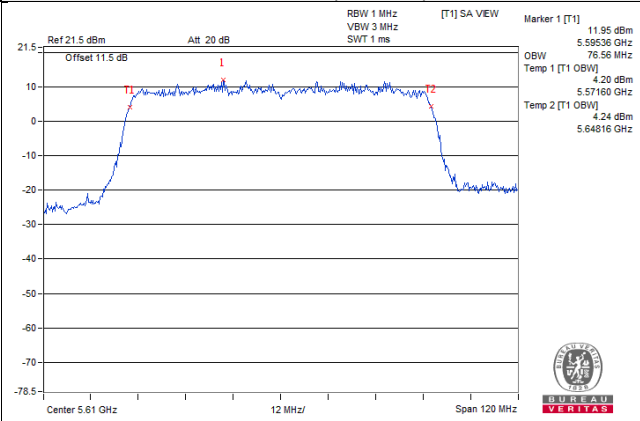

Mode B2

802.11a

| Chan. | Freq. (MHz) | Occupied Bandwidth (MHz) | | | |
|-------|----------------------|--------------------------|---------|---------|---------|
| | | Chain 0 | Chain 1 | Chain 2 | Chain 3 |
| 52 | 5260 | 16.56 | 16.56 | 16.56 | 16.43 |
| 60 | 5300 | 16.56 | 16.56 | 16.56 | 16.44 |
| 64 | 5320 | 16.56 | 16.56 | 16.44 | 16.44 |
| 100 | 5500 | 16.44 | 16.44 | 16.56 | 16.44 |
| 116 | 5580 | 16.44 | 16.56 | 16.44 | 16.44 |
| 140 | 5700 | 16.56 | 16.44 | 16.44 | 16.44 |
| 144 | 5720 For U-NII-2C | 13.16 | 13.28 | 13.28 | 13.28 |
| 144 | 5720 For U-NII-3 | 3.16 | 3.16 | 3.16 | 3.16 |

802.11n (HT20)

| Chan. | Freq. (MHz) | Occupied Bandwidth (MHz) | | | |
|-------|----------------------|--------------------------|---------|---------|---------|
| | | Chain 0 | Chain 1 | Chain 2 | Chain 3 |
| 52 | 5260 | 17.64 | 17.64 | 17.64 | 17.64 |
| 60 | 5300 | 17.64 | 17.64 | 17.64 | 17.64 |
| 64 | 5320 | 17.64 | 17.64 | 17.64 | 17.64 |
| 100 | 5500 | 17.64 | 17.64 | 17.64 | 17.64 |
| 116 | 5580 | 17.64 | 17.64 | 17.64 | 17.64 |
| 140 | 5700 | 17.64 | 17.64 | 17.64 | 17.64 |
| 144 | 5720 For U-NII-2C | 13.76 | 13.88 | 13.88 | 13.88 |
| 144 | 5720 For U-NII-3 | 3.76 | 3.76 | 3.76 | 3.76 |

802.11n (HT40)

| Chan. | Freq. (MHz) | Occupied Bandwidth (MHz) | | | |
|-------|----------------------|--------------------------|---------|---------|---------|
| | | Chain 0 | Chain 1 | Chain 2 | Chain 3 |
| 54 | 5270 | 36.00 | 36.12 | 36.00 | 36.12 |
| 62 | 5310 | 36.00 | 36.12 | 36.00 | 36.12 |
| 102 | 5510 | 36.12 | 36.00 | 36.00 | 36.00 |
| 110 | 5550 | 36.12 | 36.12 | 36.00 | 36.00 |
| 134 | 5670 | 36.00 | 36.00 | 36.12 | 36.00 |
| 142 | 5710 For U-NII-2C | 33.00 | 33.00 | 33.00 | 33.00 |
| 142 | 5710 For U-NII-3 | 3.12 | 3.12 | 3.00 | 3.00 |

802.11ac (VHT80)

| Chan. | Freq. (MHz) | Occupied Bandwidth (MHz) | | | |
|-------|----------------------|--------------------------|---------|---------|---------|
| | | Chain 0 | Chain 1 | Chain 2 | Chain 3 |
| 58 | 5290 | 76.08 | 76.08 | 75.84 | 76.08 |
| 106 | 5530 | 76.08 | 75.84 | 75.84 | 75.84 |
| 122 | 5610 | 75.84 | 75.84 | 76.08 | 76.08 |
| 138 | 5690 For U-NII-2C | 72.92 | 72.92 | 72.92 | 72.92 |
| 138 | 5690 For U-NII-3 | 2.92 | 2.92 | 2.92 | 2.92 |

Spectrum Plot of Worst Value

802.11a

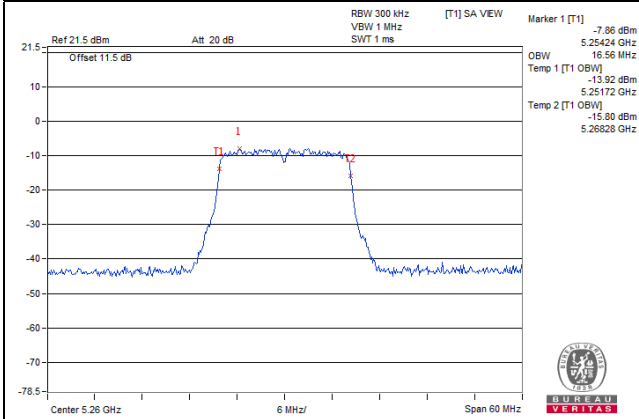

802.11n (HT20)

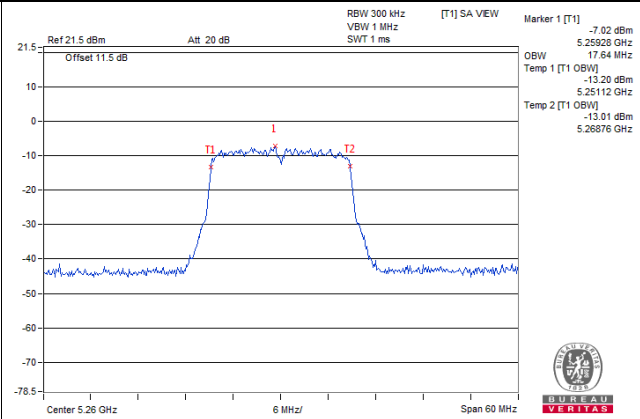

802.11n (HT40)

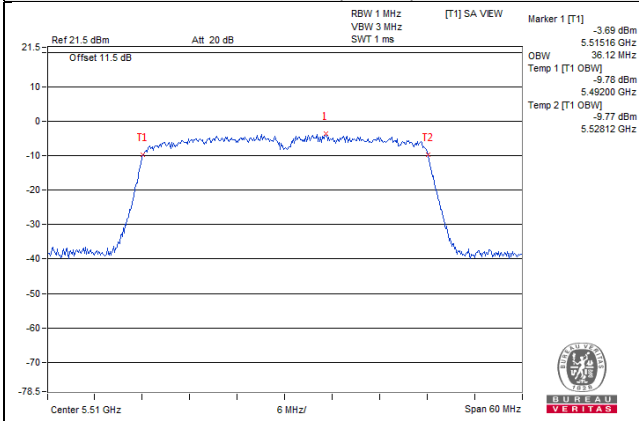

802.11ac (VHT80)

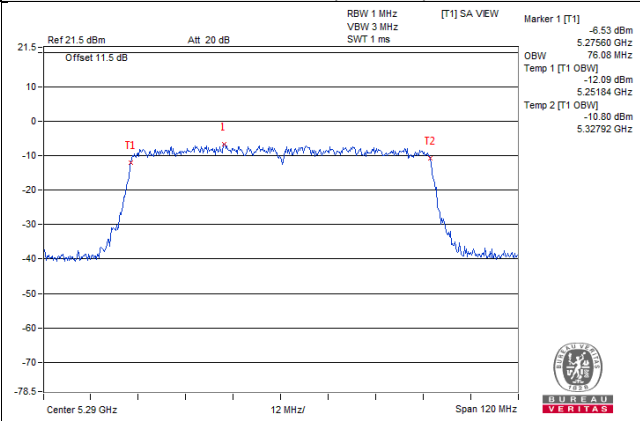

4.5 Peak Power Spectral Density Measurement

4.5.1 Limits of Peak Power Spectral Density Measurement

| Operation Band | EUT Category | | Limit |
|----------------|--------------|-----------------------------------|---------------|
| U-NII-1 | | Outdoor Access Point | 17dBm/ MHz |
| | | Fixed point-to-point Access Point | |
| | | Indoor Access Point | |
| | | Mobile and Portable client device | |
| U-NII-2A | √ | | 11dBm/ MHz |
| U-NII-2C | √ | | 11dBm/ MHz |
| U-NII-3 | √ | | 30dBm/ 500kHz |

4.5.2 Test Setup

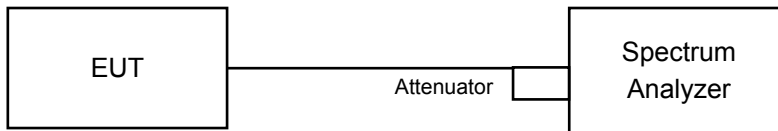

4.5.3 Test Instruments

Refer to section 4.1.2 to get information of above instrument.

4.5.4 Test Procedures

For U-NII-1, U-NII-2A, U-NII-2C Band

Duty cycle of test signal is $\geq 98\%$

Using method SA-1

- 1) Set span to encompass the entire emission bandwidth (EBW) of the signal.
- 2) Set RBW = 1MHz, Set VBW ≥ 3 MHz, Detector = RMS.
- 3) Set Channel power measure = 1MHz.
- 4) Sweep time = auto, trigger set to "free run".
- 5) Trace average at least 100 traces in power averaging mode.
- 6) Record the max value.

Duty cycle of test signal is $< 98\%$

Using method SA-2

- 1) Set span to encompass the entire emission bandwidth (EBW) of the signal.
- 2) Set RBW = 1MHz, Set VBW ≥ 3 MHz, Detector = RMS.
- 3) Set Channel power measure = 1MHz.
- 4) Sweep time = auto, trigger set to "free run".
- 5) Trace average at least 100 traces in power averaging mode.
- 6) Record the max value and add $10 \log (1/\text{duty cycle})$.

For U-NII-3 Band

Duty cycle of test signal is $\geq 98\%$

Using method SA-1

- 1) Set span to encompass the entire emission bandwidth (EBW) of the signal.
- 2) Set RBW = 300 kHz, Set VBW ≥ 1 MHz, Detector = RMS.
- 3) Use the peak marker function to determine the maximum power level in any 300 kHz band segment within the fundamental EBW.
- 4) Scale the observed power level to an equivalent value in 500 kHz by adjusting (reducing) the measured power by a bandwidth correction factor (BWCF) where $BWCF = 10\log(500 \text{ kHz} / 300 \text{ kHz})$.
- 5) Sweep time = auto, trigger set to "free run".
- 6) Trace average at least 100 traces in power averaging mode.
- 7) Record the max value.

Duty cycle of test signal is $< 98\%$

- 1) Set span to encompass the entire emission bandwidth (EBW) of the signal.
- 2) Set RBW = 300 kHz, Set VBW ≥ 1 MHz, Detector = RMS.
- 3) Use the peak marker function to determine the maximum power level in any 300 kHz band segment within the fundamental EBW.
- 4) Scale the observed power level to an equivalent value in 500 kHz by adjusting (reducing) the measured power by a bandwidth correction factor (BWCF) where $BWCF = 10\log(500 \text{ kHz} / 300 \text{ kHz})$.
- 5) Sweep time = auto, trigger set to "free run".
- 6) Trace average at least 100 traces in power averaging mode.
- 7) Record the max value and add $10 \log (1/\text{duty cycle})$.

4.5.5 Deviation from Test Standard

No deviation.

4.5.6 EUT Operating Conditions

Same as 4.3.6.

4.5.7 Test Results

Mode A1

For U-NII-2A, U-NII-2C Band

802.11a

| Chan. | Freq. (MHz) | PSD W/O Duty Factor (dBm/MHz) | | | | Total PSD W/O Duty Factor (dBm/MHz) | Duty Factor (dB) | Total PSD Wth Duty Factor (dBm/MHz) | Max. Limit (dBm/MHz) | Pass / Fail |
|-------|----------------------|-------------------------------|---------|---------|---------|-------------------------------------|------------------|-------------------------------------|----------------------|-------------|
| | | Chain 0 | Chain 1 | Chain 2 | Chain 3 | | | | | |
| 52 | 5260 | -2.74 | -3.08 | -2.71 | -2.71 | 3.21 | 0.21 | 3.42 | 3.98 | Pass |
| 60 | 5300 | -2.66 | -2.99 | -2.59 | -2.87 | 3.24 | 0.21 | 3.45 | 3.98 | Pass |
| 64 | 5320 | -2.94 | -2.73 | -2.67 | -3.02 | 3.18 | 0.21 | 3.39 | 3.98 | Pass |
| 100 | 5500 | -2.58 | -2.64 | -2.44 | -2.06 | 3.60 | 0.21 | 3.81 | 3.98 | Pass |
| 116 | 5580 | -2.50 | -2.55 | -3.13 | -2.57 | 3.34 | 0.21 | 3.55 | 3.98 | Pass |
| 140 | 5700 | -2.89 | -2.66 | -2.00 | -2.50 | 3.52 | 0.21 | 3.73 | 3.98 | Pass |
| 144 | 5720 For U-NII-2C | -2.66 | -2.64 | -2.14 | -2.26 | 3.60 | 0.21 | 3.81 | 3.98 | Pass |

Note:

1. Method a) of power density measurement of KDB 662911 is using for calculating total power density. Total power density is summing entire spectra across corresponding frequency bins on the various outputs by computer.
2. Directional Gain = $7 + 10\log(4) = 13.02\text{dBi} > 6\text{dBi}$, so the limit shall be reduced to $11 - (13.02 - 6) = 3.98\text{dBm}$.
3. Refer to section 3.3 for duty cycle spectrum plot.

802.11n (HT20)

| Chan. | Freq. (MHz) | PSD (dBm/MHz) | | | | Total PSD (dBm/MHz) | Max. Limit (dBm/MHz) | Pass / Fail |
|-------|----------------------|---------------|---------|---------|---------|---------------------|----------------------|-------------|
| | | Chain 0 | Chain 1 | Chain 2 | Chain 3 | | | |
| 52 | 5260 | -2.58 | -2.97 | -2.64 | -2.63 | 3.32 | 3.98 | Pass |
| 60 | 5300 | -2.86 | -3.05 | -2.36 | -2.62 | 3.31 | 3.98 | Pass |
| 64 | 5320 | -2.77 | -2.47 | -1.98 | -2.40 | 3.62 | 3.98 | Pass |
| 100 | 5500 | -2.36 | -2.34 | -2.48 | -2.18 | 3.68 | 3.98 | Pass |
| 116 | 5580 | -2.35 | -2.58 | -2.99 | -2.68 | 3.38 | 3.98 | Pass |
| 140 | 5700 | -1.72 | -2.44 | -1.84 | -3.12 | 3.78 | 3.98 | Pass |
| 144 | 5720 For U-NII-2C | -2.15 | -2.52 | -1.95 | -2.86 | 3.66 | 3.98 | Pass |

Note:

1. Method a) of power density measurement of KDB 662911 is using for calculating total power density. Total power density is summing entire spectra across corresponding frequency bins on the various outputs by computer.
2. Directional Gain = $7 + 10\log(4) = 13.02\text{dBi} > 6\text{dBi}$, so the limit shall be reduced to $11 - (13.02 - 6) = 3.98\text{dBm}$.

802.11n (HT40)

| Chan. | Freq. (MHz) | PSD W/O Duty Factor (dBm/MHz) | | | | Total PSD W/O Duty Factor (dBm/MHz) | Duty Factor (dB) | Total PSD Wth Duty Factor (dBm/MHz) | Max. Limit (dBm/MHz) | Pass / Fail |
|-------|-----------------------|-------------------------------|---------|---------|---------|-------------------------------------|------------------|-------------------------------------|----------------------|-------------|
| | | Chain 0 | Chain 1 | Chain 2 | Chain 3 | | | | | |
| 54 | 5270 | -2.98 | -3.24 | -2.99 | -3.19 | 2.92 | 0.13 | 3.05 | 3.98 | Pass |
| 62 | 5310 | -2.84 | -2.95 | -2.27 | -2.70 | 3.34 | 0.13 | 3.47 | 3.98 | Pass |
| 102 | 5510 | -4.17 | -4.21 | -4.52 | -4.03 | 1.79 | 0.13 | 1.92 | 3.98 | Pass |
| 110 | 5550 | -4.60 | -4.77 | -4.91 | -4.36 | 1.36 | 0.13 | 1.49 | 3.98 | Pass |
| 134 | 5670 | -4.50 | -5.78 | -4.58 | -6.20 | 0.82 | 0.13 | 0.95 | 3.98 | Pass |
| 142 | 5710 For U-NII-2 C | -4.40 | -4.97 | -4.57 | -5.44 | 1.19 | 0.13 | 1.32 | 3.98 | Pass |

Note:

- Method a) of power density measurement of KDB 662911 is using for calculating total power density. Total power density is summing entire spectra across corresponding frequency bins on the various outputs by computer.
- Directional Gain = $7 + 10\log(4) = 13.02\text{dBi} > 6\text{dBi}$, so the limit shall be reduced to $11 - (13.02 - 6) = 3.98\text{dBm}$.
- Refer to section 3.3 for duty cycle spectrum plot.

802.11ac (VHT80)

| Chan. | Freq. (MHz) | PSD W/O Duty Factor (dBm/MHz) | | | | Total PSD W/O Duty Factor (dBm/MHz) | Duty Factor (dB) | Total PSD Wth Duty Factor (dBm/MHz) | Max. Limit (dBm/MHz) | Pass / Fail |
|-------|-----------------------|-------------------------------|---------|---------|---------|-------------------------------------|------------------|-------------------------------------|----------------------|-------------|
| | | Chain 0 | Chain 1 | Chain 2 | Chain 3 | | | | | |
| 58 | 5290 | -5.49 | -5.50 | -5.49 | -5.88 | 0.43 | 0.26 | 0.69 | 3.98 | Pass |
| 106 | 5530 | -6.41 | -6.14 | -6.64 | -6.17 | -0.32 | 0.26 | -0.06 | 3.98 | Pass |
| 122 | 5610 | -5.78 | -5.69 | -6.38 | -6.53 | -0.06 | 0.26 | 0.20 | 3.98 | Pass |
| 138 | 5690 For U-NII-2 C | -5.55 | -6.01 | -5.44 | -6.39 | 0.19 | 0.26 | 0.45 | 3.98 | Pass |

Note:

- Method a) of power density measurement of KDB 662911 is using for calculating total power density. Total power density is summing entire spectra across corresponding frequency bins on the various outputs by computer.
- Directional Gain = $7 + 10\log(4) = 13.02\text{dBi} > 6\text{dBi}$, so the limit shall be reduced to $11 - (13.02 - 6) = 3.98\text{dBm}$.
- Refer to section 3.3 for duty cycle spectrum plot.

Spectrum Plot of Worst Value

802.11a / Chain 2 / CH 140

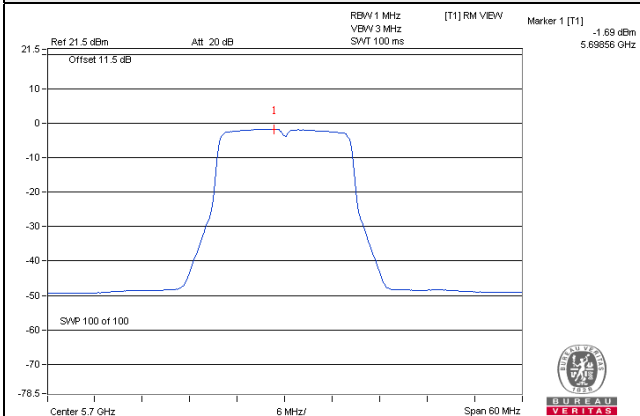

802.11n (HT20) / Chain 0 / CH 140

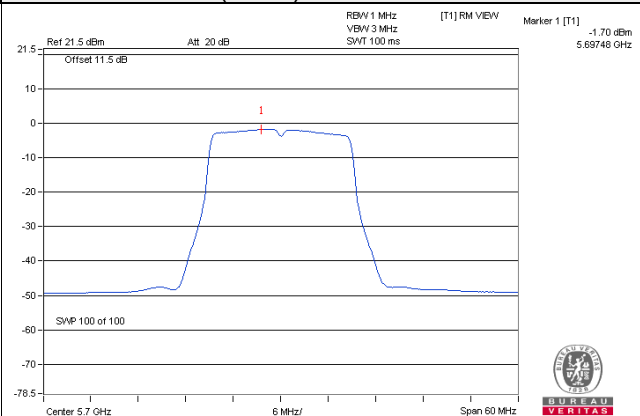

802.11n (HT40) / Chain 2 / CH 62

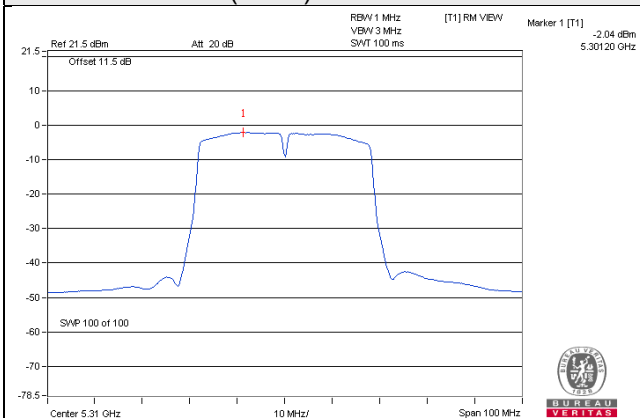

802.11ac (VHT80) / Chain 2 / CH 138

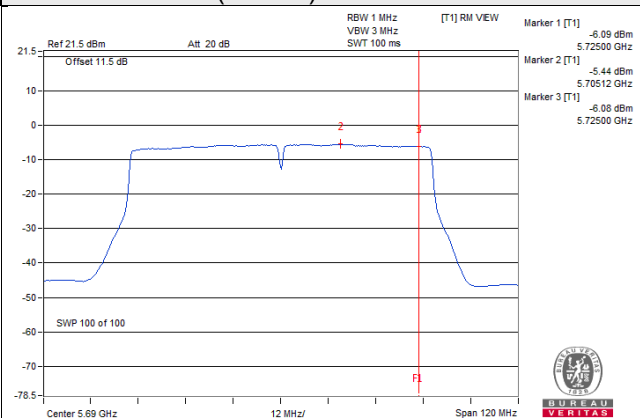

For U-NII-3 Band

802.11a

| TX chain | Chan. | Freq. (MHz) | PSD W/O Duty Factor | | 10 log (N=4) dB | Duty Factor (dB) | Total PSD With Duty Factor (dBm/500kHz) | Limit (dBm/500kHz) | Pass / Fail |
|----------|-------|---------------------|---------------------|--------------|-----------------|------------------|---|--------------------|-------------|
| | | | (dBm/300kHz) | (dBm/500kHz) | | | | | |
| 0 | 144 | 5720 For U-NII-3 | -11.34 | -9.12 | 6.02 | 0.21 | -2.89 | 22.98 | Pass |
| 1 | 144 | 5720 For U-NII-3 | -11.40 | -9.18 | 6.02 | 0.21 | -2.95 | 22.98 | Pass |
| 2 | 144 | 5720 For U-NII-3 | -10.98 | -8.76 | 6.02 | 0.21 | -2.53 | 22.98 | Pass |
| 3 | 144 | 5720 For U-NII-3 | -11.06 | -8.84 | 6.02 | 0.21 | -2.61 | 22.98 | Pass |

Note:

- Method a) of power density measurement of KDB 662911 is using for calculating total power density. Total power density is summing entire spectra across corresponding frequency bins on the various outputs by computer.
- Directional Gain = $7 + 10\log(4) = 13.02\text{dBi} > 6\text{dBi}$, so the limit shall be reduced to $30 - (13.02 - 6) = 22.98\text{dBm}$.
- Refer to section 3.3 for duty cycle spectrum plot.

802.11n (HT20)

| TX chain | Chan. | Freq. (MHz) | PSD W/O Duty Factor | | 10 log (N=4) dB | Total PSD (dBm/500kHz) | Limit (dBm/500kHz) | Pass / Fail |
|----------|-------|---------------------|---------------------|--------------|-----------------|------------------------|--------------------|-------------|
| | | | (dBm/300kHz) | (dBm/500kHz) | | | | |
| 0 | 144 | 5720 For U-NII-3 | -11.43 | -9.21 | 6.02 | -3.19 | 22.98 | Pass |
| 1 | 144 | 5720 For U-NII-3 | -11.51 | -9.29 | 6.02 | -3.27 | 22.98 | Pass |
| 2 | 144 | 5720 For U-NII-3 | -11.11 | -8.89 | 6.02 | -2.87 | 22.98 | Pass |
| 3 | 144 | 5720 For U-NII-3 | -11.13 | -8.91 | 6.02 | -2.89 | 22.98 | Pass |

Note:

- Method a) of power density measurement of KDB 662911 is using for calculating total power density. Total power density is summing entire spectra across corresponding frequency bins on the various outputs by computer.
- Directional Gain = $7 + 10\log(4) = 13.02\text{dBi} > 6\text{dBi}$, so the limit shall be reduced to $30 - (13.02 - 6) = 22.98\text{dBm}$.

802.11n (HT40)

| TX chain | Chan. | Freq. (MHz) | PSD W/O Duty Factor | | 10 log (N=4) dB | Duty Factor (dB) | Total PSD With Duty Factor (dBm/500kHz) | Limit (dBm/500kHz) | Pass / Fail |
|----------|-------|------------------------|---------------------|--------------|-----------------|------------------|---|--------------------|-------------|
| | | | (dBm/300kHz) | (dBm/500kHz) | | | | | |
| 0 | 142 | 5710 For U-NII-3 | -15.65 | -13.43 | 6.02 | 0.13 | -7.28 | 22.98 | Pass |
| 1 | 142 | 5710 For U-NII-3 | -16.10 | -13.88 | 6.02 | 0.13 | -7.73 | 22.98 | Pass |
| 2 | 142 | 5710 For U-NII-3 | -15.26 | -13.04 | 6.02 | 0.13 | -6.89 | 22.98 | Pass |
| 3 | 142 | 5710 For U-NII-3 | -15.23 | -13.01 | 6.02 | 0.13 | -6.86 | 22.98 | Pass |

Note:

1. Method a) of power density measurement of KDB 662911 is using for calculating total power density. Total power density is summing entire spectra across corresponding frequency bins on the various outputs by computer.
2. Directional Gain = $7 + 10\log(4) = 13.02\text{dBi} > 6\text{dBi}$, so the limit shall be reduced to $30 - (13.02 - 6) = 22.98\text{dBm}$.
3. Refer to section 3.3 for duty cycle spectrum plot.

802.11ac (VHT80)

| TX chain | Chan. | Freq. (MHz) | PSD W/O Duty Factor | | 10 log (N=4) dB | Duty Factor (dB) | Total PSD With Duty Factor (dBm/500kHz) | Limit (dBm/500kHz) | Pass / Fail |
|----------|-------|------------------------|---------------------|--------------|-----------------|------------------|---|--------------------|-------------|
| | | | (dBm/300kHz) | (dBm/500kHz) | | | | | |
| 0 | 138 | 5690 For U-NII-3 | -15.30 | -13.08 | 6.02 | 0.26 | -6.80 | 22.98 | Pass |
| 1 | 138 | 5690 For U-NII-3 | -15.92 | -13.70 | 6.02 | 0.26 | -7.42 | 22.98 | Pass |
| 2 | 138 | 5690 For U-NII-3 | -14.85 | -12.63 | 6.02 | 0.26 | -6.35 | 22.98 | Pass |
| 3 | 138 | 5690 For U-NII-3 | -16.21 | -13.99 | 6.02 | 0.26 | -7.71 | 22.98 | Pass |

Note:

1. Method a) of power density measurement of KDB 662911 is using for calculating total power density. Total power density is summing entire spectra across corresponding frequency bins on the various outputs by computer.
2. Directional Gain = $7 + 10\log(4) = 13.02\text{dBi} > 6\text{dBi}$, so the limit shall be reduced to $30 - (13.02 - 6) = 22.98\text{dBm}$.
3. Refer to section 3.3 for duty cycle spectrum plot.

Spectrum Plot of Worst Value

802.11a

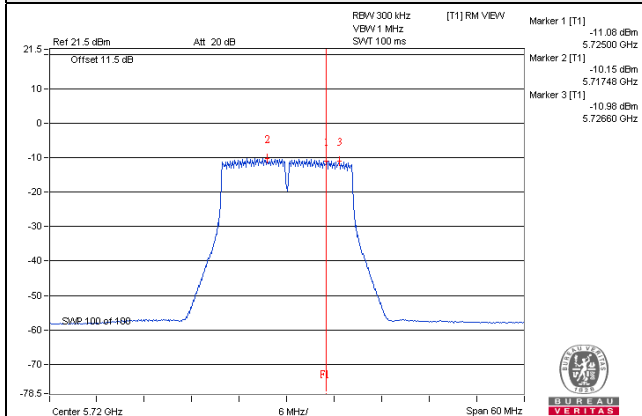

802.11n (HT20)

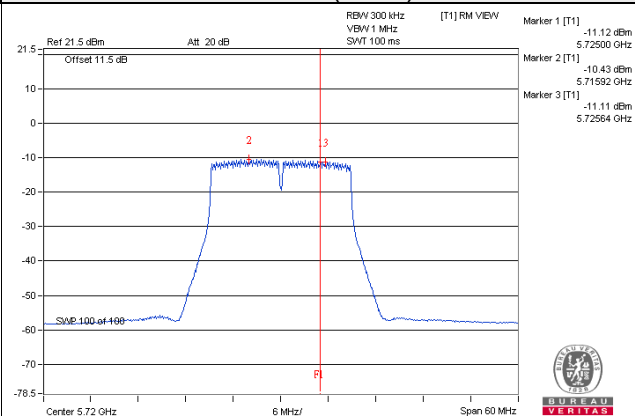

802.11n (HT40)

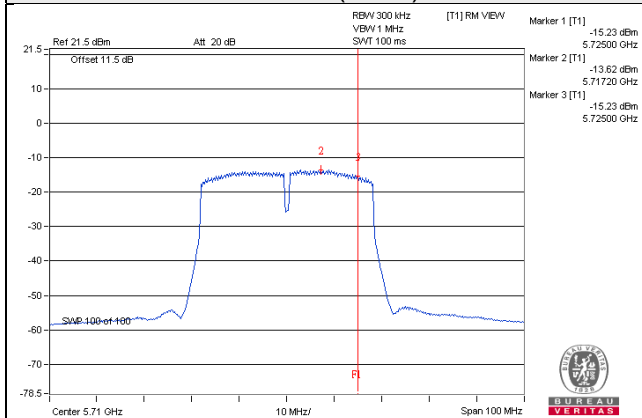

802.11ac (VHT80)

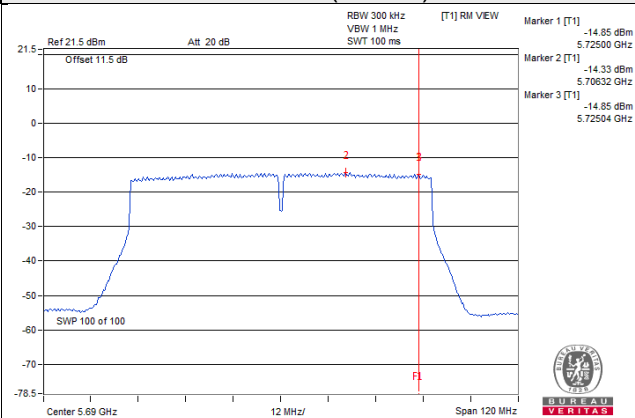

Mode A2
For U-NII-2A, U-NII-2C Band
802.11a

| Chan. | Freq. (MHz) | PSD W/O Duty Factor (dBm/MHz) | | | | Total PSD W/O Duty Factor (dBm/MHz) | Duty Factor (dB) | Total PSD Wth Duty Factor (dBm/MHz) | Max. Limit (dBm/MHz) | Pass / Fail |
|-------|----------------------|-------------------------------|---------|---------|---------|-------------------------------------|------------------|-------------------------------------|----------------------|-------------|
| | | Chain 0 | Chain 1 | Chain 2 | Chain 3 | | | | | |
| 52 | 5260 | -12.65 | -12.61 | -12.55 | -12.40 | -6.53 | 0.21 | -6.32 | -6.27 | Pass |
| 60 | 5300 | -12.45 | -12.61 | -12.37 | -12.80 | -6.53 | 0.21 | -6.32 | -6.27 | Pass |
| 64 | 5320 | -12.27 | -12.55 | -12.53 | -13.05 | -6.57 | 0.21 | -6.36 | -6.27 | Pass |
| 100 | 5500 | -12.99 | -13.06 | -12.95 | -12.52 | -6.86 | 0.21 | -6.65 | -6.27 | Pass |
| 116 | 5580 | -12.35 | -12.55 | -13.31 | -12.95 | -6.75 | 0.21 | -6.54 | -6.27 | Pass |
| 140 | 5700 | -12.21 | -12.70 | -12.51 | -13.24 | -6.63 | 0.21 | -6.42 | -6.27 | Pass |
| 144 | 5720 For U-NII-2C | -12.36 | -12.47 | -12.57 | -13.28 | -6.64 | 0.21 | -6.43 | -6.27 | Pass |

Note:

- Method a) of power density measurement of KDB 662911 is using for calculating total power density. Total power density is summing entire spectra across corresponding frequency bins on the various outputs by computer.
- Directional Gain = $18.5 + 10\log(3) = 23.27\text{dBi} > 6\text{dBi}$, so the limit shall be reduced to $11 - (23.27 - 6) = -6.27\text{dBm}$.
- Refer to section 3.3 for duty cycle spectrum plot.

802.11n (HT20)

| Chan. | Freq. (MHz) | PSD (dBm/MHz) | | | | Total PSD (dBm/MHz) | Max. Limit (dBm/MHz) | Pass / Fail |
|-------|----------------------|---------------|---------|---------|---------|---------------------|----------------------|-------------|
| | | Chain 0 | Chain 1 | Chain 2 | Chain 3 | | | |
| 52 | 5260 | -12.17 | -12.66 | -12.62 | -12.46 | -6.45 | -6.27 | Pass |
| 60 | 5300 | -12.09 | -12.57 | -12.43 | -12.80 | -6.45 | -6.27 | Pass |
| 64 | 5320 | -12.45 | -12.47 | -12.50 | -13.18 | -6.62 | -6.27 | Pass |
| 100 | 5500 | -13.02 | -13.18 | -12.99 | -12.47 | -6.89 | -6.27 | Pass |
| 116 | 5580 | -12.39 | -12.57 | -13.35 | -13.10 | -6.82 | -6.27 | Pass |
| 140 | 5700 | -12.35 | -12.77 | -12.62 | -13.28 | -6.72 | -6.27 | Pass |
| 144 | 5720 For U-NII-2C | -11.80 | -12.06 | -12.52 | -13.08 | -6.32 | -6.27 | Pass |

Note:

- Method a) of power density measurement of KDB 662911 is using for calculating total power density. Total power density is summing entire spectra across corresponding frequency bins on the various outputs by computer.
- Directional Gain = $18.5 + 10\log(3) = 23.27\text{dBi} > 6\text{dBi}$, so the limit shall be reduced to $11 - (23.27 - 6) = -6.27\text{dBm}$.

802.11n (HT40)

| Chan. | Freq. (MHz) | PSD W/O Duty Factor (dBm/MHz) | | | | Total PSD W/O Duty Factor (dBm/MHz) | Duty Factor (dB) | Total PSD Wth Duty Factor (dBm/MHz) | Max. Limit (dBm/MHz) | Pass / Fail |
|-------|-----------------------------|-------------------------------|---------|---------|---------|-------------------------------------|------------------|-------------------------------------|----------------------|-------------|
| | | Chain 0 | Chain 1 | Chain 2 | Chain 3 | | | | | |
| 54 | 5270 | -13.59 | -14.09 | -14.19 | -13.98 | -7.94 | 0.13 | -7.81 | -6.27 | Pass |
| 62 | 5310 | -13.60 | -14.18 | -14.08 | -14.39 | -8.03 | 0.13 | -7.90 | -6.27 | Pass |
| 102 | 5510 | -14.34 | -14.55 | -14.66 | -14.06 | -8.38 | 0.13 | -8.25 | -6.27 | Pass |
| 110 | 5550 | -14.04 | -14.32 | -14.82 | -14.27 | -8.33 | 0.13 | -8.20 | -6.27 | Pass |
| 134 | 5670 | -13.61 | -14.68 | -13.80 | -14.93 | -8.20 | 0.13 | -8.07 | -6.27 | Pass |
| 142 | 5710 For U-NII-2 C | -14.34 | -14.78 | -14.85 | -15.55 | -8.84 | 0.13 | -8.71 | -6.27 | Pass |

Note:

- Method a) of power density measurement of KDB 662911 is using for calculating total power density. Total power density is summing entire spectra across corresponding frequency bins on the various outputs by computer.
- Directional Gain = $18.5 + 10\log(3) = 23.27\text{dBi} > 6\text{dBi}$, so the limit shall be reduced to $11 - (23.27 - 6) = -6.27\text{dBm}$.
- Refer to section 3.3 for duty cycle spectrum plot.

802.11ac (VHT80)

| Chan. | Freq. (MHz) | PSD W/O Duty Factor (dBm/MHz) | | | | Total PSD W/O Duty Factor (dBm/MHz) | Duty Factor (dB) | Total PSD Wth Duty Factor (dBm/MHz) | Max. Limit (dBm/MHz) | Pass / Fail |
|-------|-----------------------------|-------------------------------|---------|---------|---------|-------------------------------------|------------------|-------------------------------------|----------------------|-------------|
| | | Chain 0 | Chain 1 | Chain 2 | Chain 3 | | | | | |
| 58 | 5290 | -16.94 | -17.29 | -17.29 | -17.33 | -11.19 | 0.26 | -10.93 | -6.27 | Pass |
| 106 | 5530 | -17.51 | -17.28 | -18.14 | -17.51 | -11.59 | 0.26 | -11.33 | -6.27 | Pass |
| 122 | 5610 | -17.21 | -17.42 | -17.93 | -18.01 | -11.61 | 0.26 | -11.35 | -6.27 | Pass |
| 138 | 5690 For U-NII-2 C | -18.03 | -20.18 | -19.33 | -21.88 | -13.61 | 0.26 | -13.35 | -6.27 | Pass |

Note:

- Method a) of power density measurement of KDB 662911 is using for calculating total power density. Total power density is summing entire spectra across corresponding frequency bins on the various outputs by computer.
- Directional Gain = $18.5 + 10\log(3) = 23.27\text{dBi} > 6\text{dBi}$, so the limit shall be reduced to $11 - (23.27 - 6) = -6.27\text{dBm}$.
- Refer to section 3.3 for duty cycle spectrum plot.

Spectrum Plot of Worst Value

802.11a / Chain 0 / CH 140

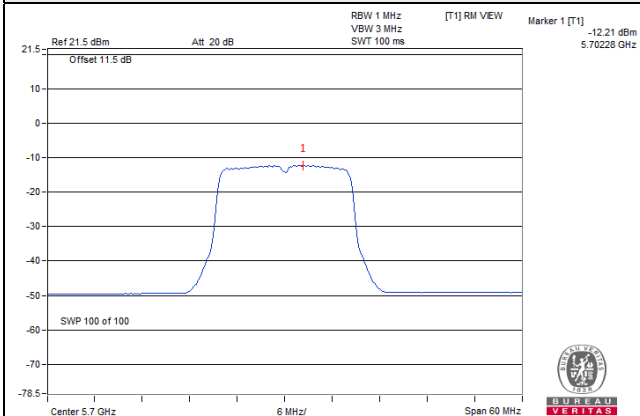

802.11n (HT20) / Chain 0 / CH 144

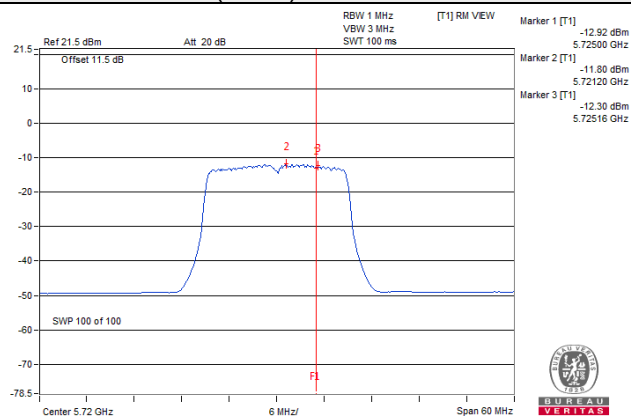

802.11n (HT40) / Chain 0 / CH 54

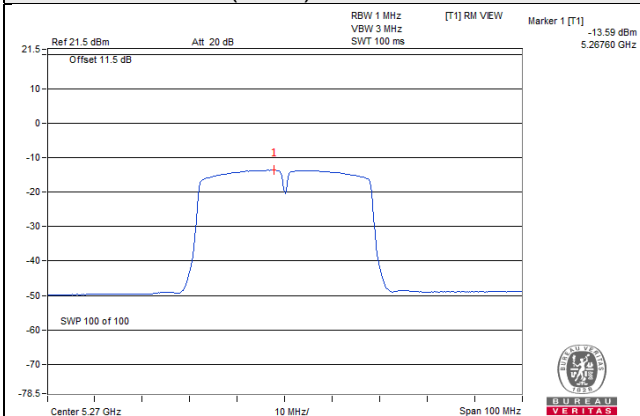

802.11ac (VHT80) / Chain 0 / CH 58

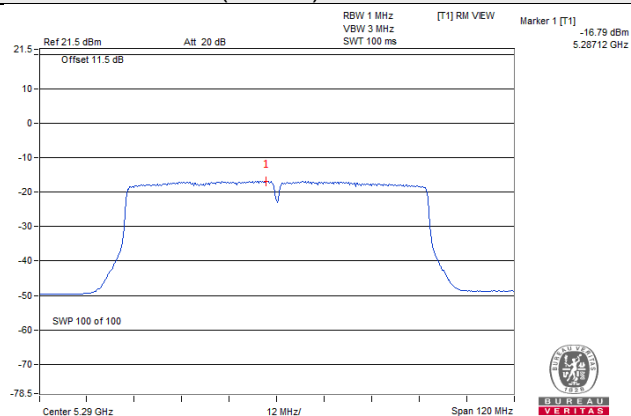

For U-NII-3 Band

802.11a

| TX chain | Chan. | Freq. (MHz) | PSD W/O Duty Factor | | 10 log (N=4) dB | Duty Factor (dB) | Total PSD With Duty Factor (dBm/500kHz) | Limit (dBm/500kHz) | Pass / Fail |
|----------|-------|---------------------|---------------------|--------------|-----------------|------------------|---|--------------------|-------------|
| | | | (dBm/300kHz) | (dBm/500kHz) | | | | | |
| 0 | 144 | 5720 For U-NII-3 | -21.10 | -18.88 | 6.02 | 0.21 | -12.65 | 12.73 | Pass |
| 1 | 144 | 5720 For U-NII-3 | -21.09 | -18.87 | 6.02 | 0.21 | -12.64 | 12.73 | Pass |
| 2 | 144 | 5720 For U-NII-3 | -21.07 | -18.85 | 6.02 | 0.21 | -12.62 | 12.73 | Pass |
| 3 | 144 | 5720 For U-NII-3 | -22.03 | -19.81 | 6.02 | 0.21 | -13.58 | 12.73 | Pass |

Note:

- Method a) of power density measurement of KDB 662911 is using for calculating total power density. Total power density is summing entire spectra across corresponding frequency bins on the various outputs by computer.
- Directional Gain = $18.5 + 10\log(3) = 23.27\text{dBi} > 6\text{dBi}$, so the limit shall be reduced to $30 - (23.27 - 6) = 12.73\text{dBm}$.
- Refer to section 3.3 for duty cycle spectrum plot.

802.11n (HT20)

| TX chain | Chan. | Freq. (MHz) | PSD W/O Duty Factor | | 10 log (N=4) dB | Total PSD (dBm/500kHz) | Limit (dBm/500kHz) | Pass / Fail |
|----------|-------|---------------------|---------------------|--------------|-----------------|------------------------|--------------------|-------------|
| | | | (dBm/300kHz) | (dBm/500kHz) | | | | |
| 0 | 144 | 5720 For U-NII-3 | -20.90 | -18.68 | 6.02 | -12.66 | 12.73 | Pass |
| 1 | 144 | 5720 For U-NII-3 | -21.03 | -18.81 | 6.02 | -12.79 | 12.73 | Pass |
| 2 | 144 | 5720 For U-NII-3 | -20.46 | -18.24 | 6.02 | -12.22 | 12.73 | Pass |
| 3 | 144 | 5720 For U-NII-3 | -21.68 | -19.46 | 6.02 | -13.44 | 12.73 | Pass |

Note:

- Method a) of power density measurement of KDB 662911 is using for calculating total power density. Total power density is summing entire spectra across corresponding frequency bins on the various outputs by computer.
- Directional Gain = $18.5 + 10\log(3) = 23.27\text{dBi} > 6\text{dBi}$, so the limit shall be reduced to $30 - (23.27 - 6) = 12.73\text{dBm}$.

802.11n (HT40)

| TX chain | Chan. | Freq. (MHz) | PSD W/O Duty Factor | | 10 log (N=4) dB | Duty Factor (dB) | Total PSD With Duty Factor (dBm/500kHz) | Limit (dBm/500kHz) | Pass / Fail |
|----------|-------|------------------------|---------------------|--------------|-----------------|------------------|---|--------------------|-------------|
| | | | (dBm/300kHz) | (dBm/500kHz) | | | | | |
| 0 | 142 | 5710 For U-NII-3 | -25.48 | -23.26 | 6.02 | 0.13 | -17.11 | 12.73 | Pass |
| 1 | 142 | 5710 For U-NII-3 | -25.39 | -23.17 | 6.02 | 0.13 | -17.02 | 12.73 | Pass |
| 2 | 142 | 5710 For U-NII-3 | -25.45 | -23.23 | 6.02 | 0.13 | -17.08 | 12.73 | Pass |
| 3 | 142 | 5710 For U-NII-3 | -25.77 | -23.55 | 6.02 | 0.13 | -17.40 | 12.73 | Pass |

Note:

- Method a) of power density measurement of KDB 662911 is using for calculating total power density. Total power density is summing entire spectra across corresponding frequency bins on the various outputs by computer.
- Directional Gain = $18.5 + 10\log(3) = 23.27\text{dBi} > 6\text{dBi}$, so the limit shall be reduced to $30 - (23.27 - 6) = 12.73\text{dBm}$.
- Refer to section 3.3 for duty cycle spectrum plot.

802.11ac (VHT80)

| TX chain | Chan. | Freq. (MHz) | PSD W/O Duty Factor | | 10 log (N=4) dB | Duty Factor (dB) | Total PSD With Duty Factor (dBm/500kHz) | Limit (dBm/500kHz) | Pass / Fail |
|----------|-------|------------------------|---------------------|--------------|-----------------|------------------|---|--------------------|-------------|
| | | | (dBm/300kHz) | (dBm/500kHz) | | | | | |
| 0 | 138 | 5690 For U-NII-3 | -28.78 | -26.56 | 6.02 | 0.26 | -20.28 | 12.73 | Pass |
| 1 | 138 | 5690 For U-NII-3 | -29.50 | -27.28 | 6.02 | 0.26 | -21.00 | 12.73 | Pass |
| 2 | 138 | 5690 For U-NII-3 | -28.69 | -26.47 | 6.02 | 0.26 | -20.19 | 12.73 | Pass |
| 3 | 138 | 5690 For U-NII-3 | -30.23 | -28.01 | 6.02 | 0.26 | -21.73 | 12.73 | Pass |

Note:

- Method a) of power density measurement of KDB 662911 is using for calculating total power density. Total power density is summing entire spectra across corresponding frequency bins on the various outputs by computer.
- Directional Gain = $18.5 + 10\log(3) = 23.27\text{dBi} > 6\text{dBi}$, so the limit shall be reduced to $30 - (23.27 - 6) = 12.73\text{dBm}$.
- Refer to section 3.3 for duty cycle spectrum plot.

Spectrum Plot of Worst Value

802.11a

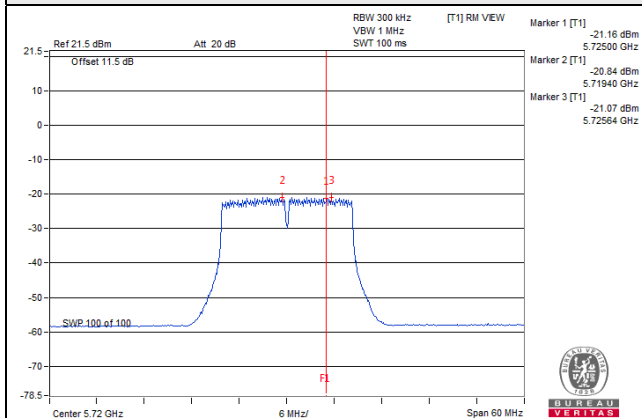

802.11n (HT20)

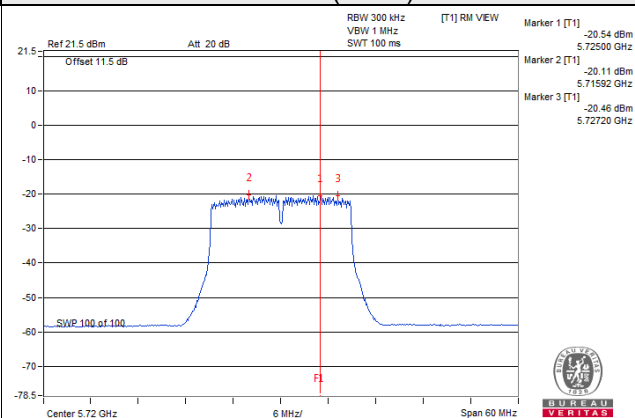

802.11n (HT40)

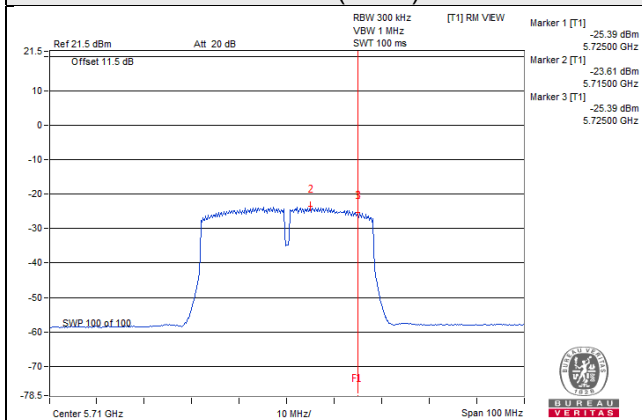

802.11ac (VHT80)

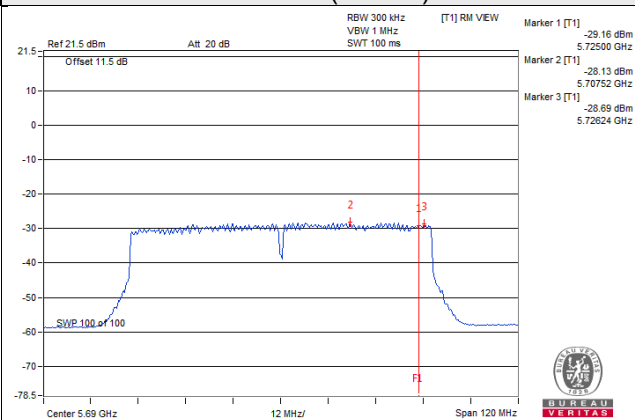

Mode B1

For U-NII-2A, U-NII-2C Band

802.11a

| Chan. | Freq. (MHz) | PSD W/O Duty Factor (dBm/MHz) | | | | Total PSD W/O Duty Factor (dBm/MHz) | Duty Factor (dB) | Total PSD Wth Duty Factor (dBm/MHz) | Max. Limit (dBm/MHz) | Pass / Fail |
|-------|----------------------|-------------------------------|---------|---------|---------|-------------------------------------|------------------|-------------------------------------|----------------------|-------------|
| | | Chain 0 | Chain 1 | Chain 2 | Chain 3 | | | | | |
| 52 | 5260 | -2.64 | -2.98 | -2.24 | -1.95 | 3.58 | 0.21 | 3.79 | 3.98 | Pass |
| 60 | 5300 | -2.58 | -2.72 | -2.23 | -2.04 | 3.64 | 0.21 | 3.85 | 3.98 | Pass |
| 64 | 5320 | -2.46 | -2.58 | -2.39 | -1.72 | 3.75 | 0.21 | 3.96 | 3.98 | Pass |
| 100 | 5500 | -1.76 | -2.91 | -2.01 | -2.78 | 3.68 | 0.21 | 3.89 | 3.98 | Pass |
| 116 | 5580 | -2.70 | -2.56 | -1.95 | -2.40 | 3.63 | 0.21 | 3.84 | 3.98 | Pass |
| 140 | 5700 | -2.40 | -2.79 | -1.99 | -1.93 | 3.76 | 0.21 | 3.97 | 3.98 | Pass |
| 144 | 5720 For U-NII-2C | -2.44 | -2.88 | -1.95 | -1.87 | 3.75 | 0.21 | 3.96 | 3.98 | Pass |

Note:

1. Method a) of power density measurement of KDB 662911 is using for calculating total power density. Total power density is summing entire spectra across corresponding frequency bins on the various outputs by computer.
2. Directional Gain = $7 + 10\log(4) = 13.02\text{dBi} > 6\text{dBi}$, so the limit shall be reduced to $11 - (13.02 - 6) = 3.98\text{dBm}$.
3. Refer to section 3.3 for duty cycle spectrum plot.

802.11n (HT20)

| Chan. | Freq. (MHz) | PSD (dBm/MHz) | | | | Total PSD (dBm/MHz) | Max. Limit (dBm/MHz) | Pass / Fail |
|-------|----------------------|---------------|---------|---------|---------|---------------------|----------------------|-------------|
| | | Chain 0 | Chain 1 | Chain 2 | Chain 3 | | | |
| 52 | 5260 | -2.38 | -3.09 | -2.15 | -2.11 | 3.61 | 3.98 | Pass |
| 60 | 5300 | -2.28 | -2.78 | -1.98 | -2.04 | 3.76 | 3.98 | Pass |
| 64 | 5320 | -2.55 | -2.50 | -2.16 | -2.22 | 3.67 | 3.98 | Pass |
| 100 | 5500 | -2.07 | -2.86 | -2.05 | -2.33 | 3.71 | 3.98 | Pass |
| 116 | 5580 | -2.54 | -2.86 | -1.90 | -2.28 | 3.64 | 3.98 | Pass |
| 140 | 5700 | -2.28 | -2.86 | -1.81 | -2.18 | 3.75 | 3.98 | Pass |
| 144 | 5720 For U-NII-2C | -2.42 | -2.67 | -1.80 | -2.18 | 3.77 | 3.98 | Pass |

Note:

1. Method a) of power density measurement of KDB 662911 is using for calculating total power density. Total power density is summing entire spectra across corresponding frequency bins on the various outputs by computer.
2. Directional Gain = $7 + 10\log(4) = 13.02\text{dBi} > 6\text{dBi}$, so the limit shall be reduced to $11 - (13.02 - 6) = 3.98\text{dBm}$.

802.11n (HT40)

| Chan. | Freq. (MHz) | PSD W/O Duty Factor (dBm/MHz) | | | | Total PSD W/O Duty Factor (dBm/MHz) | Duty Factor (dB) | Total PSD Wth Duty Factor (dBm/MHz) | Max. Limit (dBm/MHz) | Pass / Fail |
|-------|-----------------------|-------------------------------|---------|---------|---------|-------------------------------------|------------------|-------------------------------------|----------------------|-------------|
| | | Chain 0 | Chain 1 | Chain 2 | Chain 3 | | | | | |
| 54 | 5270 | -2.33 | -3.06 | -2.34 | -2.17 | 3.56 | 0.13 | 3.69 | 3.98 | Pass |
| 62 | 5310 | -2.69 | -2.90 | -2.42 | -2.43 | 3.41 | 0.13 | 3.54 | 3.98 | Pass |
| 102 | 5510 | -2.33 | -2.81 | -2.35 | -2.66 | 3.49 | 0.13 | 3.62 | 3.98 | Pass |
| 110 | 5550 | -2.64 | -2.67 | -2.06 | -2.63 | 3.53 | 0.13 | 3.66 | 3.98 | Pass |
| 134 | 5670 | -2.28 | -3.16 | -1.39 | -2.47 | 3.74 | 0.13 | 3.87 | 3.98 | Pass |
| 142 | 5710 For U-NII-2 C | -2.32 | -2.57 | -1.86 | -2.19 | 3.79 | 0.13 | 3.92 | 3.98 | Pass |

Note:

- Method a) of power density measurement of KDB 662911 is using for calculating total power density. Total power density is summing entire spectra across corresponding frequency bins on the various outputs by computer.
- Directional Gain = $7 + 10\log(4) = 13.02\text{dBi} > 6\text{dBi}$, so the limit shall be reduced to $11 - (13.02 - 6) = 3.98\text{dBm}$.
- Refer to section 3.3 for duty cycle spectrum plot.

802.11ac (VHT80)

| Chan. | Freq. (MHz) | PSD W/O Duty Factor (dBm/MHz) | | | | Total PSD W/O Duty Factor (dBm/MHz) | Duty Factor (dB) | Total PSD Wth Duty Factor (dBm/MHz) | Max. Limit (dBm/MHz) | Pass / Fail |
|-------|-----------------------|-------------------------------|---------|---------|---------|-------------------------------------|------------------|-------------------------------------|----------------------|-------------|
| | | Chain 0 | Chain 1 | Chain 2 | Chain 3 | | | | | |
| 58 | 5290 | -8.52 | -8.90 | -7.98 | -8.31 | -2.39 | 0.26 | -2.13 | 3.98 | Pass |
| 106 | 5530 | -10.15 | -11.03 | -10.28 | -10.33 | -4.41 | 0.26 | -4.15 | 3.98 | Pass |
| 122 | 5610 | -3.05 | -2.96 | -2.93 | -1.44 | 3.48 | 0.26 | 3.74 | 3.98 | Pass |
| 138 | 5690 For U-NII-2 C | -6.04 | -6.20 | -5.13 | -5.48 | 0.33 | 0.26 | 0.59 | 3.98 | Pass |

Note:

- Method a) of power density measurement of KDB 662911 is using for calculating total power density. Total power density is summing entire spectra across corresponding frequency bins on the various outputs by computer.
- Directional Gain = $7 + 10\log(4) = 13.02\text{dBi} > 6\text{dBi}$, so the limit shall be reduced to $11 - (13.02 - 6) = 3.98\text{dBm}$.
- Refer to section 3.3 for duty cycle spectrum plot.

Spectrum Plot of Worst Value

802.11a / Chain 3 / CH 64

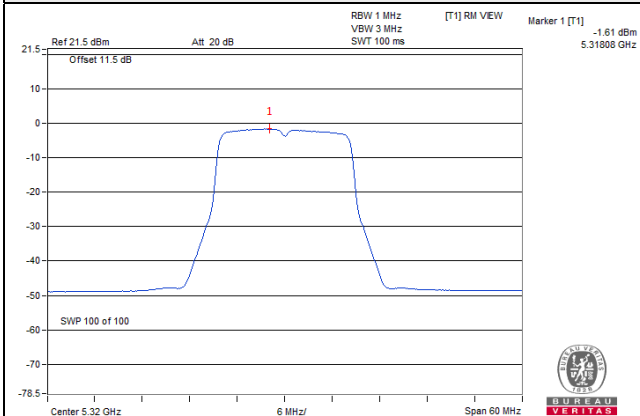

802.11n (HT20) / Chain 2 / CH 144

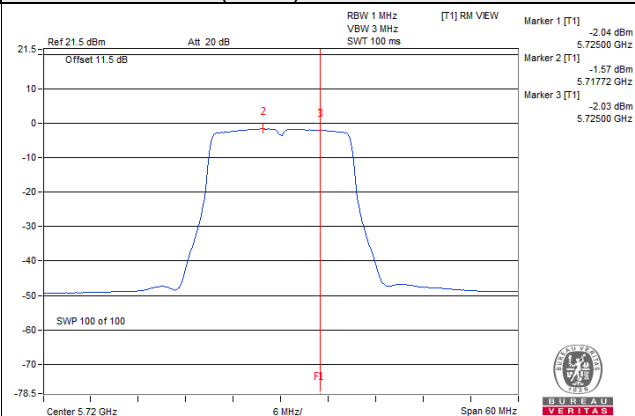

802.11n (HT40) / Chain 2 / CH 134

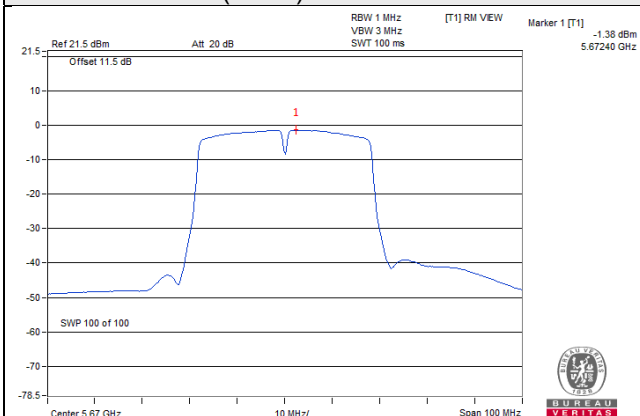

802.11ac (VHT80) / Chain 3 / CH 122

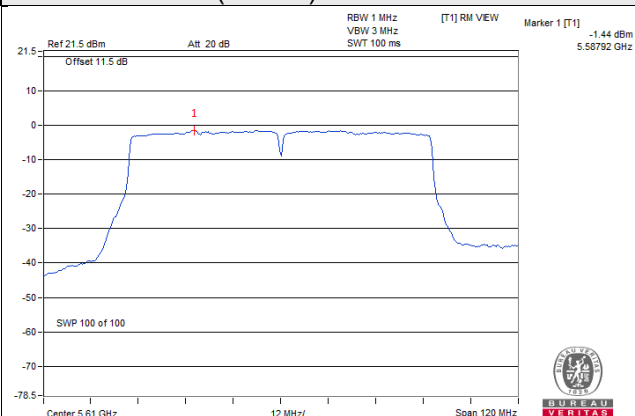

For U-NII-3 Band

802.11a

| TX chain | Chan. | Freq. (MHz) | PSD W/O Duty Factor | | 10 log (N=4) dB | Duty Factor (dB) | Total PSD With Duty Factor (dBm/500kHz) | Limit (dBm/500kHz) | Pass / Fail |
|----------|-------|---------------------|---------------------|--------------|-----------------|------------------|---|--------------------|-------------|
| | | | (dBm/300kHz) | (dBm/500kHz) | | | | | |
| 0 | 144 | 5720 For U-NII-3 | -11.10 | -8.88 | 6.02 | 0.21 | -2.65 | 22.98 | Pass |
| 1 | 144 | 5720 For U-NII-3 | -11.42 | -9.20 | 6.02 | 0.21 | -2.97 | 22.98 | Pass |
| 2 | 144 | 5720 For U-NII-3 | -10.53 | -8.31 | 6.02 | 0.21 | -2.08 | 22.98 | Pass |
| 3 | 144 | 5720 For U-NII-3 | -10.34 | -8.12 | 6.02 | 0.21 | -1.89 | 22.98 | Pass |

Note:

- Method a) of power density measurement of KDB 662911 is using for calculating total power density. Total power density is summing entire spectra across corresponding frequency bins on the various outputs by computer.
- Directional Gain = $7 + 10\log(4) = 13.02\text{dBi} > 6\text{dBi}$, so the limit shall be reduced to $30 - (13.02 - 6) = 22.98\text{dBm}$.
- Refer to section 3.3 for duty cycle spectrum plot.

802.11n (HT20)

| TX chain | Chan. | Freq. (MHz) | PSD W/O Duty Factor | | 10 log (N=4) dB | Total PSD (dBm/500kHz) | Limit (dBm/500kHz) | Pass / Fail |
|----------|-------|---------------------|---------------------|--------------|-----------------|------------------------|--------------------|-------------|
| | | | (dBm/300kHz) | (dBm/500kHz) | | | | |
| 0 | 144 | 5720 For U-NII-3 | -11.20 | -8.98 | 6.02 | -2.96 | 22.98 | Pass |
| 1 | 144 | 5720 For U-NII-3 | -11.42 | -9.20 | 6.02 | -3.18 | 22.98 | Pass |
| 2 | 144 | 5720 For U-NII-3 | -10.60 | -8.38 | 6.02 | -2.36 | 22.98 | Pass |
| 3 | 144 | 5720 For U-NII-3 | -10.99 | -8.77 | 6.02 | -2.75 | 22.98 | Pass |

Note:

- Method a) of power density measurement of KDB 662911 is using for calculating total power density. Total power density is summing entire spectra across corresponding frequency bins on the various outputs by computer.
- Directional Gain = $7 + 10\log(4) = 13.02\text{dBi} > 6\text{dBi}$, so the limit shall be reduced to $30 - (13.02 - 6) = 22.98\text{dBm}$.

802.11n (HT40)

| TX chain | Chan. | Freq. (MHz) | PSD W/O Duty Factor | | 10 log (N=4) dB | Duty Factor (dB) | Total PSD With Duty Factor (dBm/500kHz) | Limit (dBm/500kHz) | Pass / Fail |
|----------|-------|------------------------|---------------------|--------------|-----------------|------------------|---|--------------------|-------------|
| | | | (dBm/300kHz) | (dBm/500kHz) | | | | | |
| 0 | 142 | 5710 For U-NII-3 | -12.98 | -10.76 | 6.02 | 0.13 | -4.61 | 22.98 | Pass |
| 1 | 142 | 5710 For U-NII-3 | -12.55 | -10.33 | 6.02 | 0.13 | -4.18 | 22.98 | Pass |
| 2 | 142 | 5710 For U-NII-3 | -11.90 | -9.68 | 6.02 | 0.13 | -3.53 | 22.98 | Pass |
| 3 | 142 | 5710 For U-NII-3 | -12.38 | -10.16 | 6.02 | 0.13 | -4.01 | 22.98 | Pass |

Note:

- Method a) of power density measurement of KDB 662911 is using for calculating total power density. Total power density is summing entire spectra across corresponding frequency bins on the various outputs by computer.
- Directional Gain = $7 + 10\log(4) = 13.02\text{dBi} > 6\text{dBi}$, so the limit shall be reduced to $30 - (13.02 - 6) = 22.98\text{dBm}$.
- Refer to section 3.3 for duty cycle spectrum plot.

802.11ac (VHT80)

| TX chain | Chan. | Freq. (MHz) | PSD W/O Duty Factor | | 10 log (N=4) dB | Duty Factor (dB) | Total PSD With Duty Factor (dBm/500kHz) | Limit (dBm/500kHz) | Pass / Fail |
|----------|-------|------------------------|---------------------|--------------|-----------------|------------------|---|--------------------|-------------|
| | | | (dBm/300kHz) | (dBm/500kHz) | | | | | |
| 0 | 138 | 5690 For U-NII-3 | -16.08 | -13.86 | 6.02 | 0.26 | -7.58 | 22.98 | Pass |
| 1 | 138 | 5690 For U-NII-3 | -15.87 | -13.65 | 6.02 | 0.26 | -7.37 | 22.98 | Pass |
| 2 | 138 | 5690 For U-NII-3 | -14.93 | -12.71 | 6.02 | 0.26 | -6.43 | 22.98 | Pass |
| 3 | 138 | 5690 For U-NII-3 | -15.58 | -13.36 | 6.02 | 0.26 | -7.08 | 22.98 | Pass |

Note:

- Method a) of power density measurement of KDB 662911 is using for calculating total power density. Total power density is summing entire spectra across corresponding frequency bins on the various outputs by computer.
- Directional Gain = $7 + 10\log(4) = 13.02\text{dBi} > 6\text{dBi}$, so the limit shall be reduced to $30 - (13.02 - 6) = 22.98\text{dBm}$.
- Refer to section 3.3 for duty cycle spectrum plot.

Spectrum Plot of Worst Value

802.11a

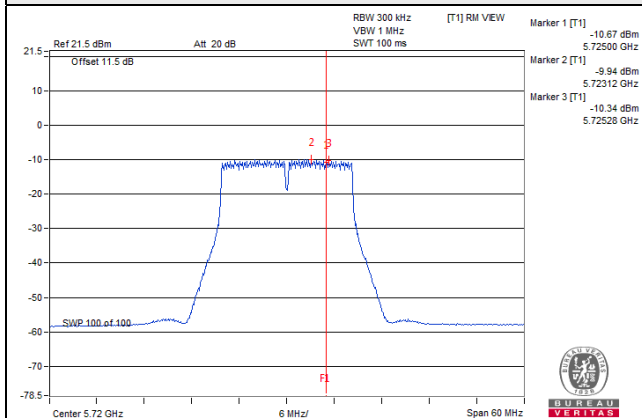

802.11n (HT20)

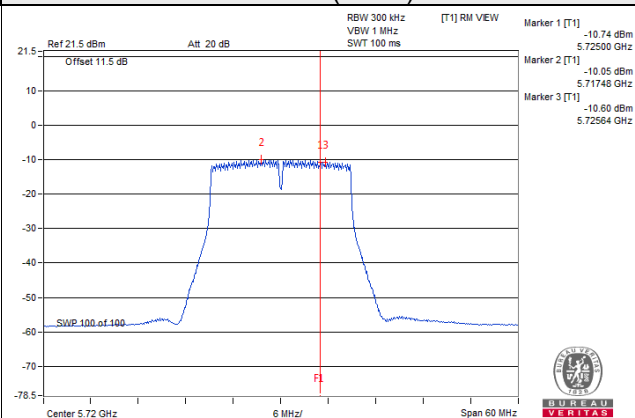

802.11n (HT40)

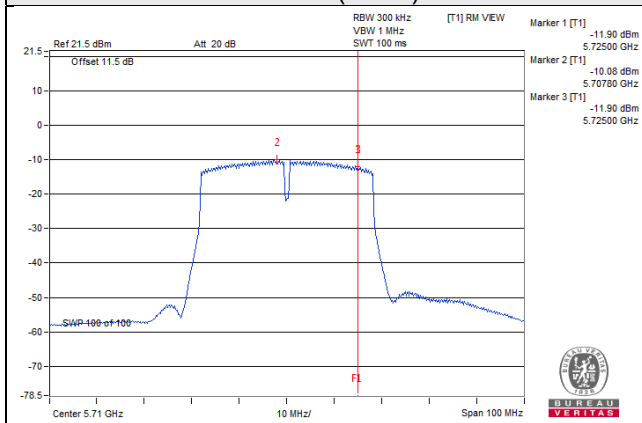

802.11ac (VHT80)

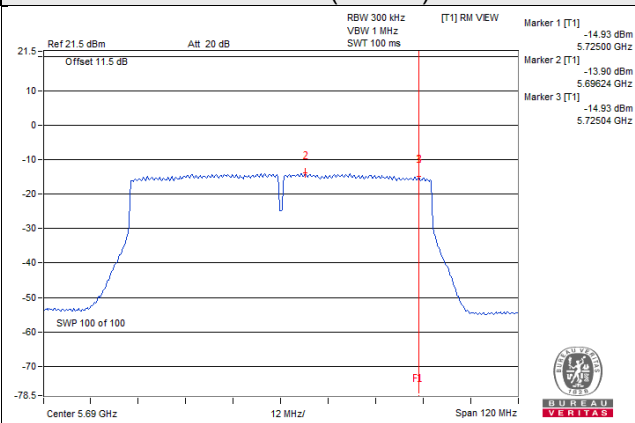

Mode B2
For U-NII-2A, U-NII-2C Band
802.11a

| Chan. | Freq. (MHz) | PSD W/O Duty Factor (dBm/MHz) | | | | Total PSD W/O Duty Factor (dBm/MHz) | Duty Factor (dB) | Total PSD Wth Duty Factor (dBm/MHz) | Max. Limit (dBm/MHz) | Pass / Fail |
|-------|----------------------|-------------------------------|---------|---------|---------|-------------------------------------|------------------|-------------------------------------|----------------------|-------------|
| | | Chain 0 | Chain 1 | Chain 2 | Chain 3 | | | | | |
| 52 | 5260 | -12.39 | -13.57 | -12.34 | -12.24 | -6.58 | 0.17 | -6.41 | -6.27 | Pass |
| 60 | 5300 | -12.43 | -13.29 | -12.32 | -12.36 | -6.56 | 0.17 | -6.39 | -6.27 | Pass |
| 64 | 5320 | -12.55 | -12.97 | -12.35 | -12.45 | -6.55 | 0.17 | -6.38 | -6.27 | Pass |
| 100 | 5500 | -12.48 | -13.70 | -12.76 | -13.09 | -6.96 | 0.17 | -6.79 | -6.27 | Pass |
| 116 | 5580 | -12.69 | -13.95 | -12.54 | -12.93 | -6.98 | 0.17 | -6.81 | -6.27 | Pass |
| 140 | 5700 | -12.34 | -13.87 | -11.91 | -12.42 | -6.56 | 0.17 | -6.39 | -6.27 | Pass |
| 144 | 5720 For U-NII-2C | -13.38 | -12.67 | -12.12 | -12.87 | -6.72 | 0.17 | -6.55 | -6.27 | Pass |

Note:

- Method a) of power density measurement of KDB 662911 is using for calculating total power density. Total power density is summing entire spectra across corresponding frequency bins on the various outputs by computer.
- Directional Gain = $18.5 + 10\log(3) = 23.27\text{dBi} > 6\text{dBi}$, so the limit shall be reduced to $11 - (23.27 - 6) = -6.27\text{dBm}$.
- Refer to section 3.3 for duty cycle spectrum plot.

802.11n (HT20)

| Chan. | Freq. (MHz) | PSD (dBm/MHz) | | | | Total PSD (dBm/MHz) | Max. Limit (dBm/MHz) | Pass / Fail |
|-------|----------------------|---------------|---------|---------|---------|---------------------|----------------------|-------------|
| | | Chain 0 | Chain 1 | Chain 2 | Chain 3 | | | |
| 52 | 5260 | -12.28 | -13.33 | -12.14 | -12.09 | -6.41 | -6.27 | Pass |
| 60 | 5300 | -12.21 | -13.02 | -11.96 | -12.09 | -6.28 | -6.27 | Pass |
| 64 | 5320 | -12.42 | -12.84 | -12.16 | -12.31 | -6.41 | -6.27 | Pass |
| 100 | 5500 | -11.91 | -12.79 | -12.20 | -12.42 | -6.30 | -6.27 | Pass |
| 116 | 5580 | -12.06 | -13.21 | -11.84 | -12.38 | -6.32 | -6.27 | Pass |
| 140 | 5700 | -12.35 | -12.82 | -12.00 | -12.25 | -6.32 | -6.27 | Pass |
| 144 | 5720 For U-NII-2C | -13.11 | -12.85 | -11.58 | -12.52 | -6.45 | -6.27 | Pass |

Note:

- Method a) of power density measurement of KDB 662911 is using for calculating total power density. Total power density is summing entire spectra across corresponding frequency bins on the various outputs by computer.
- Directional Gain = $18.5 + 10\log(3) = 23.27\text{dBi} > 6\text{dBi}$, so the limit shall be reduced to $11 - (23.27 - 6) = -6.27\text{dBm}$.

802.11n (HT40)

| Chan. | Freq. (MHz) | PSD W/O Duty Factor (dBm/MHz) | | | | Total PSD W/O Duty Factor (dBm/MHz) | Duty Factor (dB) | Total PSD Wth Duty Factor (dBm/MHz) | Max. Limit (dBm/MHz) | Pass / Fail |
|-------|-----------------------------|-------------------------------|---------|---------|---------|-------------------------------------|------------------|-------------------------------------|----------------------|-------------|
| | | Chain 0 | Chain 1 | Chain 2 | Chain 3 | | | | | |
| 54 | 5270 | -13.33 | -13.35 | -13.08 | -14.31 | -7.47 | 0.13 | -7.34 | -6.27 | Pass |
| 62 | 5310 | -13.92 | -13.84 | -13.26 | -14.81 | -7.91 | 0.13 | -7.78 | -6.27 | Pass |
| 102 | 5510 | -13.91 | -13.49 | -13.81 | -14.00 | -7.78 | 0.13 | -7.65 | -6.27 | Pass |
| 110 | 5550 | -13.56 | -13.31 | -13.78 | -14.56 | -7.76 | 0.13 | -7.63 | -6.27 | Pass |
| 134 | 5670 | -13.35 | -13.33 | -12.76 | -14.46 | -7.41 | 0.13 | -7.28 | -6.27 | Pass |
| 142 | 5710 For U-NII-2 C | -15.58 | -15.21 | -14.55 | -15.21 | -9.10 | 0.13 | -8.97 | -6.27 | Pass |

Note:

- Method a) of power density measurement of KDB 662911 is using for calculating total power density. Total power density is summing entire spectra across corresponding frequency bins on the various outputs by computer.
- Directional Gain = $18.5 + 10\log(3) = 23.27\text{dBi} > 6\text{dBi}$, so the limit shall be reduced to $11 - (23.27 - 6) = -6.27\text{dBm}$.
- Refer to section 3.3 for duty cycle spectrum plot.

802.11ac (VHT80)

| Chan. | Freq. (MHz) | PSD W/O Duty Factor (dBm/MHz) | | | | Total PSD W/O Duty Factor (dBm/MHz) | Duty Factor (dB) | Total PSD Wth Duty Factor (dBm/MHz) | Max. Limit (dBm/MHz) | Pass / Fail |
|-------|-----------------------------|-------------------------------|---------|---------|---------|-------------------------------------|------------------|-------------------------------------|----------------------|-------------|
| | | Chain 0 | Chain 1 | Chain 2 | Chain 3 | | | | | |
| 58 | 5290 | -16.97 | -16.73 | -16.94 | -17.65 | -11.04 | 0.26 | -10.78 | -6.27 | Pass |
| 106 | 5530 | -17.94 | -16.98 | -16.97 | -17.17 | -11.23 | 0.26 | -10.97 | -6.27 | Pass |
| 122 | 5610 | -17.37 | -16.62 | -17.62 | -17.84 | -11.32 | 0.26 | -11.06 | -6.27 | Pass |
| 138 | 5690 For U-NII-2 C | -20.33 | -20.60 | -19.29 | -20.73 | -14.16 | 0.26 | -13.90 | -6.27 | Pass |

Note:

- Method a) of power density measurement of KDB 662911 is using for calculating total power density. Total power density is summing entire spectra across corresponding frequency bins on the various outputs by computer.
- Directional Gain = $18.5 + 10\log(3) = 23.27\text{dBi} > 6\text{dBi}$, so the limit shall be reduced to $11 - (23.27 - 6) = -6.27\text{dBm}$.
- Refer to section 3.3 for duty cycle spectrum plot.

Spectrum Plot of Worst Value

802.11a / Chain 2 / CH 140

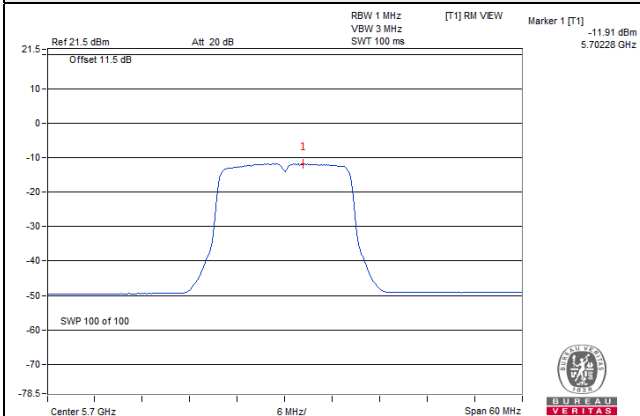

802.11n (HT20) / Chain 2 / CH 144

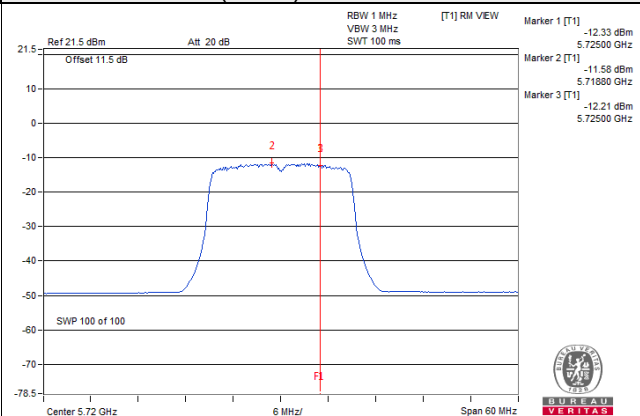

802.11n (HT40) / Chain 2 / CH 134

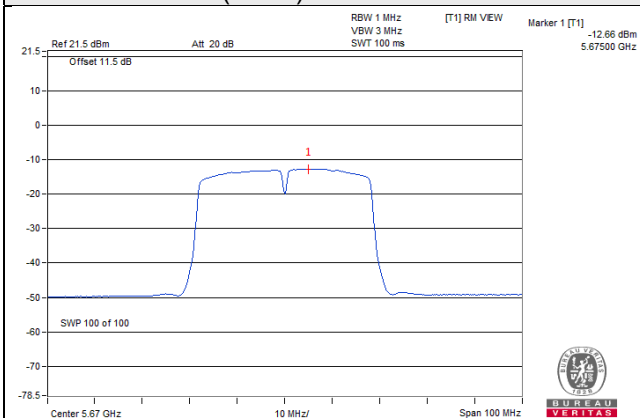

802.11ac (VHT80) / Chain 1 / CH 122

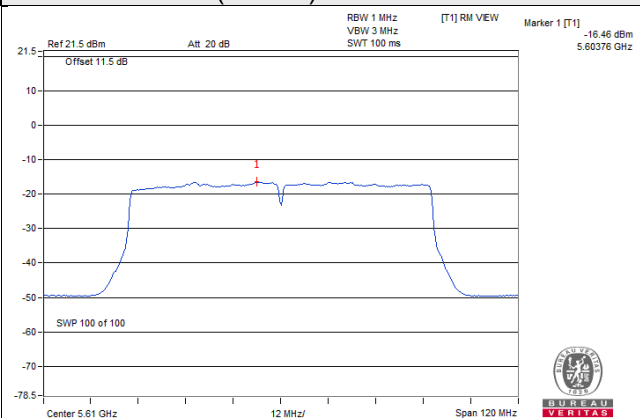

For U-NII-3 Band

802.11a

| TX chain | Chan. | Freq. (MHz) | PSD W/O Duty Factor | | 10 log (N=4) dB | Duty Factor (dB) | Total PSD With Duty Factor (dBm/500kHz) | Limit (dBm/500kHz) | Pass / Fail |
|----------|-------|---------------------|---------------------|--------------|-----------------|------------------|---|--------------------|-------------|
| | | | (dBm/300kHz) | (dBm/500kHz) | | | | | |
| 0 | 144 | 5720 For U-NII-3 | -22.09 | -19.87 | 6.02 | 0.17 | -13.68 | 12.73 | Pass |
| 1 | 144 | 5720 For U-NII-3 | -21.67 | -19.45 | 6.02 | 0.17 | -13.26 | 12.73 | Pass |
| 2 | 144 | 5720 For U-NII-3 | -21.30 | -19.08 | 6.02 | 0.17 | -12.89 | 12.73 | Pass |
| 3 | 144 | 5720 For U-NII-3 | -21.64 | -19.42 | 6.02 | 0.17 | -13.23 | 12.73 | Pass |

Note:

- Method a) of power density measurement of KDB 662911 is using for calculating total power density. Total power density is summing entire spectra across corresponding frequency bins on the various outputs by computer.
- Directional Gain = $18.5 + 10\log(3) = 23.27\text{dBi} > 6\text{dBi}$, so the limit shall be reduced to $30 - (23.27 - 6) = 12.73\text{dBm}$.
- Refer to section 3.3 for duty cycle spectrum plot.

802.11n (HT20)

| TX chain | Chan. | Freq. (MHz) | PSD W/O Duty Factor | | 10 log (N=4) dB | Total PSD (dBm/500kHz) | Limit (dBm/500kHz) | Pass / Fail |
|----------|-------|---------------------|---------------------|--------------|-----------------|------------------------|--------------------|-------------|
| | | | (dBm/300kHz) | (dBm/500kHz) | | | | |
| 0 | 144 | 5720 For U-NII-3 | -21.74 | -19.52 | 6.02 | -13.50 | 12.73 | Pass |
| 1 | 144 | 5720 For U-NII-3 | -21.87 | -19.65 | 6.02 | -13.63 | 12.73 | Pass |
| 2 | 144 | 5720 For U-NII-3 | -20.61 | -18.39 | 6.02 | -12.37 | 12.73 | Pass |
| 3 | 144 | 5720 For U-NII-3 | -21.04 | -18.82 | 6.02 | -12.80 | 12.73 | Pass |

Note:

- Method a) of power density measurement of KDB 662911 is using for calculating total power density. Total power density is summing entire spectra across corresponding frequency bins on the various outputs by computer.
- Directional Gain = $18.5 + 10\log(3) = 23.27\text{dBi} > 6\text{dBi}$, so the limit shall be reduced to $30 - (23.27 - 6) = 12.73\text{dBm}$.

802.11n (HT40)

| TX chain | Chan. | Freq. (MHz) | PSD W/O Duty Factor | | 10 log (N=4) dB | Duty Factor (dB) | Total PSD With Duty Factor (dBm/500kHz) | Limit (dBm/500kHz) | Pass / Fail |
|----------|-------|------------------------|---------------------|--------------|-----------------|------------------|---|--------------------|-------------|
| | | | (dBm/300kHz) | (dBm/500kHz) | | | | | |
| 0 | 142 | 5710 For U-NII-3 | -25.97 | -23.75 | 6.02 | 0.13 | -17.60 | 12.73 | Pass |
| 1 | 142 | 5710 For U-NII-3 | -25.19 | -22.97 | 6.02 | 0.13 | -16.82 | 12.73 | Pass |
| 2 | 142 | 5710 For U-NII-3 | -24.95 | -22.73 | 6.02 | 0.13 | -16.58 | 12.73 | Pass |
| 3 | 142 | 5710 For U-NII-3 | -25.17 | -22.95 | 6.02 | 0.13 | -16.80 | 12.73 | Pass |

Note:

- Method a) of power density measurement of KDB 662911 is using for calculating total power density. Total power density is summing entire spectra across corresponding frequency bins on the various outputs by computer.
- Directional Gain = $18.5 + 10\log(3) = 23.27\text{dBi} > 6\text{dBi}$, so the limit shall be reduced to $30 - (23.27 - 6) = 12.73\text{dBm}$.
- Refer to section 3.3 for duty cycle spectrum plot.

802.11ac (VHT80)

| TX chain | Chan. | Freq. (MHz) | PSD W/O Duty Factor | | 10 log (N=4) dB | Duty Factor (dB) | Total PSD With Duty Factor (dBm/500kHz) | Limit (dBm/500kHz) | Pass / Fail |
|----------|-------|------------------------|---------------------|--------------|-----------------|------------------|---|--------------------|-------------|
| | | | (dBm/300kHz) | (dBm/500kHz) | | | | | |
| 0 | 138 | 5690 For U-NII-3 | -29.08 | -26.86 | 6.02 | 0.26 | -20.58 | 12.73 | Pass |
| 1 | 138 | 5690 For U-NII-3 | -29.79 | -27.57 | 6.02 | 0.26 | -21.29 | 12.73 | Pass |
| 2 | 138 | 5690 For U-NII-3 | -29.03 | -26.81 | 6.02 | 0.26 | -20.53 | 12.73 | Pass |
| 3 | 138 | 5690 For U-NII-3 | -29.98 | -27.76 | 6.02 | 0.26 | -21.48 | 12.73 | Pass |

Note:

- Method a) of power density measurement of KDB 662911 is using for calculating total power density. Total power density is summing entire spectra across corresponding frequency bins on the various outputs by computer.
- Directional Gain = $18.5 + 10\log(3) = 23.27\text{dBi} > 6\text{dBi}$, so the limit shall be reduced to $30 - (23.27 - 6) = 12.73\text{dBm}$.
- Refer to section 3.3 for duty cycle spectrum plot.

Spectrum Plot of Worst Value

802.11a

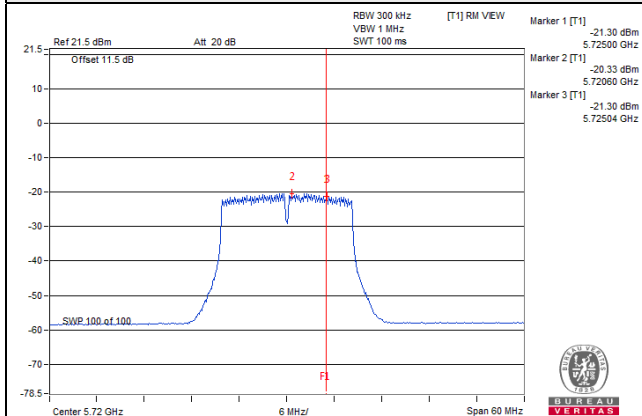

802.11n (HT20)

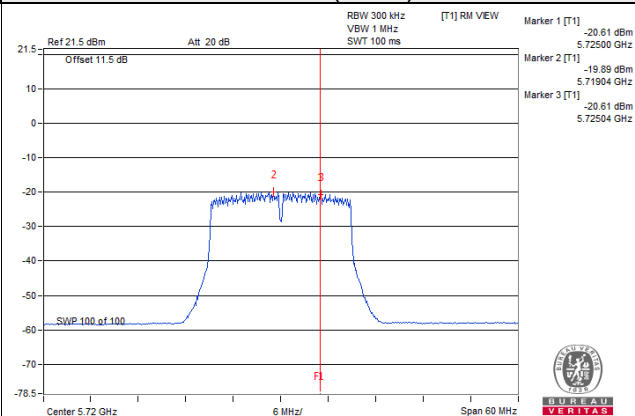

802.11n (HT40)

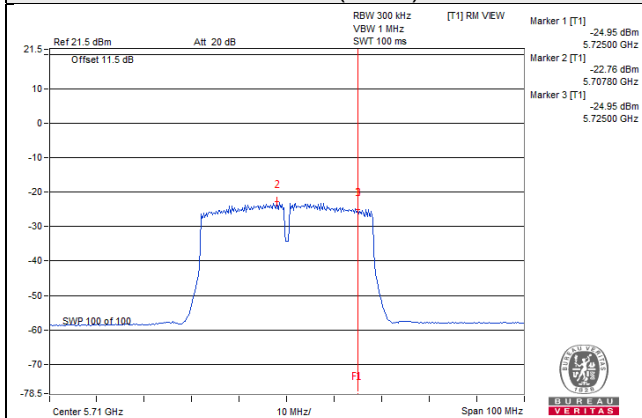

802.11ac (VHT80)

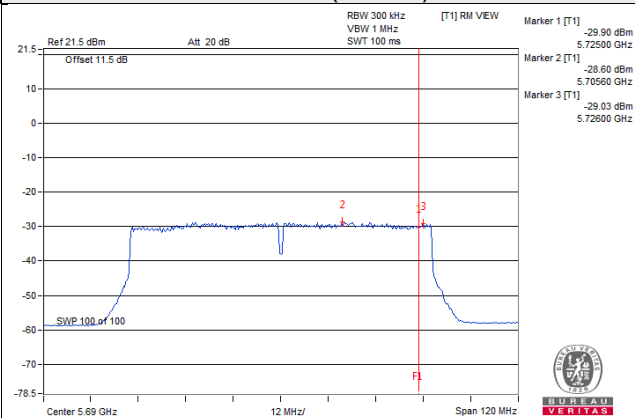

4.6 Frequency Stability

4.6.1 Limits of Frequency Stability Measurement

The frequency of the carrier signal shall be maintained within band of operation

4.6.2 Test Setup

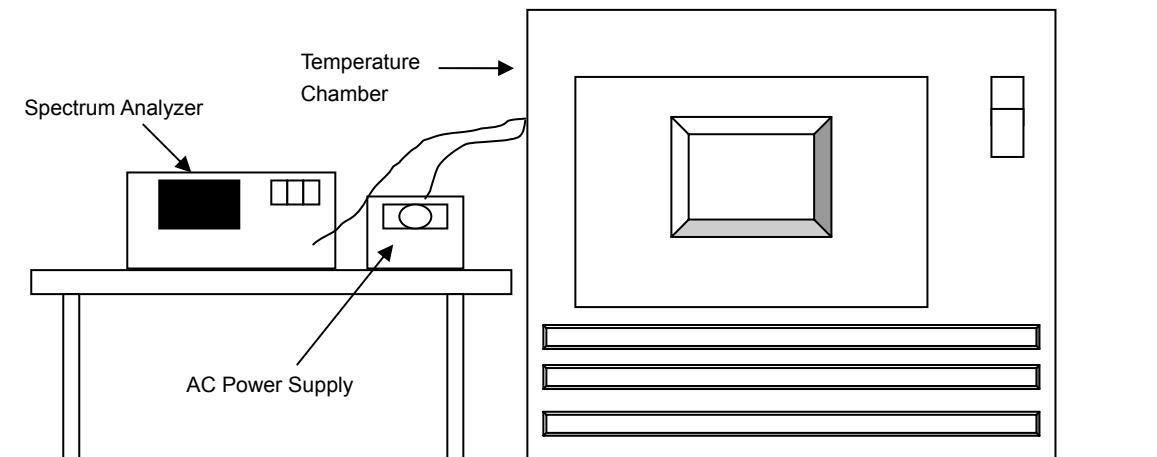

4.6.3 Test Instruments

Refer to section 4.1.2 to get information of above instrument.

4.6.4 Test Procedure

- The EUT was placed inside the environmental test chamber and powered by nominal AC voltage.
- Turn the EUT on and couple its output to a spectrum analyzer.
- Turn the EUT off and set the chamber to the highest temperature specified.
- Allow sufficient time (approximately 30 min) for the temperature of the chamber to stabilize, turn the EUT on and measure the operating frequency after 2, 5, and 10 minutes.
- Repeat step 2 and 3 with the temperature chamber set to the lowest temperature.
- The test chamber was allowed to stabilize at +20 degree C for a minimum of 30 minutes. The supply voltage was then adjusted on the EUT from 85% to 115% and the frequency record.

4.6.5 Deviation from Test Standard

No deviation.

4.6.6 EUT Operating Condition

Set the EUT transmit at un-modulation mode to test frequency stability.

4.6.7 Test Results

Mode A1, B1

| Frequency Stability Versus Temp. | | | | | | | | | |
|----------------------------------|--------------------|--------------------------|---------------------|--------------------------|---------------------|--------------------------|---------------------|--------------------------|---------------------|
| Operating Frequency: 5260MHz | | | | | | | | | |
| Temp. (°C) | Power Supply (Vac) | 0 Minute | | 2 Minute | | 5 Minute | | 10 Minute | |
| | | Measured Frequency (MHz) | Frequency Drift (%) | Measured Frequency (MHz) | Frequency Drift (%) | Measured Frequency (MHz) | Frequency Drift (%) | Measured Frequency (MHz) | Frequency Drift (%) |
| 50 | 120 | 5260.0175 | 0.00033 | 5260.0186 | 0.00035 | 5260.0153 | 0.00029 | 5260.0186 | 0.00035 |
| 40 | 120 | 5259.9979 | -0.00004 | 5259.9968 | -0.00006 | 5259.9996 | -0.00001 | 5259.9975 | -0.00005 |
| 30 | 120 | 5259.9808 | -0.00037 | 5259.9825 | -0.00033 | 5259.9848 | -0.00029 | 5259.9832 | -0.00032 |
| 20 | 120 | 5260.0214 | 0.00041 | 5260.0235 | 0.00045 | 5260.0229 | 0.00044 | 5260.0257 | 0.00049 |
| 10 | 120 | 5259.9976 | -0.00005 | 5259.9973 | -0.00005 | 5259.9955 | -0.00009 | 5259.9963 | -0.00007 |
| 0 | 120 | 5260.022 | 0.00042 | 5260.0184 | 0.00035 | 5260.0205 | 0.00039 | 5260.0193 | 0.00037 |
| -10 | 120 | 5259.9834 | -0.00032 | 5259.984 | -0.00030 | 5259.9866 | -0.00025 | 5259.9828 | -0.00033 |
| -20 | 120 | 5260.0022 | 0.00004 | 5260.0028 | 0.00005 | 5260.005 | 0.00010 | 5260.0049 | 0.00009 |
| -30 | 120 | 5259.9773 | -0.00043 | 5259.9767 | -0.00044 | 5259.9757 | -0.00046 | 5259.9797 | -0.00039 |

| Frequency Stability Versus Voltage | | | | | | | | | |
|------------------------------------|--------------------|--------------------------|---------------------|--------------------------|---------------------|--------------------------|---------------------|--------------------------|---------------------|
| Operating Frequency: 5260MHz | | | | | | | | | |
| Temp. (°C) | Power Supply (Vac) | 0 Minute | | 2 Minute | | 5 Minute | | 10 Minute | |
| | | Measured Frequency (MHz) | Frequency Drift (%) | Measured Frequency (MHz) | Frequency Drift (%) | Measured Frequency (MHz) | Frequency Drift (%) | Measured Frequency (MHz) | Frequency Drift (%) |
| 20 | 138 | 5260.0223 | 0.00042 | 5260.0238 | 0.00045 | 5260.0223 | 0.00042 | 5260.0253 | 0.00048 |
| | 120 | 5260.0214 | 0.00041 | 5260.0235 | 0.00045 | 5260.0229 | 0.00044 | 5260.0257 | 0.00049 |
| | 102 | 5260.0204 | 0.00039 | 5260.0225 | 0.00043 | 5260.0233 | 0.00044 | 5260.0253 | 0.00048 |

Mode A2, B2

| Frequency Stability Versus Temp. | | | | | | | | | |
|----------------------------------|--------------------|--------------------------|---------------------|--------------------------|---------------------|--------------------------|---------------------|--------------------------|---------------------|
| Operating Frequency: 5260MHz | | | | | | | | | |
| Temp. (°C) | Power Supply (Vac) | 0 Minute | | 2 Minute | | 5 Minute | | 10 Minute | |
| | | Measured Frequency (MHz) | Frequency Drift (%) | Measured Frequency (MHz) | Frequency Drift (%) | Measured Frequency (MHz) | Frequency Drift (%) | Measured Frequency (MHz) | Frequency Drift (%) |
| 50 | 120 | 5260.0261 | 0.00050 | 5260.0255 | 0.00048 | 5260.0252 | 0.00048 | 5260.0255 | 0.00048 |
| 40 | 120 | 5259.9977 | -0.00004 | 5259.9974 | -0.00005 | 5259.9985 | -0.00003 | 5259.9996 | -0.00001 |
| 30 | 120 | 5259.9769 | -0.00044 | 5259.9776 | -0.00043 | 5259.9756 | -0.00046 | 5259.977 | -0.00044 |
| 20 | 120 | 5259.9776 | -0.00043 | 5259.9773 | -0.00043 | 5259.9794 | -0.00039 | 5259.9775 | -0.00043 |
| 10 | 120 | 5260.0192 | 0.00037 | 5260.0168 | 0.00032 | 5260.0193 | 0.00037 | 5260.0184 | 0.00035 |
| 0 | 120 | 5259.984 | -0.00030 | 5259.9832 | -0.00032 | 5259.9824 | -0.00033 | 5259.9828 | -0.00033 |
| -10 | 120 | 5259.9953 | -0.00009 | 5259.9939 | -0.00012 | 5259.9952 | -0.00009 | 5259.9958 | -0.00008 |
| -20 | 120 | 5260.0245 | 0.00047 | 5260.0226 | 0.00043 | 5260.0224 | 0.00043 | 5260.0222 | 0.00042 |
| -30 | 120 | 5259.998 | -0.00004 | 5259.997 | -0.00006 | 5259.9952 | -0.00009 | 5259.997 | -0.00006 |

| Frequency Stability Versus Voltage | | | | | | | | | |
|------------------------------------|--------------------|--------------------------|---------------------|--------------------------|---------------------|--------------------------|---------------------|--------------------------|---------------------|
| Operating Frequency: 5260MHz | | | | | | | | | |
| Temp. (°C) | Power Supply (Vac) | 0 Minute | | 2 Minute | | 5 Minute | | 10 Minute | |
| | | Measured Frequency (MHz) | Frequency Drift (%) | Measured Frequency (MHz) | Frequency Drift (%) | Measured Frequency (MHz) | Frequency Drift (%) | Measured Frequency (MHz) | Frequency Drift (%) |
| 20 | 138 | 5259.9778 | -0.00042 | 5259.9784 | -0.00041 | 5259.9793 | -0.00039 | 5259.9782 | -0.00041 |
| | 120 | 5259.9776 | -0.00043 | 5259.9773 | -0.00043 | 5259.9794 | -0.00039 | 5259.9775 | -0.00043 |
| | 102 | 5259.9768 | -0.00044 | 5259.9778 | -0.00042 | 5259.9796 | -0.00039 | 5259.9784 | -0.00041 |

4.7 6dB Bandwidth Measurement

4.7.1 Limits of 6dB Bandwidth Measurement

The minimum of 6dB Bandwidth Measurement is 0.5MHz.

4.7.2 Test Setup

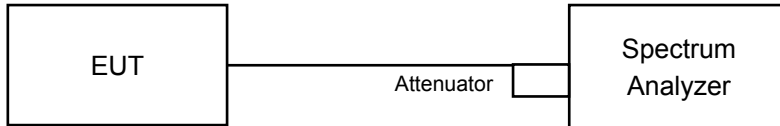

4.7.3 Test Instruments

Refer to section 4.1.2 to get information of above instrument.

4.7.4 Test Procedure

Measurement Procedure REF

- Set resolution bandwidth (RBW) = 100kHz
- Set the video bandwidth (VBW) $\geq 3 \times$ RBW, Detector = Peak.
- Trace mode = max hold.
- Sweep = auto couple.
- Measure the maximum width of the emission that is constrained by the frequencies associated with the two amplitude points (upper and lower) that are attenuated by 6 dB relative to the maximum level measured in the fundamental emission

4.7.5 Deviation from Test Standard

No deviation.

4.7.6 EUT Operating Condition

The software provided by client to enable the EUT under transmission condition continuously at lowest, middle and highest channel frequencies individually.

4.7.7 Test Results

Mode A1

802.11a

| Chan. | Freq. (MHz) | 6dB Bandwidth (MHz) | | | | Minimum Limit (MHz) | Pass / Fail |
|-------|---------------------|---------------------|---------|---------|---------|---------------------|-------------|
| | | Chain 0 | Chain 1 | Chain 2 | Chain 3 | | |
| 144 | 5720 For U-NII-3 | 2.92 | 3.16 | 3.17 | 3.18 | 0.5 | Pass |

802.11n (HT20)

| Chan. | Freq. (MHz) | 6dB Bandwidth (MHz) | | | | Minimum Limit (MHz) | Pass / Fail |
|-------|---------------------|---------------------|---------|---------|---------|---------------------|-------------|
| | | Chain 0 | Chain 1 | Chain 2 | Chain 3 | | |
| 144 | 5720 For U-NII-3 | 3.15 | 3.39 | 3.41 | 3.76 | 0.5 | Pass |

802.11n (HT40)

| Chan. | Freq. (MHz) | 6dB Bandwidth (MHz) | | | | Minimum Limit (MHz) | Pass / Fail |
|-------|---------------------|---------------------|---------|---------|---------|---------------------|-------------|
| | | Chain 0 | Chain 1 | Chain 2 | Chain 3 | | |
| 142 | 5710 For U-NII-3 | 2.60 | 2.52 | 2.58 | 2.55 | 0.5 | Pass |

802.11ac (VHT80)

| Chan. | Freq. (MHz) | 6dB Bandwidth (MHz) | | | | Minimum Limit (MHz) | Pass / Fail |
|-------|---------------------|---------------------|---------|---------|---------|---------------------|-------------|
| | | Chain 0 | Chain 1 | Chain 2 | Chain 3 | | |
| 138 | 5690 For U-NII-3 | 2.76 | 2.72 | 2.78 | 2.74 | 0.5 | Pass |

Spectrum Plot of Worst Value

802.11a

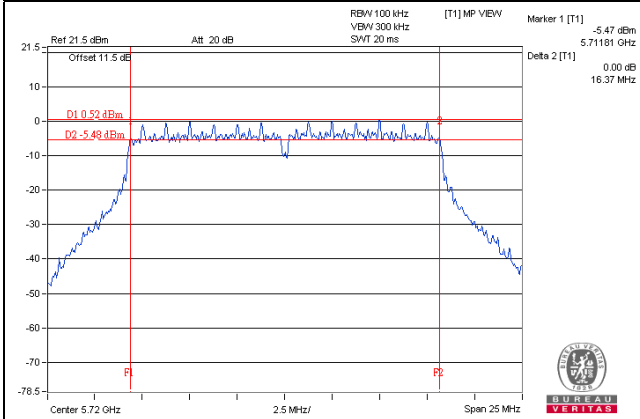

802.11n (HT20)

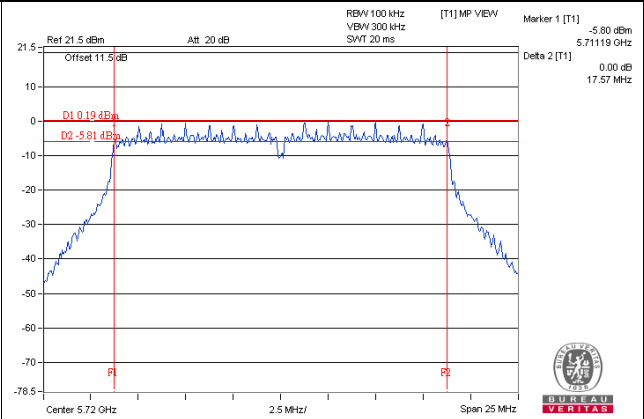

802.11n (HT40)

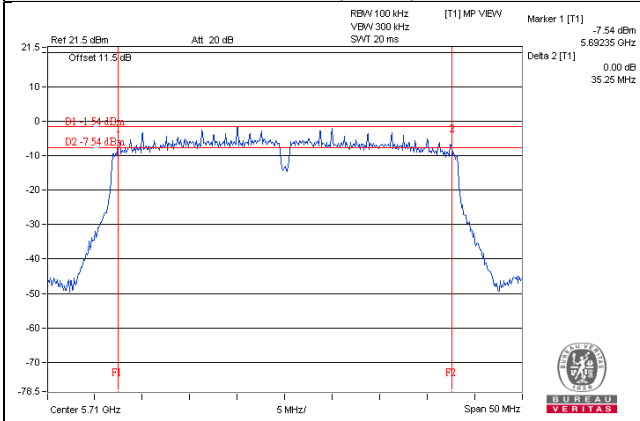

802.11ac (VHT80)

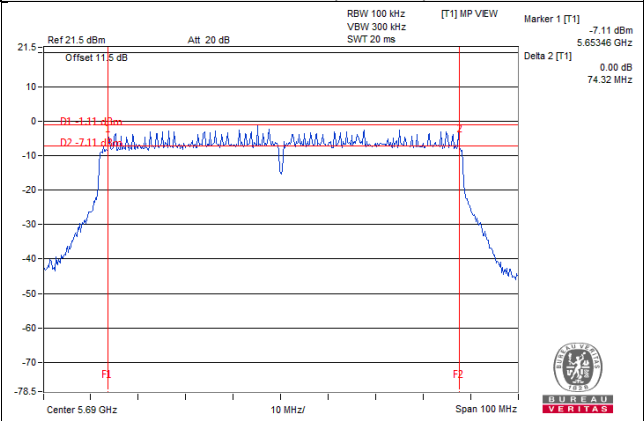

Note: For CH144, CH142, CH138 (UNII-3 Band):

The 6dB bandwidth above 5725MHz = Marker 1 + Delta 2 - 5725MHz

Mode A2

802.11a

| Chan. | Freq. (MHz) | 6dB Bandwidth (MHz) | | | | Minimum Limit (MHz) | Pass / Fail |
|-------|---------------------|---------------------|---------|---------|---------|---------------------|-------------|
| | | Chain 0 | Chain 1 | Chain 2 | Chain 3 | | |
| 144 | 5720 For U-NII-3 | 3.18 | 3.18 | 3.19 | 3.18 | 0.5 | Pass |

802.11n (HT20)

| Chan. | Freq. (MHz) | 6dB Bandwidth (MHz) | | | | Minimum Limit (MHz) | Pass / Fail |
|-------|---------------------|---------------------|---------|---------|---------|---------------------|-------------|
| | | Chain 0 | Chain 1 | Chain 2 | Chain 3 | | |
| 144 | 5720 For U-NII-3 | 3.42 | 3.55 | 3.80 | 3.80 | 0.5 | Pass |

802.11n (HT40)

| Chan. | Freq. (MHz) | 6dB Bandwidth (MHz) | | | | Minimum Limit (MHz) | Pass / Fail |
|-------|---------------------|---------------------|---------|---------|---------|---------------------|-------------|
| | | Chain 0 | Chain 1 | Chain 2 | Chain 3 | | |
| 142 | 5710 For U-NII-3 | 2.63 | 2.63 | 2.66 | 2.62 | 0.5 | Pass |

802.11ac (VHT80)

| Chan. | Freq. (MHz) | 6dB Bandwidth (MHz) | | | | Minimum Limit (MHz) | Pass / Fail |
|-------|---------------------|---------------------|---------|---------|---------|---------------------|-------------|
| | | Chain 0 | Chain 1 | Chain 2 | Chain 3 | | |
| 138 | 5690 For U-NII-3 | 2.74 | 2.72 | 2.75 | 2.75 | 0.5 | Pass |

Spectrum Plot of Worst Value

802.11a

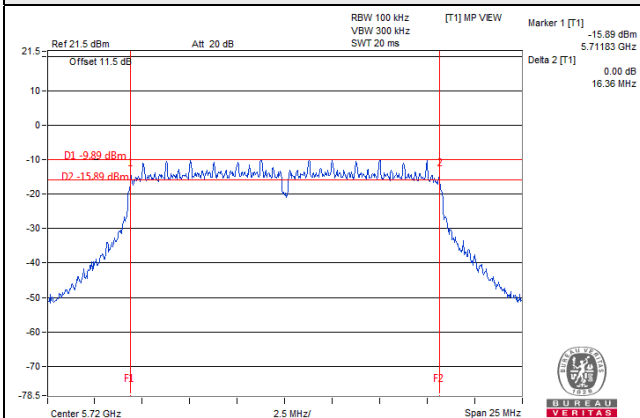

802.11n (HT20)

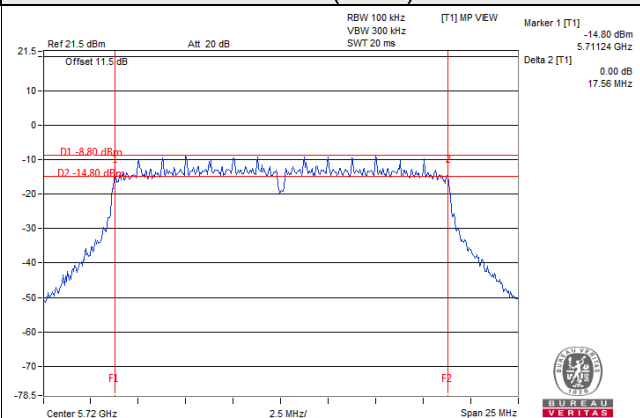

802.11n (HT40)

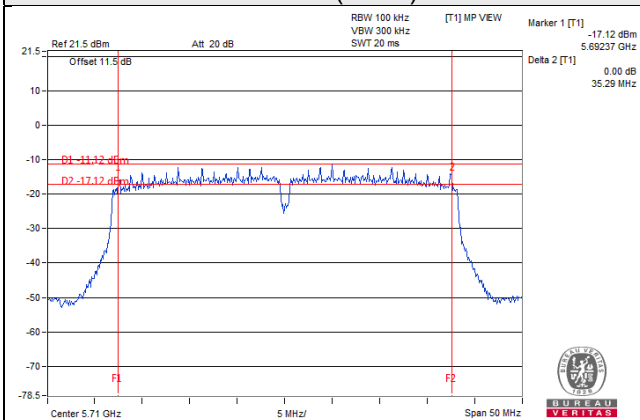

802.11ac (VHT80)

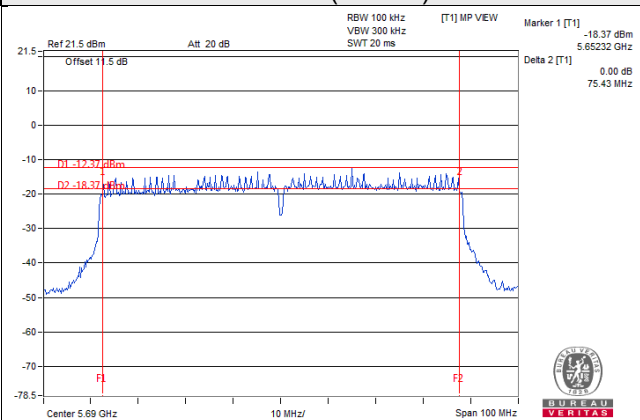

Note: For CH144, CH142, CH138 (UNII-3 Band):

The 6dB bandwidth above 5725MHz = Marker 1 + Delta 2 - 5725MHz

Mode B1
802.11a

| Chan. | Freq. (MHz) | 6dB Bandwidth (MHz) | | | | Minimum Limit (MHz) | Pass / Fail |
|-------|---------------------|---------------------|---------|---------|---------|---------------------|-------------|
| | | Chain 0 | Chain 1 | Chain 2 | Chain 3 | | |
| 144 | 5720 For U-NII-3 | 3.16 | 3.16 | 3.16 | 3.17 | 0.5 | Pass |

802.11n (HT20)

| Chan. | Freq. (MHz) | 6dB Bandwidth (MHz) | | | | Minimum Limit (MHz) | Pass / Fail |
|-------|---------------------|---------------------|---------|---------|---------|---------------------|-------------|
| | | Chain 0 | Chain 1 | Chain 2 | Chain 3 | | |
| 144 | 5720 For U-NII-3 | 3.77 | 3.79 | 3.40 | 3.77 | 0.5 | Pass |

802.11n (HT40)

| Chan. | Freq. (MHz) | 6dB Bandwidth (MHz) | | | | Minimum Limit (MHz) | Pass / Fail |
|-------|---------------------|---------------------|---------|---------|---------|---------------------|-------------|
| | | Chain 0 | Chain 1 | Chain 2 | Chain 3 | | |
| 142 | 5710 For U-NII-3 | 2.62 | 2.55 | 2.54 | 2.54 | 0.5 | Pass |

802.11ac (VHT80)

| Chan. | Freq. (MHz) | 6dB Bandwidth (MHz) | | | | Minimum Limit (MHz) | Pass / Fail |
|-------|---------------------|---------------------|---------|---------|---------|---------------------|-------------|
| | | Chain 0 | Chain 1 | Chain 2 | Chain 3 | | |
| 138 | 5690 For U-NII-3 | 2.75 | 2.75 | 2.74 | 2.72 | 0.5 | Pass |

Spectrum Plot of Worst Value

802.11a

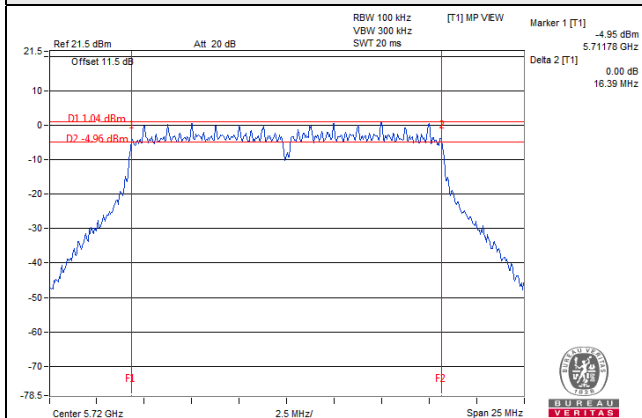

802.11n (HT20)

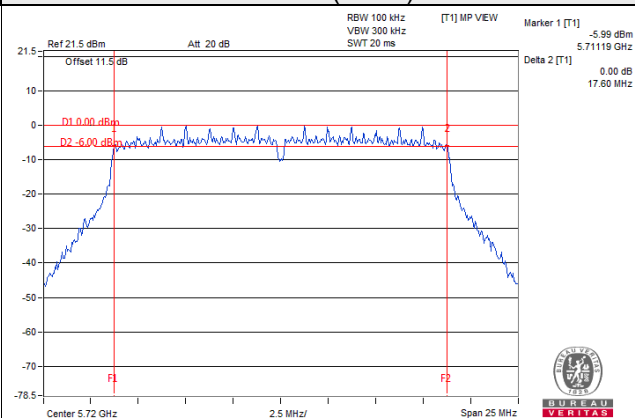

802.11n (HT40)

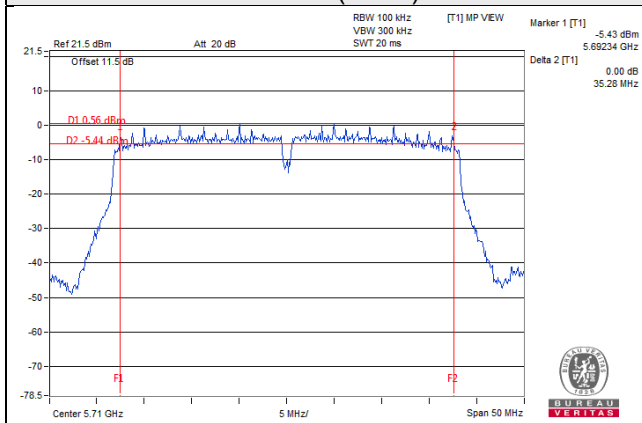

802.11ac (VHT80)

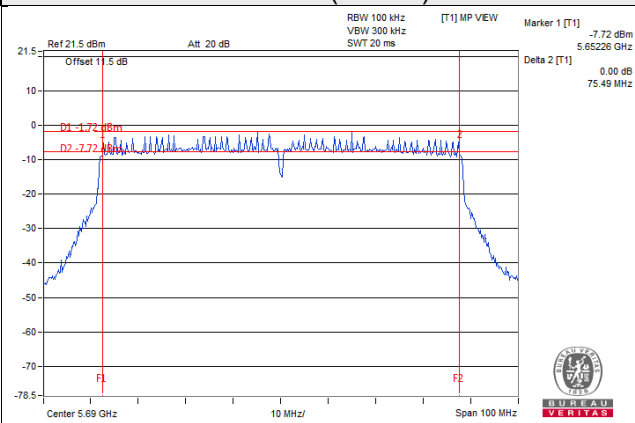

Note: For CH144, CH142, CH138 (UNII-3 Band):

The 6dB bandwidth above 5725MHz = Marker 1 + Delta 2 - 5725MHz

Mode B2

802.11a

| Chan. | Freq. (MHz) | 6dB Bandwidth (MHz) | | | | Minimum Limit (MHz) | Pass / Fail |
|-------|---------------------|---------------------|---------|---------|---------|---------------------|-------------|
| | | Chain 0 | Chain 1 | Chain 2 | Chain 3 | | |
| 144 | 5720 For U-NII-3 | 3.15 | 3.15 | 3.15 | 3.15 | 0.5 | Pass |

802.11n (HT20)

| Chan. | Freq. (MHz) | 6dB Bandwidth (MHz) | | | | Minimum Limit (MHz) | Pass / Fail |
|-------|---------------------|---------------------|---------|---------|---------|---------------------|-------------|
| | | Chain 0 | Chain 1 | Chain 2 | Chain 3 | | |
| 144 | 5720 For U-NII-3 | 3.48 | 3.16 | 3.16 | 3.78 | 0.5 | Pass |

802.11n (HT40)

| Chan. | Freq. (MHz) | 6dB Bandwidth (MHz) | | | | Minimum Limit (MHz) | Pass / Fail |
|-------|---------------------|---------------------|---------|---------|---------|---------------------|-------------|
| | | Chain 0 | Chain 1 | Chain 2 | Chain 3 | | |
| 142 | 5710 For U-NII-3 | 2.63 | 2.56 | 2.59 | 2.58 | 0.5 | Pass |

802.11ac (VHT80)

| Chan. | Freq. (MHz) | 6dB Bandwidth (MHz) | | | | Minimum Limit (MHz) | Pass / Fail |
|-------|---------------------|---------------------|---------|---------|---------|---------------------|-------------|
| | | Chain 0 | Chain 1 | Chain 2 | Chain 3 | | |
| 138 | 5690 For U-NII-3 | 2.77 | 2.77 | 2.75 | 2.70 | 0.5 | Pass |

Spectrum Plot of Worst Value

802.11a

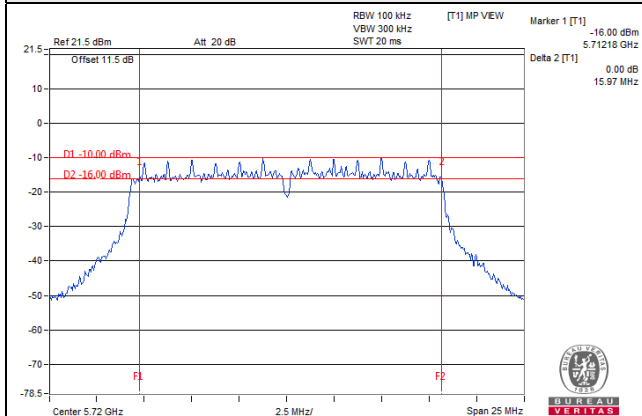

802.11n (HT20)

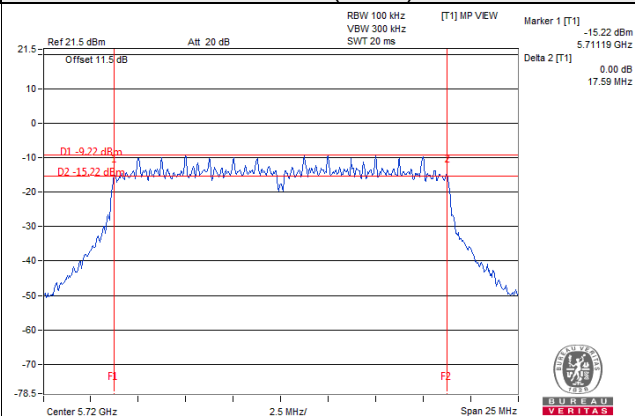

802.11n (HT40)

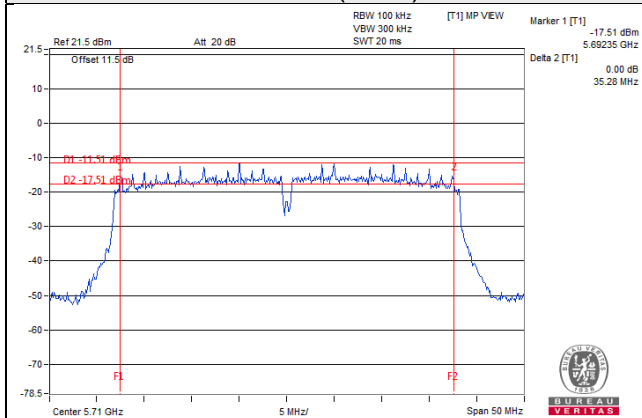

802.11ac (VHT80)

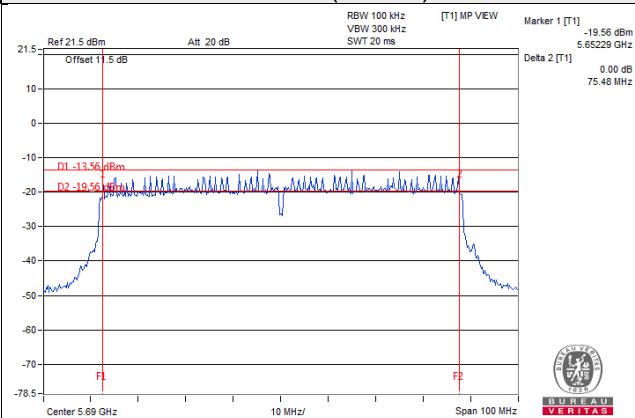

Note: For CH144, CH142, CH138 (UNII-3 Band):

The 6dB bandwidth above 5725MHz = Marker 1 + Delta 2 - 5725MHz

5 Pictures of Test Arrangements

Please refer to the attached file (Test Setup Photo).

Appendix – Information on the Testing Laboratories

We, Bureau Veritas Consumer Products Services (H.K.) Ltd., Taoyuan Branch, were founded in 1988 to provide our best service in EMC, Radio, Telecom and Safety consultation. Our laboratories are FCC recognized accredited test firms and accredited and approved according to ISO/IEC 17025.

If you have any comments, please feel free to contact us at the following:

Linko EMC/RF Lab

Tel: 886-2-26052180

Fax: 886-2-26051924

Hsin Chu EMC/RF/Telecom Lab

Tel: 886-3-6668565

Fax: 886-3-6668323

Hwa Ya EMC/RF/Safety

Tel: 886-3-3183232

Fax: 886-3-3270892

Email: service.adt@tw.bureauveritas.com

Web Site: www.bureauveritas-adt.com

The address and road map of all our labs can be found in our web site also.

--- END ---