



MET Laboratories, Inc. *Safety Certification - EMI - Telecom Environmental Simulation*

914 WEST PATAPSCO AVENUE • BALTIMORE, MARYLAND 21230-3432 • PHONE (410) 354-3300 • FAX (410) 354-3313

33439 WESTERN AVENUE • UNION CITY, CALIFORNIA 94587 • PHONE (510) 489-6300 • FAX (510) 489-6372

3162 BELICK STREET • SANTA CLARA, CALIFORNIA 95054 • PHONE (408) 748-3585 • FAX (510) 489-6372

January 19, 2011

Firetide, Inc.
16795 Lark Ave. Suite 200
Los Gatos, CA 95032

Dear Steve Gu,

Enclosed is the EMC Wireless test report for compliance testing of the Firetide, Inc., Firetide Outdoor MIMO Access Points, Model 5200, tested to the requirements of Title 47 of the Code of Federal Regulations (CFR), Part 90 Subpart Y for Land Mobile Radio Services and RSS-111, Issue 3, June 2009.

Thank you for using the services of MET Laboratories, Inc. If you have any questions regarding these results or if MET can be of further service to you, please feel free to contact me.

Sincerely yours,
MET LABORATORIES, INC.

Jennifer Warnell
Documentation Department

Reference: (\\Firetide, Inc.\\EMCS82555B-FCC90Y Rev. 1)

Certificates and reports shall not be reproduced except in full, without the written permission of MET Laboratories, Inc.



MET Laboratories, Inc. *Safety Certification - EMI - Telecom Environmental Simulation*

914 WEST PATAPSCO AVENUE • BALTIMORE, MARYLAND 21230-3432 • PHONE (410) 354-3300 • FAX (410) 354-3313

33439 WESTERN AVENUE • UNION CITY, CALIFORNIA 94587 • PHONE (510) 489-6300 • FAX (510) 489-6372

3162 BELICK STREET • SANTA CLARA, CALIFORNIA 95054 • PHONE (408) 748-3585 • FAX (510) 489-6372

Electromagnetic Compatibility Criteria Test Report

For the

Firetide, Inc.

Firetide Outdoor MIMO Access Points, Model 5200

Tested under

The FCC Verification Rules

**Contained in Title 47 of the CFR, Part 90, Subpart Y
for Private Land Mobile Radio Services**

and

RSS-111, Issue 3, June 2009

MET Report: EMCS82555B-FCC90Y Rev. 1

January 19, 2011

Prepared For:

Firetide, Inc.

16795 Lark Ave. Suite 200

Los Gatos, CA 95032

Prepared By:

MET Laboratories, Inc.

914 W. Patapsco Ave.

Baltimore, MD 21230

Electromagnetic Compatibility Criteria Test Report

For the

Firetide, Inc.
Firetide Outdoor MIMO Access Points, Model 5200

Tested under

**The FCC Verification Rules
Contained in Title 47 of the CFR, Part 90, Subpart Y
for Private Land Mobile Radio Services
and
RSS-111, Issue 3, June 2009**

MET Report: EMCS82555B-FCC90Y Rev. 1



Minh Ly, Project Engineer
Electromagnetic Compatibility Lab



Jennifer Warnell
Documentation Department

Engineering Statement: The measurements shown in this report were made in accordance with the procedures indicated, and the emissions from this equipment were found to be within the limits applicable. I assume full responsibility for the accuracy and completeness of these measurements, and for the qualifications of all persons taking them. It is further stated that upon the basis of the measurements made, the equipment tested is / is not capable of operation in accordance with the requirements of Part 90, Subpart Y of the FCC Rules and Industry Canada standard RSS-111, Issue 3, June 2009 under normal use and maintenance.



Shawn McMillen,
Wireless Manager, Electromagnetic Compatibility Lab

Report Status Sheet

Revision	Report Date	Reason for Revision
∅	October 25, 2010	Initial Issue.
1	January 19, 2011	Revised to reflect engineer corrections

Table of Contents

1. Executive Summary	1
1.1. Testing Summary	2
2. Equipment Configuration.....	3
2.1. Overview	4
2.2. Test Site	5
2.3. Description of Test Sample	5
2.4. Equipment Configuration	6
2.5. Support Equipment	6
2.6. Ports and Cabling Information	6
2.7. Mode of Operation	9
2.8. Method of Monitoring EUT Operation	9
2.9. Modifications	9
2.9.1. Modifications to EUT	9
2.9.2. Modifications to Test Standard	9
2.10. Disposition of EUT	9
3. Electromagnetic Compatibility Criteria for Intentional Radiators	10
3.1. Peak Power Output.....	15
4. Electromagnetic Compatibility Occupied Bandwidth Requirements.....	19
4.1. Occupied Bandwidth (Emission Masks)	19
5. Electromagnetic Compatibility Spurious Emissions at Antenna Terminal Requirements	26
5.1. Spurious Emissions at Antenna Terminals.....	26
6. Electromagnetic Compatibility Radiated Emissions Requirements	38
6.1. Radiated Emissions.....	38
7. Electromagnetic Compatibility Frequency Stability Requirements	46
7.1. Frequency Stability	46
8. RF Exposure Requirements	49
9. Electromagnetic Compatibility Receiver Spurious Requirements	50
9.1. Receiver Spurious Emissions	50
10. Test Equipment	52
11. Certification Label & User’s Manual Information	53
11.1. Verification Information	54
11.2. Label and User’s Manual Information	58

All references to section numbers are taken directly from the standard/specification used. Only sections requiring testing or evaluation are included.

List of Tables

Table 1. Equipment Configuration	6
Table 2. Support Equipment.....	6
Table 3. Ports and Cabling Information	6
Table 4. Frequency Stability, 5 MHz and 10 MHz.....	47
Table 5. Frequency Stability, 20 MHz	48
Table 6. Spurious Emission Limits for Receivers	50

List of Figures

Figure 1. Block Diagram of Equipment Configuration	7
Figure 2. Setup Block Diagram.....	8
Figure 3. RF Power Output Test Setup.....	11
Figure 4. Peak Spectral Density Test Setup	18
Figure 5. Occupied Bandwidth (Emission Mask) Test Setup.....	22
Figure 6. Occupied Bandwidth Test Setup.....	25
Figure 7. Spurious Emissions at Antenna Terminals Test Setup.....	37

List of Photographs

Photograph 1. Firetide, Inc., Firetide Outdoor MIMO Access Points, Model 5200.....	5
Photograph 2. Radiated Emission Spurious Test Setup, 30 MHz – 1 GHz.....	45
Photograph 3 Radiated Emission Spurious Test Setup, 1 GHz – 18 GHz.....	45

List of Plots

Plot 1. RF Power Output, Low Channel, 802.11a, Low Channel, 5 MHz.....	12
Plot 2. RF Power Output, Low Channel, 802.11a, Mid Channel, 5 MHz	12
Plot 3. RF Power Output, Low Channel, 802.11a, High Channel, 5 MHz.....	12
Plot 4. RF Power Output, Mid Channel, 802.11a, Low Channel, 10 MHz	13
Plot 5. RF Power Output, Mid Channel, 802.11a, Mid Channel, 10 MHz.....	13
Plot 6. RF Power Output, Mid Channel, 802.11a, High Channel, 10 MHz.....	13
Plot 7. RF Power Output, High Channel, 802.11a, Low Channel, 20 MHz.....	14
Plot 8. RF Power Output, High Channel, 802.11a, High Channel, 20 MHz	14
Plot 9. Peak Spectral Density, 802.11a, Low Channel, 5 MHz	16
Plot 10. Peak Spectral Density, 802.11a, Mid Channel, 5 MHz.....	16
Plot 11. Peak Spectral Density, 802.11a, High Channel, 5 MHz	16
Plot 12. Peak Spectral Density, 802.11a, Low Channel, 10 MHz.....	17
Plot 13. Peak Spectral Density, 802.11a, Mid Channel, 10 MHz.....	17
Plot 14. Peak Spectral Density, 802.11a, High Channel, 10 MHz	17
Plot 15. Peak Spectral Density, 802.11a, Low Channel, 20 MHz.....	18
Plot 16. Peak Spectral Density, 802.11a, High Channel, 20 MHz	18
Plot 17. Emission Mask, 802.11a, Low Channel, 5 MHz.....	20
Plot 18. Emission Mask, 802.11a, Mid Channel, 5 MHz	20
Plot 19. Emission Mask, 802.11a, High Channel, 5 MHz.....	20
Plot 20. Emission Mask, 802.11a, Low Channel, 10 MHz.....	21
Plot 21. Emission Mask, 802.11a, Mid Channel, 10 MHz	21
Plot 22. Emission Mask, 802.11a, High Channel, 10 MHz.....	21
Plot 23. Emission Mask, 802.11a, Low Channel, 20 MHz.....	22
Plot 24. Emission Mask, 802.11a, High Channel, 20 MHz.....	22
Plot 25. Occupied Bandwidth, 802.11a, Low Channel, 5 MHz	23

Plot 26. Occupied Bandwidth, 802.11a, Mid Channel, 5 MHz	23
Plot 27. Occupied Bandwidth, 802.11a, High Channel, 5 MHz.....	23
Plot 28. Occupied Bandwidth, 802.11a, Low Channel, 10 MHz	24
Plot 29. Occupied Bandwidth, 802.11a, Mid Channel, 10 MHz	24
Plot 30. Occupied Bandwidth, 802.11a, High Channel, 10 MHz.....	24
Plot 31. Occupied Bandwidth, 802.11a, Low Channel, 20 MHz	25
Plot 32. Occupied Bandwidth, 802.11a, High Channel, 20 MHz.....	25
Plot 33. Conducted Spurious Emissions, Low Channel, 5 MHz (30 MHz – 1 GHz).....	27
Plot 34. Conducted Spurious Emissions, Low Channel, 5 MHz (1 GHz – 18 GHz).....	27
Plot 35. Conducted Spurious Emissions, Low Channel, 5 MHz (18 GHz – 26 GHz).....	27
Plot 36. Conducted Spurious Emissions, Low Channel, 5 MHz (26 GHz – 40 GHz).....	28
Plot 37. Conducted Spurious Emissions, Mid Channel, 5 MHz (30 MHz – 1 GHz).....	28
Plot 38. Conducted Spurious Emissions, Mid Channel, 5 MHz (1 GHz – 18 GHz)	28
Plot 39. Conducted Spurious Emissions, Mid Channel, 5 MHz (18 GHz – 26 GHz)	29
Plot 40. Conducted Spurious Emissions, Mid Channel, 5 MHz (26 GHz – 40 GHz)	29
Plot 41. Conducted Spurious Emissions, High Channel, 5 MHz (30 MHz – 1 GHz)	29
Plot 42. Conducted Spurious Emissions, High Channel, 5 MHz (1 GHz – 18 GHz).....	30
Plot 43. Conducted Spurious Emissions, High Channel, 5 MHz (18 GHz – 26 GHz).....	30
Plot 44. Conducted Spurious Emissions, High Channel, 5 MHz (26 GHz – 40 GHz).....	30
Plot 45. Conducted Spurious Emissions, Low Channel, 10 MHz (30 MHz – 1 GHz).....	31
Plot 46. Conducted Spurious Emissions, Low Channel, 10 MHz (1 GHz – 18 GHz).....	31
Plot 47. Conducted Spurious Emissions, Low Channel, 10 MHz (18 GHz – 26 GHz).....	31
Plot 48. Conducted Spurious Emissions, Low Channel, 10 MHz (26 GHz – 40 GHz).....	32
Plot 49. Conducted Spurious Emissions, Mid Channel, 10 MHz (30 MHz – 1 GHz).....	32
Plot 50. Conducted Spurious Emissions, Mid Channel, 10 MHz (1 GHz – 18 GHz)	32
Plot 51. Conducted Spurious Emissions, Mid Channel, 10 MHz (18 GHz – 26 GHz)	33
Plot 52. Conducted Spurious Emissions, Mid Channel, 10 MHz (26 GHz – 40 GHz)	33
Plot 53. Conducted Spurious Emissions, High Channel, 10 MHz (30 MHz – 1 GHz)	33
Plot 54. Conducted Spurious Emissions, High Channel, 10 MHz (1 GHz – 18 GHz).....	34
Plot 55. Conducted Spurious Emissions, High Channel, 10 MHz (18 GHz – 26 GHz).....	34
Plot 56. Conducted Spurious Emissions, High Channel, 10 MHz (26 GHz – 40 GHz).....	34
Plot 57. Conducted Spurious Emissions, Low Channel, 20 MHz (30 MHz – 1 GHz).....	35
Plot 58. Conducted Spurious Emissions, Low Channel, 20 MHz (1 GHz – 18 GHz).....	35
Plot 59. Conducted Spurious Emissions, Low Channel, 20 MHz (18 GHz – 26 GHz).....	35
Plot 60. Conducted Spurious Emissions, Low Channel, 20 MHz (26 GHz – 40 GHz).....	36
Plot 61. Conducted Spurious Emissions, High Channel, 20 MHz (30 MHz – 1 GHz)	36
Plot 62. Conducted Spurious Emissions, High Channel, 20 MHz (1 GHz – 18 GHz).....	36
Plot 63. Conducted Spurious Emissions, High Channel, 20 MHz (18 GHz – 26 GHz).....	37
Plot 64. Conducted Spurious Emissions, High Channel, 20 MHz (26 GHz – 40 GHz).....	37
Plot 65. Radiated Spurious Emissions, Low Channel, 5 MHz (30 MHz – 1 GHz).....	39
Plot 66. Radiated Spurious Emissions, Low Channel, 5 MHz (1 GHz – 18 GHz).....	39
Plot 67. Radiated Spurious Emissions, Mid Channel, 5 MHz (30 MHz – 1 GHz).....	39
Plot 68. Radiated Spurious Emissions, Mid Channel, 5 MHz (1 GHz – 18 GHz).....	40
Plot 69. Radiated Spurious Emissions, High Channel, 5 MHz (30 MHz – 1 GHz)	40
Plot 70. Radiated Spurious Emissions, High Channel, 5 MHz (1 GHz – 18 GHz).....	40
Plot 71. Radiated Spurious Emissions, Low Channel, 10 MHz (30 MHz – 1 GHz).....	41
Plot 72. Radiated Spurious Emissions, Low Channel, 10 MHz (1 GHz – 18 GHz).....	41
Plot 73. Radiated Spurious Emissions, Mid Channel, 10 MHz (30 MHz – 1 GHz).....	41
Plot 74. Radiated Spurious Emissions, Mid Channel, 10 MHz (1 GHz – 18 GHz)	42
Plot 75. Radiated Spurious Emissions, High Channel, 10 MHz (30 MHz – 1 GHz)	42
Plot 76. Radiated Spurious Emissions, High Channel, 10 MHz (1 GHz – 18 GHz).....	42
Plot 77. Radiated Spurious Emissions, Low Channel, 20 MHz (30 MHz – 1 GHz).....	43
Plot 78. Radiated Spurious Emissions, Low Channel, 20 MHz (1 GHz – 18 GHz).....	43
Plot 79. Radiated Spurious Emissions, High Channel, 20 MHz (30 MHz – 1 GHz).....	43

Plot 80. Radiated Spurious Emissions, High Channel, 20 MHz (1 GHz – 18 GHz)	44
Plot 81. Conducted Receiver Spurious Emissions, 30 MHz – 1 GHz	51
Plot 82. Conducted Receiver Spurious Emissions, 1 GHz – 20 GHz.....	51

List of Terms and Abbreviations

AC	Alternating Current
ACF	Antenna Correction Factor
Cal	Calibration
<i>d</i>	Measurement Distance
dB	Decibels
dBμA	Decibels above one microamp
dBμV	Decibels above one microvolt
dBμA/m	Decibels above one microamp per meter
dBμV/m	Decibels above one microvolt per meter
DC	Direct Current
E	Electric Field
DSL	Digital Subscriber Line
ESD	Electrostatic Discharge
EUT	Equipment Under Test
<i>f</i>	Frequency
FCC	Federal Communications Commission
GRP	Ground Reference Plane
H	Magnetic Field
HCP	Horizontal Coupling Plane
Hz	Hertz
IEC	International Electrotechnical Commission
kHz	kilohertz
kPa	kilopascal
kV	kilovolt
LISN	Line Impedance Stabilization Network
MHz	Megahertz
μH	microhenry
μ	microfarad
μs	microseconds
NEBS	Network Equipment-Building System
PRF	Pulse Repetition Frequency
RF	Radio Frequency
RMS	Root-Mean-Square
TWT	Traveling Wave Tube
V/m	Volts per meter
VCP	Vertical Coupling Plane



Executive Summary

1. Testing Summary

These tests were conducted on a sample of the equipment for the purpose of demonstrating compliance with Part 90, Subpart Y. All tests were conducted using measurement procedure ANSI TIA/EIA-603-A-2004.

Title 47 of the CFR, Part 90, Subpart Y, and FCC 04-265 Reference and Test Description	RSS-111, Issue 3, June 2009 Reference	Conformance			Comments
		Yes	No	N/A	
		<i>Yes - Equipment complies with the Requirement</i> <i>No - Equipment does not comply with the Requirement</i> <i>N/A - Not applicable to the equipment under tests</i>			
2.1046; 90.1215(a) Peak Power Output	RSS-111, Section 5.3	✓			Measured emissions below applicable limits.
2.1046; 90.1215(a) Peak Power Spectral Density	RSS-111, Section 4.2	✓			Measured emissions below applicable limits.
2.1047(a) Modulation Characteristics	N/A			✓	EUT is non-voice, data only.
2.1049; 90.210(M) Occupied Bandwidth (Emission Mask)	RSS-111, Section 5.3	✓			Measured emissions below applicable limits.
2.1051; 90.210(M) Spurious Emissions at Antenna Terminals	RSS-111, Section 5.4	✓			Measured emissions below applicable limits.
2.1053; 90.210(M) Radiated Spurious Emissions	RSS-111, Section 5.4	✓			Measured emissions below applicable limits.
2.1055(a) (1); 90.213 Frequency Stability over Temperature Variations	RSS-111, Section 5.2	✓			Measured emissions below applicable limits.
2.1055(d) (2) Frequency Stability over Voltage Variations	RSS-111, Section 5.2	✓			Measured emissions below applicable limits.
90.214 Transient Frequency Behavior	RSS-111, Section 5.2			✓	EUT operating frequency is at 4.9 GHz.

Equipment Configuration

2. Equipment Configuration

2.1. Overview

MET Laboratories, Inc. was contracted by Firetide, Inc. to perform testing on the Firetide Outdoor MIMO Access Points, Model 5200 under quote number 9FIR2707R3.

This document describes the test setups, test methods, required test equipment, and the test limit criteria used to perform compliance testing of the Firetide, Inc., Firetide Outdoor MIMO Access Points, Model 5200.

An EMC evaluation to determine compliance of the TB 4.9 with the requirements of Part 90, Subpart Y, was conducted. (All references are to the most current version of Title 47 of the Code of Federal Regulations in effect). In accordance with §2.1033, the following data is presented in support of the Certification of the TB4.9. Firetide, Inc. should retain a copy of this document and it should be kept on file for at least five years after the manufacturing of the EUT has been **permanently** discontinued. The results obtained relate only to the item(s) tested.

Model(s) Tested:	Firetide Outdoor MIMO Access Points, Model 5200	
Model(s) Covered:	Firetide Outdoor MIMO Access Points, Model 5200	
EUT Specifications:	Primary Power Source: 115 VAC	
	FCC ID: REP-5200-1 IC ID: 4988A-5200	
	Type of Modulations:	OFDM
	Max Peak and Average Output Power:	26.65 dBm
	Equipment Code:	TNB
	EUT Frequency Ranges:	4940 – 4990MHz
Analysis:	The results obtained relate only to the item(s) tested.	
Environmental Test Conditions:	Temperature (15-35° C):	
	Relative Humidity (30-60%):	
	Barometric Pressure (860-1060 mbar):	
Evaluated by:	Minh Ly	
Report Date(s):	January 19, 2011	

2.2. Test Site

All testing was performed at MET Laboratories, Inc., 3162 Belick Street, Santa Clara, CA 95054. All equipment used in making physical determinations is accurate and bears recent traceability to the National Institute of Standards and Technology.

Radiated Emissions measurements were performed in a semi-anechoic chamber (equivalent to an Open Area Test Site). In accordance with §2.948(a)(3), a complete site description is contained at MET Laboratories.

2.3. Description of Test Sample

The Firetide, Inc. Firetide Outdoor MIMO Access Points, Model 5200, Equipment Under Test (EUT), is an Outdoor MIMO Access Points utilizing Wistron DNMA-83 mini PCI radios.



Photograph 1. Firetide, Inc., Firetide Outdoor MIMO Access Points, Model 5200

2.4. Equipment Configuration

The EUT was set up as outlined in Figure 1, Block Diagram of Test Setup. All cards, racks, etc., incorporated as part of the EUT is included in the following list.

Ref. ID	Name / Description	Model Number	Part Number	Serial Number	Rev. #
A	Firetide Outdoor AP	5200	5200	NA	1
B	PoE Injector (PhiHong)	PoE30U-560	PoE30U-560	P71300181A1	NA

Table 1. Equipment Configuration

2.5. Support Equipment

Firetide, Inc. supplied support equipment necessary for the operation and testing of the Firetide Outdoor MIMO Access Points, Model 5200. All support equipment supplied is listed in the following Support Equipment List.

Ref. ID	Name / Description	Manufacturer	Model Number	Customer Supplied Calibration Data
D	Laptop computer	Dell	vostro 1000	N/A

Table 2. Support Equipment

2.6. Ports and Cabling Information

Ref. ID	Port name on EUT	Cable Description or reason for no cable	Qty.	Length (m)	Shielded (Y/N)	Termination Box ID & Port Name
1	DC Power	DC power input from SELV	1	1	N	N/A
2	Ethernet	IP connection to host computer	1	10	N	N/A

Table 3. Ports and Cabling Information

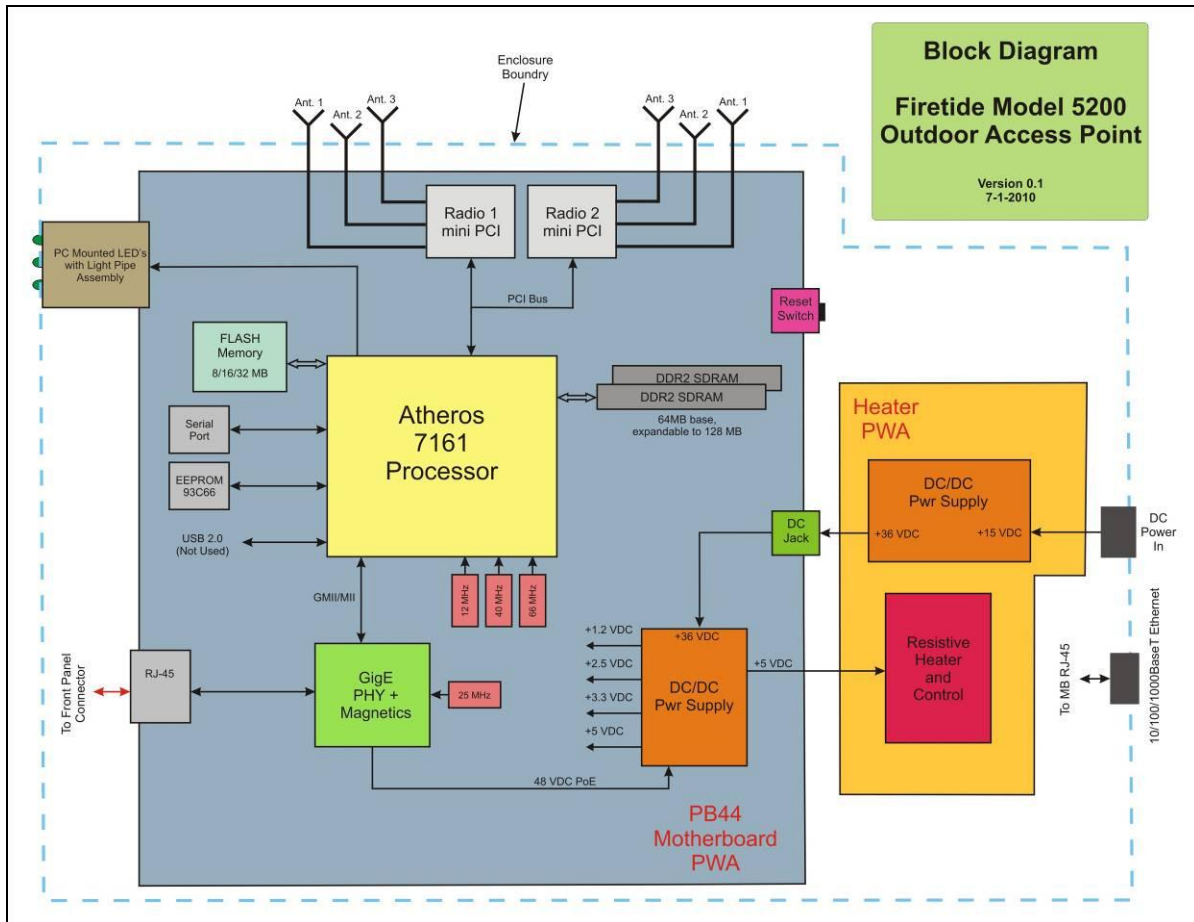

Figure 1. Block Diagram of Equipment Configuration

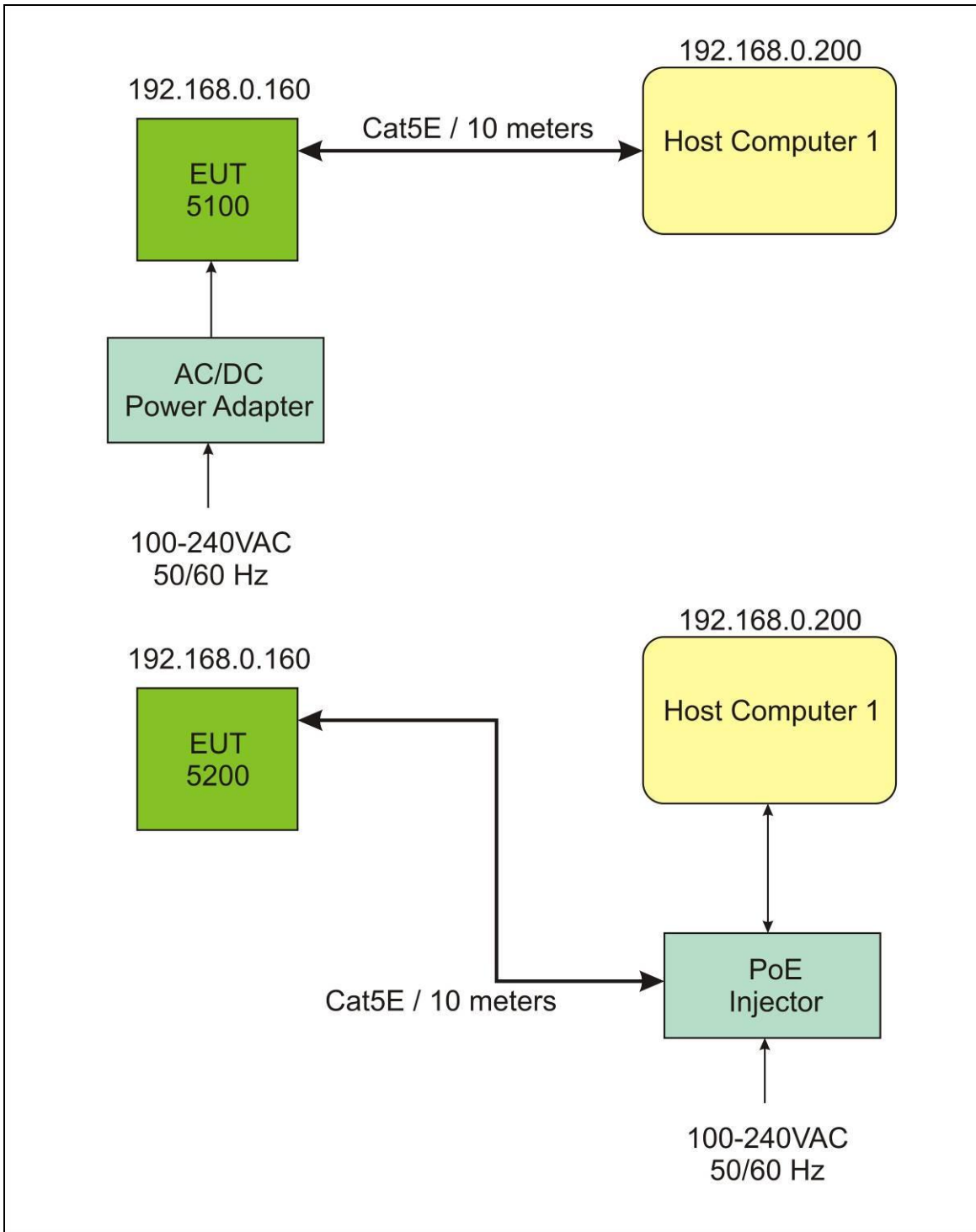

Figure 2. Setup Block Diagram

2.7. Mode of Operation

Operation can be monitored using by pinging the EUT or running ART.

2.8. Method of Monitoring EUT Operation

IP connectivity is maintained with the EUT. If IP connectivity is lost, EUT connectivity shall be re-established upon power up or re-boot.

2.9. Modifications

2.9.1. Modifications to EUT

Replaced 40MHz crystal oscillator with wide temperature type that has lower temperature coefficient of 10ppm.

2.9.2. Modifications to Test Standard

No modifications were made to the test standard.

2.10. Disposition of EUT

The test sample including all support equipment submitted to the Electro-Magnetic Compatibility Lab for testing was returned to Firetide, Inc. upon completion of testing.

III. Electromagnetic Compatibility Criteria for Intentional Radiators

3. Electromagnetic Compatibility RF Power Output Requirements

3.1. RF Power Output

Test Requirement(s): §2.1046 and §90.1215(a) with FCC 04-265

Test Procedures: As required by 47 CFR 2.1046, *RF power output measurements* were made at the RF output terminals using a Spectrum Analyzer.

A laptop was connected to EUT to control the RF power output and frequency channel. The EUT was connected to a Spectrum Analyzer via an attenuator to measure the Peak power. The EUT power was adjusted enough to produce maximum output power as specified in the owner’s manual. The output power was then recorded with peak reading. Measurements were made at the low, mid and high channels.

Test Results: Equipment complies with 47CFR 2.1046 and 90.1215(a) with FCC 04-265.

All RF Power output measurements were direct connection to RF output Terminal of EUT from a Spectrum Analyzer.

RF Power Output	
Frequency (MHz)	Peak Power (dBm)
5 MHz	
4945.0	24.84
4965.0	25.69
4985.0	25.77
10 MHz	
4945.0	26.65
4965.0	25.63
4985.0	25.83
20 MHz	
4950.0	25.12
4980.0	25.57

Test Engineer(s): Minh Ly

Test Date(s): 08/25/10

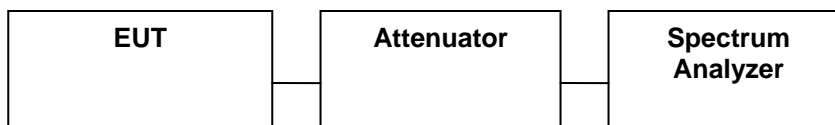
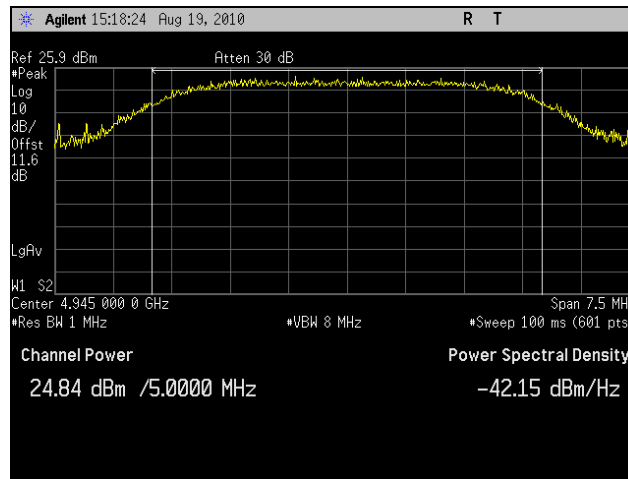
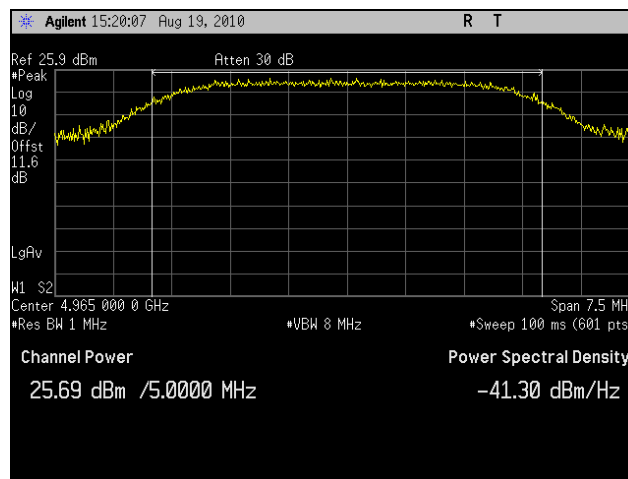

Figure 3. RF Power Output Test Setup



Plot 1. RF Power Output, Low Channel, 802.11a, Low Channel, 5 MHz



Plot 2. RF Power Output, Low Channel, 802.11a, Mid Channel, 5 MHz

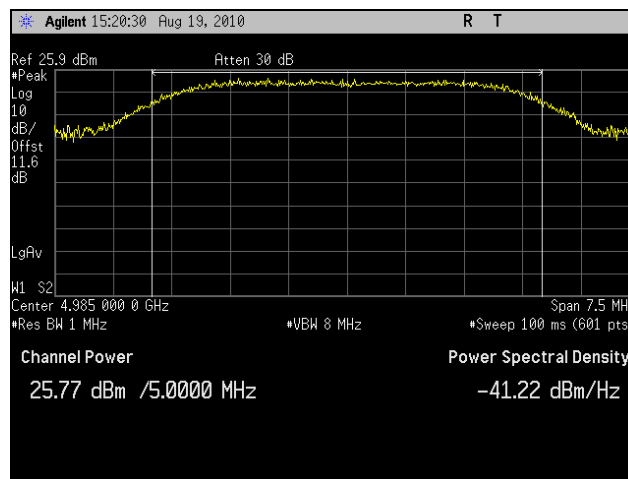

Plot 3. RF Power Output, Low Channel, 802.11a, High Channel, 5 MHz

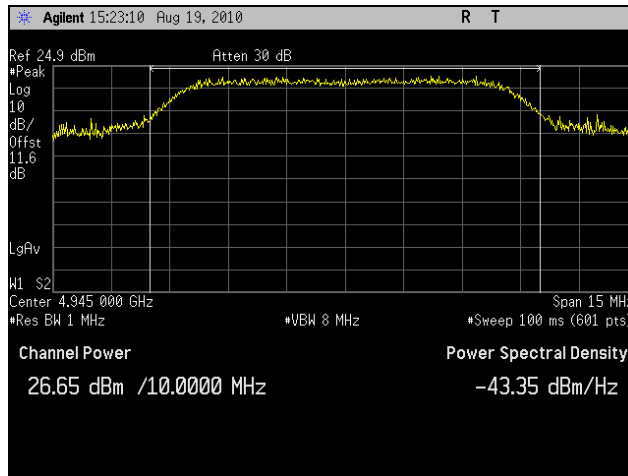

Plot 4. RF Power Output, Mid Channel, 802.11a, Low Channel, 10 MHz

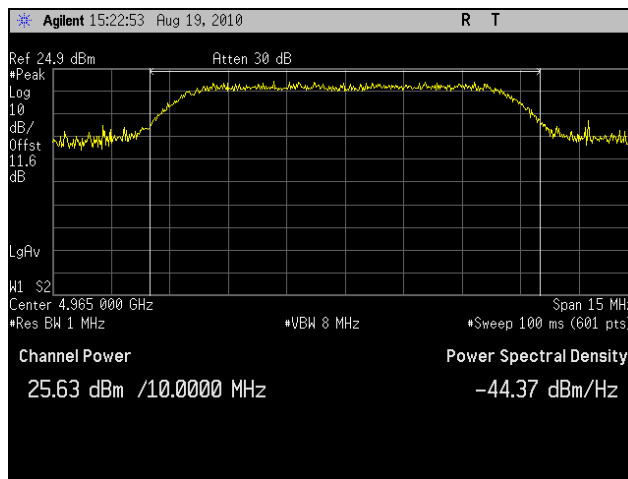

Plot 5. RF Power Output, Mid Channel, 802.11a, Mid Channel, 10 MHz

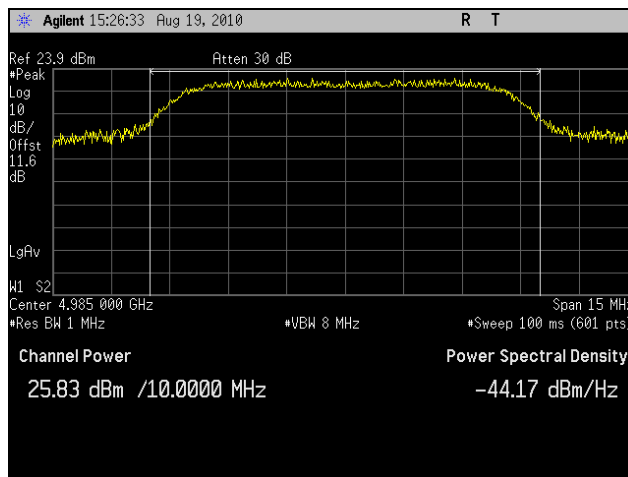

Plot 6. RF Power Output, Mid Channel, 802.11a, High Channel, 10 MHz

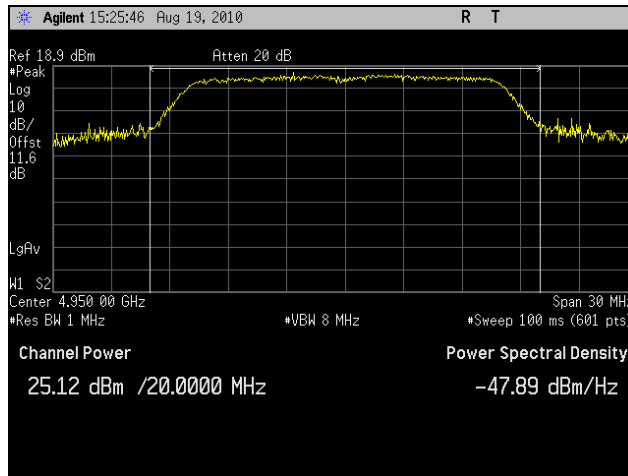

Plot 7. RF Power Output, High Channel, 802.11a, Low Channel, 20 MHz

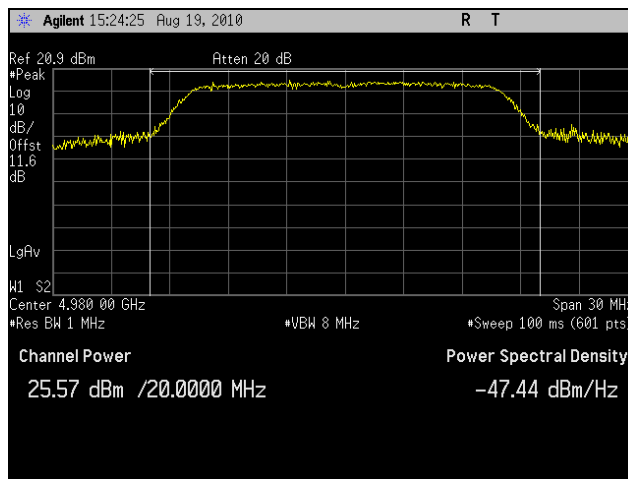

Plot 8. RF Power Output, High Channel, 802.11a, High Channel, 20 MHz

3.2. Peak Power Spectral Density

Test Requirement(s): §90.1215(a) with FCC 04-265

Test Procedures: As required by 47 CFR 2.1046, *RF power output measurements* were made at the RF output terminals using a Directional Coupler through a Spectrum Analyzer and Power Meter.

A laptop was connected to EUT to control the RF power output and frequency channel. The EUT was connected to a Spectrum Analyzer in order to measure the power level. The Spectrum Analyzer was set to a RBW = 1 & VBW = 3 MHz. The EUT power was adjusted at the maximum output power level. The max hold key from the Spectrum Analyzer was activated capturing the modulated envelope of the EUT. The Peak Power Spectral Density was then recorded. Measurements were made at the low, mid and high channels.

Test Results: Equipment complies with 47 CFR 2.1046 and 90.1215(a) with FCC 04-265 (High Power devices). The EUT does not exceed 21dBm/MHz peak power spectral density at the carrier frequency.

The following pages show measurements of Peak Power Spectral Density plots which is recorded below:

Peak Power Spectral Density			
Frequency (MHz)	EUT Channel Bandwidth (MHz)	Measured Power Spectral Density (dBm)	Limit (dBm)
4945.0	5 MHz	19.47	21.00
4965.0		20.13	21.00
4985.0		18.52	21.00
4945.0	10 MHz	20.21	21.00
4965.0		19.67	21.00
4985.0		19.75	21.00
4950.0	20 MHz	17.21	21.00
4980.0		15.75	21.00

Test Engineer(s): Minh Ly

Test Date(s): 08/19/10

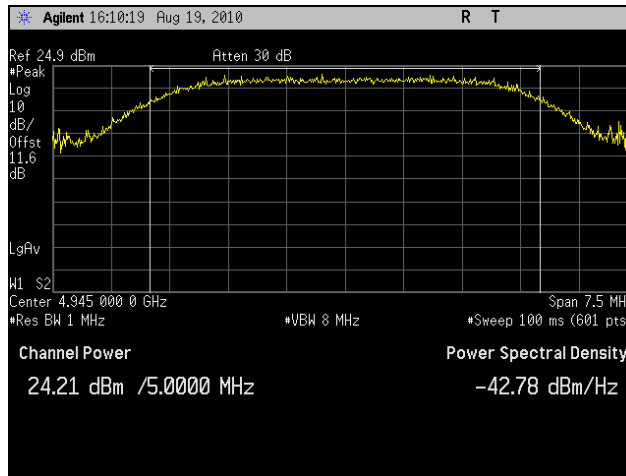

Plot 9. Peak Spectral Density, 802.11a, Low Channel, 5 MHz

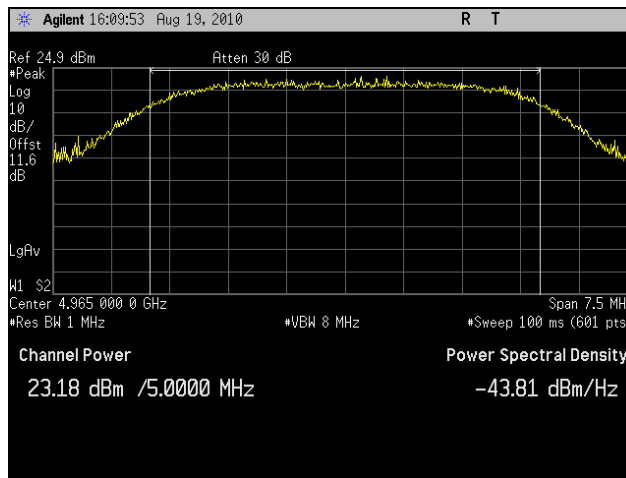

Plot 10. Peak Spectral Density, 802.11a, Mid Channel, 5 MHz

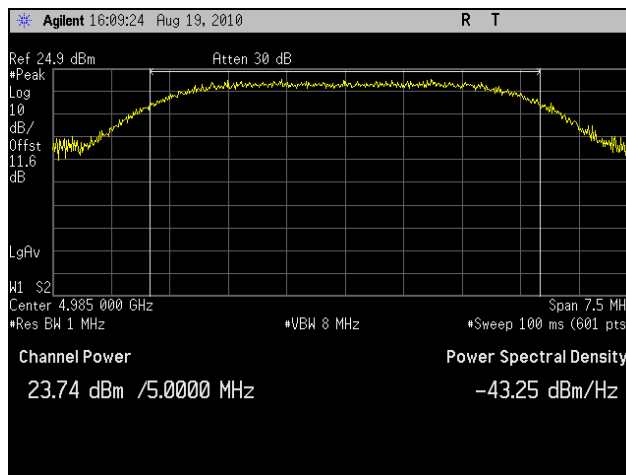

Plot 11. Peak Spectral Density, 802.11a, High Channel, 5 MHz

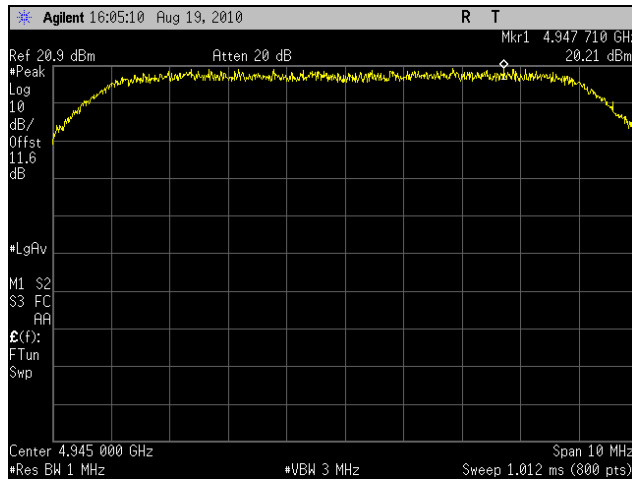

Plot 12. Peak Spectral Density, 802.11a, Low Channel, 10 MHz

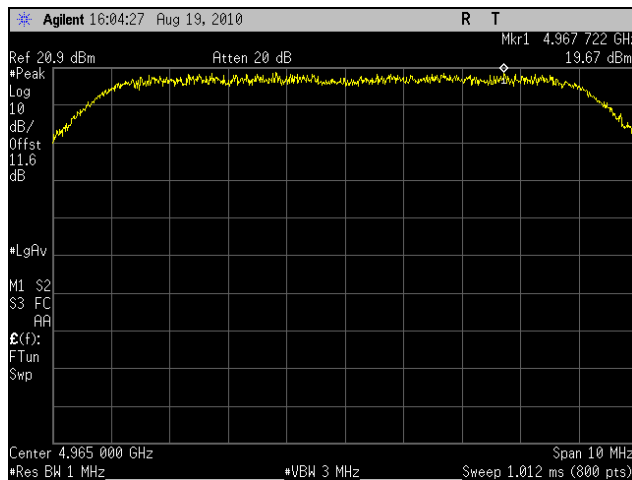

Plot 13. Peak Spectral Density, 802.11a, Mid Channel, 10 MHz

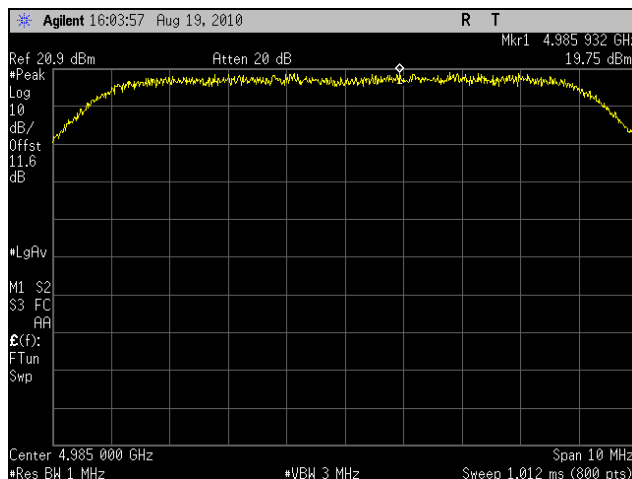

Plot 14. Peak Spectral Density, 802.11a, High Channel, 10 MHz

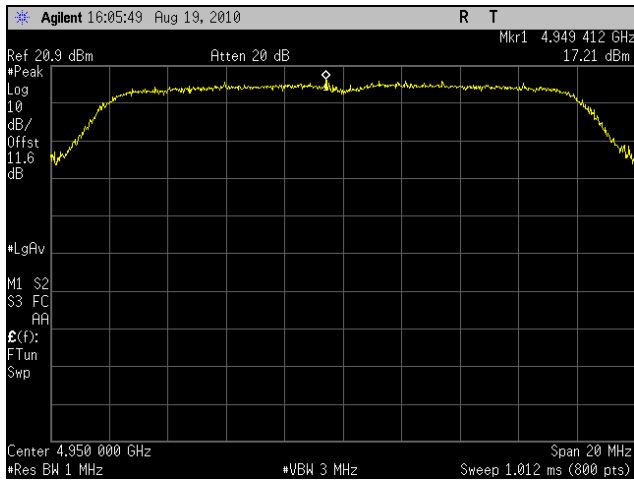

Plot 15. Peak Spectral Density, 802.11a, Low Channel, 20 MHz

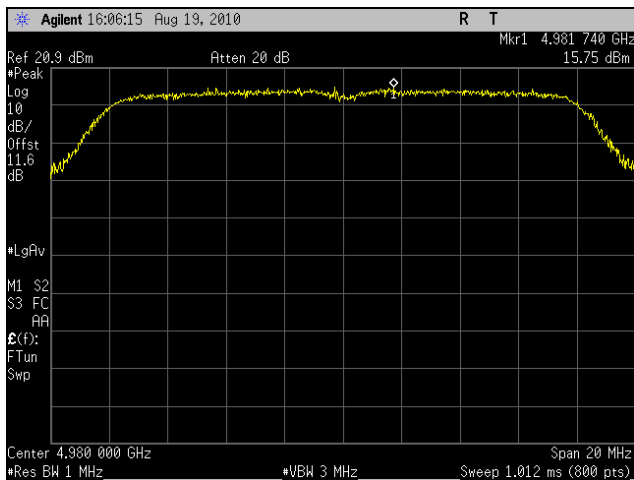

Plot 16. Peak Spectral Density, 802.11a, High Channel, 20 MHz

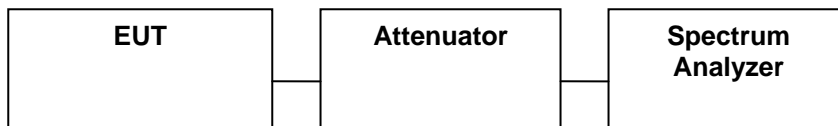

Figure 4. Peak Spectral Density Test Setup

4. Electromagnetic Compatibility Occupied Bandwidth Requirements

4.1. Occupied Bandwidth (Emission Mask)

Test Requirement(s): §2.1049 and §90.210 (M) with FCC 04-265 (Emissions Mask M)

Test Procedures: As required by 47 CFR 2.1049, *occupied bandwidth measurements* were made at the RF output terminals using a Spectrum Analyzer.

A laptop was connected to EUT to control the RF power output and frequency channel. The EUT was connected to a Spectrum Analyzer via attenuator. The measured highest Average Power was set relative to zero dB reference. The RBW of the Spectrum Analyzer was set to at least 1% of the channel bandwidth. The EUT power was adjusted at the maximum output power level. Measurements were carried out at the low, mid and high channels of the TX band.

Test Results: Equipment complies with Section 2.1049 and 90.210(M) with FCC 04-265 (Emission Mask M). The EUT does not exceed the Emission Masks limit.

The following pages show measurements of Emission Mask plots:

Test Engineer(s): Minh Ly

Test Date(s): 08/25/10

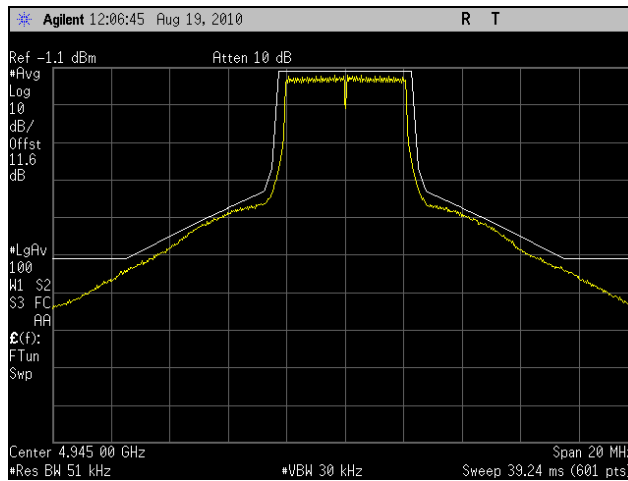

Plot 17. Emission Mask, 802.11a, Low Channel, 5 MHz

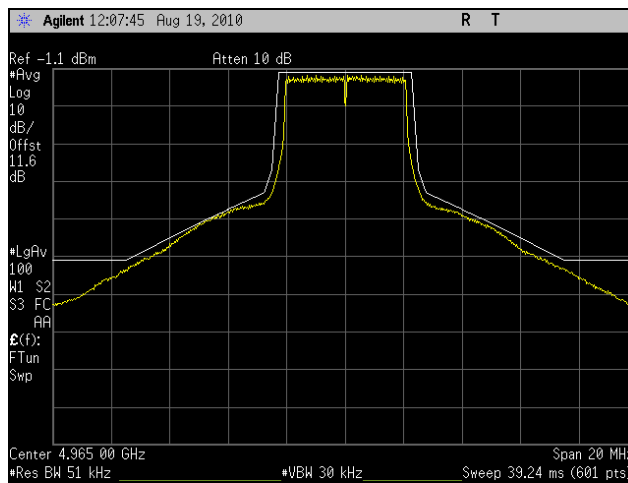

Plot 18. Emission Mask, 802.11a, Mid Channel, 5 MHz

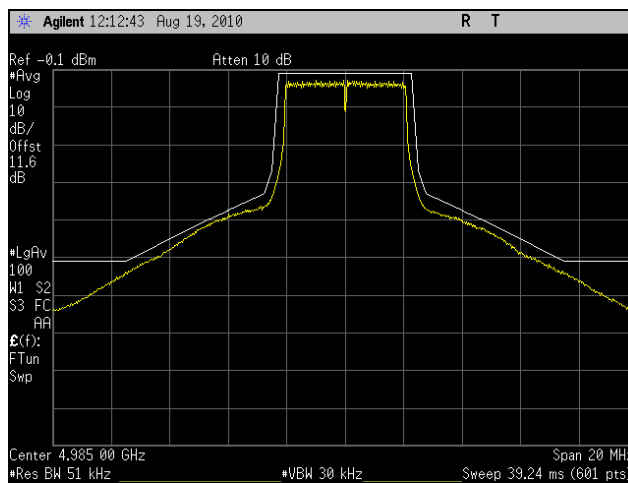

Plot 19. Emission Mask, 802.11a, High Channel, 5 MHz

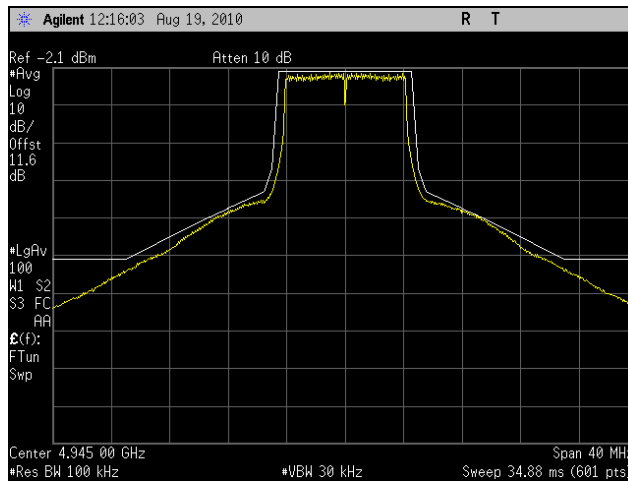

Plot 20. Emission Mask, 802.11a, Low Channel, 10 MHz

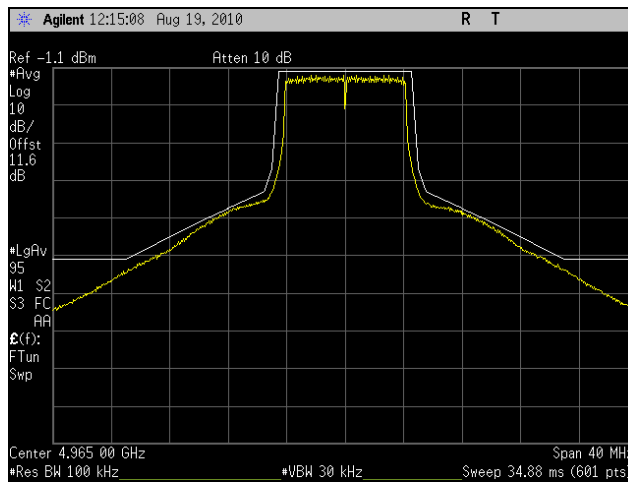

Plot 21. Emission Mask, 802.11a, Mid Channel, 10 MHz

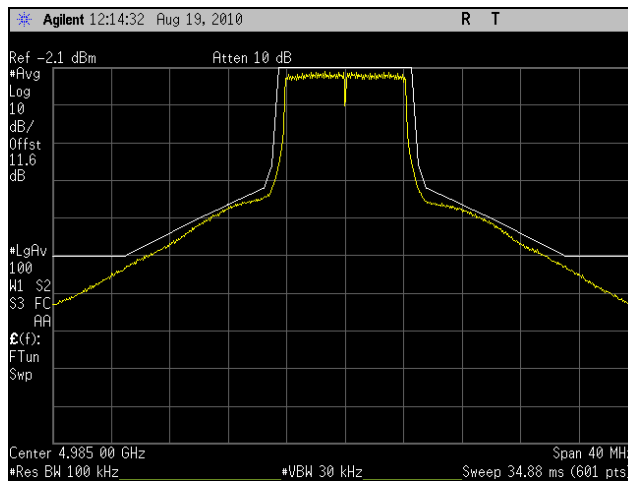

Plot 22. Emission Mask, 802.11a, High Channel, 10 MHz

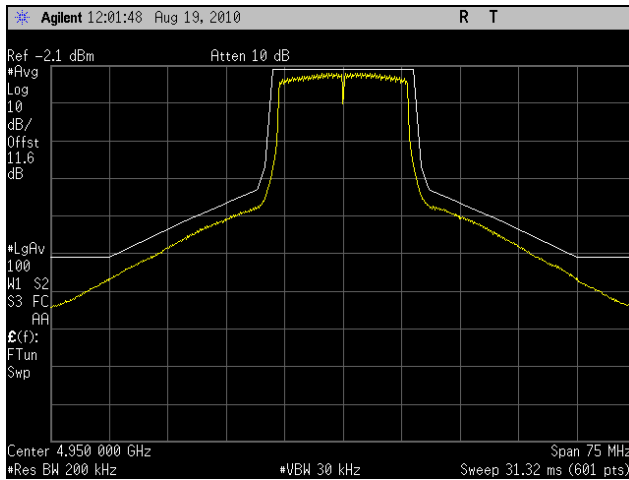

Plot 23. Emission Mask, 802.11a, Low Channel, 20 MHz

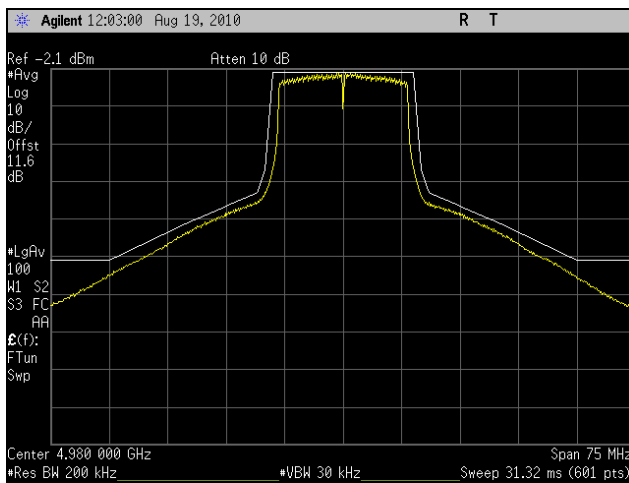

Plot 24. Emission Mask, 802.11a, High Channel, 20 MHz

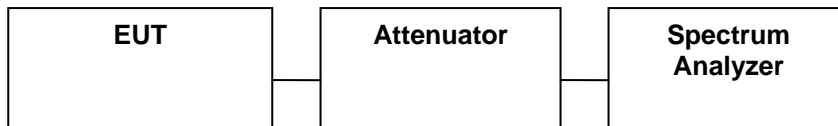
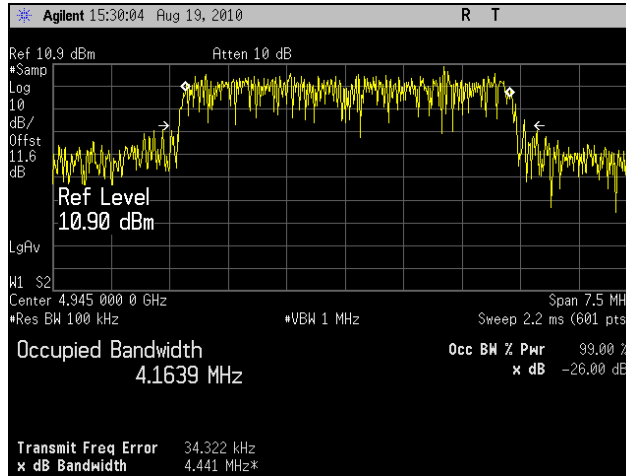
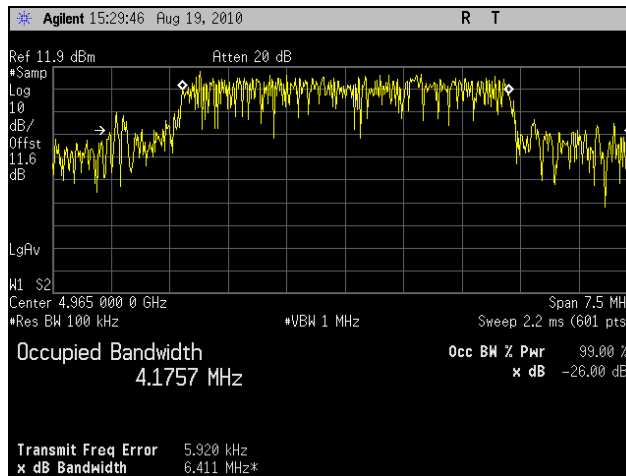

Figure 5. Occupied Bandwidth (Emission Mask) Test Setup

Occupied Bandwidth



Plot 25. Occupied Bandwidth, 802.11a, Low Channel, 5 MHz



Plot 26. Occupied Bandwidth, 802.11a, Mid Channel, 5 MHz

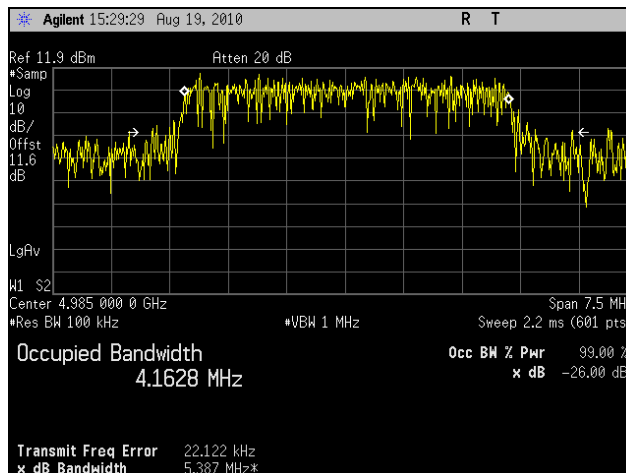

Plot 27. Occupied Bandwidth, 802.11a, High Channel, 5 MHz

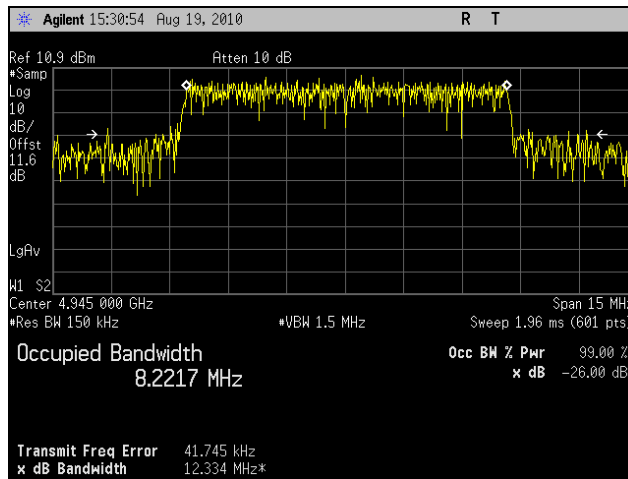

Plot 28. Occupied Bandwidth, 802.11a, Low Channel, 10 MHz

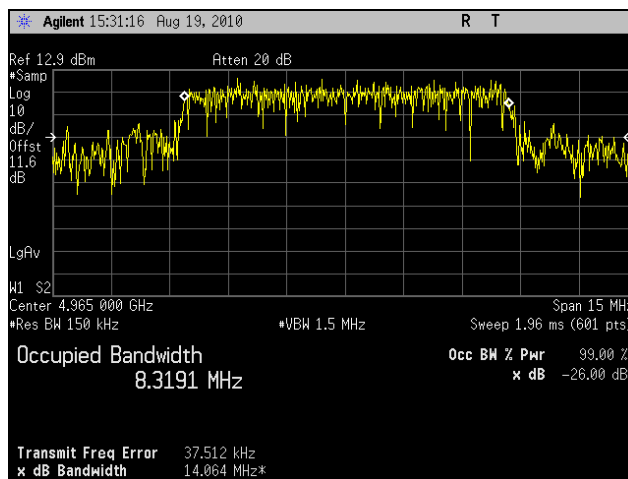

Plot 29. Occupied Bandwidth, 802.11a, Mid Channel, 10 MHz

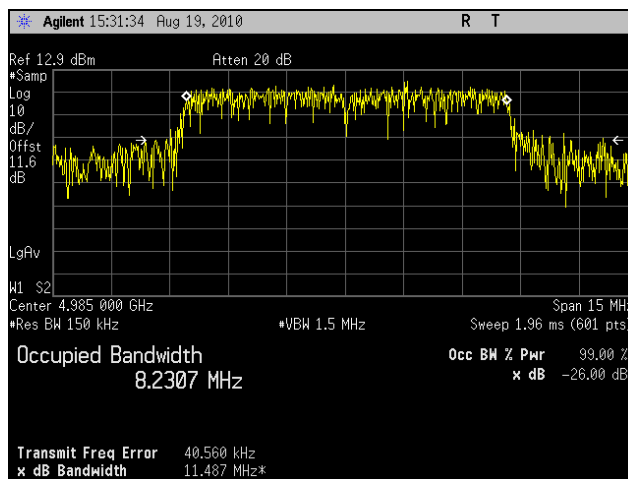

Plot 30. Occupied Bandwidth, 802.11a, High Channel, 10 MHz

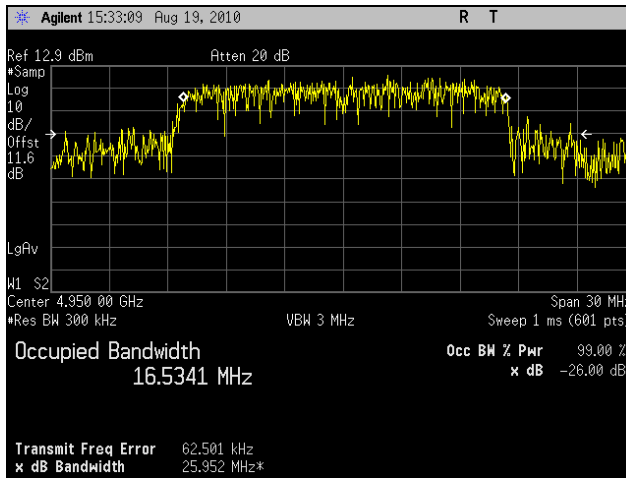

Plot 31. Occupied Bandwidth, 802.11a, Low Channel, 20 MHz

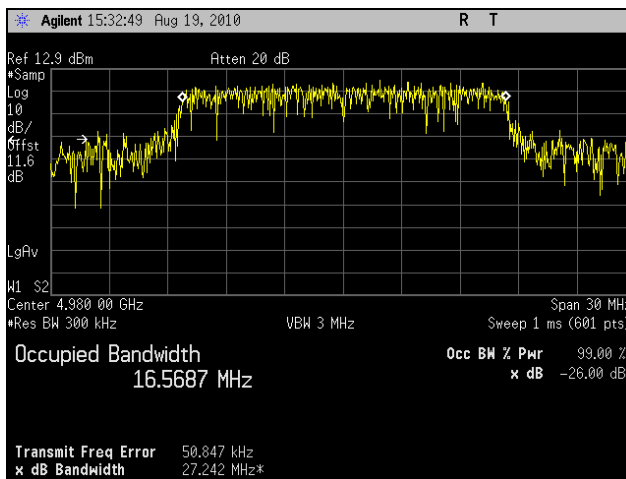

Plot 32. Occupied Bandwidth, 802.11a, High Channel, 20 MHz

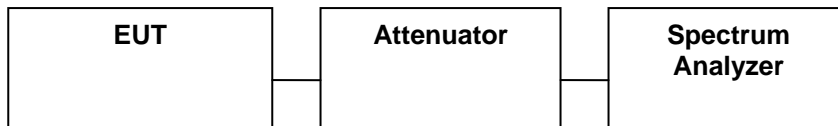

Figure 6. Occupied Bandwidth Test Setup

5. Electromagnetic Compatibility Spurious Emissions at Antenna Terminal Requirements

5.1. Spurious Emissions at Antenna Terminals

Test Requirement(s): §2.1051 and §90.210(M) with FCC 04-265

Test Procedures: As required by 47 CFR 2.1051, *spurious emissions at antenna terminal measurements* were made at the RF output terminals using a Spectrum Analyzer.

A laptop was connected to EUT to control the RF power output and frequency channel. The EUT was connected to a Spectrum Analyzer and a Power Meter to monitor the output power level. The Spectrum Analyzer was set to sweep 30 MHz and up to 10th harmonic of the fundamental or 40GHz which ever is the lesser. Measurements were made at the low, mid and high channels.

The Conducted Spurious Emissions *Limit* is obtained by the following:

Test Results: Equipment complies with Section 2.1051 and 90.210(M) with FCC 04-265.

Test Engineer(s): Minh Ly

Test Date(s): 08/25/10

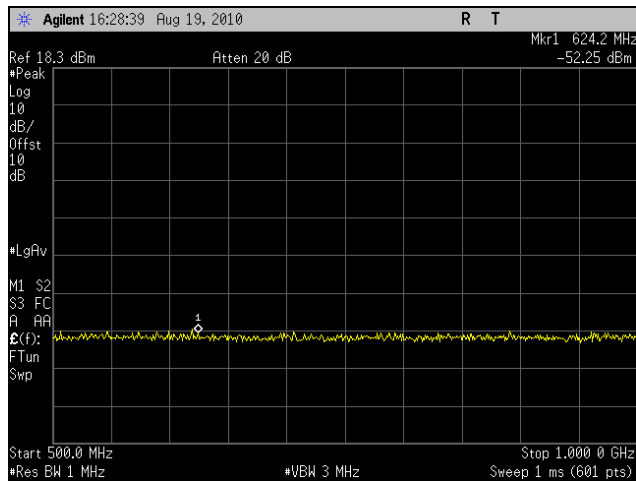

Plot 33. Conducted Spurious Emissions, Low Channel, 5 MHz (30 MHz – 1 GHz)

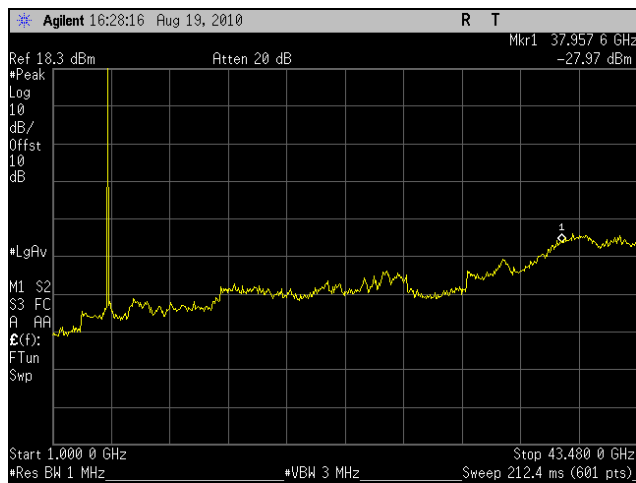

Plot 34 Conducted Spurious Emissions, Low Channel, 5 MHz (1 GHz – 18 GHz)

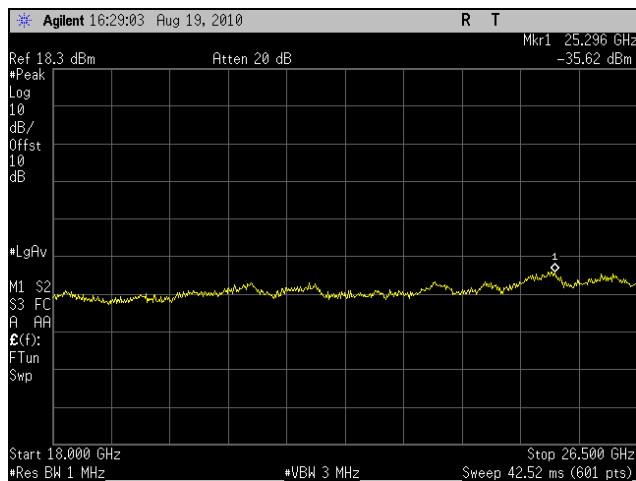

Plot 35. Conducted Spurious Emissions, Low Channel, 5 MHz (18 GHz – 26 GHz)

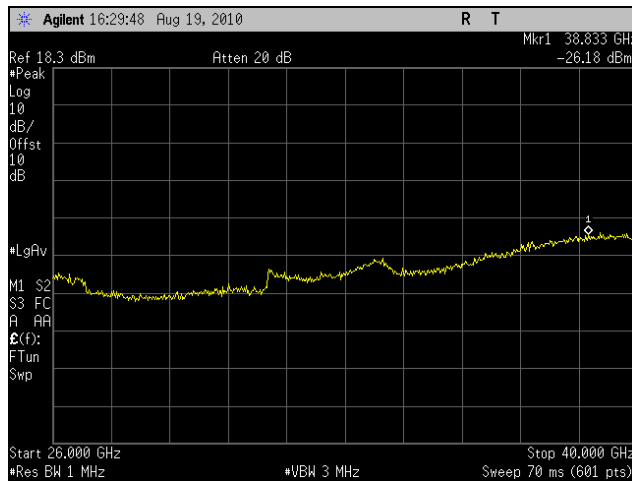

Plot 36. Conducted Spurious Emissions, Low Channel, 5 MHz (26 GHz – 40 GHz)

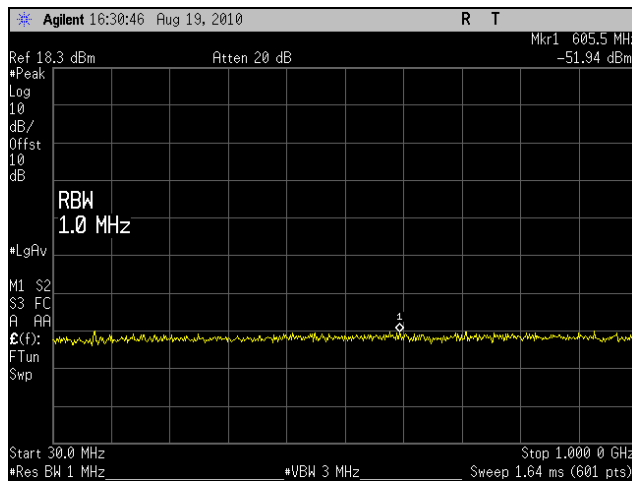

Plot 37. Conducted Spurious Emissions, Mid Channel, 5 MHz (30 MHz – 1 GHz)

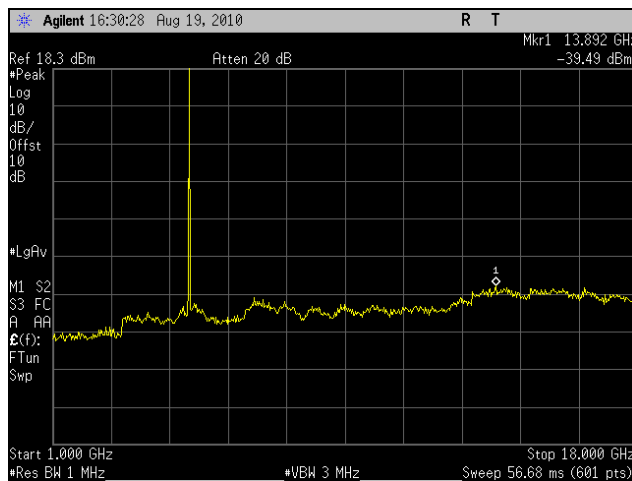

Plot 38. Conducted Spurious Emissions, Mid Channel, 5 MHz (1 GHz – 18 GHz)

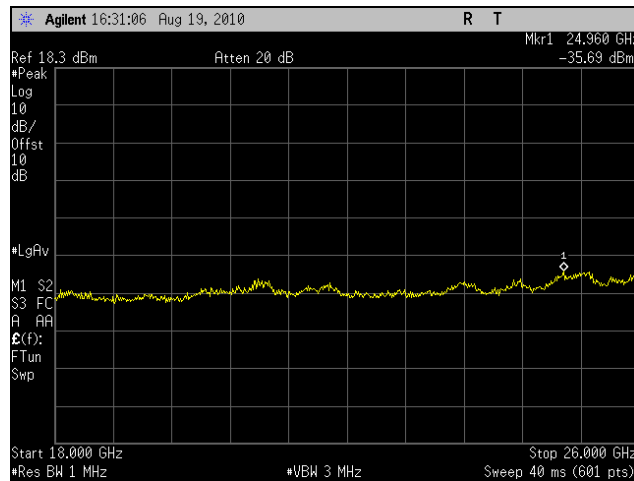

Plot 39. Conducted Spurious Emissions, Mid Channel, 5 MHz (18 GHz – 26 GHz)

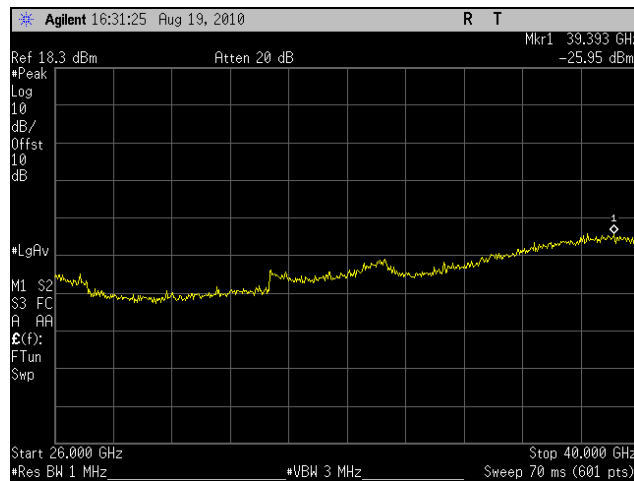

Plot 40. Conducted Spurious Emissions, Mid Channel, 5 MHz (26 GHz – 40 GHz)

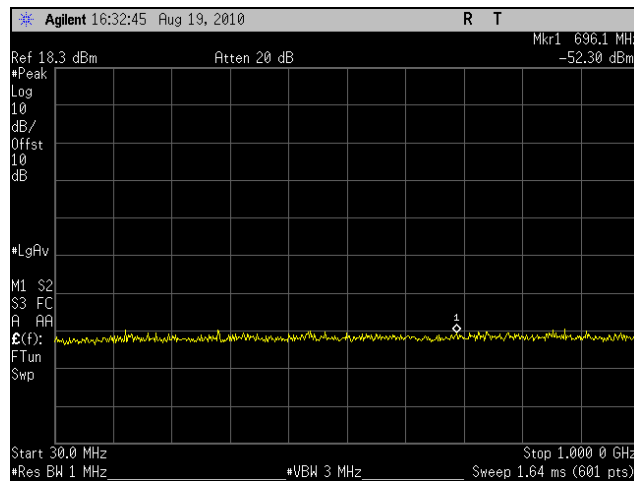

Plot 41. Conducted Spurious Emissions, High Channel, 5 MHz (30 MHz – 1 GHz)

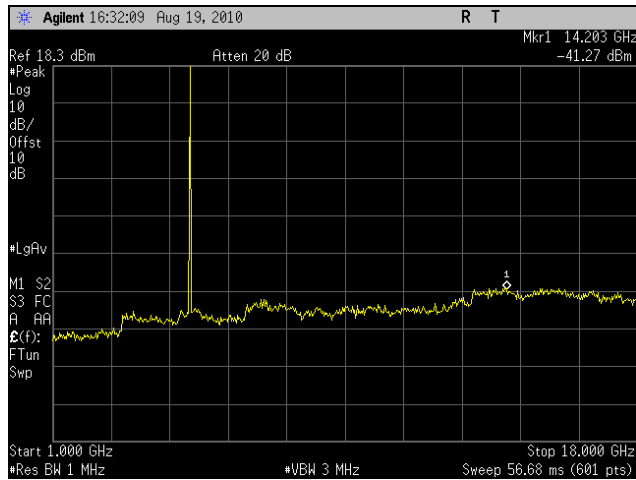

Plot 42. Conducted Spurious Emissions, High Channel, 5 MHz (1 GHz – 18 GHz)

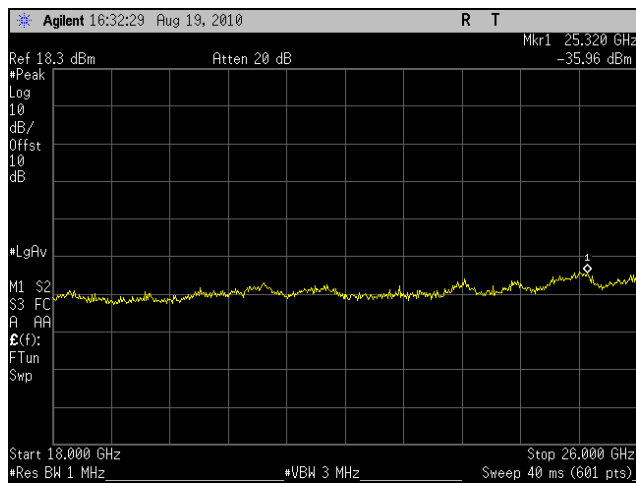

Plot 43. Conducted Spurious Emissions, High Channel, 5 MHz (18 GHz – 26 GHz)

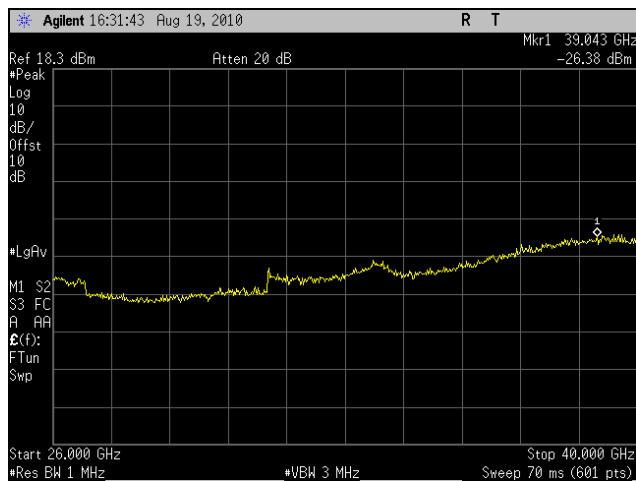

Plot 44. Conducted Spurious Emissions, High Channel, 5 MHz (26 GHz – 40 GHz)

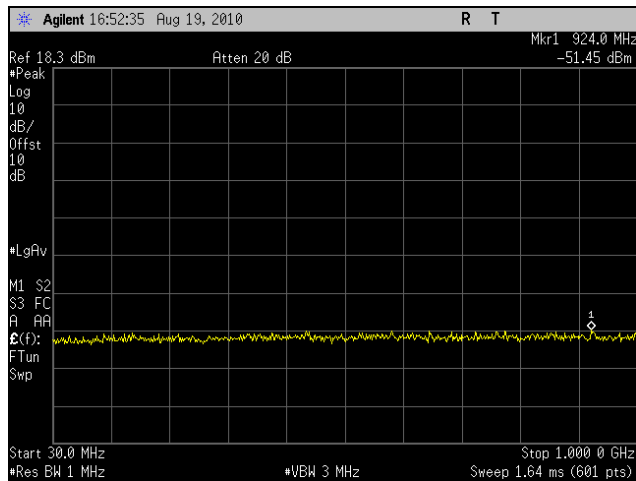

Plot 45. Conducted Spurious Emissions, Low Channel, 10 MHz (30 MHz – 1 GHz)

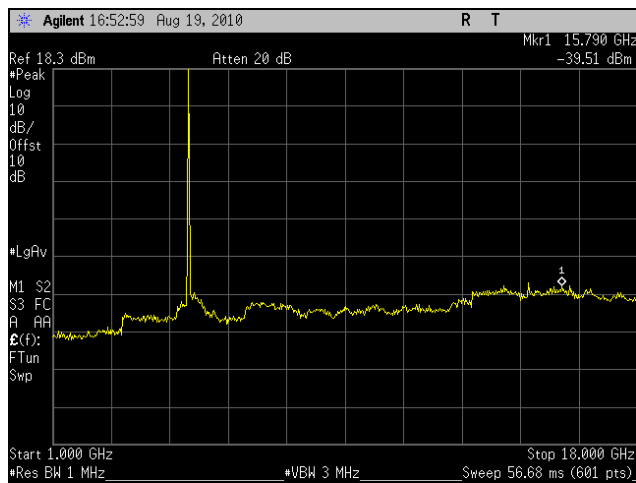

Plot 46. Conducted Spurious Emissions, Low Channel, 10 MHz (1 GHz – 18 GHz)

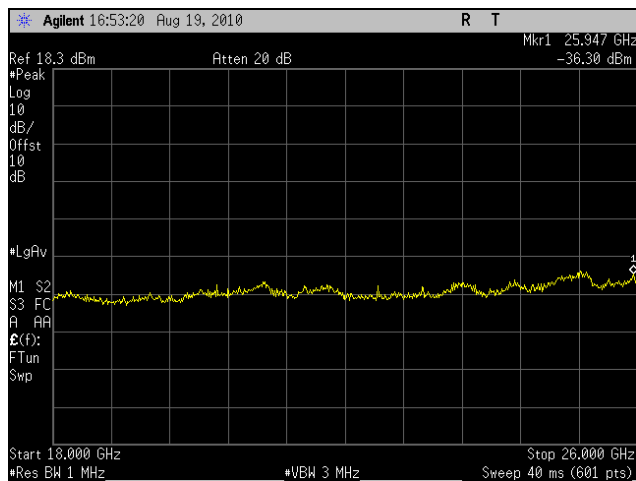

Plot 47. Conducted Spurious Emissions, Low Channel, 10 MHz (18 GHz – 26 GHz)

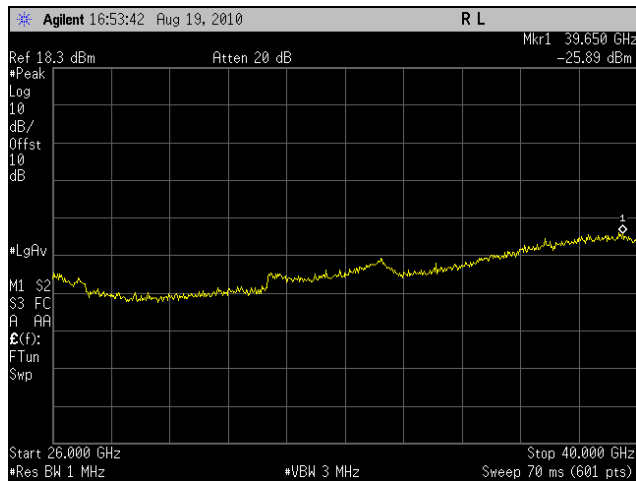

Plot 48. Conducted Spurious Emissions, Low Channel, 10 MHz (26 GHz – 40 GHz)

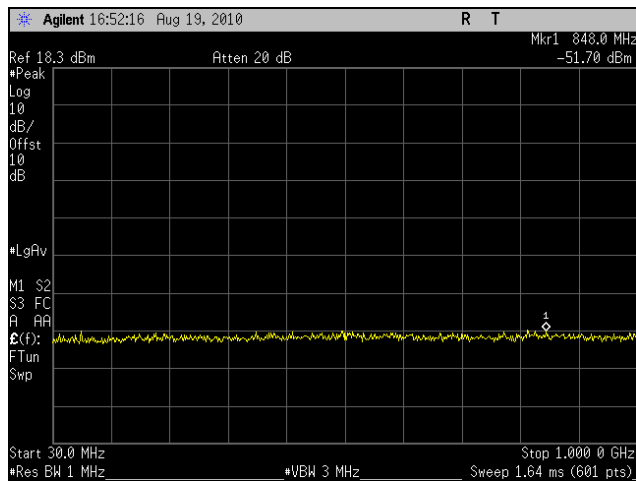

Plot 49. Conducted Spurious Emissions, Mid Channel, 10 MHz (30 MHz – 1 GHz)

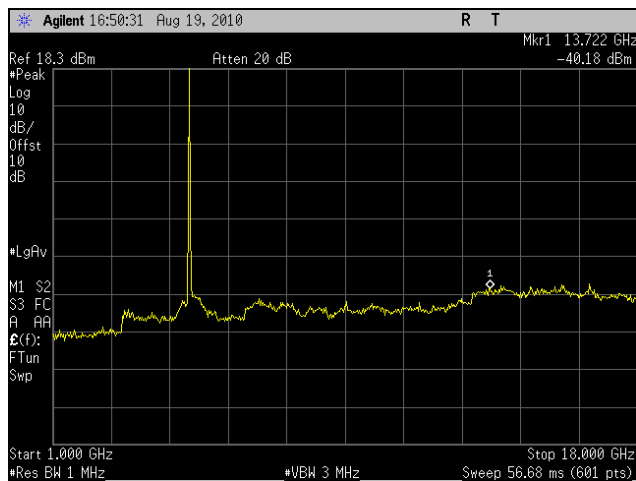

Plot 50. Conducted Spurious Emissions, Mid Channel, 10 MHz (1 GHz – 18 GHz)

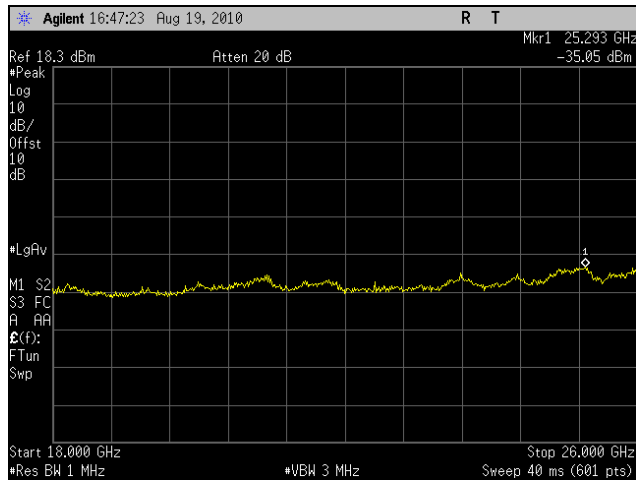

Plot 51. Conducted Spurious Emissions, Mid Channel, 10 MHz (18 GHz – 26 GHz)

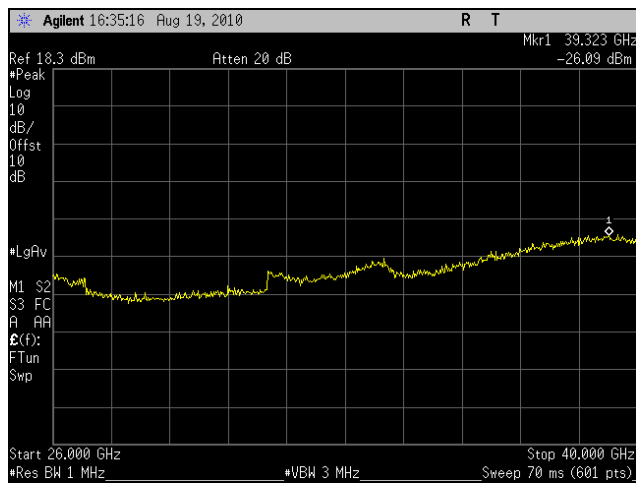

Plot 52. Conducted Spurious Emissions, Mid Channel, 10 MHz (26 GHz – 40 GHz)

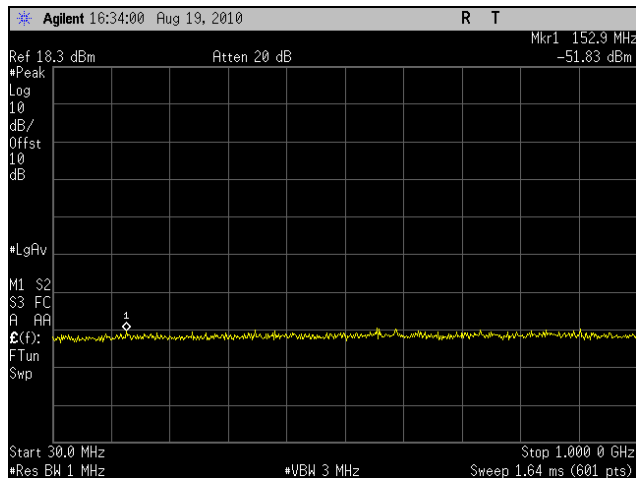

Plot 53. Conducted Spurious Emissions, High Channel, 10 MHz (30 MHz – 1 GHz)

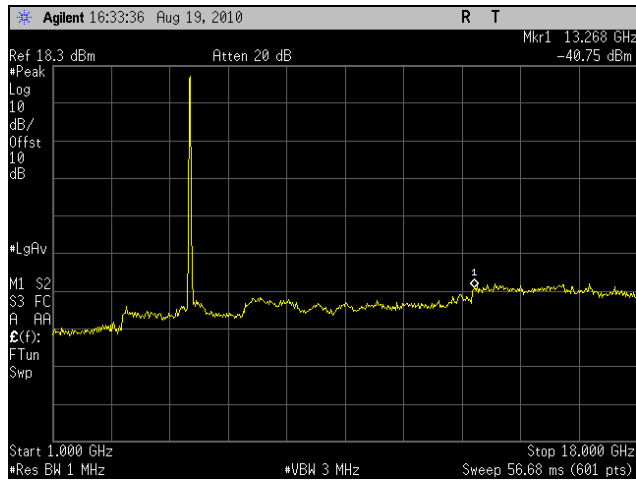

Plot 54. Conducted Spurious Emissions, High Channel, 10 MHz (1 GHz – 18 GHz)

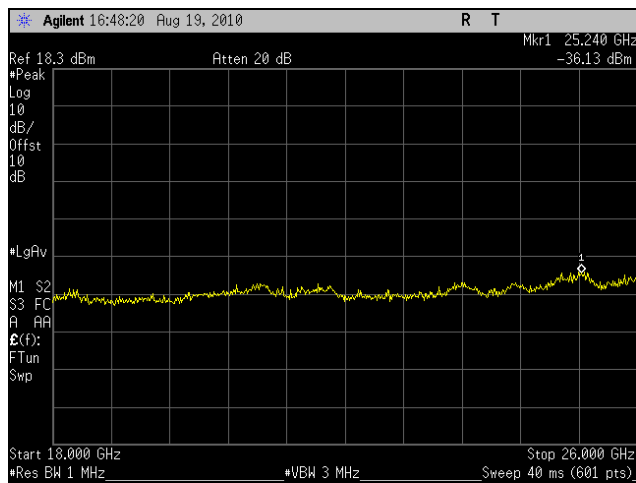

Plot 55. Conducted Spurious Emissions, High Channel, 10 MHz (18 GHz – 26 GHz)

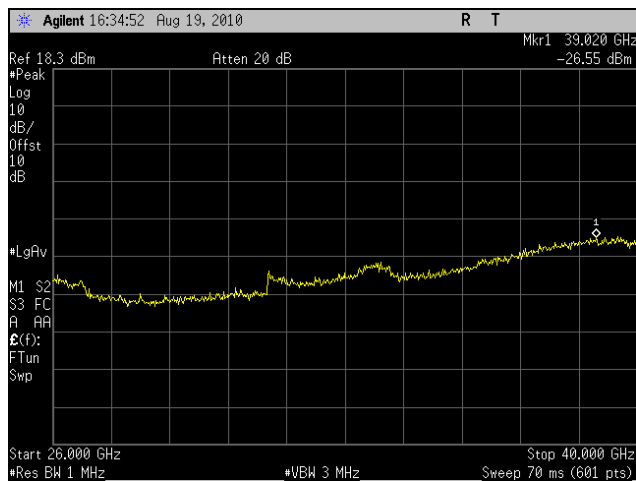

Plot 56. Conducted Spurious Emissions, High Channel, 10 MHz (26 GHz – 40 GHz)

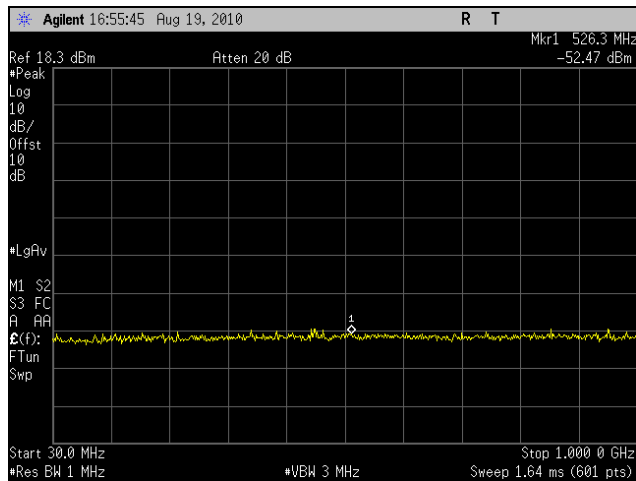

Plot 57. Conducted Spurious Emissions, Low Channel, 20 MHz (30 MHz – 1 GHz)

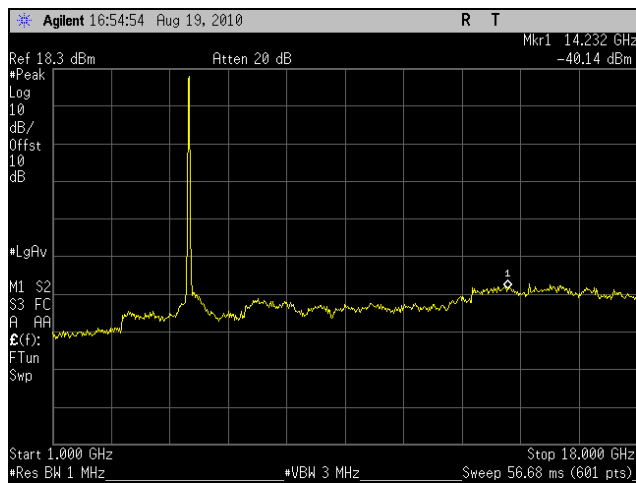

Plot 58. Conducted Spurious Emissions, Low Channel, 20 MHz (1 GHz – 18 GHz)

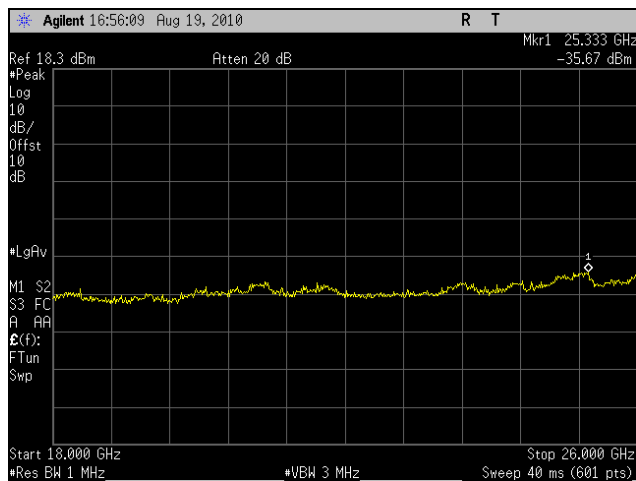

Plot 59. Conducted Spurious Emissions, Low Channel, 20 MHz (18 GHz – 26 GHz)

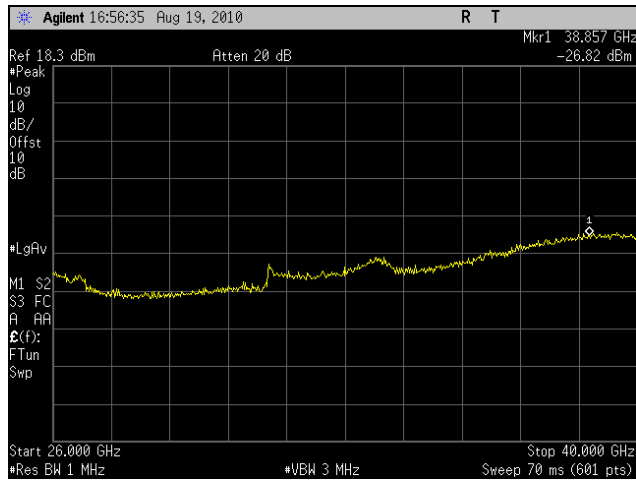

Plot 60. Conducted Spurious Emissions, Low Channel, 20 MHz (26 GHz – 40 GHz)

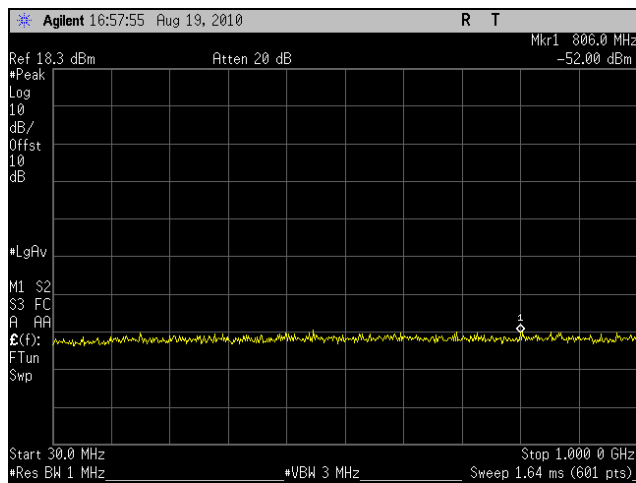

Plot 61. Conducted Spurious Emissions, High Channel, 20 MHz (30 MHz – 1 GHz)

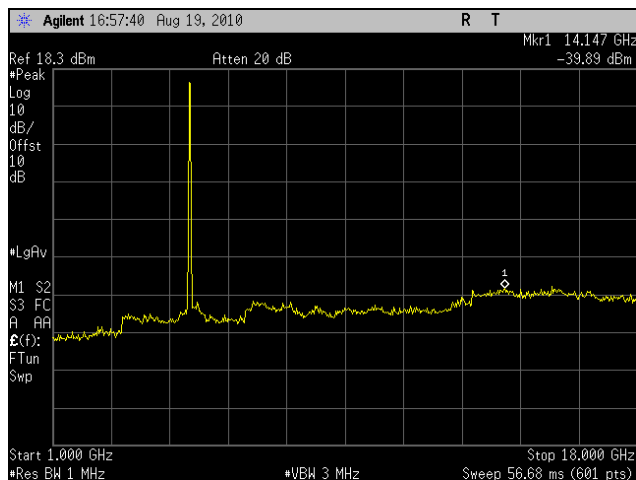

Plot 62. Conducted Spurious Emissions, High Channel, 20 MHz (1 GHz – 18 GHz)

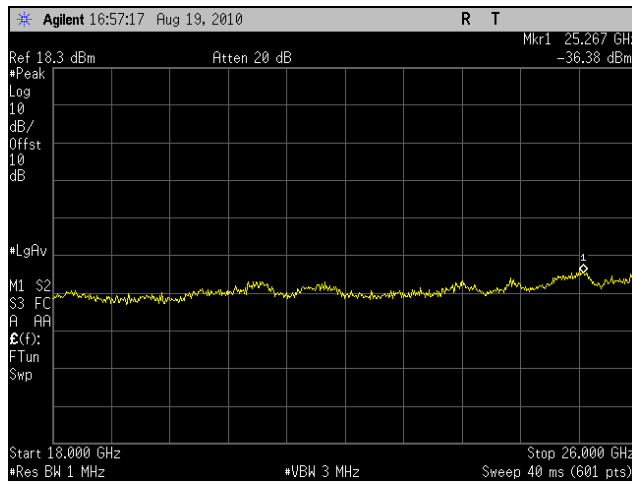

Plot 63. Conducted Spurious Emissions, High Channel, 20 MHz (18 GHz – 26 GHz)

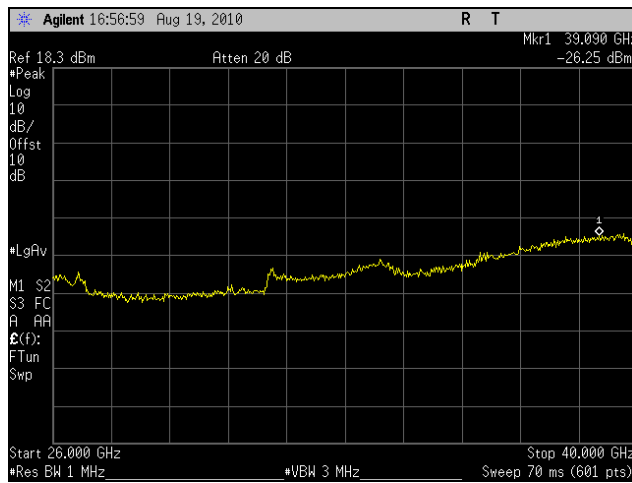

Plot 64. Conducted Spurious Emissions, High Channel, 20 MHz (26 GHz – 40 GHz)

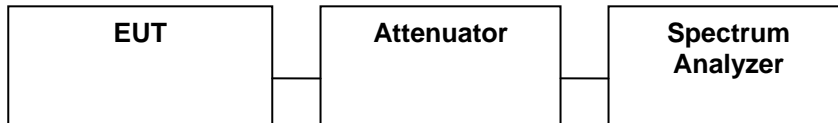

Figure 7. Spurious Emissions at Antenna Terminals Test Setup

Electromagnetic Compatibility Radiated Emissions Requirements

5.2. Radiated Emissions

Test Requirement(s): §2.1053 and §90.210

Test Procedures: As required by 47 CFR 2.1053, *field strength of radiated spurious measurements* were made in accordance with the procedures of TIA/EIA-603-A-2001 "Land Mobile FM or PM Communications Equipment Measurement and Performance Standards".

Radiated emission measurements were performed inside a 10 meter semi-anechoic chamber. The EUT was set at a distance of 3m from the receiving antenna. The EUT's RF ports were terminated to 50ohm load. The EUT was set to transmit at the low, mid and high channels of the transmitter frequency range at its maximum power level. The EUT was rotated about 360⁰ and the receiving antenna scanned from 1-4m in order to capture the maximum emission. A calibrated antenna source was positioned in place of the EUT and the previously recorded signal was duplicated. The maximum EIRP of the emission was calculated by adding the forward power to the calibrated source plus its appropriate gain value. These steps were carried out with the receiving antenna in both vertical and horizontal polarization. Harmonic emissions up to the 10th or 40GHz, which ever was the lesser, were investigated.

No peaks were found above 18 GHz.

Note: Signal substitution was not performed due to the fact that only noise floor was detected from 30 MHz – 40 GHz.

Test Results: Equipment complies with Section 2.1053 and 90.210.

Test Engineer(s): Minh Ly

Test Date(s): 08/25/10

Radiated Emissions Test Results

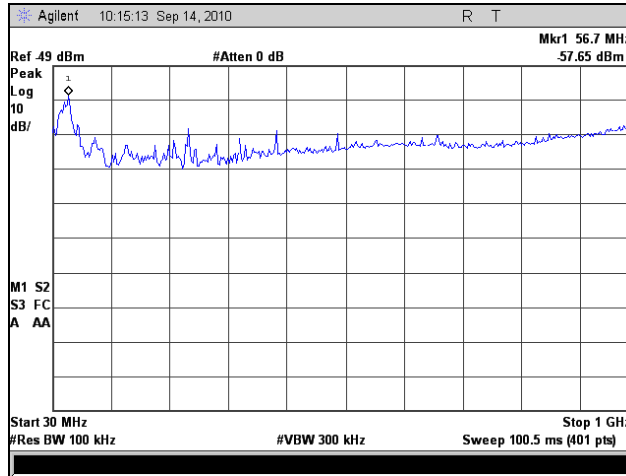

Plot 65. Radiated Spurious Emissions, Low Channel, 5 MHz (30 MHz – 1 GHz)

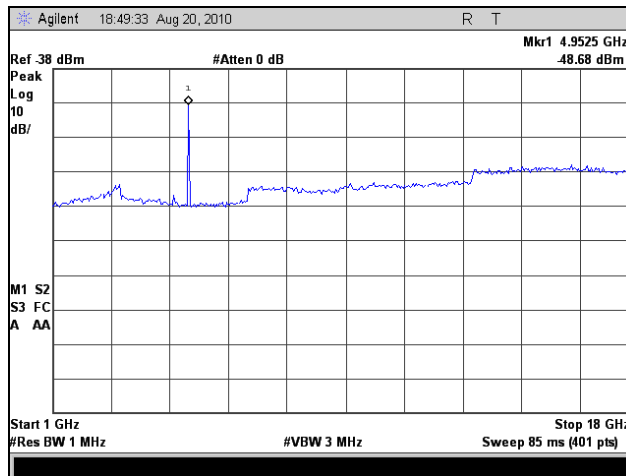

Plot 66. Radiated Spurious Emissions, Low Channel, 5 MHz (1 GHz – 18 GHz)

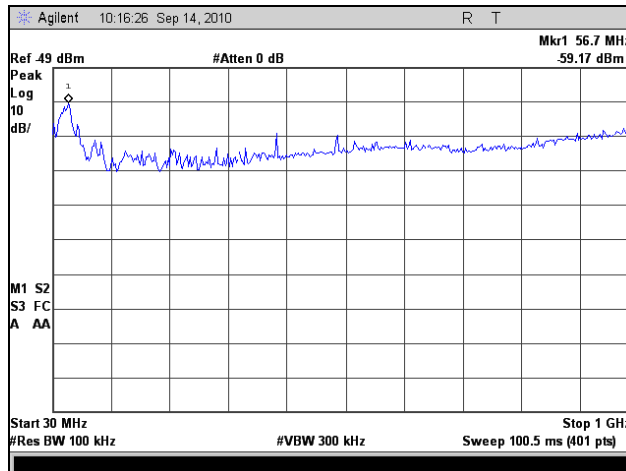

Plot 67. Radiated Spurious Emissions, Mid Channel, 5 MHz (30 MHz – 1 GHz)

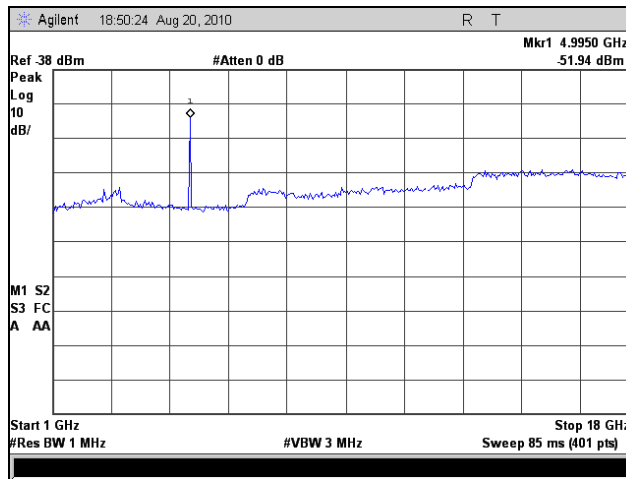

Plot 68. Radiated Spurious Emissions, Mid Channel, 5 MHz (1 GHz – 18 GHz)

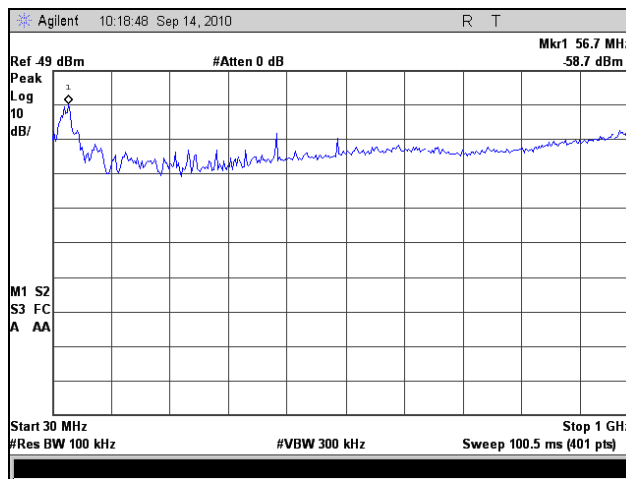

Plot 69. Radiated Spurious Emissions, High Channel, 5 MHz (30 MHz – 1 GHz)

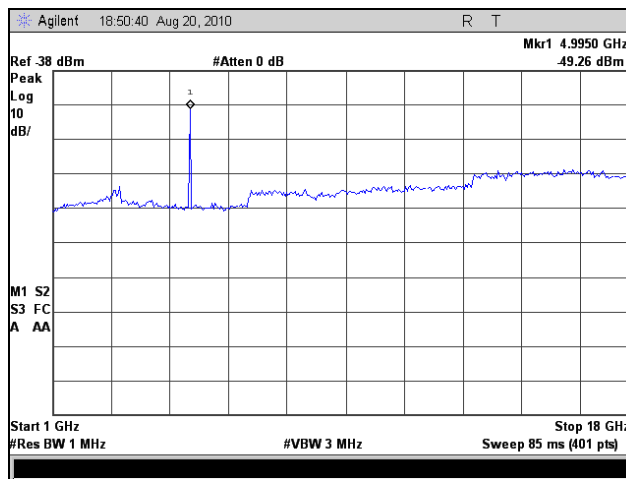

Plot 70. Radiated Spurious Emissions, High Channel, 5 MHz (1 GHz – 18 GHz)

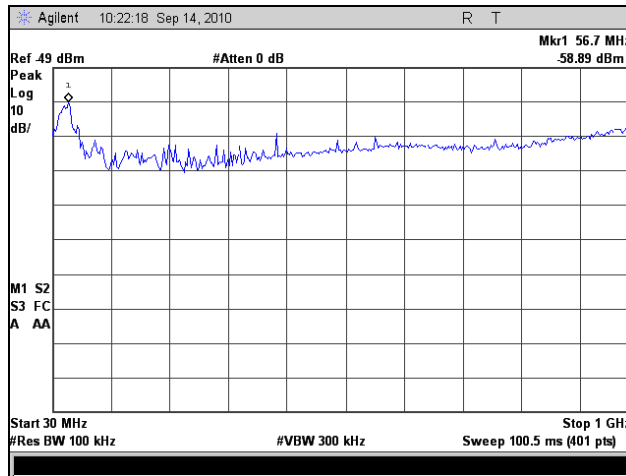

Plot 71. Radiated Spurious Emissions, Low Channel, 10 MHz (30 MHz – 1 GHz)

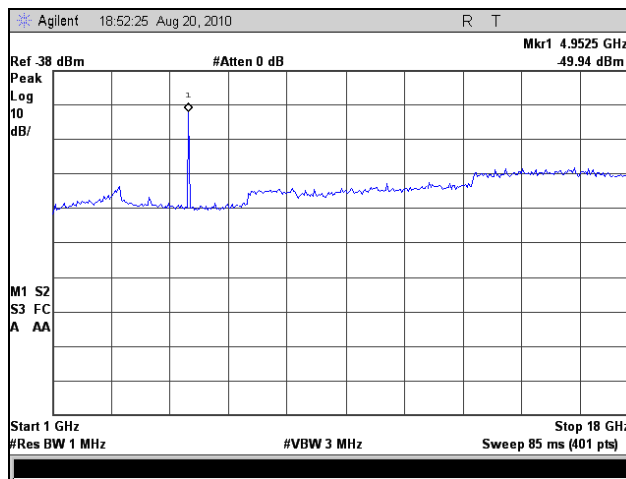

Plot 72. Radiated Spurious Emissions, Low Channel, 10 MHz (1 GHz – 18 GHz)

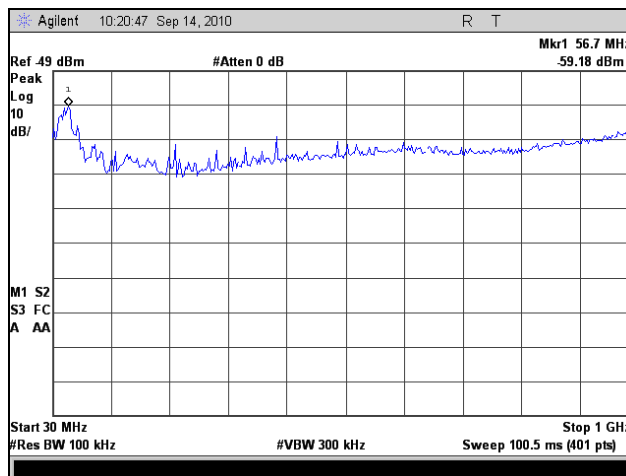

Plot 73. Radiated Spurious Emissions, Mid Channel, 10 MHz (30 MHz – 1 GHz)

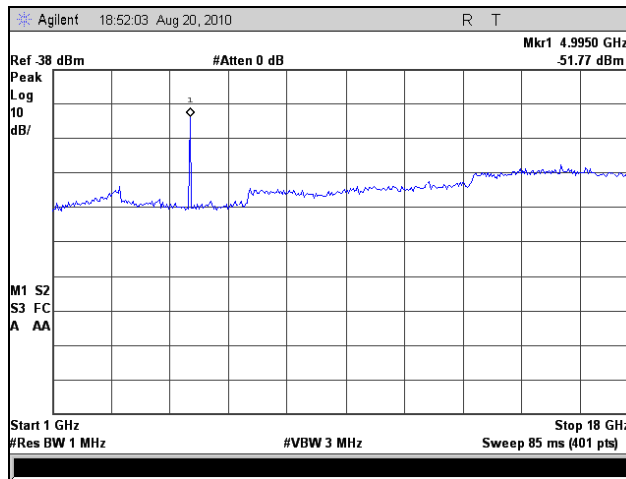

Plot 74. Radiated Spurious Emissions, Mid Channel, 10 MHz (1 GHz – 18 GHz)

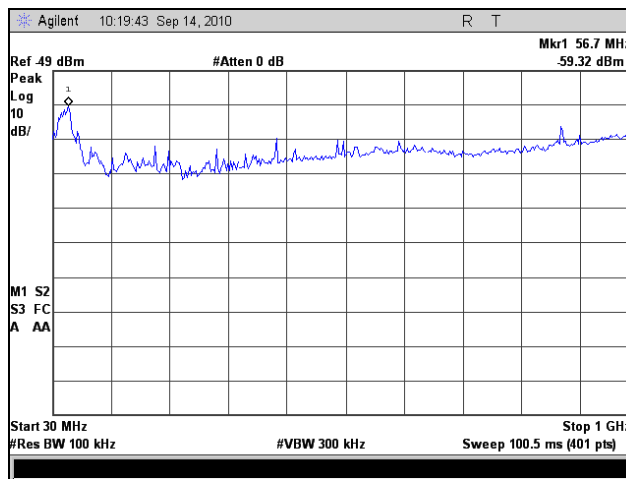

Plot 75. Radiated Spurious Emissions, High Channel, 10 MHz (30 MHz – 1 GHz)

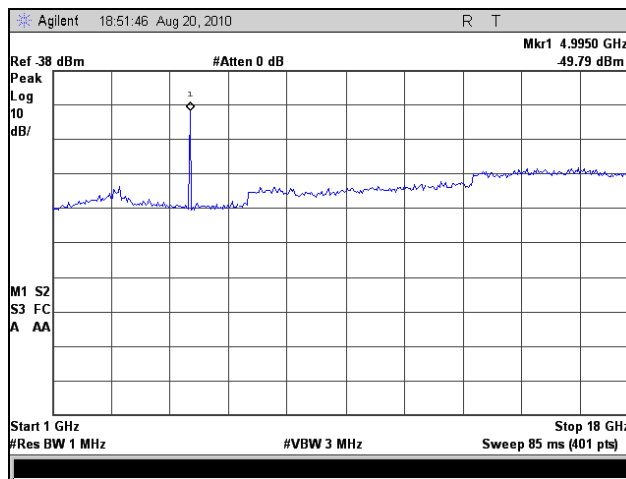

Plot 76. Radiated Spurious Emissions, High Channel, 10 MHz (1 GHz – 18 GHz)

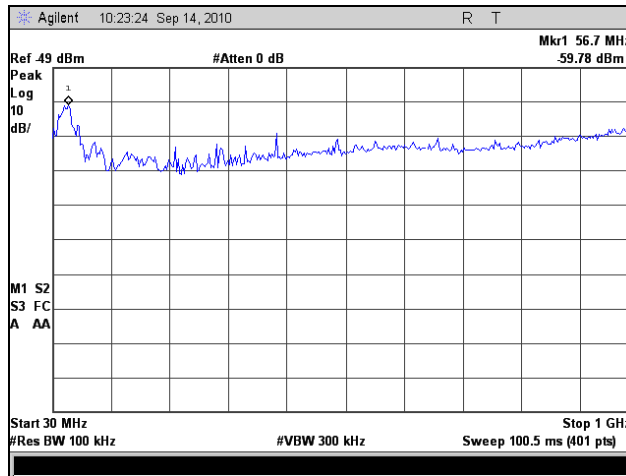

Plot 77. Radiated Spurious Emissions, Low Channel, 20 MHz (30 MHz – 1 GHz)

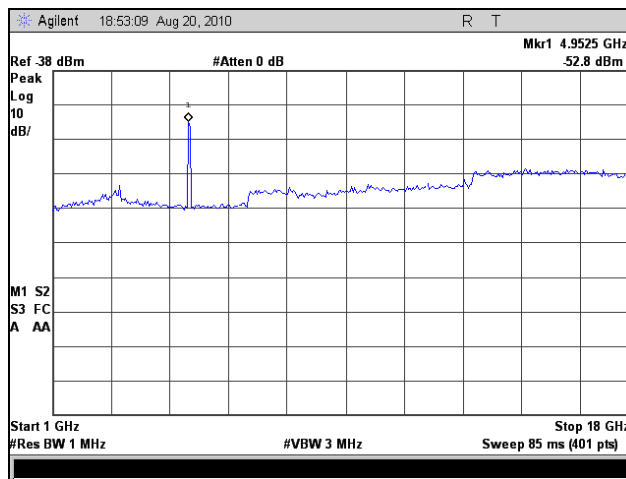

Plot 78. Radiated Spurious Emissions, Low Channel, 20 MHz (1 GHz – 18 GHz)

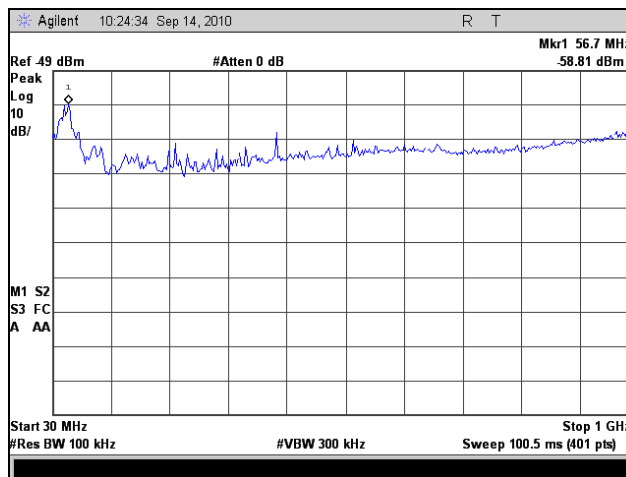

Plot 79. Radiated Spurious Emissions, High Channel, 20 MHz (30 MHz – 1 GHz)

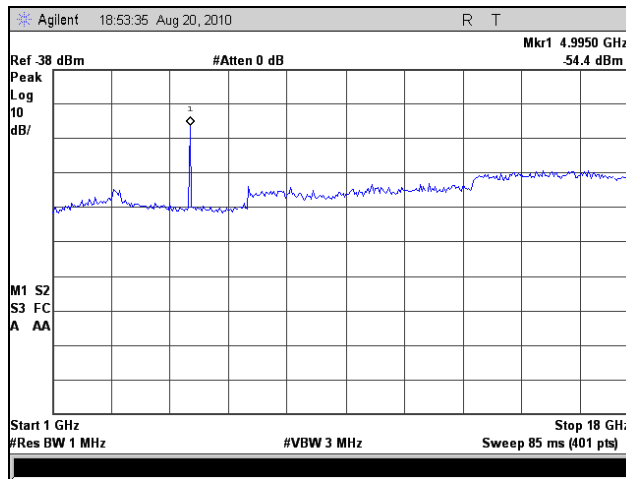

Plot 80. Radiated Spurious Emissions, High Channel, 20 MHz (1 GHz – 18 GHz)

Radiated Emissions Spurious Test Setup



Photograph 2. Radiated Emission Spurious Test Setup, 30 MHz – 1 GHz

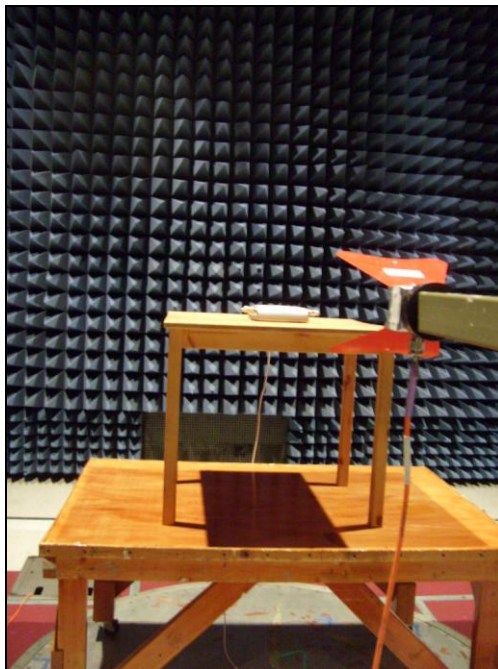

Photograph 3 Radiated Emission Spurious Test Setup, 1 GHz – 18 GHz

6. Electromagnetic Compatibility Frequency Stability Requirements

6.1. Frequency Stability

Test Requirement(s): §2.1055 and §90.213

Test Procedures: As required by 47 CFR 2.1055, *Frequency Stability measurements* were made at the RF output terminals using a Directional Coupler through a Spectrum Analyzer and Power Meter.

The EUT was placed in the Environmental Chamber and support equipments are outside the chamber on a table. The EUT was set to transmit a CW signal corresponding to the low, mid and high Channels for 5, 10, & 20 MHz Bandwidths. The frequency counter option on the Spectrum Analyzer was used to measure frequency deviations. The frequency drift was investigated for every 10^{°C} increment until the unit is stabilized then recorded the reading in tabular format with the temperature range of -40 to 60^{°C}.

Voltage supplied to EUT is 120 VAC reference temperature was done at 20^{°C}. The voltage was varied by ± 15 % of nominal

Test Results: Equipment complies with Section 2.1055 and 90.213

Test Engineer(s): Minh Ly

Test Date(s): 09/16/10

Frequency Stability Test Results

(Low Channel)				
	Voltage (AC)	Temperature (C)	Frequency (MHz)	PPM
Reference	120	60	4945.059500	17.088
	120	50	4945.053250	15.824
	120	40	4945.046000	14.358
	120	30	4945.022500	9.606
	120	20	4944.975000	0.000
	120	10	4945.010310	7.141
4945.021000	120	0	4945.018620	8.821
	120	-10	4944.994890	4.022
	120	-20	4944.984120	1.844
	120	-30	4944.975520	0.105
	120	-40	4944.974290	0.144
	102	20	4944.977000	0.404
	138	20	4944.977100	0.425
(Mid Channel)				
	Voltage (AC)	Temperature (C)	Frequency (MHz)	PPM
Reference	120	60	4965.058500	18.429
	120	50	4965.055250	17.775
	120	40	4965.054750	17.674
	120	30	4965.024000	11.480
	120	20	4964.967000	0.000
	120	10	4965.045090	15.728
4965.022750	120	0	4965.014710	9.609
	120	-10	4964.994670	5.573
	120	-20	4964.985090	3.644
	120	-30	4964.976570	1.928
	120	-40	4964.975630	1.738
	102	20	4964.968000	0.201
	138	20	4964.966000	0.201
(High Channel)				
	Voltage (AC)	Temperature (C)	Frequency (MHz)	PPM
Reference	120	60	4985.026500	3.173
	120	50	4985.079500	7.458
	120	40	4985.067500	5.051
	120	30	4985.024000	3.675
	120	20	4985.042320	0.000
	120	10	4985.034700	1.529
4985.022750	120	0	4985.019740	4.530
	120	-10	4984.990510	10.393
	120	-20	4984.985500	11.398
	120	-30	4984.974880	13.528
	120	-40	4984.976840	13.135
	102	20	4985.047650	1.069
	138	20	4985.048190	1.178

Table 4. Frequency Stability, 5 MHz and 10 MHz

(Low Channel)				
	Voltage (AC)	Temperature (C)	Frequency (MHz)	PPM
Reference	120	60	4950.114500	13.772
	120	50	4950.079000	6.600
	120	40	4950.064000	3.570
	120	30	4950.023000	4.713
	120	20	4950.046330	0.000
	120	10	4950.053760	1.501
4950.022750	120	0	4950.013590	6.614
	120	-10	4949.996030	10.162
	120	-20	4949.982510	12.893
	120	-30	4949.974790	14.452
	120	-40	4949.974760	14.458
	102	20	4950.045712	0.125
	138	20	4950.039860	1.307
(High Channel)				
	Voltage (AC)	Temperature (C)	Frequency (MHz)	PPM
Reference	120	60	4980.119012	16.384
	120	50	4980.079300	8.410
	120	40	4980.062000	4.936
	120	30	4980.025000	2.494
	120	20	4980.037420	0.000
	120	10	4980.043870	1.295
4980.022750	120	0	4980.013250	4.853
	120	-10	4979.997010	8.114
	120	-20	4979.981990	11.130
	120	-30	4979.976760	12.181
	120	-40	4979.974230	12.689
	102	20	4980.038900	0.297
	138	20	4980.038760	0.269

Table 5. Frequency Stability, 20 MHz

7. RF Exposure Requirements

RF Exposure Requirements: §90.1217, §1.1307(b)(1) and §1.1307(b)(2): Systems operating under the provisions of this section shall be operated in a manner that ensures that the public is not exposed to radio frequency energy levels in excess of the Commission's guidelines.

RF Radiation Exposure Limit: §1.1310: As specified in this section, the Maximum Permissible Exposure (MPE) Limit shall be used to evaluate the environmental impact of human exposure to radiofrequency (RF) radiation as specified in Sec. 1.1307(b), except in the case of portable devices which shall be evaluated according to the provisions of Sec. 2.1093 of this chapter.

MPE Limit Calculation: EUT's operating frequencies @ 4940-4990 MHz; highest conducted power = 26.65 dBm (peak) therefore, **Limit for Uncontrolled exposure: 1 mW/cm² or 10 W/m²**

Equation from page 18 of OET 65, Edition 97-01

EUT with 9 dBi Antenna

$$S = PG / 4\pi R^2 \quad \text{or} \quad R = \sqrt{PG / 4\pi S}$$

where, S = Power Density (1 mW/cm²)

P = Power Input to antenna (267.92 mW)

G = Antenna Gain (7.94 numeric)

$$S = (462.38 * 7.94 / 4 * 3.14 * 20.0^2) = (3672.82 / 5024) = \mathbf{0.73 \text{ mW/cm}^2} @ 20\text{cm separation}$$

EUT with 16 dBi Antenna

$$S = PG / 4\pi R^2 \quad \text{or} \quad R = \sqrt{PG / 4\pi S}$$

where, S = Power Density (1 mW/cm²)

P = Power Input to antenna (267.92 mW)

G = Antenna Gain (7.94 numeric)

$$R = (462.38 * 39.8 / 4 * 3.14)^{1/2} = (18407.72 / 12.56)^{1/2} = 38.28 \text{ cm in order to comply with } 1 \text{ mW/cm}^2$$

8. Electromagnetic Compatibility Receiver Spurious Requirements

8.1. Receiver Spurious Emissions

Test Requirement: The following receiver spurious emission limits shall be complied with:

- a) If a radiated measurement is made, all spurious emissions shall comply with the limits of Table 6.

Spurious Frequency (MHz)	Field Strength (microvolt/m at 3 metres)
30-88	100
88-216	150
216-960	200
Above 960	500

Table 6. Spurious Emission Limits for Receivers

- b) If a conducted measurement is made, no spurious output signals appearing at the antenna terminals shall exceed 2 nanowatts per any 4 kHz spurious frequency in the band 30-1000 MHz, or 5 nanowatts above 1 GHz.

Test Procedure: The receiver spurious emissions were tested in compliance with the limits of Table 12. The testing was performed conducted.

Test Results: The EUT was compliant with the Receiver Spurious Emission limits of this requirement.

Test Engineer(s): Minh Ly

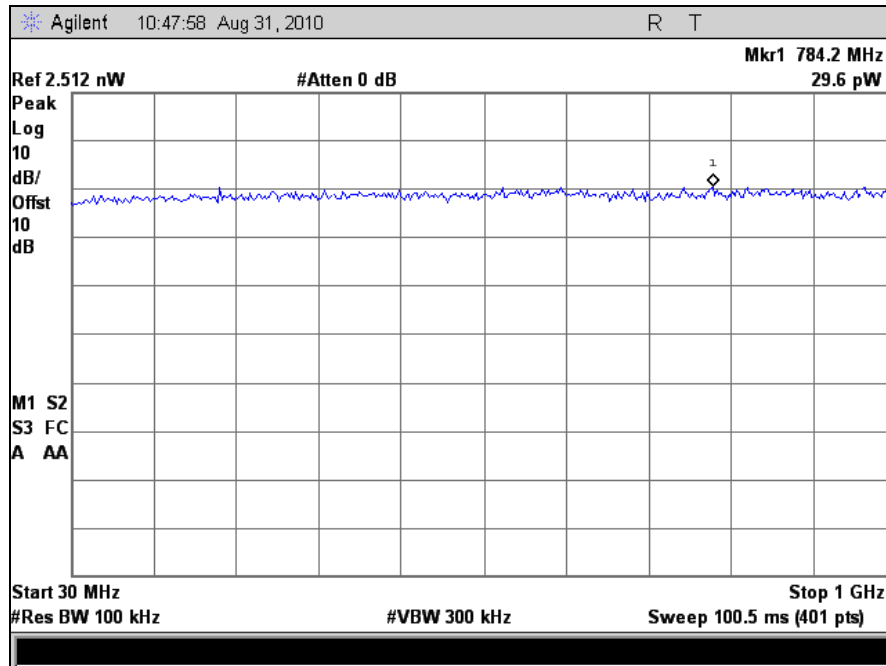

Plot 81. Conducted Receiver Spurious Emissions, 30 MHz – 1 GHz

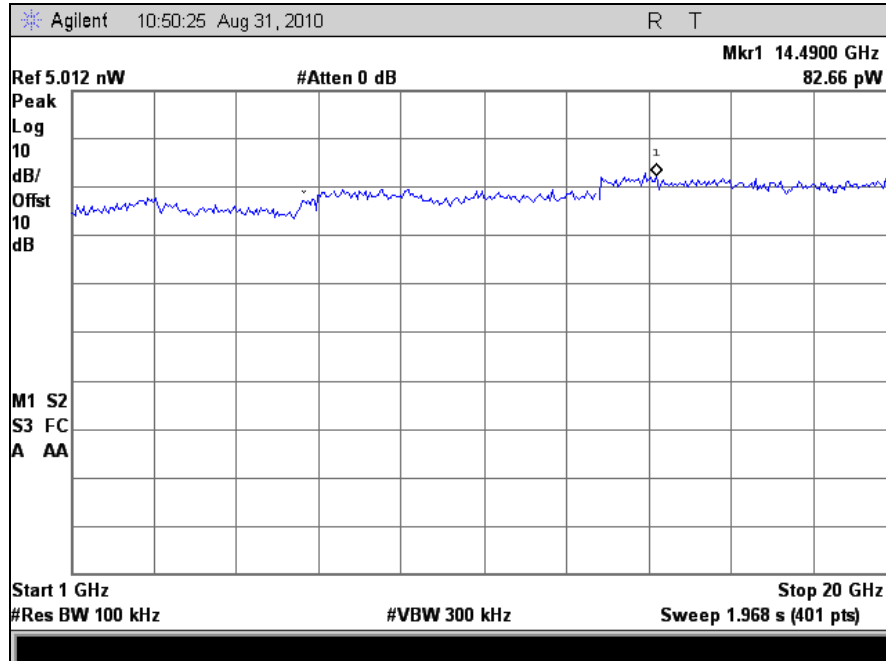

Plot 82. Conducted Receiver Spurious Emissions, 1 GHz – 20 GHz

9. Test Equipment

Calibrated test equipment utilized during testing was maintained in a current state of calibration per the requirements of ANSI/NCSL Z540-1-1994 and ANSI/ISO/IEC 17025:2000.

MET Asset #	Equipment	Manufacturer	Model	Last Cal Date	Cal Due Date
1S2501	EMI RECEIVER	ROHDE&SCHWARZ	ESU40	06/03/2010	06/03/2011
1S2484	BILOG ANTENNA	TESEQ	CBL6112D	SEE NOTE	
1S2399	TURNTABLE CONTROLLER	SUNOL SCIENCE	SC99V	NOT REQUIRED	
1S2522	DIGITAL THERMO/HYGROMETER	CONTROL COMPANY	11-661-7D	11/11/2009	11/11/2010
1S2482	5M CHAMBER	PANASHIELD	N/A	10/16/2009	10/16/2010
1S2603	DOUBLE RIDGED WAVEGUIDE HORN	ETS-LINGREN	3117	04/09/2009	04/09/2011
1S2121	PRE-AMPLIFIER	HEWLETT PACKARD	8449B	SEE NOTE	
N/A	HIGH PASS FILTER	MICRO-TRONICS	HPM13146	SEE NOTE	
1S2583	SPECTRUM ANALYZER	AGILENT	E4447A	01/26/2010	01/26/2011
1S2460	ANALYZER, SPECTRUM 9 KHZ-40GHZ	AGILENT	E4407B	07/13/2010	07/13/2011
1S2229	TEMPERATURE CHAMBER	TENNY ENGINEERING	T63C	02/19/2010	02/19/2011
1S2128	HARMONIC MIXER	HEWLETT PACKARD	11970A	11/22/2008	11/22/2010
1S2129	HARMONIC MIXER	HEWLETT PACKARD	11970K	11/22/2008	11/22/2010

Note: Functionally tested equipment is verified using calibrated instrumentation at the time of testing.

Certification & User's Manual Information



10. Certification Label & User's Manual Information

10.1. Certification Information

The following is extracted from Title 47 of the Code of Federal Regulations, Part 2, Subpart I — Marketing of Radio frequency devices:

§ 2.801 Radio-frequency device defined.

As used in this part, a radio-frequency device is any device which in its operation is capable of Emitting radio-frequency energy by radiation, conduction, or other means. Radio- frequency devices include, but are not limited to:

- (a) The various types of radio communication transmitting devices described throughout this chapter.
- (b) *The incidental, unintentional and intentional radiators defined in Part 15 of this chapter.*
- (c) The industrial, scientific, and medical equipment described in Part 18 of this chapter.
- (d) Any part or component thereof which in use emits radio-frequency energy by radiation, conduction, or other means.

§ 2.803 Marketing of radio frequency devices prior to equipment authorization.

- (a) Except as provided elsewhere in this chapter, no person shall sell or lease, or offer for sale or lease (including advertising for sale or lease), or import, ship or distribute for the purpose of selling or leasing or offering for sale or lease, any radio frequency device unless:
 - (1) In the case of a device subject to certification, such device has been authorized by the Commission in accordance with the rules in this chapter and is properly identified and labeled as required by §2.925 and other relevant sections in this chapter; or
 - (2) In the case of a device that is not required to have a grant of equipment authorization issued by the Commission, but which must comply with the specified technical standards prior to use, such device also complies with all applicable administrative (including verification of the equipment or authorization under a Declaration of Conformity, where required), technical, labeling and identification requirements specified in this chapter.
- (d) Notwithstanding the provisions of paragraph (a) of this section, the offer for sale solely to business, commercial, industrial, scientific or medical users (but not an offer for sale to other parties or to end users located in a residential environment) of a radio frequency device that is in the conceptual, developmental, design or pre-production stage is permitted prior to equipment authorization or, for devices not subject to the equipment authorization requirements, prior to a determination of compliance with the applicable technical requirements *provided* that the prospective buyer is advised in writing at the time of the offer for sale that the equipment is subject to the FCC rules and that the equipment will comply with the appropriate rules before delivery to the buyer or to centers of distribution.

- (e)(1) Notwithstanding the provisions of paragraph (a) of this section, prior to equipment authorization or determination of compliance with the applicable technical requirements any radio frequency device may be operated, but not marketed, for the following purposes and under the following conditions:
- (i) *Compliance testing*;
 - (ii) Demonstrations at a trade show provided the notice contained in paragraph (c) of this section is displayed in a conspicuous location on, or immediately adjacent to, the device;
 - (iii) Demonstrations at an exhibition conducted at a business, commercial, industrial, scientific or medical location, but excluding locations in a residential environment, provided the notice contained in paragraphs (c) or (d) of this section, as appropriate, is displayed in a conspicuous location on, or immediately adjacent to, the device;
 - (iv) Evaluation of product performance and determination of customer acceptability, provided such operation takes place at the manufacturer's facilities during developmental, design or pre-production states; or
 - (v) Evaluation of product performance and determination of customer acceptability where customer acceptability of a radio frequency device cannot be determined at the manufacturer's facilities because of size or unique capability of the device, provided the device is operated at a business, commercial, industrial, scientific or medical user's site, but not at a residential site, during the development, design or pre-production stages.
- (e)(2) For the purpose of paragraphs (e)(1)(iv) and (e)(1)(v) of this section, the term *manufacturer's facilities* includes the facilities of the party responsible for compliance with the regulations and the manufacturer's premises, as well as the facilities of other entities working under the authorization of the responsible party in connection with the development and manufacture, but not the marketing, of the equipment.
- (f) For radio frequency devices subject to verification and sold solely to business, commercial, industrial, scientific and medical users (excluding products sold to other parties or for operation in a residential environment), parties responsible for verification of the devices shall have the option of ensuring compliance with the applicable technical specifications of this chapter at each end user's location after installation, provided that the purchase or lease agreement includes a provision that such a determination of compliance be made and is the responsibility of the party responsible for verification of the equipment.



The following is extracted from Title 47 of the Code of Federal Regulations, Part 2, Subpart Y — Equipment Authorization Procedures:

§ 2.901 Basis and Purpose

- (a) In order to carry out its responsibilities under the Communications Act and the various treaties and international regulations, and in order to promote efficient use of the radio spectrum, the Commission has developed technical standards for radio frequency equipment and parts or components thereof. The technical standards applicable to individual types of equipment are found in that part of the rules governing the service wherein the equipment is to be operated.¹ *In addition to the technical standards provided, the rules governing the service may require that such equipment be verified by the manufacturer or importer, be authorized under a Declaration of Conformity, or receive an equipment authorization from the Commission by one of the following procedures: certification or registration.*

- (b) The following sections describe the verification procedure, the procedure for a Declaration of Conformity, and the procedures to be followed in obtaining certification from the Commission and the conditions attendant to such a grant, whichever is applicable.

§ 2.902 Certification.

- (a) Certification is an equipment authorization issued by the Commission, based on representation and test data submitted by the applicant.

- (b) Certification attaches to all units subsequently marketed by the grantee which are identical (see Section 2.908) to the sample tested except for permissive changes or other variations authorized by the Commission pursuant to Section 2.1043.

¹ In this case, the equipment is subject to the rules of Part 15. More specifically, the equipment falls under Subpart B (of Part 15), which deals with unintentional radiators.

§ 2.948 Description of measurement facilities.

- (a) Each party making measurements of equipment that is subject to an equipment authorization under Part 15 or Part 18 of this chapter, regardless of whether the measurements are filed with the Commission or kept on file by the party responsible for compliance of equipment marketed within the U.S. or its possessions, shall compile a description of the measurement facilities employed.
 - (1) If the measured equipment is subject to the verification procedure, the description of the measurement facilities shall be retained by the party responsible for verification of the equipment.
 - (i) *If the equipment is verified through measurements performed by an independent laboratory, it is acceptable for the party responsible for verification of the equipment to rely upon the description of the measurement facilities retained by or placed on file with the Commission by that laboratory. In this situation, the party responsible for the verification of the equipment is not required to retain a duplicate copy of the description of the measurement facilities.*
 - (ii) If the equipment is verified based on measurements performed at the installation site of the equipment, no specific site calibration data is required. It is acceptable to retain the description of the measurement facilities at the site at which the measurements were performed.
 - (2) If the equipment is to be authorized by the Commission under the certification procedure, the description of the measurement facilities shall be filed with the Commission's Laboratory in Columbia, Maryland. The data describing the measurement facilities need only be filed once but must be updated as changes are made to the measurement facilities or as otherwise described in this section. At least every three years, the organization responsible for filing the data with the Commission shall certify that the data on file is current.

10.2. Label and User's Manual Information

The following is extracted from Title 47 of the Code of Federal Regulations, Part 15, Subpart A — General:

§ 15.19 Labeling requirements.

(a) *In addition to the requirements in Part 2 of this chapter, a device subject to certification or verification shall be labeled as follows:*

- (1) Receivers associated with the operation of a licensed radio service, e.g., FM broadcast under Part 73 of this chapter, land mobile operation under Part 90, etc., shall bear the following statement in a conspicuous location on the device:

This device complies with Part 15 of the FCC Rules. Operation is subject to the condition that this device does not cause harmful interference.

- (2) A stand-alone cable input selector switch, shall bear the following statement in a conspicuous location on the device:

This device is verified to comply with Part 15 of the FCC Rules for use with cable television service.

- (3) All other devices shall bear the following statement in a conspicuous location on the device:

This device complies with Part 15 of the FCC Rules. Operation is subject to the following two conditions: (1) This device may not cause harmful interference, and (2) this device must accept any interference received, including interference that may cause undesired operation.

- (4) Where a device is constructed in two or more sections connected by wires and marketed together, the statement specified under paragraph (a) of this section is required to be affixed only to the main control unit.

- (5) When the device is so small or for such use that it is not practicable to place the statement specified under paragraph (a) of this section on it, the information required by this paragraph shall be placed in a prominent location in the instruction manual or pamphlet supplied to the user or, alternatively, shall be placed on the container in which the device is marketed. However, the FCC identifier or the unique identifier, as appropriate, must be displayed on the device.



§ 15.21 Information to user.

The users manual or instruction manual for an intentional or unintentional radiator shall caution the user that changes or modifications not expressly approved by the party responsible for compliance could void the user's authority to operate the equipment.

The following is extracted from Title 47 of the Code of Federal Regulations, Part 15, Subpart B — Unintentional Radiators:

§ 15.105 Information to the user.

- (a) For a Class B digital device or peripheral, the instructions furnished the user shall include the following or similar statement, placed in a prominent location in the text of the manual:

Note: This equipment has been tested and found to comply with the limits for a Class B digital device, pursuant to Part 15 of the FCC Rules. These limits are designed to provide reasonable protection against harmful interference when the equipment is operated in a residential environment. This equipment generates, uses, and can radiate radio frequency energy and, if not installed and used in accordance with the instruction manual, may cause harmful interference to radio communications. However, there is no guarantee that interference will not occur in a particular installation. If this equipment does cause harmful interference to radio or television reception, which can be determined by turning the equipment off and on, the user is encouraged to try to correct the interference by one or more of the following measures:

- Reorient or relocate the receiving antenna.
- Increase the separation between the equipment and receiver.
- Connect the equipment into an outlet on a circuit different from that to which the receiver is connected.
- Consult the dealer or an experienced radio/TV technician for help.

End of Report